

INSTRUCTION BOOKLET

**READ AND KEEP
THESE INSTRUCTIONS**

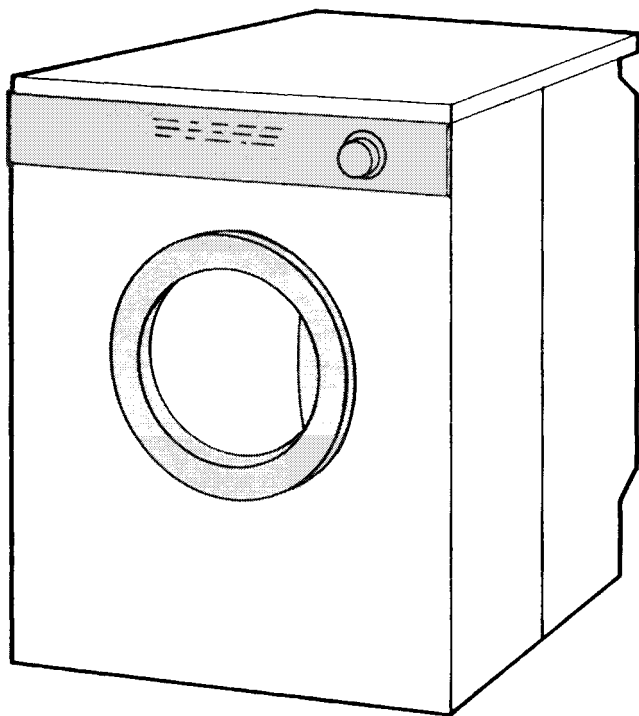

**TUMBLE DRYER
TD150/A**

ZANUSSI

CONTENTS

Page	3	Warnings
Page	4	The control panel
Page	6	Your machine
Page	7	Instructions for the installer
Page	9	Use of controls
Page	10	Drying times
Page	11	Drying 4 kg (9 lb) of cotton
Page	12	Drying 2 kg (4.5 lb) of synthetics
Page	13	Hints for successful drying
Page	14	Maintenance
Page	15	Servicing
Page	21	Zanussi guarantee conditions
Page	22	5 year cover

TECHNICAL SPECIFICATIONS

DIMENSIONS AND WEIGHT

Height	85 cm (33.5'')
Width	60 cm (23.6'')
Depth	57 cm (22.4'')
Weight	30 kg

ELECTRICAL CONNECTION

Voltage	220/240 V - 50 Hz
Maximum power absorbed	2650 W (13 A)

DRYING CAPACITY

Cotton, linen	4.5 kg (10 lb)
Synthetics, delicate fabrics	2 kg (4.5lb)

WARNINGS

It is most important that this instruction book should be retained with the appliance for future reference. Should the appliance be sold or transferred to another owner, or should you move house and leave the appliance, always ensure that the book is supplied with the appliance in order that the new owner can be acquainted with the functioning of the appliance and the relevant warnings.

THESE WARNINGS ARE PROVIDED IN THE INTEREST OF SAFETY. YOU MUST READ THEM CAREFULLY BEFORE INSTALLING OR USING THE APPLIANCE.

- ▲ Always switch off and unplug appliance after use.
- ▲ Any electrical work required to install this appliance should be carried out by a qualified electrician or competent person.
- ▲ This appliance is designed to be operated by adults. Children should not be allowed to tamper with the controls or play with the product.
- ▲ This product should be serviced by an Authorized Zanussi Network Service Centre, and only genuine Zanussi spare parts should be used.
- ▲ It is dangerous to alter the specifications or modify this product in any way.
- ▲ Care must be taken to ensure that the appliance does not stand on the electrical supply cable.
- ▲ Do not overload the appliance.
- ▲ As some duvets and eider-downs should be washed/dried in large commercial machines because of their bulk, please check with the manufacturer of the item before washing/drying in a domestic machine, even if the dry weight of the item is within the limit advised.
- ▲ Never tumble dry items that have had contact with chemicals such as dry cleaning fluid. These are of a volatile nature and could cause an explosion.
- ▲ Always check that there are no volatile or flammable objects left in pockets.
- ▲ The door becomes very hot during the drying cycle. Keep children away from the appliance when it is in operation.
- ▲ Leave the porthole door slightly ajar when not in use to preserve the door seal.
- ▲ Fluff filters must be cleaned after every use.
- ▲ Do not operate the appliance with a damaged filter or with no filter at all, as this may cause a fire.
- ▲ Zanussi tumble dryers are designed to be vented through to the open air. The appliance should have its own ventilation system which should not be joined with any other ventilation system connected to any other appliance.
- ▲ In order to prevent the appliance from overheating, it is important that the condensation vents are not obstructed.
- ▲ Pets or children have been known to climb into tumble dryers. Check your drum before use.
- ▲ The users should always check that they have not left their gas lighters (disposable or otherwise) in their clothing.
- ▲ Under no circumstances should you attempt to repair the machine yourself. Repairs carried out by inexperienced persons may cause injury or more serious malfunctioning. Refer to your local Zanussi Service Centre. Always insist on genuine Zanussi spare parts.

THE CONTROL PANEL

Keep this page open while reading the booklet

1

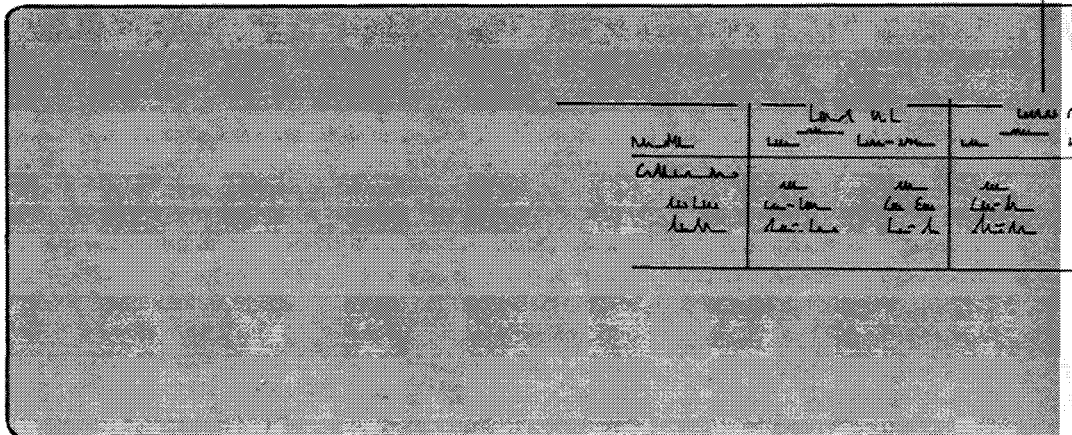

Mode	Cool		Power
	On	Off	
Auto	On	Off	On
Auto	On	Off	On
Auto	On	Off	On

- 1 Programme chart
- 2 Programme selector dial

SYMBOLS

Symbols provided on the control panel have the following meaning:

 Cooling phase

2

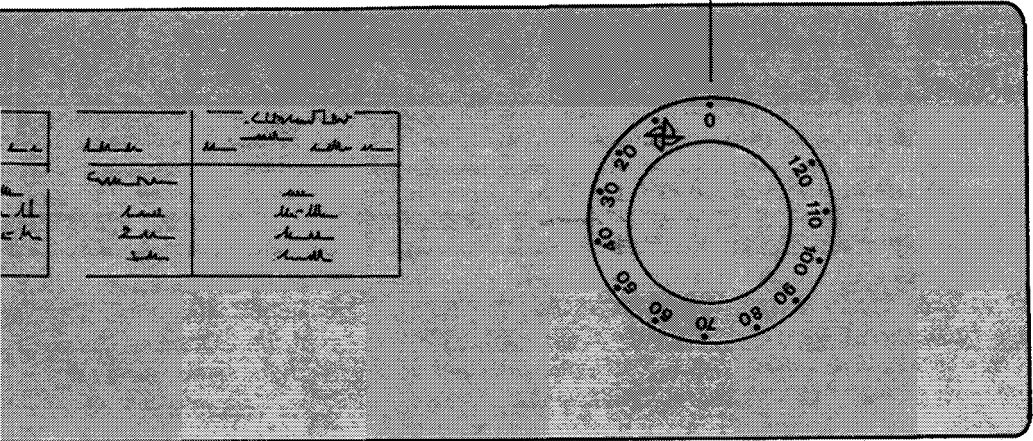

YOUR MACHINE

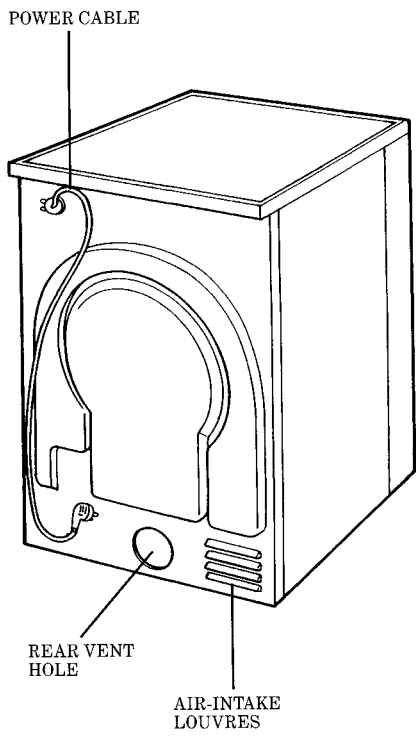
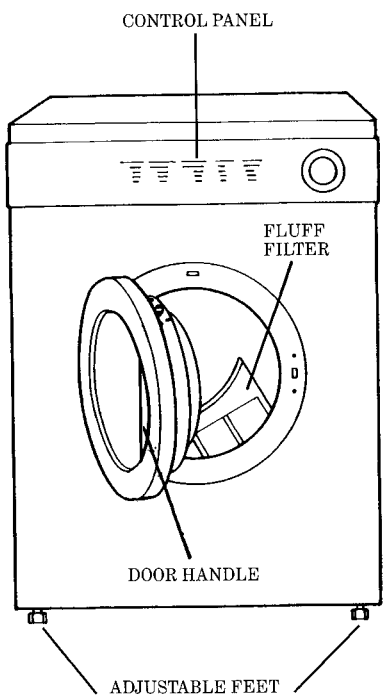

INSTRUCTIONS FOR THE INSTALLER

1

Install the appliance in a well ventilated room or close to a window since, whilst drying, the tumble dryer will expel a certain amount of moist air.

Room temperature must not exceed 35°C.

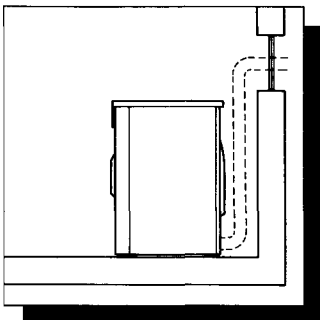

2

Condensation may be discharged through a vent outlet provided at the back.

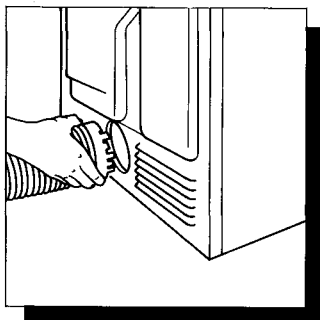

3

With the special plastic flexible tube (vent hose), which can be purchased from either your retailer or local service centre, you may discharge condensation directly outdoors.

The length of the vent hose must not be more than 2 m and it must not contain more than two bends when it is placed in position for operation.

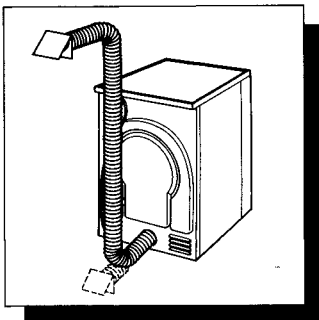

4

It is absolutely essential not to connect the flexible vent hose to, for example, a chimney or flue pipe designed to carry the exhaust from a fuel burning heating appliance.

The capacity of the venting circuit must be at least 150 m³/h.

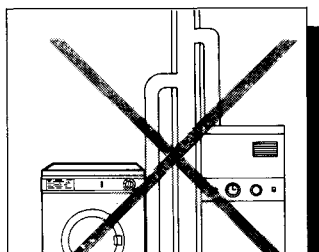

5

The tumble dryer must be installed in a clean place, where dirt does not build up.

Make sure there are no obstructing items or materials near the air-intake louvres provided at the back (such as for example paper, rags, etc.).

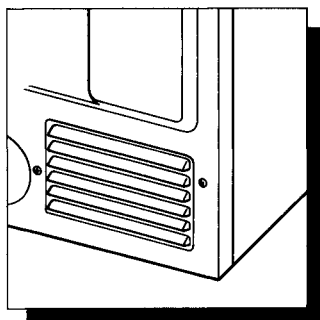

6

Level the tumble dryer into place by screwing or unscrewing the front feet as required. Accurate levelling will keep vibration and noise to a minimum when the dryer is in use.

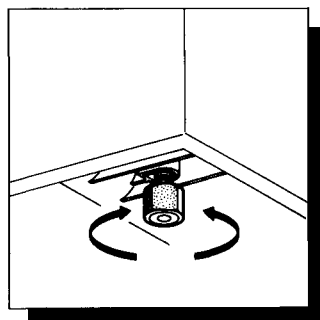

INSTRUCTIONS FOR THE INSTALLER

7

THE ELECTRICAL CONNECTIONS

WARNING

This appliance must be earthed-

The manufacturer declines any liability should this safety measure not be observed.

If the plug that is fitted to your appliance is not suitable for your socket outlet, it must be cut off and the appropriate plug fitted.

The cut off plug should be disposed of to prevent the hazard of electric shocks in case it should be plugged into a 13 Amp socket in another part of your home.

Important

The wires in this mains lead are coloured in accordance with the following code:

GREEN AND YELLOW - EARTH
BLUE - NEUTRAL
BROWN - LIVE

If you fit your own plug, the colours of the wires in the mains lead of your appliance may not correspond with the markings identifying the terminals in your plug, this is what you have to do:

Connect the green and yellow (earth) wire to the terminal in the plug which is marked with the letter «E» or coloured green, or green and yellow.

Connect the blue (neutral) wire to the terminal in the plug which is marked with the letter «N» or coloured black.

Connect the brown (live) wire to the terminal which is marked with the letter «L» or coloured red.

The plug moulded on to the cord incorporates a fuse. For replacement, use a 13 Amp BS 1362 fuse.

Only ASTA approved fuses should be used.

The fuse cover/carrier must be replaced in the event of changing fuse.

The right fuse cover/carrier colour is the one shown by the coloured insert at base of the plug.

The plug must not be used if the fuse cover/carrier is lost.

A replacement cover/carrier must be obtained from Zanussi Service Agents whose addresses are listed on the attached «Service and Spares Nationwide».

In addition, avoid connecting the dryer to the same socket as your washing machine (or any other appliance) by means of an adaptor.

Have an extra socket installed if necessary by a qualified electrician.

This appliance complies with E.E.C. directive no. 87/308 of 2.6.87 relative to radio interference suppression.

NOTE

Installation and, in particular, connection to the electric mains and to the discharge vent must be carried out by competent personnel or qualified technicians.

Please ensure that when the appliance is installed it is easily accessible for the engineer in the event of a breakdown.

USE OF CONTROLS

To obtain the best drying results it is essential to get to know the controls and how to use them properly.

1

PROGRAMME CHART

This will help you to select the correct time for drying.

2

PROGRAMME SELECTOR DIAL

The selector dial is marked with times in minutes corresponding with those on the chart (page 10).

To set the machine to the selected time, turn the dial clockwise until the time you want coincides exactly with the pointer.

Never attempt to turn the dial in an anticlockwise direction.

STARTING

THE TUMBLE DRYER

Load the damp laundry and then, before starting the appliance, carry out following checks:

- The mains switch is on.
- The vent hose, if you have one, is in position.
- The door is properly closed.

Select the drying time by turning the selector dial clockwise to the required time (see chart on page 10).

STOPPING

THE TUMBLE DRYER

Upon completion of the programme, the selector dial turns automatically to the STOP position and thus interrupts operation of the machine.

Remove the laundry from the machine.

The programme being carried out can be interrupted at any given moment by turning the selector dial to the STOP position.

DRYING TIMES

The selected drying time can be extended when the original programme is completed, by resetting the control knob for a further period of drying.

It is better to select a time which is too short and then set the dial for a further period if necessary.

Select the drying time according to your experience.

The programme guide is designed to help you.

Remember that during the last 8 minutes of the operation the heat is cut off in order to carry out a fabric cooling phase, which prevents any creasing or crumpling of the fabrics.

DRYING TIMES

COTTON AND LINEN

Degree of drying required	Degree of spin/drying given	Quantity	Selector dial setting
			HIGH TEMP.
Store dry	500 rpm	10 lb (4.5 kg)	80 to 100 mins
		5 lb (2.25 kg)	50 to 60 mins
	800 to 1000 rpm	10 lb (4.5 kg)	65 to 85 mins
		5 lb (2.25 kg)	45 to 55 mins
Iron dry	500 rpm	10 lb (4.5 kg)	65 to 85 mins
		5 lb (2.25 kg)	45 to 55 mins
	800 to 1000 rpm	10 lb (4.5 kg)	45 to 65 mins
		5 lb (2.25 kg)	30 to 40 mins

SYNTHETICS

Degree of drying required	Degree of spin/drying given	Quantity	Selector dial setting
			LOW TEMP.
Store dry	Short spin dry	4 lb (1.75 kg)	40 to 45 mins
		2 lb (0.9 kg)	25 to 30 mins
		1 lb (0.5 kg)	20 to 25 mins

If the laundry is spin-dried in a washing machine at less than 500 rpm, the residual dampness will be higher and consequently the drying time should be increased.

This applies particularly to laundry consisting primarily of towels.

If the laundry is spin-dried at more than 1000 rpm, the residual dampness will be lower and consequently the drying time should be decreased.

DRYING 4 KG (9 lb) OF COTTON

You have for example just machine-washed and spun at 1000 rpm 4 kg (9 lb) of laundry.

They are cotton fabrics of medium weight which you want to iron as soon as they are dried.

1

LOAD THE LAUNDRY

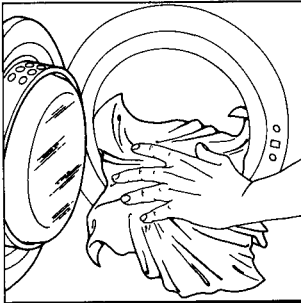

Open the door by pulling the handle outwards.

Load the items you have to dry one at a time, shaking them out loosely and close the door.

2

SELECT TIME AND

START THE MACHINE

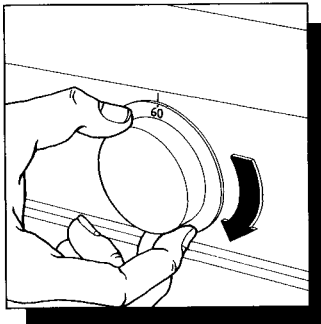

Following indications given in the drying times chart, turn the selector dial clockwise on the 60 mins setting. The dryer starts operating.

3

WHEN DRYING

IS COMPLETED

When the laundry is completely dry, the dryer stops automatically.

If the laundry is still too damp, select a further brief drying time, bearing in mind that during the 8 last minutes the dryer carries out the cooling and anticrease treatment phase.

DRYING 2 KG (4.5 lb) OF SYNTHETICS

You have for example just machine-washed and briefly spun 2 kg (4.5 lb) of synthetics which do not need ironing.

1

LOAD THE LAUNDRY

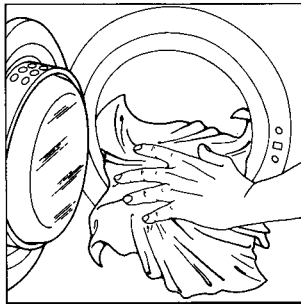

Open the door by pulling the handle outwards.

Load the items you have to dry one at a time, shaking them out loosely and close the door.

2

SELECT TIME AND START THE MACHINE

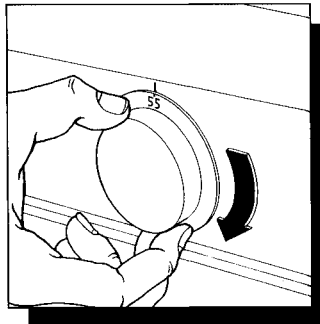

Following indications given in the drying times chart, turn the selector dial clockwise on the 55 mins setting. The dryer starts operating.

3

WHEN DRYING IS COMPLETED

When the laundry is completely dry, the dryer stops automatically.

If the laundry is still too damp, select a further brief drying time, bearing in mind that during the 8 last minutes the dryer carries out the cooling and anticrease treatment phase.

HINTS ON DRYING

● Do not overload the dryer. During the first times you're using the dryer weigh the laundry loads.

Here is a list of the average weights of the more common laundry items according to an approximate basis.

Sheet	700 to 1000 gr
Pillowcase	100 to 200 gr
Tablecloth	400 to 500 gr
Table napkin	50 to 100 gr
Kitchen towel	70 to 120 gr
Linen hand towel	100 to 150 gr
Sponge hand towel	150 to 250 gr
Sponge bath towel	700 to 1000 gr
Bathrobe	1000 to 1500 gr
Shirt	200 to 300 gr
Apron	150 to 200 gr

● However, the best and most economical load is the maximum indicated for the different types of fabric.

● Always load well spun laundry. The higher the spin speed the lower is electric energy consumption and the shorter is the drying time.

● Do not leave the damp laundry load in a heap too long before drying.

● Sort the laundry out: Separate synthetics from cotton and linen and dry them separately.

● Close poppers and zips and fasten any buttons found loose.

● Do not use the tumble dryer to dry the following:

- Dry-cleaned fabrics or fabrics cleaned with chemical solvents.
- Woollen garments and those manufactured from synthetic/wool mixtures of the heat-shrinkable type.
- Very delicate articles such as silk and curtains made of synthetic material.
- Foam-rubber articles.
- Fibre-glass articles.

● In some cases, labels on articles may also be of help.

 Vigorous drying

 Delicate drying

 Do not tumble dry

● Avoid drying dark clothes with light coloured fluffy items such as towels as they could attract the fluff.

● If you overdry the laundry, besides wasting energy, any subsequent ironing may become more difficult because the fabric could be heavily crumpled.

● Remove the laundry when the dryer has finished drying.

● To avoid a static charge when drying is completed, use either a fabric softener when you are washing the laundry or a fabric conditioner specifically for tumble dryers.

● When you have finished tumble drying do not forget to clean the filter. If the filter is dirty, drying times are increased considerably and consequently energy consumption is also increased.

MAINTENANCE

IMPORTANT

You are advised to unplug the appliance before all cleaning and maintenance operations.

EXTERNAL CLEANING

Use only soap and water and then dry thoroughly.

From time to time, apply a little wax furniture cream with a soft cloth.

CLEANING

THE DOOR

Clean periodically the interior part of the door to eliminate any fluff.

Only an accurate cleaning ensures a correct drying.

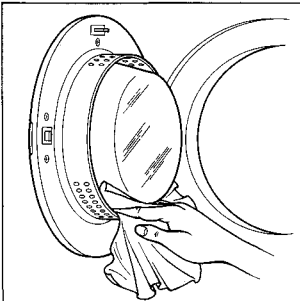

CLEANING

THE FILTER

Your dryer will only function well if the filter is clean.

The filter collects all the «fluff» which accumulates during drying and it must therefore be removed and cleaned at the end of each programme.

To remove the filter it is sufficient to lift it up.

The filter can be opened for easy cleaning.

It is perfectly normal for fluff to accumulate in the filter during drying. In fact, even fabrics dried in the open air lose their fibres, but we do not notice it.

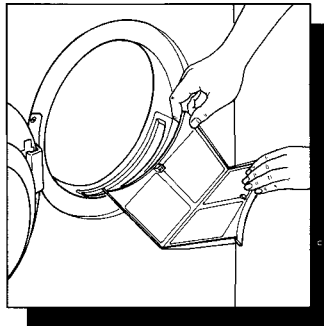

SERVICING

In some cases, functional problems may be due to lack of basic maintenance or to incorrect procedures when starting the machine and, in such cases, may be easily solved without the need for a service call.

■ PROBLEM	● CAUSE	▶ SOLUTION
■ THE DRYER DOES NOT START	● The door is open	▶ Close the door
	● The plug is not fitted into the wall socket	▶ Fit the plug into the wall socket
	● There is no electric supply from the wall socket	▶ Have the fuse replaced if it has blown ▶ Contact a qualified electrician
	● The programme selector dial is not set correctly	▶ Turn the dial to the required time
■ THE DRYER DOES NOT DRY PROPERLY	● The filter is clogged	▶ Clean the filter after each drying operation
	● Insufficient drying time	▶ Carry out an extra drying phase
	● Excessive laundry load	▶ Reduce the laundry load
	● The dryer is not correctly installed	▶ Check to see installation is in accordance with instructions (see pages 7 and 8). In particular, check efficiency of air-intake louvres and of the condensation vents.

If, after the above checks, there is still a fault, call your nearest Zanussi Service Force Centre, whose address and telephone number can be found on the following pages.

Please make sure you give the model and serial number of the appliance. This information can be found on the rating plate, or on the guarantee certificate.

Original spare parts can be purchased from Zanussi Service Force Centres.

In-guarantee customers should ensure that the above checks have been made as the engineer will make a charge if the fault is not a mechanical or electrical breakdown.

Please note that proof of purchase is required for any in-guarantee service calls.

How to find the telephone number of your Zanussi Service Force listed in this leaflet

Zanussi Service areas are allocated by postcodes which are listed in alphabetical order for easy reference.

1. Look for the two letters of your address postcode in the far left 'Postcode' column.
2. Match up the number of your postcode against the number listed in the 'Postcode Numbers' column.
3. Look across the column to the Service Force Key Number for your area. Turn to the last page of this directory for the address and telephone number to contact for service which is listed against your key number.

If you are unsure of your postcode, the main towns and cities are listed in alphabetical order for easy reference.

Additionally, your local Zanussi Service Force Centre telephone number is listed under 'Z' in your telephone directory.

The Customer Care Department at Zanussi House, Hambridge Road, Newbury, RG14 5EP, Tel: 0635 521313, will be happy to help you with any queries or difficulties.



Post-code Letter	Town	Post-code Number	Service Force Key Number	Post-code Letter	Town	Post-code Number	Service Force Key Number
AB	Aberdeen	1-5	1	DE	Derby	11-12	18
AL	St Albans	1-10	2	DG	Dumfries	1-7, 10-12	34
A	Brecon	45	3	DG		13-14	35
BA	Bath	1-5, 11-15	4	DG		8-9	36
BA		7-10, 20-22	5	DH	Durham	1-9	37
BA		6, 16	6	DL	Darlington	1-17	37
BB	Blackburn	1-12	7	DN	Doncaster	1-7, 10-12, 22	33
BD	Bradford	1-23	8	DN		14	38
BD		24	7	DN	Doncaster	8-9, 15-21, 31-40	39
BH	Bournemouth	1-18, 21-25	9	SUB POSTCODE DIVISION			
BH		19-20	10	DN	Gainsborough		
BL	Bury	0-9	11		South	21-1, 21-2, 21-5	40
BN	Brighton	1-9, 11-15,	12	DN	Gainsborough		
BN		20-27	12		North	21-3, 21-4	39
BN		16-18	13				
BR	Bromley	1-8	14	DT	Dorchester	1-6, 10-11	10
BS	Bristol	1-28, 98-99	15	DT		6-9	5
BT	Belfast	1-82	16	SUB POSTCODE DIVISION			
B	Birmingham	1-21, 25-33,	17	DT	Bridport East	6-3, 6-4	10
B		38, 40, 45, 47-48,	17	DT	Bridport West	6-5, 6-6	5
B		60-71, 80, 97-98	17				
B	Birmingham	23-24, 34-37,	18	DY	Dudley	1-6, 8-9	17
B		42-44, 46, 72-	18	DY		7, 10-14	41
B		79	18	EC	London	All EC Codes	28
B	Birmingham	49-50,	19	EH	Edinburgh	1-42, 52-54	42
B		96	19	EH		43-46	35
B	Birmingham	95	20	EH	Edinburgh	47-49, 51, 55	43
CA	Carlisle	1-16, 18-28	21	EN	Enfield	1-11	28
CA		17	7	EX	Exeter	1-17, 20	45
CB	Cambridge	1-8	22	EX		18-23, 31-39	46
CB		9-11	23	E	London	All East Codes	28
CF	Cardiff	1-8, 31-48	3	FK	Falkirk	1-4	43
CH	Chester	1-4	24	FK		10-14, 18-19	32
CH		5-7	25	FK	Falkirk	5-9, 15-17	47
CH		8	26	FK		20-21	31
CM	Chelmsford	0-6, 8-9, 11-15	27	FY	Fleetwood	0-8	7
CM		7	23	GCI	Guernsey		48
CM	Chelmsford	16-24	28	GL	Gloucester	1-8, 10-19,	49
CO	Colchester	1-16	23	GL		50-56	49
CR	Croyden	0, 2-4, 9	29	GL		9	15
CT	Canterbury	1-21	14	GL		20	19
CV	Coventry	1-8, 10-12, 21-23,	20	GU	Guildford	1-24, 26, 34-35	50
CV		9, 13	18	GU		25	51
CV	Coventry	31-35, 37	20	GU	Guildford	27-33	13
CV		36	19	G	Glasgow	1-5, 11-15, 20-23,	47
CW	Crewe	1-12	30	G		31-34, 40-46, 51-	47
DA	Dartford	1-18	14	G	Glasgow	53, 58, 60-69, 73,	47
DD	Dundee	1-5, 7-11	31	G		76-78, 81-84	47
DD			22	G			

Post-code Letter	Town	Postcode Number	Service Force Key Number	Post-code Letter	Town	Postcode Number	Service Force Key Number
HA	Harrow	0-9	52	L	Liverpool	1-49, 60-70	24
HD	Huddersfield	1-8	8	ME	Medway	1-20, 99	14
HG	Harrogate	1-5	8	MK	Milton Keynes	1-17, 19, 40-46	22
HP	Hemel	1-3	2	MK		18	65
HP	Hempstead	4-23	53	ML	Motherwell	1-12	43
HR	Hereford	1-2, 4, 6-9	49	M	Manchester	1-35, 60	11
HR		3, 5	54	NE	Newcastle-on-Tyne	1-49, 61-70, 88	66
HU	Hull	1-20, 55	38	NE		98-99	66
HX	Halifax	1-7	8	NE		71	35
IG	Ilford	1-11	28	NG	Nottingham	1-23, 25	33
IOM	Isle of Man		55	NG		24	40
IP	Ipswich	1-15, 30-31	56	NG	Nottingham	31-34	64
IP		16-27	57	NN	Northampton	1-7, 11-12	67
IP	Ipswich	28-29, 32-33	22	NN		8-10, 14-18	22
IV	Inverness	1-24, 26, 30-36,	58	NN	Northampton	13	65
IV		40-49, 51-56	58	NP	Newport	1-9, 44	3
IV	Inverness	25, 27-28	59	NR	Norwich	1-35	57
JCI	Jersey		60	NW	London	All NW Codes	52
KA	Kilmarnock	1-26, 28-30	43	N	London	All N Codes	28
KA		27	61	OL	Oldham	1-12, 15-16	11
KT	Kingston-on-Thames	1-23	51	OL		13-14	7
KT		24	50	OX	Oxford	1-17	65
KW	Wick	1-14	59	PA	Paisley	1-4	47
KW		15-17	62	PA		5-19	43
KY	Kirkcaldy	1-16	32	PA	Paisley	20-27, 33, 35, 40-	68
LA	Lancaster	1-23	7	PA		49	68
LD	Llandrindod	1-8	54	PA		28-31	69
LD		3	3	PA	Paisley	32, 34, 36-39, 61	70
LE	Leicester	1-5, 7-8, 11-14,	63	PA		62-78	68
LE		16-17	63	PA	Paisley	80-82, 88	71
LE	Leicester	6, 9-10	63	PA		83-87	72
LE		15	64	PE	Peterborough	1-15, 34, 38	64
LL	Llandudno	11-15	25	PE		16-19	22
LL		16-19	26	PE	Peterborough	20-25	40
LL	Llandudno	20-21, 23, 27, 31-	25	PE		30-33, 35-37	57
LL		32, 34-40, 42-47	25	PH	Perth	1-2, 8-9, 10-18	31
LL	Llandudno	22, 24-26, 28-30,	26	PH		3-7	32
LL		33-34, 41, 48-49,	26	PH	Perth	19-26, 30-44	58
LL		51-78	26	PL	Plymouth	1-21	73
LN	Lincoln	1-6, 8-10	40	PL		22-35	74
LN		7, 11-13	39	PO	Portsmouth	1-22	13
				PO		30-41	75
SUB POSTCODE DIVISION				PR	Preston	1-9	7
LN	Lincoln	3-4, 3-5	40	RG	Reading	1-17, 26	53
LN		3-6	39	RG		21-25, 27	50
				RG	Reading	28	4
LS	Leeds	1-29	8	RH	Redhill	1-3, 6-7, 9-20	12
LU	Luton	1-6	2	RH		4-5	50
LU		7	22	RH	Redhill	8	29

Post-code Letter	Town	Postcode Number	Service Force Key Number	Post-code Letter	Town	Postcode Number	Service Force Key Number
RM	Romford	1-5, 7, 10-18	27	TR	Truro	1-27	74
RM		6, 8-9	28	TS	Stockton-on-Tees	1-29	37
SA	Swansea	1-20, 31-32	3	TW	Twickenham	1-20	51
SA		33-39, 41-44, 61-73	76	UB	Uxbridge	1-10	52
SA	Swansea	40, 45-48	77	WA	Warrington	1-5, 8-9, 10-15	11
SE	London	All SE Codes	29	WA		6-7	24
SG	Stevenage	1-9, 11, 15	2	WA	Warrington	16	30
SG		10, 12-14	28	WC	London	All WC Codes	52
SG	Stevenage	16-19	22	WD	Watford	1-2, 4-7	2
SK	Stockport	1-3, 6-12	30	WD		3	53
SK		4-5, 13-16	11	WF	Wakefield	1-17	8
SK	Stockport	17	33	WN	Wigan	1-5, 7	11
SL	Slough	1-10	53	WN		6, 8	24
SM	Sutton	1-3, 7	51	WR	Worcester	1-14	19
SM		4-6	29	WR		15	41
SN	Swindon	1-8, 11-16	65	WS	Walsall	1-15	18
SN		9-10	4	WV	Wolverhampton	1-4, 10-14	18
SO	Southampton	1, 4, 41-43, 51	9	WV		5-9, 15-16	41
SO		2-3, 5, 21-24, 52	13	W	London	All West Codes	52
SO	Southampton	20	4	YO	York	1-3, 5, 7-8	8
SP	Salisbury	1-5, 9-11	4	YO		4, 6, 11-18, 25	38
SP		6	9	YO	York	21-22	37
SP	Salisbury	7-8	10	ZE	Lerwick	1,3	79
SR	Sunderland	1-7, 9	66	ZE		2	80
SR		8	37				
SS	Southend-on-Sea	0-9, 11-17, 99	27				
ST	Stoke-on-Trent	1-18, 20-21	30				
ST		19	18				
SW	London	All SW Codes Except 2, 9, 16	52				
SW	London	2, 9, 16	29				
SY	Shrewsbury	1-6, 9-17, 18-22	25				
SY		7, 17-19	54				
SY	Shrewsbury	8	41				
SY		23-25	77				
S	Sheffield	1-19, 30-31, 40-45,	33				
S		60-66, 74, 80-81	33				
S	Sheffield	70-73, 75	8				
TA	Taunton	1-11, 21-24	6				
TA		12-20	5				
TD	Selkirk	1-15	35				
TF	Telford	1-8, 10-13	41				
TF		9	30				
TN	Tonbridge	1-2, 4, 8-18, 23-30	14				
TN		3, 5-7, 19-22, 31-40	12				
TQ	Torquay	1-6, 9, 12-13	78				
TQ		7-8	73				
TQ		14	45				

Service Force Key Number	Service Force Address	Telephone Number	Service Force Key Number	Service Force Address	Telephone Number
1	60 Commerce Street, Aberdeen, AB2 1BP or Tel:	0224 583949 0224 582704	41	1 Underhill Street, Bridgnorth, Salop, WV16 4BB	0746 763322
2	Unit 4, Riverside Est, Coldharbour Ln, Harpenden	05827 461908	42	38 Buccleuch Street, Dalkeith, Midlothian, EH22	031 663 7758
3	3 Pentwyn Road, Blackwood, Gwent, Sth Wales	0495 223151	43	Block 2 Unit 5, Auchenraith Ind. Est. Rosendale Way, Blantyre	0698 828145
4	31 St Andrews Road, Bemerton, Salisbury, SP2	0722 336072	45	91 Exeter Road, Exmouth, Devon, EX8 1QD	0395 263531
5	31 East Street, Crewkerne, Somerset, TA18	0460 72740	46	3 Bear St, Barnstaple, North Devon, EX32	0271 71774
6	80 Killigrew Street, Falmouth, Cornwall, TR11	0984 31858	47	Unit E6C Anniesland Ind. Est. Netherton Rd, Glasgow, Scotland	041 954 5304
7	333 Rangleit Road, Walton Summit, Preston, PR5	0772 321200		or Tel:	041 954 5349
8	7 Crown Street, Leeds, Yorks, LS2	0532 460992	48	Blencathra, Saumarez Lane, Castel, Guernsey	0481 56854
9	63 Curzon Road, Bournemouth, BH1 4PW	0202 303363	49	134 Eastgate Street, Gloucester, GL1 1QT	0452 422488
10	Poundbury Road, Dorchester, Dorset, DT1 2PJ	0305 264951	50	Unit 1 Redfields Ind. Pk, Church Crookham, Fleet	0252 851414
11	Unit 41/42 Clarendon Ct, Winwick Quay, W'ton	0925 50822	51	127 Walton Road, Molesey, Surrey, KT8 0DT	081 979 6366
12	Sydney House, Queens Road, Haywards Heath	0444 417656	52	27 Christchurch Ind. Est. Forward Drive, Harrow	081 427 4247
13	266 Main Road, Southbourne, Emsworth, PO10 or Tel:	0243 374814 0243 371170	53	Reform Road, Maidenhead, Berkshire	0628 783711
14	Bridgewood Hse, 8 Laker Road, Rochester, ME1 or Tel:	0634 201441 0689 61444	54	Merion House, High Street, Llandrindod Wells	0597 4842
15	89 Stoke Croft Road, Bristol, Avon, BS1 3RD or Tel:	0272 246271 0272 246378	55	Tromode Wks, Cronkbourne Vill, Douglas, I.O.M.	0624 76066
16	Owenmore Hse, Kilwee Ind. Est., Upper Dunmurry Lane, Belfast	0232 301121	56	Unit 2b, Elton Park Business Centre, Hadleigh Rd, Ipswich, IP2 0DQ	0473 211713 0603 629653
17	66 Birch Rd East, Wyreley Rd Ind. Est, B'ham	021 327 1671	57	75 Grove Road, Norwich, NR1 3RL	0463 791822
18	Unit 3 Sterling Park, Claymore, Tamworth or Tel:	0827 289800 0827 289822	58	Unit 3B3, Smithton Ind. Est. Smithton, Inverness	040 833517
19	22 Newton Road, Malvern, Worcester	0684 572915	59	Main Street, Golspie, Sutherland, KW10 6RA	0534 67001
20	Unit 3, Bryant Road, Exhall, Coventry	0203 644277	60	P.O.Box 45, Queens Road, St Helier, Jersey	077 086 246
21	High Ehenside, Egremont, Cumbria, CA22	0946 820509	61	Bruach, Blackwaterfoot, Isle of Arran	0856 5457
22	1 Wharf Road, Higham Ferrers, Northants	0933 317727	62	Hatson Ind. Estate, Kirkwall, Orkney	0858 33229
23	Unit 18, Fourth Ave, Bluebridge Ind. Est, Halstead, Essex	0787 473982	63	30a Scotland Road, Market Harborough, LE16	0778 422147
24	Unit 14, Dock Road, Birkenhead, L41 1JJ	051 639 1287	64	Pinfold Rd, Manning Rd Ind. Est. Bourne, Lincs	0869 248598
25	Plas Fynnon W/house, Middleton Rd, Oswestry	0691 652917	65	Unit E19, Telford Rd, Launton Ind. Est. Bicester	091 2960166
26	Easy Laundrette, Panton Hall, Denbigh, Clwyd	074 571 3272	66	Unit C1, Bergen Cl, Tyne Tunnel Trad. Estate, North Shields, Tyne & Wear	0604 37061
27	19 Sirdar Rd, Off Brook Rd, Rayleigh, Essex	0268 741171	67	53 Sandringham Road, Northampton, NN1 5NA	0369 2147
28	284 Alma Road, Enfield, EN3	081 805 6825	68	96 Argyll Street, Dunoon, Argyll, PA23 7NE	0586 52008
29	194 Court Road, Eltham, London, SE9 4EN	081 859 3939	69	43 Crosshill Avenue, Carnelton, Argyll	0631 62690
30	Unit 8b, Alderflatt Dr, Newstead Ind. Est. Stoke-on-Trent, ST4 8HX	0782 643814	70	Strathblayne, Miller Road, Oban	0870 2331
31	3-7 Blackness Street, Dundee, Scotland, DD1 or Tel:	0382 642828 0382 455862	71	2 Killweivagh, Gregoy, Benbecula, Outer Hebrides	0851 5555
32	33a Burnside, Auchtermuchty, Fife, Scotland	0337 28807	72	Churchouse, 16 James St, Stornaway, Isle of Lewis	0752 222540
33	Unit 63, Storforth Ln Trad. Est. Chesterfield	0246 231790	73	6 Embankment Ln, Embankment Rd, Plymouth	0326 314600
34	93 Irish Street, Dumfries, Scotland	0387 69694	74	80 Killigrew Street, Falmouth, Cornwall, TR11	0983 523062
35	2-8 Wood Market, Kelso, Borders, TD5 7AX	0573 24411	75	109-111 Hunnyhill, Newport, Isle of Wight	0437 710366
36	27 Antrim Ave, Stranraer, Dumfries & Galloway	0776 3277	76	Roch, Haverfordwest, Dyfed	0545 570254
37	8 Cumbie Way, Aycliffe Ind. Est. Newton Aycliffe	0325 300606	77	4 Market Street, Aberaeron, W. Wales, SA46	0803 526222
38	Unit 1, Boulevard Unit Fact. Est. Hull, HU3 4AY	0482 223335	78	250-252 Torquay Road, Preston, Paignton	0595 2915
39	Unit 2, Cromwell Road, Grimsby, DN31 2BN	0472 358760	79	3-4 Carlton Place, Lerwick, Shetland, ZE1	08066 546
40	Unit 14 Stonefield Park, Clifton Street, Lincoln	0522 532330	80	Harlsdale, Symbister, Whalasaay, Shetland	

PEACE OF MIND FOR TWELVE MONTHS

Zanussi Standard Guarantee Conditions

This guarantee is in addition to your statutory and other legal rights which will not be excluded or in any way diminished by the return of this guarantee card.

We, Zanussi Ltd., undertake that if within twelve months of the date of the purchase this ZANUSSI appliance or any part thereof is proved to be defective by reason only of faulty workmanship or materials, we will, at our option repair or replace the same **FREE OF ANY CHARGE** for labour, materials or carriage on condition that:

- * The appliance has been correctly installed and used only on the electricity supply stated on the rating plate.
- * The appliance has been used for normal domestic purposes only, and in accordance with the manufacturer's operating and maintenance instructions.
- * The appliance has not been serviced, maintained, repaired, taken apart or tampered with by any person not authorised by us.
- * The appliance is still in the possession of the original purchaser.

All service work under this guarantee must be undertaken by a Zanussi Service Force Centre. Any appliance or defective part replaced shall become our property.

EXCLUSIONS

This guarantee does not cover:

- * Damage or calls resulting from transportation, improper use or neglect, the replacement of any light bulbs or removable parts of glass or plastic.
- * Costs incurred for calls to put right machines improperly installed or calls to machines outside the United Kingdom.
- * Appliances found to be in use within a commercial environment, plus those which are the subject of rental agreements.

* Products of Zanussi manufacture which are NOT marketed by Zanussi Ltd.

* EEC Countries - the standard guarantee is applicable but is subject to the owner's responsibility and cost to ensure the appliance meets the standards set by the country to which the product is taken. The Zanussi company in the country concerned will be pleased to advise further. Sight of your purchase receipt will be required by them.

... OR FIVE YEARS

ZANUSSI 5 YEAR

COVER CONDITIONS

For a once-only payment you can extend your Standard Guarantee to 5 years.

All the conditions and exclusions of the Standard Guarantee apply.

NOTES

1. Products supplied as "seconds", refurbished, damaged, or shop-soiled are not eligible for Zanussi 5 Year Cover.
2. The issue of a cover does NOT by virtue of our having done so, nullify the exclusions.
3. The Engineer will need to check the details of your Cover card and may make a charge for his services if it is not presented to him at the time of his call.
4. The date of purchase, or the date of initial payment (deposit) of the appliance will be deemed the date of commencement of cover.
5. Covers issued are not refundable or transferable.

GUARANTEE RECORD

Appliance purchased from..... on.....
Guarantee card no..... Model no.....
Serial no..... (These details may be taken from your Guarantee Record Card)

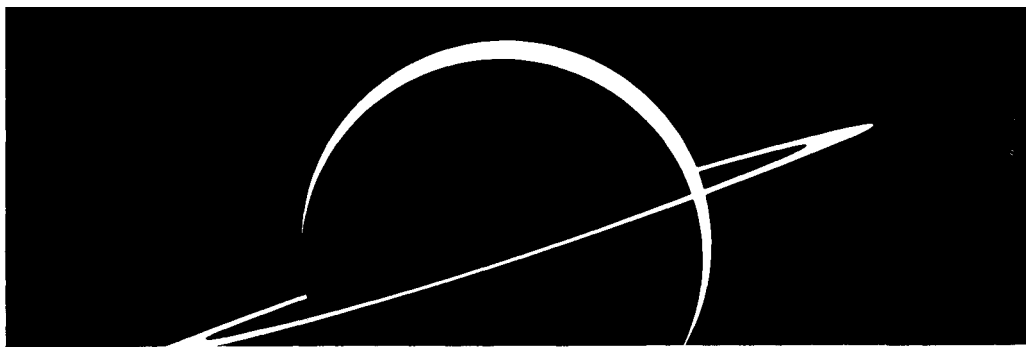

ZANUSSI

The appliance of science

Zanussi Ltd., Zanussi House, Newbury

The information in this manual is correct at time of going to press.

Free Manuals Download Website

<http://myh66.com>

<http://usermanuals.us>

<http://www.somanuals.com>

<http://www.4manuals.cc>

<http://www.manual-lib.com>

<http://www.404manual.com>

<http://www.luxmanual.com>

<http://aubethermostatmanual.com>

Golf course search by state

<http://golfingnear.com>

Email search by domain

<http://emailbydomain.com>

Auto manuals search

<http://auto.somanuals.com>

TV manuals search

<http://tv.somanuals.com>