

INSTRUCTION BOOKLET

**READ AND KEEP
THESE INSTRUCTIONS**

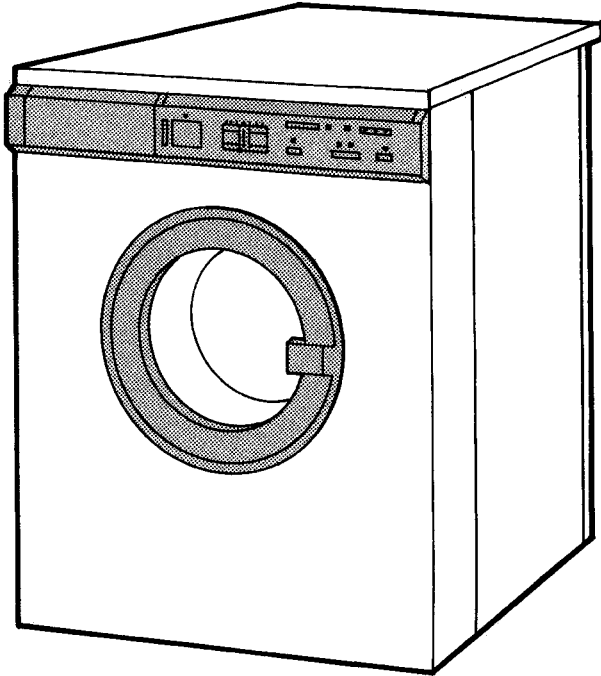

**TUMBLE DRYER
TE350**

ZANUSSI

CONTENTS

Page	3	Warnings
Page	4	The control panel
Page	6	Your machine
Page	7-9	Instructions for the installer
Page	10-11	Use of controls
Page	12	Drying programmes
Page	13	Drying 4 kg (9 lb) of cotton
Page	14	Drying 2 kg (4 lb) of synthetics
Page	15	Hints for successful drying
Page	16	Maintenance
Page	17	Servicing
Page	18	Specifications
Page	19	Zanussi guarantee conditions
Page	25	5 year cover

WARNINGS

It is most important that this instruction book should be retained with the appliance for future reference. Should the appliance be sold or transferred to another owner, or should you move house and leave the appliance, always ensure that the book is supplied with the appliance in order that the new owner can be acquainted with the functioning of the appliance and the relevant warnings.

THESE WARNINGS ARE PROVIDED IN THE INTEREST OF SAFETY. YOU MUST READ THEM CAREFULLY BEFORE INSTALLING OR USING THE APPLIANCE.

- ▲ Always switch off and unplug appliance after use.
- ▲ Any electrical work required to install this appliance should be carried out by a qualified electrician or competent person.
- ▲ This appliance is designed to be operated by adults. Children should not be allowed to tamper with the controls or play with the product.
- ▲ This product should be serviced by an Authorized Zanussi Network Service Centre, and only genuine Zanussi spare parts should be used.
- ▲ It is dangerous to alter the specifications or modify this product in any way.
- ▲ Care must be taken to ensure that the appliance does not stand on the electrical supply cable.
- ▲ Do not overload the appliance.
- ▲ As some duvets and eider-downs should be washed/dried in large commercial machines because of their bulk, please check with the manufacturer of the item before washing/drying in a domestic machine, even if the dry weight of the item is within the limit advised.
- ▲ Never tumble dry items that have had contact with chemicals such as dry cleaning fluid. These are of a volatile nature and could cause an explosion.
- ▲ Always check that there are no volatile or flammable objects left in pockets.
- ▲ The door becomes very hot during the drying cycle. Keep children away from the appliance when it is in operation.
- ▲ Leave the porthole door slightly ajar when not in use to preserve the door seal.
- ▲ Fluff filters must be cleaned after every use.
- ▲ Do not operate the appliance with a damaged filter or with no filter at all, as this may cause a fire.
- ▲ Zanussi tumble dryers are designed to be vented through to the open air. The appliance should have its own ventilation system which should not be joined with any other ventilation system connected to any other appliance.
- ▲ In order to prevent the appliance from overheating, it is important that the condensation vents are not obstructed.
- ▲ Pets or children have been known to climb into tumble dryers. Check your drum before use.
- ▲ The users should always check that they have not left their gas lighters (disposable or otherwise) in their clothing.
- ▲ Under no circumstances should you attempt to repair the machine yourself. Repairs carried out by inexperienced persons may cause injury or more serious malfunctioning. Refer to your local Zanussi Service Centre. Always insist on genuine Zanussi spare parts.

THE CONTROL PANEL

Keep this page open while reading the booklet

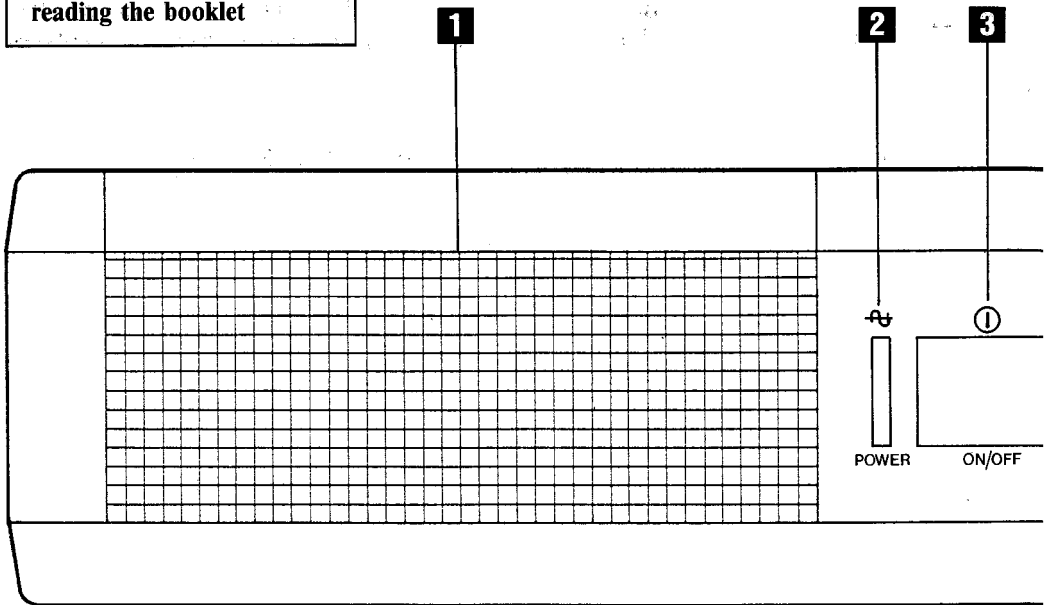

- 1** Programme chart
- 2** Pilot light
- 3** On/Off switch
- 4** Sensor programme selector
- 5** Timed drying push button
- 6** Timed drying light
- 7** Reduced drying temperature push button
- 8** «Cooling phase» light for timed drying
- 9** Warning light
- 10** Buzzer silencer push button
- 11** Cycle phase display
- 12** Cycle starting push button

SYMBOLS

The symbols located on the control panel, have the following meaning:

① On/Off

⊖°C Reduced temperature

⬇ Start

⊖ Timed drying

⊗ Buzzer excluded

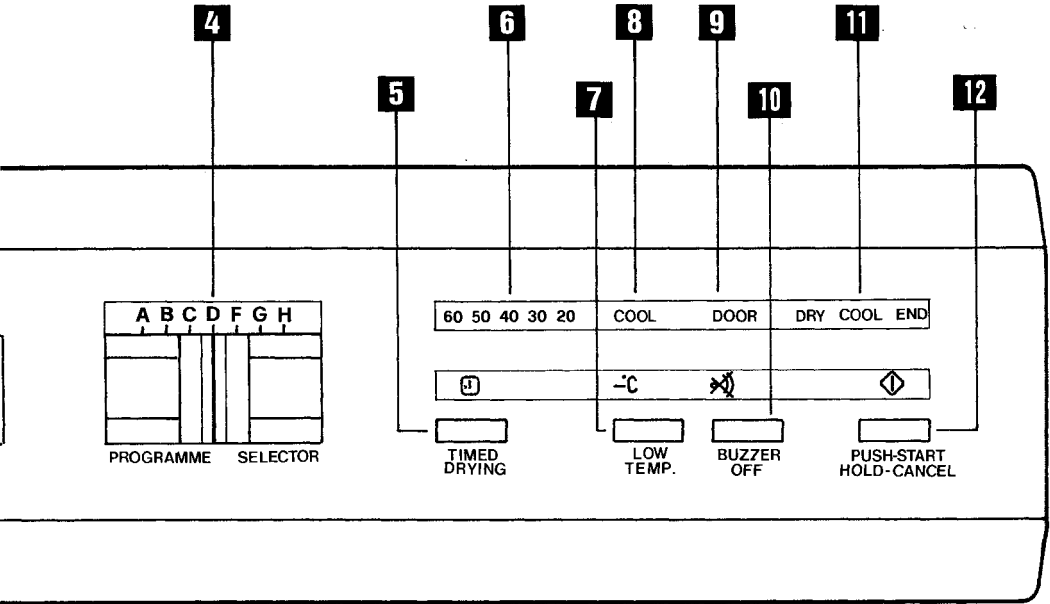

YOUR MACHINE

The TE350 is an electric sensor tumble dryer, and features seven sensor programmes for different degrees of dryness with automatic temperature and timer control (no more guessing).

If you want to take charge, you have got the option to choose a timed drying cycle to suit your needs.

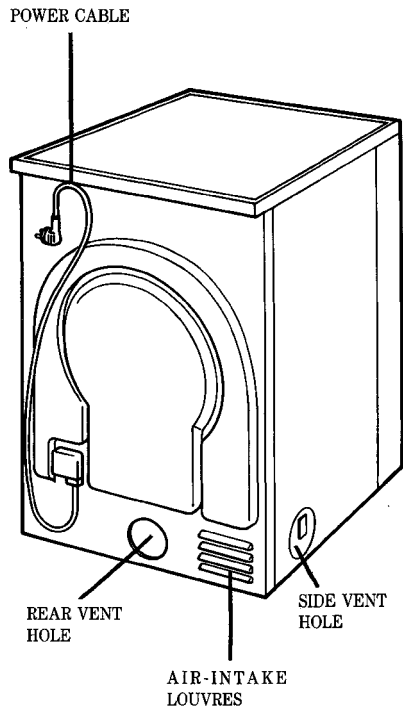
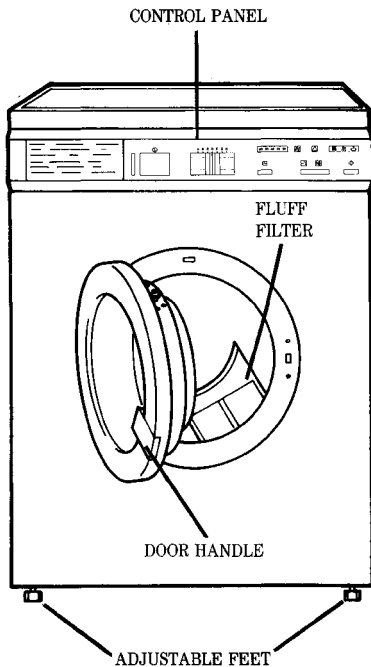

INSTRUCTIONS FOR THE INSTALLER

1

Install the appliance in a well ventilated room or close to a window since, whilst drying, the tumble dryer will expel a certain amount of moist air.

Room temperature must not exceed 35°C.

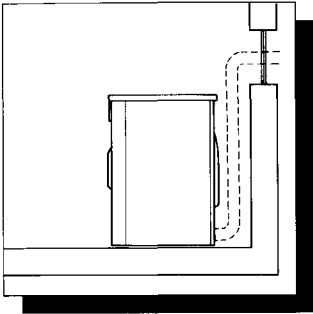

2

Condensation may be discharged either through a vent outlet provided at the back or through the side vent outlet. The unused outlet must be covered with the cover provided for such a purpose.

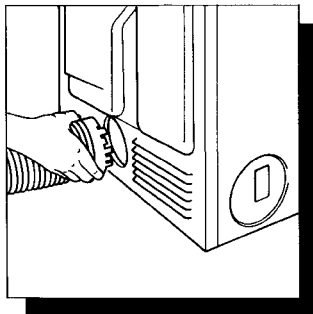

3

With the special plastic flexible tube (vent hose), available on request by your local dealer, you may discharge condensation directly outdoors.

The length of the vent hose must not be more than 2 m and it must not contain more than two bends when it is placed in position for operation.

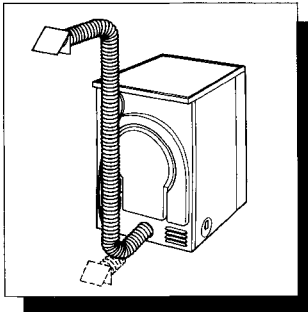

4

It is absolutely essential not to connect the flexible vent hose to, for example, a chimney or flue pipe designed to carry the exhaust from a fuel burning heating appliance.

The capacity of the venting circuit must be at least 150 m³/h.

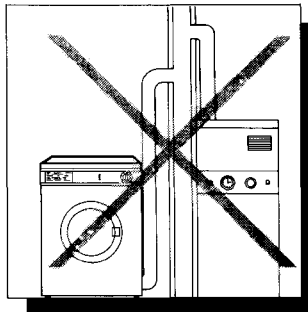

5

The tumble dryer must be installed in a clean place, where dirt does not build up.

Make sure there are no obstructing items or materials near the air-intake louvres provided at the back (such as for example paper, rags, etc.).

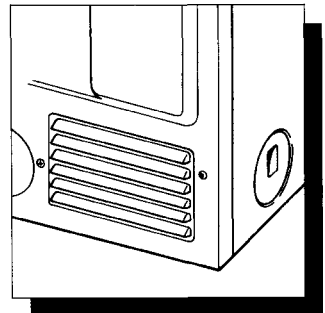

6

Level the tumble dryer into place by screwing or unscrewing the front feet as required.

Accurate levelling will keep vibration and noise to a minimum when the dryer is in use.

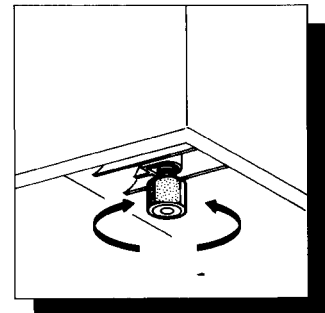

INSTRUCTIONS FOR THE INSTALLER

7

THE ELECTRICAL CONNECTIONS

WARNING

This appliance must be earthed

The manufacturer declines any liability should this safety measure not be observed.

If the plug that is fitted to your appliance is not suitable for your socket outlet, it must be cut off and the appropriate plug fitted.

The cut off plug should be disposed of to prevent the hazard of electric shocks in case it should be plugged into a 13 Amp socket in another part of your home.

Important

The wires in this mains lead are coloured in accordance with the following code:

GREEN AND YELLOW - EARTH
BLUE - NEUTRAL
BROWN - LIVE

If you fit your own plug, the colours of the wires in the mains lead of your appliance may not correspond with the markings identifying the terminals in your plug, this is what you have to do:

Connect the green and yellow (earth) wire to the terminal in the plug which is marked with the letter «E» or the earth symbol or coloured green, or green and yellow.

Connect the blue (neutral) wire to the terminal in the plug which is marked with the letter «N» or coloured black.

Connect the brown (live) wire to the terminal which is marked with the letter «L» or coloured red.

The plug moulded on to the cord incorporates a fuse. For replacement, use a 13 Amp BS 1362 fuse.

Only ASTA approved fuses should be used.

The fuse cover/carrier must be replaced in the event of changing fuse.

The right fuse cover/carrier colour is the one shown by the coloured insert at base of the plug.

The plug must not be used if the fuse cover/carrier is lost.

A replacement cover/carrier must be obtained from Zanussi Service Agents whose addresses are listed on the attached «Service and Spares Nationwide».

In addition, avoid connecting the dryer to the same socket as your washing machine (or any other appliance) by means of an adaptor.

Have an extra socket installed if necessary by a qualified electrician.

This appliance complies with E.E.C. directive no. 87/308 of 2.6.87 relative to radio interference suppression.

ELECTRIC CABLE REPLACEMENT

If necessary, the electric cable can be replaced.

Unplug the appliance.

The terminal board is located at the back of the appliance and is easily accessible.

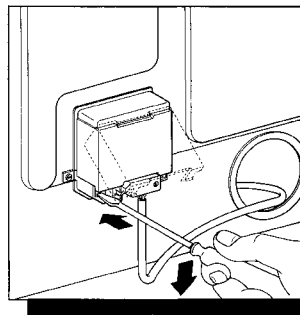

Depress with a screwdriver the two tongues of the terminal board lid, lift it, unscrew the screw fixing the cable, unscrew the terminals and replace the cable.

NOTE

Installation and, in particular, connection to the electric mains and to the discharge vent must be carried out by competent personnel or qualified technicians.

Please ensure that when the appliance is installed it is easily accessible for the engineer in the event of a breakdown.

DOOR REVERSAL

8

This operation must be carried out by qualified personnel.

To make it easier to load or unload the laundry the door can be reversed.

To do this operate as follows:

- Remove the door by unscrewing the two screws (1) fastening the hinge to the cabinet.
- Remove the safety pin (2) by bending the two fastening tags.
- Remove the block (3) by bending the two fastening tags.
- Refit the safety pin (2) and block (3) on the opposite sides of the door, making sure they are accurately engaged.
- Remove the plastic plate (4) by unscrewing the two fastening screws.
- Refit the plastic plate (4) on the opposite side.
- Refit the door by screwing in the two screws (1) which fasten the door to the cabinet.

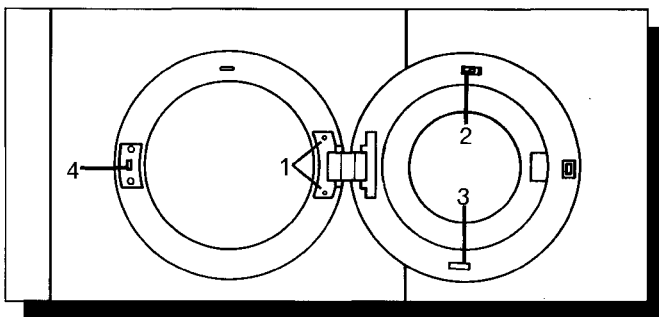
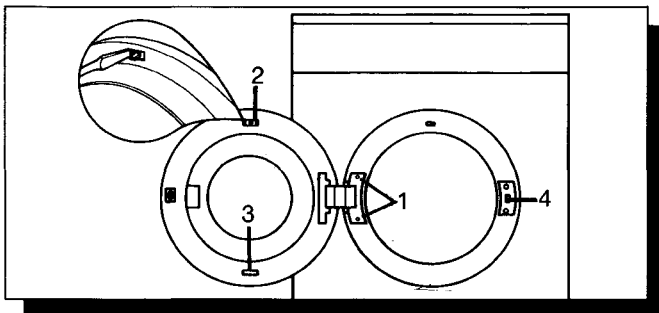

USE OF CONTROLS

To obtain the best drying results it is essential to get to know the controls and how to use them properly.

1

PROGRAMME CHART

This lists the drying programmes.

2

PILOT LIGHT

It lights up when the on/off switch is depressed and goes out when it is pressed again.

3

ON/OFF SWITCH

Before using the machine, depress the on/off switch.

4

PROGRAMME SELECTOR

The red bar in the centre of the slider should be moved to line up with the required programme.

5

MANUAL DRYING PUSH BUTTON

If you do not wish to use the automatic sensor programmes this push button allows you to manually select the required drying time.

Push the button until the desired drying time is lit up on the display.

6

MANUAL DRYING TIME LIGHT

The display will show the drying time selected.

7

COOLING PHASE LIGHT

This light indicates that the cooling phase is in operation.

8

REDUCED TEMPERATURE PUSH BUTTON

This reduces the drying temperature, and should be used when drying polyester-cotton, or particularly delicate synthetics. Drying times are longer when this function is used.

Programme «H» (delicate synthetics) reduces the temperature automatically.

9

WARNING LIGHT

The light starts blinking when the door is open or when the temperature control units are not functioning correctly.

USE OF CONTROLS

10

BUZZER

SILENCER

PUSH BUTTON

If you do not wish the buzzer to sound at the end of the drying programme, depress this push button.

11

PROGRAMME

PHASE DISPLAY

This shows the progression of the programme.

12

PROGRAMME

STARTING

PUSH BUTTON

Press this push button to start the drying programme. This button can be used to cancel the programme at any stage by pressing for a few seconds.

STARTING

Once the laundry is loaded and before starting the dryer, be sure that:

- The mains switch is on.
- The vent hose, if you have one, is in position.
- The door is properly closed.



Switch on the on/off switch, and the pilot light will come on. Select the programme or the desired drying time. If required depress the reduced temperature button and/or the buzzer silencer push button.

At this point push the start button and the dryer will start.

STOPPING

THE TUMBLE

DRYER

The end of the cycle is signalled by the buzzer (if the  push button has not been activated) and by the cycle completion  light.

To help avoid creasing the drum will continue to rotate for a period of time, if you are not able to remove the laundry immediately.

Depress the on/off  push button, open the door, and unload the laundry.

The appliance should be unplugged once the programme has finished.

DRYING

PROGRAMMES

The dryer is provided with various programmes, each of which is suitable for different types of fabrics.

You should ensure that the correct programme is used for the type of fabric being dried.

Refer to the programme chart after consulting the fabric care label in the garment, first ensuring that the garment is suitable for tumble drying.

DRYING PROGRAMMES

Type of laundry	Degree of drying required	Quantity	Programme selector setting
Cotton & Linen	Extra dry	4.5 kg (10 lb) max	A
	Cupboard dry	4.5 kg (10 lb) max	B
	Slightly damp	4.5 kg (10 lb) max	D
	Hand iron dry	4.5 kg (10 lb) max	F
	Machine iron dry	4.5 kg (10 lb) max	G
Synthetics	Cupboard dry	1.75 kg (4 lb) max	C
Delicate synthetics	Cupboard dry	1.75 kg (4 lb) max	H

TIME CONTROLLED CYCLES

Time controlled drying cycles are ideal for drying small loads of laundry and to complete the drying cycle of sensor programmes, if necessary.

Type of laundry	Degree of drying required	Quantity	Timed drying setting
For all types of fabric	According to your needs	4.5 kg (10 lb) max	Selected time: max. 60 mins.

DRYING FOR EXAMPLE 4 kg (9 lb) OF COTTON

You have for example just machine-washed and spun 4 kg (9 lb) of laundry.

They are cotton fabrics of medium weight which you want to iron as soon as they are dried.

1

LOAD THE LAUNDRY

Open the door by pulling the handle outwards.

Load the items you have to dry one at a time shaking them out loosely and close the door.

2

PROGRAMME SELECTION

Switch on the on/off switch (pilot light will light up).

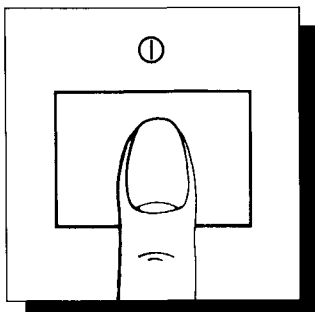

Slide the programme selector until the red line in the centre of the slider lines up with letter F.

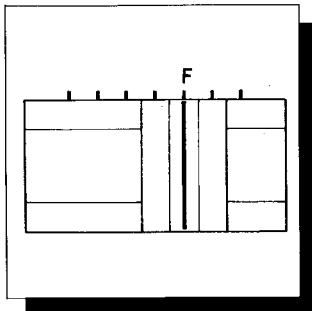



3

START

Ensure that:

The plastic venting hose (if you have one) is in position;



The warning light  is off (if lit, the door may be open).

Press the  start push button.

The drying cycle display  will light up to show the dryer is in operation.

4

ONCE THE DRYING CYCLE IS CONCLUDED

The end of the cycle is signalled by the buzzer signal and the cycle completion light . To help avoid creasing the drum will continue to rotate for a period of time, if you are not able to remove the laundry immediately. Depress the re-set button  for a few seconds (only if the cycle completion light is still lit), open the door and unload the laundry. Check the filter and clean if necessary. When you have finished using the dryer, switch off the on/off switch and unplug at the mains.

DRYING FOR EXAMPLE 2 kg (4 lb) OF SYNTHETICS

You have for example just machine-washed and briefly spun 2 kg (4 lb) of synthetics which do not need ironing.

1 LOAD THE LAUNDRY

Open the door by pulling the handle outwards.

Load the items you have to dry one at a time, shaking them out loosely and close the door.

2 PROGRAMME SELECTION

Switch on the on/off switch (pilot light will light up).

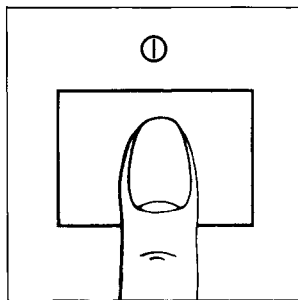

Slide the programme selector until the red line in the centre of the slider lines up with letter H.

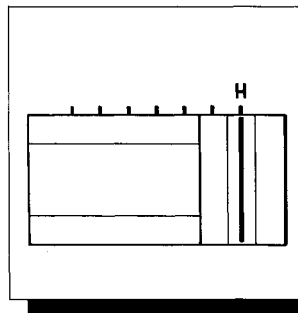



In this programme, temperature reduction switches on automatically (lamp  lights up).

3 START

Ensure that:

The plastic venting hose (if you have one) is in position;

The alarm light  is off (if lit, the door may be open). Press the  start push button.

The drying cycle display  will light up to show the dryer is in operation.

4 ONCE THE DRYING CYCLE IS CONCLUDED

The end of the cycle is signalled by the buzzer signal and the programme end light .

To help avoid creasing the drum will continue to rotate for a period of time, if you are not able to remove the laundry immediately.

Depress the on/off  push button, open the door, and unload the laundry.

The appliance should be unplugged once the programme has finished.

HINTS ON DRYING

● Do not overload the dryer. During the first times you're using the dryer weigh the laundry loads.

Here is a list of the average weights of the more common laundry items according to an approximate basis.

Sheet	700 to 1000 gr
Pillowcase	100 to 200 gr
Tablecloth	400 to 500 gr
Table napkin	50 to 100 gr
Kitchen towel	70 to 120 gr
Linen hand towel	100 to 150 gr
Sponge hand towel	150 to 250 gr
Sponge bath towel	700 to 1000 gr
Bathrobe	1000 to 1500 gr
Shirt	200 to 300 gr
Apron	150 to 200 gr

● However, the best and most economical load is the maximum indicated for the different types of fabric.

● Always load well spun laundry.

The higher the spin speed the lower is electric energy consumption and the shorter is the drying time.

● Do not leave the damp laundry load in a heap too long before drying.

● Sort the laundry out: Separate synthetics from cotton and linen and dry them separately.

● Close poppers and zips and fasten any buttons found loose.

● Do not use the tumble dryer to dry the following:

- Dry-cleaned fabrics or fabrics cleaned with chemical solvents.
- Woollen garments and those manufactured from synthetic/wool mixtures of the heat-shrinkable type.
- Very delicate articles such as silk and curtains made of synthetic material.
- Foam-rubber articles.
- Fibre-glass articles.

● In some cases, labels on articles may also be of help.

Vigorous drying

Delicate drying

Do not tumble dry

● Avoid drying dark clothes with light coloured fluffy items such as towels as they could attract the fluff.

● If you overdry the laundry, besides wasting energy, any subsequent ironing may become more difficult because the fabric could be heavily crumpled.

● Remove the laundry when the dryer has finished drying.

● To avoid a static charge when drying is completed, use either a fabric softener when you are washing the laundry or a fabric conditioner specifically for tumble dryers.

● When you have finished tumble drying do not forget to clean the filter. If the filter is dirty, drying times are increased considerably and consequently energy consumption is also increased.

MAINTENANCE

IMPORTANT

You are advised to unplug the appliance before all cleaning and maintenance operations.

EXTERNAL CLEANING

Use only soap and water and then dry thoroughly.

From time to time, apply a little wax furniture cream with a soft cloth.

CLEANING THE DOOR

Clean periodically the interior part of the door to eliminate any fluff.

Only an accurate cleaning ensures a correct drying.

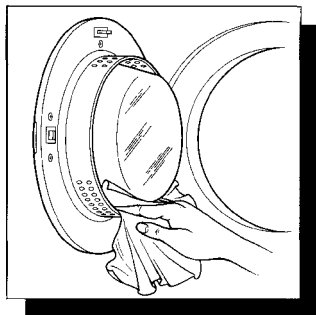

CLEANING

THE FILTER

Your dryer will only function well if the filter is clean.

The filter collects all the «fluff» which accumulates during drying and it must therefore be removed and cleaned at the end of each programme.

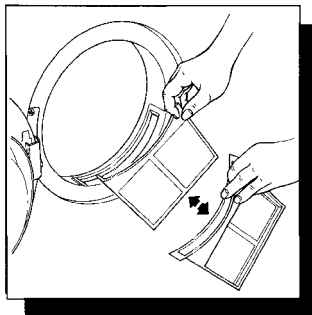





The filter is composed of two parts which facilitate cleaning operations.

It is perfectly normal for fluff to accumulate in the filter during drying. In fact, even fabrics dried in the open air lose their fibres, but we do not notice it.

SERVICING

In some cases, functional problems may be due to lack of basic maintenance or to incorrect procedures when starting the machine and, in such cases, may be easily solved without the need for a service call.

■ PROBLEM	● CAUSE	▶ SOLUTION
■ THE DRYER DOES NOT START	● The door is open (the warning light  is lit)	▶ Close the door (the warning light  will go out)
	● The plug is not fitted into the wall socket	▶ Fit the plug into the wall socket
	● There is no electric supply from the wall socket.	▶ Have the fuse replaced if it has blown ▶ Contact a qualified electrician
	● The programme selector is not set correctly	▶ Slide the selector to the desired programme
	● The On/Off switch has not been switched on (pilot light is off)	▶ Press the On/Off switch (pilot light lights up)
	● The start push button  has not been activated (programme phase display switched off)	▶ Press the start push button  (programme phase display lights up)
■ THE DRYER DOES NOT DRY PROPERLY	● The filter is clogged	▶ Clean the filter after each drying operation
	● The wrong programme has been selected	▶ Select the right programme. See the drying programmes (page 12)
	● Excessive laundry load	▶ Reduce the laundry load
	● The dryer is not correctly installed	▶ Check to see installation is in accordance with instructions (see pages 7 and 8). In particular, check efficiency of air-intake louvres and of the condensation vents.

If, after the above checks, there is still a fault, call your nearest Zanussi Service Force Centre, whose address and telephone number can be found on the following pages.

Please make sure you give the model and serial number of the appliance. This information can be found on

the rating plate, or on the guarantee certificate.

Original spare parts can be purchased from Zanussi Service Force Centres.

In-guarantee customers should ensure that the above checks have been made as the engineer will make a charge if the fault is not a mechanical or electrical breakdown.

Please note that proof of purchase is required for any in-guarantee service calls.

TECHNICAL SPECIFICATIONS

DIMENSIONS AND WEIGHT

Height	85 cm (33.5)
Width	60 cm (23.6)
Depth	57 cm (22.4)
Weight	32 kg (70 lbs)

ELECTRICAL CONNECTION

Voltage	220/240 V (50 Hz)
Maximum power absorbed	2650 W

CAPACITY

Cotton, linen	4.5 kg (10 lbs)
Synthetics, delicate fabrics	2 kg (4,5 lbs)

How to find the telephone number of your Zanussi Service Force listed in this leaflet

Zanussi Service areas are allocated by postcodes which are listed in alphabetical order for easy reference.

1. Look for the two letters of your address postcode in the far left 'Postcode' column.
2. Match up the number of your postcode against the number listed in the 'Postcode Numbers' column.
3. Look across the column to the Service Force Key Number for your area. Turn to the last page of this directory for the address and telephone number to contact for service which is listed against your key number.

If you are unsure of your postcode, the main towns and cities are listed in alphabetical order for easy reference.

Additionally, your local Zanussi Service Force Centre telephone number is listed under 'Z' in your telephone directory.

The Customer Care Department at Zanussi House, Hambridge Road, Newbury, RG14 5EP, Tel: 0635 521313, will be happy to help you with any queries or difficulties.



Post-code Letter	Town	Post-code Number	Service Force Key Number	Post-code Letter	Town	Post-code Number	Service Force Key Number
AB	Aberdeen	1-5	1	DE	Derby	11-12	18
AL	St Albans	1-10	2	DG	Dumfries	1-7, 10-12	34
A	Brecon	45	3	DG		13-14	35
BA	Bath	1-5, 11-15	4	DG		8-9	36
BA		7-10, 20-22	5	DH	Durham	1-9	37
BA		6, 16	6	DL	Darlington	1-17	37
BB	Blackburn	1-12	7	DN	Doncaster	1-7, 10-12, 22	33
BD	Bradford	1-23	8	DN		14	38
BD		24	7	DN	Doncaster	8-9, 15-21, 31-40	39
BH	Bournemouth	1-18, 21-25	9				
BH		19-20	10	SUB POSTCODE DIVISION			
BL	Bury	0-9	11	DN	Gainsborough		
BN	Brighton	1-9, 11-15,	12		South	21-1, 21-2, 21-5	40
BN		20-27	12	DN	Gainsborough		
BN		16-18	13		North	21-3, 21-4	39
BR	Bromley	1-8	14	DT	Dorchester	1-6, 10-11	10
BS	Bristol	1-28, 98-99	15	DT		6-9	5
BT	Belfast	1-82	16				
B	Birmingham	1-21, 25-33,	17	SUB POSTCODE DIVISION			
B		38, 40, 45, 47-48,	17	DT	Bridport East	6-3, 6-4	10
B		60-71, 80, 97-98	17	DT	Bridport West	6-5, 6-6	5
B	Birmingham	23-24, 34-37,	18				
B		42-44, 46, 72-	18	DY	Dudley	1-6, 8-9	17
B		79	18	DY		7, 10-14	41
B	Birmingham	49-50,	19	EC	London	All EC Codes	28
B		96	19	EH	Edinburgh	1-42, 52-54	42
B	Birmingham	95	20	EH		43-46	35
CA	Carlisle	1-16, 18-28	21	EH	Edinburgh	47-49, 51, 55	43
CA		17	7	EN	Enfield	1-11	28
CB	Cambridge	1-8	22	EX	Exeter	1-17, 20	45
CB		9-11	23	EX		18-23, 31-39	46
CF	Cardiff	1-8, 31-48	3	E	London	All East Codes	28
CH	Chester	1-4	24	FK	Falkirk	1-4	43
CH		5-7	25	FK		10-14, 18-19	32
CH		8	26	FK	Falkirk	5-9, 15-17	47
CM	Chelmsford	0-6, 8-9, 11-15	27	FK		20-21	31
CM		7	23	FY	Fleetwood	0-8	7
CM	Chelmsford	16-24	28	GCI	Guernsey		48
CO	Colchester	1-16	23	GL	Gloucester	1-8, 10-19,	49
CR	Croyden	0, 2-4, 9	29	GL		50-56	49
CT	Canterbury	1-21	14	GL		9	15
CV	Coventry	1-8, 10-12, 21-23,	20	GL		20	19
CV		9, 13	18	GU	Guildford	1-24, 26, 34-35	50
CV	Coventry	31-35, 37	20	GU		25	51
CV		36	19	GU	Guildford	27-33	13
CW	Crewe	1-12	30	G	Glasgow	1-5, 11-15, 20-23,	47
DA	Dartford	1-18	14	G		31-34, 40-46, 51-	47
DD	Dundee	1-5, 7-11	31	G	Glasgow	53, 58, 60-69, 73,	47
DD		6	32	G		76-78, 81-84	47
DE	Derby	1-7, 13-15, 55	33	G	Glasgow	71-72, 74-75	43

Post-code Letter	Town	Postcode Number	Service Force Key Number	Post-code Letter	Town	Postcode Number	Service Force Key Number
RM	Romford	1-5, 7, 10-18	27	TR	Truro	1-27	74
RM		6, 8-9	28	TS	Stockton-on-		
SA	Swansea	1-20, 31-32	3		Tees	1-29	37
SA		33-39, 41-44, 61-73	76	TW	Twickenham	1-20	51
SA	Swansea	40, 45-48	77	UB	Uxbridge	1-10	52
SE	London	All SE Codes	29	WA	Warrington	1-5, 8-9, 10-15	11
SG	Stevenage	1-9, 11, 15	2	WA		6-7	24
SG		10, 12-14	28	WA	Warrington	16	30
SG	Stevenage	16-19	22	WC	London	All WC Codes	52
SK	Stockport	1-3, 6-12	30	WD	Watford	1-2, 4-7	2
SK		4-5, 13-16	11	WD		3	53
SK	Stockport	17	33	WF	Wakefield	1-17	8
SL	Slough	1-10	53	WN	Wigan	1-5, 7	11
SM	Sutton	1-3, 7	51	WN		6, 8	24
SM		4-6	29	WR	Worcester	1-14	19
SN	Swindon	1-8, 11-16	65	WR		15	41
SN		9-10	4	WS	Walsall	1-15	18
SO	Southampton	1, 4, 41-43, 51	9	WV	Wolverhampton	1-4, 10-14	18
SO		2-3, 5, 21-24, 52	13	WV		5-9, 15-16	41
SO	Southampton	20	4	W	London	All West Codes	52
SP	Salisbury	1-5, 9-11	4	YO	York	1-3, 5, 7-8	8
SP		6	9	YO		4, 6, 11-18, 25	38
SP	Salisbury	7-8	10	YO	York	21-22	37
SR	Sunderland	1-7, 9	66	ZE	Lerwick	1,3	79
SR		8	37	ZE		2	80
SS	Southend-on-						
	Sea	0-9, 11-17, 99	27				
ST	Stoke-on-						
	Trent	1-18, 20-21	30				
ST		19	18				
SW	London	All SW Codes	52				
		Except 2, 9, 16					
SW	London	2, 9, 16	29				
SY	Shrewsbury	1-6, 9-17, 18-22	25				
SY		7, 17-19	54				
SY	Shrewsbury	8	41				
SY		23-25	77				
S	Sheffield	1-19, 30-31, 40-45,	33				
S		60-66, 74, 80-81	33				
S	Sheffield	70-73, 75	8				
TA	Taunton	1-11, 21-24	6				
TA		12-20	5				
TD	Selkirk	1-15	35				
TF	Telford	1-8, 10-13	41				
TF		9	30				
TN	Tonbridge	1-2, 4, 8-18, 23-30	14				
TN		3, 5-7, 19-22, 31-40	12				
TQ	Torquay	1-6, 9, 12-13	78				
TQ		7-8	73				
TQ		14	45				

Service Force Key Number	Service Force Address	Telephone Number	Service Force Key Number	Service Force Address	Telephone Number
1	60 Commerce Street, Aberdeen, AB2 1BP	0224 583949	41	1 Underhill Street, Bridgnorth, Salop, WV16 4BB	0746 763322
	or Tel:	0224 582704	42	38 Buccleuch Street, Dalkeith, Midlothian, EH22	031 663 7758
2	Unit 4, Riverside Est, Coldharbour Ln, Harpenden	05827 461906	43	Block 2 Unit 5, Auchentraith Ind. Est. Rosendale Way, Blantyre	0698 828145
3	3 Pentwyn Road, Blackwood, Gwent, Sth Wales	0495 223151	45	91 Exeter Road, Exmouth, Devon, EX8 1QD	0395 263531
4	31 St Andrews Road, Bemerton, Salisbury, SP2	0722 336072	46	3 Bear St, Barnstaple, North Devon, EX32	0271 71774
5	31 East Street, Crewkerne, Somerset, TA18	0460 72740	47	Unit E6C Anniesland Ind. Est. Netherton Rd, Glasgow, Scotland	041 954 5304
6	80 Killigrew Street, Falmouth, Cornwall, TR11	0984 31858		or Tel:	041 954 5349
7	333 Rangleat Road, Walton Summit, Preston, PR5	0772 321200	48	Blencathra, Saumarez Lane, Castel, Guernsey	0481 56854
8	7 Crown Street, Leeds, Yorks, LS2	0532 460992	49	134 Eastgate Street, Gloucester, GL1 1QT	0452 422488
9	63 Curzon Road, Bournemouth, BH1 4PW	0202 303363	50	Unit 1 Redfields Ind. Pk, Church Crookham, Fleet	0252 851414
10	Poundbury Road, Dorchester, Dorset, DT1 2PJ	0305 264951	51	127 Walton Road, Molesey, Surrey, KT8 0DT	081 979 6366
11	Unit 41/42 Clarendon Ct, Winwick Quay, Wotton	0925 50822	52	27 Christchurch Ind. Est. Forward Drive, Harrow	081 427 4247
12	Sydney House, Queens Road, Haywards Heath	0444 417656	53	Reform Road, Maidenhead, Berkshire	0628 783711
13	266 Main Road, Southbourne, Emsworth, PO10	0243 374814	54	Merion House, High Street, Llandrindod Wells	0597 4842
	or Tel:	0243 371170	55	Tromode Wks, Cronkbourne Vill, Douglas, I.O.M.	0624 76066
14	Bridgewood Hse, 8 Laker Road, Rochester, ME1	0634 201441	56	Unit 2b, Elton Park Business Centre, Hadleigh Rd, Ipswich, IP2 0DQ	0473 211713
	or Tel:	0689 61444	57	75 Grove Road, Norwich, NR1 3RL	0603 629653
15	89 Stoke Croft Road, Bristol, Avon, BS1 3RD	0272 246271	58	Unit 3B3, Smithton Ind. Est. Smithton, Inverness	0463 791822
	or Tel:	0272 246378	59	Main Street, Golspie, Sutherland, KW10 6RA	040 833517
16	Owenmore Hse, Kilwee Ind. Est., Upper Dunmurry Lane, Belfast	0232 301121	60	P.O.Box 45, Queens Road, St Helier, Jersey	0534 67001
17	66 Birch Rd East, Wyreley Rd Ind. Est. B'ham	021 327 1671	61	Bruach, Blackwaterfoot, Isle of Arran	077 086 246
18	Unit 3 Sterling Park, Claymore, Tamworth	0827 289800	62	Hatson Ind. Estate, Kirkwall, Orkney	0856 5457
	or Tel:	0827 289822	63	30a Scotland Road, Market Harborough, LE16	0858 33229
19	22 Newton Road, Malvern, Worcester	0684 572915	64	Pinfold Rd, Manning Rd Ind. Est. Bourne, Lincs	0778 422147
20	Unit 3, Bryant Road, Exhall, Coventry	0203 644277	65	Unit E19, Telford Rd, Launton Ind. Est. Bicester	0869 248598
21	High Ehenside, Egremont, Cumbria, CA22	0946 820509	66	Unit C1, Bergen Cl, Tyne Tunnel Trad. Estate, North Shields, Tyne & Wear	091 2960166
22	1 Wharf Road, Higham Ferrers, Northants	0933 317727	67	53 Sandringham Road, Northampton, NN1 5NA	0604 37061
23	Unit 18, Fourth Ave, Bluebridge Ind. Est, Halstead, Essex	0787 473982	68	96 Argyll Street, Dunoon, Argyll, PA23 7NE	0369 2147
24	Unit 14, Dock Road, Birkenhead, L41 1JJ	051 639 1287	69	43 Crosshill Avenue, Camelstown, Argyll	0586 52008
25	Plas Fynnon W/ouse, Middleton Rd, Oswestry	0691 652917	70	Strathblayne, Miller Road, Oban	0631 62690
26	Easy Launderette, Panton Hall, Denbigh, Clwyd	074 571 3272	71	2 Killweivagh, Gregory, Benbecula, Outer Hebrides	0870 2331
27	19 Sirdar Rd, Off Brook Rd, Rayleigh, Essex	0268 741171	72	Churchouse, 16 James St, Stornaway, Isle of Lewis	0851 5555
28	284 Alma Road, Enfield, EN3	081 805 6825	73	6 Embankment Ln, Embankment Rd, Plymouth	0752 222540
29	194 Court Road, Eitham, London, SE9 4EN	081 859 3939	74	80 Killigrew Street, Falmouth, Cornwall, TR11	0326 314600
30	Unit 8b, Alderflat Dr, Newstead Ind. Est. Stoke-on-Trent, ST4 8HX	0782 643814	75	109-111 Hunnyhill, Newport, Isle of Wight	0983 523062
31	3-7 Blackness Street, Dundee, Scotland, DD1	0382 642828	76	Roch, Haverfordwest, Dyfed	0437 710366
	or Tel:	0382 455862	77	4 Market Street, Aberaeron, W. Wales, SA46	0545 570254
	or Tel:	0382 826809	78	250-252 Torquay Road, Preston, Paighton-	0803 526222
32	33a Burnside, Auchtermuchty, Fife, Scotland	0337 28807	79	3-4 Carlton Place, Lerwick, Shetland, ZE1	0595 2915
33	Unit 63, Storforth Ln Trad. Est. Chesterfield	0246 231790	80	Harlsdale, Symbister, Whalasaay, Shetland	08066 546
34	93 Irish Street, Dumfries, Scotland	0387 69694			
35	2-8 Wood Market, Kelso, Borders, TD5 7AX	0573 24411			
36	27 Antrim Ave, Stranraer, Dumfries & Galloway	0776 3277			
37	8 Cumbie Way, Aycliffe Ind. Est. Newton Aycliffe	0325 300606			
38	Unit 1, Boulevard Unit Fact. Est. Hull, HU3 4AY	0482 223335			
39	Unit 2, Cromwell Road, Grimsby, DN31 2BN	0472 358760			
40	Unit 14 Stonefield Park, Clifton Street, Lincoln	0522 532330			



PEACE OF MIND FOR TWELVE MONTHS

Zanussi Standard Guarantee Conditions

This guarantee is in addition to your statutory and other legal rights which will not be excluded or in any way diminished by the return of this guarantee card.

We, Zanussi Ltd., undertake that if within twelve months of the date of the purchase this ZANUSSI appliance or any part thereof is proved to be defective by reason only of faulty workmanship or materials, we will, at our option repair or replace the same **FREE OF ANY CHARGE** for labour, materials or carriage on condition that:

- * The appliance has been correctly installed and used only on the electricity supply stated on the rating plate.
- * The appliance has been used for normal domestic purposes only, and in accordance with the manufacturer's operating and maintenance instructions.
- * The appliance has not been serviced, maintained, repaired, taken apart or tampered with by any person not authorised by us.
- * The appliance is still in the possession of the original purchaser.

All service work under this guarantee must be undertaken by a Zanussi Service Force Centre. Any appliance or defective part replaced shall become our property.

EXCLUSIONS

This guarantee does not cover:

- * Damage or calls resulting from transportation, improper use or neglect, the replacement of any light bulbs or removable parts of glass or plastic.
- * Costs incurred for calls to put right machines improperly installed or calls to machines outside the United Kingdom.
- * Appliances found to be in use within a commercial environment, plus those which are the subject of rental agreements.

* Products of Zanussi manufacture which are NOT marketed by Zanussi Ltd.

* EEC Countries - the standard guarantee is applicable but is subject to the owner's responsibility and cost to ensure the appliance meets the standards set by the country to which the product is taken. The Zanussi company in the country concerned will be pleased to advise further. Sight of your purchase receipt will be required by them.

... OR FIVE YEARS

ZANUSSI 5 YEAR

COVER CONDITIONS

For a once-only payment you can extend your Standard Guarantee to 5 years.

All the conditions and exclusions of the Standard Guarantee apply.

NOTES

1. Products supplied as "seconds", refurbished, damaged, or shop-soiled are not eligible for Zanussi 5 Year Cover.
2. The issue of a cover does NOT by virtue of our having done so, nullify the exclusions.
3. The Engineer will need to check the details of your Cover card and may make a charge for his services if it is not presented to him at the time of his call.
4. The date of purchase, or the date of initial payment (deposit) of the appliance will be deemed the date of commencement of cover.
5. Covers issued are not refundable or transferable.

GUARANTEE RECORD

Appliance purchased from..... on.....

Guarantee card no..... Model no.....

Serial no..... (These details may be taken from your Guarantee Record Card)

Your name.....

Address.....

.....

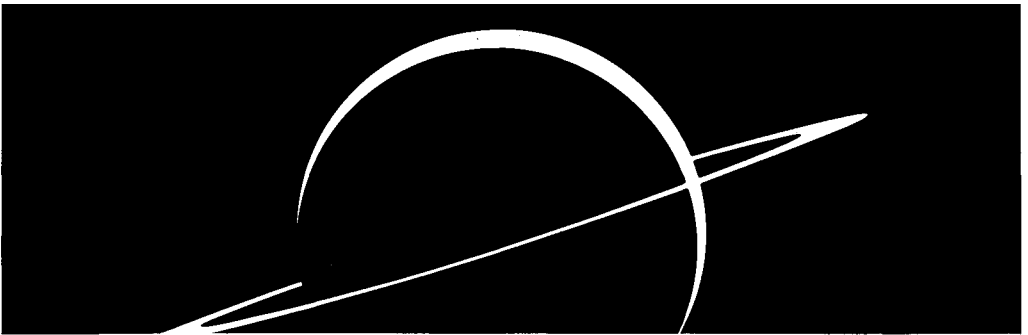

ZANUSSI

The appliance of science

The information in this manual is correct at time of going to press.
Zanussi reserve the right to alter specifications without notice.

Free Manuals Download Website

<http://myh66.com>

<http://usermanuals.us>

<http://www.somanuals.com>

<http://www.4manuals.cc>

<http://www.manual-lib.com>

<http://www.404manual.com>

<http://www.luxmanual.com>

<http://aubethermostatmanual.com>

Golf course search by state

<http://golfingnear.com>

Email search by domain

<http://emailbydomain.com>

Auto manuals search

<http://auto.somanuals.com>

TV manuals search

<http://tv.somanuals.com>