

ZANUSSI

ELECTRIC OVENS

BMF 849

BMS 841

INSTRUCTION BOOKLET

IL

Important Safety Information

These warnings are provided in the interest of safety. You **MUST** read them carefully before installing or using the appliance.

Installation

- It is mandatory that all operations required for the installation are carried out by a qualified or competent person, in accordance with existing rules and regulations.
- It is **dangerous** to alter the specification in any way.
- Once you removed all packaging from the appliance, ensure that it is not damaged and the electric cable is in perfect conditions. Otherwise, contact your dealer before proceeding with the installation.

Child Safety

- This appliance has been designed to be operated by adults and children under supervision. Young children **MUST NOT** be allowed to tamper with the controls or play near or with the oven.
- Accessible parts of this appliance may become hot when it is in use. Children should be **KEPT AWAY** until it has cooled.

During use

- This appliance has been designed for cooking edible foodstuff only and **MUST NOT** be used for any other purposes.
- Ensure that all control knobs are in the OFF position when not in use.
- Should you connect any electrical tool to a plug near this cooking appliance, ensure that electric cables are not in contact with it and keep them far enough from the heated parts of this appliance.
- If the appliance is out of order, disconnect it from the electric supply.
- Do not leave utensils containing foodstuffs, e. g. fat or oil in or on the appliance. This could cause damage in case the appliance is inadvertently switched on.
- Always place the dripping pan in position to collect fat when using the grill or when cooking meat. Pour a little water into the dripping pan to avoid smoke and unpleasant smells.
- Always use oven gloves to remove pans from the oven.
- For hygiene and safety reasons, this appliance should be kept clean at all times. A build-up of fats or other foodstuff could result in a fire.
- Disconnect the appliance from the electrical supply, before carrying out any cleaning or maintenance work.

- Some parts of the appliance are covered by a shock-proof plastic film. Remove this film before using the oven.
- This appliance is meant to operate with a single-phased connection to 230V electrical supply. An eventual 400V poliphasic connection without earth wire will destroy the oven and the hob, if fitted.
- **The manufacturer disclaims any responsibility should all the safety measures not be carried out.**

Service

- Under no circumstances should you attempt to repair the appliance yourself. Repairs carried out by unexperienced persons may cause injury or serious malfunctioning. Refer to your local Service Centre. Always insist on genuine spare parts.

Environmental Information

- After installation, please dispose of the packaging with due regard to safety and the environment.
- When disposing of an old appliance, make it unusable, by cutting off the cable.

It is most important that this instruction book is be retained with the appliance for future reference. Should the appliance be sold or transferred, always ensure that the book is left with the appliance in order that the new owner can get to know the functions of the appliance and the relevant warnings.

MANUFACTURER: ELECTROLUX ZANUSSI S.p.A.
Viale Bologna, 298
47100 FORLÌ (Italy)

Contents

For the User

Important Safety Information	2
Guide to Use the instructions	3
Description of the Oven	3
When the oven is first installed	5
Using the Oven	5
Electronic programmer	6
Using the oven	8
Cooking Tables	9
Cleaning and maintenance	11
Technical Assistance	13
Something not working...	13

For the Installer

Technical Data	14
Installation	14
Electrical connection	15

Guide to Use the instructions

The following symbols will be found in the text to guide you throughout the Instructions:



Safety Instructions



Step by step instructions for an operation



Hints and Tips



Environmental information

Description of the Oven

Push-Pull control knobs (BMF 849)

Some models are provided with push-pull control knobs (Fig. 1). These knobs can be completely sunken inside the control panel when the oven is not working.

The Safety Thermostat

This oven is provided with a safety thermostat. In case of malfunctioning of the main thermostat, and consequent over-heating, the safety device will stop the power supply to the appliance. If this happens, call your local Zanussi Service Centre. Under no circumstances should you attempt to repair the appliance yourself.

The Cooling Fan for the Controls

This oven is provided with a cooling fan, meant to keep the front panel, the knobs and the oven door handle cool. This fan may run on after the oven or grill is switched off, until a normal temperature is reached.

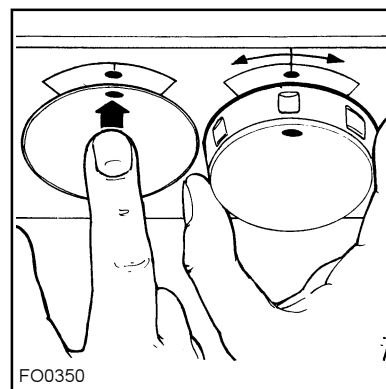



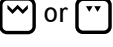

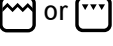

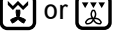





Fig. 1

FO0350

Oven function control knob (Fig. 2)

The oven function control knob can have the following symbols and functions:

-  Oven Light - The oven light will be on without any cooking function
-  Conventional cooking - The heat comes from both the top and bottom element, ensuring even heating inside the oven.
-  Top heating element - The heat comes from the top of the oven only.
-  Bottom heating element - The heat comes from the bottom of the oven only.
-  or  Inner grill element only - can be used for grilling small quantities.
-  or  Double Grill - The full grill element will be on.
-  or  Thermal Grilling - This function offers an alternative method of cooking food items, normally associated with conventional grilling. The grill element and the oven fan operate together, circulating hot air around the food. **When using this function, select a maximum temperature of 200°C and do not exceed 1 hour of operation.**
-  -  Fan cooking - This allows you to roast or roast and bake simultaneously using any shelf, without flavour transference.
-  Defrost Setting - This setting is intended to assist in thawing of frozen food.

Thermostat control knob (Fig. 3)

Turn the thermostat control knob to select temperatures between 50°C and 250°C (MAX).

Thermostat control light (°C)

Once the oven temperature has been selected, the temperature light will come on and remain on until the oven has reached the correct setting; after that, it will go on and off with the thermostat, showing how the temperature is being maintained.

Oven control light

It will come on every time an heating element is set on operation.

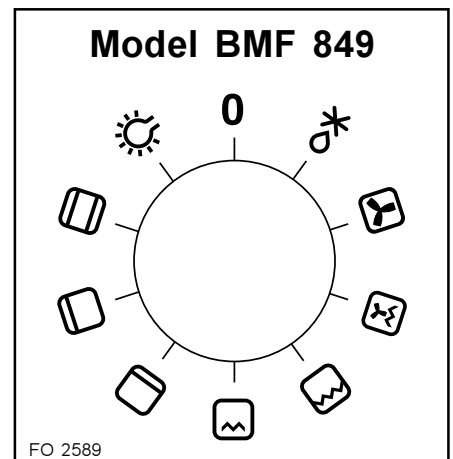

FO 2589

Fig. 2

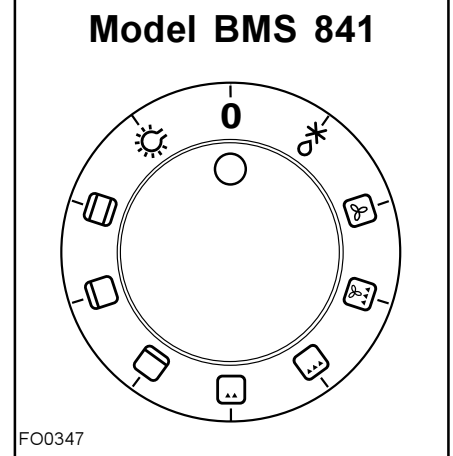

FO0347

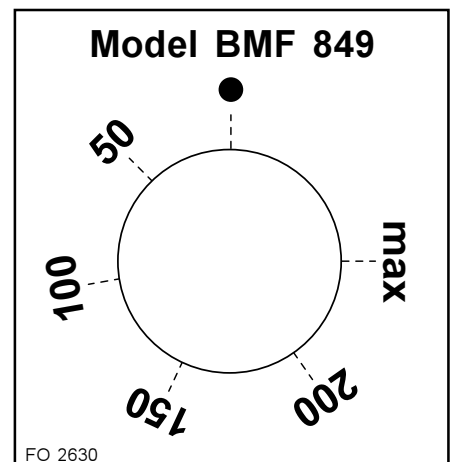

FO 2630

Fig. 3

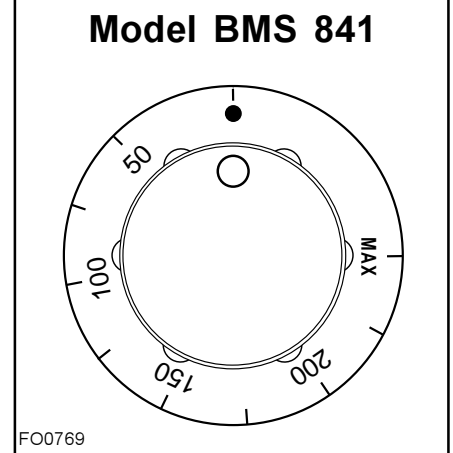

FO0769

When the oven is first installed

i Before cooking for the first time, carefully wash the oven accessories.

i The oven will work only if the time of day has been set with the electronic programmer.

Once the oven has been installed:

- set the thermostat knob to MAX (250);
- switch the oven function control knob to conventional cooking (☐);
- allow the oven to run empty for approximately 45 minutes;
- open a window for ventilation.

During this time, an unpleasant odour may be emitted. This is absolutely **normal**, and is caused by residues of manufacturing.

Repeat this operation for the grill and fan cooking function. Once this operation is carried out, let the oven cool down, then clean the oven cavity with a soft cloth soaked in warm soapy water.

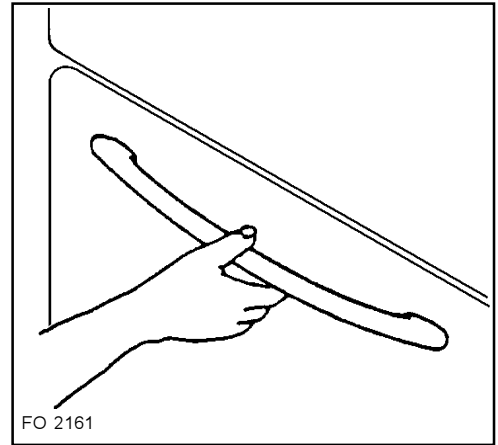

Fig. 4



To open the oven door, always catch the handle in its central part (Fig. 4).

Using the Oven



Always cook with the oven door closed.

- Stand clear when opening the drop down oven door. Do not allow it to fall open - support the door using the door handle, until it is fully open.
- The oven has four shelf levels. The shelf positions are counted from the bottom of the oven as shown in the diagram.
- Do not place cookware directly on the oven base.

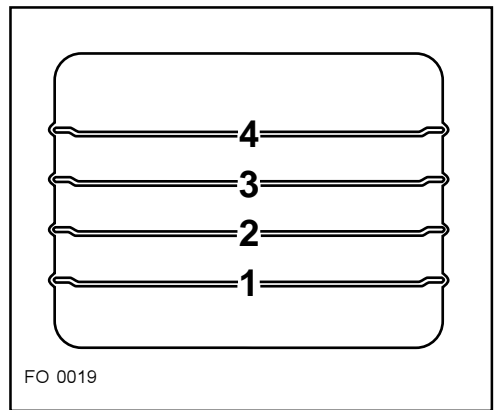

Fig. 5

Condensation and steam

When food is heated it produces steam in the same way as a boiling kettle. The oven vents allow some of this steam to escape. However, **always stand back from the oven when opening the oven door** to allow any build up of steam or heat to release.

If the steam comes into contact with a cool surface on the outside of the oven, e.g. a trim, it will condense and produce water droplets. This is quite normal and is not a fault with the oven. To prevent discoloration, regularly wipe away condensation and also soilage from surfaces.

Telescopic shelf supports (fig. 6)

- Mod. BMF 849:** Shelf level 2 is fitted with telescopic shelf supports.
- Mod. BMS 841:** Shelf levels 2 and 4 are fitted with telescopic shelf supports.

- Pull the right and left hand telescopic shelf supports completely out, as shown in the diagram.
- Place the shelf or the grill pan on the telescopic shelf supports, as shown in the diagram, then gently push them all inside the oven.



Do not attempt to close the oven door if the telescopic shelf supports are not completely inside the oven. This could damage the door enamel and glass.

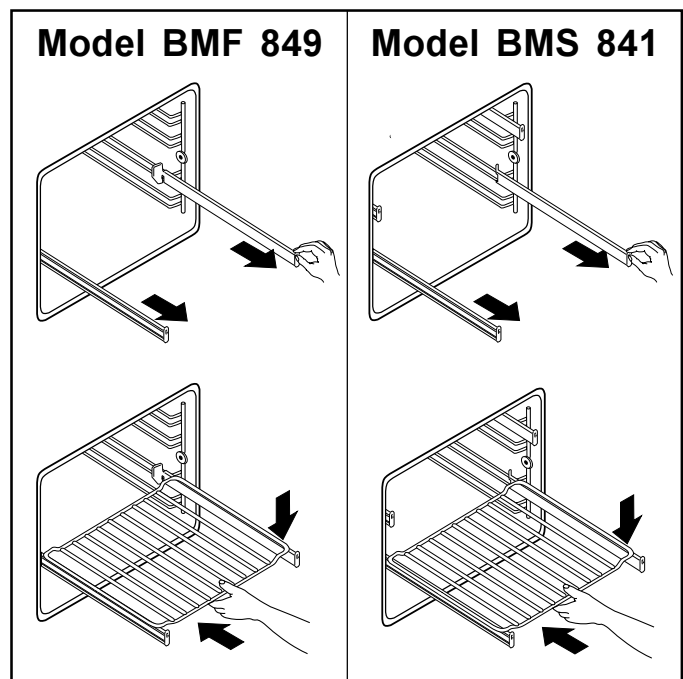

Fig. 6

Electronic programmer

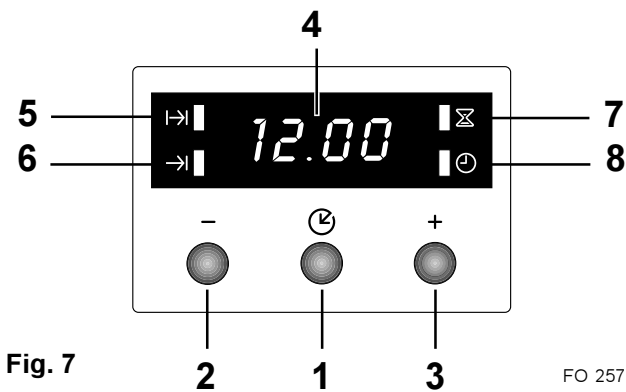

Fig. 7

FO 2571

1. Push button for selecting a function
2. Decreasing control button “-”
3. Increasing control button “+”
4. Display
5. “Cooking Duration” pilot lamp
6. “End of cooking” pilot lamp
7. “Minute minder” pilot lamp
8. “Time of day” pilot lamp

The oven will work only if the time of day has been set. Moreover, the oven can also be operated without any programme.

Setting the time of day

When the power supply is switched on, or after a power failure, the “Time of day” pilot lamp will flash on the display.

To set the correct time of day:

1. press button “+” or “-”.
2. After the setting is carried out, wait for 5 seconds: the “Time of day” pilot lamp will go out and the display will show the set time. The appliance is ready for use.

To reset the correct time of day:

1. press button repeatedly to select the “Time of day” function. The relevant pilot lamp will start flashing. Then proceed as described above.
The time of day may be reset only if no automatic function (cook duration or end of cooking) has been set.

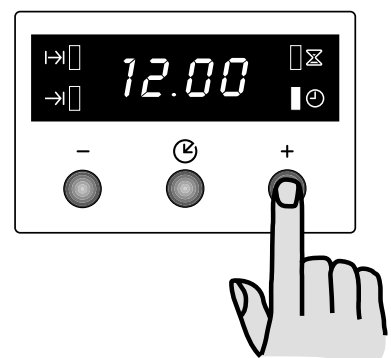

“Cooking Duration” function

Thanks to this function, the oven will automatically switch off at the end of a programmed cooking duration time. Place food in the oven, select a cooking function and adjust the cooking temperature. Press button repeatedly to select the “Cooking Duration” function. The relevant pilot lamp will start flashing. Then, proceed as follows:

To set the duration time:

1. press button “+” or “-”.
2. After the setting is carried out, wait for 5 seconds: the “Cooking Duration” pilot lamp will come on and the display will revert to the time of day.
3. When cooking time is over, the oven will be switched off automatically and an acoustic alarm will be heard, while the pilot lamp will start flashing. Turn the oven function and the thermostat control knob to zero.

To switch off the acoustic alarm, press any button. **NOTE:** when doing this operation, the oven will be operated again, therefore, remember to turn the oven function and the thermostat control knob to zero at the end of the cooking time.

To cancel the duration time:

1. Press button repeatedly to select the “Cooking Duration” function. The relevant pilot lamp will flash and the display will show the remaining cooking time.
2. Press button “-” until the display shows “0:00”. After 5 seconds the pilot lamp will go out and the display will revert to the time of day.

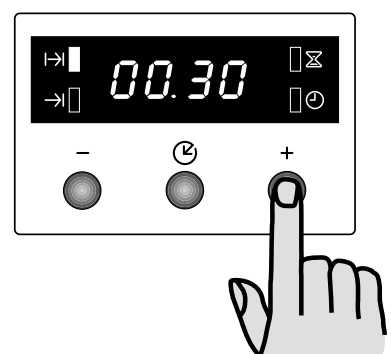
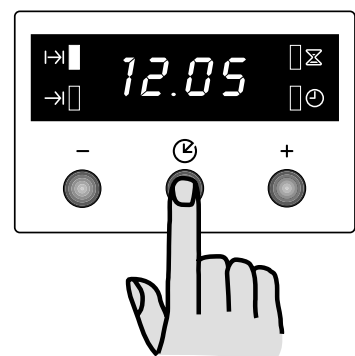

“End of cooking” function →|

Thanks to this function, you can set the oven to switch off automatically when a programmed end of cooking time is over. Place food in the oven, select a cooking function and adjust the cooking temperature. Press button  repeatedly to select the “End of cooking” function. The relevant pilot lamp →| will start flashing. Then, proceed as follows:

To set the End of cooking time:

1. press button “+” or “-”.
2. After the setting is carried out, wait for 5 seconds: the “End of cooking” pilot lamp |→| will come on and the display will revert to the time of day.
3. When cooking time is over, the oven will be switched off automatically and an acoustic alarm will be heard, while the pilot lamp will start flashing. Turn the oven function and the thermostat control knob to zero.

To switch off the acoustic alarm, press any button. **NOTE:** when doing this operation, the oven will be operated again, therefore, remember to turn the oven function and the thermostat control knob to zero when cooking is over.

To cancel the End of cooking time:

1. Press button  repeatedly to select the “End of cooking” function. The relevant pilot lamp →| will flash and the display will show the programmed End of cooking time.
2. Press button “-” until the display shows the current time of day. The programmer will beep and the pilot lamp will go out.

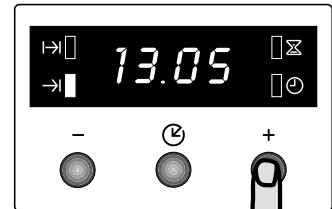
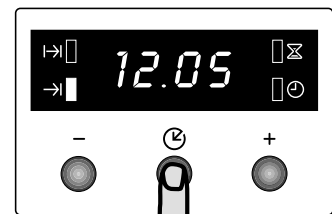

“Cooking duration” |→| and “End of cooking time” →| combined

The functions “Cooking duration” e “End of cooking time” can be used simultaneously to set the oven to switch on and off automatically at a later time.

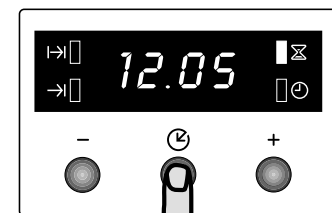

1. With the “Cooking duration” function |→| (carry out the cooking duration setting as described in the relevant chapter) set the duration time. Then, press button : the display will show the programmed setting.
2. With the “End of cooking time” function →| (carry out the End of cooking setting as described in the relevant chapter) set the end of cooking time. The relevant pilot lamps will come on and the display will show the time of day. The oven will switch on and off according to the set programmes.





“Minute minder” function

The minute minder alarm will sound at the end of a timed period, but THE OVEN WILL REMAIN ON, if it is in use.

To set the minute minder:

1. Press button  repeatedly to select the “Minute minder” function. The relevant pilot lamp  will start flashing.
2. Then, press button “+” or “-” (maximum: 2 hours, 30 minutes).
3. After the setting is carried out, wait for 5 seconds: the “Minute minder” pilot lamp  will come on.
4. At the end of the timed period, the pilot lamp will start flashing and acoustic alarm will be heard. To switch off the acoustic alarm, press any button.

To cancel the minute minder:

1. Press button  repeatedly to select the “Minute minder” function. The relevant pilot lamp  will flash and the display will show the remaining time.
2. Press button “-” until the display shows “0:00”. After 5 seconds the pilot lamp will go out and the display will revert to the time of day.

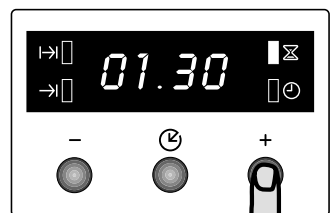

How to switch off the display

1. Press two or three programmer push buttons simultaneously and keep them pressed for about 5 seconds. The display will switch off.
2. To switch on the display, press any button.

The display can be switched off only if no other functions have been set.

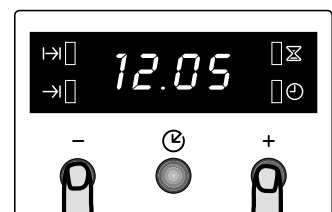



Using the oven



 **Always cook with the oven door closed**

Conventional cooking

Turn the oven function control knob to the relevant symbol () and set the thermostat knob on the required temperature.

If you need more heat from the top or the bottom of the oven, turn the oven function control knob to  (top heating element only) or  (bottom heating element only).

Fan cooking

Turn the oven function control knob to the relevant symbol ( - ) and set the thermostat knob on the required temperature. The fan behind the back panel circulates heated air into the oven.

If you need to cook more than one dish in the fan oven at the same time, place the shelves on the first and third position from the bottom (fig.8). If you are cooking only one dish in the fan oven, use the lower positions, as this will give you better results.



Grilling

Turn the oven function control knob to the relevant symbol and set the thermostat knob on the required temperature. When using the double grill function, you will obtain even heating on the whole surface of the dish.

When grilling meat or fish, spread a little oil on them and always place them on the oven grid. The shelf level depends on the thickness of the food.

Always place the dripping pan at the lowest level, with some water in it, to avoid smoke and unpleasant smells.

Thermal grilling

Turn the oven function control knob to the relevant symbol ( - ) and set the thermostat knob on the required temperature. **When using this cooking function, select a maximum temperature of 200°C and do not exceed 1 hour of operation.**

The full grill element and the oven fan operate alternately, circulating hot air around the food. The need to check and turn food is reduced. With the exception of toast and rare steaks, you can thermal grill all the foods you would normally cook under a conventional grill.

Defrosting

Turn the oven function control knob to the relevant symbol () and set the thermostat knob on the OFF position (symbol : ●). The oven fan operates without heat and circulates the air, at room temperature, inside the oven.

- The temperatures inside the oven can reach 250°C. Always ensure that you are using oven proof baking trays, oven dishes, etc.

- Do not place pans, biscuit pans or aluminium foil directly on the base of the oven. This could cause a heat build-up which could affect the performance of the oven and damage the oven enamel.
- Carefully supervise cookings with **fats or oil**, since these types of foodstuff can result in a fire, if overheated. For the same reason, be careful when placing or removing food in the oven, not to let any fat or oil fall on the oven base. If this happens, carefully clean the oven to avoid unpleasant smells or smoke.

Hints and Tips on Cooking Fish and Meat

You can place meat in oven proof dishes, or directly on the oven shelf. In this case, remember to place the dripping pan in the first position from the bottom with some water in it. The dripping pan will avoid the falling of melted fat on the oven base.

White meat, poultry and fish in general, need a medium temperature cooking (between 150 and 175 °C). If you need to cook red meat (slightly browned on the outside and more gently cooked in the inside), a higher temperature (between 200 and 250 °C) for a short time is recommended.

Hints and Tips on baking

Cakes usually need a medium temperature cooking, between 150 and 200 °C.

A short oven pre-heating (about 10 minutes) is recommended when cooking cakes or baking. Once the cooking has been started, keep the oven door closed during all the cooking time, and check the cooking results through the oven door glass.

Hints and Tips on grilling

If you need to grill meat or fish, place them directly on the shelf after spreading a little oil on them. In the grill function, heat comes only from the top element. Therefore, you need to adjust the cooking level depending on meat or fish's thickness. Always remember to place the dripping pan in the lower position with some water in it.

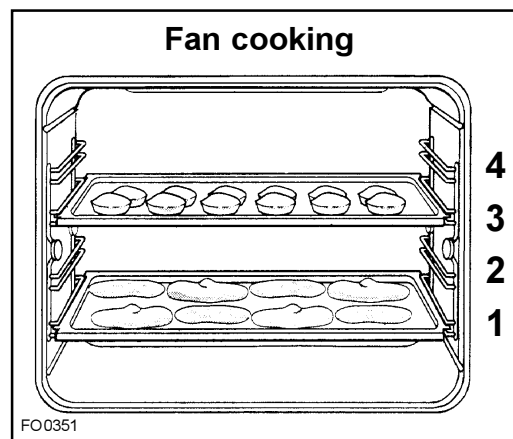







Fig. 8 FO0351

Cooking Tables

Conventional and fan cooking

WEIGHT (GR.)	TYPE OF DISH	Conventional Cooking 		Fan Oven  - 		Cooking time  minutes	NOTES
		Level 	temp. °C	Level 	temp. °C		
	Cakes						
	Whipped up kneading	2	180	2 (1 and 3)*	160	45 ~ 60	
	Leavened kneading	2	180	2 (1 and 3)*	160	20 ~ 35	
	Shortbread dough	2	180	2 (1 and 3)*	160	20 ~ 30	
	Butter-milk cheese cake	1	175	2	150	60 ~ 80	
	Apple cake	1	180	2 (1 and 3)*	160	40 ~ 60	
	Strudel	2	175	2 (1 and 3)*	150	60 ~ 80	
	Jam-tart	2	180	2 (1 and 3)*	160	45 ~ 60	
	Small cakes	2	180	2 (1 and 3)*	160	15 ~ 25	
	Biscuits	2	180	2 (1 and 3)*	160	10 ~ 20	
	Meringues	2	100	2 (1 and 3)*	100	90 ~ 120	
	Bread and Pizza						
1000	White bread	1	200	2	175	45 ~ 60	1 piece
500	Rye bread	2	200	2	175	30 ~ 45	In bread pan
500	Bread rolls	2	200	2 (1 and 3)*	175	20 ~ 35	8 rolls
250	Pizza	1	220	2 (1 and 3)*	200	20 ~ 35	In baking pan
	Flans						
	Pasta flan	2	200	2 (1 and 3)*	175	40 ~ 50	
	Vegetable flan	2	200	2 (1 and 3)*	175	45 ~ 60	
	Quiches	2	200	2 (1 and 3)*	175	35 ~ 45	
	Lasagne	2	200	2	175	45 ~ 60	
	Meat						
1000	Beef	2	200	2	175	50 ~ 70	On grid
1200	Pork	2	200	2	175	100 ~ 130	On grid
1000	Veal	2	200	2	175	90 ~ 120	On grid
1500	English roast beef	2	220	2	200	50 ~ 70	On grid
1200	Lamb	2	200	2	175	110 ~ 130	Leg
1000	Chicken	2	200	2	175	60 ~ 80	Whole
4000	Turkey	2	200	2	175	210 ~ 240	Whole
1500	Duck	2	175	2	160	120 ~ 150	Whole
3000	Goose	2	175	2	160	150 ~ 200	Whole
1200	Hare	2	200	2	175	60 ~ 80	Cut in pieces
	Fish						
1000	Whole	2	200	2 (1 and 3)*	175	40 ~ 60	2 fishes
800	Fillets	2	200	2 (1 and 3)*	175	30 ~ 40	4 fillets

NOTE:

Cooking times do not include pre-heating time. We recommend a short oven pre-heating (about 10 minutes) before baking or cooking pizza.

(*) If you need to cook more than one dish at the same time, we recommend you to place them on the levels quoted between brackets.

The times given in the table are intended as a guide only. Only experience will enable you to determine the correct setting to suit your personal requirements.

Cooking Tables

Grilling

TYPE OF DISH	Quantity		Grilling		Cooking time (minutes) ⌚	
	PIECES	WEIGHT	Level 	temp. °C	Upper side	Lower side
Steaks	4	800	4	max	10	8
Chops	4	600	4	max	12	8
Sausages	8	500	4	max	10	6
Chicken (cut in pieces)	6	800	3	max	30	20
Kebabs	4	700	4	max	12	10
Chicken (breast)	4	400	4	max	13	10
Tomatoes	8	500	4	max	12	—
Fish (fillets)	4	400	4	max	8	6
Sandwiches	4	—	4	max	8	—
Toast	4	—	4	max	2~3	1

Thermal grilling

Type of dish	Quantity (gr.)	Shelf level from the bottom	Temperature °C	Time in minutes	
				lower side	upper side
Pork	1500	2 or 3	170	45	30
Roastbeef	1500	3	200	30	20
Chicken	1200	2 or 3	190	40	30
Kebabs	800	3	200	15	10
Fish (whole)	800	3	200	12	8



When using the Thermal grill function, select a maximum temperature of 200°C and do not exceed 1 hour of operation.

Grease Filter

When cooking meat, the grease filter must be fitted over the oven fan by clipping it over the vents in the back panel. This will prevent a built-up of fat on the fan impellor. Do not use abrasive materials to clean the seal. The grease filter is dishwasher proof.

When cooking is completed and the oven has cooled down, remove the filter by pushing the protruding tongue on the filter upward. (See Fig. 9) Wash the filter after use using warm soapy water.

Fit the grease filter only when roasting.

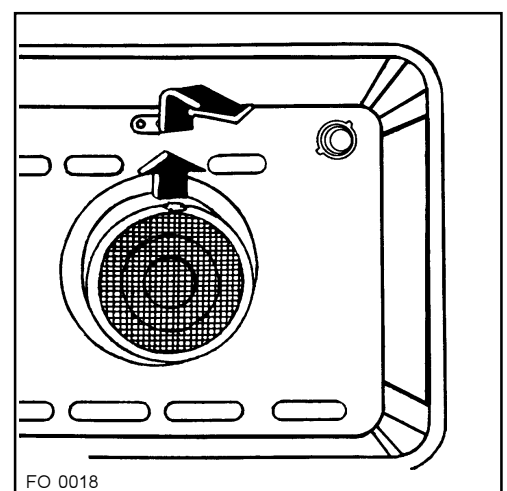



Fig. 9 FO 0018

Cleaning and maintenance

General Cleaning

 Before carrying out any cleaning or maintenance work, always disconnect the appliance from the electrical supply, and allow it to cool down.

- When using **spray** cleaning products, be careful not to spread them on the heating elements or on the thermostat sensor.
- Never use harsh **abrasives**, steel wool or cleaners with **bleach**, as they could damage the enamel and the oven door glass.

The Oven Cavity

The enamelled oven cavity is best cleaned whilst the oven is still warm. It is advisable to wipe the oven over with a soft cloth soaked in warm soapy water after each use. However, from time to time, it will be necessary to do a more complete cleaning, using a proper oven cleaner. In case of particularly tough stains, you can use stainless steel cleaning products or some warm vinegar.

 If cooking fruits, some over-heated natural acids can squeeze and settle on the oven enamel, causing stains quite difficult to remove. This could affect the enamel brightness, but it will have no consequence on the oven performances. To avoid these stains to be burnt out during the next cooking, carefully clean the oven cavity after all fruits cookings.

The Oven Door and its gasket

Before cleaning the oven door, we recommend you to remove it from the oven.

 Proceed as follows:

- a) open the oven door completely;
- b) find the hinges linking the door to the oven (fig. 10);
- c) unlock and turn the small levers located on the two hinges (fig. 10);
- d) handle the door by its left- and right-hand sides, then slowly turn it towards the oven until it is half-closed;
- e) gently pull the oven door off its site (fig. 10);
- f) place it on a steady plan.

Clean the oven door glass with warm water and a soft cloth only.

Once the cleaning is carried out, refit the oven door, following the procedure in reverse.

The correct operation of the oven is ensured by a gasket placed round the edge of the oven cavity.

- Periodically **check** the condition of this gasket. If necessary, clean it without using abrasive cleaning products.
- If the gasket shows to be **damaged**, call you local Service Centre. Do not use the oven until it has been repaired.

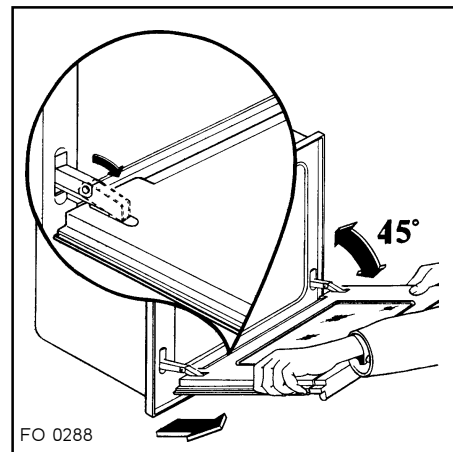



Fig. 10 FO 0288

Replacing the Oven Light

 Ensure the electricity supply is switched off before carrying out this operation.

The oven bulb has to comply to these features:

- resistant to temperatures of 300 °C;
- electric rate: 230 V - 50 Hz;
- electric power rate: 25 W;
- connection type: E 14.

To replace the bulb, proceed as follows (Fig. 11):

- push in and turn the glass lid anticlockwise;
- remove the faulty bulb;
- replace it with a new one;
- refit the glass lid;
- switch on the electricity supply.

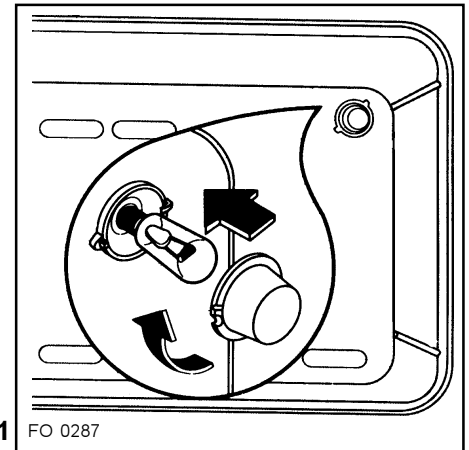



Fig. 11 FO 0287

The Hinged Grill

Some models are fitted with a hinged grill element, to enable you to clean the roof of the oven easily.

 Before proceeding ensure the oven is cool and is isolated from the electricity supply.

- Undo the screws which hold the grill in place (see Fig. 12). When doing this operation for the first time, we recommend using a screwdriver.
- Then gently pull the grill downward to allow access to the oven roof.
- Clean the oven roof with a suitable cleaner and wipe dry before replacing the hinged grill element.
- Gently push up the grill element into place and firmly screw into place the holding nuts.

 Ensure the grill holding nuts are firmly in place to avoid the grill falling down when in use.

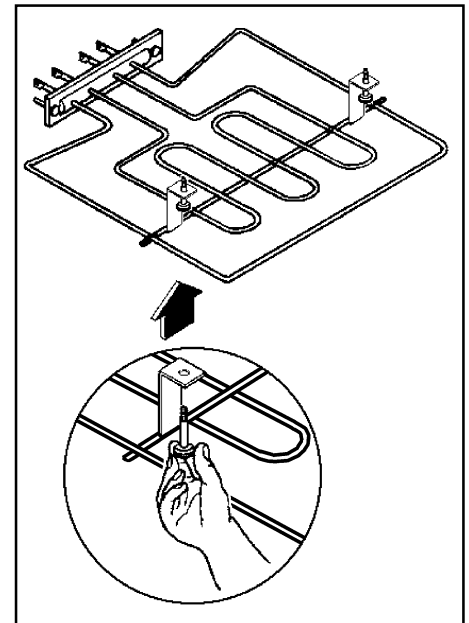



Fig. 12

Oven Shelves and Shelf Supports

To clean the oven shelves, soak in warm soapy water and remove stubborn marks with a well wetted soap impregnated pad. Rinse well and dry with a soft cloth.

The shelf supports can be removed for easy cleaning (Fig. 13). Please, ensure the retaining nuts are secure when refitting the shelf support.

 When cleaning the shelf supports, take care not to remove the lubricating grease behind the telescopic runners. This is meant to ensure their good operation.

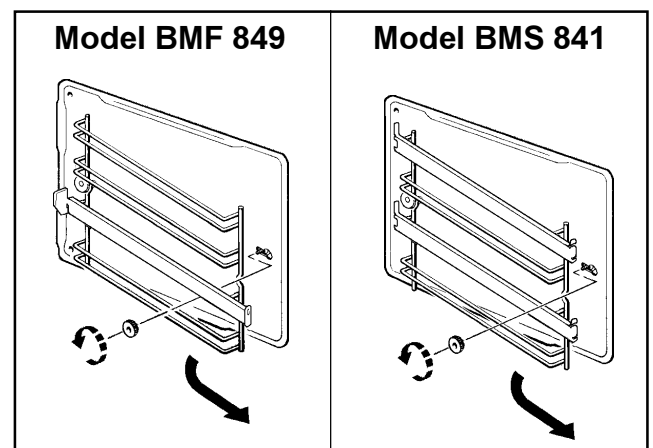

Fig. 13

Something not working...

If the appliance is not working correctly, please carry out the following checks, before contacting your local Service Centre.

SYMPTOM	SOLUTION
<ul style="list-style-type: none"> ■ The oven does not come on 	<ul style="list-style-type: none"> ◆ Check that both a cooking function and a temperature have been selected <i>or</i> ◆ Check the appliance is wired in properly, and the socket switch or the switch from the mains supply to the oven are ON.
<ul style="list-style-type: none"> ■ The oven temperature light does not come on 	<ul style="list-style-type: none"> ◆ Turn the thermostat knob on a temperature <i>or</i> ◆ Turn the oven function control knob on a function.
<ul style="list-style-type: none"> ■ The oven light does not come on 	<ul style="list-style-type: none"> ◆ Turn the oven function control knob on a function <i>or</i> ◆ Buy a new oven light bulb, asking for it to your local Service Centre and replace it by following the instruction provided in this booklet.
<ul style="list-style-type: none"> ■ It takes too much time to finish the dishes, or they are cooked too fast. 	<ul style="list-style-type: none"> ◆ Refer to the contents of this booklet, especially to the chapter "Using the oven".
<ul style="list-style-type: none"> ■ Steam and condensation settle on the food and the oven cavity. 	<ul style="list-style-type: none"> ◆ Leave dishes inside the oven no longer than 15-20 minutes after the cooking is completed.

Technical Assistance

If after the checks listed in the previous chapter, the appliance still does not work correctly, contact your local Service Centre, specifying the type of malfunctioning, the appliance model (Mod.), the product number (Prod. No.) and the serial number (Ser. No.) marked on the identification plate.

This plate is placed on the front external edge of the oven cavity.

Original spareparts, certified by the product manufacturer and carrying this symbol are only available at our Service Centre and authorized spareparts shops.

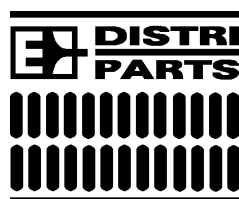
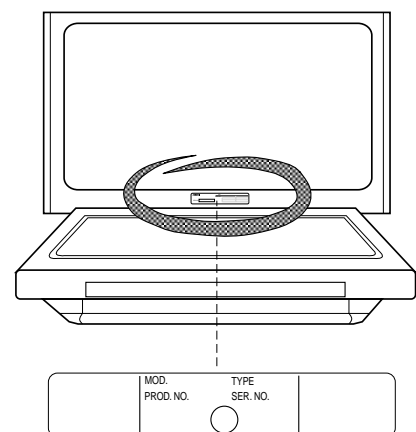

Technical Data

Recess dimensions

Height	in-column	58,0 cm
	undertop	59,1 cm
Width		56,0 cm
Depth		55,0 cm

Oven cavity dimensions

Height	32,5 cm
Width	42,0 cm
Depth	39,0 cm
Volume	53 l

Heating elements ratings

Bottom heating element	1000 W
Top heating element	800 W
Full Oven (Top+Bottom) (1000 + 800)	1800 W
Simple Grill heating element	1750 W
Double Grill heating element	2550 W
Oven rear heating element	2000 W
Convection fan	30 W
Cooling fan	25 W
Oven lamp	25 W
Voltage tension (50 Hz)	230 V
Maximum power rating (230V - 50Hz)	2600 W

Installation

The following instructions are meant to a qualified technician, in order to allow him carry out the installation in compliance with the rules in force. The building-in and the electrical connection fo the appliance must be carried out by a qualified and authorized technician only.

Building In

It is important that the dimensions and materials of the surround or cabinet into which the oven will be built are correct and will withstand a temperature increase.

A correct installation will have to ensure a proper protection against contact with electric parts or merely functionally isolated parts.

All the units meant to ensure protection have to be fitted not to be taken away without using any tool.

We recommed not to install the appliance near refrigerators or freezer, since the heat could affect the performance of these appliances.

Oven dimensions

The oven dimensions are shown in fig. 14.

In-Column recess dimensions

The recess must have the dimensions shown in Fig. 15.

Undertop recess dimensions

The recess must have the dimensions shown in Fig. 16.

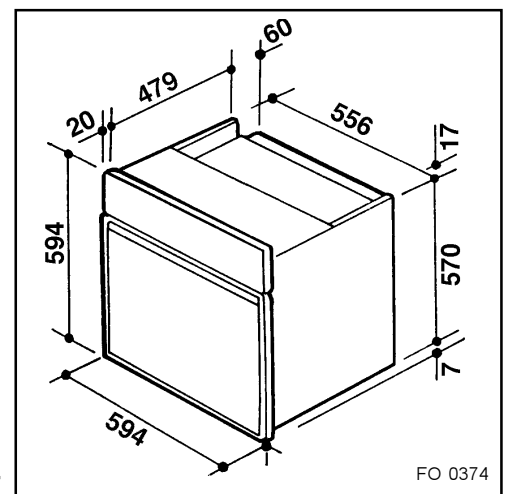

Fig. 14

FO 0374

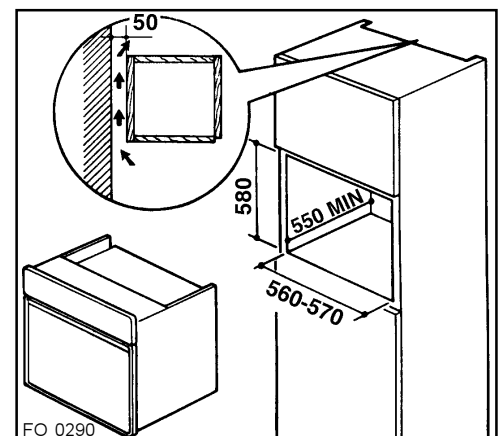

Fig. 15

FO 0290

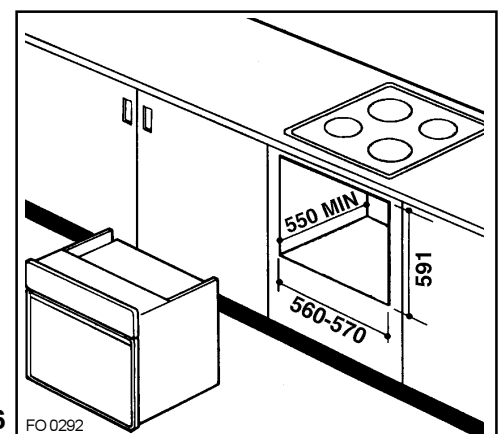

Fig. 16

FO 0292

Securing the oven to the cabinet

- Fit the appliance into the cabinet recess.
- Open the oven door and secure the oven to the kitchen cabinet with four wood screws, which fit the holes provided in the oven frame (Fig.17).

When installing an electric plate hob over the oven, the hob's electrical connection and the oven's one have to be carried out separately, for security reasons and to let the oven be taken off the unit easier, if necessary.

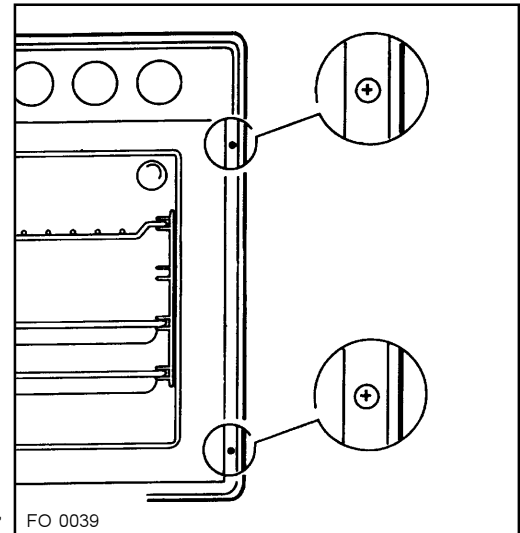

Fig. 17 FO 0039

Electrical connection

Before the appliance is connected:

- 1) check that the main fuse and the domestic installation can support the load;
- 2) check that the power supply is properly earthed in compliance with the current rules;
- 3) check the socket or the double pole switch used for the electrical connection can be easily reached with the appliance built in the furniture unit.

This appliance is supplied without connection cable. A suitable one must be fitted, in compliance with the electric supply rate. Only the following cable types must be used: H07 RN-F, H05 RN-F, H05 RR-F, H05 VV-F, H05 V2V2-F (T90), H05 BB-F (section 3x 1,5 mm²). A suitable plug, able to carry the load specified on the rating plate, must be fitted to the cable. The plug has to be fitted in a proper socket.

If connecting the appliance directly to the electric system, a double pole switch must be installed between the appliance and the electricity supply, with a minimum gap of 3 mm. between the switch contacts and of a type suitable for the required load in compliance with the current rules. The earth wire must not be interrupted by the double switch pole.

The connection cable has to be placed in order that, in each part, it cannot reach a temperature 50 °C higher than the room temperature.

After the connection is carried out, test the heating elements for about 3 minutes.

Terminal block

The oven has an easily accessible terminal block, which is meant to work with an electric single-phase rate of 230 V (Fig. 18).

The manufacturer disclaims any responsibility should all the safety measures not be carried out.

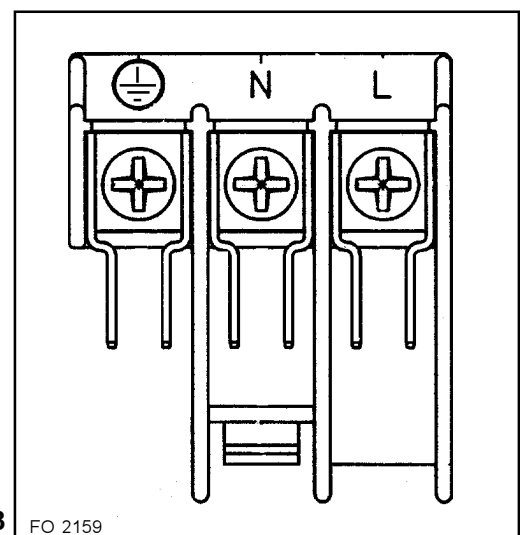

Fig. 18 FO 2159

Free Manuals Download Website

<http://myh66.com>

<http://usermanuals.us>

<http://www.somanuals.com>

<http://www.4manuals.cc>

<http://www.manual-lib.com>

<http://www.404manual.com>

<http://www.luxmanual.com>

<http://aubethermostatmanual.com>

Golf course search by state

<http://golfingnear.com>

Email search by domain

<http://emailbydomain.com>

Auto manuals search

<http://auto.somanuals.com>

TV manuals search

<http://tv.somanuals.com>