

OPERATING INSTRUCTIONS

ZANUSSI

BUILT - IN
DOUBLE CAVITY
GAS OVEN
MODEL
ZDG 862

Introduction

This gas oven has been designed and manufactured to all the necessary British Standards. It also carries the C.E. mark. The cooker complies with European Council Directive 90/396/EEC.

It is important that you understand how to use and care for the oven properly before you use it for the first time.

We have written this booklet with your safety in mind. Read the booklet thoroughly before you use the oven. Keep the booklet in a safe place so that anyone who uses the oven can read it. Pass the booklet on with the oven if you give or sell it to someone else.

For your safety

This oven is designed for domestic use to cook food. You must not use it for any other purpose. It is not designed for commercial use.

Keep children, babies and toddlers away from the oven at all times.

The installation instructions that came with the oven tell you how and where it can be fitted. If the oven is already installed you must make sure that all instructions have been followed. If you are in any doubt ask a registered person. More details on installation on page 4.

We have included several drawings to show the right and wrong way of doing things.

The right way will have a smiling face by it.



A sad face shows something is wrong.



Do not remove the rating plate from the cookers as this may invalidate the guarantee.

Contents	Page
Installing the oven	4
General information	5
The cooling fan for the controls	5
Ignition	6
Oven light	6
Lighting the oven and grill	7
The grill	9
The grill pan and handle	12
The oven	14
Baking trays and dishes	16
Oven cooking charts	17
Slow cooking	20
The electronic timer	23
Hints and tips for automatic cooking	26
Care and cleaning	27
What is wrong and why?	31
Replacing an oven light bulb	33
Service and spare parts	34
Tecnical details	36
Safety requirements/ventillation	37
Location of appliance	38
Installation	39
Pressure testing	44
Guarantee conditions	46

Installing the oven

For your safety

This oven must be installed and serviced by a competent person as stated in the Gas Safety (Installation & Use) (Amendment) regulations current edition.

It is important that the oven is suitable for your gas supply. Your installer should check the data badge.

Cabinet Dimensions

This oven must be fitted into a cabinet with a suitable sized aperture.

Minimum aperture height 874mm

Minimum aperture width 560mm

Minimum aperture depth 560mm

For more details on suitable cabinet sizes refer to the Installation and Servicing Instructions supplied with your oven.

Location

For your safety

All gas ovens require adequate ventilation. The room the oven is fitted in must have a good air supply that meets the standard BS 5440 Part 2 (current edition). Your installer will tell you if you are not sure.

The oven may be placed in a kitchen, kitchen/diner or bedsit but not in a bathroom or shower room. It should not be installed in a bedsit smaller than 20m³. (Ask your installer).

General information

To get the best results from your new oven please read these instructions carefully.

You should pay particular attention to cooking times and gas mark settings as these may differ from your previous oven. You may find it necessary to adjust these until you are more familiar with the oven.

For your safety

Do not block any of the oven vents.

Never line any part of the oven with aluminium foil.

Do not let items which can catch fire or electric mains leads such as kettle flexes trail over any part of the oven.

Oven housing units vary widely in construction and finish. To avoid possible damage to the housing unit, you must not leave cabinet doors or flaps above the oven open or partially open when you use the grill or oven. If you have a storage area above your oven it will become warm when you use the oven. Do not store perishable foods in the storage area above the oven.

The cooling fan for the controls

Your oven has a cooling fan. The cooling fan will start to work as soon as you light the grill or oven. You will be able to hear the fan when it is working.

The cooling fan may continue to work after you have turned off the oven or grill. It will switch itself on and off until the oven has cooled down.

If you want to turn off the electrical supply to the oven, you should not do so until the cooling fan has stopped working.

For your safety

When you are using the grill or oven warm air will exhaust from the grill cavity and the vents below the control panel.

Take care not to stand too close to the oven or grill while in use.

Ignition

The grill and oven burners light automatically when you turn on the control. If, for any reason either of the burners go out, the spark ignition will automatically relight it.

Please note:

You can only use the grill with the door fully or partially open. You cannot use the grill when the door is closed.

You cannot use the oven or grill in the event of a power failure.

Oven light

The oven light will come on when you use the oven.

The oven light bulb will usually last for many months. If the light does not work, you probably need to replace the bulb. See page 33 for details on how to change the oven light bulb.

Connecting to the electricity supply

For your safety

This cooker must be earthed and protected by a 3 amp fuse.

The plug supplied with the oven can be fitted directly to a suitable three pin earthed socket.

If you have to change the fuse replace it with a 3 amp fuse which has been ASTA approved to BS 1362.

Do not use the plug until you have put the fuse cover back on. If the fuse cover is lost you can get a replacement from an electrical retailer. The correct replacement can be identified by marking or colour coding.

If you cut the plug off dispose of it safely as it will be a shock hazard if it is inserted into a 13 amp socket elsewhere in the house.

If the ignition system doesn't work there may be a fault with the electrical supply. First, check the socket by trying out another piece of electrical equipment in it, if that works correctly renew the fuse in the plug.

If the fuse keeps failing there is a fault in the oven which must be put right. Do not use a fuse with a rating higher than 3 amps. Do not carry out other electrical work. Unplug the oven and tell your installer.

Lighting the oven and grill

Grill

To light:

- 1 Open the grill door. Push in the control knob and turn it to the highest setting. This is shown by a large flame symbol.

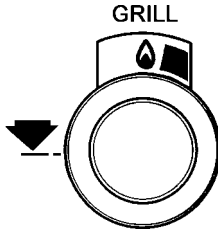

Oven

To light:

- 1 Open the oven door.
- 2 Push in the control knob and turn it to gas mark 9. When the burner has lit there will only be small flames at first.

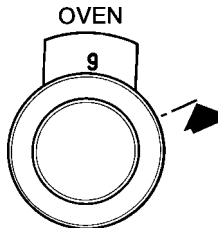

- 3 Now turn the control knob to the gas mark you want.
- 4 Wait until the burner is showing large flames.
- 5 Close the oven door.

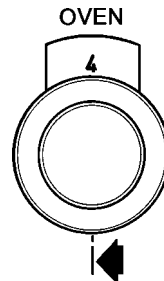

To turn off any burner

- 1 Push in the control knob and turn it to the off position.
This is shown by a large dot.

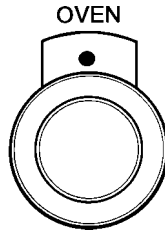

For your safety

When you are lighting any burner check that it has lit before you leave the oven.

When you are turning off a burner do not leave the oven until the flame has gone out.

The grill

We suggest that you run the grill without food for approximately 5 - 10 minutes to burn off any residue from the surface. During this period an odour may be emitted, it is therefore advisable to open a window for ventilation.

Heat control

The grill gives variable heat settings.

The control knob turns to the left from 'OFF' to 'HIGH' and then to 'LOW'. The high setting should be used for fast cooking such as toast. Use a lower setting to cook thicker foods such as chicken after it has been browned on the high setting.

You should remember to turn the food regularly.

You should not use the grill to keep food warm as it will continue to cook the food.

The grill pan should be used on the shelf without the metal plate underneath it. The shelf can be positioned in any of the runner positions. You can reverse the grill pan grid to suit different types of food.

If you close the door whilst the grill burner is lit, it will go out and you will hear a continuous 'sparking'. The burner will automatically re-light when you open the door.

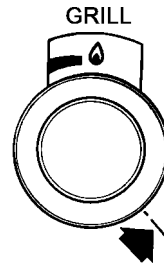

For your safety

You must keep the grill door fully or partially open when the grill burner is lit.

Accessible parts may be hot when the grill is used.

Young children should be kept away.

Cooking positions

Most food should be cooked on the grid in the grill pan. You can turn the grid over to suit different thicknesses of food.

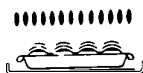
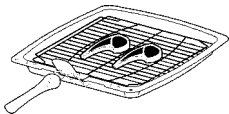
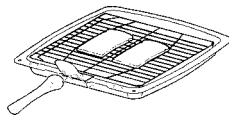

You can place some dishes straight on the grill shelf. This is useful when you are browning the top of food such as cauliflower cheese.

Preheating

You don't usually need to preheat the grill. You may wish to preheat it for a couple of minutes when you are cooking steak or browning food.

Putting food on the grid

Place food such as toast, tea-cakes and muffins towards the centre of the grid. If you put food outside this area it may require rotating during cooking.

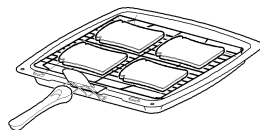

Place food which needs a more gentle heat, such as tomatoes or mushrooms towards the edge of the grid.



Arrange meat, meat products and fish to suit their thickness and how you like them cooked.

To prevent excess fat splashing when you use the grill place the trivet in the grill pan below the grill grid.

Grill shelf

The grill shelf can be slotted into place in any of two positions. For safety the shelf will only pull out so far. If you want to remove the shelf completely pull it forward as far as it will go, raise the front edge and lift it out. To put the shelf into a different position, keep the front edge raised, slot the shelf onto the runner, lower the front edge and slide the shelf in.

You should use the shelf without the metal plate when grilling.

Use shelf position one when toasting and adjust the height of the grid to suit.

Shelf positions are counted from the top downwards.

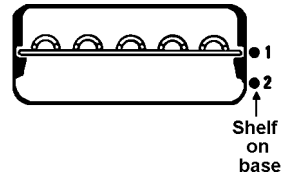

Dishes, tins and trays should not be placed directly on the oven base as it becomes very hot and damage will occur.

For your safety

Always remove the grill pan before attempting to adjust the shelf position. Oven gloves should be used when removing or pulling the shelf in and out.

For hygiene and safety reasons this cooker should be kept clean at all times. A build-up of fats or other foodstuffs could result in a fire, especially in the grill pan.

The grill pan and handle

The grill pan is supplied with a removable handle.

To attach the handle, place the wirework under the cut out in the pan so that the metal plate hooks over the top of the grill pan.

Slide the handle to the left and over the central bump on the grill pan.

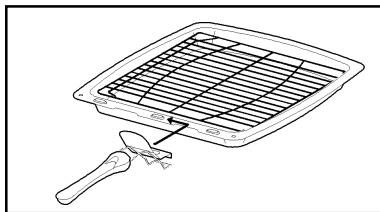

Ensure the handle is correctly located. It is not necessary to remove the grill pan handle during grilling.

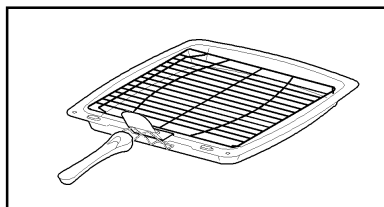

Place the grill pan on the shelf so that the pan is positioned centrally beneath the grill.

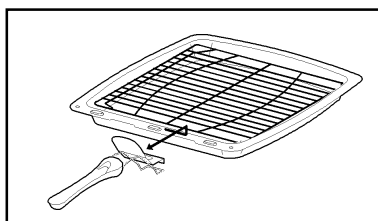

To remove the handle, slide the handle to the right and lift the handle away from the cut out on the grill pan.

If you require an additional handle for your grill pan, this can be ordered from your local Zanussi Service Force Centre by quoting part number 311479800\6.

To check the progress of the food when using the grill you should withdraw the grill pan on the shelf to attend to food. After removing the grill pan you can rest it on a heat resistant work surface if you need to.

Plate warming

You can use the grill compartment to warm plates while the oven is on. Do not place plates to warm under the grill when it is on as this may damage the plates.

The oven

For your safety

Never leave the cooker unattended when the oven door is open.

We suggest that you run the oven without food for approximately 10 - 15 minutes at gas mark 7 to burn off any residue from the surface. During this period an odour may be emitted, it is therefore advisable to open a window for ventilation.

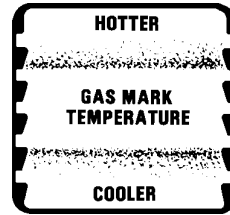

Heat zones

There are zones of heat within the oven. The temperature in the middle is the gas mark you have chosen.

The top of the oven is slightly hotter and the lower shelf slightly cooler. The base of the oven is quite a lot cooler. You can make use of these heat zones when you are cooking foods requiring different temperatures all at the same time. You can use the base of the oven to warm plates.

If you are cooking more than one tray of similar items, for example cakes or biscuits, swap the trays around during cooking. Or you could remove the top tray when the food is cooked and move the lower tray to the higher shelf to finish cooking.

Preheating

You do not need to preheat the oven for casseroles and so on.

Preheat the oven for baking or when you are cooking sensitive food such as Yorkshire puddings, soufflés and yeast mixtures.

When you are cooking or reheating frozen or chilled food read the instructions on the packaging.

When you need to preheat the oven, we recommend you do so for 20 minutes.

Oven shelves

The two oven shelves can be slotted into place in any of 5 positions. For safety the shelves will only pull out so far. If you want to remove a shelf completely, pull it forward as far as it will go, raise the front edge and lift it out.

To put the shelf into a different position, keep the front edge raised, slot the shelf onto the runner, lower the front edge and slide the shelf in.

The shelf positions are counted from the top downwards and recommended shelf positions are given in the cooking charts on pages 17, 18 and 19. When cooking always try to leave at least one runner position between shelves to allow the heat to circulate properly.

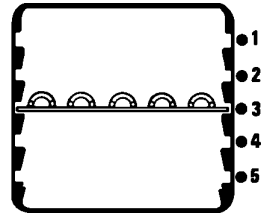

The recommended shelf positions given in the oven cooking charts give the best results.

When you only need to use one shelf you can store the other shelf above or below the one you are using where there is more space.

Use the shelf with the metal plate in a higher runner position when cooking on two levels.

Dishes, tins and trays should not be placed directly on the oven base as it becomes very hot and damage will occur.

Baking trays and dishes



For your safety

Never place cooking dishes, trays and so on over the oven burner. This will damage the oven as well as the ovenware and possibly the cabinet underneath the oven.







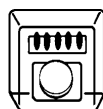

Leave a gap of 13mm (½") between all dishes and the sides of the oven so the heat can circulate properly.

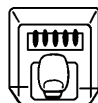
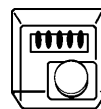

Do not push dishes too far back as food will burn if it overhangs the burner flames.

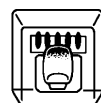

For the best results we recommend that you use a baking tray which is 310mm (12") square. If you use a tray or tin which is larger than this, you may need to turn the food around during cooking.

Place single dishes on the centre of the shelf. You may need to turn large items around during cooking.

Roasting

For best results we recommend open roasting using minimal fat or oil to prevent splashing.

It is not necessary to cover meat or poultry or wrap food in foil when roasting as this restricts the circulation of heat and will lead to extended cooktimes.

If you are using a roasting bag or cover chicken breast with foil, be prepared to allow an extra 10 - 15 minutes for each 1/2kg (1lb).

When cooking large items such as turkeys, the use of foil may be required to prevent the breast becoming dry before the rest of the bird is fully cooked.

Condensation

Condensation may form on the oven. This is quite normal and nothing to worry about. The condensation forms when heat and moisture are present, for example during cooking. Whenever possible try to make sure that food which contains a lot of moisture for example casseroles are covered. If you do notice any condensation, wipe it up straight away.

Oven cooking chart

These instructions are for cooking in the oven after it has been pre-heated for 20 minutes.

When you are using both shelves, use the shelf with the metal plate in the higher position.

If you are cooking more than one tray of similar items, for example cakes or biscuits, swap the trays around during cooking or you can take the top tray out of the oven when the food is cooked and move the lower tray to the higher shelf to finish cooking.

Always leave at least one shelf position between shelves to allow heat to circulate.

The recommended shelf positions give the best results.

Put the dishes in the centre of the shelf.

You can change the gas marks and cooking times to suit your own tastes.

It is important to check that food is piping hot before serving.

Food		Gas mark	Shelf position	Approximate cooking time
Roasting meat:	Beef	5	4*	Rare: 20 mins. per ½kg (1 lb) and 30 mins. Medium: 25 mins. per ½kg (1 lb) and 25 mins. Well Done: 30 mins. per ½kg (1 lb) and 30 mins.
	Lamb	5	4*	Medium: 25 mins. per ½kg (1 lb) and 25 mins. Well Done: 30 mins. per ½kg (1 lb) and 30 mins.
	Pork and Veal	5	4*	Medium: 30 mins. per ½kg (1 lb) and 30 mins. Well Done: 35 mins. per ½kg (1 lb) and 35 mins.

Thoroughly thaw frozen joints before cooking them.

* Recommended position for shelf with metal plate.

Food	Gas mark	Shelf position	Approximate cooking time
Poultry:			
Chicken	5	4*	20 mins. per ½ kg (1 lb) and 20 mins.
Turkey below 4.5kg (10lbs)	4	5	25 mins. per ½ kg (1 lb) and 25 mins.
over 4.5kg (10 lbs)	4	5	15 mins. per ½ kg (1 lb) and 15 mins.
Duck and duckling	5	4*	25 mins. per ½ kg (1 lb)
Stuffed poultry	Cook as above but calculate weight including stuffing		

Thoroughly thaw frozen joints before cooking them.

The times given above are for open roasting in a preheated oven. If you cover the food with foil or a lid allow an extra 10 - 15 minutes for each ½kg (1lb).

Yorkshire pudding	- large	7	2*	25-30 mins.
	- individual	7	2*	15-25 mins.
Cakes:	Very rich fruit cake	According to recipe		
	Rich fruit cake 180mm (7")	2	5*	2¼ hours.
	205mm (8")	2	5*	2½-2¾ hours.
	Madeira, 180mm (7")	4	5*	60 mins.
	Small cakes	5	1* & 4	15-25 mins.
	Scones	7	1* & 4	10-20 mins.
	Victoria sandwich			
	180mm (7")	4	2* & 4	20-30 mins.
	205mm (8")	4	2* & 4	20-35 mins.

* Recommended position for shelf with metal plate.

Food		Gas Mark	Shelf Position	Approximate cooking time
Pastries:	Plate tart (shortcrust)	6	2*	25-35 mins.
	Fruit pie (shortcrust)	6	2*	25-35 mins.
	Mince pies (flan pastry)	5	1* & 4	20-25 mins.
	Profiteroles (choux pastry)	4	2	25-30 mins.

To help pastry brown on the underside cook on a metal plate, or if plates are flat and have no rim underneath, place on baking tray to cook.

Puddings:	Milk puddings	2	3	1½-2 hrs.
	Baked sponge pudding	4	4*	45-60 mins.
	Baked custard	3	2	50-60 mins.
Yeast mixtures:	Bread 0.45kg (1 lb loaves)	8	3*	30-40 mins.
	0.90kg (2 lb loaves)	8	3*	30-40 mins.
	Rolls and buns	8	2*	15-20 mins.

Note: You must soak dried beans then boil them in an open pan for 15 minutes before you add them to any dish.

*Recommended position for shelf with metal plate.

Slow cooking

The slow cook setting gives a very low heat in the oven. It is particularly useful when you are cooking soups, stews and casseroles because the long slow cooking will make cheaper, tougher cuts of meat more tender.

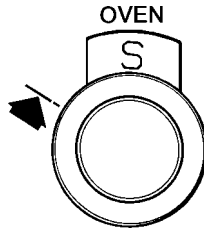

Some foods such as pastry and biscuits are not suitable for slow cooking because the temperature is too low.

Cover all food during cooking to prevent it from drying out. You can uncover food for the last half hour if it is normally served golden brown.

Food preparation-slow cooking

Joints of meat and poultry

- Do not cook meat joints over 2.7kg (6lb).
- Do not cook poultry over 2kg (4lb 8oz).
- Cook on the middle shelf of the oven or above.
- Cook stuffing separately.
- Cook for at least 6 hours.
- Only cook joints of pork if you can make sure, by using a meat thermometer, that the temperature inside the joint is at least 88°C.
- For good air circulation always stand joints on a rack in the roasting tin or casserole
- Thaw all frozen meat and poultry before you cook it.
- Prime cuts of meat do not benefit from slow cooking.
- Cut off unwanted fat and skin unless it is browned first.

Soups, casseroles and stews

- Do not cook casseroles over 3kg (6lb).
- Do not cook two (1.8kg) (2lb) casseroles on slow cook setting at the same time.
- Cook in the middle of the oven or above.
- Cover food with a tight fitting lid or tin foil.
- Cook for up to 9 hours.

Vegetables

- Cut into small pieces.
- Dried beans must be pre-soaked then boiled in an open pan for 15 minutes before adding to any dish.
- To prevent vegetables from discolouring, add lemon juice.
- Place vegetables under meat in casseroles.
- Cover food with a tight fitting lid or tin foil.
- Cook for up to 6 hours.

Milk puddings

- Make the pudding in the usual way.
- For delicate puddings such as egg custard, place the dish in a bain marie and cover the dish with tin foil.
- Cook for 2 - 4 hours.

General points for slow cooking

Frozen foods

Thaw thoroughly before cooking.

Thickening

Toss meat in flour for casseroles. Alternatively blend cornflour with water and add it at the end of cooking.

Flavouring

Flavours are held in the food because there is little evaporation. Adjust flavouring at the end of the cooking time.

Liquid

Use slightly less liquid as there is little evaporation during cooking.

Milk and milk products, for example cream

Add these towards the end of cooking to prevent them from curdling.

Reheating

Cool left over food quickly and then put it in the fridge.

Do not reheat food using the slow cook setting. Reheat food in the usual way or in a microwave.

Only reheat food once.

The electronic timer

Please note that this is a 24 hour clock, for example 2pm is shown as 1400.

In the following pages we explain how to set the controls. Read through them until you're familiar with the procedure.

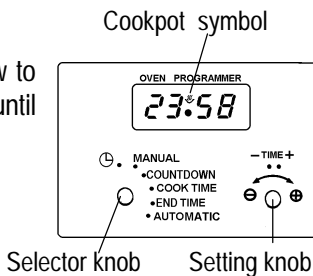

If the oven is switched off on the wall, or there is a loss of power, the clock will stop and you will not be able to use the oven. When you first switch the electricity supply on, the timer display will flash. During the hours of 10p.m. (22.00hrs) and 6a.m. the display will glow dim. If a function is selected the display will glow brighter until the function is complete. It will then revert back to the dim mode.

To set the time of day

Turn and hold the selector knob to ☰

The cookpot symbol (☰) is showing. Adjust the time by turning the setting knob in either direction. The selector knob will return to 'manual' when you let go of it.

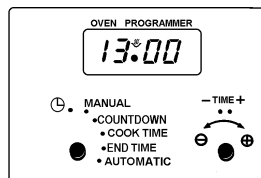

To use the countdown

Turn the selector knob to 'countdown'. Turn the setting knob clockwise until the display shows the time you want. Our diagram shows the timer set to 5 minutes.

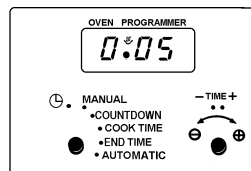

When you are using the minute minder you can make the clock show the time of day by turning the selector knob to 'manual'.

At the end of the timed period an alarm will sound. Switch off the alarm by turning the selector knob to 'manual'.

Automatic control

When you use the automatic controls for the first time it's probably best to choose a time when you are at home. That way you can check to make sure you've set everything correctly and you'll feel much more confident when you are away from home in the future.

Setting the controls for automatic use

This is very easy. All you have to do is work through the steps below. The clock will work out the rest for itself.

1 Is the electricity supply on?

2 Is the clock showing the correct time?

To adjust turn and hold the selector knob to  and turn the setting knob in either direction.

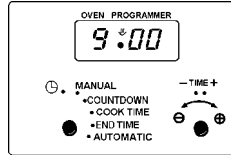

3 How long will the food take to cook?

Turn the selector knob to 'cook time'. Then turn the setting knob until the length of time you want the food to cook shows in the display. The maximum cooking time is 23 hours and 59 minutes. 'Auto' will show in the display.

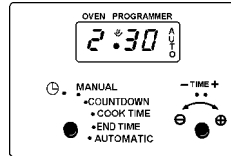

- 4 What time do you want the food to be cooked by? Turn the selector knob to 'End time'. Turn the setting knob until the time the oven is to switch off shows in the display. The cookpot () will go out.

The 'End' time must not be more than 23 hours 59 minutes from the time of day. For example if the time of day is 9.00 am the latest 'End' time will be 8.59 am the next day.

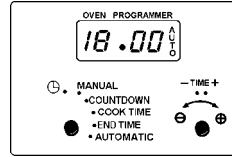

- 5 Set to automatic. Turn the selector knob to 'automatic'. The time of day will show in the display.
- 6 Turn on the oven control. Turn the oven control mark 9 then to the gas mark you want.

The time shown on the chart gives an example of setting the automatic controls when the time is 9.00 am, the food is to be cooked for 2½ hours and the food is needed at 6.00 pm (1800 hours).

The clock will work out what time the oven will switch itself on and it will turn the oven off at the end. Once the automatic sequence is finished there will be an alarm and the 'Auto' symbol flashes to remind you that you need to set the oven for manual operation. To do this turn the selector knob to 'manual'.
Turn off the oven control.

To cancel an automatic programme

If you change your mind and want to cancel a programme that you have set turn the selector knob to 'Cook time' and turn the setting knob until 0.00 shows in the display.
Turn the selector knob to 'manual'.

Hints and tips for automatic cooking

- 1 Check the instructions for setting the automatic controls until you are familiar with the timer operation.
- 2 If the oven has been used, allow it to cool completely before using for automatic cooking.
- 3 You should leave food in the oven for as short a time as possible before automatic cooking starts.
- 4 Do not leave food to stand in the oven when it has finished cooking. You should remove it and if it is not going to be eaten at once, cool it quickly.
- 5 If you cannot remove food from the oven as soon as it is cooked make sure that the food is covered.
- 6 Choose perishable foods carefully, especially during warm weather.
- 7 Food should be fresh and preferably straight from the refrigerator.
- 8 Joints of meat and poultry must be completely thawed.
- 9 Dishes containing left over cooked meat or poultry should not be cooked automatically if there is a delay period.
- 10 Choose dishes which require approximately the same cooking time. Slight variations may be allowed by:-
 - i) placing foods in larger or smaller containers
 - ii) using more or less liquid
 - iii) cutting fruit or vegetables into larger or smaller pieces.These will give longer or shorter cooking times respectively. Further temperature adjustments can be made by placing the foods higher or lower in the oven as the top of the oven is hotter than the bottom.
- 11 Arrange shelf positions to suit dishes and choose dishes which will fit into the oven together.
- 12 As food may be standing for some time in the oven, cover dishes with foil or a lid where possible, and in the case of roast potatoes and joints of meat, brush with a little fat or oil. Lemon juice may be added to fruit and vegetables to prevent browning.
- 13 Cream should be added just before serving.
- 14 If alcohol is used fermentation can occur.
- 15 Green leaf vegetables which take only a short time to cook, should not be placed into the oven with the automatic meal. It is far better to cook them in a pan on the hotplate whilst dishing up the rest of the meal.

Care and cleaning

For your safety

For hygiene and safety reasons you must keep this gas oven clean. A build up of fat or other foodstuff could cause a fire.

Try to mop up spills and splashes as soon as they happen.

But be careful as parts of the appliance will be hot.

Do not use any polishes, caustic cleaners, abrasives, washing soda or soap powder except those recommended in this booklet.

Please note: If we recommend you use hot soapy water we mean hot water with washing up liquid in it and not any other cleaning product.

If you own a dishwasher please read the operating instructions for the machine before you wash any part of your cooker.



Clean your oven regularly using a cloth that has been wrung out in hot soapy water. Rinse and polish it dry using a soft cloth.

When you remove parts of your oven for cleaning do not plunge them into water whilst they are very hot as this may damage the finish of the parts.

You must not remove the control knobs when cleaning the control panel.

The grill

Clean the grill compartment, the shelf, grill pan and handle, grid and trivet, and the inner grill door while they are still slightly warm. This way you can easily remove any splashes and spills. Clean them with a cloth that has been wrung out in soapy water. You may use mild abrasives such as 'Jif'. For more stubborn marks you may occasionally need to use a soap filled pad such as 'Brillo'.







The oven

Clean the base of the oven, the oven shelves, the meat tin, and the oven door while they are still slightly warm. This way you can easily remove any splashes and spills. You may use mild abrasives. The heat in the oven will change the colour of the metal plate on the shelf. You must not remove the solid plate from the shelf. You can soak the shelf for a few minutes in hot soapy water to make cleaning easier. If you use any oven cleaners on the oven base they must have the Vitreous Enamel Development Council (VEDC) seal of approval. Follow the instructions on the cleaning agent and protect the oven burner with aluminium foil to prevent it from becoming blocked. Do not use any cleaning products on the top, sides and back of your oven.

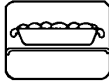
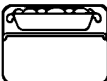
The top, sides and back of your oven are coated in a special material which helps to keep itself clean.

Follow these simple rules to maintain the appearance of the special finish.



- 1  Do not overfill dishes or they will boil over. 
- 2  Do not use dishes too high in the oven. If you do they may stick to the oven roof. 
- 3  Cover your roasting tins with foil. This will prevent fat splashing. 
- 4  Use a roasting tin which is just large enough for the meat and potatoes. This will help to reduce fat splashing. 
- 5  Dry any vegetables that you are going to roast. If they are wet there will be more fat splashing. 
- 6 Follow the oven cleaning cycle regularly.

Oven cleaning cycle

You need to follow the cycle to keep the inside of the oven in good condition. The type of cooking you do will affect how often you need to follow the cycle.

If you do a lot of roasting and very little baking you should follow the cleaning cycle once a week. If you do very little roasting you will only need to follow the cleaning cycle every 2-3 weeks.

To carry out a cleaning cycle:

- 1 Remove the oven shelves.
- 2 Set the oven to mark 5 for at least 30 minutes.
- 3 Turn the temperature up to mark 7 for 2 hours or until the oven is presentably clean. Some staining will remain.

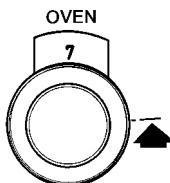
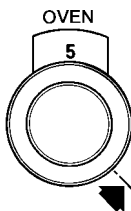

Do not use any cleaning agents or scrapers on the inside of the oven. Do not wash the special finish.



Cleaning between the outer and inner door glass

You can remove the glass from the oven and grill doors if you need to. The grill door is fitted with a trim. You must note the correct position of the trim when you remove the grill door glass.

To remove the outer glass

- 1 Open the door so you can get at the two cross head screws on the top of the door.
- 2 Loosen these two screws using a pozidrive screwdriver.
- 3 You should hold the door glass securely in place with one hand, whilst removing the screws completely, with the other hand. If you do not do this, the door glass could fall forward. Still holding the door glass, remove the trim from the top of the grill door.

Note the correct position of the grill door trim. The oven door does not have a trim.

- Using both hands, gently tilt the top of the door glass towards you. Lift it slightly to disengage the locators at the bottom of the door.

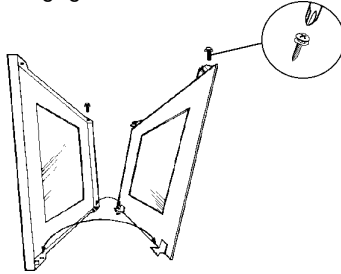

- Clean the outer and inner glass using hot soapy water and mild abrasives such as 'Jif'.
- Replace the glass by holding it in both hands and gently placing the locators into the holes of the brackets at the bottom of the door. Push the top of the glass towards the door, and make sure the screw location holes line up. Replace the trim on top of the grill door making sure that it is correctly positioned. You can check this by looking through the air gap on the top of the door and checking that the screw location holes line up.
- Hold the glass in place with one hand and replace the cross head screws into the location holes, with the other hand.
- Tighten the screws using a pozidrive screwdriver. Close the door.

Cleaning The Door Glass

 To prevent damaging or weakening the door glass panels avoid the use of the following:

- Household detergents and bleaches
- Impregnated pads unsuitable for non-stick saucepans
- Brillo/Ajax pads or steel wool pads
- Chemical oven pads or aerosols
- Rust removers
- Bath/Sink stain removers

 If the door glass panel becomes chipped or has deep scratches the glass will be weakened and must be replaced to prevent the possibility of the panel shattering. Please contact your local Service Centre who will be pleased to advise further.

What is wrong and why?

We strongly recommend that you carry out the following checks on your oven before calling a Service Engineer. It may be that the problem is a simple one which you can solve yourself, without the expense of a service call.

If the Service Engineer finds that the problem is listed below, you will be charged for the call whether or not the cooker is under guarantee.

Problem

The oven or grill will not light.

Check

- Check that the oven is switched on at the wall.
- Check that the timer is set to 'manual' (See page 25).
- Check that there has not been a power failure. If the electricity supply has been interrupted or you have switched the oven off at the wall the grill may have cut out before the cooling fan has cooled the oven down. Switch the oven on at the wall until the cooling fan has cooled it down.
- Check that there is not a problem with your gas supply. You can do this by making sure that other gas appliances such as your central heating or gas fire are working.

Problem

Food is cooking too quickly or too slowly.

Check

- Check that you are using the recommended gas marks and shelf positions. See pages 17, 18 and 19. Be prepared to adjust the gas mark up or down to achieve the results you want.

Problem

The oven is not cooking evenly.

Check

- Check that the oven is installed properly and is level.
- Check you are using the recommended temperatures and shelf positions.
- If you are using a tin or tray which is larger than the one we recommend, be prepared to turn it round during cooking
- If you are cooking a large item be prepared to turn it round during cooking.

Problem

Having difficulty cleaning any part of the oven.

Check

- Check that you are following the instructions for care and cleaning (See page 27).

Problem

The oven light does not work.

Check

- Check that the oven is not set for automatic cooking. The light will illuminate when cooking begins.
- If you have had your oven for some time you may need to replace the oven light bulb. (See page 33).

Problem

The timer does not work.

Check

- Check that the timer instructions are being closely followed. (See page 23).

Problem

The oven or grill burner flame is unstable/noisy.

Check

- Check that the burner flames stabilise after a few minutes. It may be that the appliance needs to adjust to room temperature.

Replacing an oven light bulb

You need a 25 Watt small Edison screw with a temperature rating of T300.

- Make sure the oven is cool before you replace the bulb.
- Unplug the oven.
- Open the oven door and remove the oven shelves.
- Pull the glass bulb cover towards you and then pull it off.
- Unscrew the bulb by turning it to the left.
- Fit a new bulb and then replace the glass bulb cover.
- Replace the oven shelves.
- Plug the oven back into the electricity supply.
- Re-set the time of day.

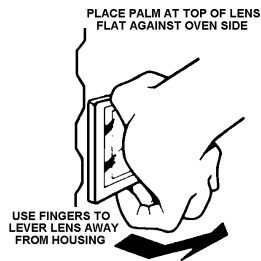

The oven light bulb is not covered by the manufacturers guarantee.

Service and spare parts

For your safety

Maintenance work must only be done by a competent person. Do not try to repair the oven yourself. This could be dangerous. It is dangerous to alter or modify the product in any way.

Help us to help you

Please determine your type of enquiry before writing or telephoning.

Service

It is a recommendation by the manufacturer that your cooker has an annual gas safety check carried out by the manufacturers approved organisation.

Before calling out an Engineer, please ensure that you have read the details under the heading 'What is wrong and why?' and have the model number and purchase date to hand. The telephone number for service is:

0870 5 929929

PLEASE NOTE that all enquiries concerning service should be addressed to your local Zanussi Customer Service Centre.

Some Regional Electricity Companies are responsible for the servicing of cookers sold through their own retail outlets. For service contact your local Electricity Showroom.

When you report a problem try to describe the nature of the fault. Always give your ovens full name, model and serial numbers which you can see when the oven door is opened.

Your call will be routed to Service Force Centre covering your postcode area.

Make a note of this information in this space:

Name:

Model Number:

Serial Number:

G.C. Number:

Customer care department

For general enquiries concerning your Zanussi cooker or further information on products, you are invited to contact our Consumer Care Department by letter or telephone as follows:

Customer Care Department
Zanussi
55 -77 High Street
Slough
Berkshire
SL1 1DZ

Tel: 0870 5 727727

The Gas Consumers' Council

The Gas Consumers' Council (GCC) is an independent organisation which protects the interests of gas users. If you need advice, you will find the telephone number in your local telephone directory under Gas.

TECHNICAL DATA

Serial number on front frame. Data badge on rear of electrics panel.

DIMENSIONS	<i>Height</i>	<i>Width</i>	<i>Depth</i>
Overall	885	595	595
Flexible Gas Pipe			
Minimum Cabinet	874	560	575
Solid Gas Pipe			
Minimum Cabinet	874	560	560
Maximum Cabinet	879	570	N/A
Weight of Appliance	45kg		
Minimum Clearance top of Appliance to Roof of Cabinet	3mm (1/8")		

CONNECTIONS

Gas	Flexible Hose	Rear top right hand side of appliance Rc½ (½" B.S.P. Female).
	Solid Pipe	Right hand side of appliance above grill Behind control panel Rc¼ (¼" B.S.P. Female)
Electrical		Rear of appliance at bottom left hand side 240V a.c. 50Hz Mains 3 core cable and moulded plug fused to 3amp.

GENERAL

Automatic Oven	
Control	Diehl Type 311/60
Pressure test point	Top right hand corner behind fascia.
Solenoid valve	Teddington SOVRBB01

IGNITION

Spark Generator	Flame Suppressed H.T. Spark 240V APCO D9805
Spark Gap	3-4mm

GRILL

	<i>Natural Gas</i>	<i>L.P. Gas</i>
Burner	Steel tubular burner with expanded metal frets.	
Heat Input	2.8kW (9556 Btu/h)	2.8kW (201 g/h)
Injector Marking	123	089

OVEN

	<i>Natural Gas</i>	<i>L.P.Gas</i>
Burner	Sheet metal construction mounted transversely at rear of oven.	
Heat Input	2.4kW (8189 btu/h)	2.4kW(127g/h)
Injector Marking	108	078
Flame Supervision Device	Diamond 'H' G.S.D. 100/28	Diamond 'H' G.S.D. 100/30
Thermostat	Diamond 'H' 1100/110/B2	Diamond 'H' 1100/114/B2
Thermostat By-Pass Marking	74	79

IMPORTANT - SAFETY REQUIREMENTS

This appliance must be installed in accordance with the Gas Safety (Installation and Use) Regulations Current Editions. Detailed recommendations are contained in the following British Standard Codes of Practice - BS.6172, BS.5440: Part 2 and BS.6891. All British Standards must be 'Current Editions'.

PROVISION FOR VENTILATION

The room containing the appliance should have an air supply in accordance with BS.5440: Part 2 Current Edition. All rooms require an openable window or equivalent and some rooms will require a permanent vent as well. For room volumes up to 5m³ an air vent of 100cm² is required. For room volumes between 5m³ and 10m³ an air vent of 50cm² is required. If the room has a door that opens directly to the outside, no air vent is required. For room volumes that exceed 11m³ no air vent is required. If there are other fuel burning appliances in the same room, BS.5440: Part 2 Current Edition should be consulted to determine the requisite vent requirements.

LOCATION OF APPLIANCE

The appliance may be located in a kitchen, a kitchen/diner or bedsitting room, but not located in a bathroom or shower room.

It is essential that there is a minimum clearance of 3mm between the top surface of the appliance and the inside top of the cabinet. The unit must be fitted into a cabinet conforming to Fig. 1. The following internal dimensions are particularly important.

	Height	874.....Minimum	879.....Maximum
	Width	560.....Minimum	570.....Maximum
Solid Pipe	Depth	560..... Minimum	N/A.....Maximum
Flexible Pipe	Depth	575.....Minimum	N/A.....Maximum

NOTE: Where a cupboard door with a handle is situated above the appliance, we recommend a minimum clearance gap of 5mm between fascia top trim and door. L.P.G. cookers **MUST NOT** be installed below ground level, i.e. in a basement, or aboard any boat, yacht or other vessel.

Fig.1

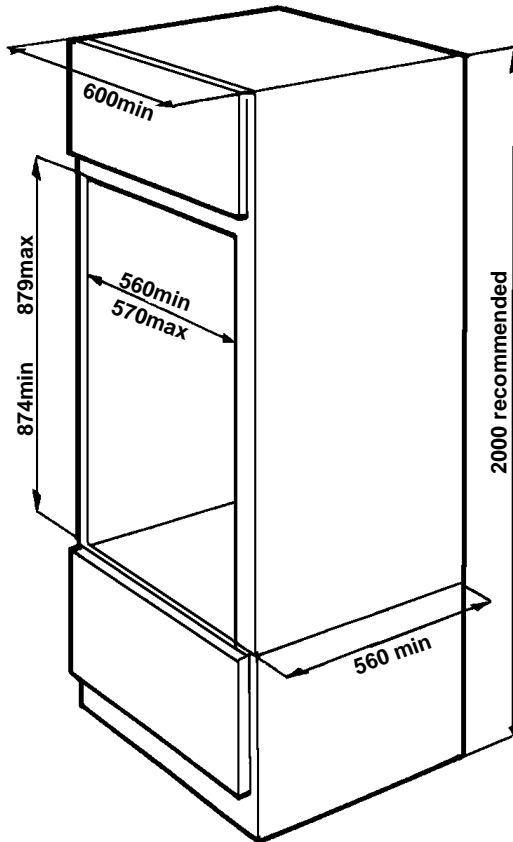

INSTALLATION Flexible Pipe Installation.

1. FITTING THE APPLIANCE AND CABINET

It is recommended that a $\frac{3}{8}$, 1100mm long angled bayonet flexible hose (BFS) and a $\frac{1}{2}$ " straight socket (BFS) be used for the installation. However any approved hose of the right length can be used.

IMPORTANT: Flexible tubing used must comply with B.S. 669 current editions L.P.G. flexible connections must be of a type suitable for L.P.G. and capable of operation up to 50mbar and carry a red stripe, band or label.

NOTE: Only liquid sealants can be used in threaded gas connections. Do not use P.T.F.E. tape.

- 1 Make suitable arrangements for gas and electric supplies into the installation site. Preferably a junction box or 3 pin earth socket should be situated at the back of the cabinet below the oven.
- 2 The electrical connection to the appliance is at the rear bottom right hand side, the junction box or socket should be positioned accordingly.
- 3 Fit the cabinet as Fig.1, making sure that it is level.
- 4 When unpacking the appliance keep it on its polystyrene base until it is put into the cabinet to avoid damage. Do not allow young children to play with any part of the packaging. After installation, please dispose of the packaging with due regard to the environment, your local authority can arrange this.

NOTE: It is imperative that the appliance is left in the base to protect both the appliance and the floor.

- 5 Remove the oven and grill doors
 - i) Open door fully.
 - ii) Rotate the hinge stirrups to their forward position. (See Fig. 2).
 - iii) To remove the door, clear the hinges by raising the door slightly whilst pulling towards you.

Fig.2

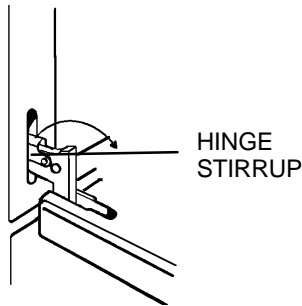

- 6 Remove the fascia panel .
 - i) Remove the gas control knobs, springs, bezels and timer control knobs.
 - ii) Remove the four screw (two each side) which are visible on the underside of the fascia. Fig.3.
 - iii) Tilt the bottom of the fascia panel out over. Withdraw the fascia panel by moving it down over to disengage it from the top fixing lugs. Take care not to lose the two rubber grommets from the timer.

NOTE: The thermostat and grill discs will remain attached to the fascia panel. When refitting the control knobs and bezels, the drive pins on the rear of the bezel must first be located in the disc carrier. The knob and spring can now be fitted onto the control spindle. To prevent the top fascia panel mounts becoming slack, it may be necessary to adjust the top fixing lugs.

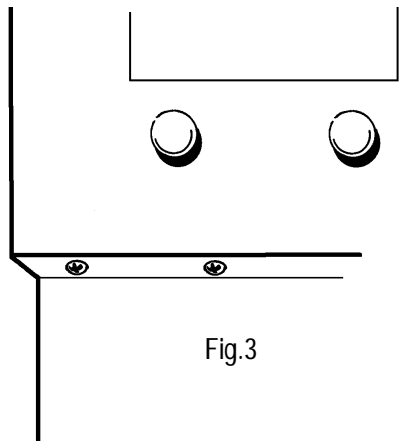

- 7 If the gas supply bayonet and wall fixing bracket are to be located behind the appliance. It must be located in the shaded area as indicated in Fig.5.
- 8 Connect flexible hose to the gas inlet supply block see Fig.5 (The flexible supply pipe must be suitable for use at 70°C above ambient). The hose should be long enough to allow the appliance to be withdrawn from the cabinet.
- 9 Position the appliance in front of the cabinet and run the supply cable (See Section 2) through the cabinet and connect to the junction box or socket. Ensure that the supply is isolated at this stage. Connect flexible hose to the bayonet connector.
- **N.B. Two people will be required to carry out the lifting procedure.**
Warning: Do not attempt to lift this appliance by the handle.
- 10 Lift the appliance into the cabinet making sure the hose and supply cable are not trapped. Push the appliance as far back as it will go.
- 11 Centralise and fix the appliance using the six wood screws provided, in the position indicated in Fig.4.
- 12 Carry out a gas soundness check.

NOTE: Check the gas supply pressure before fitting the fascia. (See Section 3).

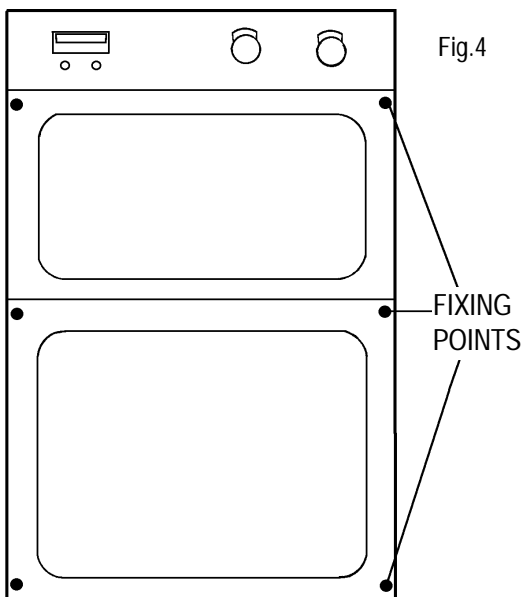

INSTALLATION

Solid Pipe Installation

FITTING THE APPLIANCE AND CABINET.

Make suitable arrangements for gas and electrical supplies into the installation site. Preferably a junction box or 3 pin earthed socket should be situated at the back of the cabinet below the oven.

- 2 The electrical connection to the appliance is at the rear bottom right hand side, the junction box or socket should be positioned accordingly.
 - 3 Fit cabinet as Fig. 1, making sure that it is level.
 - 4 When unpacking the appliance keep it on its polystyrene base until it is put into the cabinet to avoid damage. Do not allow young children to play with any part of the packaging. After installation, please dispose of the packaging with due regard to the environment, your local authority can arrange this.
- NOTE: It is imperative that the appliance is left in the base to protect both the appliance and the floor.
- 5 Remove the oven and grill doors
 - i) Open door fully.
 - ii) Rotate the hinge stirrups to there forward position (See Fig. 2).
 - iii) To remove the door, clear the hinges by raising the door slightly whilst pulling towards you.
 - 6 Remove the fascia panel.
 - i) Remove the gas control knobs, springs, bezels and timer control knobs.
 - ii) Remove the four screw (two each side) which are visible on the underside of the fascia. Fig. 3.
 - iii) Tilt the bottom of the fascia panel out over. Withdraw the fascia panel by moving it down over to disengage it from the top fixing lugs. Take care not to lose the 2 rubber grommets from the timer.

Fig.5

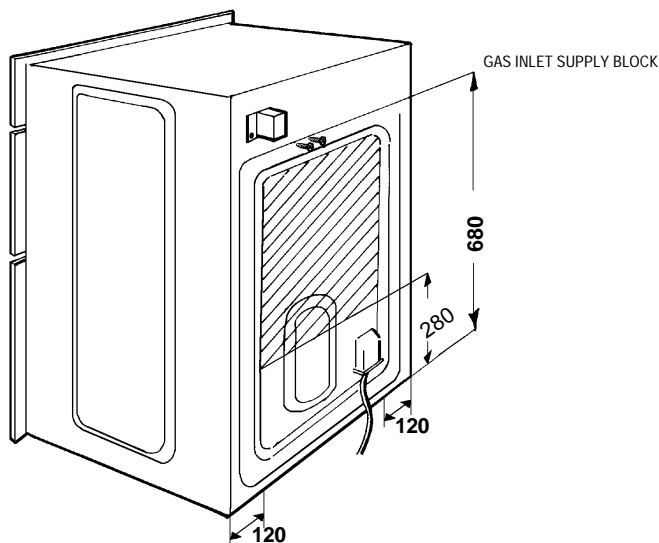

NOTE: The thermostat and grill discs will remain attached to the fascia panel. When refitting the control knobs and bezels, the drive pins on the rear of the bezel must first be located in the disc carrier. The knob and spring can now be fitted onto the control spindle. To prevent the top fascia panel mounts becoming slack, it may be necessary to adjust the top fixing lugs.

- 7 Solid gas pipe installation:
 - i) Slacken and remove the union nut on the gas supply elbow on the right hand side of the control panel. See Fig 9.
 - ii) Remove the two screws on the gas inlet block Fig.5.
 - iii) Withdraw the gas inlet block and pipe assembly from the back of the appliance.
 - iv) Remove the union elbow from the inlet block and pipe assembly. The elbow will be required in the final installation.
 - v) The union elbow should be connected to the gas supply pipe via a standard ¼" B.S.P. straight connector.

Install the gas supply pipe on site complete with the union elbow (See Fig.6). Note the orientation of the elbow.

8 Position the appliance in front of the cabinet and run the supply cable (See Section 2) through the cabinet and connect to the junction box or socket. Ensure that the supply is isolated at this stage.

● **N.B. Two people will be required to carry out the lifting procedure.**

Warning: Do not attempt to lift this appliance by the handle.

9 Lift the appliance into the cabinet making sure the gas supply pipe enters the duct in the rear of the appliance and the cable is not trapped by the appliance. Push the appliance as far back as it will go. Ensure the supply pipe comes through the control panel and pull through any slack cable.

10 Centralise and fix the appliance to the cabinet using six wood screws in the position indicated in Fig.4

11 Tighten the union nut into the supply elbow.

12 Carry out a gas soundness check.

NOTE: Check supply pressure before fitting fascia (See Section 3).

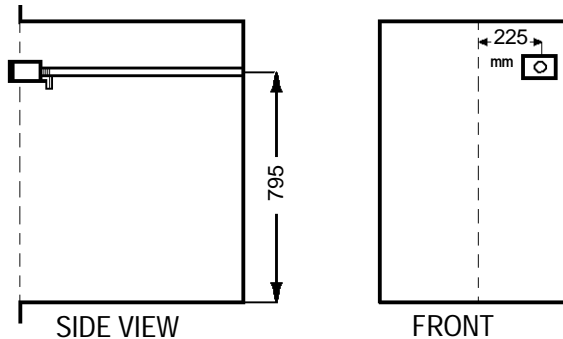

Fig.6

2. CONNECTION TO ELECTRICITY SUPPLY

WARNING: This appliance must be earthed, do not earth this appliance to the gas supply piping.

This appliance must be connected to a 220V-240V AC, 50Hz supply which incorporates a 3 ampere fuse. If any other type of plug is used it should incorporate a 5 ampere fuse either in the plug or adapter or at the distribution board. The appliance is supplied with 2 meters (6.5 ft) of 5 ampere 3 core cable fitted with a moulded plug. If this proves to be insufficient to allow the appliance to be plugged into the nearest supply socket, the supply cable can be either:

- i) Replaced totally by a longer cable at least 0.75mm² nominal cross sectional area (24/0.2).
- ii) Extended by using a B.E.A.B. approved 3-way sealed flex connector with integral flex clamps.

DO NOT EXTEND THE CABLE USING PLASTIC OR CERAMIC CONNECTION TERMINAL BLOCKS AND/OR INSULATION TAPE.

If the supply cable is replaced it is recommended that the ends of the new cable all be cut to the same length 60mm, any excess wire being stored inside the mains terminal see Fig.7.

Should the supplied cable be required to be threaded through small apertures in the cabinets it can be removed from the mains inlet terminal block see Fig.7.

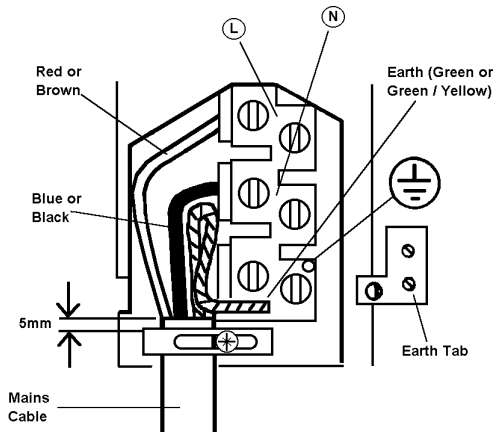

Fig.7

If the supplied plug is cut off dispose of it safely as it will be a shock hazard if inserted into a 13 amp socket elsewhere in the house.

To fit a 3 pin 13 amp plug to the end of the appliance cable (Fig.8).

Connect the wires as follows:

BROWN to the live terminal.

BLUE to the neutral terminal.

GREEN and YELLOW to the earth terminal.

As the colours of the wires in the mains lead of this appliance may not correspond with the coloured markings identifying the terminals in your plug, proceed as follows:

The wire which is GREEN and YELLOW must be connected to the terminal in the plug which is marked with the letter 'E' or by the earth symbol or coloured GREEN or GREEN and YELLOW.

The wire which is coloured BLUE must be connected to the terminal which is marked with the letter 'N' or coloured black.

The wire which is coloured BROWN must be connected to the terminal which is marked with the letter 'L' or coloured RED.

FIT A 3 AMP FUSE TO THE PLUG FUSE HOLDER

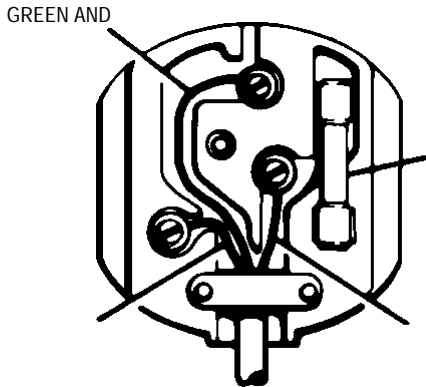

Fig.8

3. PRESSURE TESTING

The pressure test point is located on the right hand side of the gas rail. Access to the test point is through a cut out in the top right hand side of the control panel see Fig.9.

- 1 Remove the hex head plug from the test point.
- 2 Connect the pressure gauge to the test point.
- 3 Check the supply pressure by turning the oven thermostat to Mark 9 then turn on the gas and electricity supplies. Allow the oven burner to light and gas flow open up to full rate.
The pressure should be
For Natural Gas 20mbar
For L.P.Gas 28mbar for Butane,37mbar for Propane
- 4 Turn off the gas and electricities supply and the thermostat disconnect the pressure gauge and replace the test point plug. Turn on the gas supply and check for gas soundness.

NOTE . The electrical supply must be connected in order to test the pressure

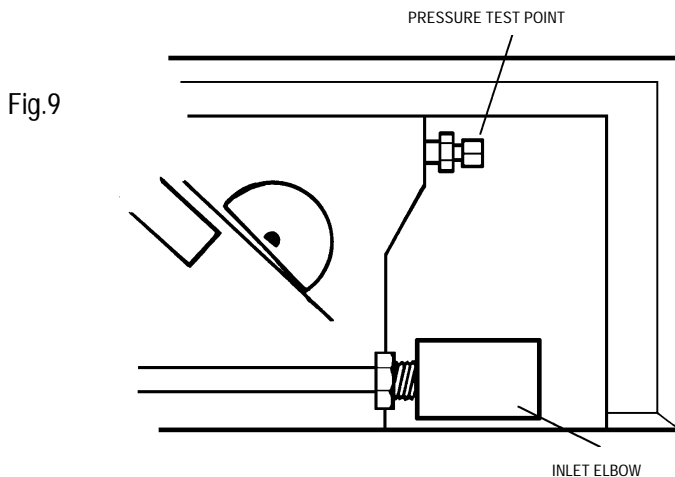

4. RE-ASSEMBLE THE APPLIANCE

- 1 Refit the fascia panel.
- 2 Re-fit the oven and grill doors.

5. CHECKING THE GRILL

- 1 Place the grill pan containing the trivet under the grill burner.
- 2 With the grill door open, turn on the grill tap, check that there is a spark from it's ignition system. This should continue until the burner is alight.
- 3 There is a safety switch which shuts off the gas supply to the grill burner when the door is closed. Check that it is operational by slowly closing the grill door, the gas supply should be shut off to the burner before the grill door is fully closed.

NOTE: The burner will continue to spark.

6. CHECKING THE MAIN OVEN CONTROLS

To set the clock (See Fig.10).

- 1 Turn on electricity supply and ensure that the thermostat is in the off position.
- 2 Rotate left hand clock knob to the ☰ position.
- 3 Set the time of day by rotating the right hand knob.

NOTE: that it is a 24 hour clock.

- 4 Rotate the left hand knob to the 'manual' position.

Fig.10

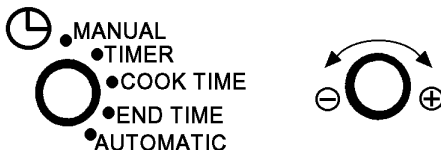

7. CHECKING THE MAIN OVEN

- 1 Set the clock as described in section 6, the clock is now ready for manual operation.
- 2 Turn the main thermostat knob to Mk. 9 and check that there is sparking from the ignition system. This should continue until the oven burner is alight.
- 3 When the oven burner lights up the sparking should cease, there should be a low gas rate at first to the oven burner which is the flame supervision device (F.S.D.) by pass rate.
- 4 When the F.S.D. phial has heated up it opens the F.S.D. valve and the main gas stream flows to the burner.
- 5 Set the oven thermostat to Mk. 2, close the oven door and check that after 10 minutes the flame size has reduced.
- 6 Turn off the thermostat and check that the oven flames go out.

8. AUTOMATIC OPERATION

Having set the clock up as described above, turn the left hand knob to the 'Cook Time' position and set the right hand knob to show a cooking time of two minutes (0.02).

Turn the left hand knob to the 'End Time' position, the time shown on the display is now the time of day with two minutes added on. Rotate the right hand knob to add two minutes to this time to give a two minute delay.

Turn the left hand knob to the 'Automatic' position to complete the programming sequence, the clock now shows the time of day again with the auto neon glowing continuously.

Turn the oven thermostat on and two minutes after setting, the oven burner should commence it's lighting sequence.

Two minutes after the lighting sequence has started the timer should switch off the gas supply to the oven burner and the audible signal should sound. If the signal is continuous it may be switched off at any time by rotating the left hand knob.

Return timer to manual by rotating the left hand knob to the 'manual' position.

GENERAL NOTE Instruct the user how to use the appliance. Inform the user that when the appliance is first turned on they may be able to smell residues from the surfaces being burnt off. It may be necessary to open a window for ventilation. The smell will disappear after using the oven a few times. Refer the user to the wording in the inside cover of the Users Instructions which gives advice on the safe operation of the appliance. Advise the user that the cooling fan may continue to work after they have turned off the oven or grill and it will switch itself off when the oven has cooled down.

Guarantee Conditions

Standard guarantee conditions

We, Zanussi, undertake that if within 24 months of the date of the purchase this Zanussi appliance or any part thereof is proved to be defective by reason only of faulty workmanship or materials, we will, at our option repair or replace the same **FREE OF CHARGE** for labour, materials or carriage on condition that:

- The appliance has been correctly installed and used only on the electricity supply stated on the rating plate
- The appliance has been used for normal domestic purposes only, and in accordance with the manufacturer's instructions
- The appliance has not been serviced, maintained repaired, taken apart or tampered with by any person not authorised by us
- All service work under this guarantee must be undertaken by a Zanussi Service Force Centre.
- Any appliance or defective part replaced shall become the Company's property
- This guarantee is in addition to your statutory and other legal rights

Home visits are made between **8.30am** and **5.30pm** Monday to Friday. Visits may be available outside these hours in which case a **premium** will be charged.

Exclusions

This guarantee does not cover:

- Damage or calls resulting from transportation, improper use or neglect, the replacement of any light bulbs or removable parts of glass or plastic
- Costs incurred for calls to put right an appliance which is improperly installed or calls to appliances outside the United Kingdom
- Appliances found to be in use within a commercial environment, plus those which are subject to rental agreements
- Products of Zanussi manufacture which are not marketed by Zanussi

European Guarantee

If you should move to another country within Europe then your guarantee moves with you to your new home subject to the following qualifications:

- The guarantee starts from the date you first purchased your product
- The guarantee is for the same period and to the same extent for labour and parts as exists in the new country of use for this brand or range of products
- This guarantee relates to you and cannot be transferred to another user
- Your new home is within the European Community (EC) or European Free Trade Area
- The product is installed and used in accordance with our instructions and is only used domestically, i.e. a normal household
- The product is installed taking into account regulations in your new country

Before you move please contact your nearest Customer Care centre, listed below, to give them details of your new home. They will then ensure that the local Service Organisation is aware of your move and able to look after you and your appliances.

France	Senlis	+33 (0)3 44 62 29 99
Germany	Nürnberg	+49 (0)911 323 2600
Italy	Pordenone	+39 (0)1678 47053
Sweden	Stockholm	+46 (0)8 738 79 50
UK	Slough	+44 (0)1753 219897

ZDG862 31177804

PART NO: 311477804



Free Manuals Download Website

<http://myh66.com>

<http://usermanuals.us>

<http://www.somanuals.com>

<http://www.4manuals.cc>

<http://www.manual-lib.com>

<http://www.404manual.com>

<http://www.luxmanual.com>

<http://aubethermostatmanual.com>

Golf course search by state

<http://golfingnear.com>

Email search by domain

<http://emailbydomain.com>

Auto manuals search

<http://auto.somanuals.com>

TV manuals search

<http://tv.somanuals.com>