

User
information

Informations à
l'intention de
l'utilisateur

Built-in oven

Four
encastrable

ZOB 593

Thank you for selecting our appliance

We wish you lots of enjoyment with your new appliance and we hope that you will consider our brand again when purchasing household appliances.

Please read this user manual carefully and keep it throughout the product life cycle as a reference document. The user manual should be passed on to any future owner of the appliance.

Contents

Warnings and Important Safety Information	4
Description of the appliance	6
Control panel	7
When the oven is first installed	8
Function Symbols	11
Using the Oven	12
Programming the Oven	17
Safety and Energy Saving Functions	19
Baking and Roasting Tables	22
Cleaning and Maintenance	24
If something is wrong	28
Technical Data	29
Instructions for the Installer	30
Building In	31
Guarantee/Customer Service	32
European Guarantee	34

Guide to using the user instructions



Safety instructions



Step by step instructions



Hints and Tips



This appliance conforms with the following **ECC Directives**:

- 2006/95 (Low Voltage Directive);
 - 89/336 (EMC Directive);
 - 93/68 (General Directive);
- and subsequent modifications.

English



Warnings and Important Safety Information

Always keep these user instructions with the appliance. Should the appliance be passed on to third persons or sold, or if you leave this appliance behind when you move house, it is very important that the new user has access to these user instructions and the accompanying information.

These warnings are provided for the safety of the users and those living with them. So read them carefully before connecting and/or using the appliance.

Installation

- The installation must be performed by a qualified person in accordance with the rules and regulations in force. The individual operations for installing the appliance are described under the instructions for the installer.
- Have the appliance installed and connected by a qualified person with specialist knowledge, who will carry it out in accordance with the directives.
- If any modifications to the power supply are required because of the installation, these should also be carried out by a qualified electrician.
- It is dangerous to make modifications of any kind to this appliance or to its specifications.
- During the baking, roasting and grilling process, the oven window and the other parts of the appliance get hot, so children should be kept away from the appliance. Take care, if connecting electrical appliances to sockets near the oven, that cables do not come into contact with hot rings or get caught in the oven door.
- Always use oven gloves to take hot oven-proof dishes or pots out of the oven.
- Regular cleaning prevents the surface material from deteriorating.

Operation

- This oven is designed for cooking foodstuffs; never use it for other purposes.
- **When opening the oven door during or at the end of cooking be careful of the stream of hot air, which comes out of the oven.**
- Be very careful when using the cooker. The extreme heat of the heating elements makes the shelves and other parts very hot.
- If you should for whatever reason use aluminium foil to cook food in the oven, never allow it to come into direct contact with the floor of the oven.
- When cleaning the oven, proceed with care: never spray anything onto the grease filter (if fitted), the heating elements and the thermostat sensor.
- Before cleaning the oven, either turn the power off or pull the mains plug out.
- Make sure that the oven is in the "OFF" position, when the oven is no longer being used.
- This oven was made as a single appliance or as a combination appliance with electrical hotplate, depending on the model, for single-phase connection to 230 V.
- The appliance must not be cleaned with a superheated steam cleaner or a steam jet cleaner.
- Do not use abrasive cleaners or sharp metal scrapers. These can scratch the glass in the oven door, which may result in the shattering of the glass.

Child Safety

- This appliance is intended for use by adults. It is dangerous to allow children to use it or play with it.
- Children should be kept away while the oven is working. Also, after you have switched the oven off, it remains hot for a long time.
- This appliance is not intended for use by children or other persons whose physical, sensory or mental capabilities or lack of experience and knowledge prevents them from using the appliance safely without supervision or instruction by a responsible person to ensure that they can use the appliance safely.

Customer Service

- Have checks and/or repairs carried out by the manufacturer's service department or by a service department authorised by the manufacturer and use only original spare parts.
- Do not attempt to repair the appliance yourself in the event of malfunctions or damage. Repairs carried out by untrained persons may cause damage or injury.

The symbol  on the product or its packaging

indicates that this product is not to be treated as normal household waste. Instead it must be handed over to a collection point for the recycling of electrical and electronic equipment. The correct disposal of this product will help to protect the environment and human health. Environment and health are endangered by incorrect disposal. For more detailed information about recycling of this product, please contact your local town hall, your household waste disposal service or the shop where you purchased the product.

Description of the appliance

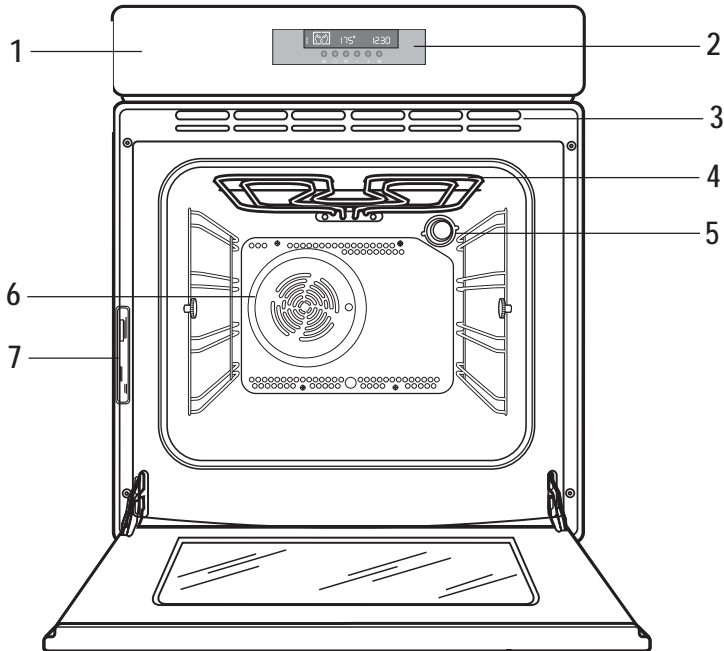

- | | |
|------------------------------|-----------------|
| 1. Control Panel | 5. Oven light |
| 2. Electronic programmer | 6. Oven Fan |
| 3. Air Vents for Cooling Fan | 7. Rating plate |
| 4. Grill | |

Oven accessories

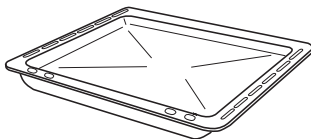

Dripping pan

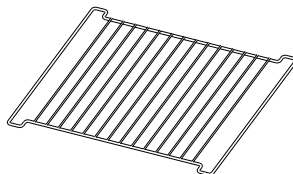

Shelf

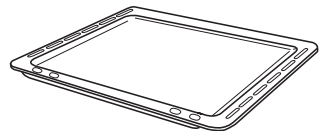

2 x Cake tray

Control panel

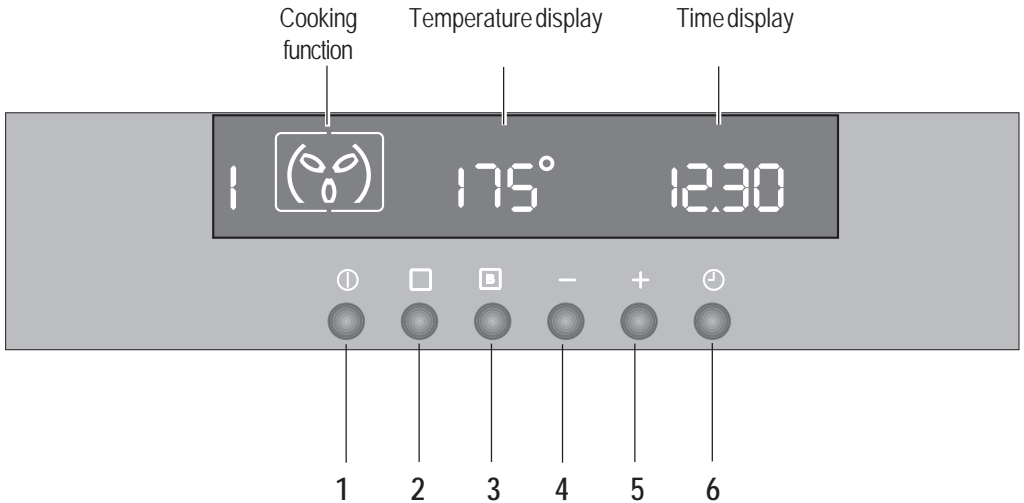

Push buttons

1. ON / OFF
2. Oven Function Control
3. Fast Heat Up Function
4. Decreasing Control "—" (Time or Temperature)
5. Increasing Control "+" (Time or Temperature)
6. Minute minder / Cooking duration function / End of cooking function

All the oven functions are controlled by an electronic programmer.

You can select any combination of cooking function, cooking temperature and automatic timing.

NOTE

In the event of a power failure, the programmer will keep all the settings (time of day, programme setting or programme in operation) for about 3 minutes. If power fails for a longer time, all the settings will be cancelled. When the power is restored, the numbers in the display will flash, and the clock/timer has to be reset.



When the oven is first installed

 *Remove **all packaging**, both inside and outside the oven, before using the oven.*



When the oven is first connected to the electrical supply, the display will automatically show 12:00 and the symbol  will flash.

Ensure the correct time of day is set before using the oven.

To set the correct time of day:

a) press button  and, while the symbol  is flashing (Fig. 1), set the correct time of day by pressing buttons "—" or "+" (Fig. 2).

The time arrow symbol  will disappear about 5 seconds after the correct time is displayed (Fig. 3).

b) if the symbol  is not flashing anymore, press button  twice.

Then, proceed as described in point a).

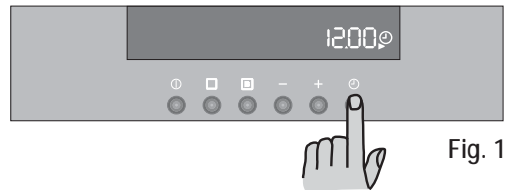

Fig. 1

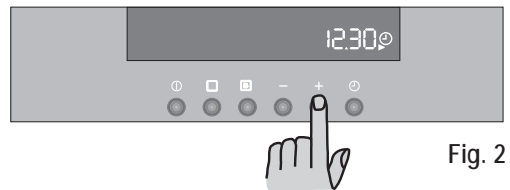

Fig. 2



Fig. 3

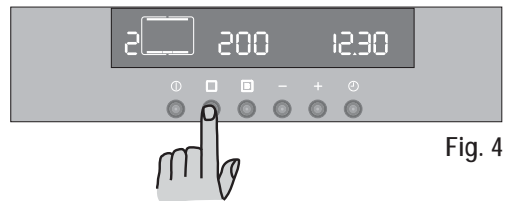







Fig. 4

Before first use

The oven should be heated without food.

To do that, proceed as follows:

- press button  to switch on the oven.
- press button  twice and select the "Conventional Cooking" function  (Fig. 4).
- set the temperature to 250 °C using the increasing push button "+".
- Allow the oven to run **empty** for approximately 45 minutes.
- open a window for ventilation.

This procedure should be repeated with the "Fan Cooking"  and "Full Grill"  function for approximately 5-10 minutes.

i During this time, an unpleasant odour may be emitted. This is absolutely **normal**, and is caused by residues of manufacturing.

Once this operation is carried out, let the oven cool down, then clean the oven cavity with a soft cloth soaked in warm water to which a little mild washing-up liquid has been added.

i Before cooking for the first time, carefully wash the **shelves** and the **baking tray**.

! To open the oven door, always hold the handle in the centre (Fig. 5).

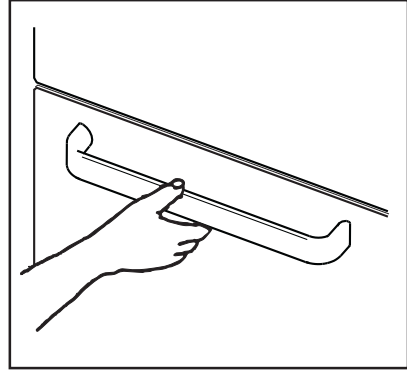

Fig.5

"On/Off" Push Button

The oven must be switched on before setting any cooking function or programme. When button **ⓘ** is pressed, the oven symbol will appear in the display, and the oven light will switch on.

To switch off the oven, you can press button **ⓘ** at any time. Any cooking function or programme will stop, the oven light will switch off and the time display will show the time of day only.

It is possible to switch off the oven at any time.

How to select a Cooking Function

1) Switch on the oven by pressing the **ⓘ** button.

2) Press button **□** to select the required oven function. Each time button **□** is pressed, a cooking symbol will appear in the display and the corresponding cooking function number will appear to the left of the currently selected cooking function symbol (Fig. 6).

3) If the pre-set temperature is not suitable, press button "**-**" or "**+**" to adjust the temperature in 5 degree steps.

- as soon as the oven heats up, the thermometer

symbol rises slowly **🌡**, indicating the degree to which the oven is currently heated;

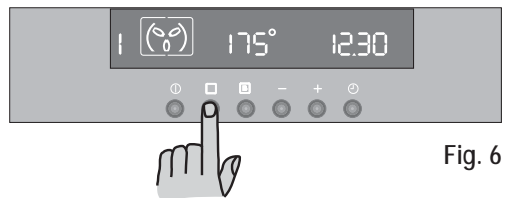



Fig. 6

When the required temperature is reached, an acoustic alarm will sound for a short time and the thermometer symbol  will illuminate permanently.

How to set the temperature and cooking time

Press button “-” and “+” to increase or decrease the pre-set temperature while the “°” symbol is flashing (Fig. 7). The maximum temperature is 250°C.

Press button “-” and “+” to increase or decrease the pre-set cooking time while the symbol  is flashing (Fig. 7).

Safety Thermostat

To prevent dangerous overheating (through incorrect use of the appliance or defective components), the oven is fitted with a safety thermostat, which interrupts the power supply. The oven switches back on again automatically, when the temperature drops.

Should the safety thermostat trigger due to incorrect use of the appliance, it is enough to remedy the error after the oven has cooled down; if on the other hand, the thermostat triggers because of a defective component, please contact Customer Service.

The cooling fan

The cooling fan is designed to cool the the oven and the control panel. The fan switches on automatically after a few minutes of cooking. Warm air is blown out through the aperture near the oven door handle. When the oven is switched off, the fan may run on after the oven is switched off to keep the controls cool. This is quite normal.



The action of the cooling fan will depend on how long the oven has been used and at what temperature. It may not switch in at all at lower temperature settings nor run on where the oven has only been used for a short time.

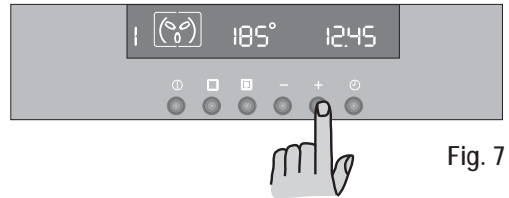











Fig. 7

Function Symbols

- 1  **Fan cooking** - This setting allows you to roast or roast and bake simultaneously using any shelf, without flavour transference. Pre-set temperature: 175 °C
- 2  **Conventional cooking** - The heat comes from both the top and bottom element, ensuring even heating inside the oven. Pre-set temperature: 200 °C
- 3  **Inner Grill** - can be used for grilling small quantities. Pre-set temperature: 250 °C
- 4  **Thermal Grilling** - This function offers an alternative method of cooking food items, normally associated with conventional grilling. The grill element and the oven fan operate together, circulating hot air around the food. Pre-set temperature: 180 °C
Select a maximum temperature of 200°C.
- 5  **Pizza Oven** - The bottom element provides direct heat to the base of pizzas, quiches or pies, while the fan ensures air is circulated to cook the pizza toppings or pie fillings. Pre-set temperature: 175 °C
- 6  **Full Grill** - The full grill element will be on. Recommended for large quantities. Pre-set temperature: 250 °C
- 7  **Bottom heating element** - The heat comes from the bottom of the oven only, to allow you to finish your dishes. Pre-set temperature: 250 °C
- 8  **Top heating element** - The heat comes from the top of the oven only, to allow you to finish your dishes. Pre-set temperature: 250 °C
- 9  **Defrosting** – The oven fan operates without heat and circulates the air, at room temperature, inside the oven. This function is particularly suitable for defrosting delicate food which could be damaged by heat, e.g. cream filled gateaux, iced cakes, pastries, bread and other yeast products.

Using the oven

The oven is supplied with an exclusive system which produces a natural circulation of air and the constant recycling of steam.

This system makes it possible to cook in a steamy environment and keep the dishes soft inside and crusty outside. Moreover, the cooking time and energy consumption are reduced to a minimum. During cooking steam may be produced which can be released when opening the oven door. This is absolutely normal.



However, always stand back from the oven when opening the oven door during cooking or at the end of it to allow any build up of steam or heat to release.



Attention! - Do not place objects on the oven base and do not cover any part of the oven with aluminium foil while cooking, as this could cause a heat build-up which would affect the baking results and damage the oven enamel. Always place pans, heat-resisting pans and aluminium trays on the shelf which has been inserted in the shelf runners. When food is heated, steam is created, like in a kettle. When the steam comes into contact with the glass in the oven door, it condenses and creates water droplets.

To reduce condensation, always preheat the empty oven for 10 minutes.

We recommend you wipe the water droplets away after every cooking process.



Always cook with the oven door closed. Stand clear when opening the drop down oven door. **Do not** allow it to fall open - support the door using the door handle, until it is fully open.

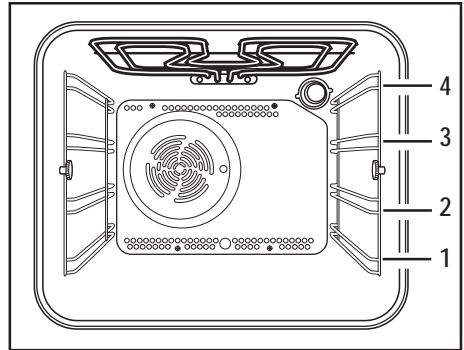



The oven has four shelf levels, and is supplied with two shelves. The shelf positions are counted from the bottom of the oven as shown in the diagram.

It is important that these shelves are correctly positioned as shown in the diagram.

Do not place cookware directly on the oven base.

Fan cooking

The air inside the oven is heated by the element around the fan situated behind the back panel. The fan circulates hot air to maintain an even temperature inside the oven.

The advantages of cooking with this function are:

Faster Preheating

As the fan oven quickly reaches temperature, it is not usually necessary to preheat the oven although you may find that you need to allow an extra 5-7 minutes on cooking times. For recipes which require higher temperatures, best results are achieved if the oven is preheated first, e.g. bread, pastries, scones, souffles, etc.

Lower Temperatures

Fan oven cooking generally requires lower temperatures than conventional cooking. Follow the temperatures recommended in the cooking chart. Remember to reduce temperatures by about 20-25 °C for your own recipes which use conventional cooking.

Even Heating for Baking

The fan oven has uniform heating on all shelf positions. This means that batches of the same food can be cooked in the oven at the same time. However, the top shelf may brown slightly quicker than the lower one.

This is quite usual. There is no mixing of flavours between dishes.

How to use the fan oven



1. Switch the oven on.
2. Press the Oven Function Control button and select the "Fan Cooking" function.
3. If necessary adjust temperature setting using the "+" or "-" buttons.

Conventional Cooking

- The middle shelf position allows for the best heat distribution. To increase base browning simply lower the shelf position. To increase top browning, raise the shelf position.
- The material and finish of the baking trays and dishes used will affect base browning. Enamelware, dark, heavy or non-stick utensils increase base browning, while oven glassware, shiny aluminium or polished steel trays reflect the heat away and give less base browning.
- Always place dishes centrally on the shelf to ensure even browning.
- Stand dishes on suitably sized baking trays to prevent spillage onto the base of the oven and make cleaning easier.
- **Do not** place dishes, tins or baking trays directly on the oven base as it becomes very hot and damage will occur. When using this setting, heat comes from both the top and bottom elements. This allows you to cook on a single level and is particularly suitable for dishes which require extra base browning such as quiches and flans.

Gratins, lasagnes and hotpots which require extra top browning also cook well in the conventional oven.

How to use the conventional oven

1. Switch the oven ON.
2. Select the Conventional Oven Function by pressing the Oven Function control button  until the symbol  appears in the display.

Top oven element only

This function is suitable for finishing cooked dishes, e.g. lasagne, shepherds pie, cauliflower cheese etc.

Bottom oven element only

This function is particularly useful when blind-baking pastry. It may also be used to finish off quiches or flans to ensure the base pastry is cooked through.

Grilling

- Most foods should be placed on the grid in the grill pan to allow maximum circulation of air and to lift the food out of the fats and juices. Food such as fish, liver and kidneys may be placed directly on the grill pan, if preferred.
- Food should be thoroughly dried before grilling to minimise splashing. Brush lean meats and fish lightly with a little oil or melted butter to keep them moist during cooking.
- Accompaniments such as tomatoes and mushrooms may be placed underneath the grid when grilling meats
- When toasting bread, we suggest that the top runner position is used.
- The food should be turned over during cooking, as required.

How to use the Full Grill

1. Switch the oven ON.
2. Select the Full Grill function by pressing the Oven

Function control button  until the symbol  appears in the display.



3. If necessary adjust temperature setting using the "+" or "-" buttons.
4. Adjust the grid and grill pan runner position to allow for different thicknesses of food. Position the food close to the element for faster cooking and further away for more gentle cooking.

Preheat the grill on a full setting for a few minutes before sealing steaks or toasting. Adjust the heat setting and the shelf as necessary, during cooking.

During cooking, the cooling fan and the thermostat control light will operate in the same way as described for the fan oven function.

How to use the Inner Grill Element



The inner grill provides quick direct heat to the central area of the grill pan. By using the inner grill element for cooking small quantities, it can help to save energy.

1. Switch the oven ON.
2. Select the Inner Grill Element by pressing the Oven Function control button  until the symbol  appears on the display.
3. If necessary adjust temperature setting using the "+" or "-" buttons.
4. Adjust the grid and grill pan runner position to allow for different thicknesses of food and follow the instructions for grilling.

How to Use the Thermal Grill

Thermal grilling offers an alternative method of cooking food items normally associated with conventional grilling. The grill element and the oven fan operate alternately, circulating hot air around the food. The need to check and turn the food is reduced. Thermal grilling helps to minimise cooking smells in the kitchen.

With the exception of toast and rare steaks, you can thermally grill all the foods you would normally cook under a conventional grill. Cooking is more gentle, therefore food generally takes a little longer to cook with thermal grilling compared with conventional grilling. One of the advantages is that larger quantities can be cooked at the same time.



1. Switch the oven ON.
2. Select the Thermal Grill Oven Function by pressing the Oven Function control button  until the symbol  appears on the display.
3. If necessary, press "+" or "-" buttons. to adjust the temperature setting.

- Adjust the grid and grill pan runner position to allow for different thicknesses of food and follow the instructions for grilling.

Pizza Oven

The bottom element provides direct heat to the base of pizzas, quiches or pies, while the fan ensures air is circulated to cook the pizza toppings or pie fillings.



To obtain the best results use the lower shelf levels.

- Switch the oven ON.
- Select the Pizza Oven Function by pressing the Oven Function control button  until the symbol  appears on the display.
- If necessary, press "+" or "-" buttons to adjust the temperature setting.

Defrosting

The oven fan operates without heat and circulates the air, at room temperature, inside the oven. This increases the speed of defrosting. However, please note that the temperature of the kitchen will influence the speed of defrosting. This function is particularly suitable for defrosting delicate food which could be damaged by heat, e.g. cream filled gateaux, iced cakes, pastries, bread and other yeast products.

How to Use Defrosting

- Switch the oven on by pressing button .
- Select the Defrosting Oven Function by pressing the Oven Function control button  until the symbol  appears in the display.
- The display will show the indication "def".

Hints and Tips

On baking:

Cakes and pastries usually require a medium temperature (150°C-200°C) and therefore it is

necessary to preheat the oven for about 10 minutes.

Do not open the oven door before 3/4 of the baking time has elapsed.

Shortcrust pastry is baked in a springform tin or on a tray for up to 2/3 of the baking time and then garnished before being fully baked. This further baking time depends on the type and amount of topping or filling. Sponge mixtures must separate with difficulty from the spoon. The baking time would be unnecessarily extended by too much liquid.

If two baking trays with pastries or biscuits are inserted into the oven at the same time, a shelf level must be left free between the trays.

If two baking trays with pastries or biscuits are inserted into the oven at the same time, the trays must be swapped and turned around after about 2/3 of the baking time.

On Roasting:

Do not roast joints smaller than 1 kg. Smaller pieces could dry out when roasting. Dark meat, which is to be well done on the outside but remain medium or rare inside, must be roasted at a higher temperature (200°C-250°C).

White meat, poultry and fish, on the other hand, require a lower temperature (150°C-175°C). The ingredients for a sauce or gravy should only be added to the roasting pan right at the beginning if the cooking time is short. Otherwise add them in the last half hour.

You can use a spoon to test whether the meat is cooked: if it cannot be depressed, it is cooked through. Roast beef and fillet, which is to remain pink inside, must be roasted at a higher temperature in a shorter time.

If cooking meat directly on the oven shelf, insert the roasting pan in the shelf level below to catch the juices.

Leave the joint to stand for at least 15 minutes, so that the meat juices do not run out.

To reduce the build up of smoke in the oven, it is

recommended to pour a little water in the roasting pan. To prevent condensation forming, add water several times. The plates can be kept warm in the oven at minimum temperature until serving.



Caution!

Do not line the oven with aluminium foil and do not place a roasting pan or baking tray on the floor, as otherwise the oven enamel will be damaged by the heat build-up.

Cooking times



Cooking times can vary according to the different composition, ingredients and amounts of liquid in the individual dishes.

Note the settings of your first cooking or roasting experiments to gain experience for later preparation of the same dishes.

Based upon your own experiences you will be able to alter the values given in the tables.

Programming the Oven

How to set the minute minder

- 1) Press button  to select the Minute Minder function (Fig. 8). The relevant  symbol will flash and the control panel will display "0.00".
- 2) Press button "+" to select the required time. Maximum time is 23 hours 59 minutes. After it has been set, the Minute Minder will wait 3 seconds and then start running (Fig. 9).
- 3) When the programmed time has elapsed, an acoustic alarm will be heard.
- 4) To switch off the acoustic alarm, press any button.

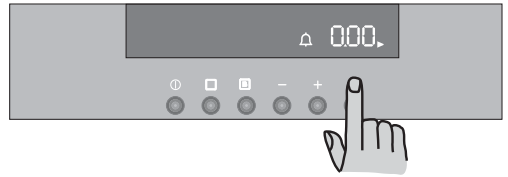

Fig. 8





 The oven will NOT switch off if in use. The Minute Minder function can also be used as well when the oven is off.



Fig. 9

To use or to change the Minute Minder setting:

press button  until the symbols  and  flash. It is now possible to change the Minute Minder setting by pressing button "-" or "+".

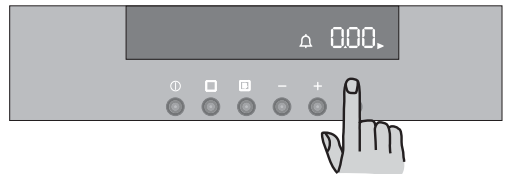







Fig. 10

To cancel the Minute Minder:

press button  until the symbols  and  flash. Press button "-" to decrease the time until "0.00" is displayed (Fig. 10).

To programme the Oven to switch off

- 1) Place food in the oven, switch on the oven, select a cooking function and adjust the cooking temperature, if required (Fig. 11).
- 2) Press button  to select the "Cooking Duration" function (Fig. 12). The "Cooking Duration" symbol  will flash and the control panel will display "0.00".

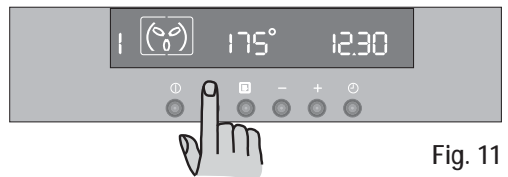

Fig. 11

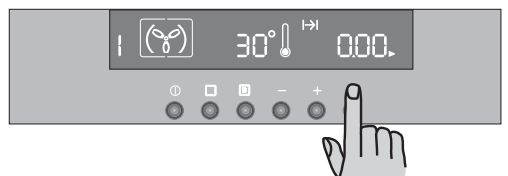

Fig. 12

- 3) While the symbol ► is flashing, press button "+" to select the required time. Maximum time is 23 hours 59 minutes. The programmer will wait 3 seconds and then start running.
- 4) When cooking time is over, the oven will be switched off automatically and an acoustic alarm will be heard while the control panel will display "0.00".
- 6) To switch off the acoustic alarm, press any button.

To cancel the Cooking Duration Time:

- press button ⏸ until the symbol ► will flash.
- press button "-" to decrease the time until "0.00" is displayed (Fig. 13).

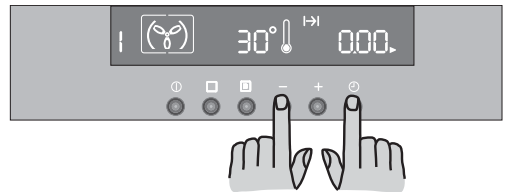

Fig. 13

To Programme the Oven to Switch On and Off

- 1) Carry out the "Cooking Duration" setting as described in the relevant chapter.
- 2) Press button ⏸ until the "End of Cooking" function →| is selected and the relevant symbol flashes. The control panel will display the end of cooking time (that is, the actual time + cooking duration time - Fig. 14).
- 3) Press button "+" to select the required end of cooking time.
- 4) After this is set, the programmer will wait 3 seconds and then start running.
- 5) The oven will switch on and off automatically. The end of cooking will be marked by an acoustic alarm.
- 6) To switch off the acoustic alarm, press any button.

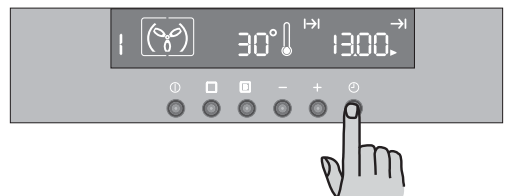

Fig. 14

To cancel the programme, simply cancel the Duration Time.

Safety and Energy Saving Functions

Safety Cut-Off Function

The oven will switch off automatically if any change of setting is made, according to the table below (Fig. 15).

If temperature setting is:	the oven will switch off:
250°C	after 3 hours
from 200 up to 245°C	after 5,5 hours
from 120 up to 195°C	after 8,5 hours
less than 120°C	after 12 hours

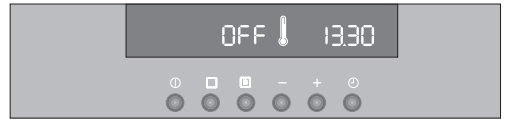

Fig. 15

Residual Heat Function

When a Cooking Duration time is set, the oven will automatically switch off a few minutes before the end of the programmed time, and use the residual heat to finish your dishes without energy consumption. All current settings will be displayed until the Cooking Duration time is over.

This function will not operate when the Cooking Duration time is less than 15 minutes.

Child Safety Function

To avoid children switching on the oven, it is possible to lock the oven controls.





- 1) Turn off the oven by pressing button .
- 2) Press buttons  and "" at the same time and keep them pressed for about 3 seconds. An acoustic signal will be emitted and the indication 'SAFE' will appear on the display (Fig. 16).
- 3) The oven is now locked. Neither oven functions nor temperatures can be selected.



Fig. 16

To unlock the oven:

Press buttons  and “-” at the same time and keep them pressed for about 3 seconds. An acoustic signal will be emitted and the indication ‘SAFE’ will go off. The oven can now be operated (Fig. 17).

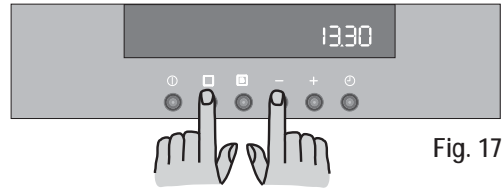





Fig. 17

"Fast Heat Up" function

After a cooking function has been selected and the temperature has been adjusted, the cavity will gradually heat up until the selected temperature is reached. This will take from 10 to 15 minutes, depending on selected function and temperature. If it is necessary to reach the required temperature in a shorter time, the "Fast Heat Up" Function can be used.

- 1) Switch the oven on by pressing button .
- 2) Set the required cooking function and temperature as explained in the previous pages.
- 3) Set the temperature by pressing button “-” or “+”. The temperature will appear on the display.
- 4) Press button . The temperature display will show "FHU" (Fig. 18).
- 5) press button  and the symbol “°” will flash for approximately 10 seconds. Now it is possible to select the required temperature by pressing button “-” or “+”.
- 4) When the required temperature is reached, an acoustic alarm will sound for a short time, and the temperature display will revert to the set temperature.

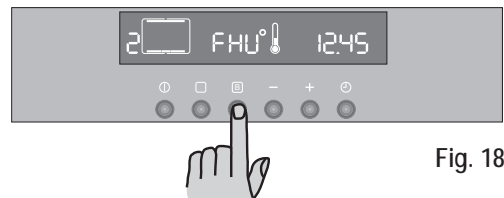





Fig. 18

This function can be used with any cooking function or temperature.

Demo mode

This mode is intended to be used in shops to demonstrate the oven functionality without any power consumption except the interior light, the display and the fan. This function can only be switched on when the appliance is first connected.

If there is a power failure, when the power supply is restored again, the Demo function can only be switched on if in the display 12:00 and the symbol  are flashing automatically.

1. Press the  button for approximately 2 seconds. An acoustic alarm will sound for a short time.
2. Press the  and "—" buttons at the same time. A short acoustic alarm will be heard and the time 12:00 will appear in the display (Fig. 19).

When the oven is switched on the symbol  appears in the display. This means that the Demo function is activated.

All oven functions can be selected.

The oven is not really working and the heating elements do not switch on.

Switch off the oven and follow the procedure described above to switch off the demo mode again.

 The Demo function remains saved in the programme in the event of a power failure.

Error code

The electronic programmer does a continuous diagnostic check of the system. If some parameters are not correct, the control unit will stop the activated functions and it will show on the display the corresponding error code (Fig. 20).

For further details, refer to chapter "Something not working".

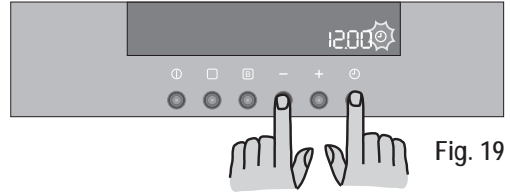

Fig. 19





Fig. 20

Baking and Roasting Table

Conventional Cooking and Fan Cooking



Timings do not include pre-heating.
The empty oven should always be pre-heated for 10 minutes.

TYPE OF DISH	Conventional Cooking		Fan Cooking		Cooking times in minutes ⌚	NOTES
	 temp °C	temp °C	 temp °C	temp °C		
CAKES						
Whisked recipies	2	170	2 (1and3)*	160	45-60	In cake mould
Shortbread dough	2	170	2 (1and3)*	160	20-30	In cake mould
Butter-milk cheese cake	1	175	2	165	60-80	In cake mould
Apple cake (Apple pie)	1	170	2lef+righ.	160	90-120	In cake mould
Strudel	2	180	2	160	60-80	In baking tray
Jam- tart	2	190	2(1and3)*	180	40-45	In cake mould
Fruit cake	2	170	2	150	60-70	In cake mould
Sponge cake	1	170	2(1and3)*	165	30-40	In cake mould
Christmas cake	1	150	2	150	120-150	In cake mould
Plum cake	1	175	2	160	50-60	In bread tin
Small cake	3	170	2	160	20-35	In baking tray
Biscuits	2	160	2(1and3)*	150	20-30	In baking tray
Meringues	2	135	2(1and3)*	150	60-90	In baking tray
Buns	2	200	2	190	12-20	In baking tray
Pastry: Choux	2or 3	210	2(1and3)*	170	25-35	In braking tray
Plate tarts	2	180	2	170	45-70	In cake mould
BREAD AND PIZZA						
White bread	1	195	2	185	60-70	
Rye bread	1	190	1	180	30-45	In bread tin
Bread rolls	2	200	2(1and3)*	175	25-40	In baking tray
Pizza	2	200	2	200	20-30	In baking tray
FLANS						
Pasta flan	2	200	2(1and3)*	175	40-50	In mould
Vegetable flan	2	200	2(1and3)*	175	45-60	In mould
Quiches	1	210	1	190	30-40	In mould
Lasagne	2	200	2	200	25-35	In mould
Cannelloni	2	200	2	200	25-35	In mould
MEAT						
Beef	2	190	2	175	50-70	On grid
Pork	2	180	2	175	100-130	On grid
Veal	2	190	2	175	90-120	On grid
English roast beef						
rare	2	210	2	200	50-60	On grid
medium	2	210	2	200	60-70	On grid
well done	2	210	2	200	70-80	On grid
Shoulder of pork	2	180	2	170	120-150	With rind
Shin of pork	2	180	2	160	100-120	2 pieces
Lamb	2	190	2	175	110-130	Leg
Chicken	2	190	2	200	70-85	Whole
Turkey	2	180	2	160	210-240	Whole
Duck	2	175	2	220	120-150	Whole
Goose	2	175	1	160	150-200	Whole
Rabbit	2	190	2	175	60-80	Cut in pieces
Hare	2	190	2	175	150-200	Cut in pieces
Pheasant	2	190	2	175	90-120	Whole
Meat loaf	2	180	2	170	tot.150	in bread pan
FISH						
Trout/Sea bream	2	190	2(1and3)*	175	40-55	3-4 fishes
Tuna fish/Salmon	2	190	2(1and3)*	175	35-60	4-6 fillets

(* If you cook more than one dish at the same time, we recommend you place them on the levels quoted between brackets.

Conventional Grilling



Timings do not include pre-heating.
The empty oven should always be pre-heated for 10 minutes.

TYPE OF DISH	Quantity		Grilling		Cooking time in minutes	
	Pieces	g.		temp. °C	1st side	2nd side
Fillet steaks	4	800	3	250	12-15	12-14
Beef-steaks	4	600	3	250	10-12	6-8
Sausages	8	/	3	250	12-15	10-12
Pork chops	4	600	3	250	12-16	12-14
Chicken (cut in two)	2	1000	3	250	30-35	25-30
Kebabs	4	/	3	250	10-15	10-12
Chicken (breast)	4	400	3	250	12-15	12-14
Hamburger*	6	600	2	250	20-30	
*Preheat 5'00"						
Fish (fillets)	4	400	3	250	12-14	10-12
Sandwiches	4-6	/	3	250	5-7	/
Toast	4-6	/	3	250	2-4	2-3

Thermal Grilling



With Fan Cooking plus set a maximum temperature of 200°C.

TYPE OF DISH	Quantity		Thermal Grilling		Cooking time in minutes	
	Pieces	g.		temp. °C	1st side	2nd side
Rolled joints (turkey)	1	1000	3	200	30-40	20-30
Chicken (cut in two)	2	1000	3	200	25-30	20-30
Chicken legs	6	-3	200	15-20	15-18	
Quail	4	500	3	200	25-30	20-25
Vegetable gratin	--	--	3	200	20-25	--
St. Jacques shells	--	-3	200	15-20	--	
Mackerel	2-4	-3	200	15-20	10-15	
Fish slices	4-6	800	3	200	12-15	8-10

Pizza Function

TYPE OF DISH	Pizza Function		Cooking time in minutes	NOTES
		temp. °C		
Pizza , large	1	200	15-25	on baking tray
Pizza , small	1	200	10-20	on baking tray or on grid
Bread rolls	1	200	15-25	on baking tray



The temperatures quoted are guidelines. The temperatures may have to be adapted to personal requirements.

Cleaning and Maintenance



Before cleaning switch the oven off and let it cool down.

The appliance must not be cleaned with a superheated steam cleaner or a steam jet cleaner.

Important: Before carrying out any cleaning operation, the appliance must be disconnected from the power supply.

To ensure a long life for your appliance, it is necessary to perform the following cleaning operations regularly:

- Only perform when the oven has cooled down.
- Clean the enamelled parts with soapy water.
- Do not use abrasive cleaners.
- Dry the stainless steel parts and glass with a soft cloth.
- If there are stubborn stains, use commercially available for stainless steel or warm vinegar.

The oven's enamel is extremely durable and highly impermeable. The action of hot fruit acids (from lemons, plums or similar) can however leave permanent, dull, rough marks on the surface of the enamel. However such marks in the brightly polished surface of the enamel does not affect the operation of the oven. Clean the oven thoroughly after every use. This is the easiest way to clean dirt off. It prevents dirt being burnt on.

Cleaning materials

Before using any cleaning materials on your oven, check that they are suitable and that their use is recommended by the manufacturer.

Cleaners that contain bleach should NOT be used as they may dull the surface finishes. Harsh abrasives should also be avoided.

External cleaning

Regularly wipe over the control panel, oven door and door seal using a soft cloth well wrung out in warm water to which a little liquid detergent has been added.

To prevent damaging or weakening the door glass panels avoid the use of the following:

- Household detergent and bleaches
- Impregnated pads unsuitable for non-stick saucepans
- Steel wool pads
- Chemical oven pads or aerosols
- Rust removers
- Bath/Sink stain removers

Clean the outer and inner door glass using warm soapy water. Should the inner door glass become heavily soiled it is recommended that a cleaning product such as Hob Brite is used. Do not use paint scrapers to remove soilage.



DO NOT clean the oven door while the glass panels are warm. If this precaution is not observed the glass panel may shatter.



If the door glass panel becomes chipped or has deep scratches, the glass will be weakened and must be replaced to prevent the possibility of the panel shattering. Contact your local Service Force Centre who will be pleased to advise further.

Oven Cavity

The enamelled base of the oven cavity is best cleaned whilst the oven is still warm.

Wipe the oven over with a soft cloth soaked in warm soapy water after each use. From time to time it will be necessary to do a more thorough cleaning, using a proprietary oven cleaner.

Grill heating element

This model has been fitted with a hinged grill element to make the roof of the oven especially easy to clean.



Before proceeding ensure the oven is cool and disconnected from the electricity supply.

- 1) Undo the screw fastening the grill element (see Fig). When carrying out this operation for the first time, we recommend using a screwdriver.
- 2) Then gently pull the grill downwards to allow access to the oven roof (see Fig).
- 3) Clean the oven roof with a suitable cleaner and wipe dry before returning the hinged grill element to its original position.
- 4) Carefully push the grill element up into its original position and re-tighten the retaining nut.



Ensure the retaining nut on the grill element is properly tightened so that it does not fall down when in use.

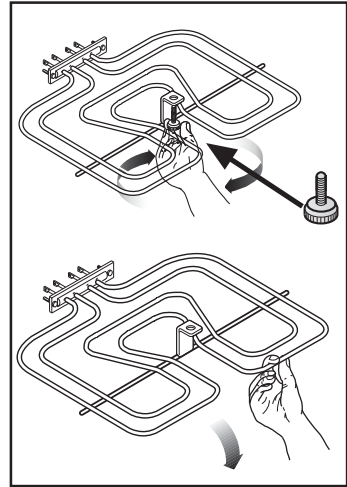

Cleaning the Oven Door

Before cleaning the oven door, we recommend you to remove it from the oven.

Proceed as follows:

1. open the oven door completely;
2. find the hinges linking the door to the oven (Fig. A);
3. unlock and turn the small levers located on the two hinges (Fig. B);
4. handle the door by its left- and right-hand sides, then slowly turn it towards the oven until it is half-closed (Fig. C);
5. gently pull the oven door off its site (Fig. C);
6. place it on a steady plan;

Clean the oven door glass with warm soapy water and a soft cloth only. Never use harsh abrasives. Once the cleaning is carried out, refit the oven door, following the procedure in reverse.

Stainless steel or aluminium appliances:

We recommend that the oven door is only cleaned using a wet sponge and dried after cleaning with a soft cloth.

Never use steel wool, acids or abrasive products as they can damage the oven surface. Clean the oven control panel following the same precautions.



DO NOT clean the oven door while the glass panels are warm. If this precaution is not observed the glass panel may shatter.

If the door glass panel becomes chipped or has deep scratches, the glass will be weakened and must be replaced to prevent the possibility of the panel shattering. Contact your local Service Centre who will be pleased to advise further.

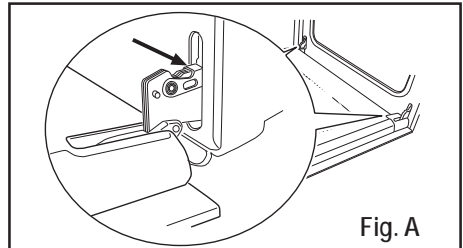

Fig. A

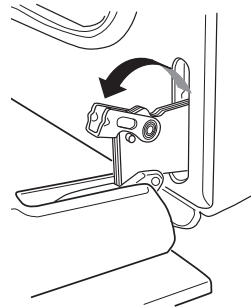

Fig. B

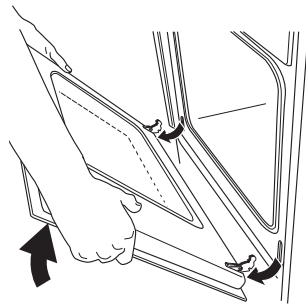

Fig. C

Replacing The Oven Light

Disconnect the appliance

If the oven bulb needs replacing, it must comply with the following specifications:

- Electric power: 15 W/25 W,
- Electric rate: 230 V (50 Hz),
- Resistant to temperatures of 300°C,
- Connection type: E14.

These bulbs are available from your local Service Force Centre.

To replace the faulty bulb:

1. Ensure the oven is isolated from the electrical supply.
2. Push in and turn the glass cover anticlockwise.
3. Remove the faulty bulb and replace with the new one.
4. Refit the glass cover and restore the electrical supply.

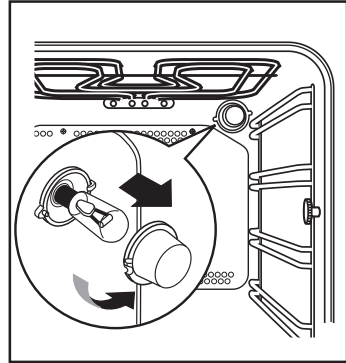

If something is wrong

If the appliance is not working correctly, please check the following before contacting the Electrolux Service Centre:

PROBLEM	SOLUTION
<ul style="list-style-type: none"> ■ The oven is not switching on. 	<ul style="list-style-type: none"> ◆ Touch the ⓘ control, then select a cooking function. <li style="text-align: center;"><i>or</i> ◆ Has the fuse in the domestic electrical installation been tripped? <li style="text-align: center;"><i>or</i> ◆ Is the child safety device or the automatic On/Off cut-off function switched on? <li style="text-align: center;"><i>or</i> ◆ Was the Demo function accidentally activated? <li style="text-align: center;"><i>or</i> ◆ Check whether the appliance is correctly connected and the socket switch or the mains supply to the oven is ON.
<ul style="list-style-type: none"> ■ The oven light does not come on. 	<ul style="list-style-type: none"> ◆ Set the oven function dial to a function. <li style="text-align: center;"><i>or</i> ◆ Buy a new oven light bulb; if necessary, order from the Electrolux Service Centre and install according to the instructions in these User Instructions.
<ul style="list-style-type: none"> ■ It takes too long to cook the dishes or they cook too quickly. 	<ul style="list-style-type: none"> ◆ Following the advice contained in these instructions, especially the section "Practical Tips".
<ul style="list-style-type: none"> ■ Steam and condensation settle on the food and in the oven cavity. 	<ul style="list-style-type: none"> ◆ When the cooking process is completed, do not leave the dishes standing in the oven for longer than 15-20 minutes.
<ul style="list-style-type: none"> ■ The error code "F.." appears in the display". 	<ul style="list-style-type: none"> ◆ Please take note of the error code and pass to our nearest Customer Service office.

Technical Data

Heating element ratings

Bottom oven element	1000 W
Top heating element	800 W
Full oven (Top+Bottom)	1800 W
Grill	1650 W
Full grill	2450 W
Fan Cooking heating	2000 W
Pizza function	3000 W
Oven light	25 W
Hot air fan motor	25 W
Cooling fan motor	25 W
Total rating	3075 W
Operating voltage (50 Hz)	230 V
Appliance Class	3

Dimensions of the recess

Height	under top	mm 593
	in column	mm 580
Width		mm 560
Depth		mm 550

Oven

Height	mm 335
Width	mm 395
Depth	mm 400
Oven capacity	53 l

Instructions for the Installer



Installation and connection must be done in compliance with the regulations in force. Any interventions must be carried out when the appliance is switched off. Only accredited engineers may work on the appliance.

The manufacturer disclaims any liability if the safety measures are not observed.

Connecting to the electrical supply

Before connecting to the electrical supply, please make sure:

- The fuse and the domestic electrical installation must be designed for the max. load of the appliance (see rating plate).
- The domestic electrical installation must be equipped with a proper earth connection in accordance with the regulations in force.
- The socket or the multi-pole off switch must be easy to access after the appliance has been installed.

The appliance is supplied with the plug attached. The mains cable and plug as supplied are to be connected to a shockproof socket (230 V~, 50 Hz). The shockproof socket must be installed in accordance with the regulations.

The following types of mains cable are suitable, taking the necessary rated cross section into account: H07 RN-F, H05 RN-F, H05 RR-F, H05 VV-F, H05 V2V2-F (T90), H05 BB-F.

If the appliance is connected without a plug, or if the plug is not accessible, a multi-pole off switch (e.g. fuses, circuit breaker) with a minimum gap of 3 mm between the contacts must be installed between the appliance and mains cable. The switch must not interrupt the earth wire at any point. The yellow-green earth wire should be 2-3 cm longer than all other cables.

The connection cable must in any case be laid out so that at no point does it reach 50°C (over room temperature).

After the connection has been carried out, the heating elements must be tested by being operated for about 3 minutes.

Terminal block

The oven is fitted with an easily accessible terminal block which is designed to operate with a single-phase power supply of 230 V.

Letter L - Live terminal
Letter N - Neutral terminal

 or E - Earth terminal

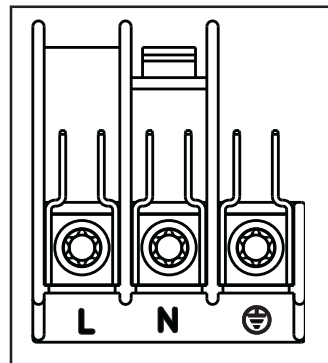

Instructions for Building In

For problem-free functioning of the built-in appliance, the kitchen unit or the recess into which the appliance is built must have suitable dimensions.

In accordance with the regulations in force, all parts which ensure the shock protection of live and insulated parts must be fastened in such a way that they cannot be undone without tools.

These also include the fixing of any end walls at the beginning or end of a line of built-in units.

The shock protection must in any case be ensured by the building in of the appliance.

The appliance can be placed with its back or a side wall against higher kitchen units, appliances or walls. However, only other appliances or units of the same height as the appliance can be placed against the other side wall.

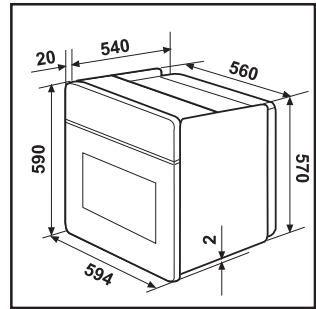

Fig. A

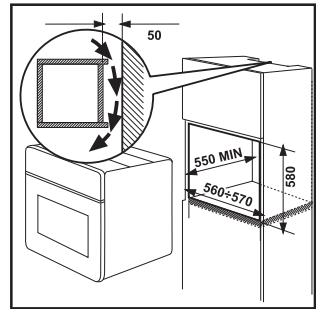

Fig. B

Oven dimensions (Fig. A)

Instructions for Building In

For problem-free functioning of the built-in appliance, the kitchen unit or the recess into which the appliance is built must have suitable dimensions (Fig. B-C).

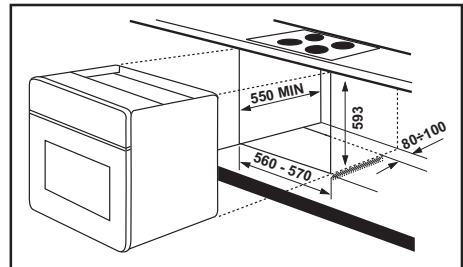

Fig. C

Securing the Appliance to the Cabinet

- Open the oven door;
- fasten the oven to the cabinet placing the four distance holders provided with the appliance (Fig. D - A) which fit exactly into the holes in the frame and then fit four wood screws (Fig. D - B).

When installing a hob over the oven, the hob electrical connection and the oven one have to be carried out separately for security reasons and to let the oven be taken off the cabinet easier, if necessary. Any extensions must be made with cables suitable for the required power.

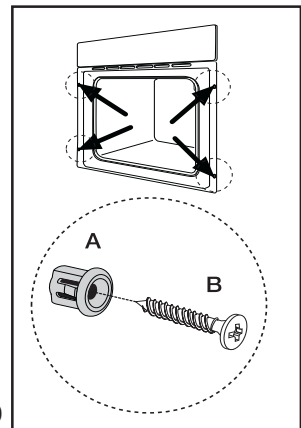

Fig. D

Declaration of guarantee terms

Our appliances are produced with the greatest of care. However, a defect may still occur. Our consumer services department will repair this upon request, either during or after the guarantee period. The service life of the appliance will not, however, be reduced as a result.

This declaration of guarantee terms is based on European Union Directive 99/44/EC and the provisions of the Civil Code. The statutory rights that the consumer has under this legislation are not affected by this declaration of guarantee terms.

This declaration does not affect the vendor's statutory warranty to the end user. The appliance is guaranteed within the context of and in adherence with the following terms:

1. In accordance with provisions laid down in paragraphs 2 to 15, we will remedy free of charge any defect that occurs within 24 months from the date the appliance is delivered to the first end user. These guarantee terms do not apply in the event of use for professional or equivalent purposes.
2. Performing the guarantee means that the appliance is returned to the condition it was in before the defect occurred. Defective parts are replaced or repaired. Parts replaced free of charge become our property.
3. So as to avoid more severe damage, the defect must be brought to our attention immediately.
4. Applying the guarantee is subject to the consumer providing proof of purchase showing the purchase and/or delivery date.
5. The guarantee will not apply if damage caused to delicate parts, such as glass (vitreous ceramic), synthetic materials and rubber, is the result of inappropriate use.
6. The guarantee cannot be called on for minor faults that do not affect the value or the overall reliability of the appliance.
7. The statutory warranty does not apply when defects are caused by:
 - a chemical or electrochemical reaction caused by water,
 - abnormal environmental conditions in general,
 - unsuitable operating conditions,
 - contact with harsh substances.
8. The guarantee does not apply to defects due to transport which have occurred outside of our responsibility. Nor will the guarantee cover those caused by inadequate installation or assembly, lack of maintenance or failure to respect the assembly instructions or directions for use.
9. Defects that result from repairs or measures carried out by people who are not qualified or expert or defects that result from the addition of non-original accessories or spare parts are not covered by the guarantee.
10. Appliances that are easy to transport may be delivered or sent to the consumer services department. Home repairs are only anticipated for bulky appliances or built-in appliances.
11. If the appliances are built-in, built-under, fixed or suspended in such a way that removing and replacing them in the place where they are fitted takes more than half an hour, the costs that result therefrom will be charged for. Connected damage caused by these removal and replacement operations will be the responsibility of the user.
12. If, during the guarantee period, repairing the same defect repeatedly is not conclusive, or if the repair costs are considered disproportionate, in agreement with the consumer, the defective appliance may be replaced with another appliance of the same value.
In this event, we reserve the right to ask for a financial contribution calculated according to the length of time it has been used.

13. A repair under guarantee does not mean that the normal guarantee period will be extended nor that a new guarantee period begins.
14. We give a twelve month guarantee for repairs, limited to the same defect.
15. Except in the event where liability is legally imposed, this declaration of guarantee terms excludes any compensation for damage outside the appliance for which the consumer wishes to assert his rights. In the event of legally admitted liability, compensation will not exceed the purchase price paid for the appliance.

These guarantee terms are only valid for appliances purchased and used in Belgium. For exported appliances, the user must first make sure that they satisfy the technical conditions (e.g.: voltage, frequency, installation instructions, etc.) for the country concerned and that they can withstand the local climatic and environmental conditions. For appliances purchased abroad, the user must first ensure that they meet the qualifications required in Belgium. Non-essential or requested adjustments are not covered by the guarantee and are not possible in all cases.

Our consumer services department is always at your disposal, even after the guarantee period has expired.

Address for our consumer services department:
BELGIUM

Electrolux Home Products Belgium	Consumer services	Tel: 02/363.04.44	Fax: 02/363.04.00 02/363.04.60
ELECTROLUX SERVICE			
Bergensesteenweg 719			
1502 Lembeek			
E-mail: consumer.services@electrolux.be			

GRAND-DUCHÉ DE LUXEMBOURG

ELECTROLUX HOME PRODUCTS	Consumer services	0035242431-1	0035242431-360
Rue de Bitbourg, 7			
L-1273 Luxembourg-Hamm			
E-mail: consumer-service.luxembourg@electrolux.lu			

European Guarantee

This appliance is guaranteed by Electrolux in each of the countries listed at the back of this user manual, for the period specified in the appliance guarantee or otherwise by law. If you move from one of these countries to another of the countries listed below the appliance guarantee will move with you subject to the following qualifications:

- The appliance guarantee starts from the date you first purchased the appliance which will be evidenced by production of a valid purchase document issued by the seller of the appliance.
- The appliance guarantee is for the same period and to the same extent for labour and parts as exists in your new country of residence for this particular model or range of appliances.
- The appliance guarantee is personal to the original purchaser of the appliance and cannot be transferred to another user.
- The appliance is installed and used in accordance with instructions issued by Electrolux and is only used within the home, i.e. is not used for commercial purposes.
- The appliance is installed in accordance with all relevant regulations in force within your new country of residence.

The provisions of this European Guarantee do not affect any of the rights granted to you by law.

www.electrolux.com

<input checked="" type="checkbox"/>		
Albania	+35 5 4 261 450	Rr. Pjeter Bogdani Nr. 7 Tirane
Belgique/België/Belgien	+32 2 363 04 44	Bergensesteenweg 719, 1502 Lembeek
Česká republika	+420 2 61 12 61 12	Budějovická 3, Praha 4, 140 21
Danmark	+45 70 11 74 00	Sjællandsgade 2, 7000 Fredericia
Deutschland	+49 180 32 26 622	Muggenhofer Str. 135, 90429 Nürnberg
Eesti	+37 2 66 50 030	Mustamäe tee 24, 10621 Tallinn
España	+34 902 11 63 88	Carretera M-300, Km. 29,900 Alcalá de Henares Madrid
France	www.electrolux.fr	
Great Britain	+44 8705 929 929	Addington Way, Luton, Bedfordshire LU4 9QQ
Hellas	+30 23 10 56 19 70	4, Limnou Str., 54627 Thessaloniki
Hrvatska	+385 1 63 23 338	Slavonska avenija 3, 10000 Zagreb
Ireland	+353 1 40 90 753	Long Mile Road Dublin 12
Italia	+39 (0) 434 558500	C.so Lino Zanussi, 26 - 33080 Porcia (PN)
Latvija	+37 17 84 59 34	Kr. Barona iela 130/2, LV-1012, Riga
Lituania	+370 5 27 80 609	Verkių 29, 09108 Vilnius, Lithuania
Luxembourg	+35 2 42 43 13 01	Rue de Bitbourg, 7, L-1273 Hamm
Magyarország	+36 1 252 1773	H-1142 Budapest XIV, Erzsébet királyné útja 87
Nederland	+31 17 24 68 300	Vennootsweg 1, 2404 CG - Alphen aan den Rijn
Norge	+47 81 5 30 222	Risløkkvn. 2, 0508 Oslo
Österreich	+43 18 66 400	Herziggasse 9, 1230 Wien
Polska	+48 22 43 47 300	ul. Kolejowa 5/7, Warsaw
Portugal	+35 12 14 40 39 39	Quinta da Fonte - Edifício Gonçalves Zarco - Q 35 -2774-518 Paço de Arcos
Romania	+40 21 451 20 30	B-dul Timisoara 90, S6, Bucharest
Schweiz - Suisse - Svizzera	+41 62 88 99 111	Industriestrasse 10, CH-5506 Mägenwil
Slovenija	+38 61 24 25 731	Electrolux Ljubljana d.o.o., Gerbičeva 98, 1000 Ljubljana
Slovensko	+421 2 43 33 43 22	Electrolux Slovakia s.r.o., Electrolux Domáce spotrebiče SK, Seberíniho 1, 821 03 Bratislava
Suomi	www.electrolux.fi	
Sverige	+46 (0)771 76 76 76	Electrolux Service, S:t Göransgatan 143, S-105 45 Stockholm
Türkiye	+90 21 22 93 10 25	Tarlabası caddesi no : 35 Taksim İstanbul
Россия	+7 095 937 7837	129090 Москва, Олимпийский проспект, 16, БЦ "Олимпик"

Free Manuals Download Website

<http://myh66.com>

<http://usermanuals.us>

<http://www.somanuals.com>

<http://www.4manuals.cc>

<http://www.manual-lib.com>

<http://www.404manual.com>

<http://www.luxmanual.com>

<http://aubethermostatmanual.com>

Golf course search by state

<http://golfingnear.com>

Email search by domain

<http://emailbydomain.com>

Auto manuals search

<http://auto.somanuals.com>

TV manuals search

<http://tv.somanuals.com>