

EN

User manual

Oven

USER MANUAL

ZOD580

la vita è bella
ZANUSSI

ITALIAN SINCE 1916

Contents

Safety information	2	Care and cleaning	16
Product description	4	What to do if.	18
Before first use	4	Installation	19
Daily use	5	Environment concerns	22
Clock functions	7	GREAT BRITAIN & IRELAND - Guarantee/Customer	
Using the accessories	8	Service	22
Helpful hints and tips	8		

Subject to change without notice

Safety information

Before the installation and use, read this manual carefully:

- For your personal safety and the safety of your property
- For the respect of the environment
- For the correct operation of the appliance.

Always keep these instructions with the appliance also if you move or sell it.

The manufacturer is not responsible if incorrect installation or use results in damage.

Children and vulnerable people safety

- This appliance can be used by children aged from 8 years and above and persons with reduced physical, sensory or mental capabilities or lack of experience and knowledge if they have been given supervision or instruction concerning use of the appliance in safe way and understand the hazards involved. Children shall not play with the appliance.
- Keep all packaging away from children. There is the risk of suffocation or physical injury.
- **WARNING:** Keep children and animals away from the appliance when the door is open or the appliance is in the operation, because it becomes hot. There is the risk of injury or other permanent disability.
- If the appliance has Child Lock or Key Lock (Control Lock) function, use it. It prevents children and animals from accidental operation of the appliance.

General safety

- Do not change the specifications of this appliance. There is the risk of injury and damage to the appliance.
- Do not let the appliance stay unattended during operation.
- Switch off the appliance after each use.

Installation

- Only an approved electrician can install and connect the appliance. Contact an approved service centre. This is to prevent the risks of structural damage or physical injury.
- Make sure that the appliance is not damaged because of transport. Do not connect a damaged appliance. If necessary, contact the supplier.
- Remove all packaging, stickers and layers from the appliance before first use. Do not remove the rating plate. It can invalidate the guarantee.
- Make sure that the appliance is disconnected from the power supply during the installation.
- Be careful when you move the appliance. The appliance is heavy. Always use safety gloves. Do not lift the appliance by the handle.
- The electrical installation must have an isolation device which lets you disconnect the appliance from the mains at all poles. The isolation device must have a contact opening width of minimum 3 mm.
- You must have correct isolation devices: line protecting cut-outs, fuses (screw type fuses removed from the holder), earth leakage trips and contactors.
- Before the installation, make sure that the kitchen cabinet has the recess dimensions applicable.
- Make sure that the appliance is installed below and adjacent safe structures.
- Keep the minimum distances to the other appliances and units.
- The appliance cannot be positioned on a base.
- Built in ovens and built in cooking surfaces are attached with special connection system. To prevent damage

to the appliance, only use an appliance with the appliances from the same manufacturer.

Electrical connection

- The appliance must be earthed.
- Make sure that the electrical data on the rating plate agree with your domestic power supply.
- Information on the voltage is on the rating plate.
- Always use a correctly installed shockproof socket.
- Do not use multi-way plugs, connectors and extension cables. There is the risk of fire.
- Do not replace or change the mains cable. Contact the service centre.
- Make sure not to squash or cause damage to the mains plug (if applicable) and cable behind the appliance.
- Do not pull the mains cable to disconnect the appliance. Always pull the mains plug – if applicable.

Use

- The appliance is only for domestic use. Do not use the appliance for commercial and industrial use.
- Only use the appliance for domestic cooking tasks. This is to prevent physical injury to persons or prevent damage to property.
- Do not use the appliance as a work surface or storage surface.
- The interior of the appliance becomes hot during use. There is the risk of burns. Do not touch the heating elements in the appliance. Use gloves when you insert or remove the accessories or pots.
- Be careful when you remove or install the accessories to prevent damage to the oven enamel.
- Always stay away from the appliance when you open the door while the appliance is in operation. Hot steam can release. There is the risk of skin burns.
- To prevent damage or discoloration to the enamel:
 - do not put any objects directly on the appliance floor and do not cover it with aluminium foil;
 - do not put hot water directly into the appliance;
 - do not keep moist dishes and food in the appliance after you finish the cooking.
- Discoloration of the enamel has no effect on the performance of the appliance so it is not a defect in the sense of the warranty law.
- Do not apply pressure on the open door.

- Always close the appliance door when you cook, even while grilling.

Care and cleaning

- Before maintenance, switch off the appliance and disconnect the appliance from the power supply.
- Before maintenance, make sure that the appliance is cold. There is the risk of burns. There is the risk that the glass panels can break.
- Keep the appliance clean at all times. A build-up of fats or other foodstuff can result in a fire.
- Regular cleaning prevents the surface material from deteriorating
- Use a deep baking tray for very moist cakes to prevent that fruit juices cause stains that can be permanent.
- For your personal safety and the safety of your property, only clean the appliance with water and a soap. Do not use flammable products or products that can cause corrosion.
- Do not clean the appliance with steam cleaners, high-pressure cleaners, sharp objects, abrasive cleaning agents, abrasive sponges and stain removers
- If you use an oven spray, follow the instructions from the manufacturer.
- Do not clean the glass door with abrasive cleaning agents or metal scraper. Heat resistant surface of the inner glass can break and shatter.
- When the door glass panels are damaged they become weak and can break. You must replace them. Contact the service centre.
- Be careful when you remove the door from the appliance. The door is heavy!
- Do not clean catalytic enamel (if applicable).

Risk of fire

- Open the door carefully. The use of ingredients with alcohol can cause a mixture of alcohol and air. There is the risk of fire.
- Do not let sparks or open flames come near the appliance when you open the door.
- Do not put flammable products or items that are wet with flammable products, and/or fusible objects (made of plastic or aluminium) in, near or on the appliance.

Oven lamp

- Bulb lamps used in this appliance are special lamps selected for household appliances use only. They can-

not be used for the full or partial illumination of a household room.

- If it becomes necessary to replace the lamp use one of the same power and specifically designed for household appliances only.
- Disconnect the appliance from the power supply before the replacement of the oven lamp. There is the risk of electrical shock.

Service centre

- Only an approved engineer can repair or work on the appliance. Contact an approved service centre.

Product description

General overview

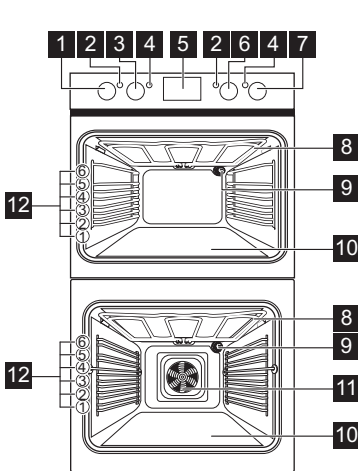

- Use only original spare parts.

Disposal of the appliance

- To prevent the risk of physical injury or damage
 - Disconnect the appliance from the power supply.
 - Cut off the mains cable and discard it.
 - Discard the door catch. This prevents children or small animals from being closed inside of the appliance. There is the risk of suffocation.

- 1 Knob for the top oven functions
- 2 Power indicator
- 3 Knob for the top oven temperature
- 4 Temperature indicator
- 5 Electronic programmer
- 6 Knob for the main oven functions
- 7 Knob for the main oven temperature
- 8 Heating element
- 9 Oven lamp
- 10 Heating element
- 11 Fan and rear wall heating element
- 12 Shelf positions

Oven accessories

- **Oven shelf**
For cookware, cake tins, roasts.
- **The roasting pan grid**

To put in the deep roasting pan.

- **Deep roasting pan**
To bake and roast or as pan to collect fat.

Before first use

Warning! Refer to "Safety information" chapter.

Initial Cleaning

- Remove all parts from the appliance.
- Clean the appliance before first use.

Important! Refer to chapter "Care and Cleaning".

Setting the time

i The oven only operates after time set.

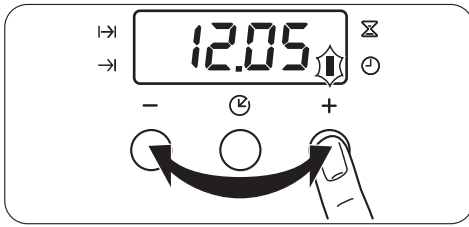

When you connect the appliance to the electrical supply or in case of a power cut, the Time function indicator flashes automatically.

To set the current time use "+" or "-" button. After approximately 5 seconds, the flashing stops and the display shows the time of day set.

i For time change you must not set an automatic function (Duration I->I or End →|) at the same time.

To use the appliance, push the control knob. The control knob comes out.

Daily use

Warning! Refer to "Safety information" chapter.

Cooling fan

When the appliance operates, the cooling fan switches on automatically. If you switch off the appliance, the cooling fan continues to operate until the appliance cools down.



Activating and deactivating the top oven

1. Turn the knob for the top oven functions to an oven function.
2. Turn the knob for the top oven temperature to a temperature. The power indicator comes on while the appliance operates. The temperature indicator comes on while the temperature in the appliance increases.

Top oven functions

Oven function	Application
0	OFF position
	Light

Pre-heating





1. Set function  and maximum temperature.
2. Let the appliance operate without the food for approximately 1 hour.
3. Set function  and maximum temperature.
4. Let the appliance operate without the food for approximately 10 minutes.
5. Set function  and maximum temperature.
6. Let the appliance operate without the food for approximately 10 minutes.

This is to burn off the residue in the appliance. The accessories can become more hot than usually. When you pre-heat the appliance for the first time, the appliance can make an odour and smoke. This is the usual effect. Make sure the airflow is sufficient.









3. To deactivate the appliance, turn the knob for the top oven functions and the knob for the top oven temperature to the Off position.

Activating and deactivating the main oven

1. Turn the knob for the main oven functions to an oven function. The power indicator comes on while the appliance operates. The temperature indicator comes on while the temperature in the appliance increases.
2. Turn the knob for the main oven temperature to a temperature. The power indicator comes on while the appliance operates. The temperature indicator comes on while the temperature in the appliance increases.
3. To deactivate the appliance, turn the knob for the main oven functions and the knob for the main oven temperature to the Off position.

Oven function		Application
	Conventional Cooking	To bake and roast on one level
	Top Heat	To brown bread, cakes and pastries and for bakes.
	Bottom Heat	To bake cakes with crispy or crusty bases and to preserve food.
	Single Circuit Grill	To grill flat food items in small quantities in the middle of the grill. To make toast.
	Dual Circuit Grill	To grill flat food items in large quantities. To make toast.

Main Oven Functions

Oven function		Application
	OFF position	The appliance is OFF.
	Light	To light up the oven interior.
	Thermaflow®	To roast or roast and bake the food that requires the same cooking temperature, using more than one shelf, without flavour transference.
	Thermal Grilling	To roast larger joints of meat or poultry on one level. Also to gratinate and brown.
	Single Circuit Grill	To grill flat food in the middle of the grill and to toast.
	Dual Circuit Grill	To grill flat food in large quantities and to toast.
	Conventional Cooking	To bake and roast on one oven level.
	Bottom Heat	To bake cakes with crispy or crusty bases and to preserve food.
	Defrost	To defrost frozen food.

Clock functions

Electronic programmer

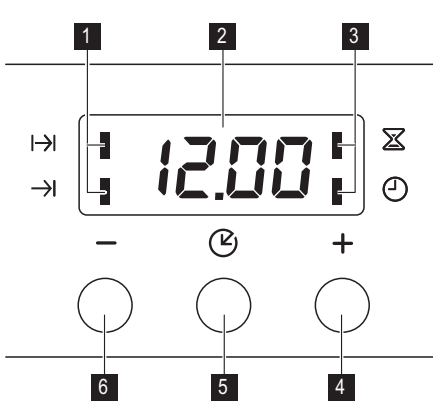

- 1 Function Indicators
- 2 Time display
- 3 Function Indicators
- 4 Button "+"
- 5 Selector Button
- 6 Button "-"

Clock function		Application
	Time of day	Shows the time. To set, change or check the time.
	Minute minder	To set a countdown time. A signal sounds, after the time period is completed. This function has no effect on the operation of the oven.
	Duration	To set how long the oven has to be in operation.
	End	To set the switch-off time for an oven function.

i Duration and End can be used at the same time, if the oven is to be switched on and off automatically later. In this case first set Duration , then End .

Setting the clock functions

- Set an oven function and temperature (not necessary for Minute Minder).
- Push the Selection button again and again until the indicator for necessary clock function flashes.



- To set the time for Minute minder , Duration or End , push "+" or "-" button. The indicator for related clock function comes on. When the time period ends, the indicator for the clock function flashes and an acoustic signal sounds for 2 minutes.
- i** With the functions Duration and End the appliance deactivates automatically.
- Push any button to stop the signal.
- Turn the knob for the oven function and the knob for the temperature to the Off position.

Cancelling the clock functions

- Press the Selection button again and again until the indicator for the necessary function flashes.
- Press and hold the button "-" until an acoustic signal sounds.

3. Release the button. The clock function goes out in some seconds.

Using the accessories

Warning! Refer to "Safety information" chapter.

Inserting the oven accessories

Put in the slide-in accessories so that the double side edges are at the back of the oven and point down to the bottom. Push the slide-in accessories between the guide-bars of one of the oven levels.

i The deep roasting pan and the oven shelf have double side edges. These edges and the shape of the guide-bars causes the anti-tilt safety for the oven accessories.

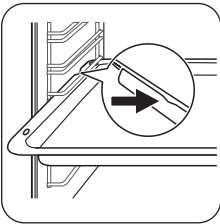

Inserting the oven shelf and deep roasting pan together

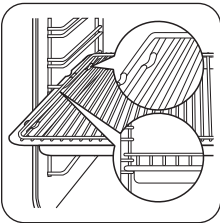

Put the oven shelf on the deep roasting pan. Push the deep roasting pan between the guide-bars of one of the oven levels.

Helpful hints and tips

Warning! Refer to "Safety information" chapter.

i The temperature and baking times in the tables are guidelines only. They depend on the recipes, quality and quantity of the ingredients used.

Caution! Use a deep baking tray for very moist cakes. Fruit juices can cause permanent stains on the enamel.

Grilling set

The grilling set includes the roasting pan grid and the deep roasting pan. You can use the roasting pan grid on the two sides.

Warning! Risk of burns when removing the accessories from a hot oven.

You can use the grilling set to roast larger pieces of meat or poultry on one level:

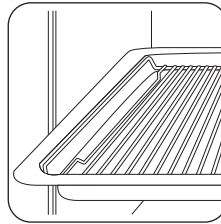

Put the roasting pan grid inside the deep roasting pan so that the supports of the oven shelf point upwards.

You can use the grilling set to grill flat dishes in large quantities and to toast:

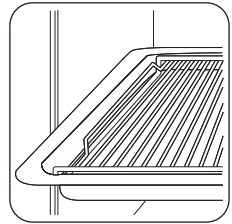

Put the roasting pan grid inside the deep roasting pan so that the supports of the oven shelf point downwards.

Put the deep roasting pan in the oven at the necessary level.

Top oven

The top oven is the smaller of the two ovens. It has 6 shelf levels. Use is to cook smaller quantities of food. It gives especially good results when used to cook fruitcakes, sweets and savoury flants or quiche.

Main oven

The main oven is particularly suitable for cooking larger quantities of food.

Baking

General instructions

- Your new oven may bake or roast differently to the appliance you had before. Adapt your usual settings (temperature, cooking times) and shelf levels to the values in the tables.
- With longer baking times, the oven can be switched off about 10 minutes before the end of baking time, to use the residual heat.

When you use frozen food, the trays in the oven can twist during baking. When the trays get cold again, the distortion will be gone.

Tips on baking

Baking results	Possible cause	Remedy
The cake is not browned sufficiently below	Incorrect oven level	Put the cake on a lower oven level
The cake sinks (becomes soggy, lumpy, streaky)	Oven temperature too high	Use a lower setting
The cake sinks (becomes soggy, lumpy, streaky)	Baking time is too short	Set a longer baking time Do not set higher temperatures to decrease baking times
The cake sinks (becomes soggy, lumpy, streaky)	Too much liquid in the mixture	Use less liquid. Look at the mixing times, specially when you use mixing machines
Cake is too dry	Oven temperature too low	Set a higher oven temperature
Cake is too dry	Baking time too long	Set a shorter baking time
Cake does not brown equally	Oven temperature too high and baking time too short	Set a lower oven temperature and a longer baking time
Cake does not brown equally	No equal mixture	Put the mixture equally on the baking tray
Cake does not cook in the baking time set	Temperature too low	Use a slightly higher oven temperature setting

Top oven

Baking

 Shelf Positions are not critical but ensure that oven shelves are evenly spaced when more than one is used (e.g. shelf positions 1 and 3)

How to use the Baking Tables

- We recommend to use the lower temperature the first time.
- If you cannot find the settings for a special recipe, look for the one that is almost the same.
- Baking time can be extended by 10-15 minutes, if you bake cakes on more than one level.
- Cakes and pastries at different heights do not always brown equally at first. If this occurs, do not change the temperature setting. The differences equalize during the baking procedure.

Food	Temperature [°C]	Approx Cook Time (mins)	Shelf Position
Biscuits	170 - 190	10 - 20	1
Bread	200 - 220	30 - 35	1
Bread rolls/buns	200 - 220	10 - 15	1
Cakes:			
- Small & Queen	170 - 180	18 - 25	1
- Sponges	160 - 175	20 - 30	1
- Victoria Sandwich	160 - 170	18 - 25	1
- Madeira	140 - 150	75 - 90	1
- Rich Fruit	140 - 150	120 - 150	1
- Gingerbread	140 - 150	75 - 90	1
- Meringues	90 - 100	150 - 180	1
- Flapjack	160 - 170	25 - 30	1
- Shortbread	130 - 150	45 - 65	1
Casseroles:			
- Beef/Lamb	150 - 170	150 - 180	1
- Chicken	160 - 180	75 - 90	1
Convenience Foods	Follow manufacturer's instructions.		
Fish	170 - 190	20 - 30	1
Fish Pie (Potato Topped)	190 - 200	20 - 30	1
Fruit Pies, Crumbles	190 - 200	30 - 50	1
Milk Puddings	150 - 170	90 - 120	1
Pasta Lasagne etc.	170 - 180	40 - 50	1
Pastry:			
- Choux	180 - 190	30 - 40	1
- Eclairs, Profiteroles	180 - 190	30 - 40	1
- Flaky/Puff Pies	210 - 220	30 - 40	1
Shortcrust:			
- Mince Pies	190 - 200	15 - 20	1
- Meat Pies	190 - 210	25 - 35	1
- Quiche, Tarts, Flans	180 - 200	25 - 50	1
Scones	220 - 230	8 - 12	1
Shepard's Pie	190 - 200	30 - 40	1
Soufflés	180 - 190	20 - 30	1

Food	Temperature [°C]	Approx Cook Time (mins)	Shelf Position
Vegetables:			
- Baked Jacket Potatoes	180 - 190	60 - 90	1
- Roast Potatoes	180 - 190	60 - 90	1
Yorkshire Pudding:			
- Large	200 - 210	25 - 40	1
- Individual	210 - 220	15 - 25	1
Roasting Meat, Poultry	See roasting chart.		

Main oven

Baking

 Shelf Positions are not critical but ensure that oven shelves are evenly spaced when more than one is used (e.g. shelf positions 1 and 3)

Food	Temperature [°C]	Approx Cook Time (mins)
Biscuits	180 - 190	10 - 20
Bread	190 - 210	30 - 35
Cakes:		
- Small & Queen	160 - 170	18 - 25
- Sponges	160 - 170	20 - 25
- Madeira	140 - 160	60 - 75
- Rich Fruit	130 - 140	120 - 150
- Christmas	130 - 140	180 - 270
Fish	160 - 180	20 - 30
Fruit Pies, Crumbles	170 - 180	30 - 50
Milk Puddings	140 - 160	60 - 90
Pastry:		
- Choux	180 - 190	30 - 40
- Shortcrust	180 - 190	25 - 35
- Flaky	180 - 190	30 - 40
- Puff	Follow manufacturer's instructions; Reduce the temperature for Fan oven by 20°C	
Plate Tarts	180 - 190	25 - 45
Quiches/Flans	170 - 180	25 - 45

Food	Temperature [°C]	Approx Cook Time (mins)
Scones	210 - 230	8 - 12
Roasting: Meat and Poultry	160 - 180	see Roasting Chart

Baking

Food	Temperature [°C]	Approx Cook Time (mins)	Shelf Position
Biscuits	180 - 190	10 - 20	3
Bread	200- 220	30 - 35	3
Cakes:			
- Small & Queen	170 - 180	18 - 25	3
- Sponges	170 - 180	20 - 25	3
- Madeira	150 - 160	60 - 75	3
- Rich Fruit	140 - 150	120 - 150	3
- Christmas	140 - 150	180 - 270	3
Fish	170 - 180	20 - 30	3
Fruit Pies, Crumbles	180 - 200	30 - 50	3
Milk Puddings	150 - 170	60 - 90	3
Pastry:			
- Choux	180 - 190	30 - 40	3
- Shortcrust	190 - 200	25 - 35	3
- Flaky	190 - 210	30 - 40	3
- Puff	Follow manufacturer's instructions		
Plate Tarts	190 - 200	25 - 45	3
Quiches/Flans	200 - 210	25 - 45	3
Scones	220 - 230	8 - 12	3
Roasting: Meat and Poultry	170 - 190	see Roasting Chart	3

Roasting

Roasting dishes

- Use heat-resistant ovenware to roast (please read the instructions of the manufacturer).
- Large roasting joints can be roasted directly in the deep roasting pan or on the oven shelf above the deep roasting pan. (If present)

- Roast lean meats in a roasting tin with a lid. This will keep the meat more succulent.
- All types of meat, that can be browned or have crackling, can be roasted in the roasting tin without the lid.

Main oven

Roasting

Meat	Temperature [°C]	Cooking Time
Beef/ Beef boned	160 - 180	20-35 minutes per ½ kg (1lb) and 20-35 minutes over
Mutton/ Lamb	160 - 180	20-35 minutes per ½ kg (1lb) and 20-35 minutes over
Pork/ Veal/ Ham	160 - 180	30-40 minutes per ½ kg (1lb) and 30-40 minutes over
Chicken	160 - 180	15-20 minutes per ½ kg (1lb) and 20 minutes over
Turkey/ Goose	160 - 180	15-20 minutes per ½ kg (1lb) and 20 minutes over
Duck	160 - 180	25-35 minutes per ½ kg (1lb) and 25-30 minutes over
Pheasant	160 - 180	35-40 minutes per ½ kg (1lb) and 35-40 minutes over
Rabbit	160 - 180	20 minutes per ½ kg (1lb) and 20 minutes over

Grilling

Always use the grilling function with maximum temperature setting

Important! Always grill with the oven door closed

 Always pre-heat the empty oven with the grill functions for 5 minutes.

- Set the shelf in the shelf level as recommended in the grilling table.

- Always set the pan to collect the fat into the first shelf level.
- Grill only flat pieces of meat or fish.

Top oven

Grilling

 Adjust shelf position and grill pan grid to suit different thicknesses of food

Food	Grill Time (mins in total)
Bacon Rashers	5- 6
Beefburgers	10 - 20
Chicken Joints	20 - 40

Food	Grill Time (mins in total)
Chops	
- Lamb	15 - 25
- Pork	20 - 25
Fish - Whole Trout/ Makarel	10 - 12
Filletts - Plaice/Cod	4 - 6
Kebabs	12 - 18
Kidneys - Lamb/Pig	6 - 10
Sausages	20 - 30
Steaks	
- Rare	4 - 6
- Medium	6 - 8
- Well Done	12 - 15
Toasted Sandwiches	3 - 4

Main oven

Grilling

 Adjust shelf position and grill pan grid to suit different thicknesses of food

Food	Grill Time (mins in total)
Bacon Rashers	5 - 6
Beefburgers	10 - 20
Chicken Joints	20 - 40
Chops	
- Lamb	15 - 25
- Pork	20 - 25
Fish - Whole Trout/ Makarel	10 - 12
Filletts - Plaice/Cod	4 - 6
Kebabs	12 - 18
Kidneys - Lamb/Pig	6 - 10
Sausages	20 - 30
Steaks	

Food	Grill Time (mins in total)
- Rare	4 - 6
- Medium	6 - 8
- Well Done	12 - 15
Toasted Sandwiches	3 - 4

Grilling

Beef

Type of meat	Quantity	Level	Temperature (°C)	Time (h:min)
Topside beef or fillet				per cm of thickness
- rare ¹⁾	per cm of thickness	1	190 - 200	0:05 - 0:06
- medium	per cm of thickness	1	180 - 190	0:06 - 0:08
- well done	per cm of thickness	1	170 - 180	0:08 - 0:10

1) Pre-heat oven

Pork

Type of meat	Quantity	Level	Temperature (°C)	Time (h:min)
Shoulder, neck, ham	1 - 1.5 kg	1	160 - 180	1:30 - 2:00
Pork chop	1 - 1.5 kg	1	160 - 180	1:00 - 1:30
Meatloaf	750 g - 1 kg	1	160 - 170	0:45 - 1:00
Knuckle of pork (pre-cooked)	750 g - 1 kg	1	150 - 170	1:30 - 2:00

Veal

Type of meat	Quantity	Level	Temperature (°C)	Time (h:min)
Roast veal	1 kg	1	160 - 180	1:30 - 2:00
Knuckle of veal	1.5 - 2 kg	1	160 - 180	2:00 - 2:30

Lamb

Type of meat	Quantity	Level	Temperature (°C)	Time (h:min)
Roast lamb, leg of lamb	1 - 1.5 kg	1	150 - 170	1:15 - 2:00
Saddle of lamb	1 - 1.5 kg	1	160 - 180	1:00 - 1:30

Game

Type of meat	Quantity	Level	Temperature (°C)	Time (h:min)
Saddle of hare, leg of hare ¹⁾	Up to 1 kg	3	220 - 250	0:25 - 0:40
Loin of Game	1.5-2 kg	1	210 - 220	1:15 - 1:45
Leg of Game	1.5 - 2 kg	1	200 - 210	1:30 - 2:15

1) pre-heat oven

Poultry

Type of meat	Quantity	Level	Temperature (°C)	Time (h:min)
Poultry pieces	per 200-250g	1	200 - 220	0:35 - 0:50
Half chicken	per 400-500g	1	190 - 210	0:35 - 0:50
Poultry	1 - 1.5 kg	1	190 - 210	0:45 - 1:15
Duck	1.5 - 2 kg	1	180 - 200	1:15 - 1:45
Goose	3.5 - 5 kg	1	160 - 180	2:30 - 3:30
Turkey	2.5 - 3.5 kg	1	160 - 180	1:45 - 2:30
Turkey	4 - 6 kg	1	140 - 160	2:30 - 4:00

Defrosting

- Put the food out of the packaging and set it on a plate on the oven shelf.
- Do not cover with a plate or bowl. This can extend the time to defrost very much.
- Put the oven shelf in the first shelf level from the bottom.

Information on acrylamides

Important! According to the newest scientific knowledge, if you brown food (specially the one which contains starch), acrylamides can pose a health risk. Thus, we recommend that you cook at the lowest temperatures and do not brown food too much.

Care and cleaning

 **Warning!** Refer to "Safety information" chapter.

- Clean the front of the appliance with a soft cloth with warm water and cleaning agent.
- To clean metal surfaces use a usual cleaning agent
- Clean the oven interior after each use. Thus you can remove dirt more easily and it does not burn on.
- Clean stubborn dirt with a special oven cleaner.
- Clean all oven accessories (with a soft cloth with warm water and cleaning agent) after each use and let them dry.
- If you have nonstick accessories, do not clean them using an aggressive agents, sharp edged objects or dishwasher. It can destroy nonstick coating!

Stainless steel or aluminium appliances:

Clean the oven door with a wet sponge only. Dry it with a soft cloth.

Do not use steel wool, acids or abrasive materials as they can damage the oven surface. Clean the oven control panel with the same precautions

Catalytic walls

The walls with a catalytic coating are self-cleaning. They absorb fat which collects on walls while the oven operates.

To support this self-cleaning process heat the oven without any food regularly:

1. Open the oven door.
2. Remove all accessories from the oven.

3. Close the door.
4. Set the maximum oven temperature and let the oven operate for 1 hour.
5. Clean the oven cavity with a soft and damp sponge.

! **Caution!** Do not attempt to clean catalytic surfaces with oven sprays, abrasive cleaners, soap or other cleaning agents. This may damage the catalytic surface.

i Discolouration of the catalytic surface has no effect on catalytic properties.

Shelf Support Rails

Removing the shelf support rails

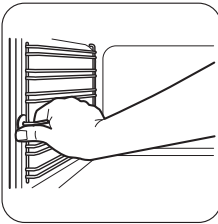

1 Pull the front of the shelf support rail away from the side wall.

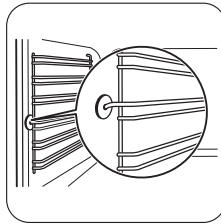

2 Pull the rear shelf support rail away from the side wall and remove it.

Installing the shelf support rails

Install the shelf support rails in opposite sequence.

i The rounded ends of the shelf support rails must point to the front!

Oven door and glass panels

To clean the oven door remove it.

! **Caution!** Be careful when you remove the door from the appliance. The door is heavy!

Removing the oven door

1. Open the oven door as far as it goes.
2. Lift up clamping levers (A) on the two door hinges fully.

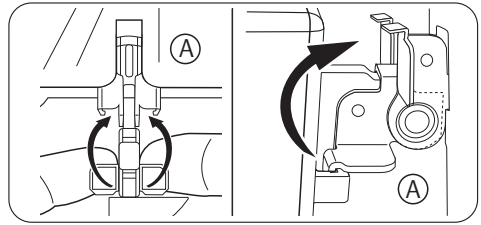

3. Close the oven door until the first position (angle approx. 45°).

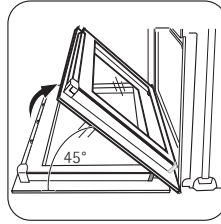

4. Hold of the oven door with one hand on each side and pull it away from the oven at an upwards angle.

i Put the oven door with the outer side down on a soft and level surface to prevent scratches.

5. Now you can remove the inner glass panels and clean them.
To install the door follow the procedure in reverse.

i The oven door has 2, 3 or 4 panels of glass (depends on the model)

Removing and cleaning the door glasses

1. Hold the door trim (B) on the top edge of the door at the two sides and push inwards to release the clip seal.

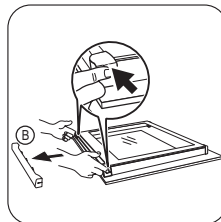

2. Pull the door trim to the front to remove it.

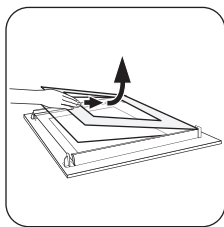

3. Hold the door glass panels on their top edge one by one and pull them upwards out of the guide
4. Clean the door glass panels.
To install panels follow the procedure in reverse. Insert the smaller panel first, then the larger.

Oven lamp

Warning! There is a danger of electrical shock!

Before you change the oven lamp:

- Switch off the oven.

What to do if . . .

Warning! Refer to "Safety information" chapter.

- Remove the fuses in the fuse box or switch off the circuit breaker.

i Put a cloth on the bottom of the oven for protection of the oven light and glass cover.

Replacing the oven lamp

1. You can find the lamp glass cover at the back of the cavity.
Turn the lamp glass cover counterclockwise to remove it.
2. Clean the glass cover.
3. Replace the oven lamp with applicable 300°C heat-resistant oven lamp.

Important! Use the same oven lamp type.

4. Install the glass cover.

Problem	Possible cause	Remedy
The oven does not heat up	The oven is not switched on	Switch on the oven
The oven does not heat up	The clock is not set	Set the clock
The oven does not heat up	The necessary settings are not set	Control the settings
The oven does not heat up	The fuse in the fuse box is released	Control the fuse. If the fuse is released more than one time, refer to a qualified electrician.
The oven lamp does not operate	The oven lamp is defective	Replace the oven lamp
Steam and condensation settle on the food and in the oven cavity	You left the dish in the oven for too long	Do not leave the dishes in the oven for longer than 15-20 minutes after the cooking process ends
The display shows "12.00"	A power cut	Reset the clock

If you cannot find a solution to the problem yourself, contact your dealer or the service centre.

The necessary data for the service centre is on the rating plate. The rating plate is on the front frame of the appliance cavity.

We recommend that you write the data here:

Model (MOD.)

.....

Product number (PNC)

Serial number (S.N.)

Installation

Warning! Refer to "Safety information" chapter.

Important! The built-in unit must meet the stability requirements of DIN 68930.

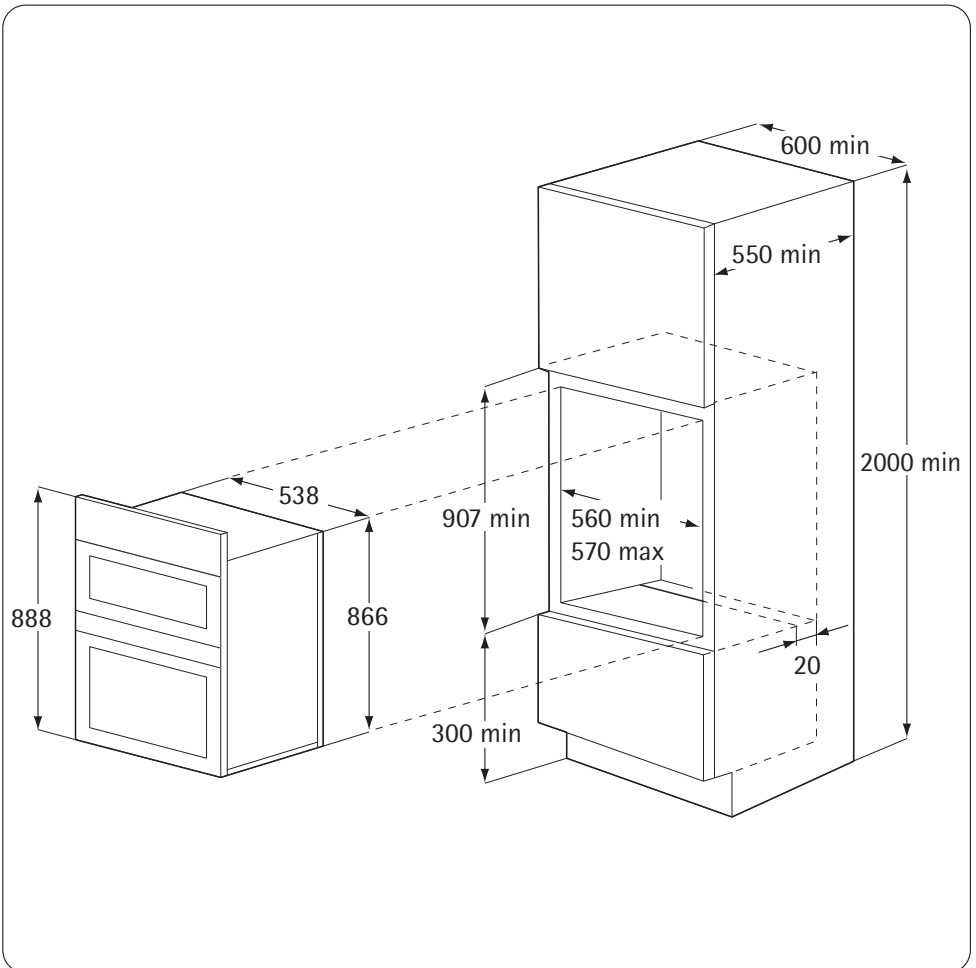

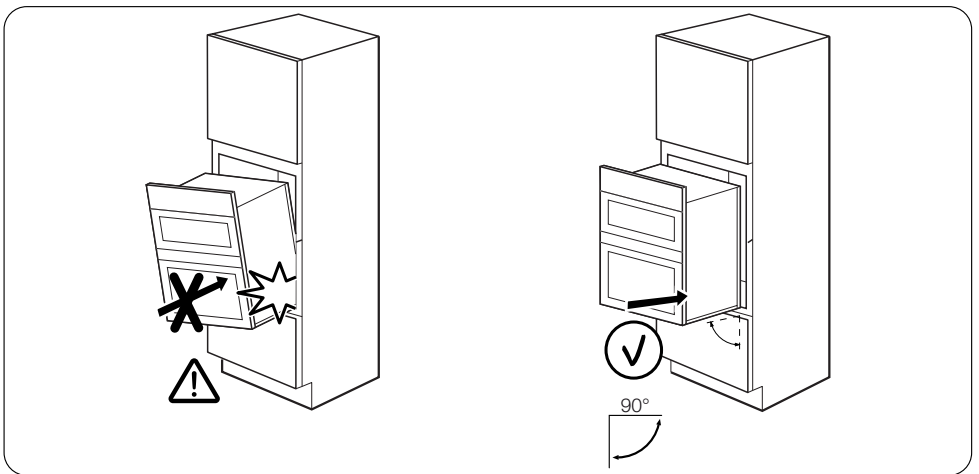
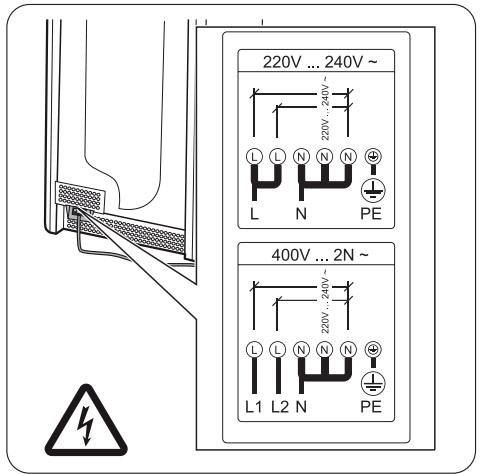
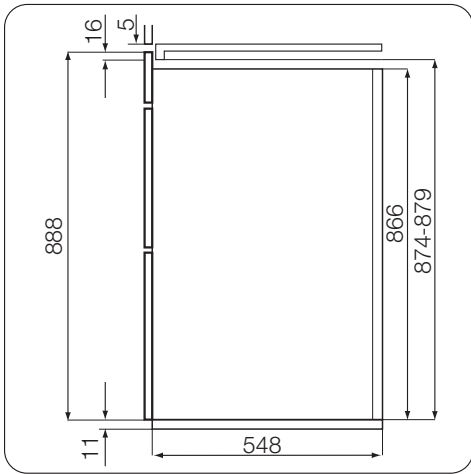

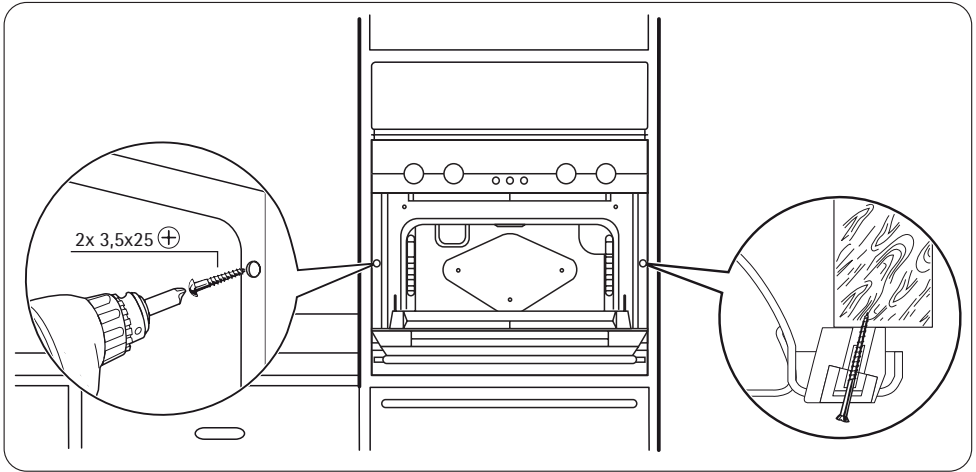

Electrical installation

Warning! Only a qualified and competent person must do the electrical installation.

i The manufacturer is not responsible if you do not follow safety precautions from chapter "Safety".

This appliance is supplied without a main plug and a main cable.

Applicable cable types : H07 RN-F, H05 RN-F, H05 RRF, H05 VV-F, H05 V2V2-F (T90), H05 BB-F

Electrical Installation

- Enquiries regarding the installation of the cooker point, if required, should be made to your Regional Electricity Company to ensure compliance with their regulations.
- The appliance socket switch should be outside the cabinet but within 2m of the appliance to make it accessible to switch off the appliance in case of an emergency.
- To protect the hands, wear gloves when lifting the oven into its housing.

Important! HOUSE CIRCUIT

Earth leakage and continuity tests must be carried out before the appliance is connected to the mains supply and re-checked after fitting.

GETTING THINGS READY CHOICE OF ELECTRICAL CONNECTION

There are three possible ways to connect your appliance. In each case the appliance should be operated using at least 6mm² twin core and earth PVC insulated multicore

cable. Please choose from the most appropriate after reading the different methods :

- By connecting to a cooker point (having a double pole isolating switch with at least 3mm contact separation in all poles and neutral) and protected with a fuse or miniature circuit breaker at your mains fuse box.
- By connecting the appliance together with a hob directly to a cooker point(s). Having a double pole isolating switch with at least 3mm contact separation in all poles and neutral.
- If you wish to connect an oven and a hob to a cooker point you can by connecting the oven and hob separately to the cooker point. Oven and hob units should be separately connected to a cooker point. (See Picture)

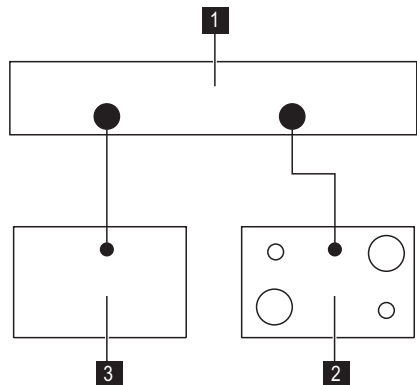

- 1 Cooker Point
- 2 Hob
- 3 Oven

It is good practice to :

- Fit an Earth Leakage Circuit Breaker to your house wiring.
- Wire your appliance to the latest IEE regulations.

Environment concerns

The symbol  on the product or on its packaging indicates that this product may not be treated as household waste. Instead it should be taken to the appropriate collection point for the recycling of electrical and electronic equipment. By ensuring this product is disposed of correctly, you will help prevent potential negative consequences for the environment and human health, which could otherwise be caused by inappropriate waste handling of this product. For more detailed

information about recycling of this product, please contact your local council, your household waste disposal service or the shop where you purchased the product.



Packaging material

The packaging material is environmentally-friendly and recyclable. Plastic parts are marked with international abbreviations such as PE, PS, etc. Dispose of the packaging material in the containers provided for this purpose at your local waste management facility.

GREAT BRITAIN & IRELAND - Guarantee/Customer Service

Standard guarantee conditions: We, Electrolux, undertake that if within 12 months of the date of the purchase this Electrolux appliance or any part thereof is proved to be defective by reason only of faulty workmanship or materials, we will, at our option repair or replace the same FREE OF CHARGE for labour, materials or carriage on condition that:

- Appliance has been correctly installed and used only on the electricity supply stated on the rating plate.
- Appliance has been used for normal domestic purposes only, in accordance with manufacturer's instructions.
- Appliance hasn't been serviced, maintained, repaired, taken apart or tampered with by person not authorised by us.
- Electrolux Service Force Centre must undertake all service work under this guarantee
- Any appliance or defective part replaced shall become the Company's property.
- This guarantee is in addition to your statutory and other legal rights.

Exclusions

- Damage, calls resulting from transport, improper use, neglect, light bulbs, removable parts of glass, plastic.

- Costs for calls to put right appliance which is improperly installed, calls to appliances outside United Kingdom.
- Appliances found to be in use within a commercial environment, plus those which are subject to rental agreements.
- Products of Electrolux manufacturer that are not marketed by Electrolux

Service and Spare Parts.Please contact your local Service Force Centre: **08445 616 616**(Call will be routed to Service Force Centre covering your postcode area). For address of local Service Force Centre and further information, please visit: www.serviceforce.co.uk Before calling out an engineer, please ensure you have read the details under the heading "What to do if...". When you contact the Service Force Centre you will need to give the following details: Your name, address and postcode, your telephone number, clear concise details of the fault, model and serial number of the appliance (found on the rating plate), the purchase date. Please note a valid purchase receipt or guarantee documentation is required for in guarantee service calls.

Customer Care.Please contact our Customer Care Department: Electrolux Major Appliances, Addington Way, Luton, Bedfordshire, LU4 9QQ or visit our website at www.electrolux.co.uk

Customer Care Department,	Tel: (Calls may be recorded for training purposes)
Electrolux	08445 613 613
AEG-Electrolux	08445 611 611
Zanussi-Electrolux	08445 612 612

For Customer Service in The Republic of Ireland please contact us at the address below:

Electrolux Group (Irl) Ltd, Long Mile Road, Dublin 12, Republic of Ireland

Tel: +353 (0)1 4090751, Email: service.eid@electrolux.ie



www.zanussi.com/shop



Free Manuals Download Website

<http://myh66.com>

<http://usermanuals.us>

<http://www.somanuals.com>

<http://www.4manuals.cc>

<http://www.manual-lib.com>

<http://www.404manual.com>

<http://www.luxmanual.com>

<http://aubethermostatmanual.com>

Golf course search by state

<http://golfingnear.com>

Email search by domain

<http://emailbydomain.com>

Auto manuals search

<http://auto.somanuals.com>

TV manuals search

<http://tv.somanuals.com>