

EN

User manual

Oven

USER MANUAL

ZOP37902

ZANUSSI

Contents

Safety information _____	2	Additional functions _____	8
Product description _____	4	Helpful hints and tips _____	8
Before first use _____	5	Care and cleaning _____	15
Daily use _____	5	What to do if... _____	17
Clock functions _____	7	Installation _____	19
Using the accessories _____	7	Environment concerns _____	20

Subject to change without notice.



Safety information

Before the installation and use, read this manual carefully:

- For your personal safety and the safety of your property
- For the respect of the environment
- For the correct operation of the appliance.

Always keep these instructions with the appliance also if you move or sell it.

The manufacturer is not responsible if incorrect installation or use results in damage.

Children and vulnerable people safety

- This appliance can be used by children aged from 8 years and above and persons with reduced physical, sensory or mental capabilities or lack of experience and knowledge if they have been given supervision or instruction concerning use of the appliance in safe way and understand the hazards involved. Children shall not play with the appliance.
- Keep all packaging away from children. There is the risk of suffocation or physical injury.
- **WARNING:** Keep children and animals away from the appliance when the door is open or the appliance is in the operation, because it becomes hot. There is the risk of injury or other permanent disability.
- If the appliance has Child Lock or Key Lock (Control Lock) function, use it. It prevents children and animals from accidental operation of the appliance.

General safety

- Do not change the specifications of this appliance. There is the risk of injury and damage to the appliance.
- Do not let the appliance stay unattended during operation.
- Switch off the appliance after each use.

Installation

- Only an approved electrician can install and connect the appliance. Contact an approved service centre. This is to prevent the risks of structural damage or physical injury.
- Make sure that the appliance is not damaged because of transport. Do not connect a damaged appliance. If necessary, contact the supplier.
- Remove all packaging, stickers and layers from the appliance before first use. Do not remove the rating plate. It can invalidate the guarantee.
- Fully obey the laws, ordinances, directives and standards in force in the country where you use the appliance (safety regulations, recycling regulations, electrical or gas safety rules etc.).
- Make sure that the appliance is disconnected from the power supply during the installation.
- Be careful when you move the appliance. The appliance is heavy. Always use safety gloves. Do not pull the appliance by the handle.
- The electrical installation must have an isolation device which lets you disconnect the appliance from the mains at all poles. The isolation device must have a contact opening width of minimum 3 mm.
- You must have correct isolation devices: line protecting cut-outs, fuses (screw type fuses removed from the holder), earth leakage trips and contactors.
- The shock protection parts must be fixed in such a way that they cannot be undone without tools.
- Some parts of the appliance carry current. Close the appliance with furniture and make sure that there are no free spaces. It prevents electrical shock because you cannot accidentally touch dangerous parts.

- Before the installation, make sure that the kitchen cabinet has the recess dimensions applicable.
- Make sure that the appliance is installed below and adjacent safe structures.
- Keep the minimum distances to the other appliances and units.
- Install the appliance with its back and one side close to the higher appliance. The other side must be close to appliance with the same height.
- The appliance cannot be positioned on a base.

Electrical connection

- The appliance must be earthed.
- Make sure that the electrical data on the rating plate agree with your domestic power supply.
- Information on the voltage is on the rating plate.
- Always use a correctly installed shockproof socket.
- When you connect electrical appliances to mains sockets, do not let cables touch or come near the hot appliance door.
- Do not use multi-way plugs, connectors and extension cables. There is the risk of fire.
- Do not replace or change the mains cable. Contact the service centre.
- Make sure not to squash or cause damage to the mains plug (if applicable) and cable behind the appliance.
- Make sure that the mains connection is accessible after the installation.
- Do not pull the mains cable to disconnect the appliance. Always pull the mains plug – if applicable.
- Fully close the oven door before you connect the appliance to mains.

Use

- The appliance is only for domestic use. Do not use the appliance for commercial and industrial use.
- Only use the appliance for domestic cooking tasks. This is to prevent physical injury to persons or prevent damage to property.
- Do not use the appliance as a work surface or storage surface.
- Do not put flammable products or items that are wet with flammable products, and/or fusible objects (made of plastic or aluminium) in, near or on the appliance. There is the risk of explosion or fire.

- The interior of the appliance becomes hot during use. There is the risk of burns. Do not touch the heating elements in the appliance. Use gloves when you insert or remove the accessories or pots.
- Be careful when you remove or install the accessories to prevent damage to the oven enamel.
- Always stay away from the appliance when you open the door while the appliance is in operation. Hot steam can release. There is the risk of skin burns.
- Discoloration of the enamel has no effect on the performance of the appliance so it is not a defect in the sense of the warranty law.
- To prevent damage or discoloration to the enamel:
 - Do not put any objects directly on the appliance floor and do not cover it with aluminium foil.
 - Do not put water directly into the hot appliance.
 - Do not keep moist dishes and food in the appliance after you finish the cooking.
- Do not use this appliance if it is in contact with water. Do not operate the appliance with wet hands.
- Do not apply pressure on the open door.
- Always close the appliance door when you cook, even while grilling.

Care and cleaning

- Before maintenance, switch off the appliance and disconnect the appliance from the power supply.
- Before maintenance, make sure that the appliance is cold. There is the risk of burns. There is the risk that the glass panels can break.
- Keep the appliance clean at all times. A build-up of fats or other foodstuff can result in a fire.
- Regular cleaning prevents the surface material from deteriorating
- Use a deep baking tray for very moist cakes to prevent that fruit juices cause stains that can be permanent.
- For your personal safety and the safety of your property, only clean the appliance with water and a soap. Do not use flammable products or products that can cause corrosion.
- Do not clean the appliance with steam cleaners, high-pressure cleaners, sharp objects, abrasive cleaning agents, abrasive sponges and stain removers
- If you use an oven spray, follow the instructions from the manufacturer.

- Do not clean the glass door with abrasive cleaning agents or metal scraper. Heat resistant surface of the inner glass can break and shatter.
- When the door glass panels are damaged they become weak and can break. You must replace them. Contact the service centre.
- Be careful when you remove the door from the appliance. The door is heavy!
- Do not clean catalytic enamel (if applicable).

Pyrolytic cleaning

Warning! Risk of burns.

- Keep children away from the appliance while the Pyrolytic cleaning is in operation. The appliance becomes very hot.
- Provide good ventilation during and after each Pyrolytic cleaning.
- Remove any pets (especially birds) from the vicinity of the oven location during and after the Pyrolytic cleaning and first use maximum temperature operation to a well ventilated area.
- Read carefully all the instructions for Pyrolytic cleaning.

Risk of fire

- Open the door carefully. The use of ingredients with alcohol can cause a mixture of alcohol and air. There is the risk of fire.

Product description

General overview

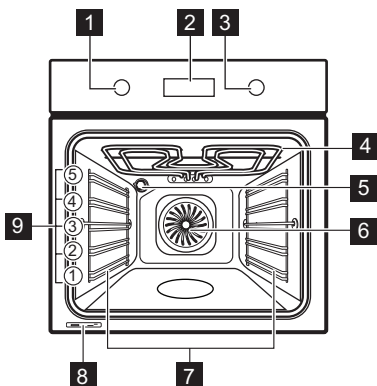

- Do not let sparks or open flames come near the appliance when you open the door.
- Do not put flammable products or items that are wet with flammable products, and/or fusible objects (made of plastic or aluminium) in, near or on the appliance.

Oven lamp

- The type of light bulb or halogen lamp used for this appliance is only for household appliances. Do not use it for house lighting.
- If it becomes necessary to replace the lamp, use one of the same power and specifically designed for household appliances only.
- Disconnect the appliance from the power supply before the replacement of the oven lamp. There is the risk of electrical shock.

Service centre

- Only an approved engineer can repair or work on the appliance. Contact an approved service centre.
- Use only original spare parts.

Disposal of the appliance

- To prevent the risk of physical injury or damage
 - Disconnect the appliance from the power supply.
 - Cut off the mains cable and discard it.
 - Discard the door catch. This prevents children or small animals from being closed inside of the appliance. There is the risk of suffocation.

- 1 Knob for the oven functions
- 2 Electronic programmer
- 3 Knob for the temperature
- 4 Grill
- 5 Oven lamp
- 6 Fan
- 7 Shelf support, removable
- 8 Rating plate
- 9 Shelf positions

Oven accessories

- **Wire shelf**
For cookware, cake tins, roasts.
- **Standard deep grill/roasting pan**

To bake and roast or as a pan to collect fat.

• **Grill trivet**

To roast and grill.

 Use the trivet only with the roasting pan.

Before first use

 **Warning!** Refer to "Safety information" chapter.



Initial cleaning

- Remove all accessories and removable shelf supports (if applicable).
- Clean the appliance before first use.

Important! Refer to the chapter "Care and cleaning".

Setting the time of day



The display shows **hr** and **12:00. 12** flashes.

1. Press **+** or **-** to set the correct hour.
2. Press  to confirm. This is necessary only when you first set the time. Afterwards, the new time value is saved automatically after five seconds.
The display shows **min** and the set hour. **00** flashes.
3. Press **+** or **-** to set the correct minutes.
4. Press  to confirm. This is necessary only when you first set the time. Afterwards, the new time value is saved automatically after five seconds.

The display shows the new time.



Changing the time of day

 You can change the time of day only if the appliance is off.

Press  again and again until the indicator for the time of day  flashes in the display. To set the new time, follow the procedure given in "Setting the time of day".

Preheating

Preheat the empty appliance to burn off the remaining grease.

1. Set the function  and the maximum temperature.
2. Let the appliance operate for 45 minutes.
3. Set the function  and the maximum temperature.
4. Let the appliance operate for 15 minutes.

Accessories can become hotter than usually. The appliance can emit an odour and smoke. This is normal. Make sure that the airflow is sufficient.

Daily use

 **Warning!** Refer to "Safety information" chapter.



To use the appliance, push the knob. The knob comes out.









Activating and deactivating the appliance

1. Turn the knob for the oven functions to an oven function.

2. Turn the knob for the temperature to set the temperature.
3. To deactivate the appliance, turn the knob for the oven functions to the off position.

Oven functions

Oven function	Application
 Off position	The appliance is off.
 True Fan Cooking	To roast or roast and bake food with the same cooking temperature, on more than one shelf, without flavour transference.
 Conventional Cooking	To bake and roast on one oven level. The top and bottom heating elements operate at the same time.

Oven function	Application
 Grilling	To grill flat food items in small quantities in the middle of the shelf. To make toast.
 Fast Grilling	To grill flat food items in large quantities. To make toast. The full grill element operates.
 Turbo Grilling	To cook large pieces of meat. The grill element and the oven fan operate one after the other and circulate hot air around the food.
 Pizza Setting	To make pizza, quiche or pie.
 Meat	To prepare very tender and juicy roasts.
 Keep Warm	To keep the food warm.
 Defrost	To thaw frozen food.
 Pyro Cleaning	To clean the oven. The high temperature burns off the residual dirt. You can then remove it with a cloth when the appliance is cold.

Display

- 1** Timer
- 2** Heat-up and residual heat indicator
- 3** Water tank (selected models only)
- 4** Food probe (selected models only)
- 5** Door lock (selected models only)
- 6** Hours/minutes
- 7** Clock functions

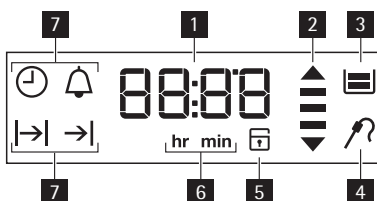

Buttons





Button	Function	Description
	Clock	To set a clock function.
- , +	Minus, plus	To set the time.

Heat-up and residual heat indicator



When you activate an oven function, the bars in the display  come on one by one. The bars show that the oven temperature increases or decreases.

When you deactivate the appliance, the display shows the residual heat indicator  if the temperature in the oven is more than 40 °C. Turn the temperature knob left or right to show the oven temperature on the display.







Clock functions





Symbol	Function	Description
	Minute Minder	To set a countdown time.
	Time of day	To set, change or check the time of day. Refer to "Setting the time of day".
	Duration	To set how long the appliance must operate. First set an oven function before you set this function.
	End	To set when the appliance must be deactivated. First set an oven function before you set this function. You can use Duration and End at the same time (Time Delay) to set the time when the appliance must be activated and then deactivated.

 Press  again and again to change the clock function.

 Press  to confirm the settings of the clock functions, or wait 5 seconds for the setting to be confirmed automatically.

Setting the Duration or End function



1. Press  again and again until the symbol  or  flashes in the display.
2. Press + or - to set the minutes.
3. Press  to confirm.
4. Press + or - to set the hour.
5. Press  to confirm.
6. When the set time ends, the symbol  or  and the set time flash. The acoustic signal sounds for two minutes. The appliance deactivates. Press a button or open the appliance door to stop the signal.





 If you press  while setting the time for Duration , the appliance switches to setting the End  function.

Setting the Minute Minder

Used to set a countdown time. The maximum time you can set is 23 hours 59 minutes. This function has no ef-

fect on the operation of the oven. You can set the Minute Minder at any time, also if the appliance is off.

1. Press  again and again until  and **00** flash in the display.
2. Press + or - to set the Minute Minder. At first the time is calculated in minutes and seconds. When the time you set is longer than 60 minutes, the symbol **hr** comes on in the display. The appliance then calculates the time in hours and minutes.
3. The Minute Minder starts automatically after five seconds.
4. When the set time ends, the acoustic signal sounds for two minutes. **00:00** and  flash in the display. Press a button to stop the signal.

 If you set the Minute Minder when the Duration  or End  function operates, the symbol  comes on in the display.

Count Up Timer

Use the Count Up Timer to monitor how long the oven operates. It is on immediately when the oven starts to heat. To reset the Count Up Timer, press and hold + and -. The timer starts to count up again.

 You cannot use the Count Up Timer when the Duration  or End  function operates.

Using the accessories

 **Warning!** Refer to "Safety information" chapter.

Trivet and grill/roasting pan

 **Warning!** Be careful when you remove the accessories from a hot appliance. There is a risk of burns.

To grill flat food items and to make toast:

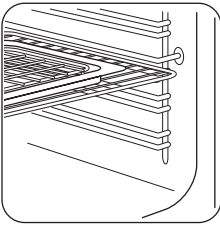



Put the trivet in the grill/roasting pan so that the supports point down.
Put the grill/roasting pan in the oven at the necessary level.

Additional functions

Child Lock

When the Child Lock is on, you cannot operate the oven. This is to make sure that children do not accidentally activate the appliance.

Activating and deactivating the Child Lock function:

1. Do not set an oven function.
2. Press and hold  and + at the same time for two seconds.
3. An acoustic signal sounds. **SAFE** and  come on or go out in the display (when you activate or deactivate the Child Lock).

 If the oven has the Pyro Cleaning function, the door is locked.

SAFE and  come on in the display when you turn a knob or press a button.

Automatic switch-off

For safety reasons the appliance deactivates after some time:

- If an oven function operates.
- If you do not change the oven temperature.

Oven temperature	Switch-off time
30 - 120 °C	12.5 h

Oven temperature	Switch-off time
120 - 200 °C	8.5 h
200 - 250 °C	5.5 h
250 - maximum °C	3.0 h

After an automatic switch-off, press a button to activate the appliance again.

Important! The automatic switch-off works with all oven functions, except Light, Duration, End and Time Delay.

Cooling fan

When the appliance operates, the cooling fan activates automatically to keep the surfaces of the appliance cool. If you deactivate the appliance, the cooling fan continues to operate until the temperature in the appliance cools down.

Safety thermostat

Incorrect operation of the appliance or defective components can cause dangerous overheating. To prevent this, the oven has a safety thermostat which interrupts the power supply. The oven activates again automatically when the temperature drops.

Helpful hints and tips

- The appliance has five shelf levels. Count the shelf levels from the bottom of the appliance floor.
- The appliance has a special system which circulates the air and constantly recycles the steam. With this system you can cook in a steamy environment and keep the food soft inside and crusty outside. It decrea-

ses the cooking time and energy consumption to a minimum.

- Moisture can condense in the appliance or on the door glass panels. This is normal. Always stand back from the appliance when you open the appliance door while

cooking. To decrease the condensation, operate the appliance for 10 minutes before cooking.

- Clean the moisture after each use of the appliance.
- Do not put the objects directly on the appliance floor and do not put aluminium foil on the components when you cook. This can change the baking results and cause damage to the enamel.

Baking cakes

- Do not open the oven door before 3/4 of the set cooking time is up.
- If you use two baking trays at the same time, keep one empty level between them.

Cooking meat and fish

- Use a dripping pan for very fatty food to prevent the oven from stains that can be permanent.

Baking and roasting table

CAKES

TYPE OF DISH	Conventional Cooking		True Fan Cooking		Cooking time [min]	Notes
	Shelf position	Temp [°C]	Shelf position	Temp [°C]		
Whisked recipes	2	170	3 (2 and 4)	160	45-60	In a cake mould
Shortbread dough	2	170	3 (2 and 4)	160	20-30	In a cake mould
Buttermilk cheese-cake	1	170	2	165	60-80	In a 26 cm cake mould
Apple cake (Apple pie)	2	170	2 (left and right)	160	80-100	In two 20 cm cake moulds on a wire shelf ¹⁾
Strudel	3	175	2	150	60-80	In a baking tray
Jam-tart	2	170	2 (left and right)	165	30-40	In a 26 cm cake mould
Sponge cake	2	170	2	160	50-60	In a 26 cm cake mould
Christmas cake/ Rich fruit cake	2	160	2	150	90-120	In a 20 cm cake mould ¹⁾
Plum cake	1	175	2	160	50-60	In a bread tin ¹⁾
Small cakes - one level	3	170	3	140-150	20-30	In a baking tray

- Leave the meat for approximately 15 minutes before carving so that the juice does not seep out.
- To prevent too much smoke in the oven during roasting, add some water into the dripping pan. To prevent the smoke condensation, add water each time after it dries up.

Cooking times

Cooking times depend on the type of food, its consistency, and volume.

Initially, monitor the performance when you cook. Find the best settings (heat setting, cooking time, etc.) for your cookware, recipes and quantities when you use this appliance.

TYPE OF DISH	Conventional Cooking		True Fan Cooking		Cooking time [min]	Notes
	Shelf position	Temp [°C]	Shelf position	Temp [°C]		
Small cakes - two levels	-	-	2 and 4	140-150	25-35	In a baking tray
Small cakes - three levels	-	-	1, 3 and 5	140-150	30-45	In a baking tray
Biscuits/pastry stripes - one level	3	140	3	140-150	30-35	In a baking tray
Biscuits/pastry stripes - two levels	-	-	2 and 4	140-150	35-40	In a baking tray
Biscuits/pastry stripes - three levels	-	-	1, 3 and 5	140-150	35-45	In a baking tray
Meringues - one level	3	120	3	120	80-100	In a baking tray
Meringues- two levels	-	-	2 and 4	120	80-100	In a baking tray ¹⁾
Buns	3	190	3	190	12-20	In a baking tray ¹⁾
Eclairs - one level	3	190	3	170	25-35	In a baking tray
Eclairs - two levels	-	-	2 and 4	170	35-45	In a baking tray
Plate tarts	2	180	2	170	45-70	In a 20 cm cake mould
Rich fruit cake	1	160	2	150	110-120	In a 24 cm cake mould
Victoria sandwich	1	170	2 (left and right)	160	50-60	In a 20 cm cake mould

1) Preheat for 10 minutes.

BREAD AND PIZZA

TYPE OF DISH	Conventional Cooking		True Fan Cooking		Cooking time [min]	Notes
	Shelf position	Temp [°C]	Shelf position	Temp [°C]		
White bread	1	190	1	190	60-70	1-2 pieces, 500 gr per piece ¹⁾
Rye bread	1	190	1	180	30-45	In a bread tin
Bread rolls	2	190	2 (2 and 4)	180	25-40	6-8 rolls in a baking tray ¹⁾

TYPE OF DISH	Conventional Cooking		True Fan Cooking		Cooking time [min]	Notes
	Shelf position	Temp [°C]	Shelf position	Temp [°C]		
Pizza	1	230-250	1	230-250	10-20	In a baking tray or deep roasting pan ¹⁾
Scones	3	200	3	190	10-20	In a baking tray ¹⁾

1) Preheat for 10 minutes.

FLANS

TYPE OF DISH	Conventional Cooking		True Fan Cooking		Cooking time [min]	Notes
	Shelf position	Temp [°C]	Shelf position	Temp [°C]		
Pasta flan	2	200	2	180	40-50	In a mould
Vegetable flan	2	200	2	175	45-60	In a mould
Quiches	1	180	1	180	50-60	In a mould ¹⁾
Lasagne	2	180-190	2	180-190	25-40	In a mould ¹⁾
Cannelloni	2	180-190	2	180-190	25-40	In a mould ¹⁾

1) Preheat for 10 minutes.

MEAT

TYPE OF DISH	Conventional Cooking		True Fan Cooking		Cooking time [min]	Notes
	Shelf position	Temp [°C]	Shelf position	Temp [°C]		
Beef	2	200	2	190	50-70	On a wire shelf
Pork	2	180	2	180	90-120	On a wire shelf
Veal	2	190	2	175	90-120	On a wire shelf
English roast beef, rare	2	210	2	200	50-60	On a wire shelf
English roast beef, medium	2	210	2	200	60-70	On a wire shelf
English roast beef, well done	2	210	2	200	70-75	On a wire shelf
Shoulder of pork	2	180	2	170	120-150	With rind
Shin of pork	2	180	2	160	100-120	2 pieces
Lamb	2	190	2	175	110-130	Leg

TYPE OF DISH	Conventional Cooking		True Fan Cooking		Cooking time [min]	Notes
	Shelf position	Temp [°C]	Shelf position	Temp [°C]		
Chicken	2	220	2	200	70-85	Whole
Turkey	2	180	2	160	210-240	Whole
Duck	2	175	2	220	120-150	Whole
Goose	2	175	1	160	150-200	Whole
Rabbit	2	190	2	175	60-80	Cut in pieces
Hare	2	190	2	175	150-200	Cut in pieces
Pheasant	2	190	2	175	90-120	Whole

FISH

TYPE OF DISH	Conventional Cooking		True Fan Cooking		Cooking time [min]	Notes
	Shelf position	Temp [°C]	Shelf position	Temp [°C]		
Trout/Sea bream	2	190	2	175	40-55	3-4 fish
Tuna fish/Salmon	2	190	2	175	35-60	4-6 fillets

Grilling

 Preheat the empty oven for 10 minutes, before cooking.

TYPE OF DISH	Quantity		Grilling		Cooking time [min]	
	Pieces	[g]	Shelf position	Temp [°C]	1st side	2nd side
Fillet steaks	4	800	4	max.	12-15	12-14
Beef steaks	4	600	4	max.	10-12	6-8
Sausages	8	-	4	max.	12-15	10-12
Pork chops	4	600	4	max.	12-16	12-14
Chicken (cut in 2)	2	1000	4	max.	30-35	25-30
Kebabs	4	-	4	max.	10-15	10-12
Breast of chicken	4	400	4	max.	12-15	12-14
Hamburger	6	600	4	max.	20-30	-
Fish fillet	4	400	4	max.	12-14	10-12
Toasted sandwiches	4-6	-	4	max.	5-7	-
Toast	4-6	-	4	max.	2-4	2-3

Turbo Grilling

Beef

TYPE OF DISH	Quantity	Shelf position	Temperature [°C]	Time [min]
Roast beef or fillet, rare	per cm of thickness	1	190-200 ¹⁾	5-6
Roast beef or fillet, medium	per cm of thickness	1	180-190 ¹⁾	6-8
Roast beef or fillet, well done	per cm of thickness	1	170-180 ¹⁾	8-10

1) Preheat the oven.

Pork

TYPE OF DISH	Quantity	Shelf position	Temperature [°C]	Time [min]
Shoulder, neck, ham joint	1-1.5 kg	1	160-180	90-120
Chop, spare rib	1-1.5 kg	1	170-180	60-90
Meat loaf	750 g-1 kg	1	160-170	50-60
Pork knuckle (precooked)	750 g-1 kg	1	150-170	90-120

Veal

TYPE OF DISH	Quantity	Shelf position	Temperature [°C]	Time [min]
Roast veal	1 kg	1	160-180	90-120
Knuckle of veal	1.5-2 kg	1	160-180	120-150

Lamb

TYPE OF DISH	Quantity	Shelf position	Temperature [°C]	Time [min]
Leg of lamb, roast lamb	1-1.5 kg	1	150-170	100-120
Saddle of lamb	1-1.5 kg	1	160-180	40-60

Poultry

TYPE OF DISH	Quantity	Shelf position	Temperature [°C]	Time [min]
Poultry portions	200-250 g each	1	200-220	30-50
Chicken, half	400-500 g each	1	190-210	35-50
Chicken, poulard	1-1.5 kg	1	190-210	50-70
Duck	1.5-2 kg	1	180-200	80-100
Goose	3.5-5 kg	1	160-180	120-180
Turkey	2.5-3.5 kg	1	160-180	120-150

TYPE OF DISH	Quantity	Shelf position	Temperature [°C]	Time [min]
Turkey	4-6 kg	1	140-160	150-240

Fish (steamed)

TYPE OF DISH	Quantity	Shelf position	Temperature [°C]	Time [min]
Whole fish	1-1.5 kg	1	210-220	40-60

Defrosting

TYPE OF DISH	[g]	Defrosting time [min]	Further defrosting time [min]	Notes
Chicken	1000	100-140	20-30	Place the chicken on an upturned saucer placed on a large plate. Turn halfway through.
Meat	1000	100-140	20-30	Turn halfway through.
Meat	500	90-120	20-30	Turn halfway through.
Trout	150	25-35	10-15	-
Strawberries	300	30-40	10-20	-
Butter	250	30-40	10-15	-
Cream	2 x 200	80-100	10-15	Cream can also be whipped when still slightly frozen in places.
Gateau	1400	60	60	-

Drying - True Fan Cooking

Cover the oven shelves with baking parchment.

VEGETABLES

TYPE OF DISH	Shelf position		Temperature [°C]	Time [hr]
	1 level	2 levels		
Beans	3	1/4	60-70	6-8
Peppers	3	1/4	60-70	5-6
Vegetables for soup	3	1/4	60-70	5-6
Mushrooms	3	1/4	50-60	6-8
Herbs	3	1/4	40-50	2-3

FRUIT

TYPE OF DISH	Shelf position		Temperature [°C]	Time [hr]
	1 level	2 levels		
Plums	3	1/4	60-70	8-10
Apricots	3	1/4	60-70	8-10
Apple slices	3	1/4	60-70	6-8
Pears	3	1/4	60-70	6-9

Information on acrylamides

Important! According to the newest scientific knowledge, if you brown food (specially the one which contains starch),

acrylamides can pose a health risk. Thus, we recommend that you cook at the lowest temperatures and do not brown food too much.

Care and cleaning

Warning! Refer to "Safety information" chapter.

- Clean the front of the appliance with a soft cloth with warm water and a cleaning agent.
- To clean metal surfaces use a usual cleaning agent.
- Clean the oven interior after each use. Then you can remove dirt more easily and it does not burn on.
- Clean stubborn dirt with a special oven cleaner.
- Clean all oven accessories after each use and let them dry. Use a soft cloth with warm water and a cleaning agent.
- If you have nonstick accessories, do not clean them using aggressive agents, sharp-edged objects or a dishwasher. It can destroy nonstick coating.

i Stainless steel or aluminium appliances:

Clean the oven door with a wet sponge only. Dry it with a soft cloth.

Do not use steel wool, acids or abrasive materials, as they can cause damage to the oven surface. Clean the oven control panel with the same precautions.

Shelf supports

You can remove the shelf supports to clean the side walls.

Removing the shelf supports

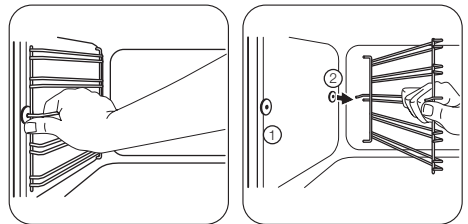

1 Pull the front of the shelf support away from the side wall.

2 Pull the rear end of the shelf support away from the side wall and remove it.

Installing the shelf supports

Install the shelf supports in the opposite sequence.

i The rounded ends of the shelf supports must point to the front.

Pyro Cleaning

Warning! The appliance becomes very hot. There is a risk of burns.

Caution! If a hob is installed with the appliance, do not use it at the same times as the Pyro Cleaning function. It can cause damage to the appliance.

1. Remove the removable shelf supports (if applicable) and accessories from the appliance. Refer to "Removing the shelf supports".

! **Caution!** Do not let the removable shelf supports stay in the appliance during Pyro Cleaning. There is a risk of damage.

2. Remove the worst dirt manually.
3. Fully close the oven door.

i The Pyro Cleaning procedure cannot start if you do not close the oven door.

4. Set the function Pyro Cleaning. Refer to "Oven functions".
5. When **→|** flashes, press **+** or **-** to set the necessary procedure:
 - **P1** - if the oven is not very dirty. The procedure is 1 h long.
 - **P2** - if the oven is more dirty. The procedure is 1 h 30 min long.
6. Press **⏸** to start the procedure. You can use the End function to delay the start of the cleaning. When the oven is at the set temperature, the door locks. The display shows the symbol **🔒** and the bars of the heat indicator.

i To stop Pyro Cleaning before it is completed, turn the knob for the oven functions to the off position.

When Pyro Cleaning is completed, the display shows the time of day. The oven door stays locked. When the appliance is cool again, an acoustic signal sounds and the door unlocks.

i During Pyro Cleaning the oven lamp is off.

Cleaning reminder

To remind you that Pyro Cleaning is necessary, **PYR** flashes in the display for 10 seconds after each activation and deactivation of the appliance.

The cleaning reminder goes out:

- After the end of the Pyro Cleaning function
- If you press **+** or **-** when **🔒** flashes in the display.

Oven lamp

! **Warning!** Be careful when you change the oven lamp. There is a risk of electrical shock.

Before you change the oven lamp:

- Deactivate the oven.
- Remove the fuses in the fuse box or deactivate the circuit breaker.

i Put a cloth on the bottom of the oven to prevent damage to the oven light and glass cover.

Always hold the halogen lamp with a cloth to prevent grease residue from burning on the lamp.

1. Turn the glass cover counterclockwise to remove it.
2. Clean the glass cover.
3. Replace the oven light bulb with an applicable 300 °C heat-resistant oven light bulb. Use the same oven lamp type.
4. Install the glass cover.

Cleaning the oven door

The oven door has three glass panels. You can remove the oven door and the internal glass panels to clean them.

i The oven door can close if you try to remove the glass panels before you remove the oven door.

Removing the oven door and the glass panels

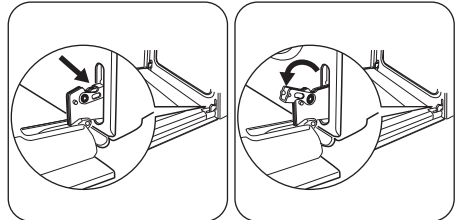

1 Open the door fully and hold the two door hinges.

2 Lift and turn the levers on the two hinges.

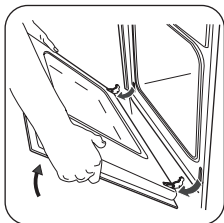

3 Close the oven door to the first opening position (halfway). Then pull forward and remove the door from its seat.

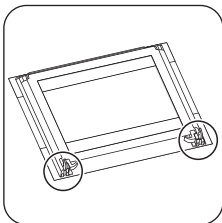

4 Put the door on a soft cloth on a stable surface.

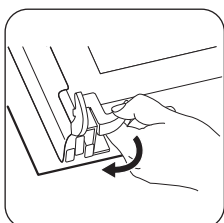

5 Release the locking system to remove the glass panels.

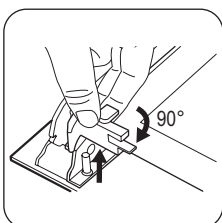

6 Turn the two fasteners by 90° and remove them from their seats.

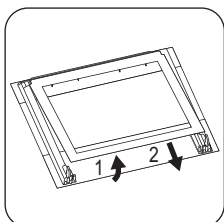

7 Carefully lift (step 1) and remove (step 2) the glass panels one by one. Start from the top panel.

Clean the glass panels with water and soap. Dry the glass panels carefully.

Installing the door and the glass panels

When the cleaning is completed, install the glass panels and the oven door. Do the above steps in the opposite sequence.

The middle panel has a decorative frame. The screen-printing zone must face the inner side of the door. Make sure that after the installation the surface of the glass panel frame on the screen-printing zones is not rough when you touch it.

Make sure that you install the top panel in the seats correctly. Refer to the illustration.

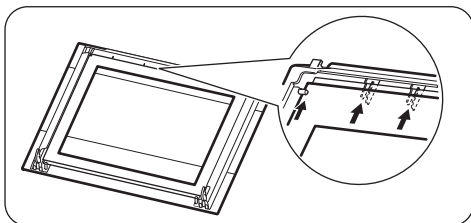

What to do if...

Warning! Refer to "Safety information" chapter.

Problem	Possible cause	Solution
The oven does not heat up.	The appliance is deactivated.	Activate the appliance.

Problem	Possible cause	Solution
The oven does not heat up.	The clock is not set.	Set the clock. Refer to "Setting the time of day".
The oven does not heat up.	The necessary settings are not set.	Make sure that the settings are correct.
The oven does not heat up.	The automatic switch-off is on.	Refer to "Automatic switch-off".
The oven does not heat up.	The Child Lock is on.	Refer to "Deactivating the Child Lock".
The oven does not heat up.	The fuse in the fuse box is released.	Do a check of the fuse. If the fuse is released more than one time, contact a qualified electrician.
The oven lamp does not operate.	The oven lamp is defective.	Replace the oven lamp.
The Pyro Cleaning does not start. The display shows C3 .	The door is not fully closed or the door lock is defective.	Fully close the door.
The display shows F102 .	The door is not fully closed or the door lock is defective.	<ol style="list-style-type: none"> 1. Fully close the door. 2. Deactivate the appliance with the house fuse or the safety switch in the fuse box and activate it again. 3. If the display shows F102 again, contact the service centre.
The oven does not heat up. The display shows Demo .	The demo mode is activated.	<ol style="list-style-type: none"> 1. Deactivate the appliance. 2. Press and hold the button +. 3. When an acoustic signal sounds, turn the knob for the oven functions to the first function. Demo flashes in the display. 4. Turn the knob for the oven functions to the off position. 5. Release the button +. 6. Turn the knob for the temperature clockwise three times. The acoustic signal sounds three times. The demo mode is deactivated.

Problem	Possible cause	Solution
The display shows an error code that is not on this list.	There is an electronic fault.	<ol style="list-style-type: none"> 1. Deactivate the appliance with the house fuse or the safety switch in the fuse box and activate it again. 2. If the display shows the error code again, contact the service centre.
Steam and condensation collect on the food and in the oven.	You left the dish in the oven for too long.	Do not keep the dishes in the oven for longer than 15-20 minutes after the cooking ends.

If you cannot find a solution to the problem yourself, contact your dealer or the service centre.

The necessary data for the service centre is on the rating plate. The rating plate is on the front frame of the oven cavity.

We recommend that you write the data here:

Model (MOD.)

Product number (PNC)

Serial number (S.N.)

Installation

Warning! Refer to "Safety information" chapter.

Building In

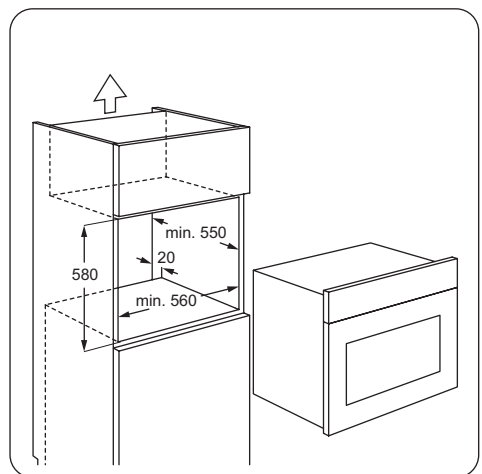
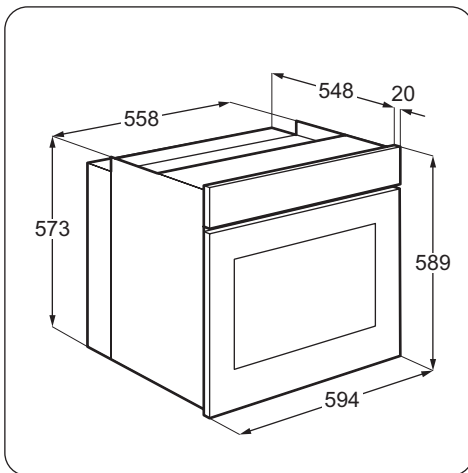

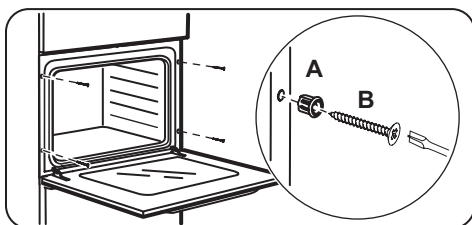
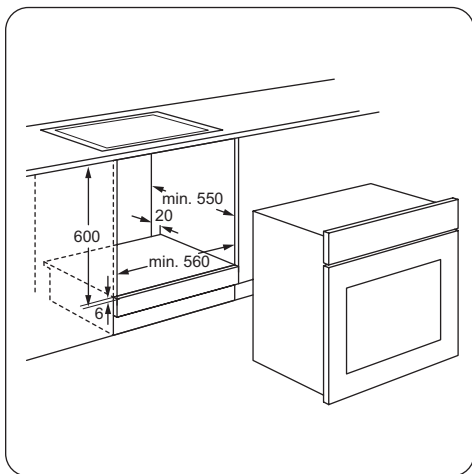

Electrical installation

Important! The manufacturer is not responsible if you do not follow the safety precautions from the chapter "Safety information".

This appliance is supplied without a main plug and a main cable.

Applicable types of cables for Europe:

- Minimum size Cable/flex: 1,5mm²
- Cable/ flex type: H07 RN-F, H05 RN-F, H05 RRF, H05 VV-F, H05 V2V2-F (T90), H05 BB-F
- Fuse 13 A

Applicable types of cables for UK only

Connection via	Min. size Cable/flex	Cable/flex type	Fuse
<ul style="list-style-type: none"> • 13 A socket outlet • 13 A spur box 	2,5 mm ²	Three core butyl insulated	13 A min.
Oven Control Circuit	2,5 mm ²	PVC/PVC twin and earth	15 A min. 20 A min.



Environment concerns

The symbol  on the product or on its packaging indicates that this product may not be treated as household waste. Instead it should be taken to the appropriate collection point for the recycling of electrical and electronic equipment. By ensuring this product is

disposed of correctly, you will help prevent potential negative consequences for the environment and human health, which could otherwise be caused by inappropriate waste handling of this product. For more detailed information about recycling of this product, please contact

your local council, your household waste disposal service or the shop where you purchased the product.



Packaging material

The packaging material is environmentally-friendly and recyclable. Plastic parts are marked with international

abbreviations such as PE, PS, etc. Dispose of the packaging material in the containers provided for this purpose at your local waste management facility.



www.zanussi.com/shop



Free Manuals Download Website

<http://myh66.com>

<http://usermanuals.us>

<http://www.somanuals.com>

<http://www.4manuals.cc>

<http://www.manual-lib.com>

<http://www.404manual.com>

<http://www.luxmanual.com>

<http://aubethermostatmanual.com>

Golf course search by state

<http://golfingnear.com>

Email search by domain

<http://emailbydomain.com>

Auto manuals search

<http://auto.somanuals.com>

TV manuals search

<http://tv.somanuals.com>