

# ZANUSSI

BUILT-UNDER  
ELECTRIC  
DOUBLE OVEN  
AND GRILL  
**ZOU 575**

INSTRUCTION BOOKLET

# IMPORTANT SAFETY INFORMATION

These warnings are provided in the interests of your safety. Ensure that you understand them all before installing or using the appliance. Your safety is of paramount importance. If you are unsure about any of the information in this book contact the Customer Care Department.

## INSTALLATION

The appliance **must** be installed according to the instructions supplied. The installation work must be undertaken by a qualified electrician or competent person.

The appliance should be serviced by an authorised Service Engineer and only genuine approved spare parts should be used.

The appliance **must** be installed in an adequately ventilated room.

It is imperative that the appliance is left in the base to protect both the appliance and the floor.

This appliance is heavy and care **must** be taken when moving it.

**Do not** attempt to lift or move this appliance by the handles.

All packaging, both inside and outside the appliance **must** be removed before the appliance is used.

It is dangerous to alter the specifications or modify the appliance in any way.

After installation please dispose of the packaging with due regard for safety and the environment. Your local authority can arrange this.

## CHILD SAFETY

**Do not** allow children to play with any part of the packaging.

**Do not** allow children to sit or climb on the drop down doors.

This appliance is not intended for use by children and other persons whose physical, sensory or mental capabilities or lack of experience and knowledge prevents them from using the appliance safely without supervision or instruction by a responsible person to ensure that they can use the appliance safely.

Children should be supervised to ensure that they do not play with the appliance.

**CAUTION: Accessible parts may be hot when the grill is in use. Young children should be kept away.**

## DURING USE

This appliance is not intended to be operated by means of an external timer or separate remote control system.

This appliance has been designed for domestic use to cook edible foodstuffs only and **must not** be used for any other purposes.

Take great care when heating fats and oils as they will ignite if they become too **hot**.

Never place plastic or any other material that may melt in or on the oven.

**Do not** leave the grill pan handle in position when grilling as it will become **hot**.

Always use oven gloves to remove and replace the grill pan handle when grilling.

Always support the grill pan when it is in the withdrawn or partially withdrawn position.

Always use oven gloves to remove and place food in the oven.

During use the appliance becomes hot. Care should be taken to avoid touching the heating elements inside the oven.

**Ensure** that all vents are not obstructed to ensure ventilation of the oven cavity.

**Never line any part of the appliance with foil.**

**Always** stand back from the appliance when opening the oven door to allow any build up of steam or heat to release.

Stand clear when opening the drop down doors. Support the doors using the handles until fully open.

**Never leave the appliance unattended when the oven door is open.**

**Do not** place sealed cans or aerosols inside the oven. They may explode if they are heated.

Ensure that all control knobs are in the **OFF** position when not in use.

**Do not** stand on the appliance or on the open oven doors.

**Do not** hang towels, dishcloths or clothes from the appliance or its handles.

**Do not** use this appliance if it is in contact with water. **Never** operate it with wet hands.

## CLEANING AND MAINTENANCE

For hygiene and safety reasons this appliance should be kept clean at all times. A build-up of fats or other foodstuffs could result in a fire especially in the grill pan.

**Do not** leave cookware containing foodstuffs, e.g. fat or oil in the appliance in case it is inadvertently switched on.

**Always** allow the appliance to cool before switching off at the wall prior to carrying out any cleaning/maintenance work.

Only clean this appliance in accordance with the instructions given in this book.

Never use steam or high pressure steam cleaners to clean the appliance.

## AT THE END OF THE APPLIANCE'S LIFE

The symbol  on the product or on its packaging indicates that this product may not be treated as household waste. Instead it shall be handed over to the applicable collection point for the recycling of electrical and electronic equipment.

By ensuring this product is disposed of correctly, you will help prevent potential negative consequences for the environment and human health, which could otherwise be caused by inappropriate waste handling of this product.

For more detailed information about recycling of this product, please contact your local city office, your household waste disposal service or the shop where you purchased the product.

# CONTENTS

## FOR THE USER

<b>Important Safety Information</b>	2
<b>Description of the Appliance</b>	4
<b>Getting to Know Your Appliance</b>	5
Before Using the Appliance	6
Rating Plate	6
Preparing to Use Your Appliance	6
When First Switching On	6
The Cooling Fan for the Controls	6
Control Panel Indicator Neon(s)	6
Pop in Pop out Controls	6
Fan Selector Button	6
Condensation and Steam	6
Cookware	6
<b>Electronic Timer</b>	7
<b>The Dual Grill</b>	10
Using the Dual Grill	10
Things to Note	10
The Grill Pan and Handle	10
Hints and Tips	11
Grilling Chart	11
<b>The Fan Assisted Top Oven</b>	12
Using the Fan Assisted Top Oven	12
Things to Note	12
To Fit the Top Oven Shelf	12
Hints and Tips	13
<b>The Conventional Top Oven</b>	14
Using the Conventional Top Oven	14
Things to Note	14
To Fit the Oven Shelf	14
Hints and Tips	15
<b>Top Oven Cooking Chart</b>	16
<b>Thermal Grilling in the Top Oven</b>	17
Using Thermal Grill	17
Things to Note	17
Hints and Tips	18
Thermal Grilling Chart	18
<b>Defrosting in the Top Oven</b>	19
Using Defrost Feature	19
Things to Note	19
Hints and Tips	19
<b>Main Oven Dual Grill</b>	20
Using the Main Oven Dual Grill	20
Things to Note	20
Hints and Tips	20
Grilling Chart	21
<b>The Main Oven</b>	22
Using the Main Oven	22
Things to Note	22
To Fit The Main Oven Shelves	23
Hints and Tips	23
<b>The Conventional Oven</b>	24
Using the Conventional Oven	24
Things to Note	24
Hints and Tips	25
<b>Main Oven Cooking Chart</b>	26
<b>Roasting Chart</b>	27
<b>Pizza Function</b>	28
Using Pizza function	28
Things To Note	28
Hints and Tips	28

<b>Defrosting in the Main Oven</b>	29
Using Defrost	29
Things to Note	29
Hints and Tips	29
<b>Boost Function</b>	30
Using Boost	30
Things to Note	30
Hints and tips	30
<b>Thermal Grilling in the Main Oven</b>	31
Using Thermal Grill	31
Things to Note	31
Hints and Tips	32
Thermal Grilling Chart	32
<b>Care and Cleaning</b>	33
Cleaning Materials	33
Cleaning the Outside of the Appliance	33
Removing and Replacing the Wirework Runners	33
Cleaning Inside the Ovens	34
Hints and Tips	34
Cleaning the Shelves, Wirework Runners and Grill/Oven Furniture	35
Cleaning the Outer and Inner Door Glass Panels	35
To Remove the Outer Door Glass	35
To Replace the Outer Door Glass	36
To Clean the Inner Glass Door	36
The Oven Lights	36
Replacing an Oven Light Bulb	37
<b>Something Not Working</b>	38
<b>Service and Spare Parts</b>	39
<b>Guarantee Conditions</b>	40

## FOR THE INSTALLER

<b>Technical Details</b>	41
<b>Installation Instructions</b>	42
Warnings	42
Things to Note	42
Choice of Electrical Connection	43
Preparing Cabinet for Fitting Oven	43
How to Finish Unpacking	44
To Remove Cover of Mains Terminal	44
Connecting to the Mains Terminal	45
Checking Electrical Connections	45
Connecting to a Hob or Cooker Point	45
Fitting into the Space Between Cabinets	46

To help you the following symbols will be found in the text.



Hints and Tips



Safety Instructions

Please read the instruction book carefully before use and retain for future reference.

# DESCRIPTION OF THE APPLIANCE

BUILT UNDER ELECTRIC DOUBLE OVEN

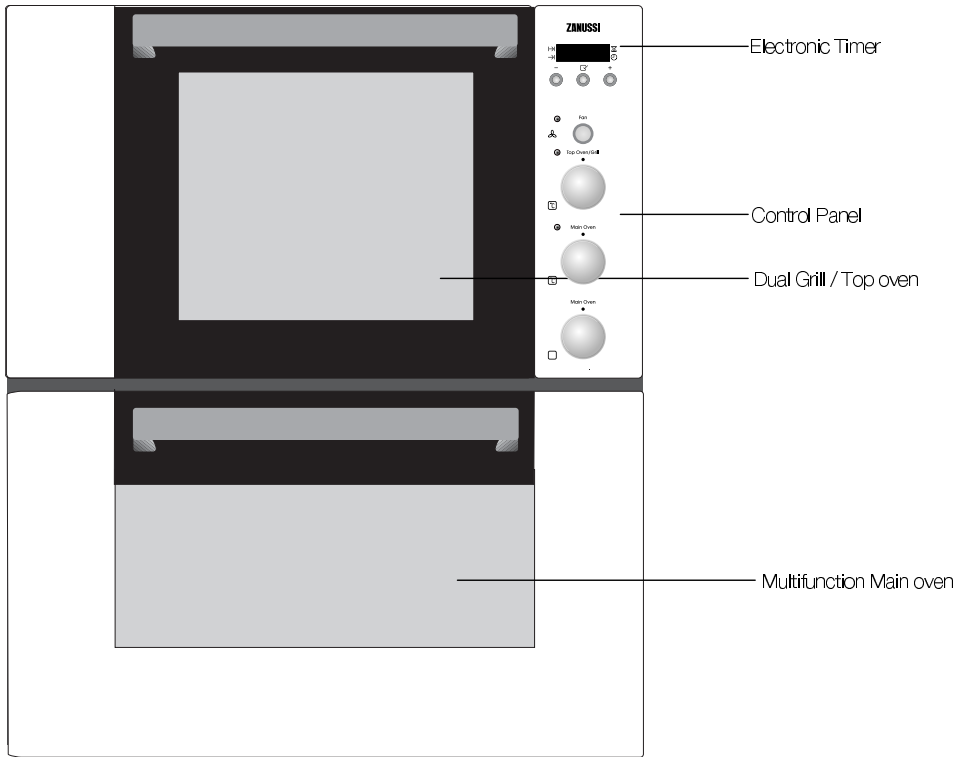



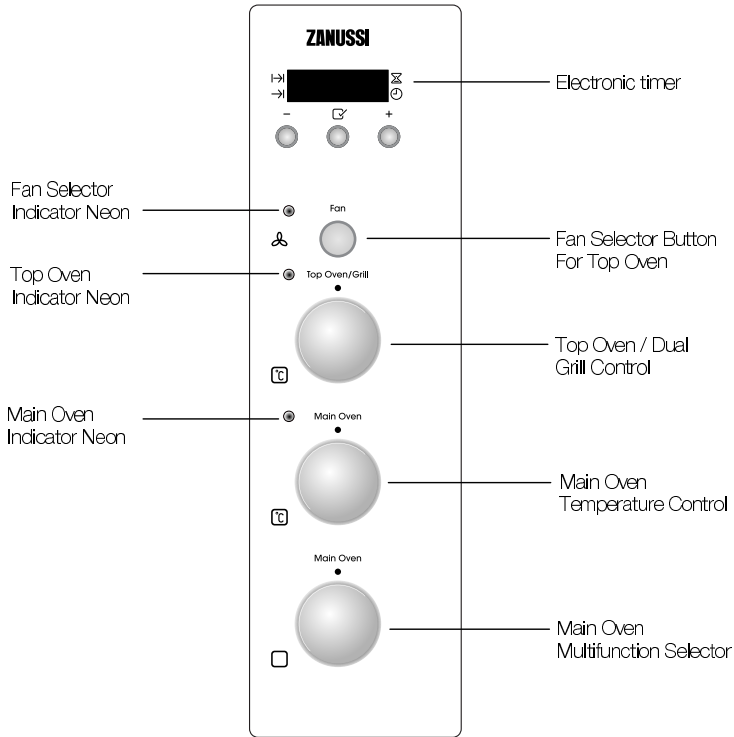

# GETTING TO KNOW YOUR APPLIANCE

## THE CONTROL PANEL



## MAIN OVEN MULTIFUNCTION SELECTOR

-  Full Grill
-  Single Economy Grill
-  Fan Oven
-  Conventional Oven
-  Pizza Function
-  Defrost
-  Boost
-  Thermal Grilling
-  Oven Light

# BEFORE USING THE APPLIANCE

## RATING PLATE

This is situated on the lower front frame of the appliance and can be seen upon opening the door. Alternatively the rating plate may also be found on the back or top of some models (where applicable).

The appliance must be protected by a suitably rated fuse or circuit breaker. The rating of the appliance is given on the rating plate.

**Do not remove the rating plate from the appliance as this may invalidate the guarantee.**

## PREPARING TO USE YOUR APPLIANCE

Wipe over the base of the oven(s) with a soft cloth and hot soapy water and wash the furniture before use. We suggest that you run the oven(s) and grill for 10 – 15 minutes at maximum temperature, to burn off any residue from their surfaces. Accessible parts may become hotter than in normal use. Children should be kept away. During this period an odour may be emitted, it is therefore advisable to open a window for ventilation.

## CONTROL PANEL INDICATOR NEON(S)

The indicator neon will operate when the grill (where applicable) or oven(s) is switched on. The indicator neon will glow. It may turn on and off during use to show that the setting is being maintained. If the neon does not operate as the instructions indicate the controls have been incorrectly set. Return all controls to zero and reset following the instructions for the required setting.

## THE COOLING FAN FOR THE CONTROLS

The cooling fan comes on after a short time when the grill/second oven and main oven is in use. It may run on after the controls are switched off until the appliance has cooled. During the initial period the cooling fan may turn ON and OFF, this is quite normal.



Always allow the cooling fan to cool the appliance down before switching off at the wall prior to carrying out any cleaning or maintenance work.

## CONDENSATION AND STEAM

When food is heated it produces steam in the same way as a boiling kettle does. The vents allow some of this steam to escape. However, always stand back from the appliance when opening the oven door(s) to allow any build up of steam or heat to be released.

If the steam comes into contact with a cool surface on the outside of the appliance, e.g. a trim, it will condense and produce water droplets.

This is quite normal and is not caused by a fault on the appliance.

To prevent discolouration occurring, regularly wipe away condensation and any soilage from the appliance surfaces.

For your safety wall coverings at the rear of the appliance should be securely fixed to the wall.

## COOKWARE

Baking trays, dishes etc., should not be placed directly against the grid covering the fan at the back of the oven.

**Do not** use baking trays larger than 30cm x 35cm (12" x 14") as they will restrict the circulation of heat and may affect performance.

## GRILL AND OVEN FURNITURE

The following items of oven furniture have been supplied with the appliance.

1 grill pan



1 grill pan handle



1 grill pan grid

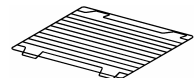

1 shelf (for grilling second oven cooking only)



2 shelves (for Main Oven cooking)



# ELECTRONIC TIMER

## KEY

- A COOK TIME
- B END TIME
- C COUNTDOWN
- D TIME
- E DECREASE CONTROL
- F SELECTOR CONTROL
- G INCREASE CONTROL

## NOTE:

The time of day must be set before the main oven will operate manually.

### 1. HOW TO SET THE TIME OF DAY

The oven has a 24 hour clock.

When the electricity supply is first switched ON, the display will show 12.00 and the 'Time' (⌚) indicator neon will flash as Fig. 1.

To set the correct time press the increase control button (+) and if necessary, the decrease control button (-) until the correct time on the 24 hour clock is reached, e.g. 10.00am as Fig.2. The 'Time' indicator (⌚) neon will flash for 5 seconds and then go out.

**Note:** The increase and decrease control buttons operate slowly at first, and then more rapidly. They should be pressed separately.

### 2. HOW TO SET THE COUNTDOWN

The 'Countdown' gives an audible reminder at the end of any period of cooking. This cooking period may be up to 2 hrs 30 mins. It is not part of the automatic control.

To set, press the Selector Control button (⌚) until the 'Countdown' indicator is illuminated (⌚) the display reads 0.00 as Fig.3.

To set the correct time duration depress the increase control (+) until the display indicates the interval to be timed, e.g. 1hr 45 mins as Fig. 4. If necessary depress the decrease control (-) to achieve the correct time interval.

**NOTE:** This must be completed within 5 seconds of first pressing the Selector Control button.

During the operation of the 'Countdown', the remaining time period will be shown in the display. The 'Countdown' will sound intermittently for up to 2 minutes at the end of the timed period. The sound can be stopped by pressing any button.

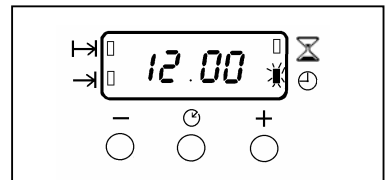
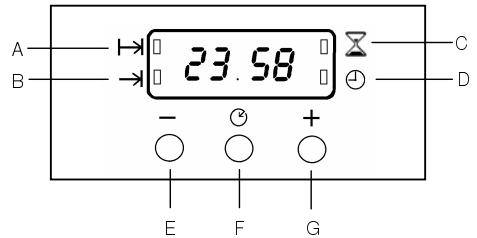

Fig.1.

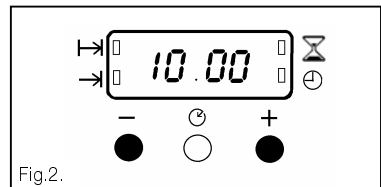

Fig.2.

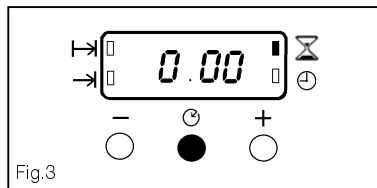

Fig.3

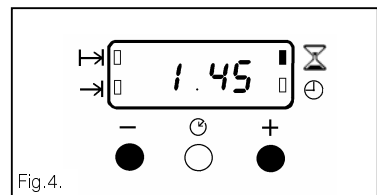

Fig.4.

## TO CANCEL THE COUNTDOWN

If you change your mind and want to cancel the 'Countdown', press the Selector Control button until the 'Countdown' (⌚) indicator neon flashes and then the decrease control ( - ) until 0.00 shows in the display as Fig. 5. The 'Countdown' (⌚) indicator neon will continue to flash for a few seconds and then return to the time of day.

## 3. SETTING THE OVEN TIMER CONTROL

Only the main oven can be automatically timed.

When using the timer control for the very first time, it is advisable to let it operate while you are at home. The displays can be checked to show that it is operating correctly and you will feel confident to leave a meal to cook automatically in the future.

### A) TO SET THE TIMER TO SWITCH ON AND OFF AUTOMATICALLY

- i) Ensure the electricity supply is switched ON and that the correct time of day is displayed, e.g. 9.am. as Fig. 6.
- ii) Set the main oven controls to the required function and temperature.
- iii) Place food in the oven.
- iv) To set the length of cooking time, press the Selector Control button until the 'Cook Time' indicator neon (⬅) is illuminated. Press the increase control ( + ) until the required length of cooking time is displayed, e.g. 2 hrs 15 mins as Fig. 7. If necessary depress the decrease control ( - ) until the correct time interval is achieved.

The maximum cooking time is 10 hours.

- v) Release the buttons. The 'Cook Time' indicator neon (⬅) will be illuminated.

**Remember, this must be completed within 5 seconds of first pressing the Selector Control button.**

- v) To set the 'End Time'. Press the Selector Control button until the 'End Time' indicator neon (➡) flashes. Press the increase control ( + ) until the required stop time is displayed, e.g. 12.15 p.m. as Fig. 8. If necessary press the decrease control ( - ) until the correct time interval is achieved.
- vii) Release the buttons. The time of day will be displayed after 5 seconds. The 'Cook Time' (⬅) and 'End Time' (➡) indicator neons will be illuminated.  
The 'End Time' must not be more than 23 hours 59 minutes from the time of day. For example, if the time of day is 09.00a.m., the latest 'End Time' would be 08.59a.m. the next day.
- viii) The oven indicator neon should be OFF.

**NOTE: When the automatic timed period starts, the oven indicator neon will glow. It may turn on and off during use to show that the setting is being maintained.**

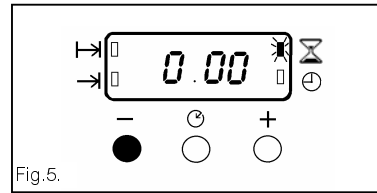

Fig.5.

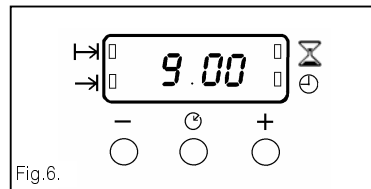

Fig.6.

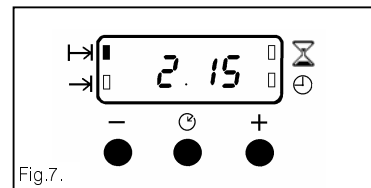

Fig.7.

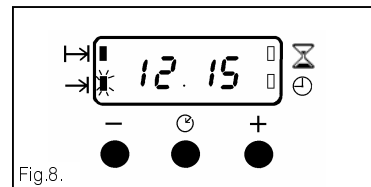





Fig.8.



## B) TO SET THE TIMER TO SWITCH OFF ONLY

- i) Ensure the electricity supply is switched ON and that the correct time of day is displayed, e.g. 10.00am as Fig. 9.
- ii) Set the main oven controls to the required function and temperature.
- iii) Place food in the oven.
- iv) To set the length of cooking time, press the Selector Control button until the 'Cook Time' (  ) indicator neon is illuminated. Press the increase control ( + ) until the required length of cooking time is displayed, e.g. 2 hrs 15 mins as Fig. 10. Depress the decrease control ( - ) if necessary.
- v) Release the buttons. The 'Cook Time' indicator neon (  ) will illuminate and the time of day will be displayed after 5 seconds.
- vi) The oven indicator neon should be ON.
- vii) To check the 'End Time' during the cooking period, simply press the Selector Control button once and the remaining time will be displayed, as Fig. 11.

## 4. TO CANCEL AN AUTOMATIC PROGRAMME

- i) To cancel an automatic programme press the Selector Control button until the 'Cook Time' (  ) indicator neon flashes. Press the decrease control ( - ) until the display reads 0.00 as Fig. 12.
- ii) Release the buttons. The 'Cook Time' (  ) indicator neon will flash and after 5 seconds return to the time of day.
- iii) Turn off the oven controls.

## 5. TO RETURN THE APPLIANCE TO MANUAL

At the end of a timed cooking period, the end time indicator neon will flash and an alarm will sound for up to 2 minutes.

- i) To stop the sound press any of the buttons, as Fig. 13.
- ii) The display will return to the time of day.
- iii) Turn off the oven controls.

## 6. THINGS TO NOTE

In the event of an interruption of the electricity supply, the timer will reset itself to zero and all programming will be cancelled.

## 7. ENERGY SAVE MODE

By switching off the time display you can save energy.

### Switching off the time display

Press and hold any two buttons until the display switches off.

### Switching on the time display

Press any button to switch on the display.

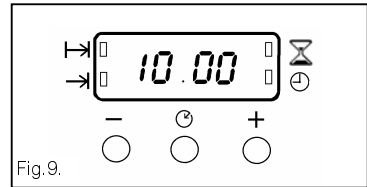

Fig.9.

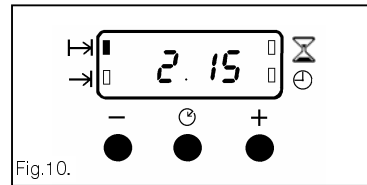

Fig.10.

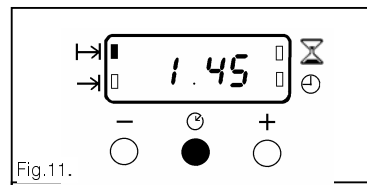

Fig.11.

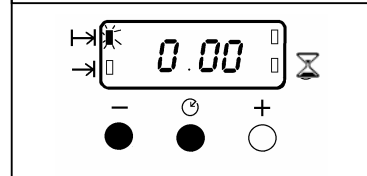

Fig.12.

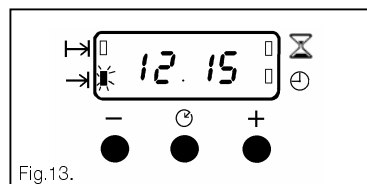

Fig.13.

## 8. AUTOMATIC COOKING

It is advisable to leave food in the oven for as short a time as possible before automatic cooking. Always ensure commercially prepared food is well within its use by date and that home prepared food is fresh and of good quality.

When cooking is complete, do not leave food to stand in the oven, but remove and cool it quickly if the food is not to be consumed immediately.

Always ensure food in the oven has been covered before cooking if it is not possible to remove food immediately after cooking.

# THE DUAL GRILL





**CAUTION** – Accessible parts may be hot when the grill is in use. Young children should be kept away.

The grill is a dual circuit grill which means that the full area of the grill can be used, or for economy purposes, the centre section only can be used when cooking smaller quantities of food.

## USING THE DUAL GRILL

Push out and turn the top oven/grill control to the full power setting (  ), then turn down as necessary.

The grill settings are as follows:-

- (  ) Full grill area at 1/4 power.
- (  ) Centre grill area at full power.
- (  ) Full grill area at full power.



**The grill door must be left open when grilling.**

## THINGS TO NOTE

- The cooling fan for the controls may operate after a time.
- Some smoke from fat splashes may be evident as the grill cleans itself.



**Never cover the grill pan with foil as this can lead to grill fires**

## THE GRILL PAN AND HANDLE

The grill pan has a removable handle.

To insert the handle, press the button on the handle with the thumb and pivot slightly upwards inserting the lip into the widest part of the bracket. Move the handle towards the left, lower into position and release the button.



**Ensure the handle is properly located.**

To remove the handle, press the button on the handle with the thumb and pivot the handle slightly upwards and towards the right to remove from the bracket.



**Protect your hands when removing the grill pan handle.**

**Always remove the grill pan handle during grilling.**

To check the progress of the food being grilled, the grill pan should be withdrawn on the shelf to attend to food during cooking.

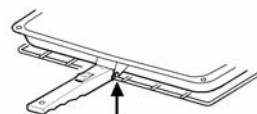
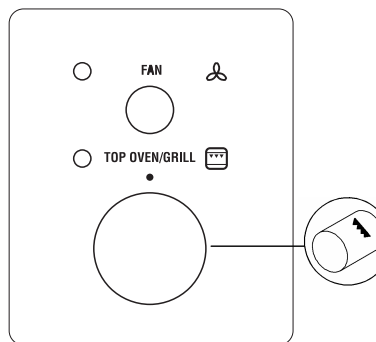

## HINTS AND TIPS

- Most foods should be placed on the grid in the grill pan to allow maximum circulation of air to lift the food out of the fats and juices.
- Adjust the grid and grill pan runner position to allow for different thicknesses of food.
- Food should be thoroughly dried before grilling to minimise splashing. Brush lean meats and fish lightly with a little oil or melted butter to keep them moist during cooking.
- Accompaniments such as tomatoes and mushrooms may be placed underneath the grid when grilling meats.
- When toasting bread, we suggest that the top runner position is used with the grid in the 'high' position.
- When using the centre section grill, ensure food is placed centrally on the grill pad grid in the grill pan before cooking.
- Preheat the grill on full setting for a few minutes. Adjust the heat setting and the shelf position as necessary during cooking.
- The food should be turned over during cooking as required

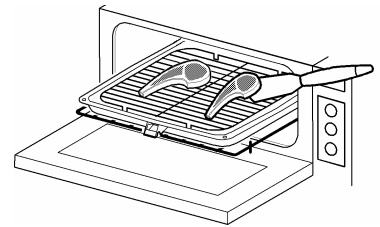
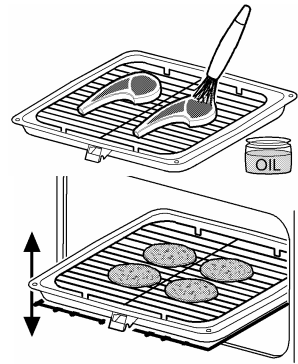

## GRILLING CHART

FOOD	POSITION	GRILL TIME (mins in total)
Bacon Rashers	Adjust	5 - 6
Beefburgers	grill	10 - 15
Chicken Joints	setting	30 - 40
Chops – Lamb	and	15 - 20
Pork		20 - 30
Fish – Whole Trout/Mackerel	grill	15 - 25
Filletts - Plaice/Cod	pan	10 - 15
Kebabs	grid	20 - 30
Kidneys – Lamb/Pig	to	8 - 12
Liver – Lamb/Pig	suit	10 - 20
Sausages	different	20 - 30
Steaks – Rare	thicknesses	6 - 12
Medium		12 - 16
Well Done		14 - 20
Toasted Sandwiches	of food	3 - 4

The times quoted above are given as a guide and should be adjusted to suit personal taste.

# THE FAN ASSISTED TOP OVEN

The top oven is the smaller of the two ovens. It is heated by elements in the top and bottom of the oven and a fan. It is designed for cooking smaller quantities of food. It gives especially good results if used to cook fruit cakes, sweet and savoury flans or quiche.

The top oven is also ideal for use as a warming compartment to warm dishes and keep food hot. Use the top oven when you want to warm plates. Use the lowest setting on the top oven temperature control.

## USING THE FAN ASSISTED TOP OVEN

- Push in the Fan Selector button.
- Push out and turn the top oven/grill temperature control to the required setting.

## THINGS TO NOTE

- The oven light will illuminate.
- The Fan Selector neon will illuminate.
- The indicator neon will glow. It may turn ON and OFF during use to show that the setting is being maintained.
- The cooling fan for the controls may operate after a time.
- The oven fan will operate.

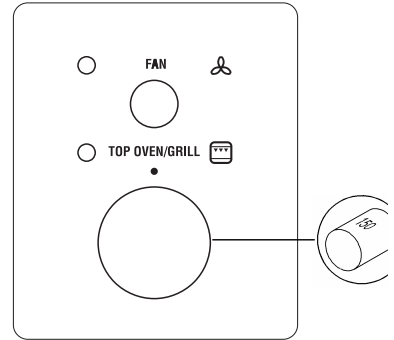

---

 Do not place dishes, tins and trays directly on the oven base as it becomes very hot and damage will occur.

---

## TO FIT THE TOP OVEN SHELF

The shelf should be fitted with the straight rods uppermost on the frame and the forms towards the back of the oven.

To remove a shelf slide the shelf towards you until the shelf stop is reached. Tilt shelf up at the front so that the stops clear the side supports. Lift shelf clear. To install a shelf, reverse the above steps. Each shelf position has an upper and lower support wire, ensure the shelf is placed between these two support wires.

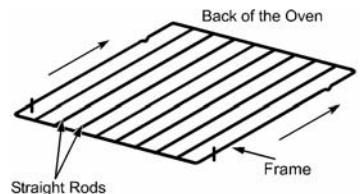

## HINTS AND TIPS

- Arrange the shelves in the required positions before switching the oven on. Shelf positions are counted from the bottom upwards.
- There should always be at least 2.5cm (1") between the top of the food and the element. This gives best cooking results and allows room for rise in yeast mixtures, Yorkshire puddings, etc. When cooking cakes, pastry, scones, bread, etc., place the tins or baking trays centrally on the shelf.
- Ensure that food is placed centrally on the shelf and there is sufficient room around the baking tray/dish to allow for maximum circulation.
- Stand dishes on a suitably sized baking tray on the shelf to prevent spillage onto the oven base and to help reduce cleaning.
- The material and finish of the baking tray and dishes used affect base browning. Enamelware, dark, heavy or non-stick utensils increase base browning. Shiny aluminium or polished steel trays reflect the heat away and give less base browning.
- Because of the smaller cooking space, lower temperatures and shorter cooking times are sometimes required.
- **Do not** place dishes directly onto the oven base as it becomes very hot and damage may occur.
- For economy leave the door open for the shortest possible time, particularly when placing food into a pre-heated oven.

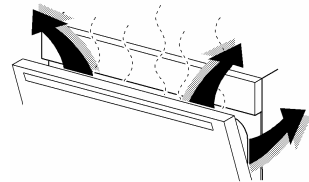
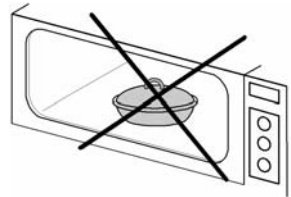
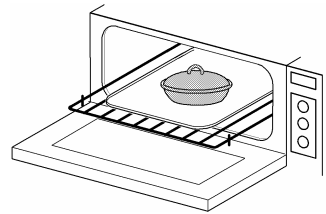
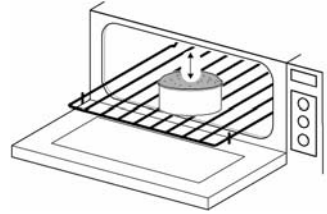

---

 Do not place cookware and cooking pots with rough bases e.g. cast iron on the oven door as damage to the glass may occur.

---

# THE CONVENTIONAL TOP OVEN

This form of cooking gives you the opportunity to cook without the fan in operation. It is particularly suitable for some cook chilled convenience foods and dishes which require extra base browning such as pizzas, quiches and flans. Gratin's, lasagne and hotpots which require extra top browning also cook well in the conventional oven. For best results cook on one level.

## USING THE CONVENTIONAL TOP OVEN

- Push out the Fan Selector button.
- Push out and turn the top oven/grill temperature control to the required setting.

## THINGS TO NOTE

- The oven light will illuminate.
- The indicator neon will glow. It may turn ON and OFF during use to show that the setting is being maintained.
- The cooling fan for the controls may operate after a time.

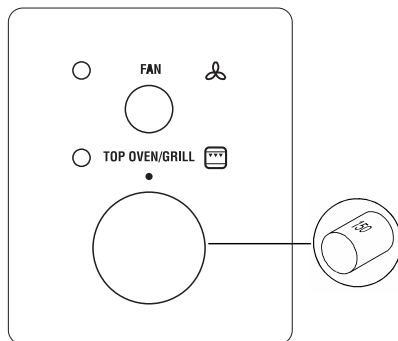

Do not place dishes, tins or baking trays directly on the oven base as it becomes very hot and damage will occur.

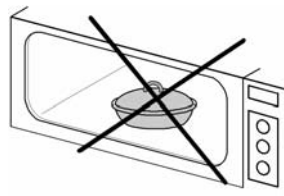

## TO FIT THE TOP OVEN SHELF

The shelf should be fitted with the straight rods uppermost on the frame and the forms towards the back of the oven. To remove a shelf slide the shelf towards you until the shelf stop is reached. Tilt shelf up at the front so that the stops clear the side supports. Lift shelf clear. To install a shelf, reverse the above steps. Each shelf position has an upper and lower support wire, ensure the shelf is placed between these two support wires.

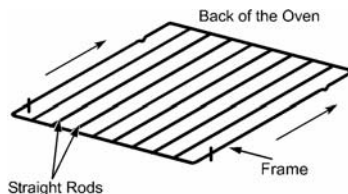

## HINTS AND TIPS

- Arrange the shelves in the required positions before switching the oven on. Shelf positions are numbered from the bottom upwards.
- There should always be at least 2.5cm (1") between the top of the food and the element. This gives best cooking results and allows room for rise in yeast mixtures, Yorkshire puddings etc. When cooking cakes, pastry, scones bread etc., place the tins or baking trays centrally on the shelf.
- Ensure that food is placed centrally on the shelf and there is sufficient room around the baking tray or dish to allow for maximum circulation.
- Stand dishes on a suitably sized baking tray on the shelf to prevent spillage onto the oven base and to help reduce cleaning.
- The material and finish of the baking tray and dishes used affect the browning. Enamelware, dark, heavy or non-stick utensils increase base browning. Shiny aluminium or polished steel trays reflect the heat away and give less base browning.
- **Because of the smaller cooking space and lower temperatures, shorter cooking times are sometimes required.**
- **Do not** place baking trays directly on the oven base as it becomes very hot and damage may occur
- For economy leave the door open for the shortest possible time, particularly when placing food into a pre-heated oven.

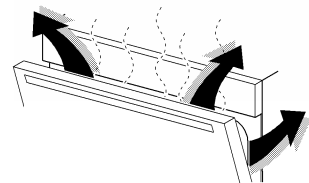
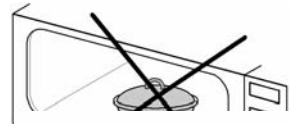
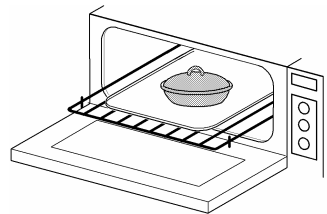
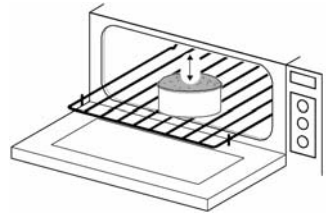

Do not place cookware and cooking pots with rough bases e.g. cast iron on the oven door as damage to the glass may occur.

# TOP OVEN COOKING CHART

The oven temperatures are intended as a guide only. It may be necessary increase or decrease the temperatures to suit individual preferences and requirements.

FOOD	SHELF POSITION	TEMP (°C)	APPROX COOK TIME (m)
Biscuits	3	170 - 190	10 - 20
Bread	3	210 - 220	25 - 30
Bread Rolls/Buns	3	210 - 220	15 - 20
Cakes:			
Small & Queen	3	180 - 190	18 - 25
Sponges	2	180 - 190	18 - 20
Victoria Sandwich	2	180 - 190	18 - 25
Madeira	3	160 - 170	1¼ - 1½h
Rich Fruit	3	140 - 150	2¼ - 2½h
Gingerbread	3	150 - 160	1¼ - 1½h
Flapjack	3	180 - 190	25 - 30
Shortbread	3	140 - 150	45 - 65
Baked Custard	3	160 - 170	2½ - 3h
Casseroles:			
Beef/Lamb	2	150 - 160	1¼ - 1½
Chicken	2	140 - 160	1¼ - 1½h
Convenience Foods	3	Follow manufacturers instructions	
Fish	3	170 - 190	20 - 30
Fish Pie - Potato Topped	3	200 - 210	20 - 25
Fruit Pies, Crumbles	3	190 - 200	40 - 50
Milk Puddings	3	140 - 150	1½ - 2h
Pasta / Lasagne etc.	3	190 - 200	40 - 45
Pastry :			
Choux –	3	190 - 200	30 - 35
Eclairs/Profiteroles	3	190 - 200	
Flaky / Puff Pies	3	200 - 210	20 - 30
Shortcrust	3	190 - 200	25 - 40
Mince Pies	3	190 - 200	15 - 20
Meat Pies	3	210 - 220	25 - 35
Quiche, Tarts, Flans	3	180 - 190	25 - 45
Roasting Meat / Poultry	1	160 - 180	see roasting chart
Scones	3	220 - 230	8 - 10
Shepherd's Pie	3	200 - 210	30 - 40
Soufflés	3	190 - 200	20 - 30
Vegetables:			
Baked Jacket Potatoes	3	190 - 200	1 - 1½
Roast Potatoes	3	200 - 210	1 - 1½
Yorkshire Puddings: - Large	3	210 - 220	25 - 40
Individual	3	210 - 220	15 - 25

Note: Shelf positions are counted from the bottom upwards.



# THERMAL GRILLING IN THE TOP OVEN

Thermal grilling in the top oven offers an alternative method of cooking food items normally associated with conventional grilling.

Thermal grilling helps to minimise cooking smells in the kitchen and allows you to grill with the oven door closed. With the exception of toast and rare steaks you can Thermal grill all the foods you would normally cook under a conventional grill.

The lower part of the oven can be used to cook accompaniments at the same time, e.g. tomatoes and mushrooms with a mixed grill or breakfast.

Dishes prepared in advance such as shepherd's pie, lasagne and au gratins can be heated through and browned on the top using the Thermal grilling function.

## COOKING TIMES

Cooking is more gentle, therefore food generally takes a little longer to cook when Thermal grilling compared with conventional grilling. One of the advantages is that larger quantities can be cooked at the same time.

## USING THERMAL GRILL



Always Thermal grill with the oven door closed and with the grill pan handle removed.

- Push in the Fan Selector button.
- Push out and turn the top oven/grill control to the full power setting ( ▼▼▼ ), then turn down as necessary.

The grill settings are as follows:-

- ( ▼ ) Full grill area at ¼ power.
- ( ▼▼ ) Centre grill area at full power.
- ( ▼▼▼ ) Full grill area at full power.

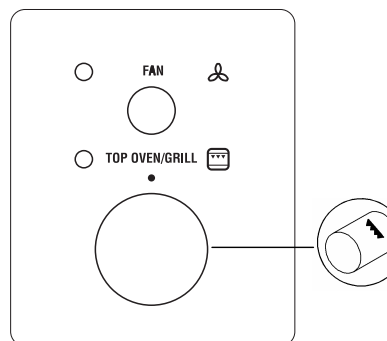

## THINGS TO NOTE

- The oven light will illuminate.
- The indicator neon will glow. It may turn ON and OFF during use to show that the setting is being maintained.
- The oven fan will operate.
- The cooling fan for the controls may operate after a time.

## **i** HINTS AND TIPS

- Prepare foods in the same way as for conventional grilling. Brush lean meats and fish lightly with a little oil or butter to keep them moist during cooking.
- Most food should be placed on the grill pan grid in the 'high' position in the grill pan to allow maximum circulation of air around the food.
- Accompaniments such as tomatoes and mushrooms may be placed below the grid when grilling meats, or in a separate dish on a lower shelf.
- Foods will cook more quickly the closer they are to the grill element and the higher the temperatures selected. Be prepared to adjust temperatures and shelf positions during cooking if necessary.
- The food should be turned over during cooking as required.
- Ensure that ready prepared or cooked chilled dishes e.g. shepherds pie, moussaka, lasagne, etc., are piping hot throughout before serving.
- A temperature range of 140°C - 220° is suitable for most foods. Be prepared to make suitable adjustments during cooking to suit individual requirements. If Thermal grilling on more than one level, it may be necessary to interchange the food on the shelves during cooking.



## THERMAL GRILLING CHART

FOOD	POSITION	GRILL SETTING	TIME (mins in total)
Bacon Rashers	5	▼▼▼	8-12
Beefburgers	3	▼▼▼	10-15
Chicken Joints	3	▼▼	30-40
Chops - Lamb/Pork	3	▼▼	20-25
Fish - Whole			
Trout/Mackerel	3	▼▼	10-20
Fillets - Plaice/Cod	3	▼▼	10-15
Kebabs	3	▼▼	20-30
Kidneys - Lamb/Pig	3	▼▼	10-15
Liver - Lamb/Pig	3	▼▼	20-30
Sausages	3	▼▼	10-20
Steaks - Medium	3	▼▼	15-20
Steaks - Well Done	3	▼▼	20-30
Heating through and Browning, e.g. Au - gratin, Lasagne, Shepherd's Pie.	3	▼▼	depends on dish

Times quoted above are given as a guide and should be adjusted to suit personal taste. Shelf positions are counted from the bottom upwards.

# DEFROSTING IN THE TOP OVEN

This top oven function defrosts most foods faster than more conventional methods. It is particularly suitable for delicate frozen foods which are to be served cold e.g. cream filled gateaux, cakes covered with icings or frostings, cheesecakes, biscuits, scones etc.

## USING DEFROST FEATURE

- Push in the Fan Selector button.
- The Top oven/Dual grill control should be in the Off '0' position.

## THINGS TO NOTE

- The oven fan and internal oven light will operate.
- The cooling fan does not operate.

## HINTS AND TIPS

- Place the frozen food in a single layer where possible and turn it over half way through the defrosting process.
- The actual speed of defrosting is influenced by room temperature. On warm days defrosting will be faster than on cooler days.
- It is preferable to thaw fish, meat and poultry slowly in the fridge. However, this process can be accelerated by using the defrost function. Small or thin fish fillets, frozen peeled pawns, cubed or minced meat, liver, thin chops, steaks etc., can be thawed in 1 - 2 hours.
- A 1kg/2¼lb oven ready chicken will be thawed in approximately 5 hours. Remove the giblets as soon as possible during the thawing process.
- Joints of meat up to 2kg/4½lb in weight can be thawed using the defrost function.
- All joints of meat and poultry must be thawed thoroughly before cooking.
- Always cook thoroughly immediately after thawing.
- **DO NOT** leave food at room temperature once it is defrosted. Cook raw food immediately or store cooked food in the fridge.
- Care must always be taken when handling foods in the home. Always follow the basic rules of food hygiene to prevent bacterial growth and cross contamination when defrosting, preparing, cooking, cooling and freezing foods.

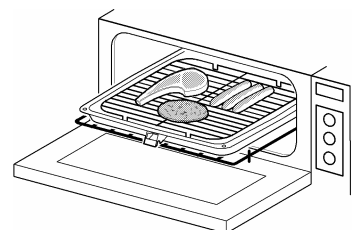
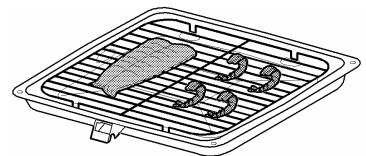
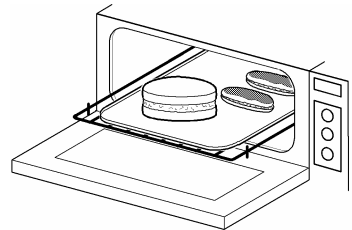
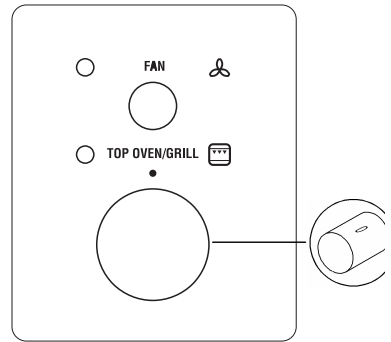

# MAIN OVEN DUAL GRILL



**CAUTION** – Accessible parts may be hot when the grill is in use. Young children should be kept away.

The grill is a dual circuit grill which means that the full area of the grill can be used or for economy purposes, the centre section only can be used when cooking smaller quantities of food.

## USING THE MAIN OVEN DUAL GRILL

- Turn the main oven multifunction selector to full grill. ▼▼▼▼
- Turn the main oven multifunction selector to centre section only. ▼▼
- Turn the main oven temperature control knob to the right as far as it will go. This is the hottest setting. To use the grill at lower settings, turn the temperature control knob to 110°C or 150°C.

## THINGS TO NOTE

- The oven light will illuminate.
- The indicator neon will glow. It may turn ON and OFF during use to show that the setting is being maintained.
- **The cooling fan for the controls may operate after a time.**
- **Some smoke from fat splashes may be evident as the grill cleans itself.**

## HINTS AND TIPS

- Most foods should be placed on the grid in the grill pan to allow maximum circulation of air to lift the food out of the fats and juices.
- Adjust the grid and grill pan runner position to allow for different thicknesses of food. Position the food close to the element for faster cooking and further away for more gentle cooking.
- Food should be thoroughly dried before grilling to minimise splashing. Brush lean meats and fish lightly with a little oil or melted butter to keep them moist during cooking.
- Accompaniments such as tomatoes and mushrooms may be placed around the outer edges or underneath the grid when grilling meats.

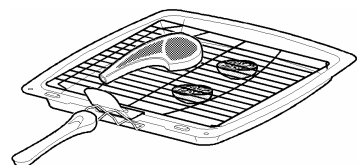
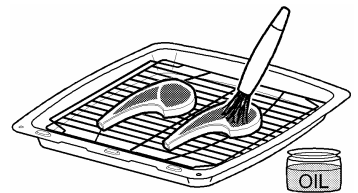
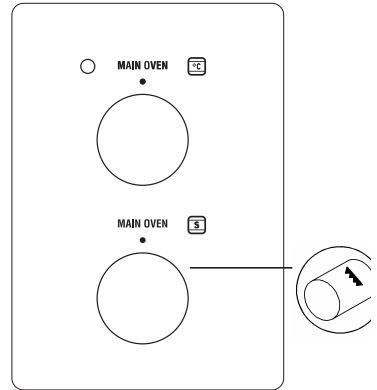

- When toasting bread, we suggest that the top runner position is used with the grid in the 'high' position.
- When using the centre section grill, ensure food is placed centrally on the grill pad grid in the grill pan before cooking.
- Preheat the grill on full setting for a few minutes. Adjust the heat setting and the shelf position as necessary during cooking.
- The food should be turned over during cooking as required

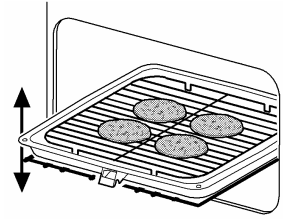

## GRILLING CHART

FOOD	POSITION	GRILL TIME (mins in total)
Bacon Rashers	Adjust grill setting and grill pan grid to suit different thicknesses of food	5 - 6
Beefburgers		10 - 15
Chicken Joints		30 - 40
Chops – Lamb		15 - 20
Pork		20 - 30
Fish – Whole Trout/Mackerel		15 - 25
Fillets - Plaice/Cod		10 - 15
Kebabs		20 - 30
Kidneys – Lamb/Pig		8 - 12
Liver – Lamb/Pig		10 - 20
Sausages		20 - 30
Steaks – Rare		6 - 12
Medium		12 - 16
Well Done		14 - 20
Toasted Sandwiches	3 - 4	

The times quoted above are given as a guide and should be adjusted to suit personal taste.

# THE MAIN OVEN

The main fan oven is particularly suitable for cooking larger quantities of food. The advantages of fan oven cooking are:

## PREHEATING

The fan oven quickly reaches its temperature so it is not usually necessary to preheat the oven. Without preheating however you may need to add an extra 5 – 10 minutes on the recommended cooking times. For recipes needing high temperatures e.g. bread, pastries, scones, soufflés etc., best results are achieved if the oven is preheated first. For best results when cooking frozen or cooked chilled ready meals always preheat the oven first.

## COOKING TEMPERATURES

Fan oven cooking generally requires lower temperatures than conventional cooking. Follow the temperatures recommended in the cooking chart. As a guide reduce temperatures by 20°C - 25°C for your own recipes, using a conventional oven.

## BATCH BAKING

The Fan oven cooks evenly on all shelf levels, especially useful when batch baking.

## USING THE MAIN OVEN

- Push out and turn the main oven multifunction selector to Fan oven.
- Push out and turn the main oven temperature control to the required setting.

## THINGS TO NOTE

- The oven light will illuminate.
- The indicator neon will glow. It may turn ON and OFF during use to show that the setting is being maintained.
- The cooling fan for the controls may operate after a time.

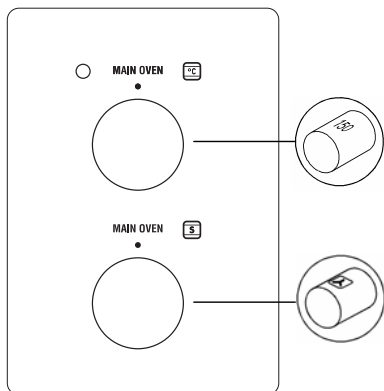

## TO FIT THE MAIN OVEN SHELVES

The shelf should be fitted with the straight rods uppermost on the frame and the forms towards the back of the oven.

To remove a shelf slide the shelf towards you until the shelf stop is reached. Tilt shelf up at the front so that the stops clear the side supports. Lift shelf clear. To install a shelf, reverse the above steps. Each shelf position has an upper and lower support wire, ensure the shelf is placed between these two support wires.

### HINTS AND TIPS

- Arrange the shelves in the required positions before switching the oven on. Shelf positions are counted from the bottom upwards.
- When cooking more than one dish in the oven, place dishes centrally on different shelves rather than cluster several dishes on one shelf, this will allow the heat to circulate freely for the best cooking results.
- When batch baking one type of food, e.g. Victoria sandwich cakes, those of similar size will be cooked in the same time.
- It is recommended that when baking larger quantities, the shelf positions should be evenly spaced to suit the load being cooked. A slight increase in cooking time may be necessary.
- **Do not** place baking trays directly on the oven base as it interferes with the oven air circulation and can lead to base burning; use the lower shelf position.



Do not place cookware and cooking pots with rough bases e.g. cast iron on the oven door as damage to the glass may occur.

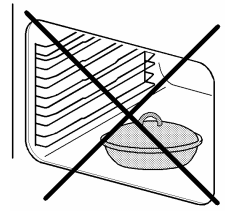
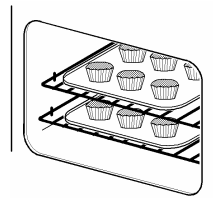
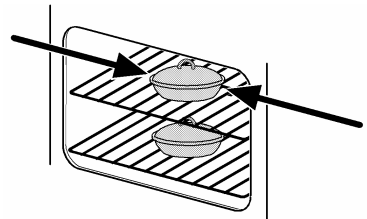
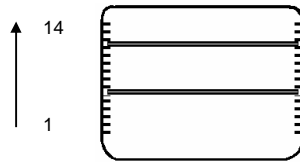

# THE CONVENTIONAL OVEN

This form of cooking gives you the opportunity to cook without the fan in operation. It is particularly suitable for dishes which require extra base browning such as pies, quiches and flans. Gratin's, lasagne and hotpots which require extra top browning also cook well in the conventional oven. For best results cook on one level.

## USING CONVENTIONAL OVEN

- Push out and turn the main oven multifunction selector to Conventional Oven. 
- Push out and turn the main oven temperature control to the required setting.

## THINGS TO NOTE

- The oven light will illuminate.
- The indicator neon will glow. It may turn ON and OFF during use to show that the setting is being maintained.
- The cooling fan for the controls may operate after a time.



Do not place dishes, tins or baking trays directly on the oven base as damage will occur.

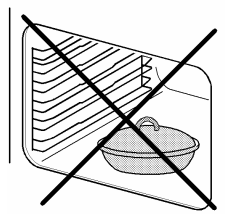
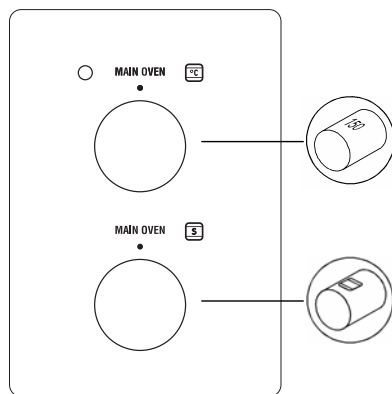



## HINTS AND TIPS

- Single level cooking gives best results. If you require more than one level of cooking use the main fan oven.
- The middle shelf allows for the best heat distribution. To increase base browning simply lower the shelf position. To increase top browning raise, the shelf position.
- There should always be at least 2.5cm (1") between the top of the food and the element. This gives best cooking results and allows room for rise in yeast mixtures, Yorkshire puddings etc. When cooking cakes, pastry, scones bread etc., place the tins or baking trays centrally on the shelf.
- Ensure that food is placed centrally on the shelf and there is sufficient room around the baking tray or dish to allow for maximum circulation.
- Stand dishes on a suitably sized baking tray on the shelf to prevent spillage onto the oven base and to help reduce cleaning.
- The material and finish of the baking tray and dishes used affect base browning. Enamelware, dark, heavy or non-stick utensils increase base browning. Shiny aluminium or polished steel trays reflect the heat away and give less base browning.
- **Do not** place baking trays directly on the oven base as it interferes with the oven air circulation and can lead to base burning; use the lower shelf position.
- For economy leave the door open for the shortest possible time, particularly when placing food into a pre-heated oven.

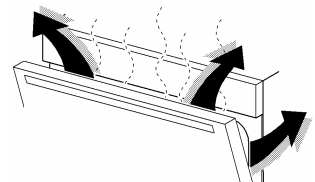
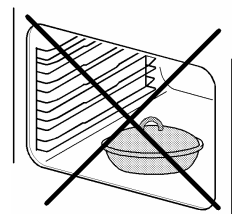
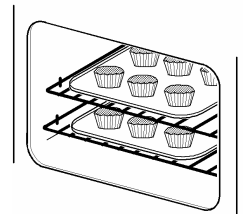

Do not place cookware and cooking pots with rough bases e.g. cast iron on the oven door as damage to the glass may occur.

# MAIN OVEN COOKING CHART

The oven temperatures are intended as a guide only. It may be necessary to increase or decrease the temperatures to suit individual preferences and requirements.

FOOD		MAIN OVEN		CONVENTIONAL OVEN		Time
		SHELF POSITION	TEMP (°C)	SHELF POSITION	TEMP (°C)	APPROX COOK TIME (m)
Biscuits			160 - 190	7	150 - 160	10 - 20
Bread			210 - 220	4	210 - 220	25 - 30
Bread rolls/buns		Shelf	210 - 220	4	210 - 220	15 - 20
Cakes:	Small & Queen		160 - 170	4	170 - 180	18 - 25
	Sponges		160 - 170	4	160 - 170	18 - 20
	Victoria	positions	160 - 170	4	160 - 170	18 - 25
Sandwich						
	Madeira		140 - 150	7	160 - 170	1¼ - 1½h
	Rich Fruit		140 - 150	7	130 - 140	2¼ - 2½h
	Christmas	are not	130 - 140	1	130 - 140	1¼ - 1½h
	Gingerbread		140 - 150	7	140 - 160	25 - 30
	Flapjack		170 - 180	7	170 - 180	45 - 65
	Shortbread	critical	140 - 150	7	140 - 150	2½ - 3h
Baked Custard			140 - 150	7	160 - 170	1¼ - 1½
Casseroles:	Beef / Lamb		140 - 150	7	140 - 150	1¼ - 1½h
	Chicken	but ensure	160 - 180	7	150 - 160	20 - 30
Convenience Foods			Follow manufacturer's instructions	7		
Fish			150 - 170	7	150 - 160	20 - 25
Fish Pie (Potato Topped)		that oven	190 - 200	7	180 - 190	40 - 50
Fruit Pies, Crumbles			180 - 190	7	190 - 200	1½ - 2h
Milk Puddings			130 - 140	7	130 - 140	40 - 45
Pasta / Lasagne etc.		shelves are	180 - 190	7	190 - 200	30 - 35
Pastry :	Choux -					
	Eclairs/Profiter		160 - 170	7	170 - 180	20 - 30
oles						
	Flaky / Puff	evenly	210 - 220	7	210 - 220	25 - 40
Pies						
	Shortcrust -					
	Mince Pies		170 - 180	7	190 - 200	15 - 20
	Meat Pies	spaced	210 - 220	7	190 - 200	25 - 35
	Quiche, Tarts,		180 - 190	7	190 - 200	25 - 45
Flans						
Roasting Meat / Poultry			160 - 180	1	160 - 180	see roasting chart
Scones		when more	200 - 210	4	210 - 220	8 - 10
Shepherd's Pie			190 - 200	7	190 - 200	30 - 40
Soufflés			170 - 180	7	180 - 190	20 - 30
Vegetables:	Baked Jacket	than one is	190 - 200	7	190 - 200	1 - 1½
Potatoes						
	Roast		200 - 210	7	200 - 210	1 - 1½
Potatoes						
Yorkshire Puddings: - Large		used	210 - 220	7	220 - 230	25 - 40
	Individual		210 - 220	7	220 - 230	15 - 25

Note: Shelf positions are counted from the bottom of the oven.

# ROASTING CHART

INTERNAL TEMPERATURES – Rare : 50-60°C; Medium : 60-70°C; Well done : 70-80°C		
MEAT	TEMPERATURE	COOKING TIME
Beef/ Beef boned	160-180°C	20-35 minutes per ½kg (1lb) and 20-35 minutes over
Mutton/Lamb	160-180°C	25-35 minutes per ½kg (1lb) and 25-35 minutes over
Pork/Veal/Ham	160-180°C	30-40 minutes per ½kg (1lb) and 30-40 minutes over
Chicken	160-180°C	15-20 minutes per ½kg (1lb) and 20 minutes over
Turkey/Goose	160-180°C	15-20 minutes per ½kg (1lb) up to 3½kg (7lb) then 10 minutes per ½kg (1lb) over 3½kg (7lb)
Duck	160-180°C	25-35 minutes per ½kg (1lb) and 25-30 minutes over
Pheasant	160-180°C	35-40 minutes per ½kg (1lb) and 35-40 minutes over
Rabbit	160-180°C	20 minutes per ½kg (1lb) and 20 minutes over

The roasting temperatures and times given in the chart should be adequate for most joints, but slight adjustments may be required to allow for personal requirements and the shape and texture of the meat. However, lower temperatures and longer cooking times are recommended for less tender cuts or larger joints.  
Wrap joints in foil if preferred, for extra browning uncover for the last 20 – 30 min. cooking time.

# PIZZA FUNCTION

This setting can be used for foods such as pizza where base browning and crispness are required.

The lower element operates in conjunction with the oven fan.

## USING PIZZA FUNCTION

- Push out and turn the main oven multifunction selector to Pizza setting. 
- Push out and turn the main oven temperature control to the required setting.

## THINGS TO NOTE

- The oven light will illuminate.
- The indicator neon will glow. It may turn ON and OFF during use to show that the setting is being maintained.
- The cooling fan for the controls may operate after a time.

## HINTS AND TIPS

- Single level cooking using the middle shelf position gives best results.
- Ensure that food is placed centrally on the shelf for maximum air circulation.
- Be guided by the cook times and temperatures given on any packaging.
- Some pizzas should be cooked directly on the oven shelf. To prevent soiling the oven base, place a baking tray in one of the lower shelf positions.



Do not place dishes, tins or baking trays directly on the oven base, as damage will occur.

- The material and finish of the baking tray and dishes used affect base browning. Enamelware, dark, heavy or non-stick utensils increase base browning. Shiny aluminium or polished steel trays reflect the heat away and give less base browning.

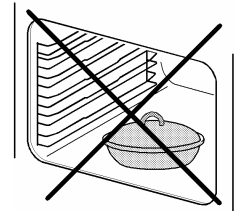
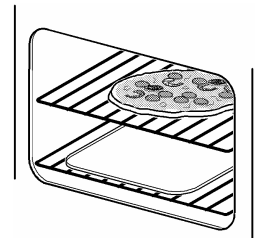
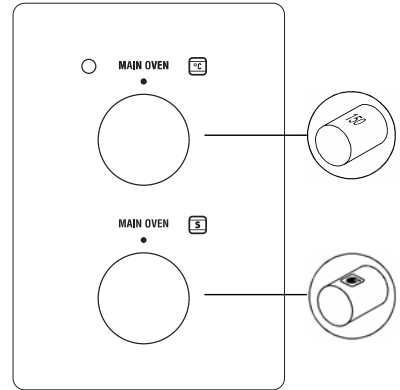

# DEFROSTING IN THE MAIN OVEN

This main oven function defrosts most foods faster than more conventional methods. It is particularly suitable for delicate frozen foods which are to be served cold e.g. cream filled gateaux, cakes covered with icings or frostings, cheesecakes, biscuits, scones etc.

## USING DEFROST

- Push out and turn the main oven multifunction selector to Defrost. 
- The Main Oven temperature control should be at the Off '0' position.

## THINGS TO NOTE

- The oven fan and internal oven light will operate.

## HINTS AND TIPS

- Place the frozen food in a single layer where possible and turn it over half way through the defrosting process.
- The actual speed of defrosting is influenced by room temperature. On warm days defrosting will be faster than on cooler days.
- It is preferable to thaw fish, meat and poultry slowly in the fridge. However, this process can be accelerated by using the defrost function. Small or thin fish fillets, frozen peeled prawns, cubed or minced meat, liver, thin chops, steaks etc., can be thawed in 1 – 2 hours.
- A 1kg/2¼lb oven ready chicken will be thawed in approximately 5 hours. Remove the giblets as soon as possible during the thawing process.
- Joints of meat up to 2kg/4½lb in weight can be thawed using the defrost function.
- All joints of meat and poultry must be thawed thoroughly before cooking.
- Always cook thoroughly immediately after thawing.
- **DO NOT** leave food at room temperature once it is defrosted. Cook raw food immediately or store cooked food in the fridge, once it has cooled.
- Care must always be taken when handling foods in the home. Always follow the basic rules of food hygiene to prevent bacterial growth and cross contamination when defrosting, preparing, cooking, cooling and freezing foods.

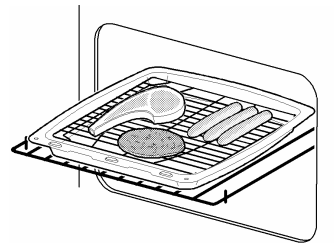
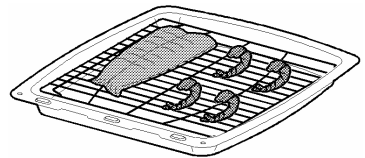
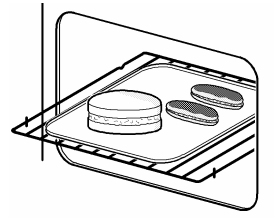

# BOOST FUNCTION

Boost is ideal for quick preheating of the oven before selecting an alternative cooking function. It can also be used for cooking chilled and frozen convenience foods without the need for pre heating.

## COOKING TIMES

Cooking times for convenience foods should be the same or slightly quicker than those stated on the packaging. This may vary depending on the dish and the quantity being cooked.

## USING BOOST

- Push out and turn the main oven multifunction selector to Boost. **B**
- Push out and turn the main oven temperature control to the required setting.
- If using Boost to preheat the oven only, when the indicator neon turns off, turn the selector to the required function.

## THINGS TO NOTE



Do not place dishes, tins or baking trays directly on the oven base as damage will occur.

- The oven light will illuminate.
- The indicator neon will glow. It may turn ON and OFF during use to show that the setting is being maintained.
- The cooling fan for the controls may operate after a time.

## **i** HINTS AND TIPS

- Single level cooking using the middle shelf gives best results.
- Frozen and cooked chilled foods can be cooked using Boost without the need for preheating.
- Use Boost for all types of frozen / cooked chilled convenience foods to give even browning and crispness where crispness is required.
- The material and finish of the baking trays and dishes used affect base browning. Enamelware, dark heavy or non-stick utensils increase base browning. Shiny aluminium or polished steel trays reflect the heat away and give less base browning.
- Always place dishes centrally on the shelf to ensure even browning.
- Stand dishes on a suitably sized baking tray on the shelf to prevent spillage onto the base of the oven and make cleaning easier.

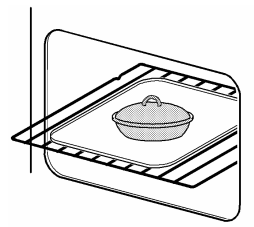
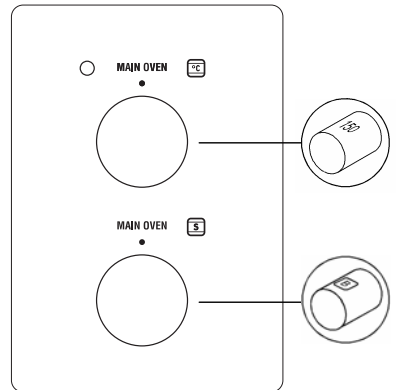

# THERMAL GRILLING IN THE MAIN OVEN

Thermal grilling offers an alternative method of cooking food items normally associated with conventional grilling.

Thermal grilling helps to minimise cooking smells in the kitchen and allows you to grill with the oven door closed. With the exception of toast and rare steaks you can Thermal grill all the foods you would normally cook under a conventional grill.

The lower part of the oven can be used to cook accompaniments at the same time, e.g. tomatoes and mushrooms with a mixed grill or breakfast.

Dishes prepared in advance such as shepherd's pie, lasagne and au gratins can be heated through and browned on the top using the Thermal grilling function.

## COOKING TIMES

Cooking is more gentle, therefore food generally takes a little longer to cook when Thermal grilling compared with conventional grilling. One of the advantages is that larger quantities can be cooked at the same time.

## USING THERMAL GRILL

---

 Always thermal grill with the oven door closed and with the grill pan handle removed.

---

- Push out and turn the main oven multifunction selector to Thermal Grill. 
- Push out and turn the main oven temperature control to the required setting. A temperature of between 140°C and 220°C is suitable for thermal grilling.

## THINGS TO NOTE

- The oven light will illuminate.
- The indicator neon will glow. It may turn ON and OFF during use to show that the setting is being maintained.
- The cooling fan for the controls may operate after a time.
- The oven fan will operate.

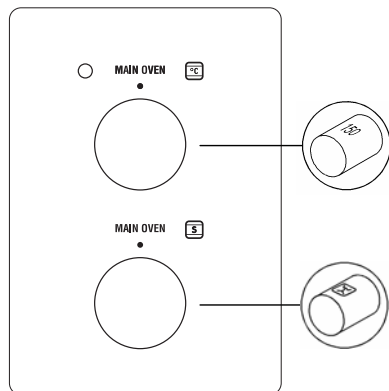

## **i** HINTS AND TIPS

- Prepare foods in the same way as for conventional grilling. Brush lean meats and fish lightly with a little oil or butter to keep them moist during cooking.
- Most food should be placed on the grill pan grid in the 'high' position in the grill pan to allow maximum circulation of air around the food.
- Accompaniments such as tomatoes and mushrooms may be placed below the grid when grilling meats, or in a separate dish on a lower shelf.
- Foods will cook more quickly the closer they are to the grill element and the higher the temperatures selected. Be prepared to adjust temperatures and shelf positions during cooking if necessary.
- Food should be turned over during cooking as required.
- Ensure that ready prepared or cooked chilled dishes e.g. shepherds pie, moussaka, lasagne, etc., are piping hot throughout before serving.
- A temperature range of 140°C - 220° is suitable for most foods. Be prepared to make suitable adjustments during cooking to suit individual requirements. If Thermal grilling on more than one level, it may be necessary to interchange the food on the shelves during cooking.



## THERMAL GRILLING CHART

FOOD	SHELF	TEMP (°C)	TIME (mins In total)
Bacon Rashers	9	200	8-12
Beefburgers	9	190	10-15
Chicken Joints	8	160	35-45
Chops - Lamb/Pork	9	170	20-35
Fish - Whole			
Trout/Mackerel	9	170	10-20
Filletts - Plaice/Cod	10	170	10-20
Kebabs	10	170	20-30
Kidneys - Lamb/Pig	9	180	10-15
Liver - Lamb/Pig	9	190	10-15
Sausages	9	190	10-15
Steaks - Medium	10	220	8-10
			each side
Steaks - Well Done	10	220	10-15
			each side
Heating through and Browning, e.g. Au - gratin, Lasagne, Shepherd's Pie.	9	170	20 depends on Size

**NOTE:** Shelf positions are counted from the bottom of the oven.

Times quoted above are given as a guide and should be adjusted to suit personal taste.



# CARE AND CLEANING



Before cleaning always allow the appliance to cool down.

## CLEANING MATERIALS

Before using any cleaning materials on your appliance, check that they are suitable and that their use is recommended by the manufacturer.

Cleaners that contain bleach should **NOT** be used as they may dull the surface finishes. Harsh abrasives should also be avoided.

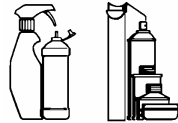

## CLEANING THE OUTSIDE OF THE APPLIANCE

Do not use abrasive cleaning materials e.g. abrasive cream cleaners, wire wool pads or scourers on painted or printed finishes as damage may occur. Regularly wipe over the control panel, control knobs, handles, doors and appliance sides using a soft cloth and hot soapy water. To prevent streaking, finish with a soft cloth.

Stainless Steel cream cleaners are abrasive and should be avoided as they may dull the surface finish. Any spillage on the stainless steel finish must be wiped off immediately.

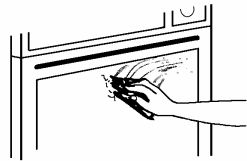

Do not attempt to remove any of the control knobs from the appliance as this may cause damage and is a safety hazard.

Under no circumstances should the door assembly be detached from the product for cleaning.

## CLEANING THE CONTROL KNOBS AND HANDLES

It is strongly recommended that only hot soapy water is used for cleaning the control knobs and door handles. ANY OTHER CLEANING MATERIALS WILL DULL THE SURFACE FINISH.

## REMOVING AND REPLACING THE WIREWORK RUNNERS

The wirework runners in the grill and oven can be removed for cleaning.

1. Remove all shelves and furniture from the oven.
2. Hold the wirework at the bottom, unclip from the cavity side and gently pull towards the centre of the oven.
3. Unhook the runner at the top and remove from the cavity.
4. To replace the runners, hook the wirework side runner into the cavity, slide back and press into place.

SIDE PANEL

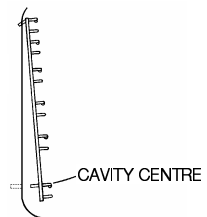

Ensure the wirework runners are firmly in position before replacing the oven shelves.

## CLEANING THE SHELVES, WIREWORK RUNNERS AND GRILL/OVEN FURNITURE

All removable parts, except the grill pan handle, can be washed in the dishwasher.

The grill pan, grill pan grid, oven shelves and wirework runners may be cleaned using a soap impregnated steel wool pad. Soaking first in hot soapy water will make cleaning easier.

### CLEANING INSIDE THE OVEN(S)

The sides and back of the grill/second oven and main oven compartments are coated with a special Stayclean coating. They should not be cleaned manually.

The vitreous enamel main oven base and grill/top oven compartment base can be cleaned using normal oven cleaners with care. Ensure that the manufacturers instructions are followed and that all parts are well rinsed afterwards.



Aerosol cleaners must not come into contact with elements, door seal or any painted finishes as this may cause damage.

---

### HINTS AND TIPS

---



Aerosol cleaners must not be used on Stayclean surfaces.

---

Stayclean surfaces destroy splashes of food and fats when the oven temperature is raised to around 220°C.

It is a good idea to run the oven for an hour or two per week to ensure continued good performance from the Stayclean finish.

Slight discolouration and polishing of the Stayclean surfaces may occur in time. This **DOES NOT** affect the Stayclean properties in any way.

Use minimal, if any, extra oil or fat when roasting meat, potatoes only require brushing with fat before cooking. Extra fat in the oven during roasting will increase splashing and soilage.

It is NOT necessary to add water to a meat tin when roasting. The water and the fat juices from the joint create excessive splattering during cooking – even at normal temperatures, as well as causing condensation.

Covering joints during cooking will also prevent splashing onto the interior surfaces. Removing the covering for the last 20-30 minutes will allow extra browning if required. Some large joints and turkeys especially benefit by this method of cooking, allowing the joint to cook through before the outside is over-browned.

## CLEANING THE DOORS

---



To prevent damaging or weakening the door glass panels avoid the use of the following:

- Household detergents and bleaches
  - Impregnated pads unsuitable for non-stick saucepans
  - Abrasive cleaning pads, scourers or steel wool pads
  - Chemical oven pads or aerosols
  - Rust removers
  - Bath/Sink stain removers
- 

## CLEANING BETWEEN THE OUTER AND INNER DOOR GLASS

The outer door glass is removable for cleaning.

### TO REMOVE THE OUTER DOOR GLASS

1. Open the door slightly to gain access to the two cross head screws on the top of the door.
2. Loosen the two screws using a Pozidrive screwdriver.
3. Hold the door glass securely in place with one hand remove the screws and washers with the other hand.

The screws and washers retain the trim on the top of the grill door. Note the position of the trim on the door.

4. Holding the door and glass with one hand, gently pull towards you and slightly lift the door glass with the other hand to disengage the panel from the location point at the bottom of the door. Gently release the door to close it.
5. Clean the outer and inner glass using hot soapy water or hob cleaner may be used. Do not use hob cleaner on the Stainless Steel or painted finishes. Do not try to clean the foil, which is inside the door. The foil is there to help keep the door cool, if it is damaged it will not work. Ensure that all parts are well rinsed and thoroughly dried before attempting to replace the outer door.

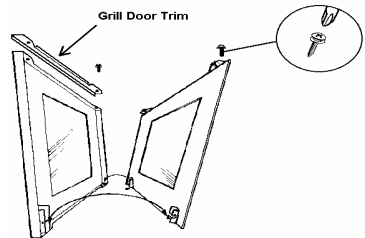

If the door glass panel becomes chipped or has deep scratches the glass will be weakened and must be replaced to prevent the possibility of the panel shattering. Please contact your local Service Force Centre who will be pleased to advise further.

---

## TO REPLACE THE OUTER GLASS

1. Holding the door glass panel with both hands, gently place the locators into the holes of the brackets at the bottom of the oven door.
2. Holding the door glass with your left hand, use your right hand to open the oven door. Bring the door gently towards the glass panel ensuring the screw location holes line up.
3. Place the trim in the correct position on the top of the grill door.
4. Hold the glass in place with one hand and insert the cross head screws with washers into the location holes with the other hand. Give the screws one turn to ensure the glass is secure.
5. Tighten the screws positively with a Pozidrive screwdriver before closing the oven door.

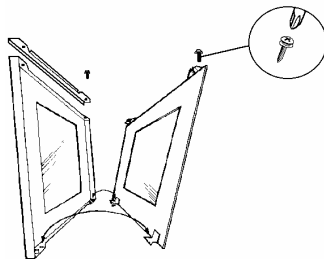

---

 **DO NOT attempt to use the oven without the glass being in place.**

---

## TO CLEAN THE INNER GLASS DOOR PANELS

Clean the inner glass door panels using a soft cloth and hot soapy water to which a little washing up liquid has been added. If the inner panel is heavily soiled, hob cleaner may be used. Do not use abrasive cleaning materials on the door glass. Ensure that all parts are well rinsed and thoroughly dried before attempting to replace the glass.

## REPLACING AN OVEN LIGHT BULB

---

 **Disconnect the appliance from the electricity supply before replacing the bulb.**

---

The type of bulb required is a 300°C, 25 watt small Edison Screw.

1. Make sure the appliance is cool before you replace a bulb
2. Open the oven door and remove the shelves and wirework runners.
3. Pull the glass bulb cover towards you and then pull it off. If necessary use a screwdriver to carefully lever off the cover, taking care not to damage the oven cavity.
4. Unscrew the bulb by turning it to the left.
5. Fit a new bulb and then replace the glass bulb cover.
6. Refit the wirework runners and replace the oven shelves.
7. Restore the electricity supply and reset the time of day.

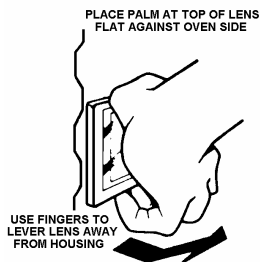

# SOMETHING NOT WORKING

Please carry out the following checks on your appliance before calling a Service Engineer. It may be that the problem is a simple one which you can solve yourself without the expense of a service call.

**In-guarantee customers should make sure that the checks have been made as the engineer will make a charge if the fault is not a mechanical or electrical breakdown.**

Please note that proof of purchase is required for in-guarantee service calls.

PROBLEM	POSSIBLE SOLUTION
The grill, ovens and timer do not work.	Check that the appliance has been wired in to the appliance supply and is switched on at the wall.  Check that the main appliance fuse is working. If you have checked the above: Allow the appliance to cool for a couple of hours. The appliance should now be working normally.
The grill and top oven work but the main oven does not.	Check that the time of day has been set on the clock. Check that the oven is set for manual cooking.
The grill does not work or cuts out after being used for a long period of time.	Ensure the cooling fan is running when the grill is on. If the cooling fan fails, the grill will not operate correctly. Contact your local Service Force Centre. Leave the grill door open and allow the grill to cool. After a couple of hours check that the grill works as normal.
The timer does not work.	Check that the instructions for the operation of the timer are being closely followed.
The indicator neons are not working correctly.	Check that you have selected only the function you require. Ensure all other controls are in the Off position.
The oven is not cooking evenly.	Check that the appliance is correctly installed and is level. Check that the recommended temperatures and shelf positions are being used.
The oven light fails to illuminate.	The oven light bulb may need replacing. If the Main Oven is set for automatic cooking the light will illuminate when the cook time begins.
The oven fan is noisy.	Check that the oven is level. Check that the shelves and bakeware are not vibrating in contact with the oven back panel.
The oven temperature is too high or too low.	Check that the recommended temperatures and shelf positions are being used. Be prepared to adjust the temperature up or down by 10°C to achieve the results you want. Refer to the main oven section.

# SERVICE AND SPARE PARTS



In the event of your appliance requiring service, or if you wish to purchase spare parts, please contact your local Service Force Centre by telephoning:-

**0870 5 929929**

Your telephone call will be automatically routed to the Service Force Centre covering your post code area.

For the address of your local Service Force Centre and further information about Service Force, please visit the website at [www.serviceforce.co.uk](http://www.serviceforce.co.uk)

Before calling out an engineer, please ensure you have read the details under the heading "Something Not Working?".

When you contact the Service Force Centre you will need to give the following details:

1. Your name, address and post code.
2. Your telephone number.
3. Clear and concise details of the fault.
4. The model and serial number of the appliance (found on the rating plate).
5. The purchase date.

**Please note that a valid purchase receipt or guarantee documentation is required for in-guarantee service calls.**

For Customer Service in Ireland please contact us at the address below:

Zanussi  
Electrolux Group (Irl) Ltd  
Long Mile Road  
Dublin 12  
Republic of Ireland

Tel: +353 (0) 1 4090751

Email: [service.eid@electrolux.ie](mailto:service.eid@electrolux.ie)

## CUSTOMER CARE DEPARTMENT

For general enquires concerning your Zanussi appliance, or for further information on Zanussi products, please contact our Customer Care Department by letter or telephone at the address below or visit our website at [www.zanussi.co.uk](http://www.zanussi.co.uk)

Customer Care Department  
Zanussi  
Major Appliances  
Addington Way  
Luton  
Bedfordshire  
LU4 9QQ  
Tel: 0870 5 727727 (\*)

\*calls to this number may be recorded for training purposes.

# GUARANTEE CONDITIONS

## Standard guarantee conditions

We, Zanussi, undertake that if within 24 months of the date of the purchase this Zanussi appliance or any part thereof is proved to be defective by reason only of faulty workmanship or materials, we will, at our option repair or replace the same FREE OF CHARGE for labour, materials or carriage on condition that:

- The appliance has been correctly installed and used only on the electricity supply stated on the rating plate.
- The appliance has been used for normal domestic purposes only, and in accordance with the manufacturer's instructions.
- The appliance has not been serviced, maintained, repaired, taken apart or tampered with by any person not authorised by us.
- All service work under this guarantee must be undertaken by a Service Force Centre.
- Any appliance or defective part replaced shall become the Company's property.
- This guarantee is in addition to your statutory and other legal rights.

Home visits are made between **8.30am** and **5.30pm** Monday to Friday. Visits may be available outside these hours in which case a **premium** will be charged.

## Exclusions

This guarantee does not cover:

- Damage or calls resulting from transportation, improper use or neglect, the replacement of any light bulbs or removable parts of glass or plastic.
- Costs incurred for calls to put right an appliance which is improperly installed or calls to appliances outside the United Kingdom.
- Appliances found to be in use within a commercial environment, plus those which are subject to rental agreements.
- Products of Zanussi manufacture which are not marketed by Zanussi.

## European Guarantee

If you should move to another country within Europe then your guarantee moves with you to your new home subject to the following qualifications:

- The guarantee starts from the date you first purchased your product.
- The guarantee is for the same period and to the same extent for labour and parts as exists in the new country of use for this brand or range of products.
- This guarantee relates to you and cannot be transferred to another user.
- Your new home is within the European Community (EC) or European Free Trade Area.
- The product is installed and used in accordance with our instructions and is only used domestically, i.e. a normal household.
- The product is installed taking into account regulations in your new country.

Before you move please contact your nearest Customer Care centre, listed below, to give them details of your new home. They will then ensure that the local Service Organisation is aware of your move and able to look after you and your appliances.

France	Senlis	+33 (0) 3 44 62 29 29
Germany	Nürnberg	+49 (0) 800 234 7378
Italy	Pordenone	+39 (0) 0434 39 4700
Sweden	Stockholm	+46 (0) 8 672 53 90
UK	Luton	+44 (0) 8705 727 727
Ireland	Dublin	+353 (0) 1 4090751

# TECHNICAL DETAILS

Voltage: 230-240 Volts AC 50Hz

Wattage: 5,6-6.1kW

Height: 720 mm

Width: 593 mm

Depth: 585 mm  
(excluding handles and knobs)

Weight: 55kg

**CE** This appliance complies with: European Council Directive 73/23/EEC.  
ECM Directive 89/336/EEC.  
CE Marking Directive 93/68/EEC.

Equipment according to ICE61000-3-4 provided  $R_{sec min} = 33$  as verified by the supply authority.



# INSTALLATION INSTRUCTIONS

## WARNINGS:



- This appliance must be installed by a qualified electrician/competent person. Safety may be impaired if installation is not carried out in accordance with these instructions.
- This appliance must be earthed.
- Do not remove the screws from the earth tab extending from the oven mains terminal block (Fig. 1).
- Before connecting the appliance make sure that the voltage of your electricity supply is the same as that indicated on the rating plate. This is situated on the lower front frame of the appliance and can be seen upon opening the door. Alternatively the rating plate may also be found on the back or top of some models (where applicable).
- Do not alter the electrical circuitry of this appliance.

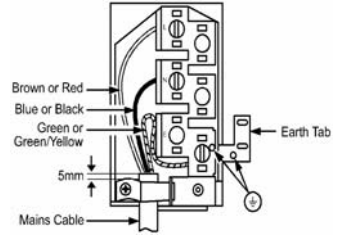

Fig.1

## CHOICE OF ELECTRICAL CONNECTION

- The appliance should be operated using at least 6mm<sup>2</sup> twin core and earth PVC insulated multicore cable. Please choose from the most appropriate after reading the different methods:
- By connecting the appliance to a cooker point having a double pole isolating switch providing at least 3mm contact separation in all poles and protected with a fuse or miniature circuit breaker at your mains fuse box.
- If you wish to connect an oven and a hob to a cooker point you can. Oven and hob units should be separately connected to a cooker point. See Fig. 2.

NOTE: It is good practice to :

- Fit an Earth Leakage Circuit Breaker to your house wiring.
- Wire your appliance to the latest IEE regulations.

## THINGS TO NOTE

- This appliance is designed to be fitted between cabinets with the recommended dimensions as shown Fig. 3 & 4.
- If there is an existing housing unit it must be removed.
- The dimensions given provide adequate air circulation around the unit within the cabinet, ensuring compliance with BS EN60-335.

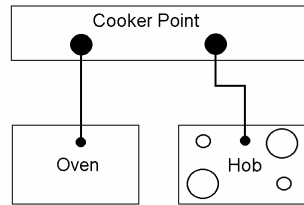

Fig. 2

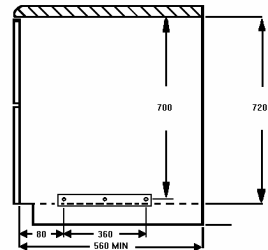

Fig. 3

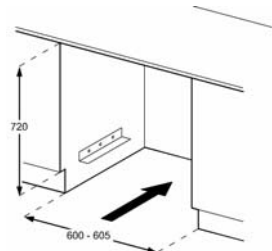

Fig. 4

- This appliance must not be installed on the wooden base board.
- Enquiries regarding the installation of the cooker point, if required, should be made to your Regional Electricity Company to ensure compliance with their regulations.
- The cooker point should be outside the cabinet but within 2m of the appliance to make it accessible to switch off the appliance in case of an emergency.
- To protect the hands, wear gloves when lifting the oven into its housing.



Do not lift the appliance by the handles.

#### NOTE: HOUSE CIRCUIT

Earth leakage and continuity tests must be carried out before the appliance is connected to the mains supply and re-checked after fitting.

#### PREPARING CABINET FOR FITTING OF OVEN

- Make sure the space between the cabinets is the correct size for the appliance to be fitted (Ref. Fig. 5 & 6).
- The plinth board spanning the space into which the appliance is to be installed should be removed.
- If the size of the space between adjacent cabinets is 605-610mm, then the cabinets should be modified so that the recommended dimension of at least 600-605mm is maintained. The modification should ideally be localised to ensure that after screw fixation the oven is securely fixed into position.
- The cabinets must be stable and level by firmly securing it to the wall or floor. If necessary, make arrangements to ensure the shelf upon which the oven will rest is level.
- The adjacent cabinets must be stable and level by firmly securing to the wall or floor. If necessary, make arrangements to ensure the work surface below which the oven will rest is level.
- Drill two pilot screw holes into the sides of the adjacent cabinets, in the positions indicated by Fig. 5.
- Fit the appliance mounting brackets using the two holes indicated in Fig. 7 to the adjacent cabinets (Ref. Fig. 5 & 6).
- Check that the mounting brackets are level. They can be adjusted if necessary by using the extra holes at the ends of the brackets. Once the brackets are level, drill a pilot hole through the central hole in the bracket and fit the remaining screw.

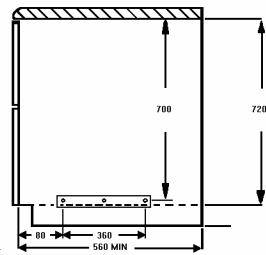

Fig. 5

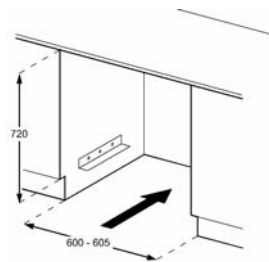

Fig. 6

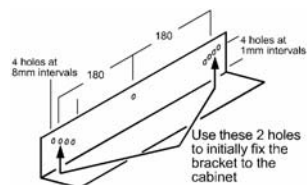

Fig. 7

## HOW TO FINISH UNPACKING

- Place packed appliance next to the space in which it will be installed.
- Remove the appliance packing except for bottom tray which should be left in position until the appliance is ready to be fitted into its cabinet.
- **NOTE:** It is imperative that the appliance is left in the base to protect both the appliance and the floor.
- Ensure the owner is given these operating instructions.



Important: Switch off at mains, miniature circuit breaker and if appropriate, remove fuse before commencing any electrical work.

## TO REMOVE COVER OF MAINS TERMINAL

From the rear of the appliance, remove mains input terminal cover to gain access to terminal block.

- First remove retaining screw with pozidrive screwdriver. See Fig. 8.

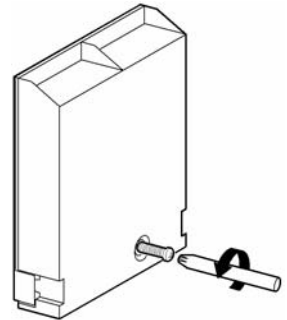

Fig. 8

- Prise cover loose using screwdriver in position (1) then lever off with screwdriver in position (2) at either side. See Fig. 9.

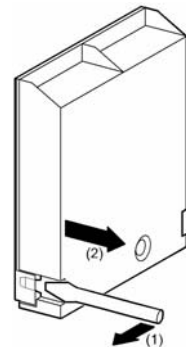

Fig.9

- Lift cover and remove screw from cable clamp. See Fig. 10.

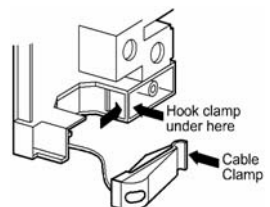

Fig.10

## CONNECTING TO THE MAINS TERMINAL



**Warning:** This appliance must be earthed.

- We recommend you use a new length of 6mm<sup>2</sup> twin core and earthed cable to ensure your safety.
- Make connection as shown in Fig. 11 by proceeding as follows:-
- Preform wires to the appropriate shape to suit fitting into the mains terminal block.
- Strip inner insulation on wires using wirestrippers.
- Twist the bared wires using pliers.
- Cut bared wires 10mm away from the end of the inner insulation. Where uninsulated Earth wires are used ensure they are suitably sheathed to leave 10mm bare wire to fit into the terminal.
- Clamp bare wires into the relevant terminal and check they are held by tugging each one in turn.
- Clamp the mains cable securely ensuring 5mm of the outer insulation is inside the terminal block and that the wires are not taugt but not so slack as to cause any fouling. See Fig. 11.
- Connect the remaining end to the mains cable to the cooker point/junction box.
- Place fuse/miniature circuit breaker in circuit and switch on at mains.

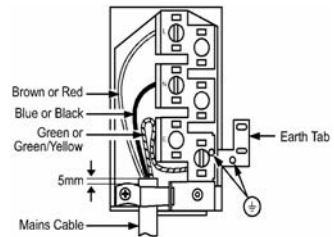

Fig.11

## CHECKING ELECTRICAL CONNECTIONS

- Correct electrical connection can be confirmed when switching on the appliance as the timer will be flashing.
- The electronic timer will flash on and off.

### NOTE: HOUSE CIRCUIT

Earth leakage and continuity tests must be carried out before the appliance is connected to the mains supply and re-checked after fitting.

## CONNECTING TO A HOB OR COOKER POINT

- Either follow in general terms the instructions for connecting to the terminal block or refer to the hob suppliers installation instructions.



Feed the cable through the cabinet and arrange to route the cable away from the appliance, which may become hot.

## FITTING INTO THE SPACE BETWEEN CABINETS



**IMPORTANT:** Ensure that the oven is switched off at the wall before any further work is carried out.

- Position the appliance in front of the cabinet. See Fig. 12.
- Take out all oven furniture before installation to reduce the weight you need to lift. The oven door should be taped to keep it closed whilst lifting.
- To place the appliance into the space between cabinetry follow the procedure below:
- N.B. Two people will be required to carry out the lifting procedure.

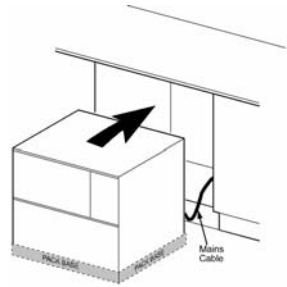

Fig. 12



**Warning:** Do not attempt to lift this appliance by the handle(s).

- Each person should squat either side of the appliance.
- Tilt the appliance so that your hands can support the underside of the appliance.
- Keeping your back straight raise the appliance to the correct height by straightening at the knees.
- Rest the rear underside of the appliance on the mounting brackets while your hands support the front.
- The appliance can be pushed fully into the space. Take care to avoid fouling the mains lead.
- Ensure the appliance is central and level.
- When the appliance is fully housed, screw the stability screws (supplied with the appliance) into the underside of the worksurface in the positions indicated (see Fig. 13), taking care not to distort the trim. It is advisable to turn each screw alternatively to avoid damaging the trim.
- Place the heat deflector flush with the edge of the worksurface, with the cork spacers up over (see Fig.14) and screw into position using the screws supplied with the appliance. Failure to do so may cause damage to the underside of the work surface.
- Replace the plinth board.
- Switch on the appliance and refer to the operating instructions.

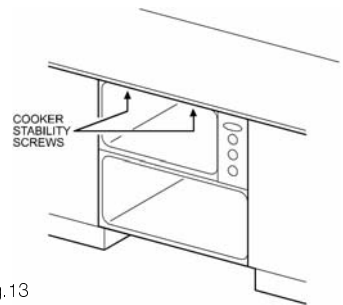

Fig.13

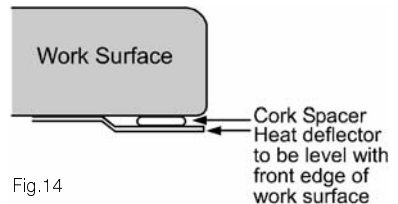

Fig.14





## **IMPORTANT NOTICE**

In line with our continuing policy of research and development, we reserve the right to alter models and specifications without prior notice.

This instruction booklet is accurate at the date of printing, but will be superseded if specifications or appearance are changed.

[www.zanussi.co.uk](http://www.zanussi.co.uk)

**Part Number: 311808800**

© Electrolux plc 2005



## Free Manuals Download Website

<http://myh66.com>

<http://usermanuals.us>

<http://www.somanuals.com>

<http://www.4manuals.cc>

<http://www.manual-lib.com>

<http://www.404manual.com>

<http://www.luxmanual.com>

<http://aubethermostatmanual.com>

Golf course search by state

<http://golfingnear.com>

Email search by domain

<http://emailbydomain.com>

Auto manuals search

<http://auto.somanuals.com>

TV manuals search

<http://tv.somanuals.com>