

ZANUSSI

BUILT-IN OVEN

ZPB 1260

INSTRUCTION BOOKLET

Important Safety Information

These warnings are provided in the interest of safety. You must read them carefully before installing or using the appliance.

During use

- During use the appliance becomes hot. Care should be taken to avoid touching heating elements inside the oven.
- This appliance has been designed for cooking edible foodstuff only and **must not** be used for any other purposes.
- Ensure that all control knobs are in the OFF position when not in use.
- Should you connect any electrical tool to a plug near this cooking appliance, ensure that electric cables are not in contact with it and keep them far enough from the heated parts of this appliance.
- If the appliance is out of order, disconnect it from the electric supply.
- Do not leave utensils containing foodstuffs, e. g. fat, oil or any inflammable product in or on the appliance. This could cause damage in case the appliance is inadvertently switched on.
- Always place the dripping pan in position to collect fat when using the grill or when cooking meat. Pour a little water into the dripping pan to avoid smoke and unpleasant smells.
- Always use oven gloves to remove pans from the oven.
- For hygiene and safety reasons, this appliance should be kept clean at all times. A build-up of fats or other foodstuff could result in a fire.
- Disconnect the appliance from the electrical supply, before carrying out any cleaning or maintenance work.
- Some parts of the appliance are covered by a shock-proof plastic film. Remove this film before using the oven.
- **Always stand back from the oven when opening the oven door during cooking or at the end of it to allow any build up of steam or heat to release.**
- Never use steam or steam machines to clean the appliance.
- We recommend that you supervise each step of the pyrolytic cleaning cycle. A power failure could cause a temperature increase of the surround or cabinet which could result in a fire.

It is important that the oven door, the door gasket, the oven light and the cavity are in good condition to avoid a fire.

A build-up of fat or other foodstuff could generate white smoke, irritating for your eyes and the respiratory system. We recommend that you stop the cleaning cycle using the ON/OFF button to cool down the oven cavity. **Do not disconnect the appliance from the electric supply.** When the oven has cooled down remove the food residue with a wet sponge.

- **The manufacturer disclaims any responsibility should all the safety measures not be carried out.**

Child Safety

- This appliance has been designed to be operated by adults and children under supervision. Young children **must not** be allowed to tamper with the controls or play near or with the oven.
- Accessible parts of this appliance may become hot when it is in use. Children should be **kept away** until it has cooled.

Installation

- It is mandatory that all operations required for the installation are carried out by a qualified or competent person, in accordance with existing rules and regulations.
- It is **dangerous** to alter the specification in any way.
- Once you have removed all packaging from the appliance, ensure that it is not damaged and the electric cable is in perfect condition. Otherwise, contact your dealer before proceeding with the installation.

Service

- Under no circumstances should you attempt to repair the appliance yourself. Repairs carried out by inexperienced persons may cause injury or serious malfunctioning. Refer to your local Service Centre. Always insist on genuine spare parts.

Environmental Information

- After installation, please dispose of the packaging with due regard to safety and the environment.
- When disposing of an old appliance, make it unusable, by cutting off the cable. Remove any door catches, to prevent small children being trapped inside.

MANUFACTURER:

ELECTROLUX HOME PRODUCTS ITALY S.p.A.
Viale Bologna, 298
47100 FORLÌ (Italy)

Contents

For the User

Important Safety Information	2
Description of the Oven	4
Control Panel	5
When the Oven is First Installed	6
Before the First Use of the Oven	6
Using the Oven	7
Programming the Oven	8
Safety and Energy Saving Functions	10
Hints and Tips	12
Cooking Tables	13
Cleaning the Oven	15
Pyrolitic Cleaning	15
Replacing the Oven Light	17
Cleaning the Oven Door	18
Something not Working	20
Service and Spare Parts	20
Customer Care Department	21
Guarantee Conditions	21

For the Installer

Installation	22
Technical Data	22
Electrical Connection	22
Building In	23

It is most important that this instruction book should be retained with the appliance for future reference. Should the appliance be sold or transferred, always ensure that the book is left with the appliance in order that the new owner can get to know the functions of the appliance and the relevant warnings.

Guide to use the instructions

The following symbols will be found in the text to guide you throughout the Instructions:



Safety Instructions



Step by step instructions for an operation



Hints and Tips



Environmental Information



This appliance complies with the following

E.E.C. Directives:

- * **73/23 - 90/683**
(Low Voltage Directive);
- * **93/68** (General Directives);
- * **89/336** (Electromagnetical Compatibility Directive).
and subsequent modifications

Description of the Oven

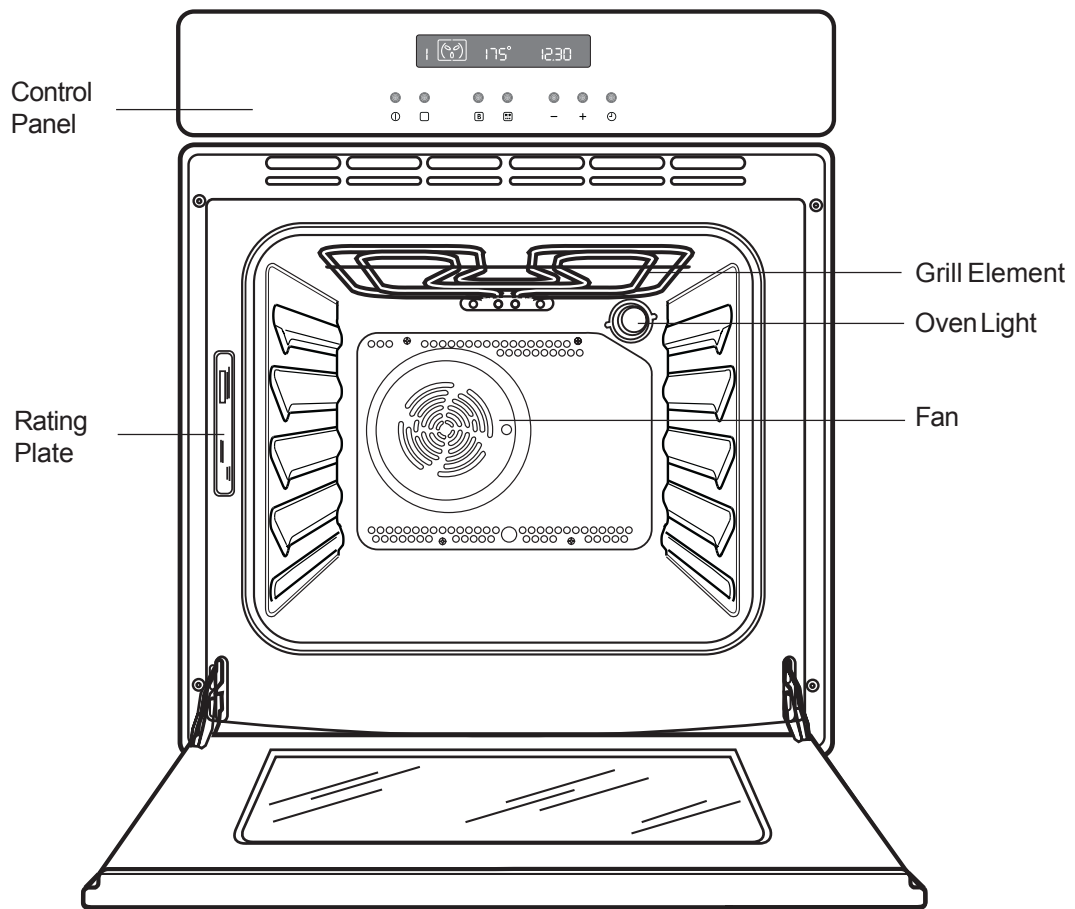

Oven accessories

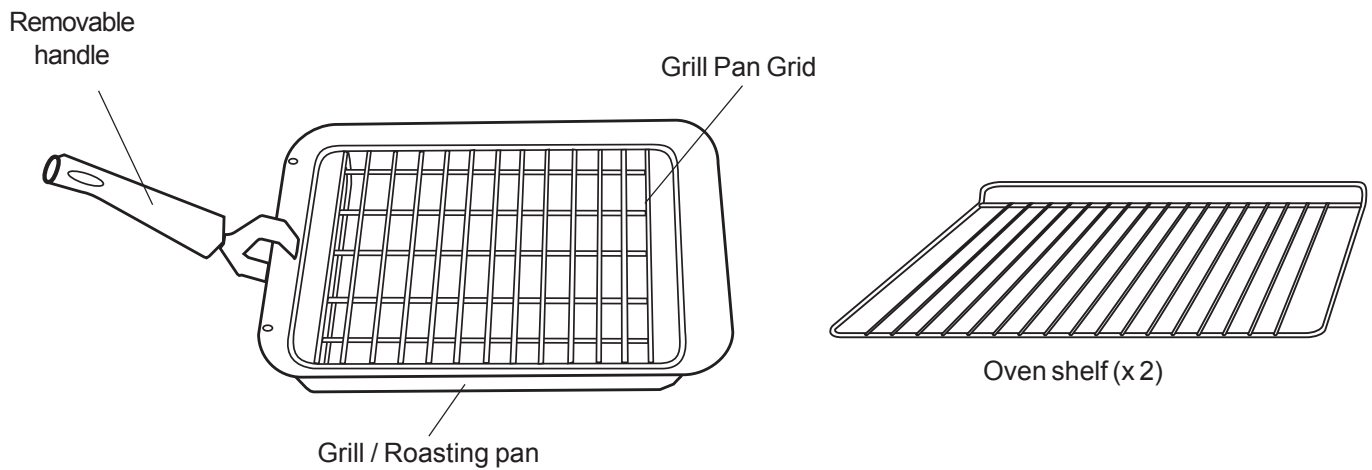

Control Panel

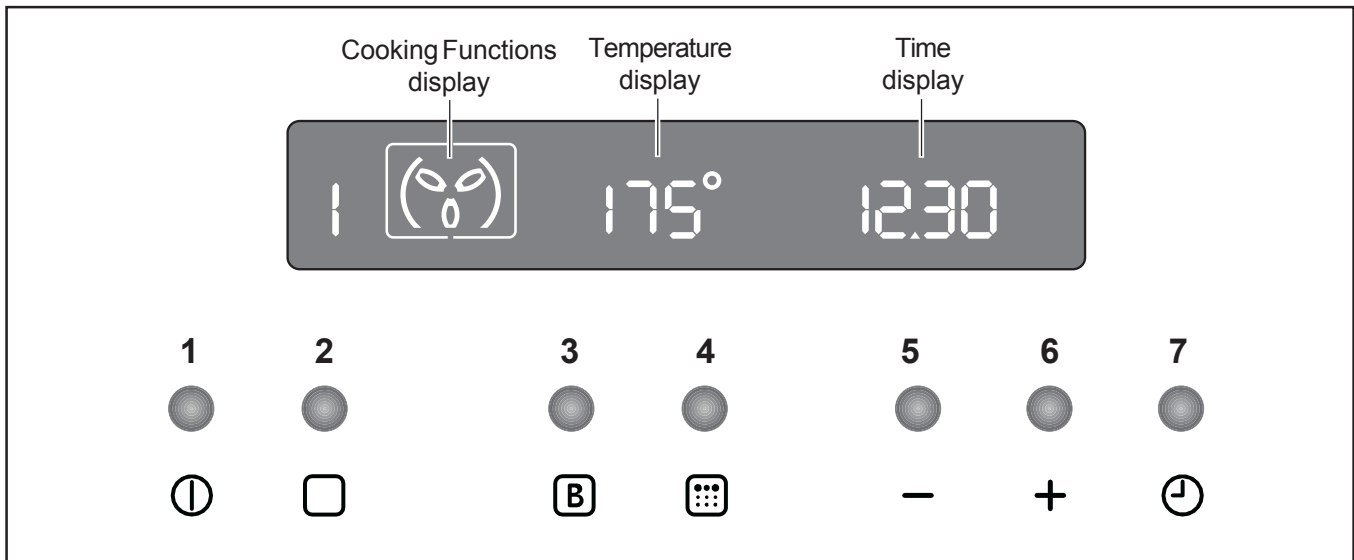

Push Buttons

1. ⓘ - ON / OFF
2. □ - Cooking Functions Control
3. B - Fast Heat Up Function
4. ■ - Pyrolitic Function
5. - - Decreasing Control (Time or Temperature)
6. + - Increasing Control (Time or Temperature)
7. ⌚ - Time Function

"On/Off" Push Button

The oven must be switched on before setting any cooking function or programme. When button ⓘ is pressed, the oven symbol will come on the display and the oven light will switch on (Fig. 1).

To switch off the oven, you can press button ⓘ at any time. Any cooking function or programme will stop, the oven light will switch off and the time display will show the time of day only.

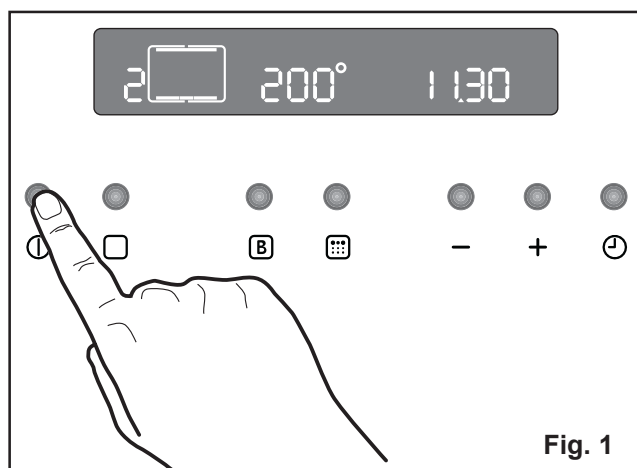

All the oven functions are controlled by an electronic programmer.

You can select any combination of cooking function, cooking temperature and automatic timing.

Special functions

The following functions can be activated by pressing two buttons at the same time:

- Child lock: press button □ and button "-".
- Beep on touch: press button □ and button "+".
- Demo mode: press button B and button "+".

For further details, see chapter "Safety and Energy Saving functions".

i In the event of a power failure, the programmer will keep all the settings (time of day, programme setting or programme in operation) for about 3 minutes. If power is not restored within 3 minutes, all the settings will be cancelled. When the power is restored, the numbers in the display will flash, and the clock/timer has to be reset.

Cooling fan

The cooling fan operates during cooking. Air is expelled through vents between the oven door and the control panel, as shown in the diagram.

The cooling fan may run on after the oven is switched off to keep the controls cool. This is quite normal.

The Safety Thermostat





This oven is provided with a safety thermostat. In case of malfunctioning of the main thermostat, and consequent over-heating, the safety device will stop the power supply to the appliance. If this happens, call your local Service Force Centre. Under no circumstances should you attempt to repair the appliance yourself.

When the oven is first installed

When the oven is first connected to the electrical supply, the display will automatically show 12:00 and the symbol  will flash.

Ensure the correct time of day is set before using the oven.

To set the correct time of day :

1. press time function button  and, while the symbol  is flashing, set the correct time of day by pressing buttons “-” or “+” (Fig. 2).
The time arrow symbol  will disappear about 5 seconds after the correct time is displayed.
2. if the symbol  is not flashing anymore, press time function button twice.
Then, proceed as described in point 1.

 It is possible to set the time of day only when the oven is off.

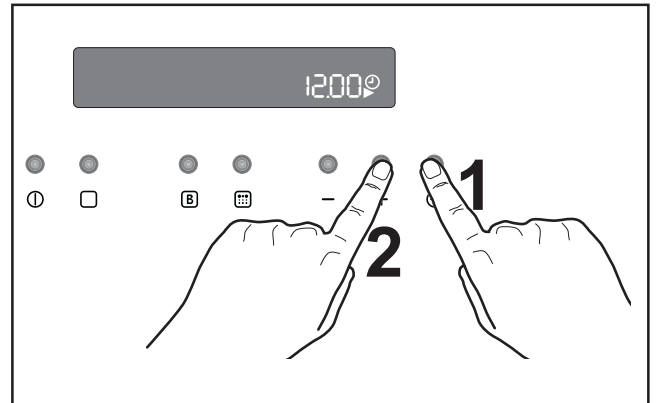



Fig. 2



Before the First Use of the Oven

 Remove **all packaging**, both inside and outside the oven, before using the oven.

The oven will work only if the time of day has been set.

 Before first use, the oven should be heated without food.

During this time, an unpleasant odour may be emitted. This is absolutely **normal**, and is caused by residues of manufacturing.

1. set the time of day with the electronic programmer (see paragraph "To set the correct time of day").
2. press button  to switch on the oven.
3. press button  twice and select the "Conventional Cooking" function  (Fig. 3).
4. set the temperature to 250°C using the increasing push button “+”.
5. Allow the oven to run **empty** for approximately 45 minutes.
6. open a window for ventilation.

This procedure should be repeated with the "Full Grill"  function for approximately 5-10 minutes.

 Once this operation is carried out, let the oven cool down, then clean the oven cavity with a soft cloth soaked in warm water to which a little mild washing-up liquid has been added.

Before cooking for the first time, carefully wash the oven accessories.

 **To open the oven door, always hold the handle in the centre (Fig. 4).**

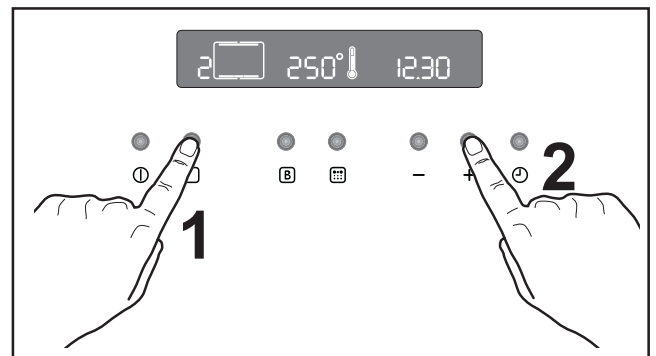

Fig. 3

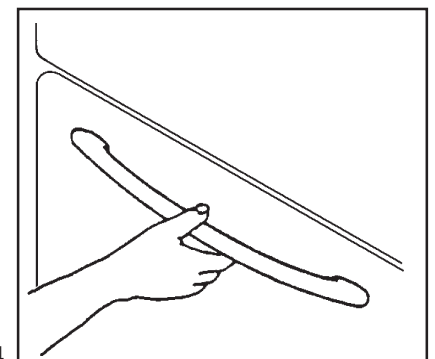

Fig. 4

Using the Oven

Shelf Positions

The oven shelves can be placed at different heights to obtain better cooking results.
The levels are shown in Fig. 5.



Always cook with the oven door closed.

- Always use oven **gloves** to remove and replace food in the oven.
- Always ensure that you are using oven proof baking trays, oven dishes, etc.
- Do not place baking trays, cake tins or aluminium foil directly on the base of the oven. This could cause a heat build-up which could affect the performance of the oven and damage the oven enamel.
- Carefully supervise cooking with **fat or oil**, since these types of foodstuff can result in a fire, if overheated. For the same reason, be careful when placing or removing food in the oven, not to let any fat or oil fall on the oven base. If this happens, carefully clean the oven to avoid unpleasant smells or smoke.

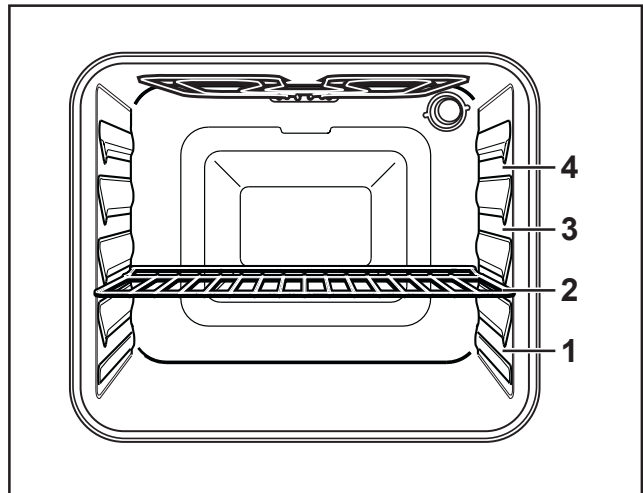







Fig. 5

How to select a Cooking Function

1. Switch on the oven by pressing the  button.
2. Press button  to select the required oven function.
Each time button  is pressed, a cooking symbol will appear in the display and the corresponding cooking function number will appear to the left of the currently selected cooking function symbol (Fig. 6).
3. If the pre-set temperature is not suitable, press button “-” or “+” to adjust the temperature in 5 degree steps.
- as soon as the oven heats up, the thermometer symbol  rises slowly, indicating the degree to which the oven is currently heated;
When the required temperature is reached, an acoustic alarm will sound for a short time and the thermometer symbol  will light permanently.

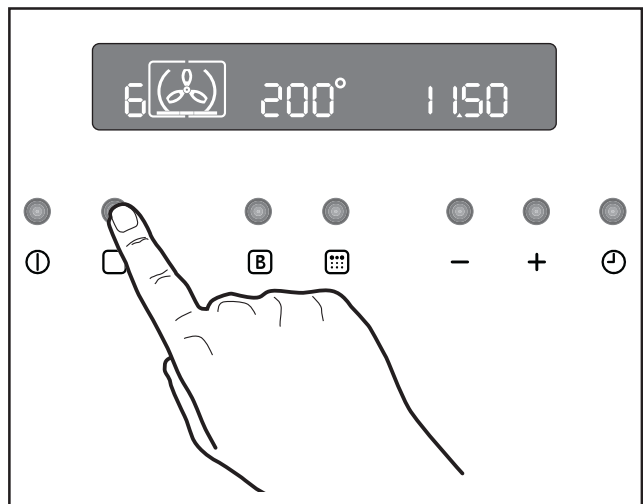



Fig. 6

How to set the temperature and cooking time

1. Press button “-” and “+” to increase or decrease the pre-set temperature while the “” symbol is flashing (Fig. 7).
2. Press button “-” and “+” to increase or decrease the pre-set cooking time while the symbol  is flashing.

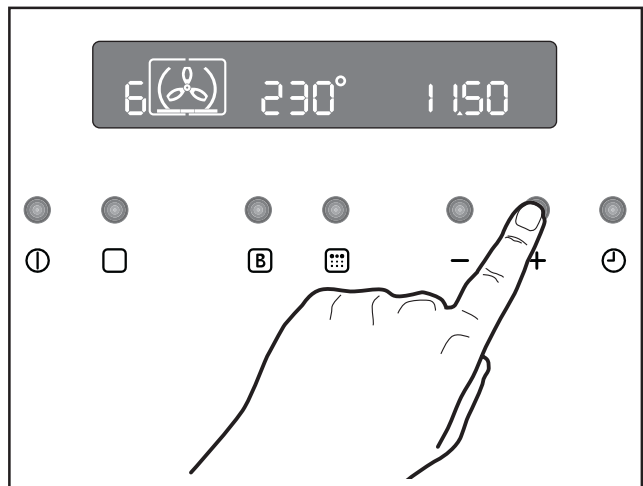











Fig. 7

Cooking Functions



The following list displays in sequence all the cooking functions available.

- 1  **Fan cooking** - This setting allows you to roast or roast and bake simultaneously using any shelf, without flavour transference. Pre-set temperature: 175 °C.
- 2  **Conventional cooking** - The heat comes from both the top and bottom element, ensuring even heating inside the oven. Pre-set temperature: 200 °C. **The maximum setting temperature is 285 °C.**
- 3  **Full Grill** - The full grill element will be on. Recommended for large quantities. Pre-set temperature: 250 °C.
- 4  **Grill** - can be used for grilling small quantities. Pre-set temperature: 250 °C.
- 5  **Thermal Grilling** - This function offers an alternative method of cooking food items, normally associated with conventional grilling. The grill element and the oven fan operate together, circulating hot air around the food. Pre-set temperature: 180 °C. **Select a maximum temperature of 200 °C.**



- 6  **Pizza Oven** - The bottom element provides direct heat to the base of pizzas, quiches or pies, while the fan ensures air is circulated to cook the pizza toppings or pie fillings. Pre-set temperature: 175 °C.
- 7  **Bottom heating element** - The heat comes from the bottom of the oven only, to allow you to finish your dishes. Pre-set temperature: 250 °C.
- 8  **Top heating element** - The heat comes from the top of the oven only, to allow to you finish your dishes. Pre-set temperature: 250 °C.
- 9  **Defrosting** - The oven fan operates without heat and circulates the air, at room temperature, inside the oven. This function is particularly suitable for defrosting delicate food which could be damaged by heat, e.g. cream filled gateaux, iced cakes, pastries, bread and other yeast products.
- 10  **Pyrolytic cleaning** - This function allows you to clean thoroughly the oven cavity.



Programming the Oven

How to set the minute minder

1. Press time function button  to select the Minute Minder Function. The relevant symbol  will flash and the control panel will display "0.00" (Fig. 8).
2. Press button "+" to select the required time. Maximum time is 23 hours 59 minutes. After the setting is carried out, the Minute Minder will wait 3 seconds and then start running.
3. When the programmed time has elapsed, an acoustic alarm will be heard.
4. To switch off the acoustic alarm, press any button.

 **The oven will NOT switch off if in use. The Minute Minder function can also be used when the oven is off.**

To use or to change the Minute Minder setting:
press time function button  until the symbols  and  flash.
It is now possible to change the Minute Minder setting by pressing button "+" or "-".

To cancel the Minute Minder:
press time function button  until the symbols  and  flash.
Press button "-" to decrease the time until "0.00" shows in the display (Fig. 9).

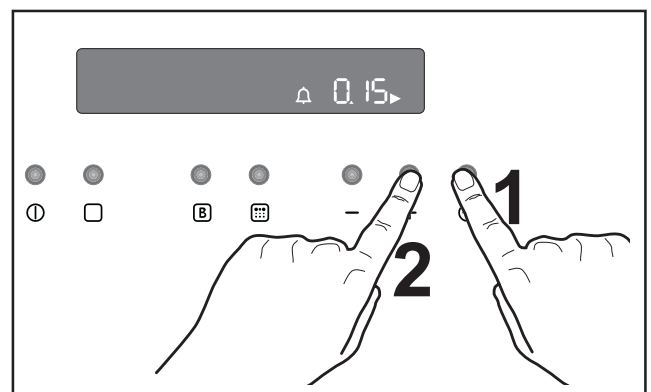

Fig. 8

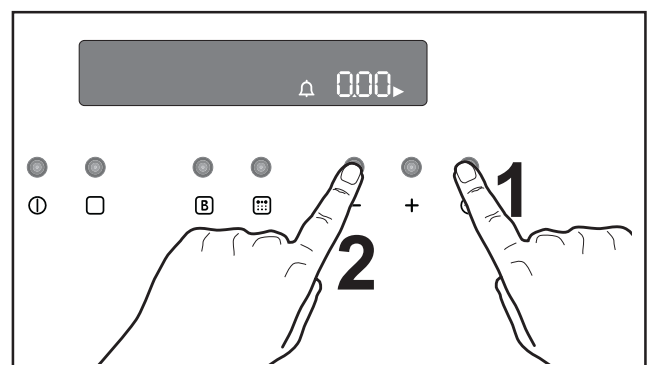





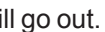

Fig. 9



To programme the Oven to switch off

1. Switch the oven on, place food in the oven, select a cooking function and adjust the cooking temperature, if required.
2. Press time function button  to select the "Cooking Duration" function. The "Cooking Duration" symbol  will flash and the control panel will display "0.00" (Fig. 10).
3. While the symbol  is flashing, press button "+" to select the required time. Maximum time is 23 hours 59 minutes. The programmer will wait 3 seconds and then start running.
4. When cooking time is over, the oven will be switched off automatically and an acoustic alarm will be heard while the control panel will display "0.00".
5. To switch off the acoustic alarm, press button .



If you press any other button the alarm will stop (Fig. 11). Then, you need to reset the programmer display by pressing button .

The control panel will display the time of day and the Cooking Duration symbol  will go out.

To cancel the Cooking Duration Time:

- press time function button  until the symbol  flashes.
- press button "-" to decrease the time until the display shows "0.00" (Fig. 12).

To programme the Oven to switch on and off

1. Carry out the "Cooking Duration" setting as described in the relevant chapter.
2. Press time function button  until the "End of Cooking" function  is selected and the relevant symbol flashes. The control panel will display the end of cooking time (that is, the actual time + cooking duration time) (Fig. 13).
3. Press button "+" to select the required end of cooking time.
4. After the setting is carried out, the programmer will wait 3 seconds and then start running.
5. The oven will switch on and off automatically. The end of cooking will be marked by an acoustic alarm.
6. To switch off the acoustic alarm, press any button.

To cancel the programme, simply cancel the Cooking Duration Time.

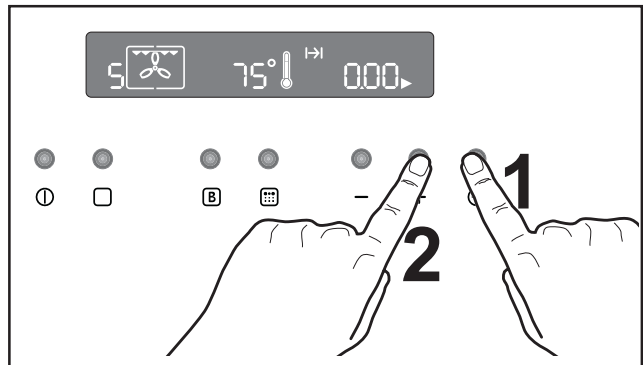

Fig. 10

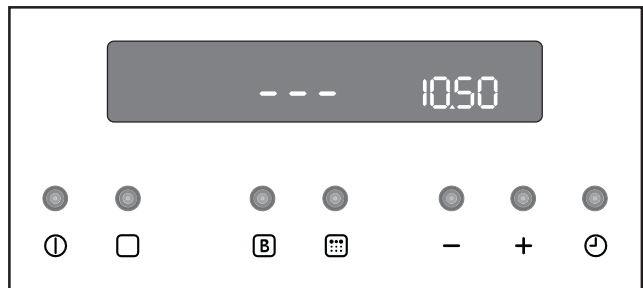

Fig. 11

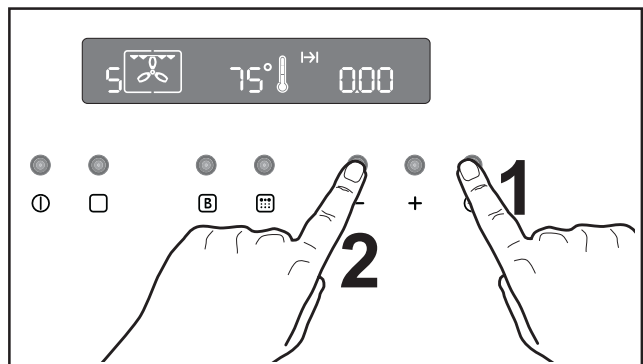

Fig. 12

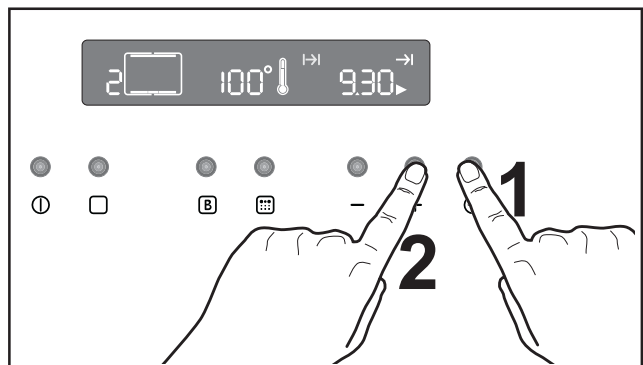

Fig. 13

Safety and Energy Saving Functions

Safety Cut-Off Function

The oven will switch off automatically if any change of setting is made, according to the table below (Fig. 14).

If temperature setting is:	the oven will switch off:
250°C	after 1 1/2 hours
from 200 up to 245°C	after 5,5 hours
from 120 up to 195°C	after 8,5 hours
less than 120°C	after 12 hours

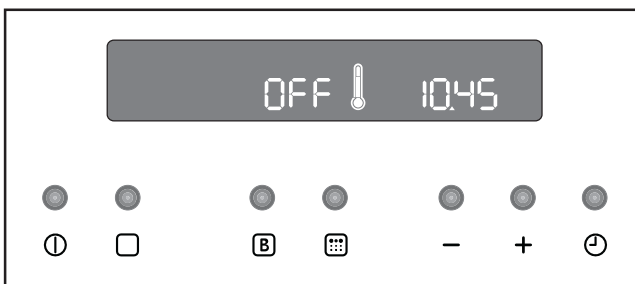

Fig. 14

Child Safety Function

To avoid children switching on the oven, it is possible to lock the oven controls.

1. Turn off the oven by pressing button ⓘ.
2. Press buttons □ and “-” at the same time and keep them pressed for about 3 seconds. An acoustic signal will be emitted and the indication ‘SAFE’ will appear in the display (Fig. 15).
3. The oven is now locked. Neither oven functions nor temperatures can be selected.

To unlock the oven:

Press buttons □ and “-” at the same time and keep them pressed for about 3 seconds. An acoustic signal will be emitted and the indication ‘SAFE’ will go off. The oven can now be operated.

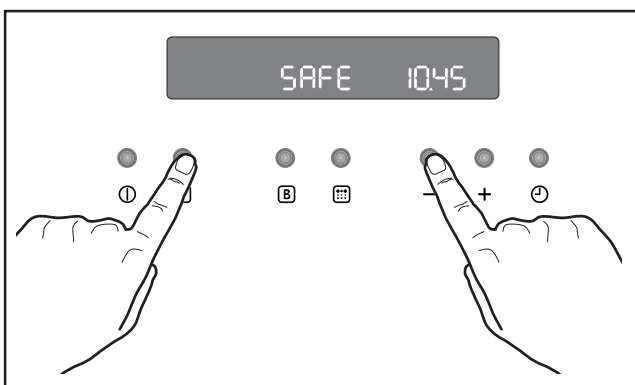

Fig. 15

"Fast Heat Up" function (Booster)

After a cooking function has been selected and the temperature has been adjusted, the cavity will gradually heat up until the selected temperature is reached. This will take from 10 to 15 minutes, depending on selected function and temperature.

If it is necessary to reach the required temperature in a shorter time, the fast heat up function can be used.

1. Switch the oven on by pressing button ⓘ.
2. Set the required cooking function and temperature as explained in the previous pages.
3. Set the temperature by pressing button “-” or “+”. The temperature will appear in the display.
4. Press button B. The temperature display will show “FHU” (Fig. 16).
5. Press button □ and the symbol “◦” will flash for approximately 10 seconds. Now it is possible to select the required temperature by pressing button “-” or “+”.
6. When the required temperature is reached, an acoustic alarm will sound for a short time, and the temperature display will revert to the set temperature.

This function can be used with any cooking function or temperature.

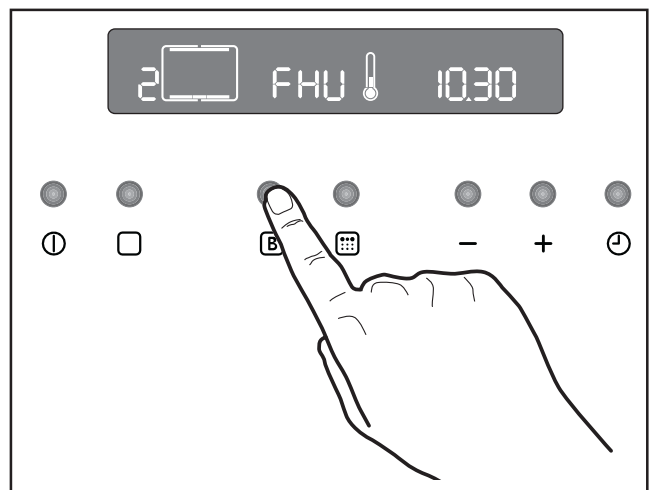

Fig. 16

Residual Heat Function

When a Cooking Duration time is set, the oven will automatically switch off a few minutes before the end of the programmed time, and use the residual heat to finish your dishes without energy consumption. All current settings will be displayed until the Cooking Duration time is over.

This function will not operate when the Cooking Duration time is less than 15 minutes.

Demo mode

This mode is intended to be used in the shops to demonstrate the oven functionality without any power consumption except the oven lamp. To activate this function the appliance should be in stand-by mode.

- Press button **B** and “+” for approximately 2 seconds (Fig. 17). An acoustic alarm will sound for a short time.
- Press button **ⓘ** and the “id” indication will appear in the display.

All oven functions can be selected.

The thermometer symbol  will not flash anymore and “id” indication will be replaced by number digits.

Follow the above described procedure to disable the demo mode.

Error code

The electronic programmer does a continuous diagnostic check of the system. If some parameters are not correct, the control unit will stop the activated functions and the corresponding error code (letter “E” followed by number digits) will be displayed.

For further details, refer to chapter “Something not working” on page 20.

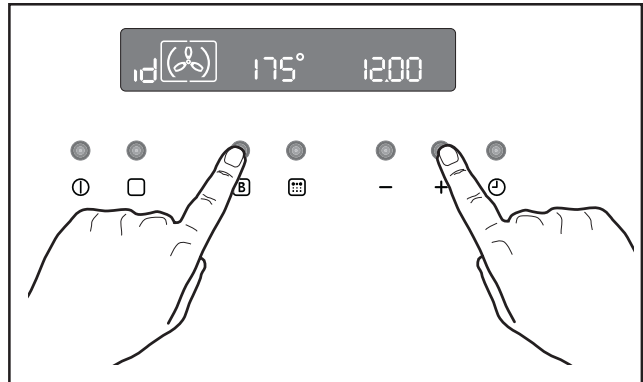

Fig. 17

Hints and Tips



Always cook with the oven door closed.

The oven is supplied with an exclusive system which produces a natural circulation of air and the constant recycling of steam. This system makes it possible to cook in a steamy environment and keep the dishes soft inside and crusty outside. Moreover, the cooking time and energy consumption are reduced to a minimum. During cooking steam may be produced which can be released when opening the oven door. This is absolutely normal.



However, always stand back from the oven when opening the oven door during cooking or at the end of it to allow any build up of steam or heat to release.



When food is heated, it produces steam in the same way as a boiling kettle does. When steam comes in contact of the oven door glass, it will condense and produce water droplets.

To reduce condensation, ensure the oven is well heated before placing food in the oven cavity. A short oven pre-heating (about 10 minutes) will then be necessary before any cooking.

We recommend you to wipe away condensation after each use of the appliance.

Hints and Tips on Cooking Fish and Meat

You can place meat in oven proof dishes, or directly on the oven shelf. In this case, remember to place the drip tray in the first position from the bottom with some water in it. The dripping pan will avoid the falling of melted fat on the oven base.

White meat, poultry and fish in general, need to be cooked at a medium temperature (between 150 and 175 °C). If you need to cook red meat (slightly browned on the outside and more gently cooked in the inside), a higher temperature (between 200 and 250 °C) for a short time is recommended.

Hints and Tips on baking

Cakes usually need to be cooked at a medium temperature (between 150 and 200 °C).

A short oven pre-heating (about 10 minutes) is recommended when cooking cakes or baking. Once the cooking has been started, keep the oven door closed during all the cooking time, and check the cooking results through the oven door glass.

Hints and Tips on grilling

If you need to grill meat or fish, place them directly on the shelf after spreading a little oil on them.

In the grill function, heat comes only from the top element. Therefore, you need to adjust the cooking level depending on meat or fish's thickness.

Always remember to place the dripping pan in the lower position with some water in it.



When using the Thermal Grill Function, select a maximum temperature of 200°C



Warning! - Do not place objects on the bottom of the oven and do not cover it with aluminium foil while cooking, as you can damage the enamelled surfaces and the food you are cooking.

Always place pans, heat-resisting pans and aluminium foils on the oven shelves.

Warning! - Be careful when you insert and extract the grid and the drip tray from the oven in order not to damage the enamelled surfaces of the oven cavity.

Cooking times

Cooking times vary according to the type of food to be cooked, its consistency, and volume. We suggest that you take particular note of your first cooking experiments with the oven, since operating in the same conditions for the same dishes you will of course obtain similar results. Only experience will enable you to make the appropriate changes to values given on charts.

Cooking Tables

i Cooking times do not include pre-heating time.
A short oven pre-heating (about 10 minutes) is necessary before any cooking.

Traditional cooking and fan ducted cooking



Weight (gr.)	TYPE OF DISH	Traditional Cooking		Fan Oven		Cooking time minutes	NOTES
		Level 	temp. °C	Level 	temp. °C		
	CAKES						
	Whisked recipes	2	170	2	160	45 ~ 60	In cake mould on the shelf
	Shortbread dough	2	170	2 (1 and 3)*	160	20 ~ 30	In cake mould on the shelf
	Butter-milk cheese cake	1	160	2	150	60 ~ 80	In cake mould on the shelf
	Apple cake	1	180	2 (1 and 3)*	170	40 ~ 60	In cake mould on the shelf
	Strudel	2	175	2	150	60 ~ 80	In cake tin on the shelf
	Jam-tart	2	175	2 (1 and 3)*	160	30 ~ 40	In cake mould on the shelf
	Fruit cake	1	175	1	160	45 ~ 60	In cake mould
	Sponge cake	1	175	2	160	30 ~ 40	In cake mould on the shelf
	Christmas cake	1	170	1	160	40 ~ 60	In cake mould on the shelf
	Plum cake	1	170	1	160	50 ~ 60	In cake mould on the shelf
	PASTRIES						
	Small cakes	2	170	2 (1 and 3)*	160	25 ~ 35	In baking tray
	Biscuits	3	190	3	170	15 ~ 25	In baking tray
	Meringues	2	100	2	100	90 ~ 120	In baking tray
	Buns	2	190	2	180	12 ~ 20	In baking tray
	Pastry: Choux	2	200	2 (1 and 3)*	190	15 ~ 25	In baking tray
	BREAD AND PIZZA						
1000	White bread	1	190	2	180	40 ~ 60	2 pieces in baking tray
500	Rye bread	1	190	1	180	30 ~ 45	In bread pan on the grid
500	Bread rolls	2	200	2	175	20 ~ 35	6-8 rolls in baking tray
250	Pizza	1	200	2 (1 and 3)*	190	15 ~ 30	On baking tray on the grid
	FLANS						
	Pasta flan	2	200	2 (1 and 3)*	175	40 ~ 50	In mould on the shelf
	Vegetable flan	2	200	2 (1 and 3)*	175	45 ~ 60	In mould on the shelf
	Quiches	1	200	2 (1 and 3)*	180	35 ~ 45	In mould on the shelf
	Lasagne	2	180	2	160	45 ~ 65	In mould on the shelf
	Cannelloni	2	200	2	175	40 ~ 55	In mould on the shelf
	MEAT						
1000	Beef	2	190	2	175	50 ~ 70	On shelf and dripping pan
1200	Pork	2	180	2	175	100 ~ 130	On shelf and dripping pan
1000	Veal	2	190	2	175	90 ~ 120	On shelf and dripping pan
1500	English roast beef						
1500	rare	2	210	2	200	50 ~ 60	On grid and dripping pan
1500	medium	2	210	2	200	60 ~ 70	On grid and dripping pan
1500	well done	2	210	2	200	70 ~ 80	On grid and dripping pan
2000	Shoulder of pork	2	180	2	170	120 ~ 150	With rind-in dripping pan
1200	Shin of pork	2	180	2	160	100 ~ 120	2 pieces-in dripping pan
1200	Lamb	2	190	2	175	110 ~ 130	Leg-in dripping pan
1000	Chicken	2	190	2	175	60 ~ 80	Whole-in dripping pan
4000	Turkey	2	180	2	160	210 ~ 240	Whole-in dripping pan
1500	Duck	2	175	2	160	120 ~ 150	Whole-in dripping pan
3000	Goose	2	175	2	160	150 ~ 200	Whole-in dripping pan
1200	Rabbit	2	190	2	175	60 ~ 80	Cut in pieces
1500	Hare	2	190	2	175	150 ~ 200	Cut in pieces
800	Pheasant	2	190	2	175	90 ~ 120	Whole
	FISH						
1200	Trout/Sea bream	2	190	2 (1 and 3)*	175	30 ~ 40	3-4 fishes
1500	Tuna fish/Salmon	2	190	2 (1 and 3)*	175	25 ~ 35	4-6 fillets

(*) If you need to cook more than one dish at the same time, we recommend you to place them on the levels quoted between brackets.

If you wish to cook more than one dish at the same time, we suggest that you change the cooking levels of your dishes during the last 5-10 minutes in order to obtain a more uniform colour of your dishes.

i Cooking times do not include pre-heating time.
A short oven pre-heating (about 10 minutes) is necessary before any cooking.

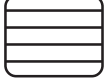
Grilling -



TYPE OF DISH	Quantity		Level 	Temperature °C	Cooking time (minutes) 	
	Pieces	Weight			Upper side	Lower side
Fillet steaks	4	800	3	250	12 ~ 15	12 ~ 14
Beef-steaks	4	600	3	250	10 ~ 12	6 ~ 8
Sausages	8	—	3	250	12 ~ 15	10 ~ 12
Pork chops	4	600	3	250	12 ~ 16	12 ~ 14
Chicken (cut in two)	2	1000	3	250	30 ~ 35	25 ~ 30
Kebabs	4	—	3	250	10 ~ 15	10 ~ 12
Chicken (breast)	4	400	3	250	12 ~ 15	12 ~ 14
Hamburger	6	600	3	250	10 ~ 15	8 ~ 10
Fish (fillets)	4	400	3	250	12 ~ 14	10 ~ 12
Sandwiches	4-6	—	3	250	3 ~ 7	—
Toast	4-6	—	3	250	2 ~ 4	2 ~ 3

Thermal grilling

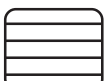
When using the thermal grill cooking function, select a maximum temperature of 200°C.

TYPE OF DISH	Quantity (gr.)	Level 	Temperature °C	Time in minutes	
				lower side	upper side
Rolled joints (turkey)	1000	3	200	30 ~ 40	20 ~ 30
Chicken (cut in two)	1000	3	200	25 ~ 30	20 ~ 30
Chicken legs	—	3	200	15 ~ 20	15 ~ 18
Quail	500	2	200	25 ~ 30	20 ~ 25
Vegetable gratin	—	3	200	20 ~ 25	—
St. Jacques shells	—	3	200	15 ~ 20	—
Mackerel	—	3	200	15 ~ 20	10 ~ 15
Fish slices	800	3	200	12 ~ 15	8 ~ 10

"Pizza" function

Weight (gr.)	TYPE OF DISH	Level 	Temperature °C	Cooking time  minutes	NOTES
700	Pizza, large	1	200	15 ~ 25	in baking tray
500	Pizza, small	1	200	10 ~ 20	in mould on the shelf
500	Flat cake	1	200	15 ~ 25	in baking tray

i The oven temperatures are intended as a guide only. It may be necessary to increase or decrease the temperatures to suit individual preferences and requirements.

Cleaning the Oven



Before cleaning always allow the cooling fan to cool the oven down before switching off at the electricity supply.

This appliance cannot be cleaned with steam or with a steam cleaning machine.

The oven should be kept clean at all times. A build-up of fats or other foodstuffs could result in a fire, especially in the grill pan.

Cleaning materials

Before using any cleaning materials on your oven, check that they are suitable and that their use is recommended by the manufacturer.

Cleaners that contain bleach should NOT be used as they may dull the surface finishes. Harsh abrasives should also be avoided.

External cleaning

Regularly wipe over the control panel, oven door and door seal using a soft cloth well wrung out in warm water to which a little washing-up liquid has been added.



To prevent damaging or weakening the door glass panels avoid the use of the following:

- Household detergent and bleaches
- Impregnated pads unsuitable for non-stick saucepans
- Brillo/Ajax pads or steel wool pads
- Chemical oven pads or aerosols
- Rustremovers
- Bath/Sink stain removers

Clean the outer and inner door glass using warm soapy water. Should the inner door glass become heavily soiled it is recommended that a cleaning product such as Hob Brite is used. Do not use paint scrapers to remove soilage.



DO NOT clean the oven door while the glass panels are warm. If this precaution is not observed the glass panel may shatter.

If the door glass panel becomes chipped or has deep scratches, the glass will be weakened and must be replaced to prevent the possibility of the panel shattering. Contact your local Service Force Centre who will be pleased to advise further.

Oven Shelves

To clean the oven shelves, soak in warm soapy water and remove stubborn marks with a well wetted soap impregnated pad. Rinse well and dry with a soft cloth.

Pyrolytic cleaning

The oven cavity is coated with a special enamel resistant to high temperatures.

During the pyrolytic cleaning operation, the temperature inside the oven can reach about 500 °C thus burning food residuals.

For your security, during the pyrolytic cleaning operation, the oven door automatically locks when the temperature inside the oven approaches about 300 °C.

Upon completion of the cleaning operation, the oven door will be locked until the oven cavity has cooled down.

The cooling fan operates during cooking until the oven has cooled down. After cooking, it is advisable to remove all the food residues with a wet sponge.

However, from time to time, it will be necessary to do a more complete and thorough cleaning, using the pyrolytic cleaning function. You can select two different levels of pyrolytic cleaning depending on how dirty the oven is.

If the oven cavity is not very dirty, we recommend that you select the pyrolytic 1 function (P 1) on the programmer display.

It is advisable to wipe the oven over with a soft sponge soaked in warm water after each pyrolytic cleaning cycle is carried out.

If the oven cavity is very dirty, we advise you to select the pyrolytic 2 function (P 2) on the programmer display.

During the pyrolytic cleaning function, it is not possible to use the oven for 2 hours when selecting the Pyr 1 function and up to 2 1/2 hours when the Pyr 2 function is active.

How to use the pyrolytic cleaning function

 Before activating the pyrolytic cleaning function, remove any excessive spillage and make sure that the oven is empty. Do not leave anything inside it (e.g. pans, grids, baking tray, dripping pan, etc.) as this could heavily damage them.

 Ensure that the oven door is closed before activating the pyrolytic cleaning function.

 When the pyrolytic cleaning function is on, it is advisable not to use the hob as this could cause overheating and damage the appliance.

 During the pyrolytic cleaning cycle the oven door becomes hot. Children should be **kept away** until it has cooled.

Choose this function to clean the oven by pyrolysis.









The following pyro levels are available:

Pyrolytic 1 (P 1) time : 2 h = 30 min heat-up +1 h at 480°C + 30 min cooling down.

Pyrolytic 2 (P 2) time : 2 h 30 min. = 30 min heat-up +1 h 30 min at 480°C + 30 min cooling down.

The pyro duration time cannot be changed.

To activate the pyrolytic cleaning function proceed as follows:

1. Press button  to switch on the oven. Press the  button as often as necessary, until the "Pyro" function symbol  (level 1 - P 1) will appear on the display (Fig. 18).
2. The Cooking Duration symbol  will flash for 5 seconds; during this time push '-' or '+' buttons to select the pyrolytic 1 (P 1) or pyrolytic 2 (P 2) function (Fig. 19).
3. Once you have chosen the desired pyrolytic function, the "Pyro" writing will flash on the display waiting for confirmation to start the pyro cleaning function. If '-' or '+' buttons are pushed, the Cooking Duration symbol  will flash again to allow you to change the pyro selection (P 1 or P 2) (Fig. 19).
4. To confirm which pyrolytic function you desire, press button , the "Pyro" text will stop flashing and the pyrolytic cleaning cycle starts (Fig. 20).
5. After some time, the door lock will be activated and the related symbol  will be displayed (Fig. 21). At this time the button  is no more active.

At the end of the pyrolytic cleaning process, the display shows the time of day. The oven door is locked.

Once the oven has cooled down, an acoustic signal will be emitted and the door will unlock.

To stop the pyrolytic cleaning cycle at any time, press button .

NOTE: The time indication is comprehensive of the cooling down time.

 If you select a cooking function while the pyrolytic function is active, the cleaning cycle will be interrupted.

If the oven door lock is activated, it is impossible to select any cooking function until the door lock is off.

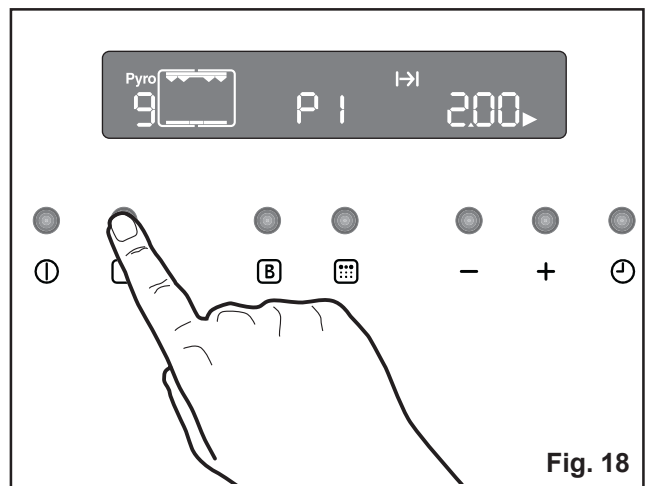

Fig. 18

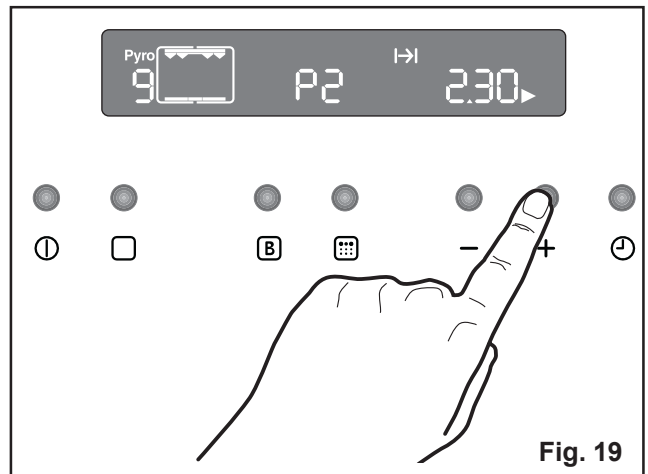

Fig. 19

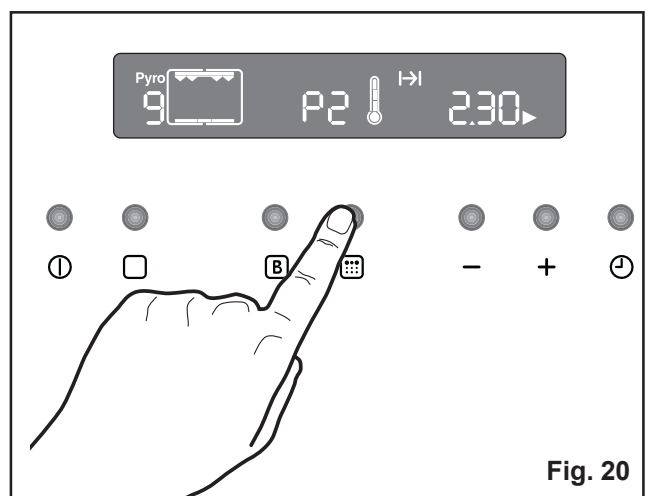

Fig. 20

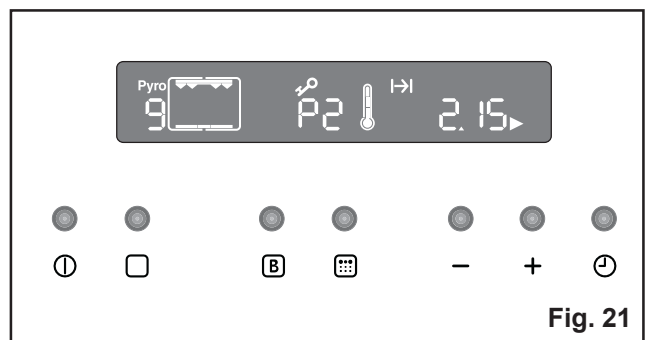









Fig. 21

To programme the pyrolytic cleaning cycle (delayed start, automatic stop)

If you wish, you can programme the start and end time of the pyrolytic cleaning cycle.

1. Press button  to switch on the oven. Press the  button as often as necessary, until the "Pyro" function symbol  (level 1 - P 1) appears in the display.
2. The Cooking Duration symbol  will flash for 5 seconds; during this time push '-' or '+' button to select the pyrolytic 1 (P 1) or pyrolytic 2 (P 2) function.
3. Once you have chosen the desired pyrolytic function, "Pyro" will flash in the display waiting for confirmation to start the pyro cleaning function.

At this time, push the time function button  (Fig. 22). The time indication will appear in the display, the "End of Cooking" symbol  and  will flash on the display.

Push '-' or '+' buttons to select the required end of cycle time. Once you have selected the ending time of the pyrolytic cleaning cycle, press  button to activate the function.

4. After some time, the door lock will be activated and the related symbol  will be displayed.

At the end of the pyrolytic cleaning process, the display shows the time of day. The oven door is locked.

Once the oven has cooled down, an acoustic signal will be emitted and the door will unlock.

To stop the pyrolytic cleaning cycle at any time, press button .

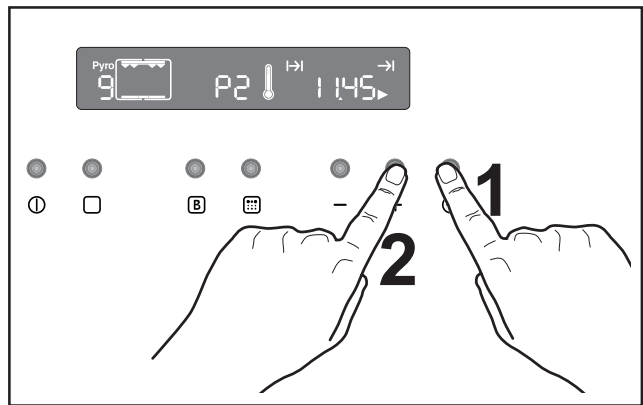



Fig. 22

Replacing the Oven Light (Fig. 25)

If the oven bulb needs replacing, it must comply with the following specifications:

- Power: 40 W,
- Voltage: 230 V (50 Hz),
- Temperature Rating of 300 °C,
- Thread type: E14.

These bulbs are available from your local Service Force Centre.

 To replace the faulty bulb (Fig. 23):

1. Ensure the oven is disconnected from the electrical supply.
2. Turn the glass cover anticlockwise.
3. Remove the faulty bulb and replace with the new one.
4. Refit the glass cover.
5. Reconnect to the electrical supply.

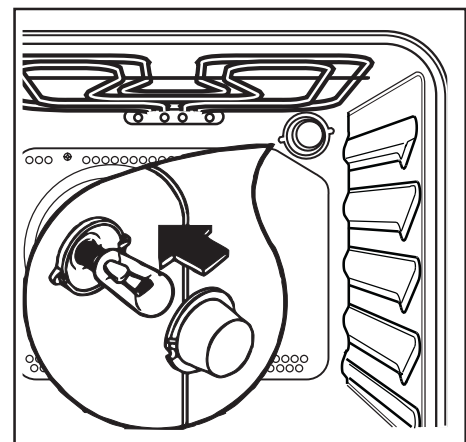

Fig. 23

Cleaning The Oven Door

The oven door is made up of four glasses.
It is possible to remove them for easier cleaning.



Warning - The oven door may bang shut if you try to extract the inner glasses when the oven door is still fitted to the oven.

Before cleaning the oven door, we recommend you to remove it from the oven.

Proceed as follows:

1. open the oven door completely and locate the two hinges which link the door to the oven;

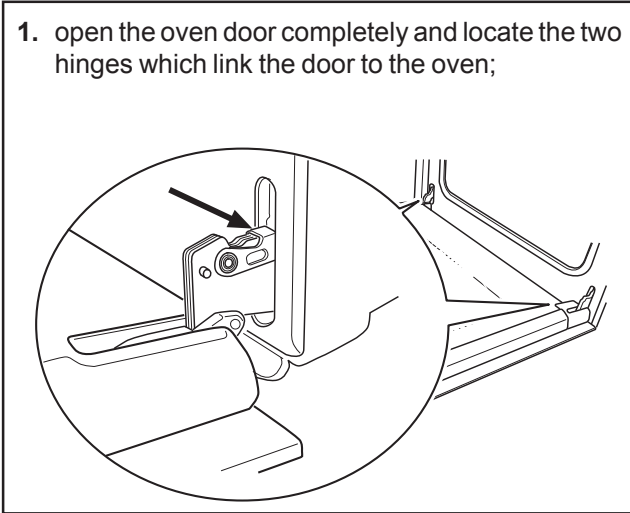

2. unlock and turn the small levers located on the two hinges;

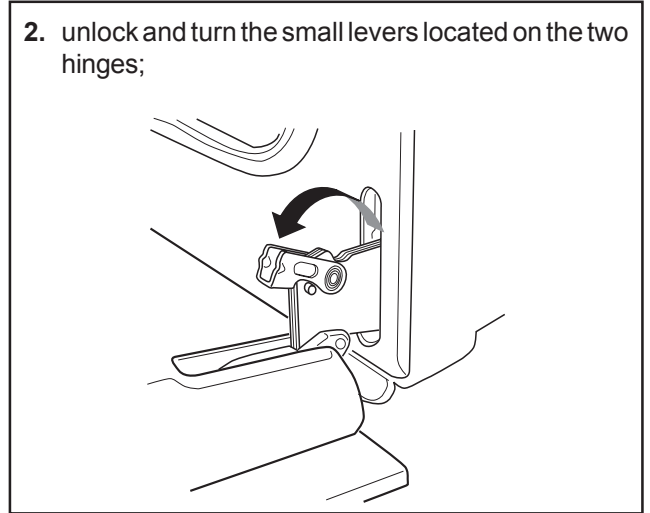

3. handle the door by its left- and right-hand sides, then slowly turn it towards the oven until it is half-closed; at this point, gently pull the oven door away from the oven frame;

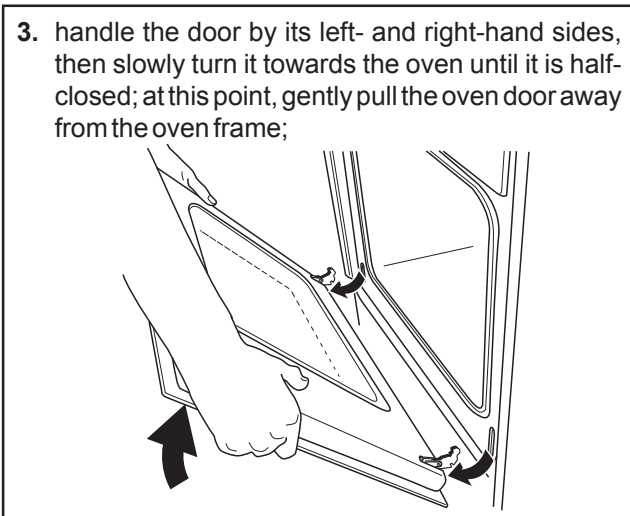

4. place the oven door on a solid surface, being careful to avoid the glass becoming scratched. Then remove the two screws located on the sides of the oven door;

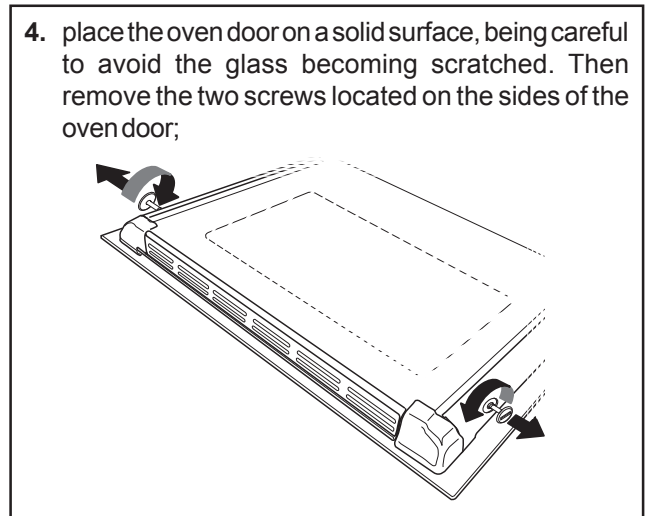

5. extract the inner glass support;

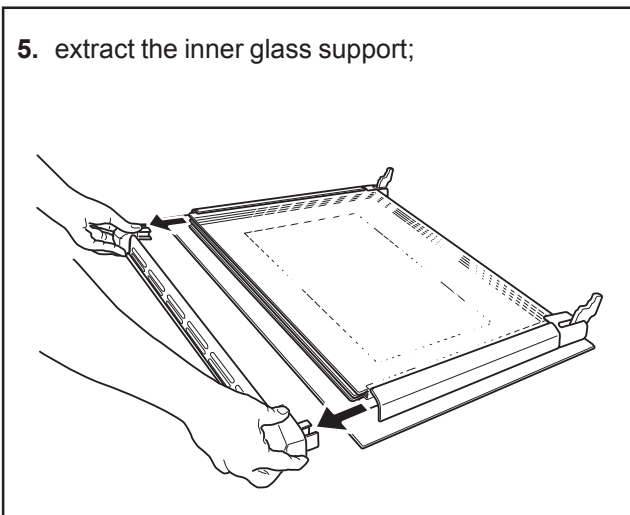

6. gently extract the three inner glasses, starting with the uppermost one first.

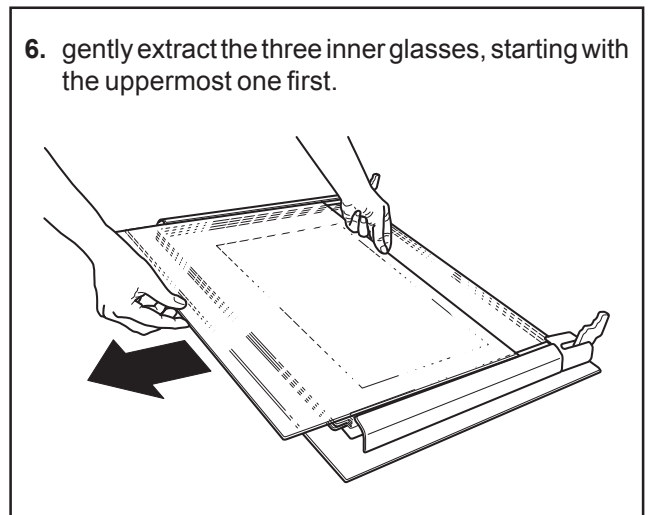

Clean the oven door glass with warm water and a soft cloth only. Never use harsh abrasives as they could damage the special heat-resistant surface of the inner glasses.

Once the cleaning is carried out, refit the oven door, following the procedure in reverse.

The two glasses in the middle are special glasses that have been treated to resist heat. They are marked with a small dot located on a corner and a black frame respectively.

It is important that, when refitting the oven door, the inner glasses are fixed in the right position.

To check if this operation has been carried out correctly, when inserting the glass, make sure that the surface of the glass marked with a black frame looks downwards and that the dot is located on the upper left corner of the glass (Fig 24).

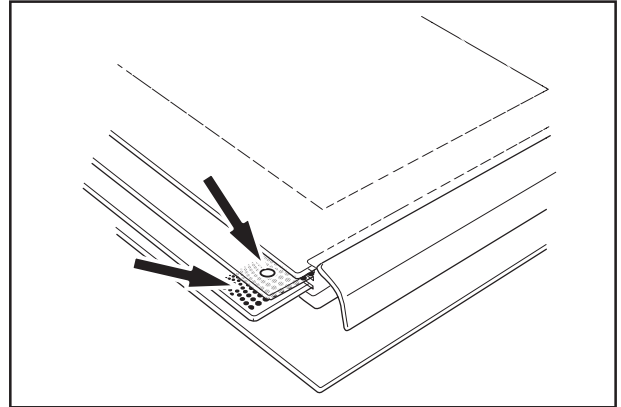

Fig. 24



DO NOT clean the oven door while the glass panels are warm. If this precaution is not observed the glass panels may shatter.

If the door glass panels become chipped or have deep scratches, the glasses will be weakened and must be replaced to prevent the possibility of the panel shattering. Contact your local Service Force Centre who will be pleased to advise further.

Something not working

If the appliance is not working correctly, please carry out the following checks, before contacting your local Service Centre.

SYMPTOM	SOLUTION
■ The oven does not come on.	◆ Press the OVEN ON button, then select a cooking function. ◆ Check the fuse and ensure the socket switch or the switch from the mains supply to the oven are ON.
■ The oven light does not come on.	◆ Switch on the oven using push button ①. ◆ Check the light bulb, and replace it if necessary (see "Replacing the Oven Light")
■ It takes too long to finish the dishes, or they are cooked too fast.	◆ The temperature may need adjusting ◆ Refer to the cooking function sections and to any cooking chart provided
■ Steam and condensation settle on the food and the oven cavity.	◆ Leave dishes inside the oven no longer than 15-20 minutes after the cooking is completed.
■ The timer does not work.	◆ Check the instructions for the timer.
■ The oven fan is noisy.	◆ Check that shelves and bakeware are not vibrating in contact with the oven back panel.
■ Error code "E40" appears on the control panel.	◆ Switch the appliance off and leave it to cool down. Push button ON / OFF to switch on the appliance.
■ An error code other than "E40" appears on the control panel.	◆ Take note of the error code and contact an authorised Service Centre.
■ The display shows "12.00".	◆ Set the time of day (see chapter "How the set the time of day").

Service and Spare Parts

SERVICE FORCE

In the event of your appliance requiring service, or if you wish to purchase spare parts, please contact your local Zanussi Service Force Centre by telephoning:

0870 5 929929

Your telephone call will be automatically routed to the Service Force Centre covering your post code area. For the address of your local Service Force Centre and further information about Service Force, please visit the website at www.serviceforce.co.uk

Before calling out an engineer, please ensure you have read the details under the heading "Something Not Working."

When you contact the Service Force Centre you will need to give the following details:

1. Your name, address and post code
2. Your telephone number
3. Clear and concise details of the fault
4. The model and serial number of the appliance (found on the rating plate)
5. The purchase date

Customer Care Department

For general enquiries concerning your Zanussi appliance or for further information on Zanussi products, please contact our Customer Care Department by letter or telephone at the address below or visit our website at www.zanussi.co.uk

Customer Care Department

Zanussi
55-77 High Street
Slough
Berkshire
SL1 1DZ
08705 727727 (*)

* calls to this number may be recorded for training purposes.

For Customer Service in the Republic of Ireland please contact us at the address below:

ZANUSSI
Electrolux Group (Ire) Ltd.
Long Mile Road
Dublin 12
Republic of Ireland

Tel: + 353 (0) 1 4090751
e-mail: service.eid@electrolux.ie

Guarantee conditions

Zanussi Guarantee conditions

We, Zanussi, undertake that if, within 24 months of the date of the purchase, this Zanussi appliance or any part thereof is proved to be defective by any reason only of faulty workmanship or materials, we will, at our option, repair or replace the same FREE OF ANY CHARGE for labour, materials or carriage on condition that:

- * The appliance has been correctly installed and used only on the gas and electricity supply stated on the rating plate.
- * The appliance has been used for normal domestic purpose only, and in accordance with the manufacturer's instructions.
- * The appliance has not been serviced, maintained, repaired, taken apart or tampered with by any person not authorised by us.
- * All service work under this guarantee must be undertaken by a Zanussi Service Centre.
- * Any appliance or defective part replaced shall become the Company's property.
- * This guarantee is in addition to your statutory and other legal rights.

Home visits are made between **8.30am and 5.30pm** Monday to Friday. Visits may be available outside these hours, in which case a **premium** will be charged.

Exclusions

This guarantee does not cover:

- * Damage or calls resulting from transportation, improper use or neglect, the replacement of any light bulbs or removable parts of glass or plastic.
- * Costs incurred for calls to put right an appliance which is improperly installed or calls to appliance outside the United Kingdom.
- * Appliances found to be in use within a commercial or similar environment, plus those which are the subject to rental agreements.
- * Products of Zanussi manufacture which are not marketed by Zanussi.

European Guarantee

If you should move to another country within Europe then your guarantee moves with you to your new home subject to the following qualifications:

- * The guarantee starts from the date you first purchased your product.
- * The guarantee is for the same period and to the same extent for labour and parts as exist in the new country of use for this brand or range of products.
- * This guarantee relates to you and cannot be transferred to another user.
- * Your new home is within the European Community (EC) or European Free Trade Area.
- * The product is installed and used in accordance with our instructions and is only used domestically, i.e. a normal household
- * The product is installed taking into account regulations in your new country.

Before you move, please contact your nearest Customer Care centre, listed below, to give them details of your new home. They will then ensure that the local Service Organisation is aware of your move and able to look after you and your appliances.

France	Senlis	+33 (0)3 44 62 29 99
Germany	Nürnberg	+49 (0)911 323 2600
Italy	Pordenone	+39 (0)1678 47053
Sweden	Stockholm	+46 (0)8 738 79 50
UK	Slough	+44 (0)1753 219897

Installation



The oven must be installed according to the instructions supplied.



This oven must be installed by **qualified personnel**.

Technical Data

Dimensions of recess

Height	undertop: 593 mm; in column 580 mm
Width	560 ÷ 570 mm
Depth	550 mm

Dimensions of the oven cavity

Height	335 mm
Width	405 mm
Depth	400 mm
Oven capacity	56 litres

Heating elements rating

Oven element	1,880 W
Top element	835 W
Bottom element	1,045 W
Convection element	2,090 W
Grill element	1,795 W
Double Grill element	2,665 W
Pizza Oven Function	3,135 W
Convection Fan	30 W
Oven Light	40 W
Cooling Fan	25 W
Total Rating	3,200 W
Supply voltage (50 Hz)	230-240 V

Electrical connection

The oven is designed to be connected to 230-240 V (50 Hz) electricity supply. The oven has an easily accessible terminal block which is marked as follows:

Letter L	-	Live terminal
Letter N	-	Neutral terminal
 or E	-	Earth terminal



THIS OVEN MUST BE EARTHED

The cable used to connect the oven to the electrical supply must comply to the specifications given below.

For Uk use only

Connection via	Min. size Cable/flex	Cable / flex type	Fuse
• Cooker Control Circuit	2.5 mm ²	PVC/PVC twin and earth	20 A

For Europe use only

Min. size Cable/flex	Cable / flex type	Fuse
2.5 mm ²	H07 RN-F, H05 RN-F, H05 RR-F, H05 VV-F, H05 V2V2-F (T90), H05 BB-F	15 A

It is necessary that you install a double pole switch between the oven and the electricity supply (mains), with a minimum gap of 3mm between the switch contacts and of a type suitable for the required load in compliance with the current rules.

The switch must not break the yellow and green earth cable at any point.

Important

After installation and connecting, the cable must be placed so that it cannot at any point reach a temperature of more than 60 °C above the ambient temperature.

Before the oven is connected, check that the main fuse and the domestic installation can support the load; and that the power supply is properly earthed.

The manufacturer disclaims any responsibility should these safety measures not be carried out.

Building In

Please ensure that when the oven is installed it is easily accessible for the engineer in the event of a breakdown.

Building In

The surround or cabinet into which the oven will be built must comply with these specifications:

- the dimensions must be as shown in the relevant diagrams;
- the materials must withstand a temperature increase of at least 60 °C above ambient;
- proper arrangements must be made of a continuous supply of air to the oven to prevent the oven overheating.

Dimensions of the oven and recess required are given in the relevant diagrams.

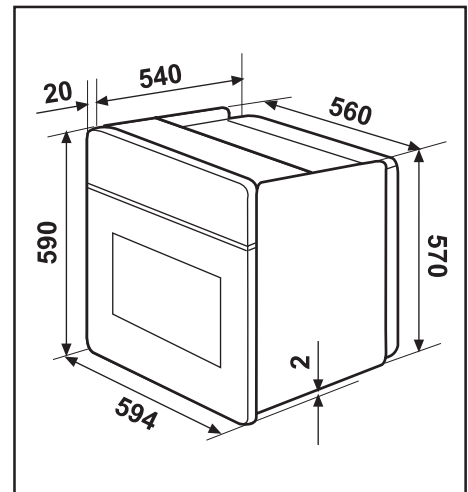

Fig. 25

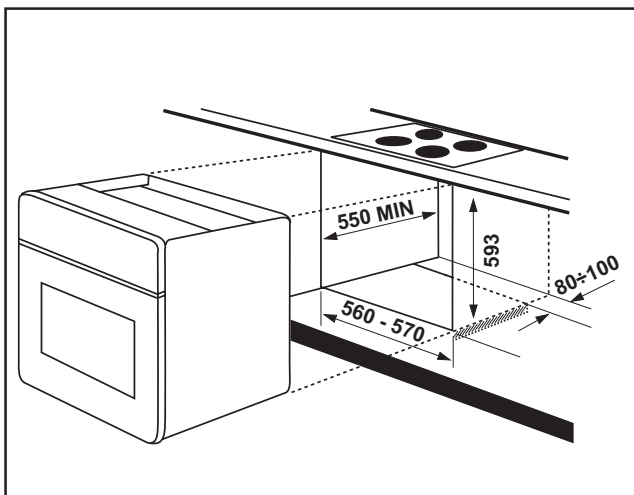

Fig. 26

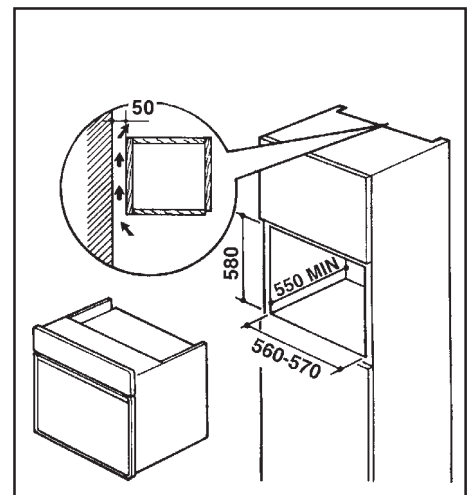

Fig. 27

Securing The Oven To The Cabinet

1. Fit the oven into the cabinet recess,
2. Open the oven door,
3. Secure the oven to the kitchen cabinet with four wood screws, which fit the holes provided in the oven frame.

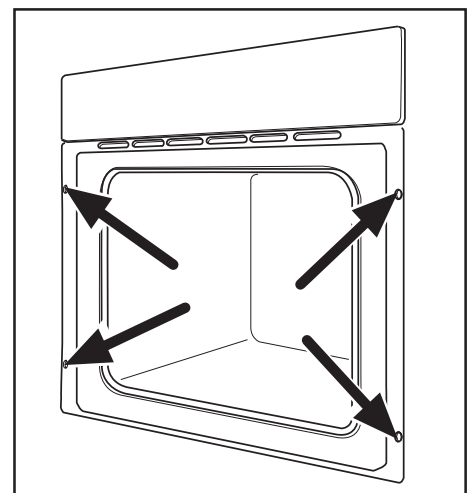

Fig. 28

-	ES	DA	DE	EL	EN	FR	IT	NL	PT	SV	FI	
1	Fabricante	Mærke	Hersteller	Προμηθευτής	Manufacturer	Fabricant	Costruttore	Fabrikant	Fabricante	Leverantör	Tavarantonttaja	ZANUSSI
2	Modelo	Model	Modell	Μοντέλο	Model	Modèle	Modello	Model	Modelo	Modell	Malli	ZPB 1260
3	Clase de eficiencia energética	Relativt energiforbrug	Energieeffizienzklasse	Τύξη ενεργειακής απόδοσης	Energy efficiency class	Classement selon son efficacité énergétique	Classe di efficienza energetica	Energie-efficiëntieklasse	Classe de eficiência energética	Energieeffektivitetsklass	Energiatohokkuusluokka	
4	- Calentamiento convencional	- Traditionel opvarmning	- Konventionelle Beheizung	- Συμβατική	- Conventional	- Classique	- Convezione naturale	- Conventioneel	- Conveccional	- Konventionell värmning	- Ylä-alalämpö	
5	- Convección forzada	- Varmluft	- Um/Heißluft	- Με κυκλοφορία θερμού αέρα	- Forced air convection	- Convection forcée	- Convezione forzata	- Geforceerde luchtconvectie	- Convecção forçada de ar	- Värmning med varmluft	- Kiertolima	
	Consumo de energía Función de calentamiento:	Energiforbrug Opvarmningsfunktion:	Energieverbrauch Beheizung:	Κατανάλωση ενέργειας Αετοσύρμα θέρμανσης	Energy consumption Heating function:	Consommation d'énergie Fonction chauffage:	Consumo di energia Funzione di riscaldamento:	Energieverbruik Verhittingsfunctie:	Consumo de energia Função de aquecimento:	Energiförbrukning Värmningsfunktion:	Energiankulutus Kuumentustapa:	
6	- Calentamiento convencional	- Traditionel opvarmning	- Konventionelle Beheizung	- Συμβατική	- Conventional	- Classique	- Convezione naturale	- Conventioneel	- Conveccional	- Konventionell värmning	- Ylä-alalämpö	0,79 kWh
7	- Convección forzada	- Varmluft	- Um/Heißluft	- Με κυκλοφορία θερμού αέρα	- Forced air convection	- Convection forcée	- Convezione forzata	- Geforceerde luchtconvectie	- Convecção forçada de ar	- Värmning med varmluft	- Kiertolima	0,78 kWh
8	- Vapor	- Damp	- Dampf	- Ατμός	- Steam	- Vapeur	- Vapore	- Stoom	- Vapor	- Ånga	- Höyry	
9	Volumen neto (litros)	Nettovolumen (liter)	Nettovolumen (Liter)	Ωφέλιμος όγκος (λίτρα)	Usable volume (litres)	Volume utile (litres)	Volume utile (litri)	Netto volume (liter)	Volume útil Litros	Användbar volym (liter)	Käyttötilavuus (litraa)	56,0
	Tipo: - Pequeño - Medio - Grande	Type: - Lille - Mellemstort - Stort	Typ: - Klein - Mittel - Groß	Τύπος: - Μικρός - Μεσoίος - Μεγάλος	Size: - Small - Medium - Large	Type: - Faible volume - Volume moyen - Grand volume	Tipo: - Piccolo - Medio - Grande	Type: - Klein - Middelgroot - Groot	Tipo: - pequeno - medio - grande	Storlek: - Liten - Medelstor - Stor	Koko: - Pieni - Keskipokoinen - Suuri	
	Tiempo de cocción con carga normal:	Tilberedningstid ved standardbelastning:	Kochzeit bei Standardbelastung:	Χρόνος για ψήσιμο τυποποιημένου φορτίου:	Time to cook standard load:	Temps de cuisson en charge normale:	Tempo necessario per cottura carico normale:	Bereidings-tijd bij standaardbelasting:	Tempo de cozedura da carga-padrão:	Tillagningstid för en standardlast:	Paistoika vakiokuormalla:	
10	- Calentamiento convencional	- Traditionel opvarmning	- Konventionelle Beheizung	- Συμβατική	- Conventional	- Classique	- Convezione naturale	- Conventioneel	- Conveccional	- Konventionell värmning	- Ylä-alalämpö	43 min.
11	- Convección forzada	- Varmluft	- Um/Heißluft	- Με κυκλοφορία θερμού αέρα	- Forced air convection	- Convection forcée	- Convezione forzata	- Geforceerde luchtconvectie	- Convecção forçada de ar	- Värmning med varmluft	- Kiertolima	41 min.
12	Superficie de la placa de cocción de mayor tamaño	Areallet af den største bageplade	Größe des größten Backblechs	Η μεγαλύτερη επιφάνεια ψησίματος εκπορεύσιμη	The area of the largest baking sheet	Aire de la surface de la plus grande plaque pour pâtisserie	Superficie del piano di cottura più grande	Oppervlakte van de grootste bakplaat	Área da superfície da maior placa de pastelaria	Ytan för den största bakplåten	Suurimman leivinpellin ala	1130 cm ²
13	Ruido [dB (A) re 1 pW]	Lydeffektniveau dB (A) (S _{woj})	Geräusch (dB (A) re 1 pW)	Ξόρυθος [dB (A) ανά 1 pW]	Noise (dB (A) re 1 pW)	Bruit [dB (A) re 1 pW]	Rumore [dB (A) re 1 pW]	Geluidsniveau dB (A) re 1 pW	Nível de ruído dB (A) re 1 pW	Bullerivå dB (A)	Ääni (dB (A) re 1 pW)	
	<ul style="list-style-type: none"> ● Más eficiente ●●●●● 	<ul style="list-style-type: none"> Bassi consumi Efficient Niedriger Verbrauch Πιο αποδοτικό More efficient Économie 	<ul style="list-style-type: none"> A B C D E F G 	<ul style="list-style-type: none"> Menos eficiente Alti consumi Inefficient Höher Verbrauch Ανοητορο αποδοτικό Less efficient Peu économe 	<ul style="list-style-type: none"> ●● 12 l ●●● 35 l ●●●● 65 l 	<ul style="list-style-type: none"> 12 l 35 l 65 l 	<ul style="list-style-type: none"> ≤Volumen neto/Nettovolumen/Ωφέλιμος όγκος/Usable volume/Volume utile/ Netto volume/Volume útil/Användbar volym/Käyttötilavuus ≤Volumen neto/Nettovolumen/Ωφέλιμος όγκος/Usable volume/Volume utile/ Netto volume/Volume útil/Användbar volym/Käyttötilavuus ≤Volumen neto/Nettovolumen/Ωφέλιμος όγκος/Usable volume/Volume utile/ Netto volume/Volume útil/Användbar volym/Käyttötilavuus 	2002/40/EC				

CUSTOMER CARE

Zanussi

55-77 High Street

Slough

Berkshire, SL1 1DZ

Tel: 08705 727727

© Electrolux plc 2003

From the Electrolux Group. The world's No.1 choice.

The Electrolux Group is the world's largest producer of powered appliances for kitchen, cleaning and outdoor use. More than 55 million Electrolux Group products (such as refrigerators, cookers, washing machines, vacuum cleaners, chain saws and lawn mowers) are sold each year to a value of approx. USD 14 billion in more than 150 countries around the world.

Free Manuals Download Website

<http://myh66.com>

<http://usermanuals.us>

<http://www.somanuals.com>

<http://www.4manuals.cc>

<http://www.manual-lib.com>

<http://www.404manual.com>

<http://www.luxmanual.com>

<http://aubethermostatmanual.com>

Golf course search by state

<http://golfingnear.com>

Email search by domain

<http://emailbydomain.com>

Auto manuals search

<http://auto.somanuals.com>

TV manuals search

<http://tv.somanuals.com>