

ZANUSSI



REFRIGERATOR

ZRT 183W1

INSTRUCTION BOOK

GB

This instruction book contains safety precautions, information on use and helpful hints and tips.

To ensure you use this appliance effectively and safely, please read this instruction book carefully before installing or using this appliance and retain for future reference.

The symbols below help you to find things more easily:



Safety precautions

Warnings and Safety information



Hints, useful information



Environmental information



The symbol on the product or on its packaging indicates that this product may not be treated as household waste. Instead it should be taken to the appropriate collection point for the recycling of electrical and electronic equipment. By ensuring this product is disposed of correctly, you will help prevent potential negative consequences for the environment and human health, which could otherwise be caused by inappropriate waste handling of this product. For more detailed information about recycling of this product, please contact your local council, your household waste disposal service or the shop where you purchased the product.

IMPORTANT SAFETY INSTRUCTIONS

These warnings are provided in the interests of your safety. Ensure that you understand them all before installing or using this appliance. Your safety is of paramount importance. If you are unsure about any of the meanings or these warnings contact the Customer Care Department.

Prior to installation

- Check the appliance for transport damage. Under no circumstances should a damaged appliance be installed. In the event of damage please contact your retailer.

Installation

- This appliance is heavy. Care should be taken when moving it.
- It is dangerous to alter the specifications or attempt to modify this product in any way.
- Ensure that the appliance does not stand on the electrical supply cable. If the supply cable is damaged, it must be replaced by a cable available from your local Service Force Centre.
- **Make sure that the power plug has not been squashed or damaged during transit.**
 - A damaged power plug may overheat and cause a fire.
- **As you unpack the appliance, check carefully for any signs of transit damage.**
- **Do not place heavy articles or the fridge/freezer itself on the power cord.**
 - There is a risk of a short circuit and fire.
- **Do not remove the power cord by pulling on its lead, particularly when the fridge/freezer is being pulled out of its niche.**
 - Damage to the cord may cause a short-circuit, fire and/or electric shock.
 - If the power cord is damaged, it must be replaced by a certified service agent or qualified service personnel.
- **If the power plug socket is loose, do not insert the power plug.**
 - There is a risk of electric shock or fire.
- Any electrical work required to install this appliance should be carried out by a qualified electrician or competent person.
- Parts which heat up should not be exposed. Whenever possible, the back of the appliance should be close to a wall, but leaving the required distance for ventilation, as stated in the installation instructions.
- The appliance should be left for 2 hours after installation before it is turned on, in order to allow the refrigerant to settle.

Child Safety

- Do not allow children to tamper with the controls or play with the product.
- Keep packaging materials away from children, to prevent the risk of suffocation!

During Use

- This appliance is designed for domestic use only, specifically for the storage of edible foodstuffs. It is not intended for commercial or industrial use.

Maintenance and Cleaning

- Before cleaning, always switch off the appliance and disconnect from the electrical supply.
- When unplugging always pull the plug from the mains socket, do not pull on the cable.

Servicing

- This product should be serviced by an authorised engineer and only genuine spare parts should be used.
- Under no circumstances should you attempt to repair the appliance yourself. Repairs carried out by inexperienced persons may cause injury or serious malfunctioning. Contact your local Service Force Centre.

At the end of the Appliance Life

- When disposing of your appliance use an authorised disposal site.
- The symbol  on the product or on its packaging indicates that this product may not be treated as household waste. Instead it should be taken to the appropriate collection point for the recycling of electrical and electronic equipment. By ensuring this product is disposed of correctly, you will help prevent potential negative consequences for the environment and human health, which could otherwise be caused by inappropriate waste handling of this product. For more detailed information about recycling of this product, please contact your local council, your household waste disposal service or the shop where you purchased the product.
- Remove the plug and ensure that any locks or catches are removed, to prevent young children being trapped inside.

Safety precautions for isobutane

Warning

- The refrigerant isobutane (R 600a) is contained within the refrigerant circuit of the appliance, a natural gas with a high level of environmental compatibility, which is nevertheless flammable.
- Keep ventilation openings, in the appliance enclosure or in the built-in structure, clear of obstruction.
- Do not use mechanical devices or other means to accelerate the defrosting process, other than those recommended by the manufacturer.
- Do not damage the refrigerant circuit.
- Do not use electrical appliances inside the food storage compartments of the appliance.



The Appliance and the Environment

This appliance does not contain gasses which could damage the ozone layer.

Avoid damaging the cooling unit.

The packaging used on this appliance marked with the



symbol is recyclable.

Keep this instruction book for future reference and ensure it is passed on to any new owner.

CONTENTS

Instructions for the User

Guide to use the instruction book	2
Important Safety Instructions	3
Instructions for the User	6
General Information	6
Description of the Appliance	6
Using the Appliance	7
Before Use	7
To Start the Appliance	7
Thermostat Control	7
Hints for storage	7
Storage Shelves	8
Hints and Tips	8
Food Storage	8
Energy Saving Advice	8
Maintenance and Cleaning	8
Internal cleaning	8
External cleaning	9
Changing the Light Bulb	9
Defrosting Your Appliance	9
When the appliance is not in use	9
Something Not Working	10
Service and Spare Parts	10
Customer Care Department	11
Guarantee Conditions	11

Instructions for the Installer

Technical Specifications	12
Installing the Appliance	12
Transportation, Unpacking	12
Cleaning	12
Location	12
Ventilation Requirements	13
Levelling	13
Door Reversal	13
Electrical Connection	15
Storage Chart	16

INSTRUCTIONS FOR THE USER

General information

This appliance is designed for the refrigeration of food in a domestic home.

To ensure correct operation, the appliance should be located where the ambient temperature is between 16-32 °C.

Description of the appliance

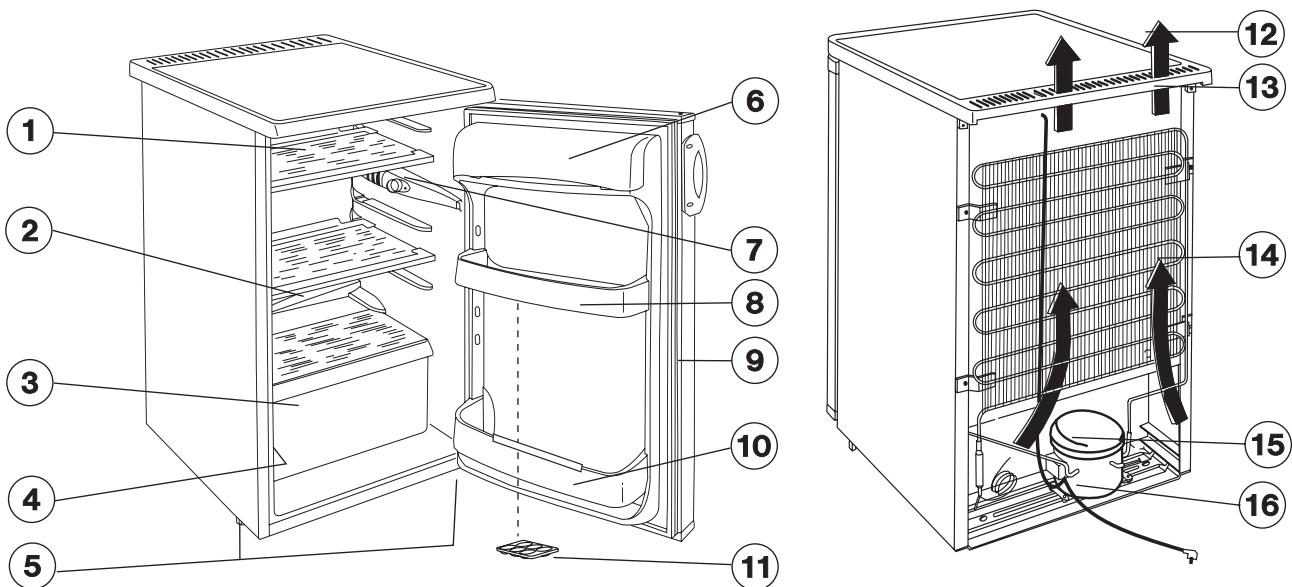

- | | |
|---|---------------------|
| 1. Glass shelf | 10. Bottle shelf |
| 2. Defrost water drain | 11. Egg tray |
| 3. Salad drawer | 12. Air circulation |
| 4. Rating Plate | 13. Spacer |
| 5. Adjustable feet | 14. Condenser |
| 6. Butter compartment | 15. Evaporator tray |
| 7. Interior Light/Thermostat control knob | 16. Compressor |
| 8. Door shelf | |
| 9. Door gasket | |

Using the Appliance

Before Use

Remove all securing tapes.

Wash the inside of the appliance with lukewarm water with a little bicarbonate of soda added (5 ml to 0,5 litre of water). Do not use soap or detergent as the smell may linger. Dry the appliance thoroughly.



Do not use detergents, abrasive powders, highly perfumed cleaning products, wax polishes or products containing alcohol.



To Start the Appliance

1. Allow the appliance to stand for 2 hrs after installation.
2. Plug in the appliance and switch on at the mains supply.
3. Turn the thermostat control to the required setting. A setting of 3 is usually suitable for normal operation (see thermostat control).
4. Leave the appliance for approximately 4 hours for the correct temperature to be reached before placing food inside.

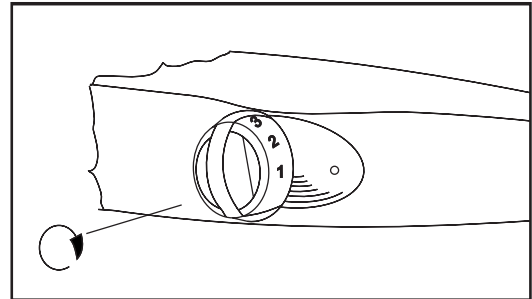

Thermostat Control

The thermostat control knob situated inside the refrigerator regulates the temperature of the larder compartment. Thermostat control is marked from 1-5 the higher the number, the colder the setting.

Position 0 - Off

Position 1 - minimum coldness

Position 5 - maximum coldness

Hints for storage

Below is the recommended storage positions for various food types:

1. Ready-cooked foods, convenience foods, fresh meat, cold cuts
2. Milk, dairy products, foods in dishes
3. Fruits, vegetables, salads
4. Cheese, butter
5. Eggs
6. Yoghurt, sour cream
7. Small bottles, soft drinks
8. Large bottles, drinks

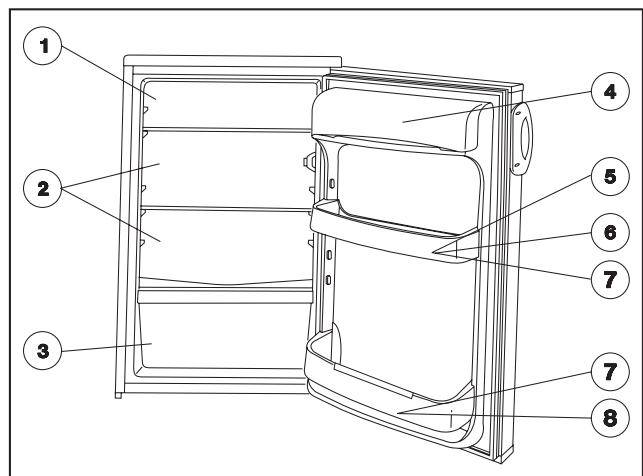

Storage Shelves

The variable shelves increase the usefulness of the fresh food compartment. The shelves can be rearranged by opening the door to 90°.

The door shelves can also be rearranged to your requirements.

Hints & Tips

Food Storage

- To obtain the best results from your appliance neither hot foods nor liquids which may evaporate, should be placed in the larder compartment.
- Keep the time between buying chilled food and placing it in your fridge as short as possible.
- Do not push food together too much, try to allow air to circulate around each item.
- Do not store uncovered food.
- Remove suspect food from your refrigerator and clean, refer to cleaning and maintenance.

Energy Saving Advice

- Do not install the cabinet close to sources of heat, such as a cooker, dishwasher or radiator.
- Locate the appliance in a cool well ventilated room and make sure that the air openings of the cabinet are not obstructed.
- Always leave warm food to cool down to room temperature before placing in the fridge.
- Try to avoid keeping the door open for long periods, or opening the door too frequently as warm air will enter the cabinet, and cause the compressor to often switch on unnecessarily.
- Ensure there are no obstructions preventing the door from closing properly.
- It is advisable to periodically clean the refrigeration system at the back of the appliance with a duster or vacuum cleaner.

Maintenance & Cleaning



Before any maintenance or cleaning work is carried out DISCONNECT the appliance from the ELECTRICITY SUPPLY.

Internal Cleaning

Clean the inside and accessories with warm water and bicarbonate of soda (5 ml to 0.5 litre of water). Rinse and dry thoroughly.



Do not use detergents, abrasive powders, highly perfumed cleaning products, wax polishes or cleaning products containing bleach or alcohol.

Clean the drain hole of the water trough at regular intervals and ensure that the drain hole is clear at all times. If blocked carefully clear using a piece of flexible curtain wire inserted into the drain outlet to remove the blockage.

Regularly check the door seals and wipe clean to ensure they are clean and free from debris.

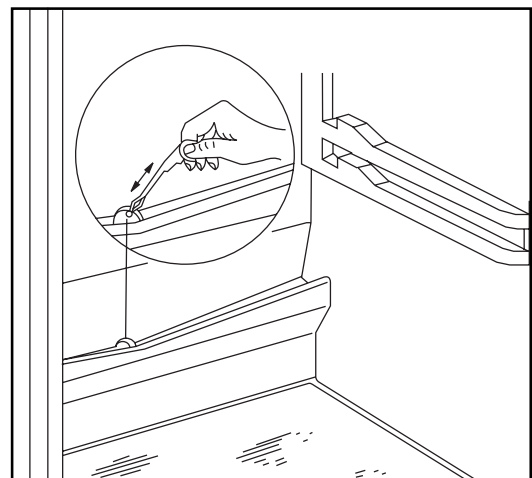

External Cleaning

Wash the outer cabinet with warm soapy water.



Do NOT use abrasive products.

There are sharp edges on the underside of the product so care should be taken when cleaning.

Once or twice a year dust the condenser (black grille) and the compressor at the back of the appliance with a brush or vacuum cleaner, as an accumulation of dust will affect the performance of the appliance and cause excessive electricity consumption.

Changing the Light Bulb

Should the light fail to work you can change it as below:

Disconnect the appliance from the electricity supply.

Remove the lamp cover retaining screws, then take the lamp cover off in the direction of the arrow and the bulb can be changed. (Type of the bulb: 230 V, 15 W, E 14 thread)

After changing the bulb replace the lamp cover, and retaining screws and reconnect the appliance to the electricity supply.

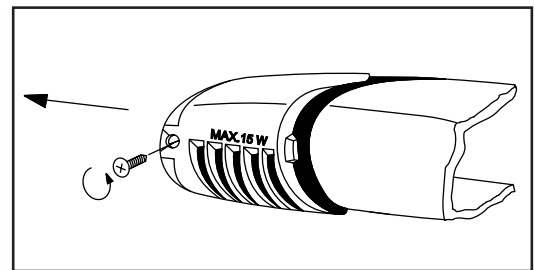

Defrosting Your Appliance

The fridge compartment is defrosted automatically, when the motor stops. Defrost water from the cooling plate runs out of the drain and onto a tray on the motor compressor where it evaporates. Droplets of water on the cooling plate during defrosting are quite normal and will freeze on the plate afterwards.

When the appliance is not in use

When the appliance is not in use for long periods disconnect from the electricity supply, empty all of the food and clean the appliance, leaving the door ajar to prevent unpleasant smells.

Something Not Working

If the appliance is not working correctly, please carry out the following checks before contacting your local Zanussi Service Force Centre.

Problem	Possible Cause	Solution
No power to the appliance	No power at the socket. There is a power cut. The fuse has blown. Thermostat control knob is set at „0“.	Check there is power at the socket. Check there is not a power cut by checking the household lights. Check the fuse has not blown. Check the thermostat control knob setting.
The temperature in the appliance is too high	The appliance is located in an unsuitable position. The thermostat control is set too low.	Check the ambient temperature is within the appliances operating limits of 16 °C to 32 °C. Check that the thermostat control knob is turned to the correct setting relative to ambient conditions.
The temperature in the appliance is too low	The thermostat control knob is set too high.	Set the thermostat control knob to a warmer position.
Excessive frost and ice has built up	The door has been left open. Something is obstructing the door. The door gasket is dirty.	Check the door has not been left open. Check nothing is preventing the door from closing. Check the door gasket is intact and clean.
The appliance is noisy.	The appliance is not level.	Check if the appliance stands stable (all four feet should be on the floor).
Water under the salad drawer.	The drain hole is blocked.	Check the drain hole is not blocked (see 'Maintenance and Cleaning').

If after the above checks your appliance still does not operate correctly, contact your local Service Force Centre.

Please note that it will be necessary to provide proof of purchase for any in-guarantee service calls.

In-guarantee customers should ensure that the above checks have been made, as the engineer will make a charge if the fault is not a mechanical or electrical breakdown.

SERVICE FORCE

Service and Spare Parts

In the event of your appliance requiring service, or if you wish to purchase spare parts, please contact your local Service Force Centre by telephoning:

08705 929929

Your telephone call will be automatically routed to the Service Force Centre covering your post code area.

For the address of your local Service Force Centre and further information about Service Force, please visit the website at www.serviceforce.co.uk

Before calling out an engineer, please ensure you have read the details under the heading "Something Not Working."

When you contact the Service Force Centre you will need to give the following details:

1. Your name, address and post code
2. Your telephone number
3. Clear and concise details of the fault
4. The model and serial number of the appliance (found on the rating plate)
5. The purchase date

Please note that a valid purchase receipt or guarantee documentation is required for in-guarantee service calls.

Customer Care Department

For general enquiries concerning your Zanussi - Electrolux appliance or for further information on Zanussi - Electrolux products, please contact our Customer Care Department by letter or telephone at the address below or visit our website at www.zanussi-electrolux.co.uk

Major Appliances - Customer Care Department

Zanussi - Electrolux

Addington Way

Luton

Bedfordshire

LU4 9QQ

08705 727727 (*)

*calls to this number may be recorded for training purposes.

Guarantee Conditions

We Zanussi - Electrolux undertake that if within 12 months of the date of the purchase this ZANUSSI - ELECTROLUX appliance or any part thereof is proved to be defective by reason only of faulty workmanship or materials, the company will, at our option repair or replace the same FREE OF CHARGE for labour, materials or carriage on condition that:

- The appliance has been correctly installed and used only on the electrical supply stated on the rating plate.
- The appliance has been used for normal domestic purposes only, and in accordance with the manufacturer's instructions.
- The appliance has not been serviced, maintained, repaired, taken apart or tampered with by any person not authorised by us.
- All service work under this guarantee must be undertaken by a Service Force Centre.
- Any appliance or defective part replaced shall become the Company's property.

Home visits are made between **8.30am** and **5.30pm Monday to Friday**. Visits may be available outside these hours in which case a premium will be charged.

EXCLUSIONS

This Guarantee does not cover:

Damage or calls resulting from transportation, improper use or neglect, the replacement of any light bulbs or removable parts of glass or plastic.

- Costs incurred for calls to put right an appliance improperly installed or calls to appliances outside the United Kingdom.
- Appliances found to be in use within a commercial environment, plus those which are the subject of rental agreements.
- Products of Zanussi - Electrolux manufacture which are not marketed by Zanussi - Electrolux.

The guarantee is in addition to your statutory and legal rights.

EUROPEAN GUARANTEE

If you should move to another country within Europe then your guarantee moves with you to your new home subject to the following qualifications:

- The guarantee starts from the date you first purchased your product.
- The guarantee is for the same period and to the same extent for labour and parts as exists in the new country of use for this brand or range of products.
- This guarantee relates to you and cannot be transferred to another user.
- Your new home is within the European Community (EC) or European Free Trade Area.
- The product is installed and used in accordance with our instructions and is only used domestically, i.e. a normal household.
- The product is installed taking into account regulations in your new country.

Before you move please contact your nearest Customer Care Centre, listed below, to give them details of your new home. They will then ensure that the local Service Organisation is aware of your move and able to look after you and your appliances.

France	Senlis	+33 (0) 344 62 29 29
Germany	Nuremberg	+49 (0) 800 234 7378
Italy	Pordenone	+39 (0) 0434 39 4700
Sweden	Stockholm	+46 (0) 8 672 53 90
UK	Luton	+44 (0) 8705 727727

Instructions for the Installer

Technical Specifications

Model	ZRT 183W1
Gross capacity (l)	Fresh food com.: 155
Net capacity (l)	Fresh food com.: 152
Width (mm)	550
Height (mm)	850
Depth (mm)	612
Energy consumption (kWh/day)	0,422
(kWh/year)	154
Energy class, according to EU Standards	A
Rated current (A)	0,55
Noise Lc (dB)	38
Weight (kg)	33

Installing the appliance

Transportation, unpacking

The appliance and the interior fitting are protected for transport.

- Remove all packaging and any adhesive tape.
- Any remnants of adhesive can be removed using white spirit.
- After transportation the appliance must not be switched on for 2 hours. This is to allow the refrigerant to settle.

Cleaning

Clean the accessories and the inside of the appliance with warm water and bicarbonate of soda (5 ml to 0.5 litres of water). Rinse and dry thoroughly.

Do not use detergents, abrasive powders, highly perfumed cleaning products, wax polishes or cleaning products containing bleach or alcohol.

Location

The appliance should be positioned in a well ventilated, dry room.

Energy use is affected by the ambient temperature.

The appliance should therefore:

- not be installed next to radiators, cookers or other sources of heat
- only be installed at a location where the ambient temperature corresponds to the climate classification, for which the appliance is designed.

The climate classification can be found on the serial plate.

The following table shows which ambient temperature is correct for each climate classification:

Climate Classification	Ambient Temperature
SN	+10 to +32 °C
N	+16 to +32 °C
ST	+18 to +38 °C

Ventilation Requirements

The appliance must have adequate ventilation to ensure correct operation.

Diagram shows the ventilation requirements when installed:

A* Under a worktop, or cupboard.

* The clearance space of 10 cm above the appliance may be reduced to 5 cm providing a clearance space 2.5 cm is left on either side of the appliance.

B When freestanding

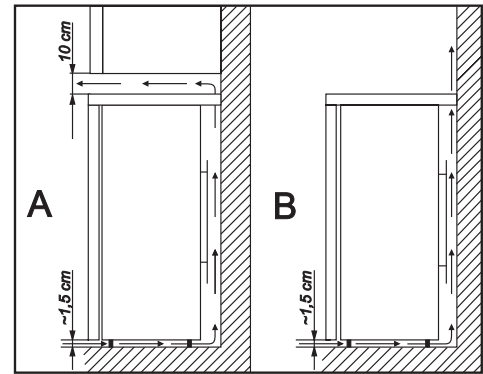

Levelling

The appliance must be level. Level the appliance by adjusting the two adjustable feet (1) at the front of the appliance.

If required the washer (2) can be removed.

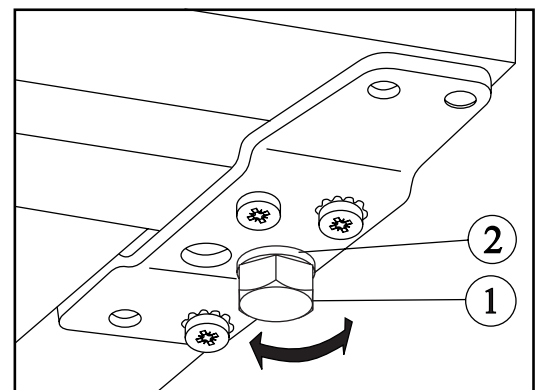

Door Reversal

If required the opening direction of the door can be changed as follows:

To reverse the bottom hinge assembly proceed as follows:

- Disconnect the appliance from the electricity supply.
- Tilt the appliance backwards, resting the top edge of the appliance on a stool or something similar.
- Unscrew the adjustable feet situated on both sides at the front (2 pieces). Remove the lower door hinge plate by unscrewing the 3 retaining screws.
- Remove the hinge pin from the bottom of the door.
- Slot the hinge pin into the hole in the hinge plate and relocate the hinge assembly to the opposite location and refit using the retaining screws.
- Put the cabinet in the upright position.

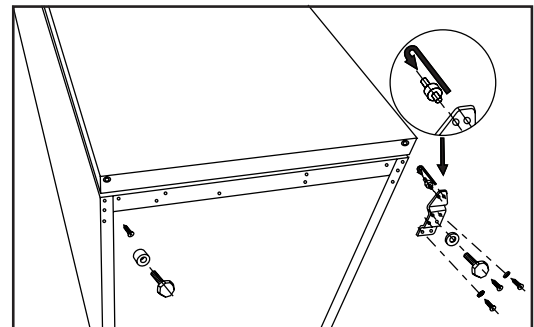

To reverse the top hinge assembly proceed as follows:

- Remove the 2 worktop retaining screws from the back of the appliance.
- Slide the worktop towards the rear and lift clear of the appliance.

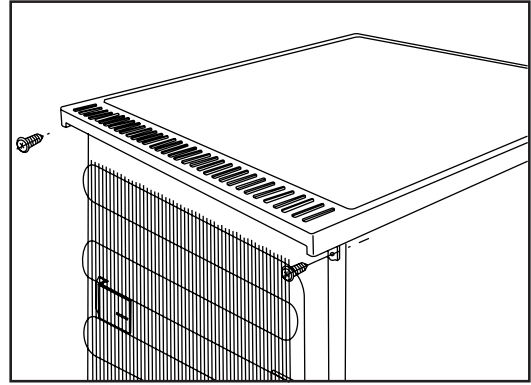

- Remove the 2 upper hinge plate retaining screws.
- Remove the hinge plate from the top of the door.
- Unscrew the hinge pin from the hinge plate and re-insert on the opposite side of the plate.
- Rotate the hinge assembly 180° and insert the hinge assembly into the opposite location.
- Refit the 2 hinge plate retaining screws.
- Relocate the worktop and refit the worktop retaining screws.

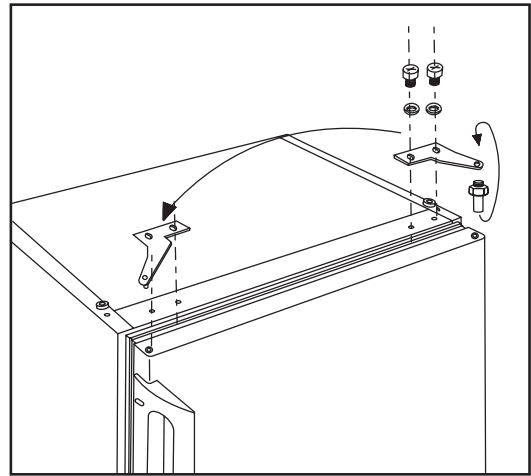

To reverse the handle proceed as follows:

- Remove screw covers (if fitted) and handle retaining screws. Remove blanking plugs on the opposite side using a punch.
- Relocate the handle to the opposite side and refit retaining screws (covers if fitted), and push the plastic plugs supplied with the instruction book into the holes where the handle was previously fitted.

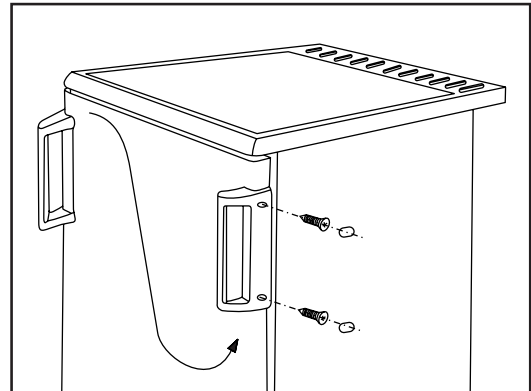

Electrical Connection

 Any electrical work required to install this appliance should be carried out by a qualified electrician or competent person.

This appliance must be earthed.

The manufacturer declines any liability should these safety measures not be observed.

Electrical Requirements

Before switching on, make sure the electricity supply voltage is the same as that indicated on the appliance rating plate.

The appliance is supplied with a 13 amp plug fitted. In the event of having to change the fuse in the plug supplied, a 13 amp ASTA approved (BS 1362) fuse must be used. Should the plug need to be replaced for any reason. The wires in the mains lead are coloured in accordance with the following code:

Green and Yellow:	Earth
Blue:	Neutral
Brown:	Live

The wire coloured green and yellow must be connected to the terminal marked with the letter "E" or by the earth symbol  or coloured green and yellow.

The wire coloured blue must be connected to the terminal "N" or coloured black.

The wire coloured brown must be connected to the terminal marked "L" or coloured red.

Upon completion there must be no cut, or stray strands of wire present and the cord clamp must be secure over the outer sheath.

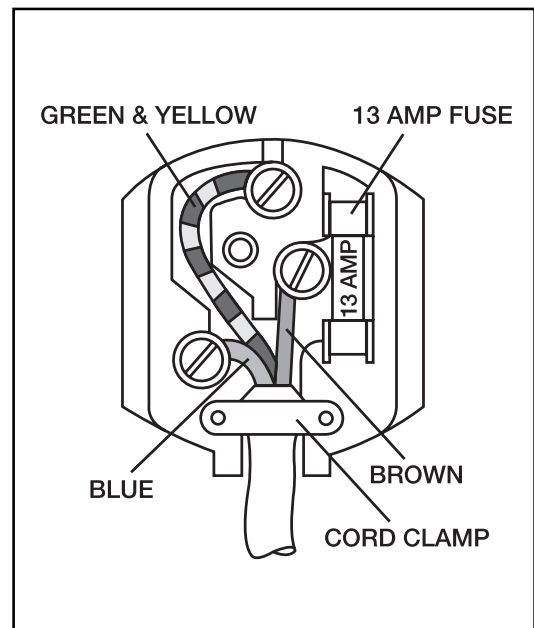

Important!

The plug must still be accessible after the appliance has been installed.

The appliance should not be connected to the electrical supply by means of an extension cable.

In case that the electrical cable has to be replaced, please contact your local Service Force Centre.

Warning!

A cut off plug inserted into a 13 amp socket is a serious safety (shock) hazard. Ensure that it is disposed of safely.

 This appliance complies with the following E.E.C. Directives:

- **73/23 EEC** of 19.02.73 (Low Voltage Directive) and subsequent modifications,
- **89/336 EEC** of 03.05.89 (Electromagnetic Compatibility Directive) and subsequent modifications.

Storage time chart

Time and method of storage of fresh foods in the refrigerator

Foods	Storage time in days							Method of packaging
	1	2	3	4	5	6	7	
Raw meat	X	X	x	x	x			cling film, airtight
Cooked meat	X	X	X	x	x	x		dish covered
Roasted meat	X	X	X	x	x			dish covered
Raw minced meat	X							dish covered
Cooked minced meat	X	X	x	x				dish covered
Cold cuts	X	X	x	x				cling film, cellophane, grease-proof paper
Fresh fish	X	x	x					cling film, airtight
Cooked fish	X	X	x	x				dish covered
Tinned fish, open	X	x	x					dish covered
Fresh chicken	X	X	X	x	x	x		cling film, airtight
Fried chicken	X	X	X	x	x	x		dish covered
Fresh duck, goose	X	X	X	x	x	x		cling film, airtight
Roasted duck, goose	X	X	X	X	x	x	x	dish covered
Butter unopened	X	X	X	X	X	X	X	original packaging
Butter opened	X	X	X	X	X	X	X	original packaging
Milk	X	X	X	x	x			original packaging
Cream	X	X	x	x				plastic box
Sour cream	X	X	X	X	x	x	x	plastic box
Cheese (hard)	X	X	X	X	X	X	X	aluminium foil
Cheese (soft)	X	X	X	X	x	x	x	cling film
Egg	X	X	X	X	X	X	X	
Spinach, sorrel	X	X	x	x				cling film
Green peas, green beans	X	X	X	X	x	x	x	cling film
Mushroom	X	X	x	x	x			cling film
Carrot	X	X	X	X	X	X	X	cling film
Tomato	X	X	X	X	X	X	X	cling film
Cabbage	X	X	X	X	X	x	x	cling film
Fruits: strawberries, raspberries, etc.	X	X	X	x	x			cling film
Tinned fruits opened	X	X	X	x	x			dish covered
Cakes filled with cream	X	X	x	x				dish covered

Notation:

- X** recommended storage time
- x** maximum recommended storage time

© Electrolux plc 2007

ELECTROLUX HOME PRODUCTS OPERATIONS EUROPE

 **From the Electrolux Group. The world's No.1 choice.**

The Electrolux Group is the world's largest producer of powered appliances for kitchen, cleaning and outdoor use. More than 55 million Electrolux Group products (such as refrigerators, cookers, washing machines, vacuum cleaners, chain saws and lawn mowers) are sold each year to a value of approx. USD 14 billion in more than 150 countries around the world.

Download from www.Somanuals.com. All Manuals Search And Download.

Free Manuals Download Website

<http://myh66.com>

<http://usermanuals.us>

<http://www.somanuals.com>

<http://www.4manuals.cc>

<http://www.manual-lib.com>

<http://www.404manual.com>

<http://www.luxmanual.com>

<http://aubethermostatmanual.com>

Golf course search by state

<http://golfingnear.com>

Email search by domain

<http://emailbydomain.com>

Auto manuals search

<http://auto.somanuals.com>

TV manuals search

<http://tv.somanuals.com>