

EN

User manual

2

Washing machine

USER MANUAL

ZANUSSI

Get Living!

FCS 1020 C

Contents

Safety information _____	2	Care and cleaning _____	12
Product description _____	3	What to do if... _____	13
Control panel _____	5	Technical data _____	16
Before first use _____	7	Consumption values _____	16
Daily use _____	7	Installation _____	17
Helpful hints and tips _____	9	Environment concerns _____	19
Washing programmes _____	11		

Subject to change without notice



Safety information

Important! Read carefully & keep for future reference.

- The safety of Your appliance complies with the industry standards and with legal requirements on the safety of appliances. However, as manufacturers, we feel it is our duty to provide the following safety notes.
- It is most important that this instruction book should be retained with the appliance for future reference. Should the appliance be sold or transferred to another owner, or should you move house and leave the appliance, always ensure that the book is supplied with the appliance in order that the new owner can get to know the functioning of the appliance and the relevant warnings.
- You **MUST** read them carefully before installing or using the appliance.
- Before first starting up, check the appliance for any damage incurred during transport. Never connect up a damaged appliance. If parts are damaged, contact your supplier.
- If the appliance is delivered in the winter months when there are minus temperatures. Store it at room temperature for 24 hours before using for the first time.

General safety

- It is dangerous to alter the specifications or attempt to modify this product in any way.
- During high temperature wash programmes the door glass may get hot. Do not touch it!
- Make sure that small pets do not climb into the drum. To avoid this, please check into the drum before using.
- Any objects such as coins, safety pins, nails, screws, stones or any other hard, sharp material can cause extensive damage and must not be placed into the machine.

- Only use the advised quantities of fabric softener and detergent. Damage to the fabric can ensue if you over-fill. Refer to the manufacturer's recommendations of quantities.
- Wash small items such as socks, laces, washable belts etc in a washing bag or pillow case as it is possible for such items to slip down between the tub and the inner drum.
- Do not use your washing machine to wash articles with whalebones, material without hems or torn material.
- Always unplug the appliance and turn off the water supply after use, cleaning and maintenance.
- Under no circumstances should you attempt to repair the machine yourself. Repairs carried out by inexperienced people may cause injury or serious malfunctioning. Contact your local Service Centre. Always insist on genuine spare parts.

Installation

- This appliance is heavy. Care should be taken when moving it.
- When unpacking the appliance, check that it is not damaged. If in doubt, do not use it and contact the Service Centre.
- All packing and transit bolts must be removed before use. Serious damage can occur to the product and to property if this is not adhered to. See relevant section in the user manual.
- After having installed the appliance, check that it is not standing on the inlet and drain hose and the worktop is not pressing the electrical supply cable against the wall.
- If the machine is situated on a carpeted floor, please adjust the feet in order to allow air to circulate freely under the appliance.

- Always be sure, that there is no water leakage from hoses and their connections after the installation.
- If the appliance is installed in a location subject to frost, please read the “dangers of freezing” chapter.
- Any plumbing work required to install this appliance should be carried out by a qualified plumber or competent person.
- Any electrical work required to install this appliance should be carried out by a qualified electrician or competent person.

Use

- This appliance is designed for domestic use. It must not be used for purposes other than those for which it was designed.
- Only wash fabrics which are designed to be machine washed. Follow the instructions on each garment label.
- Do not overload the appliance. See the Washing Programme Table.
- Before washing, ensure that all pockets are empty and buttons and zips are fastened. Avoid washing frayed or torn articles and treat stains such as paint, ink, rust, and grass before washing. Underwired bras must NOT be machine washed.
- Garments which have been in contact with volatile petroleum products should not be machine washed. If

volatile cleaning fluids are used, care should be taken to ensure that the fluid is removed from the garment before placing in the machine.

- Never pull the power supply cable to remove the plug from the socket; always take hold of the plug itself.
- Never use the appliance if the power supply cable, the control panel, the working surface or the base are damaged so that the inside of the washing machine is accessible.

Child safety

- This appliance is not intended for use by person (including children) with reduced physical sensory or mental capabilities or lack of experience and knowledge unless they have been given supervision or instruction concerning use of the appliance by a person responsible for their safety.
- Young children should be supervised to ensure that they do not play with the appliance
- The packaging components (e.g. plastic film, polystyrene) can be dangerous to children - danger of suffocation! Keep them out of children's reach.
- Keep all detergents in a safe place out of children's reach.
- Make sure that children or pets do not climb into the drum.

Product description

i Your new appliance meets all modern requirements for effective treatment of laundry with low water, energy and detergent consumption. Its new washing system allows total use of detergent and reduces water consumption so saving energy.

Machine front

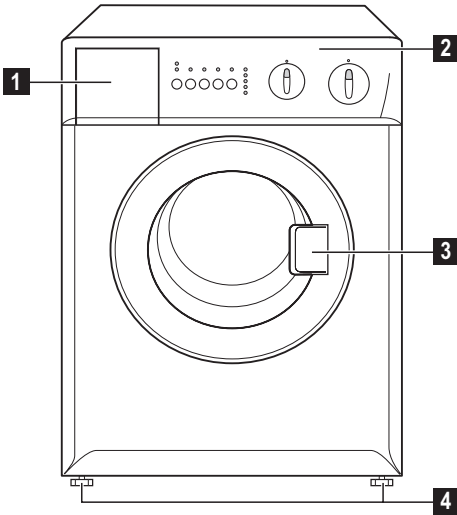

- 1 Detergent dispenser drawer
- 2 Control panel
- 3 Door opening handle
- 4 Adjustable feet (front)

Detergent dispenser drawer

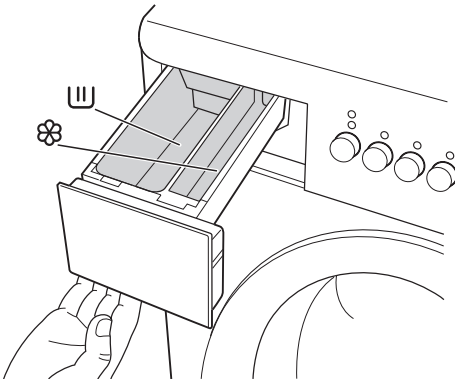

Machine rear

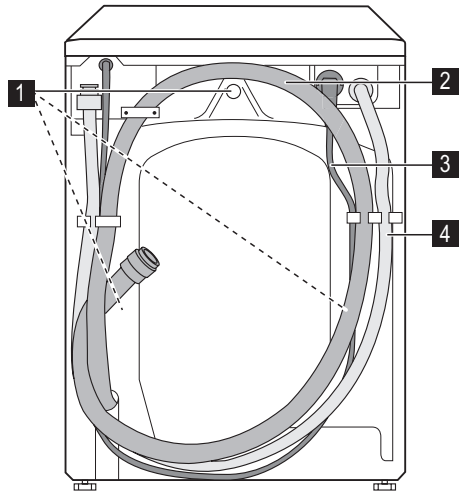

- 1 Transit locking devices
- 2 Drain hose
- 3 Electrical lead
- 4 Inlet hose

U Compartment for powder or liquid detergent used for main wash. If using liquid detergent pour it **just before** starting the programme.

W Compartment for liquid additives (fabric softener, starch).

Any fabric softener or starching additives must be poured into the compartment before starting the wash programme.

Control panel

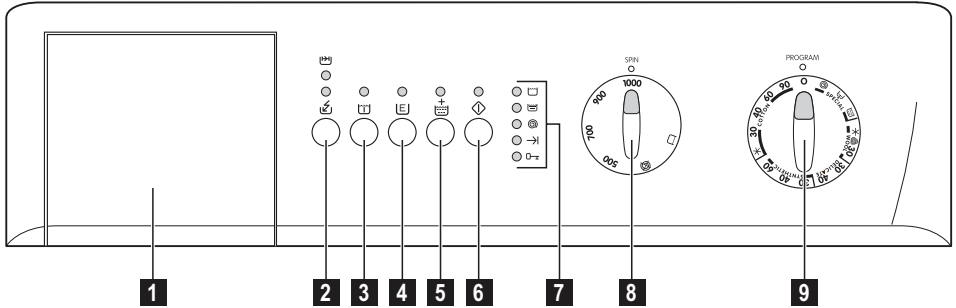

i Henceforth, the programme selector dial, the spin selector dial, programme progress lights and different buttons will be indicated in all the book with the relevant numbers given in this table.

1.	Detergent drawer	<ul style="list-style-type: none"> Detergent drawer has 2 separate compartments for detergent and fabric conditioner. <p>i Prewash detergent is to be added straight into the drum.</p>
2.	Option button Extra Quick Quick	<ul style="list-style-type: none"> By means of this button, you can select only one of the options. The relevant light will light up.
3.	Prewash button	<ul style="list-style-type: none"> By means of this button, the machine performs a prewash cycle before the main wash phase. The relevant light will light up.
4.	Economy button	<ul style="list-style-type: none"> By means of this button, the machine performs an energy saving cycle. The relevant light will light up.
5.	Super Rinse button	<ul style="list-style-type: none"> By means of this button, the machine performs some additional rinses. The relevant light will light up.
6.	Start/Pause button	<ul style="list-style-type: none"> This button allows to start the selected programme; the corresponding indicator light is lit. This button interrupts also a programme which is running, the corresponding indicator light starts to flash.
7.	Programme progress display	<ul style="list-style-type: none"> The different pilot lights illuminate depending on the running programme phase.
8.	Spin speed selector	<ul style="list-style-type: none"> The spin speed selector dial allows for changing the spin speed. Turn the spin selector, if you want your laundry to be spun at a speed different from the one proposed by the appliance or select «Rinse Hold» or "No spin" option.

9.	Programme selector dial and ON/OFF switch	<ul style="list-style-type: none"> • The programme selector dial allows to select a programme and/or to reset, cancel the programme, switch the machine on/off. • Programme selector dial is divided into following sections: Cotton, Synthetic, Delicate, Wool, Special programmes. It can be turned either clockwise or anticlockwise.
----	--	--

Table of Symbols

 = Extra quick	 = Washing	 = No Spin
 = Quick	 = Rinses	 = Drain
 = Prewash	 = Spin	 = Cold wash
 = Economy	 = Cycle End	 = Wool
 = Super Rinse	 = Door Locked	 = ON/OFF
 = Start/Pause	 = Rinse Hold	

Functions

Options (button 2)

Extra Quick

Very short programme for lightly soiled laundry, except for wool. The washing time will be reduced approx. 30 minutes for cotton and by 20 minutes for synthetic. The machine will perform 1 rinse less.

Quick

Short programme for lightly soiled white-/coloured and synthetic laundry. The washing time will be reduced approx. 10 minutes. Max. recommended temperature 60°C.

 This options can not be chosen together with the Eco option and neither with the wool programme.

The washing time will be reduced depending on the type of material and the selected temperature. Recommended load for cotton is 2 kg.

Prewash (button 3)

If the laundry is heavily soiled, you can choose a programme with prewash. Before the main wash the machine runs a prewash up to 30° C. The washing time will be prolonged approx. 20 minutes. The prewash ends with a short spin in the programmes for cotton and synthetic laundry. In the programme for delicate laundry the water is only drained. The prewash option is not available for the wool programme.

Economy (button 4)

Only for cottons and synthetic items lightly or normally soiled at a temperature of 40°C or higher. The washing time will be prolonged and the washing temperature will

be reduced. You can use this option if you want to wash normally soiled laundry and at the same time save energy. In order to be accounted as an energy class "A" programme, this button must also be pressed in the programmes "Cotton 60 °C" and "40 °C". The main wash will be extended with 20 minutes (60 °C) and 25 minutes (40 °C).

Super rinse (button 5)

The machine performs some additional rinses during the washing cycle. This option is recommended for people who are allergic to detergents, and in areas where the water is very soft. Can be used with all programmes except for the wool programme.

Rinse hold or No spin (8)











Rinse hold

By selecting this option the water of the last rinse is not emptied out to prevent the fabrics from creasing. When the programme has finished, the lights "End" (**D**) and "Locked" (**E**) are lit to indicate that the water must be emptied out (See: " At the end of the programme").

No spin

By selecting this option all the spinning phases are excluded. To be used for extremely delicate material. The machine will add some additional rinses to the cotton and synthetic programmes.

Programme progress display (7)

- (A)  
- (B)  
- (C)  
- (D)  
- (E)  

The light **A** illuminates when the machine is performing **the washing phase** .

The light **B** illuminates when the machine is **rinsing** .

The light **C** illuminates when the machine is **spinning** .

The light **D** illuminates at **the end** of the washing cycle.

The light **E** indicates if **the door** can be opened:

- The light is lit: the door cannot be opened.
- The light is out: the door can be opened.
- The light is flashing: the door can soon be opened.

Before first use

Warning!

Ensure that the electrical and water connections comply with the installation instructions.

Important! Remove any material from the drum.

Important! We recommend you to run a wash programme without any load, to clear any residues which may have

been left by the manufacturing process. Pour approx. 100 ml of detergent straight into the drum and run a cotton cycle at 60°C. When the programme is finished the machine will be ready to use.

Daily use

Load the laundry

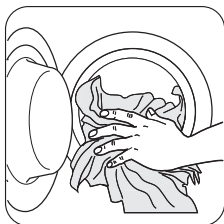

Open the door by carefully pulling the door handle outwards. Place the laundry in the drum, one item at a time, shaking them out as much as possible. Close the door.

Measure out the detergent and the fabric softener

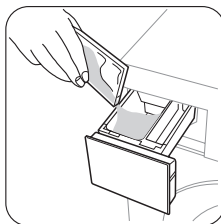

Pull out the dispenser drawer until it stops. Measure out the amount of detergent required, pour it into the larger compartment on the left  .



If required, pour fabric softener into the smaller compartment marked  (the amount used must not exceed the «MAX» mark in the drawer). Close the drawer gently.

Select the required programme by means of the programme selector dial (9)

Turn the programme selector dial to the required programme. The selector can be turned either clockwise or anticlockwise.

The green light of button **6** starts to flash

On programme progress display the pilot lights corresponding to all phases composing the selected programme are lit.

On position  the programme is reset and the machine is switched OFF.

At the end of the programme the selector dial must be turned to position  to switch the machine off.

Important! If you turn the programme selector dial to another programme when the machine is working, the lights in the programme progress display will start to flash to indicate a wrong selection. The machine will not perform the new selected programme.

Select the spin speed, Rinse Hold or No spin option (8)

Select the spin speed, Rinse Hold option or No Spin option by turning the spin speed selector.

For the maximum spin speed allowed by each programme, refer to the chapter **Washing programmes**.

- The position 1000 is equivalent to 900 rpm/min for the synthetic and wool programmes and 700 rpm/min for the delicate wash programme.
- The position 500 is equivalent to 500 rpm/min for all the wash programmes.

Select the desired option by means of buttons 2, 3, 4 and 5

Depending on the programme, different functions can be combined. These must be selected after choosing the desired programme and before pressing the button **6**. The relevant light will illuminate.

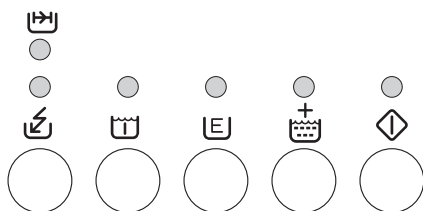

If an incorrect option is selected, the corresponding indicator lamp flashes for about 2 seconds. For the compatibility of the options with the washing programmes, refer to the chapter «**Washing programmes**».

Start the programme by pressing button 6

To start the selected programme, press this button; the corresponding pilot light stops flashing and remains lit.

On programme progress display the pilot lights **A** and **E** illuminate to indicate that the appliance starts operating and the door is locked.

Altering an option or a running programme

It is possible to change any option before the programme carries it out.

Before you make any change, you must pause the washing machine by pressing the button **6**.

The programme can be changed as long as the button **6** has not been pressed. Changing a running programme is possible only by resetting it. Turn the programme selector dial to  and then to the new programme position. Start the new programme by pressing the button **6** again.

Interrupting a programme

Press the button **6** to interrupt a programme which is running, the corresponding light starts to flash. Press the button again to restart the programme.

Cancelling a programme

Turn the selector dial to  position to cancel a programme which is running. Now you can select a new programme.

Opening the door after the programme has started

First set the machine to pause by pressing the button **6**. After some minutes, the door can be opened, when the following conditions are observed:

- The water temperature is below 55°C.
- The water level is below the bottom edge of the door.
- The machine doesn't spin.

If you cannot open the door but it is absolutely necessary to open it you have to switch the machine off by turning the selector dial to . After few minutes the door can be opened

(Pay attention to the water level and temperature!).

After this procedure, it will be necessary to set the programme and the options again and then press the button **6**.

At the end of the programme

The machine stops automatically.

The pilot light **D** illuminates to indicate that the programme has finished. The pilot light **E** goes out, the door can be opened and the laundry can be removed.

If at the end of a programme there is water in the tub (when "Rinse hold" option has been selected), **to empty out the water follow the following instructions:**

- turn the programme selector dial to 

- select the «Drain» or «Spin» programme

- press button **6**

When the pilot light **E** goes out, the door can be opened and the laundry can be removed.

At the end of the cycle, turn the programme selector dial to **○** to switch the machine off.

Helpful hints and tips

Sorting out the laundry

Follow the wash code symbols on each garment label and the manufacturer's washing instructions. Sort the laundry as follows: whites, coloureds, synthetics, delicates, wool-lens.

Temperatures

95° or 90°	for normally soiled white cottons and linen (e.g. tea cloths, towels, tablecloths, sheets...)
60°/50°	for normally soiled, colour fast garments (e.g. shirts, night dresses, pyjamas....) in linen, cotton or synthetic fibres and for lightly soiled white cotton (e.g. underwear)
40°-30°- Cold	for delicate items (e.g. net curtains), mixed laundry including synthetic fibres and woollens bearing the label «pure new wool, machine washable, non-shrink»

Before loading the laundry

Never wash whites and coloureds together. Whites may lose their «whiteness» in the wash.

New coloured items may run in the first wash; they should therefore be washed separately the first time.

Make sure that no metal objects are left in the laundry (e.g. hair clips, safety pins, pins).

Button up pillowcases, close zip fasteners, hooks and poppers. Tie any belts or long tapes.

Remove persistent stains before washing.

Rub particularly soiled areas with a special detergent or detergent paste.

Treat curtains with special care. Remove hooks or tie them up in a bag or net.

Maximum loads

Recommended loads are indicated in the washing programme charts.

Remove the laundry from the drum and carefully check that the drum is empty. If you do not intend to carry out another wash, close the water tap.

Leave the door open to prevent the formation of mildew and unpleasant smells.

General rules:

- **Cotton, linen:** drum full but not too tightly packed;
- **Synthetics:** drum no more than half full;
- **Delicate fabrics and woollens:** drum no more than one third full.

Washing a maximum load makes the most efficient use of water and energy.

For heavily soiled laundry, reduce the load size.

Laundry weights

The following weights are indicative:

The following weights are indicative:	
bathrobe	1200 g
quilt cover	700 g
man's work shirt	600 g
sheet, man's pyjamas	500 g
tablecloth	250 g
pillow case, towelling towel, night dress, man's shirt	200 g
tea cloth, ladies' briefs, napkin, blouse, men's underpants	100 g

Removing stains

Stubborn stains may not be removed by just water and detergent. It is therefore advisable to treat them prior to washing.

Blood: treat fresh stains with cold water. For dried stains, soak overnight in water with a special detergent then rub in the soap and water.

Oil based paint: moisten with benzine stain remover, lay the garment on a soft cloth and dab the stain; treat several times.

Dried grease stains: moisten with turpentine, lay the garment on a soft surface and dab the stain with the fingertips and a cotton cloth.

Rust: oxalic acid dissolved in hot water or a rust removing product used cold. Be careful with rust stains which are not recent since the cellulose structure will already have been damaged and the fabric tends to hole.

Mould stains: treat with bleach, rinse well (whites and fast coloureds only).

Grass: soap lightly and treat with bleach (whites and fast coloureds only).

Ball point pen and glue: moisten with acetone¹⁾, lay the garment on a soft cloth and dab the stain.

Lipstick: moisten with acetone as above, then treat stains with methylated spirits. Treat any residual marks with bleach.

Red wine: soak in water and detergent, rinse and treat with acetic or citric acid, then rinse. Treat any residual marks with bleach.

Ink: depending on the type of ink, moisten the fabric first with acetone¹⁾, then with acetic acid; treat any residual marks on white fabrics with bleach and then rinse thoroughly.

Tar stains: first treat with stain remover, methylated spirits or benzine, then rub with detergent paste.

Detergents and additives

Good washing results also depend on the choice of detergent and use of the correct quantities to avoid waste and protect the environment.

Although biodegradable, detergents contain substances which, in large quantities, can upset the delicate balance of nature.

The choice of detergent will depend on the type of fabric (delicates, woollens, cottons, etc.), the colour, washing temperature and degree of soiling.

All commonly available washing machine detergents may be used in this appliance:

- powder detergents for all types of fabric
- powder detergents for delicate fabrics (60°C max) and woollens
- liquid detergents, preferably for low temperature wash programmes (60°C max) for all types of fabric, or special for woollens only.

The detergent and any additives must be placed in the appropriate compartments of the dispenser drawer before starting the wash programme.

 Prewash detergent is to be added straight into the drum

If using liquid detergents, a programme **without** prewash must be selected. Pour the liquid detergent into the detergent compartment immediately before you start the programme.

Your appliance incorporates a recirculation system which allows an optimal use of the concentrated detergent.

Follow the product manufacturer's recommendations on quantities to use and do **not exceed the «MAX» mark in the detergent dispenser drawer**.

Degrees of water hardness



Water hardness is classified in so-called "degrees" of hardness. Information on hardness of the water in your area can be obtained from the relevant water supply company, or from your local authority.



 A water softener must be added when water has a medium-high degree of hardness (from degree of hardness II). Follow the manufacturer's instructions. The quantity of detergent can then always be adjusted to degree of hardness I (= soft).

Level	Characteristic	Degrees of water hardness	
		German °dH	French °T.H.
1	soft	0-7	0-15
2	medium	8-14	16-25
3	hard	15-21	26-37
4	very hard	> 21	> 37

1) do not use acetone on artificial silk

Washing programmes

Programme/ Temperature	Type of laundry	Options	Description of the programme
COTTON 90°	White cotton (heavily soiled cotton items)	SPIN REDUCTION/NO SPIN/RINSE HOLD EXTRA QUICK/QUICK ¹⁾ PREWASH ECONOMY SUPER RINSE	Main wash Rinses Long spin max. 1000 rpm Max load 3 kg
COTTON 60° - COLD	Coloured cotton (normally soiled cotton items)	SPIN REDUCTION/NO SPIN/RINSE HOLD EXTRA QUICK/QUICK ¹⁾ PREWASH ECONOMY SUPER RINSE	Main wash Rinses Long spin max. 1000 rpm Max load 3 kg
SYNTHETIC 60°-30°	Synthetic or mixed fabrics: underwear, coloured garments, non-shrink shirts, blouses.	SPIN REDUCTION/NO SPIN/RINSE HOLD EXTRA QUICK/QUICK ¹⁾ PREWASH ECONOMY SUPER RINSE	Main wash Rinses Short spin max. 900 rpm Max Load 1,5 kg
DELICATE 40°-30°	Delicate fabrics: acrylics, viscose, polyester.	SPIN REDUCTION/NO SPIN/RINSE HOLD QUICK ¹⁾ PREWASH SUPER RINSE	Main wash Rinses Short spin max. 700 rpm Max Load 1,5 kg
WOOL  30°-COLD	Washing programme for machine washable wool as well as for hand washable woollens and delicate fabrics.	SPIN REDUCTION/NO SPIN/RINSE HOLD	Main wash Rinses Short spin max. 900 rpm Max Load 1 kg
RINSES 	With this programme it is possible to rinse and spin cotton garments which have been washed by hand. The machine performs 3 rinses, followed by a final long spin. The spin speed can be reduced.	SPIN REDUCTION/NO SPIN/RINSE HOLD SUPER RINSE	Rinses Spin max. 1000 rpm Max Load 3 kg
DRAIN 	For emptying out the water of the last rinse in programmes with the Rinse Hold option selected.		Draining of water Max Load 3 kg

Programme/ Temperature	Type of laundry	Options	Description of the programme
SPIN 	Separate spin for hand washed garments and after programmes with the Rinse Hold option selected. You can choose the spin speed by turning the spin speed selector to adapt it to the fabrics to be spun.	SPIN REDUCTION	Drain and long spin Max. spin speed 1000 rpm Max Load 3 kg
 / OFF	For resetting the programme or switching the machine off		

1) If you select this option, we recommend that you reduce the maximum load. Recommended load for cotton is 2 kg.

Care and cleaning

Important! You must DISCONNECT the appliance from the electricity supply, before you can carry out any cleaning or maintenance work.

Descaling

The water we use normally contains lime. It is a good idea to periodically use a water softening powder in the machine. Do this separately from any laundry washing, and according to the softening powder manufacturer's instructions. This will help to prevent the formation of lime deposits.

Maintenance Wash

With the use of low temperature washes it is possible to get a build up of residues inside the drum.

We recommend that a maintenance wash be performed on a regular basis.

To run a maintenance wash:

- The drum should be empty of laundry.
- Select the hottest cotton wash programme.
- Use a normal measure of detergent, must be a powder with biological properties.

External cleaning

Clean the exterior cabinet of the appliance with soap and water only, and then dry thoroughly.

Cleaning the dispenser drawer

The washing powder and additive dispenser drawer should be cleaned regularly.

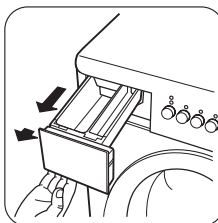

If necessary, the whole detergent drawer can be taken out of the machine for cleaning. You need to pull it firmly outwards, so that it comes free of retaining stop.

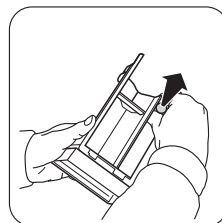

To remove the siphon at the inside edge of the drawer for cleaning, you need to press it inwards and pull it upwards at the same time. Flush it out under a tap, to remove any traces of accumulated powder. When you put it back, press it downwards until you hear a distinct click.

Cleaning the drawer recess

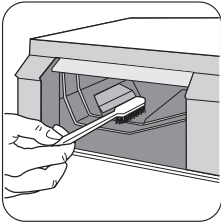

Having removed the drawer, use a small brush to clean the recess, ensuring that all washing powder residue is removed from the upper and lower part of the recess.

Replace the drawer and run the rinse programme without any clothes in the drum.

Cleaning the water inlet filter

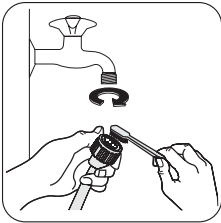

If your water is very hard or contains traces of lime deposit, the water inlet filter may become clogged. It is therefore a good idea to clean it from time to time.



Turn off the water tap. Unscrew the water inlet hose. Clean the filter using a hard bristle brush. Tighten up the inlet hose.

The dangers of freezing

If the machine is exposed to temperatures below 0°C, certain precautions should be taken.

- Turn off the water supply.
- Unscrew the inlet hose from the supply tap.
- Select a wash programme, start the machine and let the programme run for a short time.
- Interrupt the programme by turning the programme selector to  position.
- Place the end of inlet and drain hoses down low, into the waste gully (floor drain) set into the floor. Make sure that the end of the hose does not go below the water level in the gully's (drain's) water tap.
- Select the programme "Drain" and let it run until it is finished.
- Turn the programme selector to  position. When you intend to start the machine up again, make sure that the room temperature is above 0 °C.

The appliance is only to be used and stored indoors at normal room temperature. The manufacturer is not responsible for any frost damage.

What to do if...

Certain problems are due to lack of simple maintenance or oversights, which can be solved easily without calling out an engineer. Before contacting your local Service Centre, please carry out the checks listed below. During machine operation it is possible that the **End** pilot light blinks to indicate that the machine is not working:

- **1 flash:** problem with the water supply.

- **2 flashes:** problem with the water draining.

- **4 flashes:** door open.

Once the problem has been eliminated, press the button **START** to restart the programme. If after all checks, the problem persists, contact your local Service Centre.

Problem	Possible cause/Solution
The machine does not start:	<p>The door has not been closed.</p> <ul style="list-style-type: none"> • Close the door firmly. <p>The plug is not properly inserted in the power socket.</p> <ul style="list-style-type: none"> • Insert the plug into the power socket. <p>There is no power at the socket.</p> <ul style="list-style-type: none"> • Please check your domestic electrical installation. <p>The main fuse has blown.</p> <ul style="list-style-type: none"> • Replace the fuse. <p>The selector dial is not correctly positioned and the button Start has not been pressed.</p> <ul style="list-style-type: none"> • Please turn the selector dial and press the button Start again.
The machine does not fill:	<p>The water tap is closed.</p> <ul style="list-style-type: none"> • Open the water tap. <p>The inlet hose is squashed or kinked.</p> <ul style="list-style-type: none"> • Check the inlet hose connection. <p>The filter in the inlet hose is blocked.</p> <ul style="list-style-type: none"> • Clean the water inlet hose filter. <p>The door is not properly closed.</p> <ul style="list-style-type: none"> • Close the door firmly.
The machine fills then empties immediately:	<p>The end of the drain hose is too low.</p> <ul style="list-style-type: none"> • Refer to relevant paragraph in «Installation» chapter.
The machine does not empty and/or does not spin:	<p>The drain hose is squashed or kinked.</p> <ul style="list-style-type: none"> • Check the drain hose connection. <p>An option or a programme that ends with the water still in the tub or that eliminates all the spinning phases has been selected.</p> <ul style="list-style-type: none"> • Select the draining or spinning programme. <p>The laundry is not evenly distributed in the drum.</p> <ul style="list-style-type: none"> • Redistribute the laundry.
There is water on the floor:	<p>Too much detergent or unsuitable detergent (creates too much foam) has been used.</p> <ul style="list-style-type: none"> • Reduce the detergent quantity or use another one. <p>Check whether there are any leaks from one of the inlet hose fittings. It is not always easy to see this as the water runs down the hose; check to see if it is damp.</p> <ul style="list-style-type: none"> • Check the water inlet hose connection. <p>The drain or inlet hose is damaged.</p> <ul style="list-style-type: none"> • Change it with a new one.

Problem	Possible cause/Solution
Unsatisfactory washing results:	<p>Too little detergent or unsuitable detergent has been used.</p> <ul style="list-style-type: none"> • Increase the detergent quantity or use another one. <p>Stubborn stains have not been treated prior to washing.</p> <ul style="list-style-type: none"> • Use commercial products to treat the stubborn stains. <p>The correct temperature was not selected.</p> <ul style="list-style-type: none"> • Check if you have selected the correct temperature. <p>Excessive laundry load.</p> <ul style="list-style-type: none"> • Reduce the laundry load.
The door will not open:	<p>The programme is still running.</p> <ul style="list-style-type: none"> • Wait the end of washing cycle. <p>The door lock has not been released.</p> <ul style="list-style-type: none"> • Wait until the indicator light for door locked has gone out. <p>There is water in the drum.</p> <ul style="list-style-type: none"> • Select drain or spin programme to empty out the water.
The machine vibrates is noisy:	<p>The transit bolts and packing have not been removed.</p> <ul style="list-style-type: none"> • Check the correct installation of the appliance. <p>The support feet have not been adjusted</p> <ul style="list-style-type: none"> • Check the correct levelling of the appliance. <p>The laundry is not evenly distributed in the drum.</p> <ul style="list-style-type: none"> • Redistribute the laundry. <p>Maybe there is very little laundry in the drum.</p> <ul style="list-style-type: none"> • Load more laundry.
Spinning starts late or the machine does not spin:	<p>The electronic unbalance detection device has cut in because the laundry is not evenly distributed in the drum. The laundry is redistributed by reverse rotation of the drum. This may happen several times before the unbalance disappears and normal spinning can resume. If, after 10 minutes, the laundry is still not evenly distributed in the drum, the machine will not spin. In this case ,redistribute the load manually and select the spin programme.</p> <ul style="list-style-type: none"> • Redistribute the laundry. <p>The load is too small.</p> <ul style="list-style-type: none"> • Add more items, redistribute the load manually and then select the spinning programme.
No water is visible in the drum:	<p>Machines based on modern technology operate very economically using very little water without affecting performance.</p>

If you are unable to identify or solve the problem, contact our service centre. Before telephoning, make a note of the model, serial number and purchase date of your machine: the Service Centre will require this information.

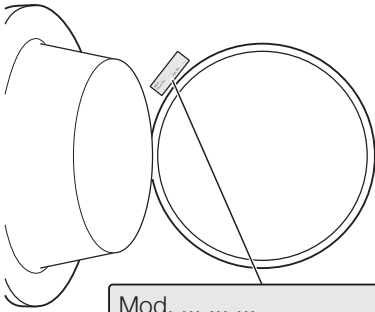

Mod.
 Prod. No.
 Ser. No.

Technical data

Dimensions	Width	67 cm
	Height	49,5 cm
	Depth	51,5 cm
Electrical connection Voltage - Overall power - Fuse	Information on the electrical connection is given on the rating plate, on the inner edge of the appliance door.	
Water supply pressure	Minimum	0,05 MPa
	Maximum	0,8 MPa
Maximum Load	Cotton	3 kg
Spin Speed	Maximum	1000 rpm

Consumption values

Programme	Energy consumption (KWh)	Water consumption (litres)	Programme duration (Minutes)
White Cottons 90°	1.43	44	~ 126
Cottons 60°	0.78	44	~ 107
Cotton + ECO option 60° 1)	0.57	39	~ 130
Synthetic 60°	0.57	42	~ 82
Synthetic 40°	0.26	42	~ 67
Delicate 40°	0.38	45	~ 61
Wool 30°	0.20	45	~ 45
Rinses	0.03	27	~ 26
Drain	-	-	~ 1

Programme	Energy consumption (KWh)	Water consumption (litres)	Programme duration (Minutes)
Spin	-	-	~ 5

1) «Cottons + Eco option» at 60°C with a load of 3 kg is the reference programme for the data entered in the energy label, in compliance with EEC 92/75 standards.

i The consumption data shown on this chart is to be considered purely indicative, as it may vary depending on the quantity and type of laundry, on the inlet water temperature and on the ambient temperature.

Installation

Lifting the machine

Be careful when lifting the machine. Incorrect methods of lifting can cause physical injuries and also increase the risk of damage to the machine. Open the door and take hold of the top inside of the door opening. You can also lift the machine by gripping the rear overhang of the top.

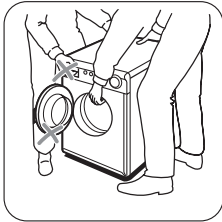

! **Warning!** Never lift the machine by gripping its control panel, door, or detergent dispenser.

Unpacking

When supplied the washing machine is packed using a number of locking devices/packing pieces to prevent drum and motor from damage in transit. All transit bolts and packing must be removed before using the appliance. You are advised to keep all transit devices so that they can be refitted if the machine ever has to be transported again.

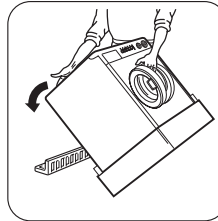

Spread some of the poly-styrene packaging materials on the floor behind the machine and then lay the machine carefully rear side down on them. Make sure that no hoses are crushed in the process.

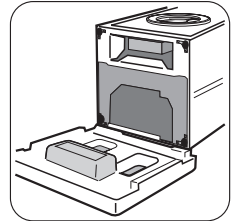

Remove the polystyrene base and the plastic support bar which the machine rests on.

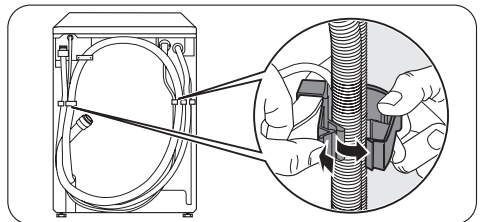

Return machine to its upright position and remove the power supply cable and the draining and inlet hose from the hose holders on the rear of the appliance.

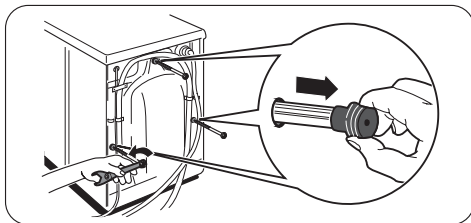

With a suitable spanner unscrew and remove the three screws and their spacers on machine's rear.

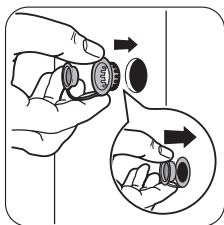

The three holes must then be plugged with the plastic plug caps supplied in the bag containing the instruction booklet, which can be found inside the drum.

Positioning

Install the machine on a flat hard floor. Make sure that air circulation around the machine is not impeded by carpets, rugs etc. Check that the machine does not touch the wall or furniture. Level the washing machine by raising or lowering the two front feet. If necessary, check the setting with a spirit level. Any necessary adjustment can be made with a spanner. Accurate levelling prevents vibration, noise and displacement of the machine during operation.

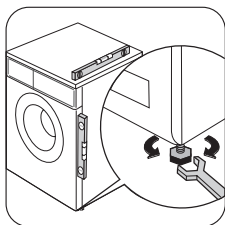

Caution! Never place cardboard, wood or similar materials under the machine to compensate for any unevenness in the floor.

Water inlet

Warning! This appliance must be connected to a cold water supply

Caution! Before connecting up the appliance to new pipework or to pipework that has not been used for

some time, run off a reasonable amount of water to flush out any debris that may have collected

Caution! Do not use the hose from your previous appliance to connect to water supply.

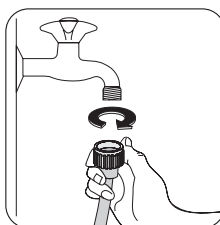

Connect the hose to a tap with a 3/4" thread. Always use the hose supplied with the appliance.

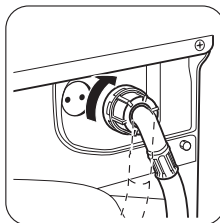

The machine end of the inlet hose can be turned in any direction. Set the hose correctly by loosening the ring nut. After positioning the inlet hose, be sure to tighten the ring nut again to prevent leaks.

The inlet hose must not be lengthened. If it is too short and you do not wish to move the tap, you will have to purchase a new, longer hose specially designed for this type of use.

Water drainage

The end of the drain hose can be positioned in three ways:

Hooked over the edge of a sink using the plastic hose guide supplied with the machine.

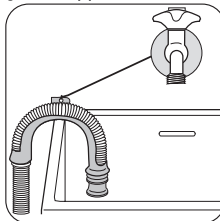

In this case, make sure the end cannot come unhooked when the machine is emptying. This could be done by tying it to the tap with a piece of string or attaching it to the wall.

In a sink drain pipe with a trap.

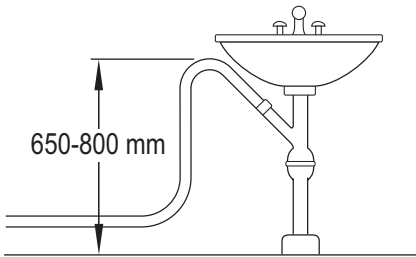

The drain hose can be connected directly into the pipe (e.g. beneath a washtub or sink), above the water trap. The drain hose must be arranged so that some part of its length is routed up to a level corresponding to the top edge of the tub and fixed in place there.

Directly into a drain pipe at a height of not less than 65 cm and not more than 80 cm.

There must be an air gap around and below the end of drain hose. This means that the internal diameter of the standpipe must be larger than the outer diameter of the hose.

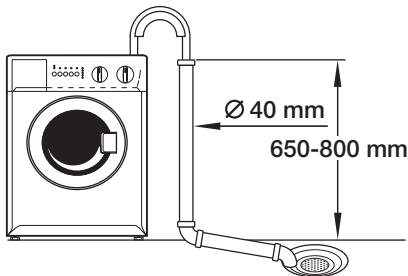

The hose must not be stuck into the standpipe more than 50 mm and it has to be fixed in this position. The drain hose must not be kinked.

The drain hose can be extended up to total 3,5 m. For the extension piece use a hose with an internal diameter at least as large as that of the machine's own hose. Use a suitable hose connector.

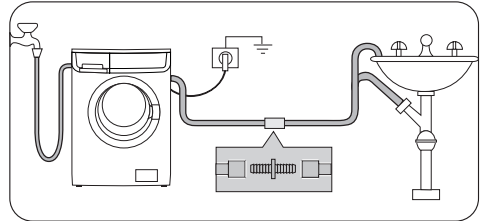

Information on the electrical connection is given on the rating plate on the inner edge of the appliance door. Check that your domestic electrical installation can take the maximum load required, also taking into account any other appliances in use.

- ⚠ **Caution!** Connect the machine to an earthed socket.
- ⚠ **Caution!** The manufacturer does not accept any responsibility for damage or injury through failure to comply with the above safety precaution.
- ⚠ **Caution!** The power supply cable must be easily accessible after installing the machine.
- ⚠ **Caution!** Should the appliance power supply cable need to be replaced, this must be carried out by a Service Centre.

Environment concerns

The symbol  on the product or on its packaging indicates that this product may not be treated as household waste. Instead it should be taken to the appropriate collection point for the recycling of electrical and electronic equipment. By ensuring this product is disposed of correctly, you will help prevent potential negative consequences for the environment and human health, which could otherwise be caused by inappropriate

waste handling of this product. For more detailed information about recycling of this product, please contact your local council, your household waste disposal service or the shop where you purchased the product.

Packaging materials

The materials marked with the symbol  are recyclable.

>PE<=polyethylene

>PS<=polystyrene

>PP<=polypropylene

This means that they can be recycled by disposing of them properly in appropriate collection containers.

Ecological hints

To save water, energy and to help protect the environment, we recommend that you follow these tips:

- Normally soiled laundry may be washed without pre-washing in order to save detergent, water and time (the environment is protected too!).

- The machine works more economically if it is fully loaded.
- With adequate pre-treatment, stains and limited soiling can be removed; the laundry can then be washed at a lower temperature.
- Measure out detergent according to the water hardness, the degree of soiling and the quantity of laundry being washed.

192996871-00-312009



Free Manuals Download Website

<http://myh66.com>

<http://usermanuals.us>

<http://www.somanuals.com>

<http://www.4manuals.cc>

<http://www.manual-lib.com>

<http://www.404manual.com>

<http://www.luxmanual.com>

<http://aubethermostatmanual.com>

Golf course search by state

<http://golfingnear.com>

Email search by domain

<http://emailbydomain.com>

Auto manuals search

<http://auto.somanuals.com>

TV manuals search

<http://tv.somanuals.com>