

INSTRUCTION BOOKLET

**READ AND KEEP
THESE INSTRUCTIONS**

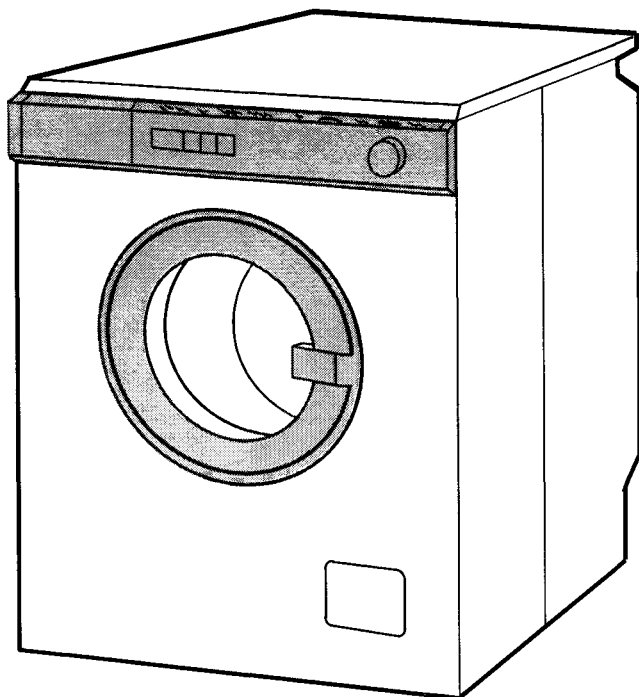

**WASHING MACHINE
FJ 1040/A**

ZANUSSI

INDEX

Page	2	Technical specifications
Page	3	Warnings
Page	4	The control panel
Page	6	Your machine
Page	7	Installation instructions
Page	11	Use of controls
Page	14-15	The washing programmes
Page	16	Use of detergent and additives
Page	18	Washing 4 kg of white cotton at 95°C
Page	20	Washing 2 kg of delicate synthetic fabrics at 40°C
Page	22	Washing hints
Page	23	Maintenance
Page	24	Cleaning the filter
Page	25	Servicing
Page	32	Zanussi guarantee conditions
Page	33	5 Year cover

TECHNICAL SPECIFICATIONS

DIMENSIONS	Width	60 cm (23.6")
	Height	85 cm (33.5")
	Depth	57 cm (22.4")
ELECTRICAL CONNECTION	Voltage	220/240V - 50Hz
	Maximum power absorbed	2550 W (13A)
WATER PRESSURE	Minimum (hot)	5 psi
	Minimum (cold)	7 psi
	Maximum	110 psi
MAXIMUM RECOMMENDED LOAD	Cotton, linen	4.5 kg (10 lb)
	Synthetics, delicate fabrics	2 kg (4.5 lb)
	Wool	1 kg (2.2 lb)
SPIN SPEED	Maximum	1000 r.p.m.

This appliance conforms to the E.E.C. directive No. 87/308 of 2/6/87 regarding the suppression of radio interference.

WARNINGS

It is most important that this instruction book should be retained with the appliance for future reference. Should the appliance be sold or transferred to another owner, or should you move house and leave the appliance, always ensure that the book is supplied with the appliance in order that the new owner can be acquainted with the functioning of the appliance and the relevant warnings.

These warnings are provided in the interest of safety. You must read them carefully before installing or using the appliance.

-
- ▲ This appliance is designed to be operated by adults. Children should not be allowed to tamper with the controls or play with the product.
 - ▲ It is dangerous to alter the specifications or attempt to modify this product in any way.
 - ▲ Any electrical work required to install this appliance should be carried out by a qualified electrician or competent person.
 - ▲ Any plumbing work required to install this appliance should be carried out by a qualified plumber or competent person.
 - ▲ This product should be serviced by an authorized Zanussi Service Centre, and only genuine spare parts should be used.
 - ▲ Care must be taken to ensure that the appliance does not stand on the electrical supply cable.
 - ▲ Always unplug the appliance and turn off the water after use.
 - ▲ Do not overload the appliance. See relevant section in instruction book.
 - ▲ Always look through the glass door to check if water has drained before opening the door. If water is present do not open door before draining the water. If in doubt, refer to your instruction book.
 - ▲ This appliance is heavy. Care should be taken when moving it.
 - ▲ All packing and transit bolts must be removed before use. Serious damage can occur to the product and to property if this is not adhered to. See relevant section in instructions.
 - ▲ The glass door becomes very hot during the washing cycle. Keep children away from the vicinity of the appliance whilst it is in operation.
 - ▲ Leave the porthole door slightly ajar between washes to preserve the door seal.
 - ▲ Only wash fabrics which are designed to be machine washed. If in doubt, consult the manufacturer of that item.
 - ▲ Before washing, ensure that all pockets are empty and buttons and zips are fastened. Avoid washing frayed or torn articles and treat stains such as paint, ink, rust, and grass before washing. Underwired bras must not be machine washed.
 - ▲ Any objects such as coins, safety pins, nails, screws, stones or any other hard, sharp material can cause extensive damage and must not be placed into the appliance.
 - ▲ Before selecting a programme or changing an ongoing programme the machine must be switched off by depressing the START/STOP push-button.
 - ▲ Garments which have been in contact with volatile petroleum products should not be machine washed. If volatile cleaning fluids are used, care should be taken to ensure that the fluid is removed from the garment before placing in the machine.
 - ▲ Wash small items such as socks, laces, washable belts etc in a washing bag or pillow case as it is possible for such items to slip down between the tub and the inner drum.
 - ▲ Only use the advised quantities of fabric softener. Damage to the fabric can ensue if you over-fill. Refer to the manufacturer's recommendations of quantities.
 - ▲ As some duvets and eiderdowns should be washed/dried in large commercial machines because of their bulk, please check with the manufacturer of the item before washing in a domestic machine, even if the dry weight of the item is within the limit advised.
 - ▲ Pets have been known to climb into washing machines. Please check your drum before use.
 - ▲ Under no circumstances should you attempt to repair the machine yourself. Repairs carried out by inexperienced persons may cause injury or more serious malfunctioning. Contact your local Zanussi Service Centre. Always insist on genuine spare parts.
-





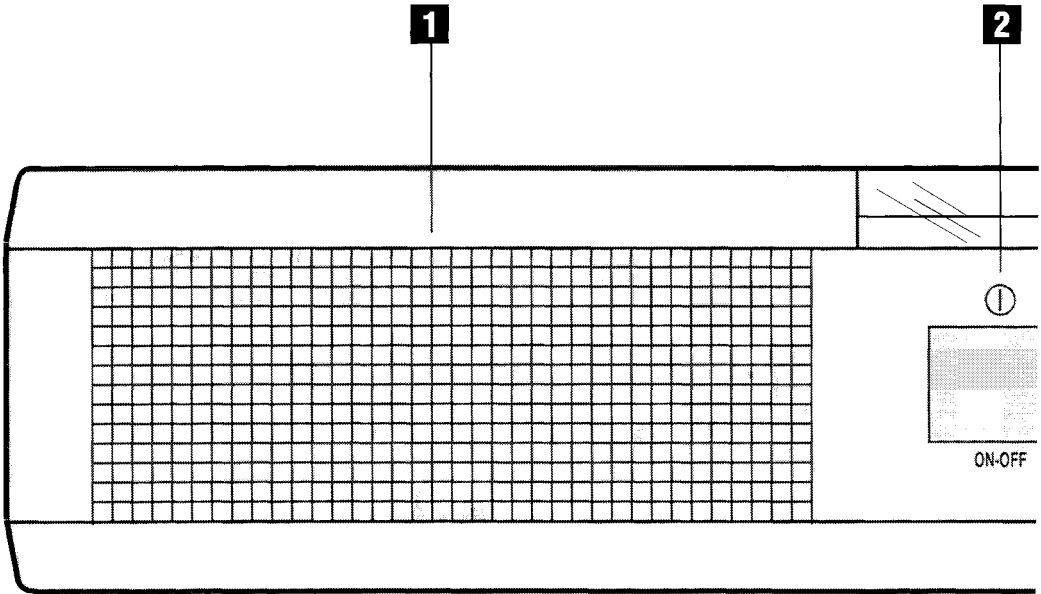





THE CONTROL PANEL

Keep this page open while reading the booklet



SYMBOLS

Symbols provided on the control panel have the following meaning:

- | | | |
|---|--|--|
|  Pilot light |  Prewash compartment |  Wash |
|  Start/Stop button |  Wash compartment |  Rinses |
|  Heavy soil |  Softener compartment |  Spin |
|  Quick wash | |  Drain |
| XE Super Economy | | |

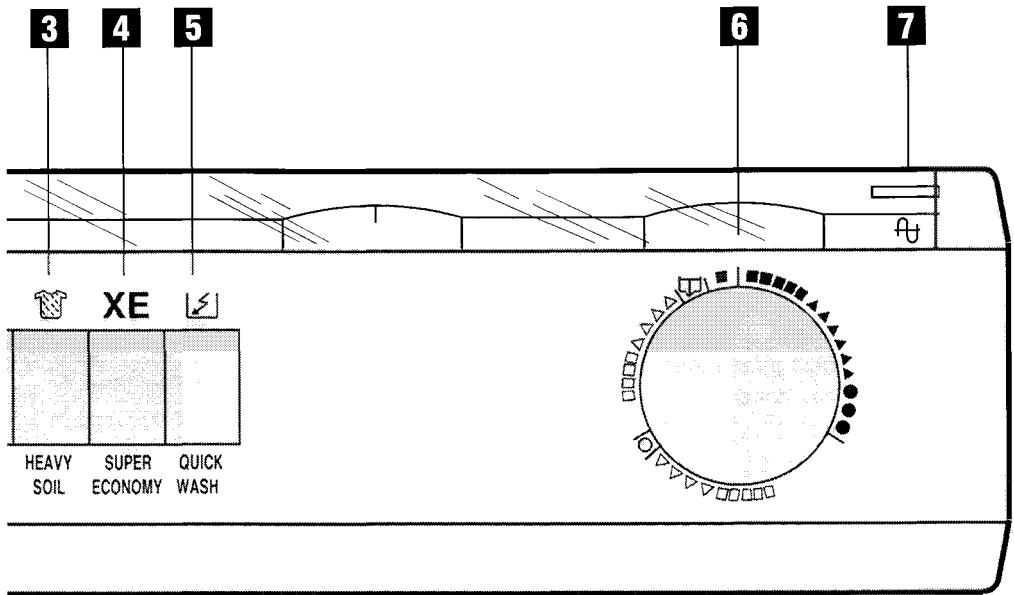

- 1** Programme chart
- 2** Start/Stop button
- 3** «Heavy soil» push button
- 4** «Super Economy» push button
- 5** «Quick wash» push button
- 6** Programme control
- 7** Pilot light

YOUR MACHINE

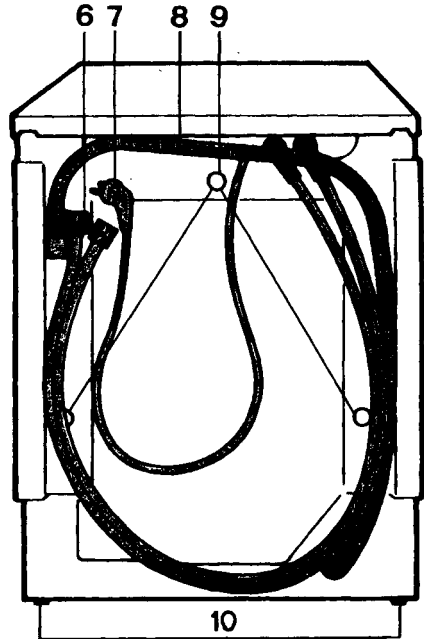
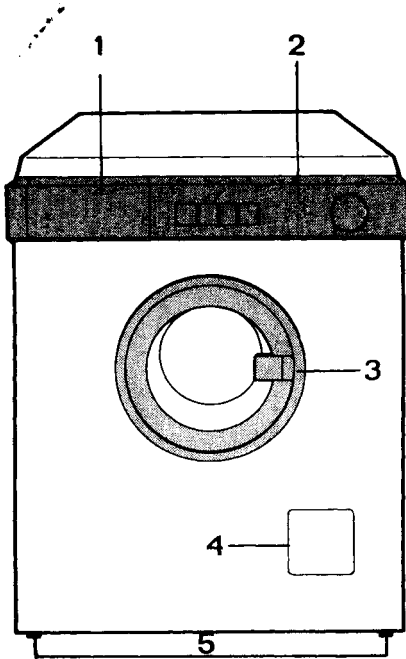

- 1 Washing powder dispenser drawer
- 2 Control panel
- 3 Door catch
- 4 Drain Filter
- 5 Adjustable feet

- 6 Water inlet hoses
- 7 Mains lead with plug
- 8 Drain hose
- 9 Transport safety screws
- 10 Rollers

INSTALLATION INSTRUCTIONS

CAUTION

Before starting the machine up, the packing must be removed as follows.

NOTE

You are advised to keep all the packing for re-use in case the machine has to be transported again.

1

Unscrew and remove the rear right screw (using a screwdriver or spanner).

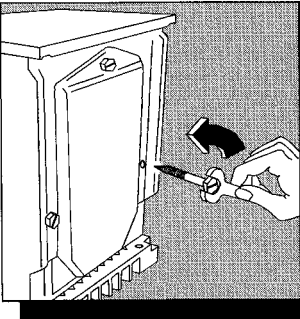

2

Lay the machine on its back making sure that the hoses are not squashed.

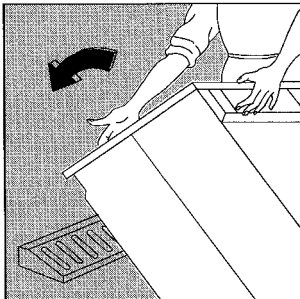

3

Remove the polystyrene block from the bottom of the machine.

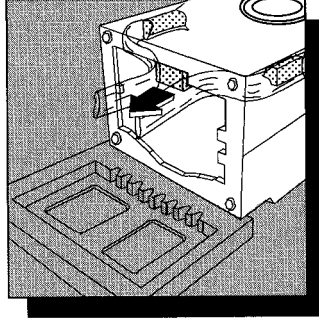

4

Carefully slide out the right polythene bag, removing it towards the centre of the machine.

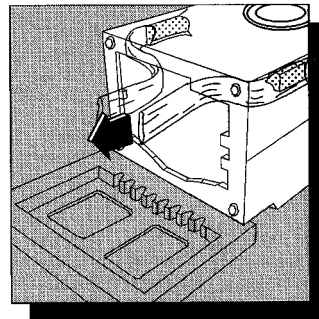

5

Repeat the operation for the left polythene bag, removing it towards the centre of the machine.

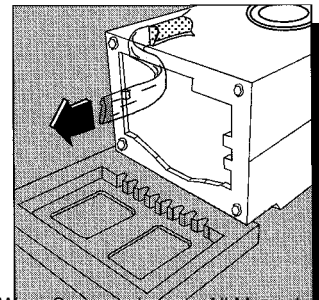

6

Remove the polystyrene base, set the machine upright and unscrew the two remaining rear screws.

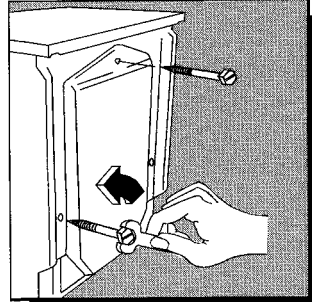

7

Slide out the 3 plastic pins.

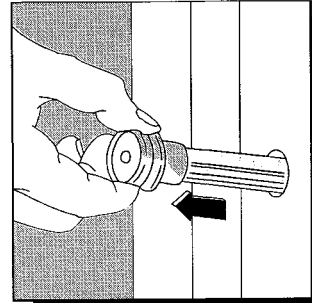

8

Plug the 3 holes with the 3 plastic plugs which you can find on the back of the machine.

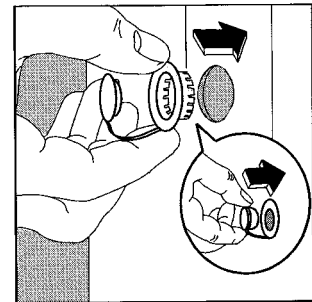

INSTALLATION INSTRUCTIONS

9

Your new Zanussi washing machine has been designed to be permanently plumbed in to your home's water supply and drainage system. However, if this is not possible, it may be connected to suitable existing taps, with the drain hose discharging into a sink.

The appliance has two inlet valves, hot and cold, with female 3/4" BSP thread connectors. If this connection size is not compatible with the plumbing of the existing installation, a variety of connectors are available from good hardware stores and plumbers merchants to suit most domestic plumbing. Any alterations to your existing plumbing must be carried out by a competent person, or qualified plumber.

10

The inlets on the back of the appliance are colour coded, blue for cold, red for hot.

Before connecting the hoses be sure to fit the mesh filters supplied as per diagram.

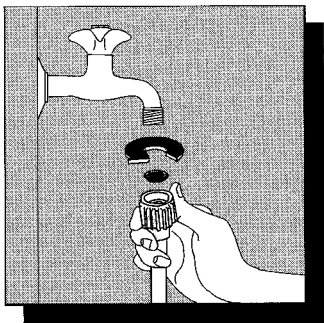

If only a cold water supply is available, connect the two hoses to a cold water outlet by means of a «Y» connection piece.

Installation should comply with local water authority and building regulations' requirements.

The appliance must be given a separate cold water supply and not be connected to a mixer tap, a single outlet water heater or a booster pump. A minimum water pressure of 7 psi is required for safe operation of the appliance.

If you cannot make the cold water connection direct from the rising mains, you may be able to operate the appliance from your cold water storage system.

There should be a minimum distance of 5.02 m (16½ ft) between the appliance's inlet and the bottom of the tank.

There will be sufficient pressure for the hot water supply from the hot water cylinder if the height between the appliance's inlet and the bottom of the cold water storage cistern (not between the appliance and hot water cylinder) is at least 2.74 m (9 ft).

11

Set the hose correctly by loosening the ring nut. After positioning the inlet hose, be sure to tighten the ring nut again to prevent leaks.

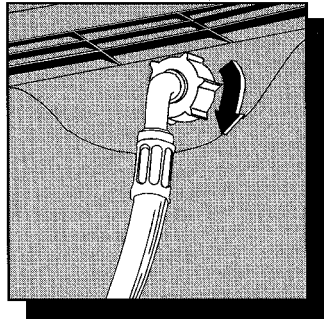

INSTALLATION INSTRUCTIONS

12

If you intend the drain hose from the machine to empty into a sink, make sure the sink is empty and that the plug hole is not blocked.

If the machine is permanently plumbed in hook the end of the hose into a standpipe installed for the purpose.

The standpipe must have an internal diameter of at least 30 mm (1 1/2 in), in order that there is an air gap between the drain hose and standpipe. Make sure, that it is designed in such a way, that the end of the drain hose cannot be covered with water.

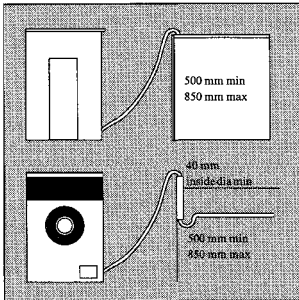

Important: Before connecting up the machine to new pipework or to pipework that has not been used for some time, run off a reasonable amount of water to flush out any debris that may have collected in the pipes.

Whether discharging into a sink or a standpipe check that the end of the drain hose is neither too high nor too low. The top of the curve in the hose's end should be no more than 90 cm (35.4") and no less than 60 cm (23.6") above floor level.

13

ELECTRICAL CONNECTION

WARNING:

THIS APPLIANCE MUST BE EARTHED

The manufacturer declines any liability should this safety measure not be observed.

If the plug that is fitted to your appliance is not suitable for your socket outlet, it must be cut off and the appropriate plug fitted.

The cut off plug should be disposed of to prevent the hazard of electric shocks in case it should be plugged into a 13 Amp socket in another part of your home.

Important

The wires in this mains lead are coloured in accordance with the following code:

GREEN AND YELLOW - EARTH
BLUE - NEUTRAL
BROWN - LIVE

If you fit your own plug, the colours of the wires in the mains lead of your appliance may not correspond with the markings identifying the terminals in your plug, this is what you have to do:

Connect the green and yellow (earth) wire to the terminal in the plug which is marked with the letter «E» or the earth \perp symbol or coloured green, or green and yellow.

Connect the blue (neutral) wire to the terminal in the plug which is marked with the letter «N» or coloured black.

Connect the brown (live) wire to the terminal which is marked with the letter «L» or coloured red.

The plug moulded on to the cord incorporates a fuse. For replacement, use a 13 Amp BS 1362 fuse.

Only ASTA approved fuses should be used.

The fuse cover/carrier must be replaced in the event of changing fuse.

The right fuse cover/carrier colour is the one shown by the coloured insert at the base of the plug.

The plug must not be used if the fuse cover/carrier is lost.

A replacement cover/carrier must be obtained from Zanussi Service Agents whose addresses are listed on the attached «Zanussi Service Agents Nationwide» or you could find your local agent by looking in your telephone directory under "Z".

This appliance complies with E.E.C. directive no. 87/308 of 2.6.87 relative to radio interference suppression.

INSTALLATION INSTRUCTIONS

14

Level the washing machine by raising or lowering the feet. Accurate levelling prevents vibrations, noises and displacement of the washing machine during operation. After levelling the machine, secure the feet by tightening the ring nuts.

Some vibration is inevitable, especially if mounted on a wooden floor.

Sprung wooden floors are particularly susceptible to vibration. For advice, consult a builder. If possible, always place the machine on a solid floor.

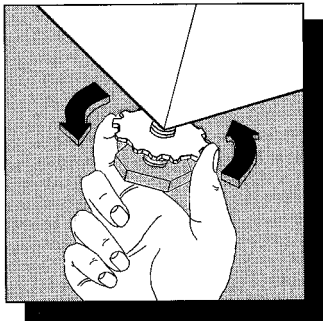

15

Special conditions

If the floor is carpeted or covered with crumbly or soft material, insert a rigid support base under the feet to prevent noises, vibrations or displacement. The base should protrude a few centimetres beyond the edge of the washing machine.

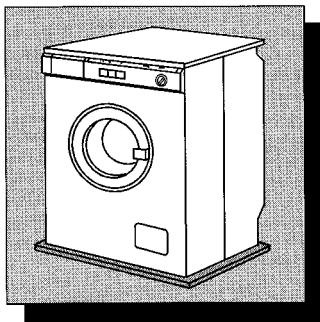

NOTE

Please ensure that when the appliance is installed it is easily accessible for the engineer in the event of a breakdown.

All plumbing and electrical work required to install this appliance must be carried out by competent persons or qualified plumbers or electricians.

USE OF CONTROLS

The user must be familiar with the machine controls and use them correctly for best washing results.

1

WASHING POWDER

DISPENSER DRAWER

The washing powder and additives must be placed in this drawer before starting the programme.

There is also a brief guide to the washing programmes on the drawer itself.

2

START/STOP BUTTON

By depressing this button the machine starts operating. When depressing it again, the machine stops.

The push button is provided with a child-proof safety lock.

Push the small slider placed on the button to lock it in the «off» position.

3

HEAVY SOIL

BUTTON

By pressing the Heavy soil button, the machine will take in only cold water on 60°C and above programmes. These would normally be hot and cold.

The water is then gradually heated to the required temperature.

The effect is to improve the overall wash performance, particularly on biological stains such as egg, blood and grass stains, and heavily soiled fabrics, since the longer «cool-soak» phase as the water heats up provides the right conditions for the powder and the water temperature to interact, and achieve the best possible results.

4

SUPER ECONOMY

BUTTON **XE**

By pressing in this push-button prior to selecting wash cycle A, you will obtain a reduction of the wash temperature from 95°C to 60°C whilst the duration of the programme will remain practically unchanged.

This will ensure a substantial saving in electricity consumption.

It is advisable to press in this push button particularly when washing strong white fabrics which do not have stubborn stains.

5

QUICK WASH

BUTTON

Ideal for quick washing of fabrics which are not very dirty (programmes A - B - C - F).

6

PROGRAMME CONTROL

To select the required programme press the knob to pop it out.

Turn the knob to the right until the marker coincides with the required programme letter.

Press the knob again if you wish to return it to its original position.

7

PILOT LIGHT

It lights up when the start/stop button is depressed and goes out when it is pressed again.

HOW AND WHEN TO USE THE CONTROLS

START

After loading the laundry and placing the washing powder and additives into the appropriate compartments, before starting up the washing machine check that:

- the appliance is plugged in
- the water supply taps are turned on
- the drain hose is correctly and securely positioned
- the door and the washing powder dispenser drawer are closed.

Depress the required, pushbutton(s).

Select the required programme by pressing and turning the programme dial **clockwise**.

At this stage, press the «start/stop» button to start the programme up.

The pilot light comes on and the programme starts up.

STOP

When the programme has finished, the programme dial will be in the «I» position and the washing machine will automatically stop.

If you have selected a programme for synthetics, mixed fabrics, silk or wool, the water remaining in the wash tub must be drained by running the draining programme before opening the door.

Open the door **1 - 2 minutes** after the end of the programme to give the safety device time to unlock.

The door must be opened only at the end of the programme!

If necessary, stop the machine by pressing the «start/stop» button **I** again.

At the end of the programme, all the buttons must be reset to the «rest» position (not depressed).

THE WASHING



















PROGRAMMES

This washing machine incorporates the «Jet System» washing for a rapid and economical wash, since the machine uses only the amount of water necessary to wash each load. This allows substantial savings of electricity, detergent and time, ensuring at the same time optimum washing results for all types of fabrics.

The following pages illustrating all the programmes provide a guide to the choice of the most suitable programme for your laundry.

The familiar wash code symbols which are found on the care labels in most clothes will gradually disappear and a new set of codes will be introduced. This change is due to changes in fabrics and detergents and because

people are tending to use fewer programmes and mix fabrics in one load. The change will bring the codes into line with the labelling used in the rest of Europe.









Old Symbol	New Symbol	Wash Action	Fabric
		Normal (Maximum)	White Cotton or Linen without Special Finishes
		Normal (Maximum)	Cotton, Linen or Viscose without Special Finishes Colourfast at 60° C.
	No longer used. White Nylon, Polyester/Cotton mixtures now included in 		
		Reduced (Medium)	Nylon, Polyester/Cotton, Viscose with Special Finishes: Cotton/Acrylic Mix.
		Normal (Maximum)	Cotton, Linen or Viscose Colourfast at 40°C but not 60°C.
		Reduced (Medium)	Acrylics, Acetate, Triacetate, Wool mixes, Polyester/wool blends.
		Much Reduced (Minimum)	Wool, wool mixes. Silks.
	No longer used. Silk now included in  ; printed acetate included in  .		
	No longer used.		

The new symbols have been used on the Programme Guide of this machine, and are listed in the Programme Charts on page 14 and 15.

The new wash symbols will also appear on the side of Washing Powder packets.

PROGRAMMES FOR COTTON AND LINEN

Recommended load: max. 4.5 kg (10 lb)

PROGRAMME	DEGREE OF SOIL	COMPARTMENTS TO USE (☸ if required)	PROGRAMME DIAL POSITION	DESCRIPTION	
PREWASH			P	Prewash at 40°C Short spin	
 95	BOILWASH WHITES	Normal soil		A	Wash at 95°C 4 rinses Spin
 60	WHITES	Light soil		B	Wash at 60°C 4 rinses Spin
 60	FAST COLOUREDS	Normal soil		B	Wash at 60°C 4 rinses Spin
 40	NON - FAST COLOUREDS	Normal soil		C	Wash at 40°C 4 rinses Spin
	LONG SPIN			D	Long spin approx. 6 min. Always preceded by a low-speed draining phase
	SHORT SPIN			G	Short spin approx. 1 min. Always preceded by a low-speed draining phase











Water filling

40°/50°C programmes - cold water filling

60°-95°C programmes - hot and cold filling, unless the heavy soil button is used.

PROGRAMMES FOR SYNTHETICS, MIXED FABRICS SILK AND WOOL

Recommended load: max. 2 kg (4.5 lb); wool max. 1 kg (2.2 lb)

PROGRAMME	DEGREE OF SOIL	COMPARTMENTS TO USE  if required	PROGRAMME DIAL POSITION	DESCRIPTION
 MIXED FABRICS	Normal soil		F	Wash at 50°C 3 rinses Stop with water left in drum
 DELICATES/ SYNTHETICS	Normal soil		J	Wash at 40°C 3 rinses Stop with water left in drum
 WOOL 	Normal soil		H	Wash at 40°C 3 rinses Stop with water left in drum
WORN ONCE	Light soil		K	Wash at 30°C 3 rinses Stop with water left in drum
HAND RINSES			L	3 rinses with additive if required Stop with water left in drum
FRESHEN UP			M	1 rinse with additive if required Stop with water left in drum
DRAIN			N	Draining of water

IMPORTANT! At the end of the last rinse, the washing machine stops without draining the water so that the garments do not crease. To drain the water, select programme **N** (draining).

USE OF DETERGENT AND ADDITIVES

Choosing the right washing powder. Always use a low lather powder. This is important as too much lather prevents the articles from being properly cleansed and you may damage the machine. **Ariel Automatic** is specially designed to complement the cleaning action of the machine.

USE OF WASHING

POWDER

The washing powder should be placed in the appropriate compartments in the washing powder dispenser drawer before starting the programme.

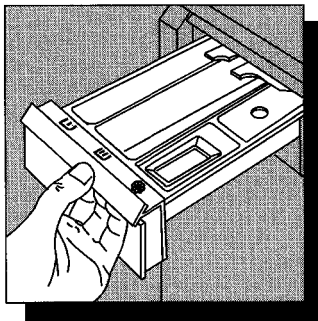

The compartment marked with the symbol **U** is for the prewash powder (if required by the programme).

The compartment marked with the symbol **M** is for the main wash powder.

HOW MUCH

DETERGENT?

Your washing machine has a unique water circulation system which runs continuously. This means that it uses detergent sparingly.

Initially you are advised to use less than the quantity specified by the detergent manufacturer.

Subsequently it is worth experimenting to see if your laundry comes out clean with smaller quantities.

Powder residue left on the clothes at the end of a wash indicates the use of too much powder. If the drum is only half-full, you can obviously use less detergent.

USE OF LIQUID

ADDITIVES

Any liquid additives for softening or dressing the laundry must be poured into the appropriate compartment of the washing powder dispenser drawer before starting the programme.

The compartment marked with the symbol  is for softeners and dressing agents; never exceed the MAX level.

USE OF LIQUID

DETERGENT

Suitable liquid detergent such as **Ariel** can be used instead of washing powder.

In this case a programme without prewash must be selected.

Pour the liquid detergent into the compartment  in the dispenser drawer immediately before starting the programme. If the detergent has its own dispenser ball, this should be used according to the manufacturer's instructions.

NOTE

Once the dispenser is filled, close it by pushing it in gently. This is particularly important if you are using fabric conditioner because if the drawer is slammed it will cause the conditioner to enter the machine prematurely.

WASHING 4 KG OF WHITE COTTON AT 95° C

Suppose you have 4 kg of normally dirty laundry to wash. It is white cotton and resistant to high temperature washing.

1

LOAD THE LAUNDRY

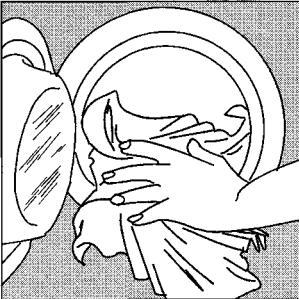

Open the door by pulling the catch outwards. Load the items to be washed one at a time and close the door.

2

MEASURE OUT THE WASHING POWDER

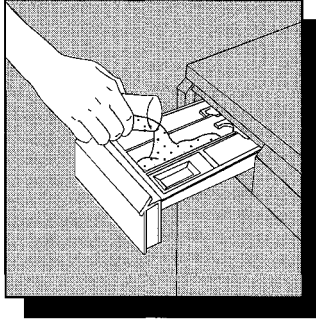

Following the table (page 16), measure the required quantity of washing powder and pour into the compartment **U**, the main wash compartment.

3

MEASURE OUT THE ADDITIVES

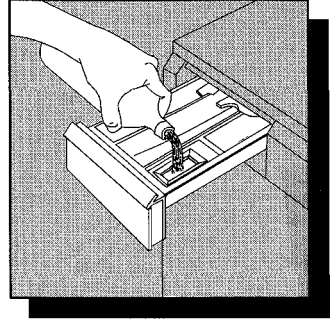

Pour the softener, if required, into the compartment marked **⊗**; do not exceed the **MAX** level.

Close the drawer gently.

WASHING 4 KG OF WHITE COTTON AT 95° C

4

SELECT THE PROGRAMME

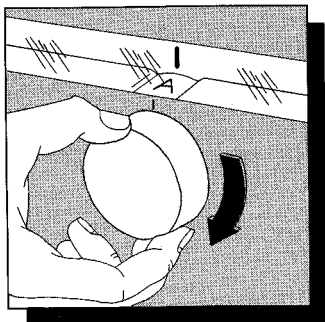

Turn the programme dial **clockwise** until letter **A** on the dial coincides with the red marker.

5

START UP

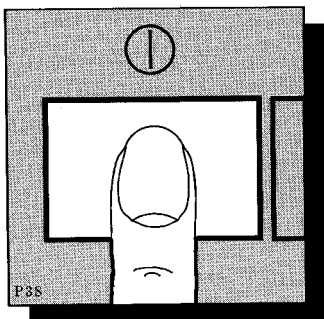

Check that:

- the appliance is plugged in;
- the water taps are on;
- the drain hose is correctly positioned.

Then, push the «start/stop» button .

The pilot lamp comes on and the washing machine starts to work.

6

AT THE END OF THE PROGRAMME

The machine automatically stops.

The door is controlled by a safety device which releases it 1 - 2 minutes after the end of the programme.

Push the «start/stop» button  again and the pilot lamp goes out.

When the programme has finished you are advised to unplug the appliance and turn off the water taps.

WASHING 2 KG OF SYNTHETIC FABRICS AT 40°C

Suppose you have 2 kg of synthetic fabric laundry to wash. They are rather delicate fabrics and should not be washed at high temperature.

1

LOAD

THE LAUNDRY

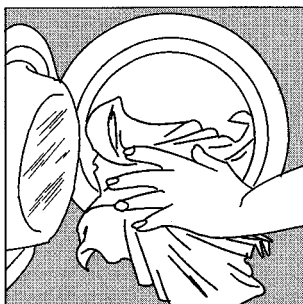

Open the door by pulling the catch outwards. Load the items to be washed one at a time and close the door.

2

MEASURE OUT

THE WASHING POWDER

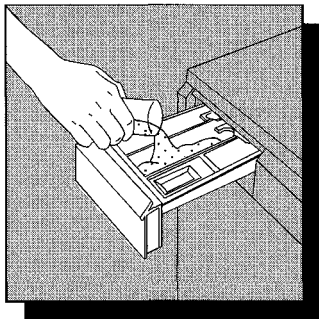

Following the table (page 16), measure the required quantity of washing powder and pour into the compartment **U**, the main wash compartment.

3

MEASURE OUT

THE ADDITIVES

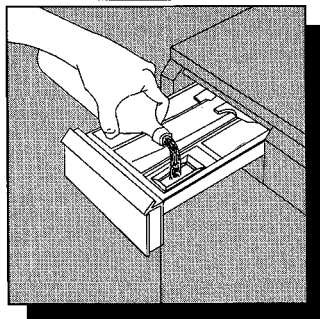

Pour the softener, if required, into the compartment marked **S**; do not exceed the **MAX** level. Close the drawer gently.

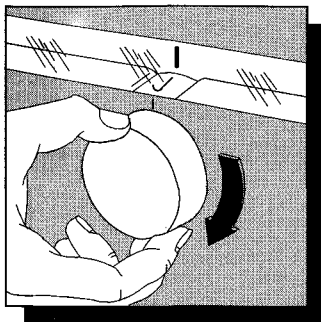
4**SELECT
THE PROGRAMME**

Turn the programme dial **clockwise** until letter **J** on the dial coincides with the red marker.

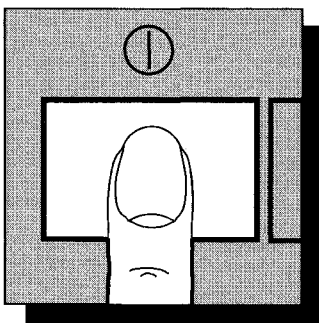
5**START UP**

Check that:

- the appliance is plugged in;
- the water taps are on;
- the drain hose is correctly positioned.

Then, push the «start/stop» button .

The pilot lamp come on and the washing machine starts to work.

6**STOP WITH THE WATER
LEFT IN THE WASH TUB**

After the last rinse, the machine stops with the water left in the wash tub to avoid the laundry creasing.

Complete the programme by draining the water as follows:
– switch the machine off by depressing the «start/stop» button .

- press and turn the programme dial **clockwise** to programme **N** (drain);
- push the «start/stop» button  again.

7**AT THE END OF
THE PROGRAMME**

The machine automatically stops.

The door is controlled by a safety device which releases it 1 - 2 minutes after the end of the programme.

Push the «start/stop» button  again and the pilot lamp goes out.

When the programme has finished you are advised to unplug the appliance and turn off the water taps.

WASHING HINTS

● Do not overload the washing machine. Weigh the laundry the first few times you use the washing machine. The average weights of the most common items are listed below as a guide:

sheet	700-1000 gr.
pillow case	100- 200 gr.
tablecloth	400- 500 gr.
serviette	50- 100 gr.
tea towel	70- 120 gr.
linen hand towel	100- 150 gr.
towelling hand towel	150- 250 gr.
towelling bath towel	700-1000 gr.
bath robe	1000-1500 gr.
man's shirt	200- 300 gr.
apron	150- 200 gr.

- Load the laundry loosely alternating large items with small ones.
- Sort the laundry according to the type of fabric, colour-fastness and how dirty it is.
- Avoid washing un-hemmed or torn items as they may unravel.
- Before washing, empty all pockets of small objects which may have been left inside (coins, keys, screws etc.).
- When washing curtains, remove the hooks.

● Close poppers and zips and fasten loose buttons.

● It is a good idea to wash new coloured items alone, at least when washing for the first time.

● When washing fabrics requiring different wash temperatures together, always select the lowest temperature.

● White items should be washed separately.

● Very small items (handkerchiefs, ribbons, socks etc.) should be washed in a washing bag.

● Use a good quality detergent suitable for automatic washing machines.

● Use the correct quantities of detergent.

● For wool, use neutral detergents only in small quantities.

● Bleach is very corrosive; it should be used with care and kept out of reach of children.

● Some stains such as fruit, wine, grass, rust etc. are obstinate and should be treated before washing with specific products which can be found in most shops. In some cases it may help to soap the stain well before washing.

● Only wool marked «Pure New Wool - washable, preshrunk» can be washed in the machine using the wool programme; other types of wool should be washed by hand or dry cleaned.

● Damp laundry should be hung out to dry as soon as possible after finishing the wash. Knitwear and woollens should be dried flat away from direct sunlight.

● Once you have finished using the machine, you are advised to unplug it and turn off the water tap.

MAINTENANCE

Successful washing and smooth running of your machine depend on a series of routine maintenance operations which should be carried out from time to time.

IMPORTANT

You are advised to unplug the appliance before all cleaning and maintenance operations.

DECALCIFICATION

The water we normally use contains lime. From time to time, and more often for hard water, it is a good idea to use a water softening powder in the machine. Do this separate to any laundry washing, and according to the softening powder manufacturer's instructions. This will prevent the formation of lime deposits.

AFTER EACH

WASH

Leave the door open for a while.

This helps prevent mould and stagnant smells forming inside the appliance.

EXTERNAL CLEANING

Use soap and water only and then dry thoroughly.

CLEANING

THE DRAWER

From time to time the washing powder and additive dispenser drawer should be cleaned.

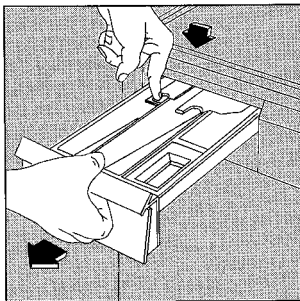

Remove the drawer and flush out under a tap.

The upper part of the additives compartment can be removed for easier cleaning.

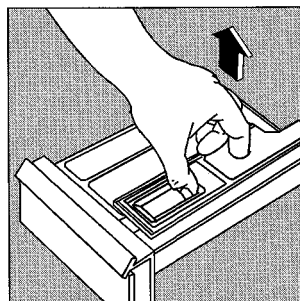

CLEANING

THE DRAWER RECESS

Having removed the drawer, use a small brush to clean the recess ensuring that all washing powder residue is removed from the upper part of the recess. Replace the drawer and run the prewash (P) for a few minutes without any clothes and then the drain

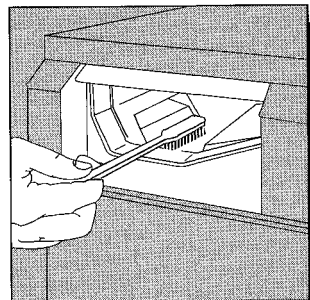

THE DANGERS OF FREEZING

If the machine is exposed to temperatures below 0°C, certain precautions should be taken.

- Turn off the water taps.
- Select a wash programme and run for a few seconds.
- Unscrew the inlet hoses.
- Unhook the drain hose from the rear support and position the end in a bowl. Run the draining programme for a few seconds.
- When you intend to start the machine up again, make sure that the room temperature is above 0°C.

CLEANING THE FILTER

THE WATER DRAIN FILTER

A clean filter is important for correct functioning of the washing machine, and should therefore be cleaned after every wash.

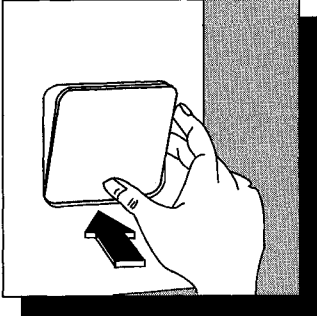

Open the panel covering the filter and place a container underneath to catch any spillage.

If the filter is blocked and the machine is unable to drain you will need to drain the water from the machine at this stage.

To do this, unhook the drain hose from the standpipe or sink and hold the end of the hose over a bowl on the floor. The water should drain by gravity into the bowl. When the bowl is full, hook the hose back up and empty the bowl. Repeat the procedure until the water stops flowing out.

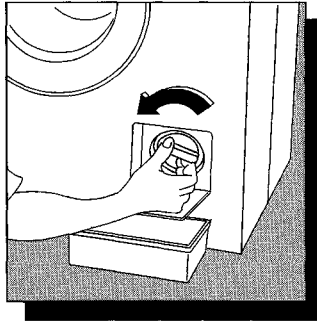

Unscrew the filter.

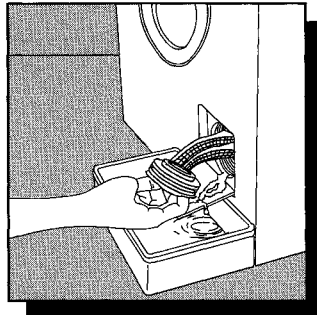

Remove the filter.

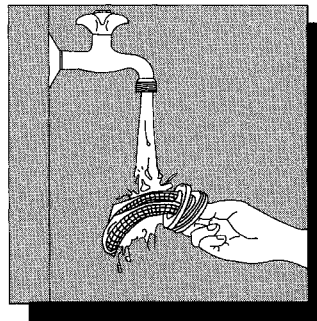

Clean carefully under a fast-running tap.

WARNING

When the appliance is in use and depending on the programme selected there can be hot water in the filter. Never remove the filter during a wash cycle, always wait until the appliance has finished the cycle, and is empty. When replacing the filter, ensure it is securely retightened. This will prevent leaks and also stop young children being able to remove the filter.

THE WATER INLET FILTERS

If your water is very hard or contains traces of lime deposit, the water inlet filter may become clogged.

It is therefore a good idea to clean them from time to time.

Turn off the water taps. Unscrew the water inlet hoses.

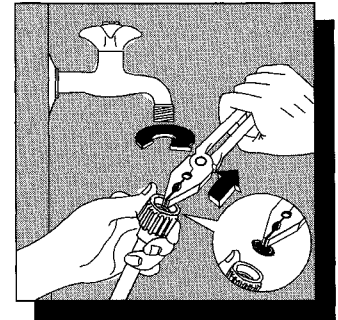

Remove and clean the filters using a hard bristle brush.

Replace the filters and tighten up the inlet hoses.

SERVICING

Certain problems are due to lack of simple maintenance or oversights and can be solved easily without having to call the Servicing Department.

PROBLEM	CAUSE	SOLUTION
THE MACHINE DOES NOT START UP (with pilot light off)	<ul style="list-style-type: none">● The «start/stop» button is not pressed● The door is not closed properly● The appliance is not plugged in● There is no electric supply from the wall socket	<ul style="list-style-type: none">▶ Press the «start/stop» button▶ Close the door▶ Plug the appliance in▶ Check the fuse
(with pilot light on)	<ul style="list-style-type: none">● The programming dial is not correctly positioned● No water is entering the machine	<ul style="list-style-type: none">▶ Consult a qualified electrician▶ Press and turn the programme dial to the selected programme▶ See solutions to the problem: THE MACHINE DOES NOT FILL
THE MACHINE DOES NOT FILL	<ul style="list-style-type: none">● The water tap is not on● The water supply has been cut off● The inlet hose is bent● The water pressure is too low● The water inlet filter is clogged	<ul style="list-style-type: none">▶ Turn the tap on▶ Wait until the water supply is restored▶ Straighten the bend out▶ If this occurs often, consult a qualified plumber▶ Clean the filter (see page 24)
THE MACHINE EMPTIES AS IT FILLS	<ul style="list-style-type: none">● The end of the drain hose is too low● The end of the drain hose is submerged in the water● Drain pipe without vent-hole	<ul style="list-style-type: none">▶ Position the drain hose at the correct height (between 60 and 90 cm)▶ The end of the drain hose must NOT be submerged▶ Consult a qualified plumber
THE MACHINE DOES NOT DRAIN OR SPIN	<ul style="list-style-type: none">● You have selected a programme without a drain cycle● The drain filter is clogged● The drain hose is bent● The drainage system pipes are blocked● The drain hose extension is incorrect	<ul style="list-style-type: none">▶ Run the draining programme▶ Clean the filter. Before doing this, see page 24.▶ Straighten the hose out▶ Consult a qualified plumber▶ Consult a qualified plumber

PROBLEM	CAUSE	SOLUTION
<p>■ THE MACHINE LEAKS OR OVERFLOWS</p>	<ul style="list-style-type: none"> ● Too much washing powder ● Unsuitable washing powder ● The inlet hose ring is loose ● The detergent dispenser drawer or recess are clogged ● The end of the drain hose is not securely positioned 	<ul style="list-style-type: none"> ▶ Reduce the quantities of washing powder ▶ Only use washing powder suitable for automatic machines ▶ Tighten the ring (see page 8) ▶ Clean the drawer and recess (see page 23) ▶ Position the drain hose correctly
<p>■ THE MACHINE VIBRATES OR IS NOISY</p>	<ul style="list-style-type: none"> ● The internal packing has not been removed ● The machine is not level ● The machine is in contact with the wall or furniture ● Washing load badly distributed ● The machine is overloaded 	<ul style="list-style-type: none"> ▶ Remove internal packing (see p. 7) ▶ Adjust the feet (see page 10) ▶ Move the machine; it should rest freely on its feet ▶ Remember to shake out large items (e.g. sheets) when loading ▶ Run the draining programme (N), reduce the load and continue
<p>■ THE DOOR DOES NOT OPEN</p>	<ul style="list-style-type: none"> ● The safety device has locked it ● Water in the wash tub 	<ul style="list-style-type: none"> ▶ Wait 1 - 2 minutes after the end of the program before opening the door ▶ Drain the water by running the draining programme (N)

If, after the above checks, there is still a fault, call your nearest Zanussi Service Force Centre, whose address and telephone number can be found on the following pages.

Please make sure you give the model and serial number of the appliance. This information can be found on the rating plate (see picture), or on the guarantee certificate.

Original spare parts can be purchased from Zanussi Service Force Centres.

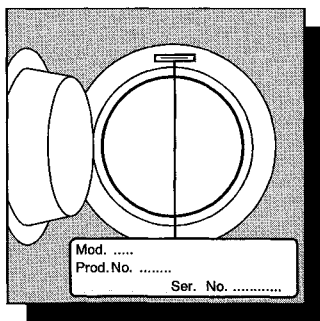

In-guarantee customers should ensure that the above checks have been made as the engineer will make a charge if the fault is not a mechanical or electrical breakdown.

Please note that proof of purchase is required for any in-guarantee service calls.

How to find the telephone number of your Zanussi Service Force listed in this leaflet

Zanussi Service areas are allocated by postcodes which are listed in alphabetical order for easy reference.

1. Look for the two letters of your address postcode in the far left 'Postcode' column.
2. Match up the number of your postcode against the number listed in the 'Postcode Numbers' column.
3. Look across the column to the Service Force Key Number for your area. Turn to the last page of this directory for the address and telephone number to contact for service which is listed against your key number.

If you are unsure of your postcode, the main towns and cities are listed in alphabetical order for easy reference.

Additionally, your local Zanussi Service Force Centre telephone number is listed under 'Z' in your telephone directory.

The Customer Care Department at Zanussi House, Hambridge Road, Newbury, RG14 5EP, Tel: 0635 521313, will be happy to help you with any queries or difficulties.



Post-code Letter	Town	Post-code Number	Service Force Key Number	Post-code Letter	Town	Post-code Number	Service Force Key Number
AB	Aberdeen	1-5	1	DE	Derby	11-12	18
AL	St Albans	1-10	2	DG	Dumfries	1-7, 10-12	34
A	Brecon	45	3	DG		13-14	35
BA	Bath	1-5, 11-15	4	DG		8-9	36
BA		7-10,20-22	5	DH	Durham	1-9	37
BA		6,16	6	DL	Darlington	1-17	37
BB	Blackburn	1-12	7	DN	Doncaster	1-7, 10-12, 22	33
BD	Bradford	1-23	8	DN		14	38
BD		24	7	DN	Doncaster	8-9, 15-21, 31-40	39
BH	Bournemouth	1-18, 21-25	9	SUB POSTCODE DIVISION			
BH		19-20	10	DN	Gainsborough		
BL	Bury	0-9	11		South	21-1, 21-2, 21-5	40
BN	Brighton	1-9, 11-15,	12	DN	Gainsborough		
BN		20-27	12		North	21-3, 21-4	39
BN		16-18	13	DT	Dorchester	1-6, 10-11	10
BR	Bromley	1-8	14	DT		6-9	5
BS	Bristol	1-28, 98-99	15	SUB POSTCODE DIVISION			
BT	Belfast	1-82	16	DT	Bridport East	6-3, 6-4	10
B	Birmingham	1-21, 25-33,	17	DT	Bridport West	6-5, 6-6	5
B		38, 40, 45, 47-48,	17	DY	Dudley	1-6, 8-9	17
B		60-71, 80, 97-98	17	DY		7, 10-14	41
B	Birmingham	23-24, 34-37,	18	EC	London	All EC Codes	28
B		42-44, 46, 72-	18	EH	Edinburgh	1-42, 52-54	42
B		79	18	EH		43-46	35
B	Birmingham	49-50,	19	EH	Edinburgh	47-49, 51, 55	43
B		96	19	EN	Enfield	1-11	28
B	Birmingham	95	20	EX	Exeter	1-17, 20	45
CA	Carlisle	1-16, 18-28	21	EX		18-23, 31-39	46
CA		17	7	E	London	All East Codes	28
CB	Cambridge	1-8	22	FK	Falkirk	1-4	43
CB		9-11	23	FK		10-14, 18-19	32
CF	Cardiff	1-8, 31-48	3	FK	Falkirk	5-9, 15-17	47
CH	Chester	1-4	24	FK		20-21	31
CH		5-7	25	FY	Fleetwood	0-8	7
CH		8	26	GCI	Guernsey		48
CM	Chelmsford	0-6, 8-9, 11-15	27	GL	Gloucester	1-8, 10-19,	49
CM		7	23	GL		50-56	49
CM	Chelmsford	16-24	28	GL		9	15
CO	Colchester	1-16	23	GL		20	19
CR	Croyden	0, 2-4, 9	29	GU	Guildford	1-24, 26, 34-35	50
CT	Canterbury	1-21	14	GU		25	51
CV	Coventry	1-8, 10-12, 21-23,	20	GU	Guildford	27-33	13
CV		9, 13	18	G	Glasgow	1-5, 11-15, 20-23,	47
CV	Coventry	31-35, 37	20	G		31-34, 40-46, 51-	47
CV		36	19	G	Glasgow	53, 58, 60-69, 73,	47
CW	Crewe	1-12	30	G		76-78, 81-84	47
DA	Dartford	1-18	14	G	Glasgow	71-72, 74-75	43
DD	Dundee	1-5, 7-11	31				
DD		6	32				
DE	Derby	1-7, 13-15, 55	33				

Post-code Letter	Town	Post-code Number	Service Force Key Number	Post-code Letter	Town	Post-code Number	Service Force Key Number
HA	Harrow	0-9	52	L	Liverpool	1-49, 60-70	24
HD	Huddersfield	1-8	8	ME	Medway	1-20, 99	14
HG	Harrogate	1-5	8	MK	Milton Keynes	1-17, 19, 40-46	22
HP	Hemel	1-3	2	MK		18	65
HP	Hempstead	4-23	53	ML	Motherwell	1-12	43
HR	Hereford	1-2, 4, 6-9	49	M	Manchester	1-35, 60	11
HR		3, 5	54	NE	Newcastle -on-		
HU	Hull	1-20, 55	38		Tyne	1-49, 61-70, 88	66
HX	Halifax	1-7	8	NE		98-99	66
IG	Ilford	1-11	28	NE		71	35
IOM	Isle of Man		55	NG	Nottingham	1-23, 25	33
IP	Ipswich	1-15, 30-31	56	NG		24	40
IP		16-27	57	NG	Nottingham	31-34	64
IP	Ipswich	28-29, 32-33	22	NN	Northampton	1-7, 11-12	67
IV	Inverness	1-24, 26, 30-36,	58	NN		8-10, 14-18	22
IV		40-49, 51-56	58	NN	Northampton	13	65
IV	Inverness	25, 27-28	59	NP	Newport	1-9, 44	3
JCI	Jersey		60	NR	Norwich	1-35	57
KA	Kilmarnock	1-26, 28-30	43	NW	London	All NW Codes	52
KA		27	61	N	London	All N Codes	28
KT	Kingston-on-			OL	Oldham	1-12, 15-16	11
	Thames	1-23	51	OL		13-14	7
KT		24	50	OX	Oxford	1-17	65
KW	Wick	1-14	59	PA	Paisley	1-4	47
KW		15-17	62	PA		5-19	43
KY	Kirkcaldy	1-16	32	PA	Paisley	20-27, 33, 35, 40-	68
LA	Lancaster	1-23	7	PA		49	68
LD	Llandrindod	1-8	54	PA		28-31	69
LD		3	3	PA	Paisley	32, 34, 36-39, 61	70
LE	Leicester	1-5, 7-8, 11-14,	63	PA		62-78	68
LE		16-17	63	PA	Paisley	80-82, 88	71
LE	Leicester	6, 9-10	20	PA		83-87	72
LE		15	64	PE	Peterborough	1-15, 34, 38	64
LL	Llandudno	11-15	25	PE		16-19	22
LL		16-19	26	PE	Peterborough	20-25	40
LL	Llandudno	20-21, 23, 27, 31-	25	PE		30-33, 35-37	57
LL		32, 34-40, 42-47	25	PH	Perth	1-2, 8-9, 10-18	31
LL	Llandudno	22, 24-26, 28-30,	26	PH		3-7	32
LL		33-34, 41, 48-49,	26	PH	Perth	19-26, 30-44	58
LL		51, 78	26	PL	Plymouth	1-21	73
LN	Lincoln	1-6, 8-10	40	PL		22-35	74
LN		7, 11-13	39	PO	Portsmouth	1-22	13
				PO		30-41	75
				PR	Preston	1-9	7
SUB POSTCODE DIVISION				RG	Reading	1-17, 26	53
LN	Lincoln	3-4, 3-5	40	RG		21-25, 27	50
LN		3-6	39	RG	Reading	28	4
LS	Leeds	1-29	8	RH	Redhill	1-3, 6-7, 9-20	12
LU	Luton	1-6	2	RH		4-5	50
LU		7	22	RH	Redhill	8	29

Post-code Letter	Town	Post-code Number	Service Force Key Number	Post-code Letter	Town	Post-code Number	Service Force Key Number
RM	Romford	1-5, 7, 10-18	27	TR	Truro	1-27	74
RM		6, 8-9	28	TS	Stockton-on-Tees		37
SA	Swansea	1-20, 31-32	3	TW	Twickenham	1-20	51
SA		33, 39, 41-44, 61-73	76	UB	Uxbridge	1-10	52
SA	Swansea	40, 45-48	77	WA	Warrington	1-5, 8-9, 10-15	11
SE	London	All SE Codes	29	WA		6-7	24
SG	Stevenage	1-9, 11, 15	2	WA	Warrington	16	30
SG		10, 12-14	28	WC	London	All WC Codes	52
SG	Stevenage	16-19	22	WD	Watford	1-2, 4-7	2
SK	Stockport	1-3, 6-12	30	WD		3	53
SK		4-5, 13-16	11	WF	Wakefield	1-17	8
SK	Stockport	17	33	WN	Wigan	1-5, 7	11
SL	Slough	1-10	53	WN		6,8	24
SM	Sutton	1-3, 7	51	WR	Worcester	1-14	19
SM		4-6	29	WR		15	41
SN	Swindon	1-8, 11-16	65	WS	Walsall	1-15	18
SN		9-10	4	WV	Wolverhampton	1-4, 10-14	18
SO	Southampton	1, 4, 41 -43, 51	9	WV		5-9, 15-16	41
SO		2-3, 5, 21-24, 52	13	W	London	All West Codes	52
SO	Southampton	20	4	YO	York	1-3, 5, 7-8	8
SP	Salisbury	1-5, 9-11	4	YO		4, 6, 11-18, 25	38
SP		6	9	YO	York	21-22	37
SP	Salisbury	7-8	10	ZE	Lerwick	1, 3	79
SR	Sunderland	1-7, 9	66	ZE		2	80
SR		8	37				
SS	Southend-on-Sea	0-9, 11-17 ,99	27				
ST	Stoke-on-Trent	1-18, 20-21	30				
ST		19	18				
SW	London	All SW Codes Except 2,9,16	52				
SW	London	2, 9, 16	29				
SY	Shrewsbury	1-6, 9-17, 18-22	25				
SY		7, 17-19	54				
SY	Shrewsbury	8	41				
SY		23-25	77				
S	Sheffield	1-19, 30-31, 40-45	33				
S		60-66, 74, 80-81	33				
S	Sheffield	70-73, 75	8				
TA	Taunton	1-11, 21-24	6				
TA		12-20	5				
TD	Selkirk	1-15	35				
TF	Telford	1-8, 10-13	41				
TF		9	30				
TN	Tonbridge	1-2, 4, 8-18, 23-30	14				
TN		3, 5-7, 19-22, 31-40	12				
TQ	Torquay	1-6, 9, 12-13	78				
TQ		7-8	73				
TQ		14	45				

Service Force Key Number	Service Force Address	Telephone Number	Service Force Key Number	Service Force Address	Telephone Number
1	60 Commerce Street, Aberdeen, AB2 1BP or Tel:	0224 583949 0224 582704	41	1 Underhill Street, Bridgnorth, Salop, WV16	0746 763322
2	Unit 4, Riverside Est, Coldharbour Ln, Harpenden	0582 461909	42	38 Buccleuch Street, Dalkeith, Midlothian, EH22	031 663 7758
3	3 Pentwyn Road, Blackwood, Gwent, Sth Wales	0495 223151	43	Block 2 Unit 5, Auchenraith Ind. Est. Rosendale Way, Blantyre	0698 828145
4	31 St Andrews Road, Bemerton, Salisbury, SP2	0722 336072	44	4 Royal Lane, Yiewsley, W- Drayton, UB7	0895 441917
5	31 East Street, Crewkerne, Somerset, TA18	0460 72740	45	91 Exeter Road, Exmouth, Devon, EX8 1QD	0395 263531
6	80 Killigrew Street, Falmouth, Cornwall, TR11	0984 31858	46	3 Bear St, Barnstaple, North Devon, EX32	0271 71774
7	333 Rangleat Road, Walton Summit, Preston, PR5	0772 321200	47	Unit E6C Anniesland Ind. Est. Netherton Rd, Glasgow, Scotland	041 954 5304
8	57 Ingram Road, Holbeck, Leeds, Yorks,	0532 460992		or Tel:	041 954 5349
9	63 Curzon Road, Bournemouth, BH1 4PW	0202 303363	48	Blencathra, Saumarez Lane, Castel, Guernsey	0481 56854
11	Unit 41/42 Clarendon Ct, Winwick Quay, W'ton	0925 50822	49	134 Eastgate Street, Gloucester, GL1 1QT	0452 422488
12	Unit 3, 21/25 Bridge Road, Haywards Heath, RH1	0444 417656	50	Unit 1 Redfields Ind. Pk, Church Crookham, Fleet	0252 851414
13	266 Main Road, Southbourne, Emsworth, PO10	0243 374814	51	127 Walton Road, Molesey, Surrey, KT8 ODT	081 9796366
	or Tel:	0243 371170		or Tel:	081 9797952
14	Bridgewood Hse, 8 Laker Road, Rochester, ME1	0634 201441	52	Unit 4, Riverside Est, Coldharbour Ln, Harpenden	0582 461909
	or Tel:	0689 61444	53	Reform Road, Maidenhead, Berkshire	0628 783711
15	Unit 1, Albert Crescent, Bristol, BS2 0YH	0272 713217	54	Merion House, High Street, Llandrindod Wells	0597 824842
16	Owenmore Hse, Kilwee Ind. Est., Upper Dunmurry Lane, Belfast	0232 301121	55	Tromode Wks, Cronkbourne Vill, Douglas, I.O.M.	0624 76066
17	66 Birch Rd East, Wyreley Rd Ind. Est, B'ham	021 327 1671	56	Unit 2b, Elton Park Business Centre, Hadleigh Rd, Ipswich, IP2 0DQ	0473 211713
18	Unit 3 Sterling Park, Claymore, Tamworth	0827 289800	57	75 Grove Road, Norwich, NR1 3RL	0603 629653
	or Tel:	0827 289822	58	Unit 3B3, Smithton Ind. Est. Smithton, Inverness	0463 791822
19	22 Newton Road, Malvern, Worcester, WR141NZ	0684 572915	59	Main Street, Golspie, Sutherland, KW10 6RA	040 833517
20	Unit 23/24, Alliance Business PK, Townsend Drv, Nuneaton, CV11	0203 350666	60	P.O.Box 45, Queens Road, St Helier, Jersey	0534 67001
21	High Ehenside, Egremont, Cumbria, CA22	0946 820509	61	Bruach, Blackwaterfoot, Isle of Arran	077 086 246
22	1 Wharf Road, Higham Ferrers, Northants	0933 317727	62	Hatson Ind. Estate, Kirkwall, Orkney	0856 5457
23	Unit 18, Fourth Ave, Bluebridge Ind. Est, Halstead, Essex	0787 473982	63	30a Scotland Road, Market Harborough, LE16	0858 33229
24	Unit 14, Dock Road, Birkenhead, L41 1JJ	051 639 1287	64	Pinfold Rd, Manning Rd Ind. Est. Bourne, Lincs	0778 422147
25	Plas Fynnon W/house, Middleton Rd, Oswestry	0691 652917	65	Unit E19, Telford Rd, Launton Ind. Est. Bicester	0869 248598
26	Easy Launderette, Panton Hall, Denbigh, Clwyd	074 581 3272	66	Unit C1, Bergen Cl, Tyne Tunnel Trad. Estate, North Shields, Tyne & Wear	091 2960166
27	19 Sirdar Rd, Off Brook Rd, Rayleigh, Essex	0268 741171	67	53 Sandringham Road, Northampton, NN1	0604 37061
28	284 Alma Road, Enfield, EN3	081 805 6825	68	96 Argyll Street, Dunoon, Argyll, PA23 7NE	0369 2147
29	194 Court Road, Eltham, London, SE9 4EN	081 859 3939	69	43 Crosshill Avenue, Cameltown, Argyll	0586 52008
30	Unit 8, Croft Road, Newcastle under Lyme, Staffs, ST5 OTW	0782 713003	70	Moss Field Workshop, Moss Field Drive, Oban	0631 664530
31	3-7 Blackness Street, Dundee, Scotland, DD1	0382 642828	71	2 Killweivagh, Gregory, Benbecula, Outer Hebrides	0870 2331
	or Tel:	0382 455862	72	Churchouse, 16 James St, Stornaway, Isle of Lewis	0851 5555
	or Tel:	0382 826809	73	5-7 Brunswick Road, Cattedown, Plymouth, PL4	0752 222540
32	33a Burnside, Auchtermuchty, Fife, Scotland	0337 28807	74	80 Killigrew Street, Falmouth, Cornwall, TR11	0326 314600
33	Unit 63, Storforth Ln Trad. Est. Chesterfield	0246 231790	75	109-111 Hunnyhill, Newport, Isle of Wight	0983 523062
34	93 Irish Street, Dumfries, Scotland	0387 69694	76	Roch, Haverfordwest, Dyfed	0437 710366
35	2-8 Wood Market, Kelso, Borders, TD5 7AX	0573 24411	77	4 Market Street, Aberaeron, W. Wales, SA46	0545 570254
36	27 Antrim Ave, Stranraer, Dumfries & Galloway	0776 3277	78	250-252 Torquay Road, Preston, Paignton	0803 529969
37	8 Cumbie Way, Aycliffe Ind. Est. Newton Aycliffe	0325 300606	79	3-4 Carlton Place, Lerwick, Shetland, ZE1	0595 2915
38	Unit 1, Boulevard Unit Fact. Est. Hull, HU3 4AY	0482 223335	80	Harlsdale, Symbister, Whalasa, Shetland	08066 546
39	Unit 2, Cromwell Road, Grimsby, DN31 2BN	0472 358760			
40	Unit 14 Stonefield Park, Clifton Street, Lincoln	0522 532330			

PEACE OF MIND FOR TWELVE MONTHS

ZANUSSI

GUARANTEE

CONDITIONS

This guarantee is in addition to your statutory and other legal rights which will not be excluded or in any way diminished by the return of this guarantee card.

We, Zanussi Ltd., undertake that if, within twelve months of the date of the purchase, this ZANUSSI appliance or any part thereof is proved to be defective by reason only of faulty workmanship or materials, we will, at our option, repair or replace the same **FREE OF ANY CHARGE** for labour, materials or carriage on condition that:

- * The appliance has been correctly installed and used only on the electricity supply stated on the rating plate.
- * The appliance has been used for normal domestic purposes only, and in accordance with the manufacturer's operating and maintenance instructions.
- * The appliance has not been serviced, maintained, repaired, taken apart or tampered with by any person not authorised by us.
- * The appliance is still in the possession of the original purchaser.

All service work under this guarantee must be undertaken by a Zanussi Service Force Centre.

Home visits are made between 8.30 am and 5.30 pm Monday to Friday. Visits may be available outside these hours in which case a premium will be charged.

Any appliance or defective part replaced shall become our property.

EXCLUSIONS

This guarantee does not cover:

- * Damage or calls resulting from transportation, improper use or neglect, the replacement of any light bulbs or removable parts of glass or plastic.
- * Costs incurred for calls to put right machines improperly installed or calls to machines outside the UK and the Republic of Ireland.
- * Appliances found to be in use within a commercial or similar environment, plus those which are the subject to rental agreements.
- * Products of Zanussi manufacture which are NOT marketed by Zanussi Ltd.
- * EEC Countries - The standard guarantee is applicable but subject to the owner's responsibility and cost to ensure the appliance meets the standards set by the country to which the product is taken. The Zanussi company in the country concerned will be pleased to advise further. Sight of your purchase receipt will be required by them.

... OR FIVE YEARS

ZANUSSI 5 YEAR

COVER CONDITIONS

For a once-only payment you can extend your Standard Guarantee to 5 years.

All the conditions and exclusions of the Standard Guarantee apply.

NOTES

1. Products supplied as "seconds", refurbished, damaged, or shop-soiled are not eligible for Zanussi 5 Year Cover.
2. The issue of a cover does NOT by virtue of our having done so, nullify the exclusions.
3. The Engineer will need to check the details of your Certificate and may make a charge for his services if it is not presented to him at the time of his call.
4. The date of purchase, or the date of initial payment (deposit) of the appliance will be deemed the date of commencement of cover.
5. Covers issued are not refundable or transferable.

GUARANTEE RECORD

Appliance purchased from..... on.....

Guarantee card no..... Model no.....

Serial no..... (These details may be taken from your Guarantee Record Card)

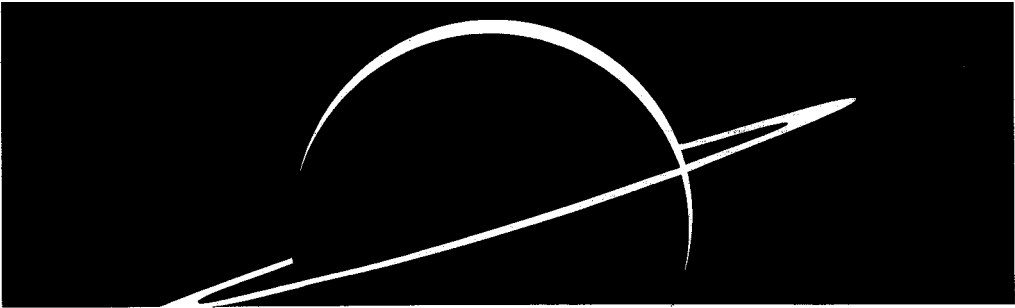

ZANUSSI

The appliance of science

Free Manuals Download Website

<http://myh66.com>

<http://usermanuals.us>

<http://www.somanuals.com>

<http://www.4manuals.cc>

<http://www.manual-lib.com>

<http://www.404manual.com>

<http://www.luxmanual.com>

<http://aubethermostatmanual.com>

Golf course search by state

<http://golfingnear.com>

Email search by domain

<http://emailbydomain.com>

Auto manuals search

<http://auto.somanuals.com>

TV manuals search

<http://tv.somanuals.com>