

ZANUSSI

WASHING MACHINES TE 1362 V - TE 1132 V TE 962 V

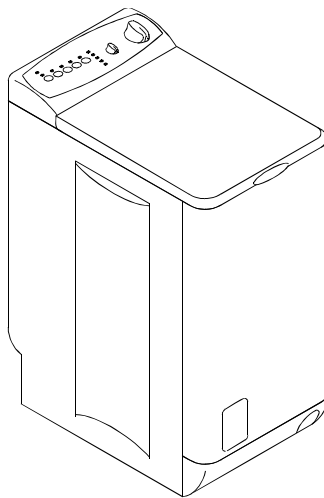

CONTENTS

FOR THE USER	3	FOR THE INSTALLER	13
Warnings	3	Warnings	13
Usage	3	Technical characteristics	13
Precautions against frost	3	Installation	14
Scrapping	3	Unpacking	14
Protection of the environment	3	Position	14
Washing machine description	4	Moving your washing machine	14
The detergents dispenser	4	Leveling	14
The control panel	4	Water inlet	14
How to do a wash ?	5	Drain	15
Loading the washing	5	Electrical connection	15
Proportioning of detergents	5		
Choice of the required program	5		
Choice of the spin drying speed	5		
Choice of the required option	5		
«Options» pushbutton	5		
«Prewash» pushbutton	5		
«Rinse plus» pushbutton	5		
«Delayed start» pushbutton	6		
Starting the program	6		
Action during a program	6		
Adding washing	6		
Modifying the current program	6		
Cancelling the program	6		
End of program	6		
Programs table	7		
Washing guide	8		
Sorting and preparing your washing	8		
Washing load depending on the nature of the material	8		
Detergents and additives	8		
International symbols for care of textiles	9		
Care and cleaning	10		
Descaling the washing machine	10		
The surface	10		
The detergents dispenser	10		
The drain filter	10		
Operating problems	11		
Guarantee	12		
After Sales Service	12		

A. FOR THE USER

1. WARNINGS

Keep this user's manual with your washing machine. If you sell your washing machine or give it away, make sure that it is accompanied by its user's manual. The new user can then be informed of how the washing machine operates and read relevant warnings.

These warnings have been written for your safety and for the safety of others. Please read these comments carefully before installing and using your washing machine. Thank you for your attention.

1.1. Usage

- When you receive your washing machine, unpack it or have it unpacked immediately. Check its general appearance. Make any reserves in writing on the delivery form and keep a copy.
- Your washing machine was designed for use by adults. Make sure that children do not touch it or use it as a toy.
- Do not modify or attempt to modify the characteristics of this washing machine. This could be dangerous for you.
- Your washing machine is intended for normal domestic use. Do not use it for commercial or industrial purposes or for any purpose other than that for which it was designed : to wash, to rinse and to spin.
- Unplug the power supply plug and close the water supply tap every time after using your washing machine.
- Only wash articles that can resist machine washing. Refer to the instructions on the label for each article.
- Do not wash underwear with bones, or any material without hems, or torn materials in your washing machine.
- Remember to remove all coins, safety pins, boraches, screws, etc., before each wash. They can cause serious damage if they are left in your washing.
- Do not put articles in your washing machine if you have used a solvent, alcohol, trichloroethylene, etc., to remove stains from them. If you must use these stain removers, wait until the product has evaporated before putting the articles in the drum.
- Collect all small articles such as socks, belts, etc., in a small cloth bag or pillow case.
- Use the quantity of detergent indicated in the «proportioning of detergents» section.
- Always unplug the washing machine before cleaning it and doing any maintenance.

1.2. Precautions against frost

If your washing machine is exposed to temperatures below 0°C, take the following precautions :

- Close the tap and disconnect the water supply pipe.
- Put the end of this pipe and the drain pipe into a bowl on the floor.

- Select the «Drain» programme and make sure it works until it is complete.
- Switch the washing machine off by putting the program selector to the «Off»* position or pressing on the «On/Off»* key.
- Unplug the washing machine.
- Screw in the water inlet pipe and install the drain pipe.

Water that remained in the pipes will then be evacuated, thus preventing the formation of frost or ice that can damage your washing machine.

The next time you want to use your washing machine, make sure that it is installed in a room in which the temperature is above 0°C.

1.3. Scrapping

All materials marked with the  symbol can be recycled. Put them in a waste tip (ask for information from your municipal offices) so that they can be recovered and recycled.

When you take your washing machine to the tip, make sure that everything that could be dangerous is out of service ; cut the power supply cable flush with the surface of your washing machine.

1.4. Protection of the environment

We recommend that the following instructions should be followed to achieve savings in water and energy and therefore to contribute to protection of the environment:

- If possible, use the washing machine at full capacity rather than with partial loads (however, do not overload the drum).
- Only use the Prewash or Soak function for very dirty washing.
- Use a detergent dose adapted to the water hardness (see «proportioning of detergents» section) and to the amount of washing and how dirty it is.

*depending on model

2. WASHING MACHINE DESCRIPTION

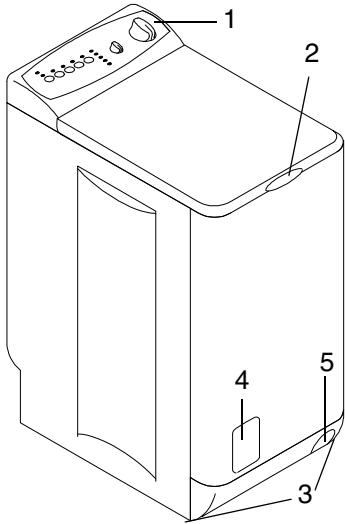

- 1 - Control panel
- 2 - Lid opening handle
- 3 - Leveling screws
- 4 - Filter door
- 5 - Lever for moving the washing machine

2.1. The detergents dispenser

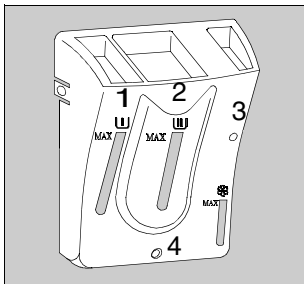

Symbols

1 - prewash

2 - wash

3 - softener

(do not exceed the MAX mark)

4 - softener overflow (if overfilled)

2.2. The control panel

- 1 - «Daily wash / quick wash» pushbutton
- 2 - «Prewash» pushbutton
- 3 - «Super rinse» pushbutton
- 4 - «Start/Start» pushbutton

- 5 - «Delay» pushbutton
- 6 - Program and information display lights
- 7 - Spinning speed selector
- 6 - Program selector

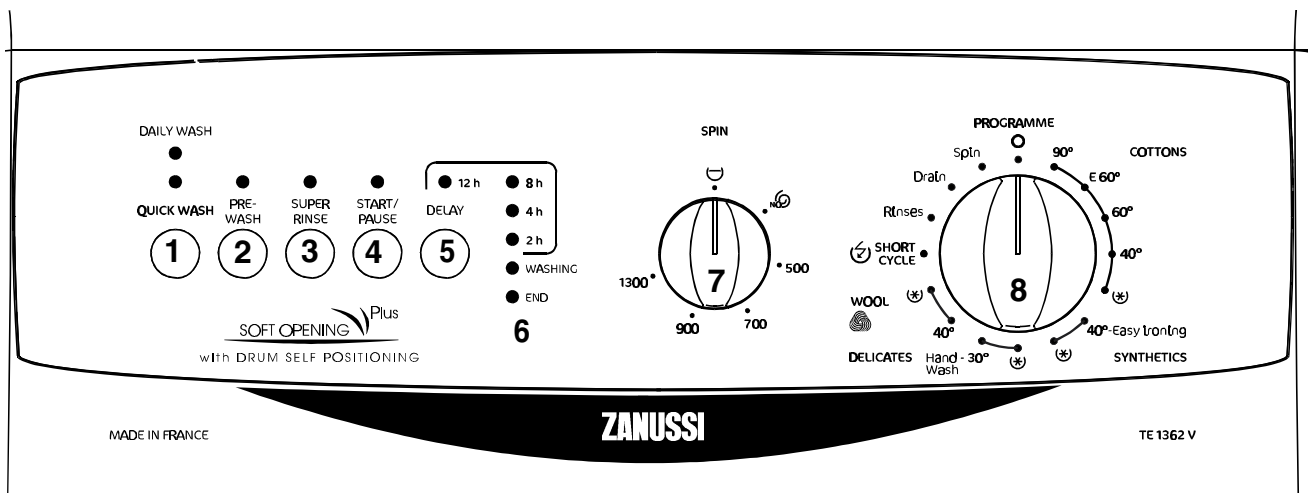

Represented model : TE 1362 V

3. HOW TO DO A WASH ?

Before the first wash in your washing machine, we recommend that you should do a preliminary wash at 90°C with detergent but without any washing to clean the tub.

3.1. Loading the washing

- Lift the machine cover.
- Open the drum by pressing on the locking button A; the two flaps automatically separate.
- Insert the washing, close the drum and the cover of your washing machine.

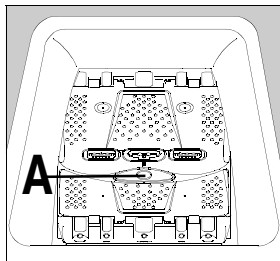

Warning : before you close the cover of your washing machine, make sure that the drum door is properly closed:

- the two flaps latched together,
- the locking button A extended.

3.2. Proportioning of detergents

Your washing machine was designed to reduce water and detergent consumption, therefore reduce the doses recommended by detergent manufacturers. Pour the powder detergent dose into the wash compartment [III] and into the prewash compartment [II] if you chose the «prewash» option. Pour in the softener into the [X] compartment if you wish. If you are using a different type of detergent, refer to the «detergents and additives» section in the washing guide.

3.3. Choice of the required programme

The programmes table will tell you which is the appropriate programme for your washing type (see § 4).

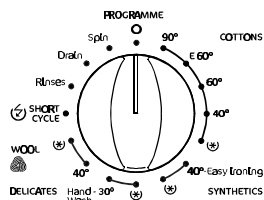

Put the programme selector onto the required programme ; the lights corresponding to the phases making up the programme will light up.

3.4. Choice of the spinning speed

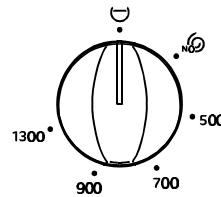

The maximum spin speed is defined as a function of the type of washing and depending on the selected program.

However, you can reduce the speed or choose the rinse hold*, drain*, or spinning suppression* positions.

3.5. Choice of the required option

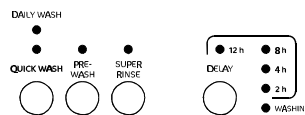

The various options should be chosen after the programme has been displayed and before pressing the Start/Pause pushbutton.

Press the required pushbutton(s) ; the corresponding lights come on. When you press again, the lights go off. When one of these options is not compatible with the chosen programme, the corresponding light will flash for a few seconds (see programme table).

3.5.1. «Daily wash / Quick wash» pushbutton

This pushbutton allows to choose between two functions :

- «Daily wash» function : This pushbutton allows to realize a washing cycle with not soiled laundry in a reduced time.
- «Quick wash» function : If you select this function, the wash time is reduced depending on which program you chose.

3.5.2. «Prewash» pushbutton

The washing machine does a prewash at 30°C maximum. The prewash finishes with a brief spinning for cotton and synthetic programs, and by a draining for delicates programs.

3.5.3. «Super rinse» pushbutton

This option adds two rinses on Cotton, Synthetics and Delicates programs. It is advised for allergic people to detergent products and in areas with fresh water.

3.5.4. «Delayed start» pushbutton

This option delays start of the programme. Select the number of hours after which you want the programme to begin by pressing on the pushbutton one or several times.

* depending on model

3.6. Starting the programme



After you chose the washing programme, press the Start/Pause pushbutton to start the cycle. The corresponding light stays on. It is normal that the programme selector does not turn during the cycle.

Pull out the power supply plug and close the water supply tap.

Note: we recommend that you should leave the cover and the drum open after use to air the washing drum.

When the washing cycle begins, the «washing» light is on.



3.7. Action during a programme

3.7.1. Adding of laundry

Press the Start/Pause pushbutton : the corresponding light flashes as long as the programme is paused. You will then hear a double "click" in the locking device when the cover opens. Press the same pushbutton again to resume the programme.

For reasons of safety, you cannot open the cover if the temperature of the washing water is too high.

3.7.2. Modifying the current programme

Before modifying the current programme, you must put the washing machine to pause by pressing on the «Start/Pause» pushbutton. If it is impossible to make the modification, the corresponding light flashes for few seconds. If you decide to change the programme in any case, you will need to cancel the current programme (see below).

3.7.3. Cancelling the programme

If you want to cancel a programme, turn the programme selector knob to the «off» position of the programme selector.

You can then select a new programme after cancelling the previous one.

3.8. End of program

The washing machine stops automatically. You will hear a double "click" in the locking device when the cover opens. The cycle end light goes on.

If you choose the rinse hold position on the spin speed variator, the rinse hold light* illuminates to inform you that water has to be drained before you can open the cover. To terminate the cycle, you can then spin the washing by choosing the spin program or drain it by choosing the drain program.

Turn the program selector knob to the "Off" position. Take out the laundry.

*depending to the model

4. PROGRAMS TABLE

The following does not show all possibilities, but simply the most frequent settings.

Program Washing type	Load	Possible options	Tempera- tures °C	Approximate consumptions		
				liters	kWh	min
COTTONS White or color, for exam- ple normally dirty work clothes, bed linen, table linen, underwear, towels.	5 kg	Daily wash / Quick wash (NOT on E 60°) Prewash Super Rinse Delay	90	63	2,10	145
			E 60 (*)	45	0,95	145
			40	58	0,65	120
SYNTHETICS Synthetic fabrics, under- wear, color fabrics, non- iron shirts, blouses.	2,5 kg	Daily wash / Quick wash Prewash Super rinse Delay	cold	57	0,15	70
			40	65	0,40	90
Easy ironing	1,0 kg					
DELICATES For all delicate mate- rials, for example cur- tains.	2,5 kg	Daily wash / Quick wash Prewash Super rinse Delay	40	52	0,60	70
WOOL Machine washable wool marked «pure wool, washable in machine, non shrinking».	1,0 kg	Delay	cold	53	0,06	45
HAND WASH Very delicate washing marked «wash by hand».	1,0 kg	Delay	30	53	0,30	50
SHORT CYCLE For only slightly dirty ma- terials, except for wool.	2,5 kg	Delay	30	43	0,30	35
Rinses Hand washed washing may be rinsed with this program.	Depending on the nature of textiles.	3 rinsings with liquid additive. Spin drying.		42	0,05	35

(Data provided for guidance and subject to change depending on usage conditions).

(*) Reference program for tests according to standard IEC 456 (E60° Cotton program).

5. WASHING GUIDE

5.1. Sorting and preparing your washing

- Sort the washing by type and care symbol (see chapter 5.4: International symbols for care of textiles): normal wash for strong washing that can resist energetic wash and spin; delicate wash for delicate washing that should be treated more carefully. For mixed loads composed of articles of different types of fibers, choose a program and temperature suitable for the most fragile fiber.
- Wash white washing and color washing separately. Otherwise, the white washing may be colored or look gray.
- New clothes very often have too much color. Preferably wash new clothes separately for the first time. Respect "wash separately" and "wash several times separately" care instructions.
- Empty pockets and spread out the washing.
- Take off all loose buttons, pins and hooks and eyes. Close zip fasteners, tie knots in laces and straps.
- Turn clothes made of several layers of textiles (sleeping bags, anoraks, etc.), colored hosiery and wool and textiles with add-on decorations, inside out.
- Wash small delicate items (socks, tights, bras, etc) in a washing net.
- Treat curtains with special care. Remove curtain hooks and put net curtains in a net bag or a sachet.

5.2. Washing load depending on the nature of the material

The quantity of washing that you put in your drum must not exceed the maximum capacity of your washing machine. This capacity may vary depending on the nature of your textiles. Reduce the quantity of washing if it is very dirty or if you have terry cloth type materials.

Not all textiles have the same volume and the same water retention capacity. This is why in general the drum should be filled:

- completely, but without excessive pressure for cotton and linen, and for mixed washes,
- half full for treated cottons and synthetic fibers,
- about one third full for very delicate articles such as net curtains and wool.

For a mixed wash, fill the drum as required for the most delicate material.

5.3. Detergents and additives

Only use detergents and additives suitable for use in a washing machine. Read the manufacturer's instructions and respect sections 2.1 and 3.2.









Powder detergents can be used without restriction; liquid detergents should be poured either in the proportioning bowl directly in the drum, or in the wash compartment provided that the washing machine is started immediately; detergents in tablets or doses must be put into the wash compartment of the detergents dispenser in your washing machine.



The quantity of detergent to be used depends on the amount of washing to be washed, the hardness of the water and how dirty the washing is.





If the water is soft, you can reduce the doses slightly. Increase the doses slightly if the water is hard (it is recommended to use a water softener) or if the washing is very dirty or stained.





You can ask the water distribution company in your region or any other competent authority to find out the degree of hardness of your water.

5.4. International symbols for care of textiles

NORMAL WASH					 Delicate wash by hand	 Do not wash
	Wash at 95°C	Wash at 60°C	Wash at 40°C	Wash at 30°C		
DELICATE WASH						

		
JAVEL WATER	Bleaching with chlorine (Javel water) allowed (only cold and with a dilute solution)	Do not bleach with chlorine (Javel water)

				
IRONING	High temperature (max 200°C)	Average temperature (max 150°C)	Low temperature (max 100°C)	Do not iron

				
DRY CLEANING	Dry cleaning (all usual solvents)	Dry cleaning (all solvents except trichloroethylene)	Dry cleaning (only oil solvents and R113)	Do not dry clean

				 High temperature	
				 Moderate Temperature	
DRYING	Dry washing spread out	Dry washing hung up	Dry washing on hanger	Drying in drum allowed	Do not dry in drum

6. CARE AND CLEANING

Do not do any cleaning operation until you have unplugged the washing machine.

6.1. Descaling the washing machine

Normally there is no need to descale the washing machine if the detergent was correctly proportioned. If descaling is necessary, use a special non-corrosive product specially designed for washing machines that you can find in the shops. Respect the proportion and frequency of descaling shown on your packaging.

6.2. The surface

Clean the surface of your washing machine using lukewarm water and a mild detergent. Never use alcohol, solvents or similar products.

6.3. The detergents dispenser

From time to time, you must clean the detergents dispenser in order to eliminate the possible wastes of the detergents and then to avoid an operating problem. The detergent dispenser is very easy to remove for a light cleaning.

Disassembly:

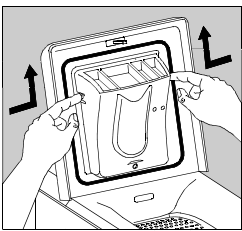

Press the clips on each side of the detergents dispenser and pull it upwards.

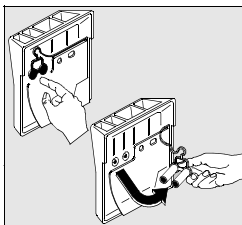

You can thus clean it using running water and a brush or a twisted cloth. Check that the siphons at the back of the detergents dispenser are not blocked.

Reassembly :

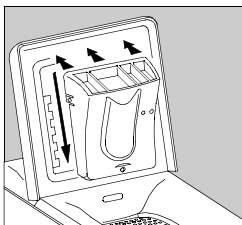

Put the detergents dispenser in the notches until they lock.

6.4. The drain filter

Clean the filter at the bottom of the washing machine regularly. The "filter" light comes on if the filter is blocked. In this case clean it immediately. If you wash washing that is very fluffy, clean it after each wash.

- **Open the door, with a screwdriver for example:**

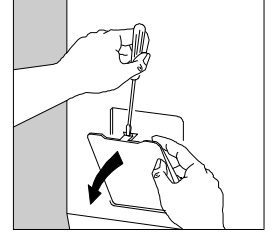
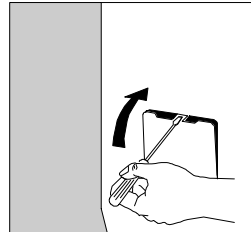

- **Drain residual water:**

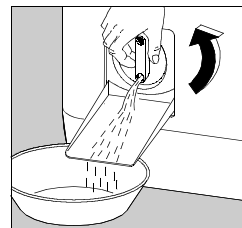

Put a receptacle under the drain. Turn the cap in the anti-clockwise direction until it is vertical to release residual water.

- **Remove the filter:**

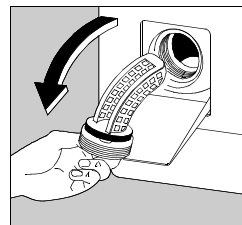

Unscrew the cap all the way and take it off. Clean it thoroughly with running water. Put the assembly back and screw it in the clockwise direction.

After cleaning the filter, you are required to closed the door. In fact, for reasons of safety, the door must be closed when the appliance is working.

*depending on model

7. OPERATING PROBLEMS

Many checks have been carried out during the manufacture of your washing machine. However, if you face a problem with its operation, please read the following sections before calling the After Sales service.

Symptom	Cause
The washing machine will not start or will not fill:	<ul style="list-style-type: none"> the washing machine is not correctly connected, the electrical installation is not working, the cover of your washing machine and the drum flaps are not correctly closed, you did not control the program start correctly, there is a power failure, the water supply is closed off, the water tap is closed, the water inlet is blocked.
The washing machine fills up but empties again immediately:	<ul style="list-style-type: none"> the drain siphon is attached too low (see installation section).
The washing machine will not spin or will not empty:	<ul style="list-style-type: none"> the drain pipe is blocked or kinked, the drain filter is blocked, the anti-unbalance mass safety device has tripped; bad distribution of washing in the drum, the «Drain» program or the «Rinse hold» option is selected, the height of the drain siphon is wrong.
There is water on the floor around the washing machine:	<ul style="list-style-type: none"> excess detergent has made too much foam that overflowed, the detergent is not suitable for washing machine, the drain siphon is not hooked on properly, the drain filter was not put back into place, the water inlet pipe is leaking.
Washing results are not satisfactory:	<ul style="list-style-type: none"> the detergent is not suitable for machine washing, there is too much washing in the drum, the washing program is not appropriate, there is not enough detergent.
The machine is vibrating or noisy:	<ul style="list-style-type: none"> not all the packing was removed from the machine (see unpacking section), the washing machine is not leveled and properly packed, the washing machine is too close to the wall or furniture, the washing is not well distributed in the drum, the load is not sufficient.
The washing cycle is much too long :	<ul style="list-style-type: none"> the water inlet is blocked, there was a power supply failure or the water was cut off, the motor temperature safety device tripped, the water inlet temperature is lower than normal, the foam detection safety system tripped (too much detergent) and the washing machine evacuated the foam, the anti-unbalance mass safety device tripped, an additional phase was added to distribute the washing in the drum better.
The washing machine stops during a washing cycle :	<ul style="list-style-type: none"> the water or electricity supply is defective, a rinse hold was programmed.
The cover does not open during the cycle :	<ul style="list-style-type: none"> the «IMMEDIATE OPENING» * light is off, the temperature of the washing water is too high. the cover cannot open until 1 to 2 minutes after the washing machine has stopped*.

Symptom	Cause
The «DRUM POSITIONNING»* light** is not on at the end of the cycle:	<ul style="list-style-type: none"> the drum could not reach the right position due to a persistent unbalanced mass; turn the drum manually.
The «End»* light ** flashes 4 times*** :	<ul style="list-style-type: none"> the cover is not correctly closed.
The «End»* light ** flashes 2 times***:	<ul style="list-style-type: none"> the drain filter is blocked, the drain pipe is blocked or kinked, the drain pipe is too high (see «installation»), the drain pump is blocked, the installation siphon is blocked.
The «End»* light ** flashes 1 time***:	<ul style="list-style-type: none"> the water tap is closed, the water network has been cut off.
Softener or Javel water flows through the overflow orifice when filling* :	<ul style="list-style-type: none"> you did not put in the right amount, the siphons at the back of the detergents dispenser are blocked.

* Depending on the model.

** Eliminate the causes of the failure if you find them, and then press on the «Start/Pause» pusbton to restart the interrupted program.

*** Depending on the model, some acoustic signals may be activated.

8. AFTER SALES SERVICE

If you have an operating problem, refer to the "Operating problems" section. If any work is necessary after you have made all your checks, please contact your washing machine dealer.

When you call the After Sales Service, mention the model and product number of your washing machine, and its serial number. This information is given on the inside of the filter door and on the name plate at the back of the washing machine.

If any work is done on your washing machine, insist that your After Sales Service uses manufacturer certified spare parts.

B. FOR THE INSTALLER

1. WARNINGS

- This washing machine is heavy. Take care when moving it.
- You must remove the packing on the washing machine before use. Failure to remove all transport protection devices can cause damage to the washing machine or nearby furniture. The washing machine must be unplugged while packing is being removed.
- Do not allow any one other than a qualified plumber to make the hydraulic connections necessary to install your washing machine.
- The washing machine must be plugged in to a power outlet with a conform earth.
- Call a qualified electrician if the electrical installation in your residence is such that you have to modify it before you can connect your washing machine.
- Please read the instructions in the "electrical connections" chapter carefully before connecting your washing machine.
- After installing your washing machine, make sure that it is not standing on its electrical power supply cable.
- When your machine is installed on a carpeted floor, make sure that the carpet does not close off the ventilation openings near the bottom of the machine.
- The power supply cable may be only replaced by the After Sales Service.
- Your manufacturer cannot be held responsible for any damage resulting from a nonconform installation.

2. TECHNICAL CHARACTERISTICS

DIMENSIONS	Height Width Depth	850 mm 397 mm 600 mm
VOLTAGE / FREQUENCY TOTAL POWER		230 V / 50 Hz 2300 W
WATER PRESSURE Connection to the water network	Minimum Maximum	0,05 MPa (0,5 bar) 0,8 MPa (8 bars) Type 20x27
 This washing machine complies with CEE directive 89-336 about the limitation of radioelectric disturbances and directive CEE 73-23 for electrical safety.		

3. INSTALLATION

3.1. Unpacking



Packing used to protect internal parts of the washing machine during transport must be removed before the washing machine is put into service for the first time.

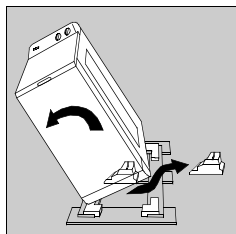

Remove all packing from the washing machine. Tilt the washing machine sideways and then remove the packing under the motor, and straighten the washing machine.

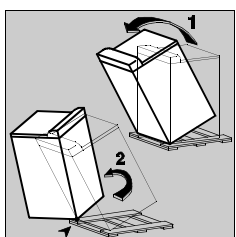

Tilt the washing machine backwards, rotate it by a quarter of a turn on one of its corner to remove the transport base.

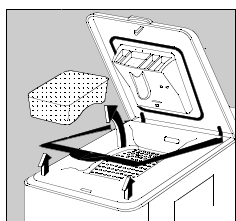

Open the washing machine lid and remove the immobilization packing and plastic films. Close the lid.

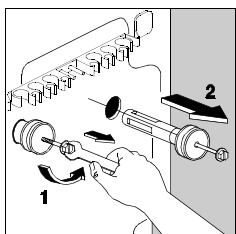

Use a 10 mm spanner to remove the two screws and spacers at the back.

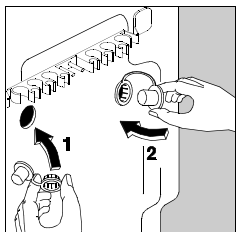

You can now see the openings that must be closed with the caches in the pack attached to the washing machine; do not forget to fold down the central capsule.

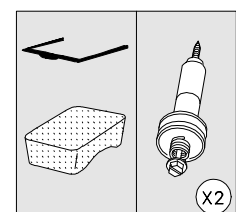

Make sure that you have removed all these parts from your washing machine and keep them so that you can use them again if you need them for future transport.

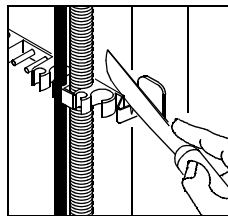

If you want to keep your washing machine aligned with the adjacent furniture, you can cut the pipe support strip at the back of your washing machine. Leave the two side closers in place.

3.2. Position

Put the washing machine on a flat hard floor in a well ventilated room.

Make sure that your washing machine does not touch the wall or any other furniture in the room.

3.3. Moving your washing machine

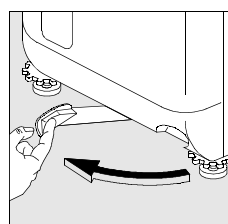

If you want to move your washing machine, lift it onto its rollers by pulling the lever at the bottom of the washing machine all the way to the left. When you have put your washing machine into the required location, put the lever back into its initial position.

3.4. Leveling

Precise leveling will prevent vibrations, noise and movements of the washing machine during operation.

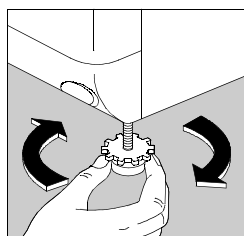

Make the washing machine level by adjusting the leveling screw that is too short.

Unscrew the stand and locking collar assembly (lift the washing machine if necessary).

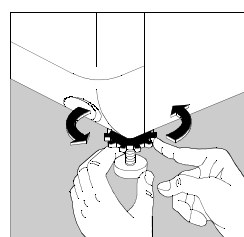

When the washing machine is stable, maintain the stand on the ground and turn the locking collar as far as possible.

3.5. Water inlet

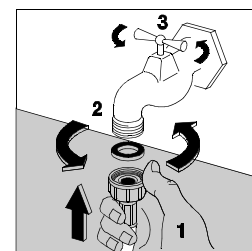

Screw the supply pipe connector onto the water inlet tap (20x27 mm), remembering to use the washer provided with the washing machine.

Open the water inlet tap.

You cannot prolong the water inlet pipe. If it is too short, buy a longer pipe provided for this purpose.

3.6. Drain

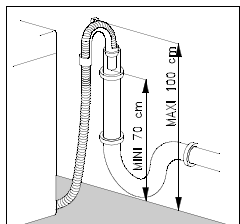

The drain siphon must be placed inside a drain pipe (or in a washbasin) at a height of between 70 and 100 cm. Make sure that it cannot fall.

- **Important:** the drain pipe must never be prolonged. If it is too short, call a professional.

3.7. Electrical connection

You can only connect this washing machine to 230 V single phase power supply.

Check rating of the fuse line: 10 A at 230V.

The washing machine must not be connected through an extension cable or a power bar.

Check that the earthing connection is conform with the regulations in force.

 **From the Electrolux Group. The world's No.1 Choice.**

The Electrolux Group is the world largest producer of powered appliances for kitchen, cleaning and outdoor use. More than 55 million Electrolux Group products (such as refrigerators, cookers, washing machines, vacuum cleaners, chain saws and lawn mowers) are sold each year to a value of approx. USD 14 billion in more than 150 countries around the world.

Free Manuals Download Website

<http://myh66.com>

<http://usermanuals.us>

<http://www.somanuals.com>

<http://www.4manuals.cc>

<http://www.manual-lib.com>

<http://www.404manual.com>

<http://www.luxmanual.com>

<http://aubethermostatmanual.com>

Golf course search by state

<http://golfingnear.com>

Email search by domain

<http://emailbydomain.com>

Auto manuals search

<http://auto.somanuals.com>

TV manuals search

<http://tv.somanuals.com>