

**ZANUSSI**

---

# Instructions for the use and care of Z 939T/Z 949T washing machines



# Contents

## Installation

Unpacking	Page	4
Positioning & levelling	»	4
Water connection	»	5

<b>Electrical connection</b>	Page	7
------------------------------	------	---

## Operation

Controls description	Page	8
Loading the clothes	»	9
Filling with washing powder	»	9
Use of additives	»	9
Which powder?	»	10
Selection of washing programmes	»	10
Wash cycle	» 11 &	12
Starting	»	13
Stopping	»	13

## Care and cleaning

Cleaning the machine	Page	14
Cleaning the drain filter	»	14
Hints for care of washing powder dispenser	»	15
Helpful tips for washing	»	15

<b>Servicing</b>	Page	16
------------------	------	----

## Building-in instructions

Instructions for door reversal	Page	17
Instructions for application of decorative paneling on door and on bottom panel	»	18
Building instructions	»	19

# Technical data

Width	23.6 ins (600 mm)
Overall depth (excluding hose)	23.6 ins (600 mm)
Height	33.5 ins (850 mm)
Weight	178,5 lbs (80 kg)
Dry clothes capacity (excluding synthetic fabrics and wool)	10 lbs (4,5 kg)
Revolutions during spinning	500/1000 r.p.m.
Total power absorbed	2500 W
Heater rating	2300 W
Motor rating during washing	200 W
Motor rating during spinning	350/700 W
Water load: normal level	2.9 gals (13 l)
Water load: high level	4.4 gals (20 l)
Maximum water pressure	110 p.s.i. - 759 kN/m <sup>2</sup>
Minimum water pressure (cold)	7 p.s.i. - 48 kN/m <sup>2</sup>
Minimum water pressure (hot)	4 p.s.i. - 27 kN/m <sup>2</sup>
Supply voltage	220 ÷ 240 V
Supply frequency	50 Hz.

# Installation

## Unpacking

After removing outer carton, reinforcing angles and polythene wrapping, proceed as follows:

Unscrew and remove, by means of the special spanner that comes with the machine, the three big screws to be found on the back of the appliance (fig. 1).

(This wrench is to be found underneath the lower panel of the cabinet).

Insert a screwdriver into the free holes left after removing the screws, and tilt it as required to cause the three plastic spacers inside the machine to fall down.

Rest the washing machine on its back and remove the two inner angle packings by pulling the left string A first and then the right string B (fig. 2). This operation should be carried out very carefully to prevent the angle packings from damaging the internal components of the machine.

Remove the polystyrene base packing and the three plastic spacers that fell down during the preceding operations.

**Note:** It is advisable to keep all parts of the inner packing for re-use in case the machine has to be transported again.

## Positioning & Levelling

Set up the machine in its permanent operating position and then carefully level it adjusting the two levelling feet (fig. 3) by means of the special small wrench that comes with the machine.

It is recommended to perform this work very accurately to avoid any vibration, noise or shifting of the appliance during operation.

Also make sure that the washing machine does not touch walls, furniture, etc. while working.

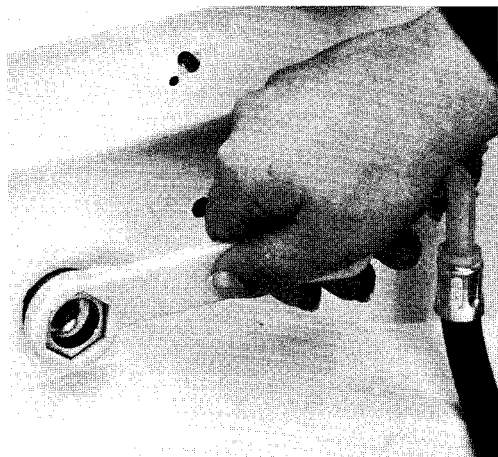

fig. 1

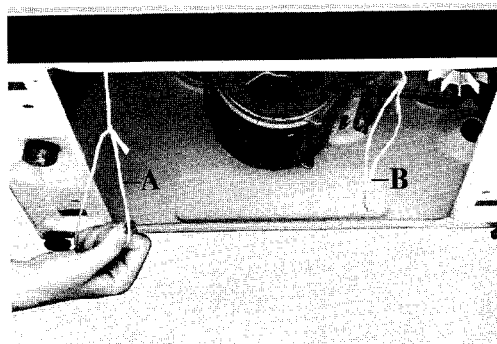

fig. 2

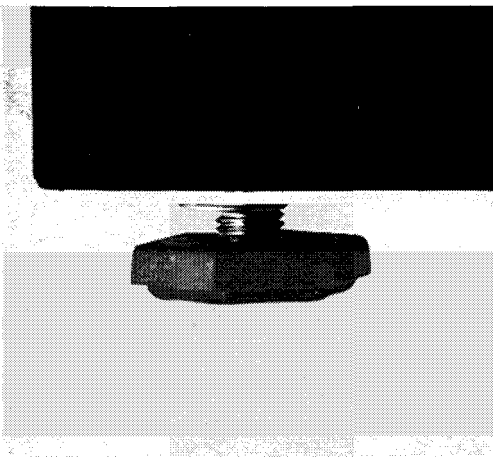

fig. 3

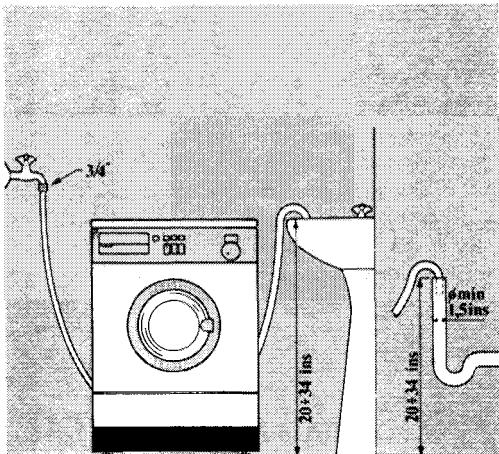

fig. 4

## Water connection

The machine may either be plumbed in or connected to existing taps. Details are given below.

## Water supply

Separate supplies of hot and cold water are necessary. Single outlet gas or electric heaters are not suitable. If only cold water supply is available, connect the two hoses to a cold water tap.

## Water outlet connection

The drain pipe from this machine must connect into the main drain of the premises, but not into the rainwater drain.

Information as to the type of drain servicing your premises can be obtained from a builder or the Local Authority. The curved end of the outlet hose should be firmly hooked over the edge of a sink or connected to a suitable drain pipe in the wall or under the sink; however, such a drain pipe should have a built-in air break in order to avoid water syphoning from the machine during draining.

The top of the drain hose (curved end) should not be lower than 50 cms (20 ins) or higher than 85 cms (34 ins) from floor level (fig. 4).

The water should be able to drain freely and the end of the outlet hose must not be under water. It is, therefore, advisable that the drain pipe, if used, has an internal diameter of at least 4 cms (1,5 ins).

Also, ensure that the drain hose is not chocked or placed in such a way as to obstruct the normal water flow. If the drain hose is to be hooked over the sink, ensure that the sink is empty and that the sink plug is not blocking the plug hole.

If an extension is required, its inner diameter must be the same as that of

the original hose of the washer and its length must not exceed 2 metres (6 ft).

## Plumbed installation

It is important that work is carried out by a qualified plumber.

## Use from existing taps

1. Mixer taps are unsuitable and must not be used.
2. Connect the red pipe connection to the hot tap and the other to the cold tap (see note below).

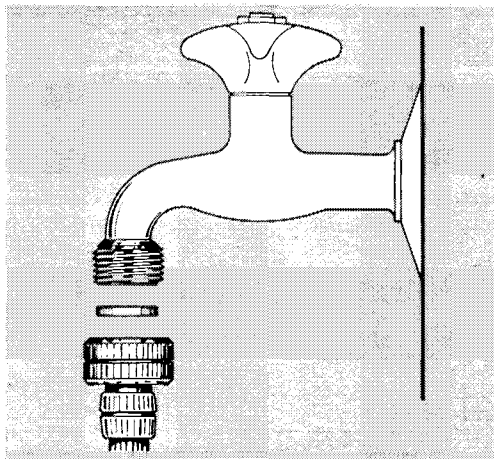

fig. 5

## Important

If the rate of flow on the cold water valve is too slow, remove the flow control device of the valve;

If the pressure on the hot tap exceeds approximately 10 lb. per square inch, it will be necessary to fit the flow control device, which is supplied with the washing machine, in the hot water valve.

## Tap connections

For taps with a 3/4 inch gas thread, fit the washers to the inlet hoses and connect as shown (fig. 5).

If the water supply is from new pipes or from pipes which have not been used for a long time, it is advisable to run off a certain amount of water before connecting the machine.

This will avoid foreign matter blocking the filters.

# Electrical connection

**WARNING:  
THIS APPLIANCE  
MUST BE EARTHED**

**The manufacturer declines to accept any liability should this safety measure not be observed.**

## Important

The wires in this mains lead are coloured in accordance with the following code:

**GREEN AND YELLOW - EARTH  
BLUE - NEUTRAL  
BROWN - LIVE**

If you fit your own plug, the colours of the wires in the mains lead of your appliance may not correspond with the markings identifying the terminals in your plug, this is what you have to do: Connect the green and yellow (earth) wire to the terminal in the plug which is marked with the letter «E» or the earth symbol  $\perp$  or coloured green, or green and yellow.

Connect the blue (neutral wire) to the terminal in the plug which is marked with the letter «N» or coloured black. Connect the brown (live) wire to the terminal which is marked with the letter «L» or coloured red.

If the plug is not suitable it must be cut off and the appropriate plug fitted. The cut off plug should be disposed of to prevent the hazard of electric shocks in case it should be plugged into a 13 Amp socket in another part of your home.



The plug moulded on to the cord incorporates a fuse. For replacement,

use a 13 Amp BS 1362 fuse. Only ASTA approved fuses should be used. The fuse cover/carrier must be replaced in the event of changing fuse. The right fuse/cover colour is the one shown by the coloured insert at the base of the socket.

The plug must not be used if the fuse cover/carrier is lost. A replacement cover/carrier must be obtained from Zanussi Service Agents whose addresses are listed on the attached «Zanussi Service Agents Nationwide».

**This appliance complies with E.E.C. directive n. 76/889 of 4.11.76 relative to radio interference suppression.**

# Operating instructions

1. Handle dispenser
2. Pilot lamp
3. Half load pushbutton «»
4. Spin pushbutton «500-1000»
5. Cold wash pushbutton «»
6. Program selector

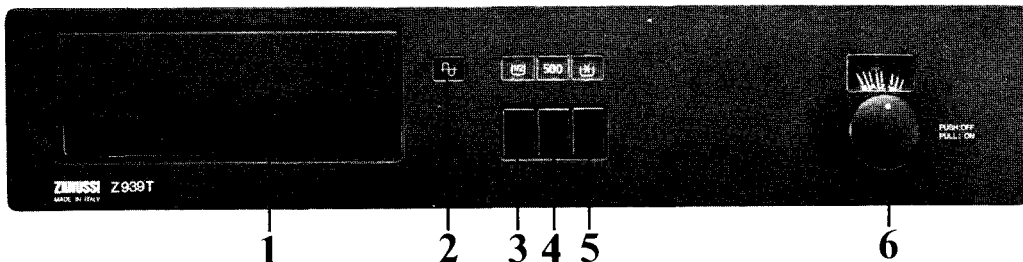

## Controls description

**Half-load pushbutton «»:** when pressed in, this pushbutton will provide only half of the normal water load in the tub. This makes it possible, when washing only a reduced load (not more than half of the normal dry load), to obtain a reduced water consumption and a considerable saving in electric power consumption. This pushbutton should not be pressed in when washing synthetics or woollens.

**Spin pushbutton «500-1000»:** if pressed in at the beginning of an **energetic** wash cycle, this pushbutton provides the final spin at 1000 r.p.m. instead of 500 r.p.m.

**Cold wash pushbutton :** by pressing in this pushbutton prior to selecting a wash cycle, the program will be carried out with cold water only. A cold water program is particularly suitable to wash very delicate synthetic fabrics, curtains & draperies and other lightly soiled fabrics.

**Program selector:** this permits selection of the required wash cycle by turning the knob clockwise until the letter corresponding to the desired program coincides exactly with the pointer. Furthermore, by pulling it or pushing it, it lets you start or stop the machine.



## Loading the clothes

For model Z949T only: to open the front door push it on the right side. Open the door of the machine by pulling the small double-action catch (fig. 6) to the left first and then outwards. Load the clothes spreading them out evenly and then close the door again.

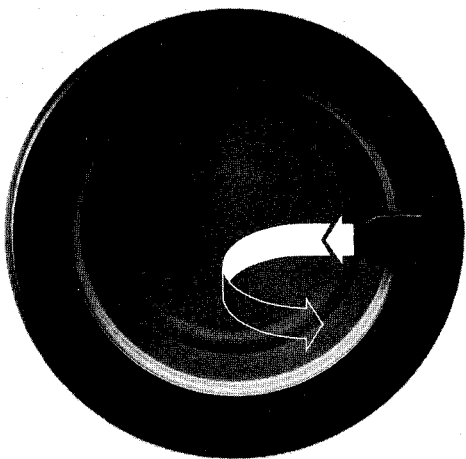

fig. 6

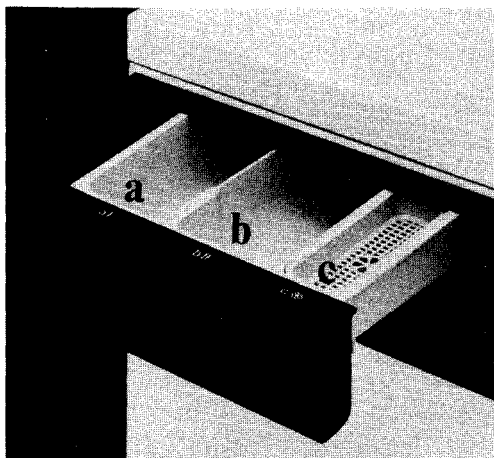

fig. 7

## Filling with washing powder

The washing powder dispenser is located on the front left of the control panel. It is very important to use a low sudsing powder (see paragraph «Which powder») such as Persil Automatic. Pull out the dispenser and add washing powder. The amount of washing powder for the prewash should be put into section «a» (fig. 7) of the dispenser and the powder for the main wash should be put into section «b». Once the dispenser is filled, close by pushing in.

## Use of additives

The washing machine is designed to carry out special treatments such as the addition of fabric conditioners automatically at the end of some washing programmes.

The conditioner liquids to be used should be put into compartment «C» (fig. 7) of the dispenser at the beginning of the programme. These additives will be automatically used by the machine at the appropriate time. Take care to use the correct amount of additive, following the manufacturer's instructions.

## Which powder?

### Do not use ordinary powders

like Ariel, Radiant, Daz etc. in your new washing machine. The reason for this is very simple, these powders produce so much lather that clothes are prevented from tumbling freely and cannot get properly clean.

**Do use the right powder.** To get the best results, we recommend **Persil Automatic**.

Like all modern automatic machines the Z939T/Z949T work at peak efficiency with a low lather product.

**This product's** balanced lather is specially designed to complement the cleaning action of these machines. So use it regularly for trouble free washing and superb results.

**Do use enough powder.** To get your clothes really clean it is essential that enough powder is used in the machine. The correct amount will depend on a number of things: the hardness of water, the size of the load, and the amount of soiling present. As a guide we suggest you follow the table above and adjust the amounts in light of your personal experience.

You may find it helps to use a measuring cup at first.

## Selection of washing programme

The washing machine carries out 12 washing programmes and 7 additional programmes. Each programme has been specially designed for a specific type of fabric (e.g. cotton, synthetic fibres, wool etc.) and incorporates the H.L.C.C. care labelling scheme.

The appropriate programme must therefore be chosen according to the type of fabric to be washed. Programme description is to be found on the inner side of the detergent dispenser flap cover.

The amount of powder in grams at full load			
Hardness of water in degrees French (°F)	Prewash	Wash when preceded by prewash	Main wash
Soft: up to 12	20	85	95
Average: 12÷25	60	135	160
Hard: 25÷37	90	185	230
Very hard: 37 besides	125	235	270

For hardness in ppm multiply indicated hardness value by 10.





For information regarding the degree of hardness in your area, enquire at competent local authority.

For reduced load or light soiling, reduce the quantities accordingly.

# Energetic wash cycle

For Cotton, Linen and Hemp Fabrics

Recommended wash load: 10 lbs (4,5 Kgs) max.









Wash cycle	Position of program selector	Dispenser compartments to be used for		Wash cycle description
		washing powder	fabric conditioner, if any	
Extra prewash	<b>A</b>	<b>a</b>		Prewash in water at 40°C (normal level) followed by a soaking phase (the laundry is left soaking in water). To drain the water, turn the program knob to cycle «V» (drain with a gentle spin) or «Z» (drain).
Whites-heavy soil	<b>B</b> 	<b>a-b</b>	<b>c</b>	Prewash in water at 40°C (normal level). Main wash in water at 90°C (normal level). 4 cold water rinses (high level). Spinning.
Whites	<b>C</b> 	<b>b</b>	<b>c</b>	Main wash in water at 90°C (normal level). 4 cold water rinses (high level). Spinning.
Fast coloureds heavy soil	<b>D</b> 	<b>a-b</b>	<b>c</b>	Prewash in water at 40°C (normal level). Main wash in water at 60°C (normal level). 4 cold water rinses (high level). Spinning.
Fast coloureds	<b>F</b> 	<b>b</b>	<b>c</b>	Main wash in water at 60°C (normal level). 4 cold water rinses (high level). Spinning.
Non-fast coloureds	<b>G</b> 	<b>b</b>	<b>c</b>	Main wash in water at 40°C (normal level). 4 cold water rinses (high level). Spinning.
Rinses	<b>H</b>			4 cold water rinses (high level). Spinning.
Special treatments	<b>J</b>		<b>c</b>	Intake of water mixed with liquid additive (high level). Special treatments. Spinning.
Spin only	<b>K</b>			Spinning for about 6 minutes with simultaneous water draining. This is preceded by slow rotations of the drum.

# Gentle wash cycles

## For Delicates, Synthetics, Mixed Fabrics and Woollens

Recommended wash load: max. 3-5 lbs (1,5-2 Kgs); wool max. 2 lbs (1 Kg).

**Note:** There is no water draining in the last rinse of the gentle wash cycles, to prevent the clothes from creasing if they are left in the machine at the end of the wash cycle. To drain the water, turn the program selector knob to cycle «V» (draining & gentle spinning) or cycle «Z» (draining without spinning).

Wash cycle	Position of Wash cycle selector	Dispenser compartments to be used for		Wash cycle description
		washing powder	fabric conditioner, if any	
Poly cotton	<b>L</b> 	<b>b</b>	<b>c</b>	Main wash in water at 90°C (high level), 3 cold water rinses (high level). <i>not only</i>
Whites heavy soil	<b>M</b> 	<b>a-b</b>	<b>c</b>	Prewash in water at 40°C (normal level). Main wash in water at 60°C (high level). 3 cold water rinses (high level).
Whites	<b>N</b> 	<b>b</b>	<b>c</b>	Main wash in water at 60°C (high level). 3 cold water rinses (high level).
Minimum iron	<b>P</b> 	<b>b</b>	<b>c</b>	Main wash in water at 50°C (high level). 3 cold water rinses (high level).
Delicates	<b>Q</b> 	<b>b</b>	<b>c</b>	Main wash in water at 40°C (high level). 3 cold water rinses (high level).
Woollens 	<b>R</b> 	<b>b</b>	<b>c</b>	Main wash in water at 40°C (high level). 3 cold water rinses (high level).
Silks	<b>S</b> 	<b>b</b>	<b>c</b>	Main wash in water at 30°C (high level). 3 cold water rinses (high level).
Rinses	<b>T</b>			3 cold water rinses (high level).
Special treatments	<b>U</b>		<b>c</b>	Intake of water mixed with liquid additive (high level). Special treatments.
Short spin only	<b>V</b>			Water draining followed by a short spin.
Drain	<b>Z</b>			Water draining with a steady drum.

## Starting

After loading the clothes, the washing powder and the fabric conditioners into the respective compartments, make sure — before you start the machine — that:

the plug is in the wall socket;  
the water tap is turned on (fully open);  
the drain hose is correctly placed;  
the loading door is correctly closed.

You may now select the required wash cycle by turning the program control knob clockwise after making sure that it is pressed in.

Press in the required pushbutton, if any. At this point, to start the washing machine simply pull the program control knob (and the pilot lamp lights up). To ensure a correct program selection, the knob can only be pulled out when the reference index is accurately positioned on the starting point of a given wash cycle.

Once it is started, the machine will automatically carry out all phases of the selected program.

## Stopping

When the program is completed (pilot lamp goes out), the machine stops automatically.

You should now press in the program control knob and wait for about 1÷2 minutes after the wash cycle is completed before you open the door, so as to allow the door safety device (interlock) to release it.

Open the door only after the wash cycle is completed. In the case of the «gentle wash cycles», don't forget to drain the water prior to opening the door.

If need be, you may stop the machine at any given moment during the cycle by pushing in the program control knob.

To restart the appliance remember that the program control knob can only be pulled out when the reference index is positioned exactly on the starting point of a given wash cycle.

When the wash cycle is completed, it is advisable to unplug the machine from the wall socket and to turn off the water tap.

# Care and cleaning

## Cleaning the machine

**Important:** Make sure that the plug has been removed from the socket prior to undertaking any kind of maintenance.

From time to time, carry out a complete cycle without a washing load, adding 1 oz of «Calgon».

This should also be done when the washer has been out of use for a long time.

Leave the door ajar for about 2 hours after the wash to allow air to circulate freely inside the machine.

Plated, polished and plastic parts and the glass door should be cleaned with a soft damp cloth, never with an abrasive cleaning powder.

For the cabinet exterior use a lukewarm solution of mild soap, then rinse and dry carefully.

It is also advisable to clean the cabinet, from time to time, with a wax polish applied with a soft cloth.

## Cleaning the drain filter

This machine incorporates a mechanical filter (located in the front side of the cabinet) the purpose of which is to collect lint and any small object inadvertently left in the articles to be washed.

If this filter is allowed to clog, it could make water draining difficult. It should therefore be cleaned regularly as follows:

Detach the drain hose from its hanger on the back of the appliance and place the free end of the hose at floor level into a basin to collect any excess water.

Remove the lower panel of the cabinet, by pulling it out from the bottom.

Then, using the special wrench that comes with the machine, unscrew and remove the filter (fig. 8-9).

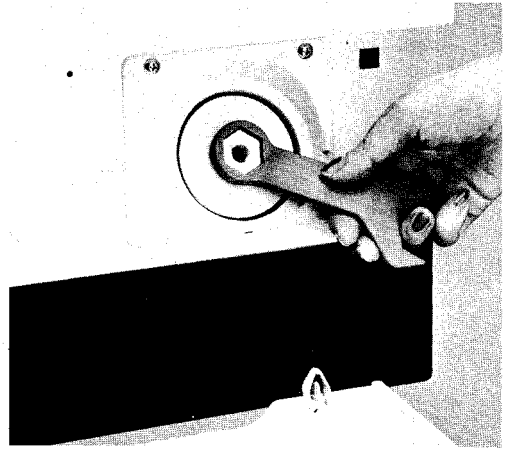

fig. 8

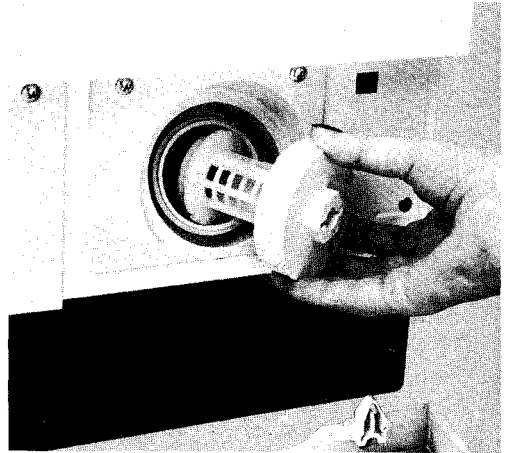

fig. 9

Clean the filter thoroughly and then replace it, making sure that it is screwed down firmly into its housing. When replacing the filter, be sure to fit it exactly into its special guide.

## **Hints for care of washing powder dispenser**

We recommend that the washing powder dispenser is checked regularly to ensure that it is clean and dry. Do wipe the dispenser after each wash. Should the dispenser require special cleaning, the drawer can be completely removed, and the interior cleared of any deposit. The drawer can be removed from the front of the appliance by giving a sharp pull outwards. A sharp tap with the palm of the hand may be necessary when replacing the drawer.

## **Helpfull tips for washing**

Here are some practical hints to enable you to obtain the best washing results:

Use a low suds washing powder specially made for front loading washing machines. An excessive formation of suds will cause unsatisfactory operation.

The quantity of washing powder required depends on the amount of laundry and on how soiled it is. It may therefore be necessary to vary the quantities suggested in this book according to experience. To obtain the best results when washing wool do not wash more than 2 lbs. at a time.

In order to get good results when washing synthetic material use a maximum washing load of 4 to 5 lbs. Cycle «R» is a special cycle for washing wool garments bearing the woolmark label «Pure New Wool washing shrink resistant».

If your water is hard it can be softened by adding special products such as

«Calgon» to the washing powder in the compartment B (fig. 8). These products facilitate the action of the washing powder and help to give better results.

Clothes should be sorted according to fabric type, degree of soil and colour fastness.

Tears and open seams should be mended, loose buttons secured, zippers closed and laces or belts collected in a cotton bag. Articles without a hem should not be washed. Ensure pockets are spots of rust, paint, ink etc., removed before washing.

Always turn off water taps fully when the machine is not in use, even if it is plumbed in.

If, after commencing a wash, you find that the wrong programme has been selected, push the control knob fully in turning the indicator knob clockwise to the correct programme. Then pull control knob fully out again.

Washing powder should only be placed in the dispenser immediately prior to the start of a programme. Do not leave washing powder in the dispenser for any length of time as it may form lumps which can be difficult to dissolve.

It is advisable to inspect the filters in the water inlet hoses periodically and clean if necessary.

# Servicing

Should servicing be required for this appliance contact your local Service Agent but before requesting service the following simple checks may save your inconvenience and expenses:

## **The machine won't start**

Check that:  
the plug is firmly in the wall socket and that there is an electricity supply by plugging in another appliance;  
the door of the machine is firmly closed;  
the program control knob is actually pulled out;  
make sure the fuses of your electrical installation have not blown.

## **The machine won't fill**

Check that:  
the water tap is actually turned on and that there is sufficient pressure;  
the fill hose is not sharply bent.

## **The machine fills, but the water empties from the drain hose**

Check that:  
the end of the drain hose is not placed too low from floor level.

## **The machine won't drain or spin**

Check that:  
the drain hose is not sharply bent (kinked) or placed in such a way as to obstruct a normal water flow;  
the drain filter is not clogged.

## **The machine vibrates or is too noisy**

Check that:  
the inner packing (transit security) was correctly removed as described in paragraph «Unpacking»;  
the machine is correctly levelled as described in the relevant paragraph the washer is not too close to a wall or to the furniture.



# Building-in instructions

## Instructions for door reversal (for model Z949T only)

The door of this washing machine is pre-arranged for door reversal, that is to say, for reversal of the opening direction.

To carry out this operation, proceed as follows:

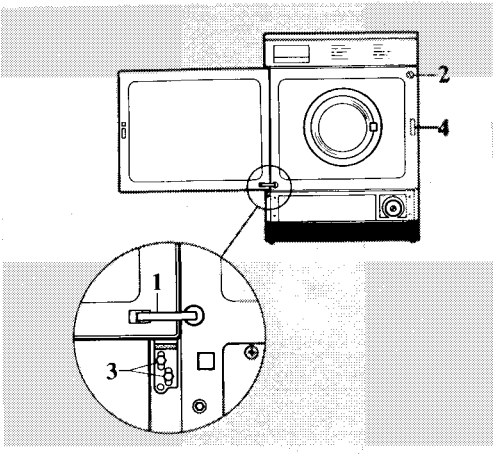

fig. 10

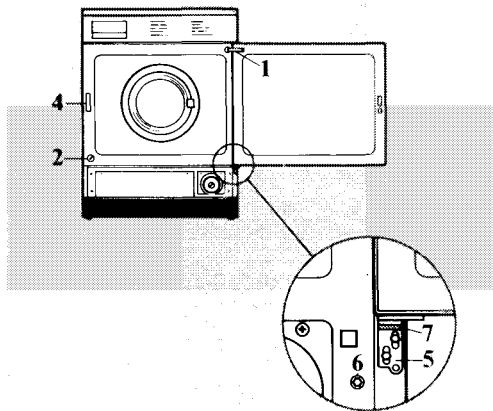

fig. 11

### a

Bend and disengage from the door the end of the closing catch (1 - Fig. 10), then rotate it 90° to remove it from its seating;

### b

Using a screwdriver, rotate the plastic cap (2 - Fig. 10) 90° and remove it;

### c

Fit the cap (2 - fig. 11) in the hole left free by the closing catch and rotate it 90° so as to lock it in position;

### d

Fit in and rotate 90° the closing catch (1 - Fig. 11) in the hole left free by the cap, making sure that the engaging tooth is facing towards the right side;

### e

Remove the machine's panel by pulling it outwards from underneath;

### f

Remove the door by unscrewing the two screws fastening the bottom hinge (3 - fig. 10).

Keep hinge for possible future use if it is required to return to original door opening direction;

## **g**

Take out part 4 - fig. 10.  
Refit the two fixing screws into the holes left free. Fix part 4 to the opposite side (fig. 11) using the two pre-fitted screws.

## **h**

Fasten the door on the opposite side by means of hinge (5 - fig. 11) provided as an attachment and using the two previously removed screws.

Check the door is aligned with the cabinet; to make this operation easy, it can be advisable to unloosen two turns the screw (6 - fig. 11) provided next to the hinge's fastening holes, then tighten the screw again.

## **i**

Fit on the hinge's bottom portion (5 - fig. 11) the adhesive bearing (7 - fig. 11) provided as an attachment so as to avoid scratches on bottom panel;

## **l**

Fit into seating provided on door the flexible end of the door closing catch (1 - fig. 11).

## **Instructions for application of decorative paneling on door and on bottom panel (for model Z949T only)**

The door and the bottom panel of this washing machine are provided with appropriate frames which enable application of decorative panels (stainless steel sheet, plastic sheet, wood, etc.) so as to match washing machine's appearance with that of remaining kitchen furniture.

The overall dimensions of the decorative panels should be as follows:

For the door:

Width	600 mm.
Height	460 mm.
Max. Thickness	4 mm.

For bottom panel:

Width	600 mm.
Height	115 mm.
Max. Thickness	4 mm.

To apply them it is necessary to remove the door and the bottom panel (see door reversal instructions at points a, e, f).

Unscrew peripheral fastening screws and remove frames taking care to remove the two hinge-pin seatings before removing the door frames.

Fit the decorative panel and then reassemble all parts taking care to make frames adhere to decorative panels.

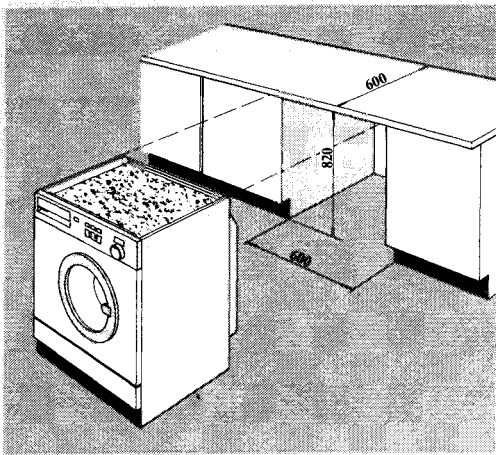

fig. 12

## Building-in instructions (fig. 12)

This washing machine can easily be built into kitchen units thanks to its standard dimensions:

Height 85 cms.

Width 60 cms.

Depth 60 cms.

If the appliance is to be fitted under a kitchen counter, into a recess having the dimensions shown in figure below, you should replace the washing machine work-top with a sheet metal panel which is supplied as an attachment on application.

Proceed as follows:

### a

Remove the original work-top from the appliance after unscrewing the screws securing it at the back, then push it slightly backwards and lift it off;

### b

Remove the two blocks fixing the work-top by unscrewing screws fastening them to the cabinet;

### c

Install the sheet metal panel and fasten it by means of the four screws that come with this panel;

### d

You may now fit the machine into the special recess, taking care that the fill and drain hoses are not bent or kinked in such a way as to obstruct the normal water flow.

---

# ZANUSSI GUARANTEE CONDITIONS

This guarantee is in addition to your statutory and other legal rights which will not be excluded or in any way diminished by the return of the enclosed card.

We, IAZ International (UK) Ltd, guarantee that if within twelve months of the date of the purchase, this ZANUSSI appliance or any part thereof is proved to be defective by reason only of faulty workmanship or materials we will at our option repair or replace the same **FREE OF ANY CHARGE** for labour, materials or carriage on condition that:

- The appliance has been correctly installed and used only on the electricity supply stated on rating plate.
- The appliance has been used for normal domestic purposes and in accordance with the manufacturer's operating and maintenance instructions.
- The appliance has not been serviced, maintained, repaired, taken apart or tampered with by any person not authorised by us.

- The appliance is still in the possession of the original purchaser.
- Any appliance or defective part replaced shall become our property.

This guarantee does not cover any damage caused during transportation or the replacement of any light bulbs or removable parts of glass or plastic.

Should you require service on your Zanussi appliance consult the enclosed list for your nearest Zanussi network centre. If the product is under first year guarantee then you will be required to produce proof of date of purchase to the engineer. If it is under 5 year cover then you must show your cover card to the engineer.

Please ensure that the enclosed pre-addressed card is stamped, completed in full and forwarded to IAZ International (UK) Ltd, to enable the guarantee to be recorded. Also complete the space below as your own record of the guarantee.

---

## GUARANTEE RECORD

Appliance purchased from \_\_\_\_\_ on \_\_\_\_\_  
Guarantee card no \_\_\_\_\_ Model no \_\_\_\_\_  
Serial no \_\_\_\_\_ (These details may be taken from your Guarantee Record Card)  
Your name \_\_\_\_\_  
Address \_\_\_\_\_

---

## Free Manuals Download Website

<http://myh66.com>

<http://usermanuals.us>

<http://www.somanuals.com>

<http://www.4manuals.cc>

<http://www.manual-lib.com>

<http://www.404manual.com>

<http://www.luxmanual.com>

<http://aubethermostatmanual.com>

Golf course search by state

<http://golfingnear.com>

Email search by domain

<http://emailbydomain.com>

Auto manuals search

<http://auto.somanuals.com>

TV manuals search

<http://tv.somanuals.com>