

ZANUSSI

 Electrolux

WASHER-DRYER ZWD 1260 W

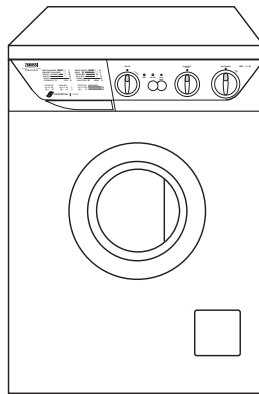



Important Safety Information

It is most important that this instruction book should be retained with the appliance for future reference. Should the appliance be sold or transferred to another owner, or should you move house and leave the appliance, always ensure that the book is supplied with the appliance in order that the new owner can get to know the functioning of the appliance and the relevant warnings.

These warnings have been provided in the interest of safety. You MUST read them carefully before installing or using the appliance.

Installation

- This appliance is heavy. Care should be taken when moving it.
- It is dangerous to alter the specifications or attempt to modify this product in any way.
- All packing and transit bolts must be removed before use. Serious damage can occur to the product and to property if this is not adhered to. See relevant section in instructions.
- Any plumbing work required to install this appliance should be carried out by a qualified plumber or competent person.
- Any electrical work required to install this appliance should be carried out by a qualified electrician or competent person.
- Care must be taken to ensure that the appliance does not stand on the electrical supply cable.
- If the machine is situated on a carpeted floor, please adjust the feet in order to allow air to circulate freely.

Child Safety

- This appliance is designed to be operated by adults. Children should not be allowed to tamper with the controls or play with the product.
- Pets and children have been known to climb into washer-dryers. Please check your drum before use.
- The glass door becomes very hot during the washing and drying cycle. Keep children away from the vicinity of the appliance whilst it is in operation.
- Keep all packaging well away from children.
- Keep all detergents in a safe place out of children's reach.





Use

- Always unplug the appliance and turn off the water supply after use.
- Do not overload the appliance. See relevant section in the instruction book.
- Only wash and dry fabrics which are designed to be machine washed and dried. If in doubt, consult the care label on the clothes.
- Before washing, ensure that all pockets are empty and buttons and zips are fastened. Avoid washing

frayed or torn articles and treat stains such as paint, ink, rust, and grass before washing. Underwired bras must NOT be machine washed.

- Any objects such as coins, safety pins, nails, screws, stones or any other hard, sharp material can cause extensive damage and must not be placed into the machine.
- Garments which have been in contact with volatile petroleum products should not be machine washed. If volatile cleaning fluids are used, care should be taken to ensure that the fluid is removed from the garment before placing in the machine.
- Wash small items such as socks, laces, washable belts etc in a washing bag or pillow case as it is possible for such items to slip down between the tub and the inner drum.
- Only use the advised quantities of fabric softener. Damage to the fabric can ensue if you over-fill. Refer to the manufacturer's recommendations of quantities.
- As some duvets and eiderdowns should be washed/dried in large commercial machines because of their bulk, please check with the manufacturer of the item before washing in a domestic machine.
- The users should always check that they have not left their gas lighters (disposable or otherwise) in their clothing.
- Never tumble dry items that have had contact with chemicals such as dry cleaning fluid. These are of a volatile nature and could cause an explosion. Only tumble dry items which have been washed in water or require airing.
- Plastic detergent dispensers should not remain in the drum during the drying cycle, as the plastic used is not designed to withstand the heat. If you wish to wash-through-to-dry you should use the conventional detergent dispenser drawer.
- Leave the porthole door slightly ajar between washes to preserve the door seal.
- Under no circumstances should you attempt to repair the machine yourself. Repairs carried out by inexperienced persons may cause injury or serious malfunctioning. Contact your local Service Force Centre. Always insist on genuine spare parts.

Contents

For the User			
Your New Washer-Dryer	4	Washing and Drying Hints	12
Important Safety Information	2	Which detergent to use?....	13
Description of the Appliance	5	And in which form?	13
Detergent dispenser drawer	5	Fabric Conditioners	13
The Control Panel	6	Wash Care Symbols	14
Operating Sequence	7-11	Washing Programmes	15-16
Washing 5 kg of white cotton at 95°C	7	Drying Programmes	17
Load the laundry	7	Maintenance and Cleaning	18-19
Measure out the detergent	7	Descaling	18
Measure out the fabric softener	7	After each wash	18
Select the spin speed or option  or 	7	Maintenance wash	18
Select the required programme	7	External cleaning	18
Start the machine	8	Cleaning the dispenser drawer	18
At the end of the programme	8	Cleaning the drawer recess	18
Washing 2.5 kg of mixed fabrics at 50°C	8	Cleaning the filter	18-19
Load the laundry	8	The dangers of freezing	19
Measure out the detergent	8	Something Not Working	20-21
Measure out the fabric softener	8	Service and Spare Parts	21
Select the spin speed or option  or 	9	Guarantee Conditions	22
Select the programme	9		
Start the machine	9	For the Installer	
At the end of the programme	9	Installation Instructions	23
Drying 2.5 kg of cotton	10	Technical Specifications	23
Load the laundry	10	Unpacking	24
Select the programme	10	Positioning	24
Select the required time	10	Water inlet	25
Start the machine	10	Water drainage	25-26
At the end of the programme	10	Levelling	26
Autodrying 1 kg of mixed fabrics	11	Special conditions	26
Load the laundry	11	In the interest of the environment	26
Add the washing powder and additive	11	Electrical connection	27
Select the programme	11		
Select the required time	11		
Start the machine	11		
At the end of the programme	11		

Guide to use the Instruction Book

The following symbols will be found in the text to guide you throughout the instructions:



Safety instructions



Hints and tips



Environmental information



Your New Washer-Dryer

Your new washer-dryer meets all modern requirements for effective treatment of laundry with low water, energy and detergent consumption.

It is gentle with your laundry, simple to use and easy to care for.

- **The special wool programme** with its new delicate wash system treats your woollens with extreme care.
- **The balance control** ensures that the machine remains stable when spinning.
- **Automatic cooling of the wash water to 60°C** before draining, with the 95°C programme. This reduces thermal shock to fabrics, helping to prevent creasing.
- **The two drying programmes** will give your wash that soft, relaxed feel whatever the weather.



Ecological hints

To save water and energy and help protect the environment, we recommend that you follow these hints:

- Adjust the quantity of detergent according to the hardness of your water supply, the amount of laundry and the degree of soiling.
- A programme without prewash is sufficient for normally soiled laundry.
- Try to load the maximum drying capacity of the machine as small loads are **uneconomical**.
- Always load well spun laundry. The higher the spin speed, the lower the electricity consumption and the shorter the drying times.



In the interest of the environment

- Materials marked with the symbol  are recyclable.
- Check with your local Council or Environmental Health Office to see if there are facilities in your area for re-cycling this appliance.
- When the appliance is to be scrapped, cut off the power supply cable and make the door lock device unusable to prevent young children from being trapped inside.
- Help to keep your country tidy - use authorised disposal sites for your old appliance.

**How do we help to protect the environment?
We use recycled paper!**

Important

Your machine is fitted with a balance control device, which ensures the machine is stable during the spin.



If the wash load appears not to have been spun sufficiently at the end of the wash cycle, because it is not evenly distributed in the drum, the balance control device may have operated. It will therefore be necessary to redistribute the wash load manually and select a spin programme. For more detailed information see the section headed "Something Not Working".

Description of the Appliance

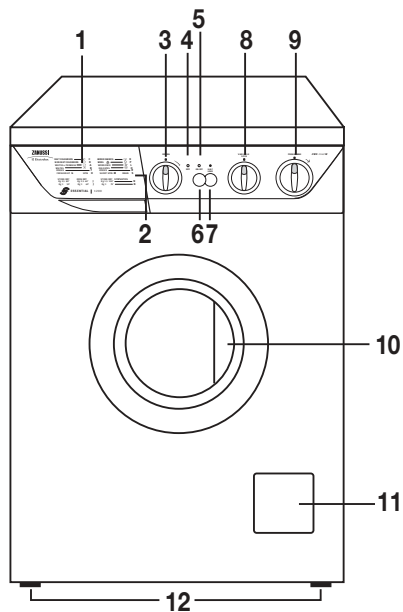
- 1 Detergent dispenser drawer
- 2 Programme guide
- 3 Drying time selector dial
- 4 Drying indicator light
- 5 "Mains-on" light
- 6 ON-OFF button
- 7 HALF LOAD button
- 8 Spin Speed selector dial
- 9 Programme selector dial
- 10 Door opening handle
- 11 Filter
- 12 Adjustable feet



Detergent dispenser drawer

-  Prewash
-  Main wash
-  Fabric softener

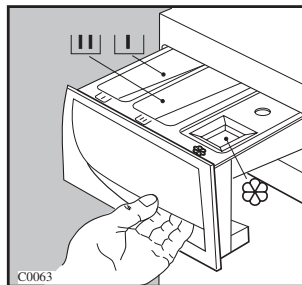

The Control Panel

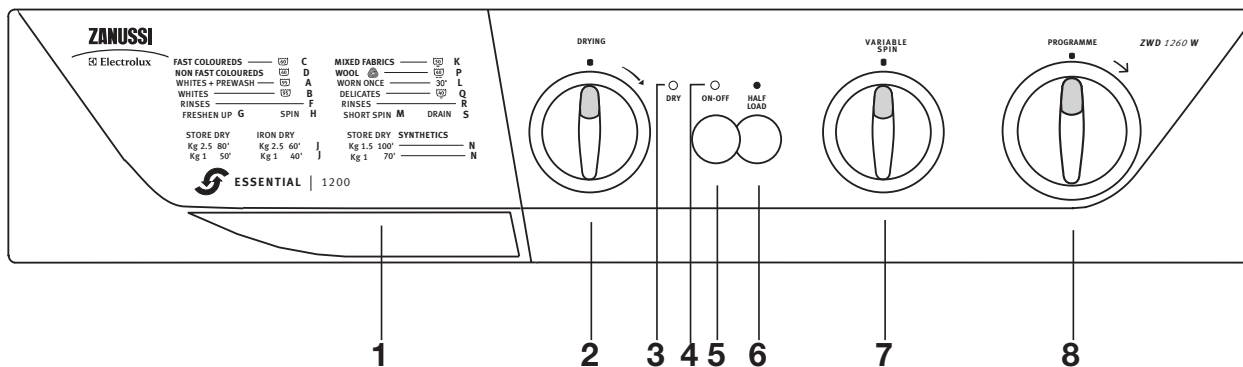

1 Programme guide

2 Drying time selector dial

Graduated up to 120 mins for cottons (light blue section) and synthetics (green section), this dial allows you to select the desired drying time according to the type and quantity of laundry and the required degree of dryness.

Turn the dial **clockwise** only.

Cooling phase

To allow the laundry to cool down, a cooling phase starts automatically 10 minutes before the end of drying and this phase must in no circumstances be reduced or interrupted.

3 Drying indicator light

This light illuminates when the machine is drying.

4 Mains-on light

This light illuminates when the machine starts working and goes out when the ON-OFF button is released.

5 ON-OFF button

By depressing this button the machine starts operating. When depressed again, the machine stops.

6 HALF LOAD button

Select this button to reduce water consumption on the rinse cycle when washing a smaller load of cottons or linens (maximum load size = 2.5 kg).

7 Spin speed selector dial

This dial allows you to select the desired spin speed or the following options:

- = no spin. All the spinning phases are excluded. To be used for items that tend to crease. If position is selected for cotton items (programmes 95°, 60° and 40°), the machine will perform an extra rinse (4 instead of 3).
- = Rinse Hold. The water of the last rinse is not emptied out to prevent any creasing in the clothes if they are left damp in the drum.

If you select the Rinse Hold option in an automatic washing & drying programme the machine will not dry.

We recommend you not to select a lower spin speed so as to avoid a too long drying time when carrying out the automatic washing & drying programme.

The spin speeds on the dial refer to **cotton programmes**. For **mixed fabrics and wool**, position 1200 corresponds to 850, for **delicates** 650 rpm.

Position 450 corresponds to 350 rpm for delicates.

8 Programme selector dial

Turn the dial **clockwise** to select the required wash and drying programme.

Before setting the dial to any position ensure that the machine is switched off.

i Operating Sequence

Before the first wash, we recommend that you run a cotton cycle at 60°C, without any laundry in the machine, to remove any manufacturing residue from the drum and tub.

Pour 1/2 a measure of detergent into the main wash compartment **III** of the dispenser drawer and start the machine.

WASHING 5 KG OF WHITE COTTON AT 95°C

Suppose you have 5 kg of normally soiled laundry to wash. It is white cotton and is suitable for high temperature washing.

1. Load the laundry

Open the door by pulling the door handle outwards. Place the laundry in the drum, one item at a time, shaking them out as much as possible. Close the door.

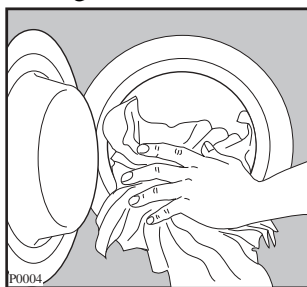

2. Measure out the detergent

Pull out the dispenser drawer until it stops. Measure out the amount of detergent required and pour it into the main wash compartment **III**. If you wish to carry out the prewash, pour detergent into the compartment marked **I**.

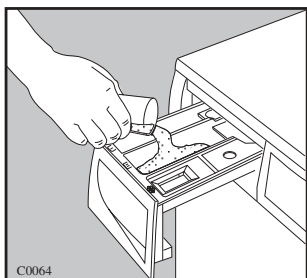

3. Measure out the fabric softener

If required, pour fabric softener into the compartment marked **⊗** (the amount used must not exceed the "MAX" mark in the drawer).

Close the drawer gently.

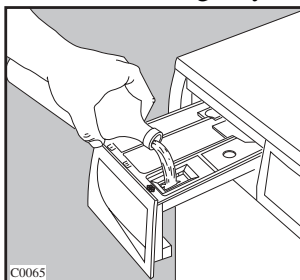

4. Select the spin speed or option **⊗** or **U**

Turn the dial to the required position.

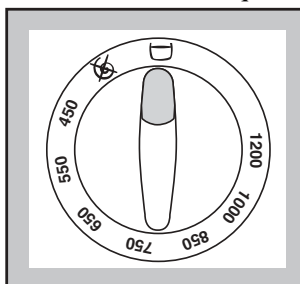

5. Select the required programme

Turn the programme selector dial **clockwise** to the programme **B** or **A** (if you wish to perform a prewash).

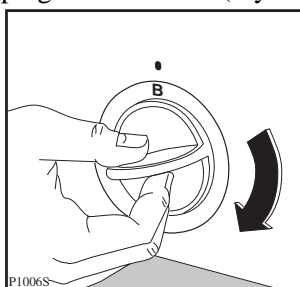

6. Start the machine

Before starting the machine check that:

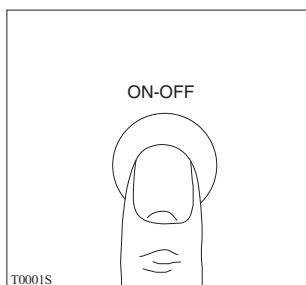

- the appliance is plugged in
- the water supply taps are turned on
- the drain hose is correctly and securely positioned
- the door and the detergent dispenser drawer are closed.

Depress the ON-OFF button: the mains-on light will illuminate and the machine starts operating.



7. At the end of the programme

The machine stops automatically.

If you have selected the RINSE HOLD option , the machine will stop with the water of the last rinse left in the tub, to prevent the fabric from creasing. To drain only, select position  or the drain programme "S".

To drain and spin, select programme "H" or turn the spin speed selector dial to the desired speed position: the machine will spin at the selected speed.

The door is controlled by a safety device which releases 2 minutes after the end of the programme.

Switch the machine off by depressing the ON-OFF button again. The mains-on light goes out.

When the programme has finished you are advised to unplug the appliance and turn off the water taps.

WASHING 2.5 KG OF MIXED FABRICS AT 50°C

Suppose you have 2.5 kg of Mixed fabrics to wash. They are rather delicate fabrics and should not be washed at a high temperature.

1. Load the laundry

Open the door by pulling the door handle outwards. Place the laundry in the drum, one item at a time, shaking them out as much as possible. Close the door.

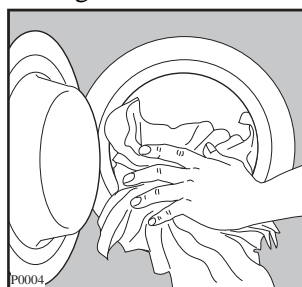

2. Measure out the detergent

Pull out the dispenser drawer until it stops. Measure out the amount of detergent required and pour it into the main wash compartment .

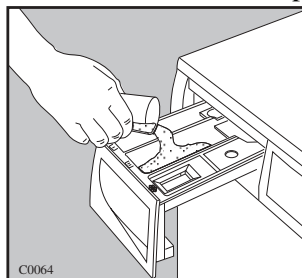

3. Measure out the fabric softener

If required, pour fabric softener into the compartment marked  (the amount used must not exceed the "MAX" mark in the drawer).

Close the drawer gently.

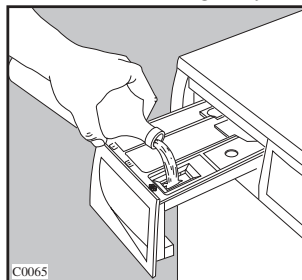

4. Select the spin speed or option



Turn the dial to the required position.

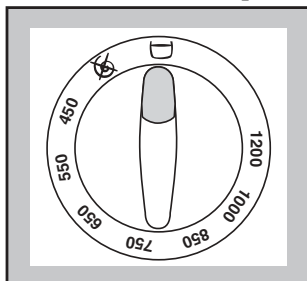

5. Select the programme

Turn the programme selector dial **clockwise** to the programme **K**.

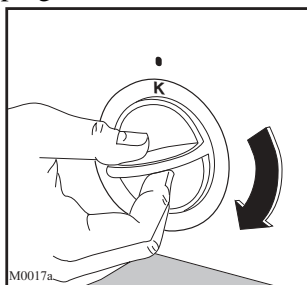

6. Start the machine

Before starting up the machine check that:

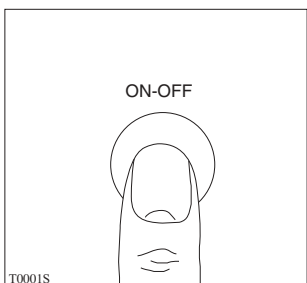

- the appliance is plugged in
- the water supply taps are turned on
- the drain hose is correctly and securely positioned
- the door and the detergent dispenser drawer are closed.

Depress the ON-OFF button: the mains-on light will illuminate and the machine starts operating.



7. At the end of the programme

The machine stops automatically.

If you have selected the RINSE HOLD option , the machine will stop with the water of the last rinse left in the tub, to prevent the fabric from creasing. To drain only, select position  or the drain programme “S”.

To drain and spin, select programme “M” or turn the spin speed selector dial to the desired speed position: the machine will spin at the selected speed.

The door is controlled by a safety device which releases 2 minutes after the end of the programme.

Switch the machine off by depressing the ON-OFF button again. The mains-on light goes out.

When the programme has finished you are advised to unplug the appliance and turn off the water taps.

DRYING 2.5 KG OF COTTON

You have for example just machine-washed and spun at 1000 rpm 5 kg of laundry.

They are cotton fabrics of medium weight which you want to iron as soon as they are dry.

Switch off the machine.

Then remove the laundry from the appliance and divide the items to obtain two loads of approx. 2.5 kg each.

1. Load the laundry

Open the door by pulling the handle outward.
Load the items one at a time and close the door.

2. Select the programme

Turn the programme selector dial clockwise to programme **J**.

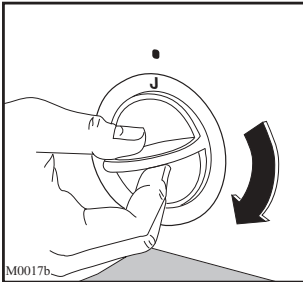

3. Select the required time

Following indications given in the programme chart on page 17, turn the time selector dial clockwise to the 60 mins setting (light blue section).

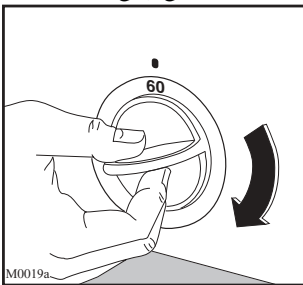

4. Start the machine

Depress the ON-OFF button, the mains-on light and drying light will illuminate and the machine starts operating.

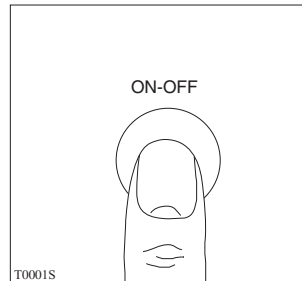

5. At the end of the programme

The machine stops automatically and the drying light goes out.

The door is controlled by a safety device which releases 2 minutes after the end of the programme.

Switch the machine off by depressing the ON-OFF button again, the mains-on light goes out.

If the laundry is still too damp, select a further brief drying time, bearing in mind that during the last 10 minutes the appliance carries out a cooling and anticrease phase.

When the programme has finished you are advised to unplug the appliance and turn off the water taps.

AUTODRYING 1 KG OF MIXED FABRICS

You intend to wash and dry automatically 1 kg of mixed fabrics which do not need ironing.

Proceed as follows:

1. Load the laundry.
2. Add the washing powder and fabric softener.

3. Select the programme

Turn the programme selector dial **clockwise** to programme **K**.

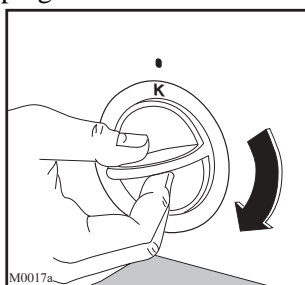

4. Select the required time

Following indications given in the programme chart on page 17, turn the time selector dial **clockwise** to the 60 mins setting (green section).

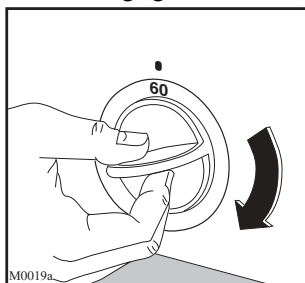

5. Start the machine

Depress the ON-OFF button: the mains-on light comes on and the machine starts operating.

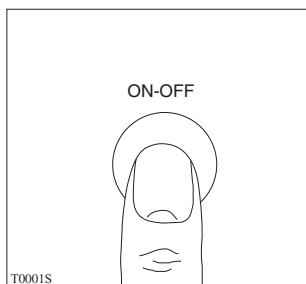

Note:

The drying light stays out until the laundry has spun. It illuminates when the drying cycle starts.

6. At the end of the programme

The machine stops automatically and the drying light goes out.

The door is controlled by a safety device which releases 2 minutes after the end of the programme.

Switch the machine off by depressing the ON-OFF button again, the mains-on light goes out.

If the laundry is still too damp, select a further brief drying time, bearing in mind that during the last 10 minutes the appliance carries out a cooling and anticrease phase.

When the programme has finished you are advised to unplug the appliance and turn off the water taps.

Washing and Drying Hints

Do **NOT** overload the machine. Weigh the laundry the first few times you use the appliance.

The average weights of the most common items are listed below as a guide:

1000g = 1 kg

Sheet	700-1000 g
Pillow case	100-200 g
Tablecloth	400-500 g
Serviette	50-100 g
Tea towel	70-120 g
Linen hand towel	100-150 g
Towelling hand towel	150-250 g
Towelling bath towel	700-1000 g
Bath robe	1000-1500 g
Man's shirt	200-300 g
Apron	150-200 g

- Load the laundry loosely alternating large items with small ones.
- Sort the laundry according to the type of fabric, colour-fastness and how dirty it is.
- Avoid washing unhemmed or torn items as they may unravel.
- Before washing, empty all pockets of small objects which may have been left inside (coins, keys, screws etc). as these could damage the drain pump.
- When washing curtains, remove the hooks.
- Close poppers and zips and fasten loose buttons.
- It is essential to wash new coloured items separately when washing for the first time.
- When washing fabrics requiring different wash temperatures together, always select the lowest temperature.
- White items should not be washed with coloured items.
- Very small items (handkerchiefs, ribbons, socks etc) should be washed in a washing bag or a pillow case.
- Use a good quality detergent suitable for automatic washing machines.
- Use the correct quantities of detergent.
- For wool, use gentle detergent only in small quantities.
- Bleach is very corrosive; it should be used with care and kept out of reach of children.

- Some stains such as fruit, wine, grass, rust etc. are difficult to remove and should be treated before washing with specific products, which can be found in most household shops. In some cases it may help to soak the stain before washing with a special pre-soak product or biological detergent.
- If you have used the machine to wash, rinse or spin only non-colour fast garments, there may be dye left in the sump. To ensure any subsequent wash is not contaminated with the dye, select and carry out a rinse and spin programme, without any garments, to ensure that any dye is removed from the sump.
- Do not leave the damp laundry load in a heap too long before drying.
- Avoid drying dark clothes with light coloured fluffy items such as towels as these can attract the fluff.
- If you overdry the laundry, besides wasting energy, any subsequent ironing may become more difficult because the fabric could be heavily crumpled.
- Remove the laundry when the appliance has finished drying.
- To avoid a static charge when drying is completed, use either a fabric softener when you are washing the laundry or a fabric conditioner specifically for tumble dryers.
- Particularly delicate items such as synthetic curtains, woollen and silk, garments with metal inserts, nylon stockings, bulky garments such as anoraks, bedcovers, quilts, sleeping bags and duvets must not be machine dried.
- Garments padded with foam-rubber or materials similar to foam-rubber must not be machine dried; they represent a fire hazard.
- Also, fabrics containing residues of setting lotions or hair sprays, nail solvents or similar solutions must not be machine dried in order to avoid the formation of harmful vapours.
- For drying, follow the indications given on the manufacturer's labels.

 Drying at high temperature

 Drying at reduced temperature

 Do not tumble dry

Important:

As a dryer, the machine works on the condensation principle.

Therefore, the water taps must be open and the drain hose must drain water into a sink or into the drain pipe, even during the drying cycle.

Which detergent?....

To ensure you obtain the best wash results from your appliance, it is important to use the right detergent in your everyday wash, and only detergents recommended for use in automatic machines.

To maintain the appearance of your clothes and household textiles and to make them last longer you should use different types of detergent for different washes, whether for whites, colours or delicates.

WHITES

We recommend the Ariel product range which is biological and designed to provide excellent cleaning and stain removal even at low temperatures.



NON BIOLOGICAL

If you prefer to use a non biological detergent, which does not contain enzymes we recommend Fairy. Fairy provides good cleaning and stain removal.



COLOURED

For coloured items you should use a detergent which is designed to clean while maintaining the original colour. Ariel Color does not contain bleach and therefore helps to preserve colours.



DELICATE ITEMS

When washing delicates such as woollens, you should use a product which is specially designed to care for fine fabrics.

Dreft Automatic is suitable for woollens and other delicates.



LAUNDRY BLEACH

For additional stain removal you may wish to use a product such as Ace Gentle Bleach which is used in addition to your chosen detergent. Ace is suitable for all washable fabrics including silks, woollens and coloureds.



And in which form?

Not only are there different types of detergent, but they are also available in different forms. Whether you chose a powder or liquid in traditional or compact form is your own personal choice.

TRADITIONAL POWDERS

Pour the powder directly into the dispenser drawer. Do not sprinkle powder onto clothes in the machine drum.

TRADITIONAL LIQUIDS

Liquid can be placed in the main wash compartment of the detergent drawer marked with the symbol , start the machine immediately upon placing the detergent in the dispenser drawer.

Alternatively the detergent is measured into the specially designed dosing device* which should be placed on top of the laundry, and at the back of the machine drum.

COMPACT POWDERS AND LIQUIDS

Compact detergents (or concentrates as they are also known) are available in liquid or powder form, and generally require a smaller dosage. Follow the manufacturer's instructions to ensure the most economical usage. Pour the detergent directly into the dispenser drawer, or alternatively measure the detergent into the specially designed dosing device* which should be placed on top of the laundry, and at the back of the machine drum.

* **If you use a dosing device in a washer dryer, please ensure the dosing device/ball is removed before carrying out a drying programme.**

FABRIC CONDITIONERS

These are ideal for improving 'softness', and also reduce static cling on synthetics and make ironing easier. They are available in two types:

For example Lenor liquid fabric softener, for use in the **washing machine/washer dryer**. The liquid fabric softener should be poured into the compartment marked with the symbol . Follow the manufacturer's dosage instructions and never exceed the MAX level.



















Bounce conditioning sheets for use in a **tumble dryer**. We recommend the conditioning sheets are pinned (using a safety pin) to an article of laundry and placed in the tumble dryer.



Wash Care Symbols

Wash care labels inside garments recommend how to launder your clothes with the best results. The care labelling code is in line with care labelling used in the rest of Europe. The symbols used make it easy to select the correct programme on your washing machine.

WASHING SYMBOL	WASH ACTION	FABRIC
	Normal (Maximum)	White Cotton or Linen without Special Finishes
	Normal (Maximum)	Cotton, Linen or Viscose without Special Finishes Colourfast at 60°C.
	Reduced (Medium)	Nylon, Polyester/Cotton, Viscose with Special Finishes, Cotton/Acrylic Mix.
	Normal (Maximum)	Cotton, Linen or Viscose Colourfast at 40°C but not 60°C.
	Reduced (Medium)	Acrylics, Acetate, Triacetate, Wool mixes, Polyester/wool blends.
	Much Reduced (Minimum)	Wool, wool mixtures, Silks
	Hand wash only	Do not machine wash
BLEACHING		
	Chlorine bleach may be used	
IRONING		
	Hot iron	Cotton, Linen, Viscose
	Warm iron	Polyester mixtures, Wool
	Cool iron	Acrylic, Nylon, Polyester
DRY CLEANING		
	May be dry cleaned. Other letters and/or a bar beneath the circle will indicate the required process to the dry cleaner.	
TUMBLE DRYING		
	with high heat setting	
	with low heat setting	
	May be tumble dried	
	A cross through any symbol means «DO NOT»	

















Important Notes

For best results, always use the dispenser drawer for dispensing detergents and liquid additives. Once the dispenser has been filled, close it by pushing it in gently. This is particularly important if you are using

fabric conditioner to avoid the conditioner entering the machine prematurely. When using liquid detergent and a prewash programme, place the detergent into the correct compartment in the dispenser drawer, after the prewash has finished.

Washing Programmes

Programmes for cotton and linen

Wash programme/ Washing symbol	Degree of soil and type of laundry	Programme dial position	Description	Possible options	Max. load
 WHITES + PREWASH	For heavy soiled cotton items.	A	Prewash at 40 °C Wash at 95°C 3 rinses Long spin	HALF LOAD VARIABLE SPIN RINSE HOLD  NO SPIN 	5 kg
 WHITES	White cotton, for example normally soiled work garments, sheets, household linen, underwear, towels.	B	Wash at 95 °C 3 rinses Long spin	HALF LOAD VARIABLE SPIN RINSE HOLD  NO SPIN 	5 kg
 FAST COLOUREDS	Fast coloured cotton or linen fabrics, shirts, underwear, towels.	C(*)	Wash at 60 °C 3 rinses Long spin	HALF LOAD VARIABLE SPIN RINSE HOLD  NO SPIN 	5 kg
 NON- FAST COLOUREDS	Non fast coloured cotton or linen fabrics, shirts, blouses, underwear.	D	Wash at 40 °C 3 rinses Long spin	HALF LOAD VARIABLE SPIN RINSE HOLD  NO SPIN 	5 kg
RINSES	Separate rinse cycle for hand washed cotton and linen items	F	4 rinses Long spin	VARIABLE SPIN RINSE HOLD  NO SPIN 	5 kg
FRESHEN UP	For softening hand washed items	G	1 rinse Long spin	VARIABLE SPIN RINSE HOLD  NO SPIN 	5 kg
SPIN	Separate spin for cotton and linen items	H	Long spin	VARIABLE SPIN	5 kg

(*) This programme at 60°C with cold water filling is the reference programme for the Energy label according to EEC Directive 92/75.

















Water filling: 30°-40° programmes: **cold** water filling
50°-60° programmes: **hot** and **cold** filling
95° programmes: **hot** water filling

Important!

- Some programmes when selected may start with a short drain. This is quite normal and not a fault with the appliance. When a programme is selected, the selector dial will advance to the water filling position. E.g. Programme B is selected, there is a short drain. The appliance takes in water and the selector will appear to move to the C position. The appliance will have memorised the programme selected, in this case B, and will run the correct programme even though the selector dial appears to be at position C.
- We recommend that you do not switch the appliance off and on during its operation. This would modify the memorised programme in progress with unsatisfactory washing results.

Washing Programmes

Programmes for synthetics, mixed fabrics, delicates and wool

Wash programme/ Washing symbol	Degree of soil and type of laundry	Programme dial position	Description	Possible options	Max. load
 MIXED FABRICS	Synthetic or mixed fabrics, underwear, coloured garments, non-shrink shirts, blouses.	K	Wash at 50 °C 3 rinses Short spin	VARIABLE SPIN RINSE HOLD  NO SPIN 	2.5 kg
 WORN ONCE	Lightly soiled synthetic or mixed fabrics	L	Wash at 30 °C 3 rinses Short spin	VARIABLE SPIN RINSE HOLD  NO SPIN 	2.5 kg
SHORT SPIN	Separate spin for delicate items	M	Draining of water and short spin	VARIABLE SPIN	2.5 kg
 WOOL 	Specially tested programme for wool garments bearing the "Pure new wool, non-shrink, machine washable" label.	P	Wash at 40 °C 3 rinses Short spin	VARIABLE SPIN RINSE HOLD  NO SPIN 	1 kg
 DELICATES	Delicate fabrics, for example curtains	Q	Wash at 40 °C 3 rinses Short spin	VARIABLE SPIN RINSE HOLD  NO SPIN 	2.5 kg
RINSES	This programme can be used for rinsing hand washed garments.	R	3 rinses, with fabric softener, if required Short spin	VARIABLE SPIN RINSE HOLD  NO SPIN 	2.5 kg
DRAIN	For emptying out the last rinse water in programmes with the Rinse Hold option  .	S	Draining of water		-

Important!

- Some programmes when selected may start with a short drain. This is quite normal and not a fault with the appliance.
When a programme is selected, the selector dial will advance to the water filling position.
- We recommend that you do not switch the appliance off and on during its operation. This would modify the memorised programme in progress with unsatisfactory washing results.
- The wool wash cycle of this machine has been approved by Woolmark for the washing of machine washable Woolmark products provided that the garments are washed according to the instructions on the garment label and those issued by the manufacturer of this washing machine. M9604.

Drying Programmes

Degree of drying	Type of fabric	Max. load	Spin speed	Drying time mins	
Store dry (*) Suitable for items to put away without ironing	Cotton and linen (towels, T-shirts, bathrobes)	2.5 kg	1000	Light blue section 80-90	
			1200	70-80	
	Programme J	1 kg	1000	50-60	
			1200	40-50	
	Synthetic and mixed fabrics (jumpers, blouses, underwear, household linen)	Programme N	1.5 kg	850	Green section 90-100
			1 kg	850	60-70
Iron dry Suitable for ironing	Cotton and linen (sheets, tablecloths, shirts, etc.)	2.5 kg	1000	Light blue section 60-70	
			1200	50-60	
	Programme J	1 kg	1000	40-50	
			1200	30-40	

(*) The STORE DRY drying programme for cotton is the reference programme for the Energy Label data, in compliance with EC directive 92/75.

Maintenance and Cleaning

Before any maintenance or cleaning is carried out you must **DISCONNECT** the appliance from the electricity supply.

Descaling

The water we use normally contains lime. It is a good idea to periodically use a water softening powder in the machine. Do this separately from any laundry washing, and according to the softening powder manufacturer's instructions. This will help to prevent the formation of lime deposits.

After each wash

Leave the door open for a while. This helps to prevent mould and stagnant smells forming inside the appliance. Keeping the door open after a wash will also help to preserve the door seal.

Maintenance Wash

With the use of low temperature washes it is possible to get a build up of residues inside the drum. We recommend that a maintenance wash be performed on a regular basis.

To run a maintenance wash:

- The drum should be empty of laundry.
- Select the hottest cotton wash programme.
- Use a normal measure of detergent, must be a powder (such as Ariel Futur).

External cleaning

Clean the exterior cabinet of the appliance with soap and water only, and then dry thoroughly.

Cleaning the dispenser drawer

The washing powder and additive dispenser drawer should be cleaned regularly. Remove the drawer by pressing the catch downwards and by pulling it out. Flush it out under a tap, to remove any traces of accumulated powder. To aid cleaning, the top part of the additive compartment should be removed.

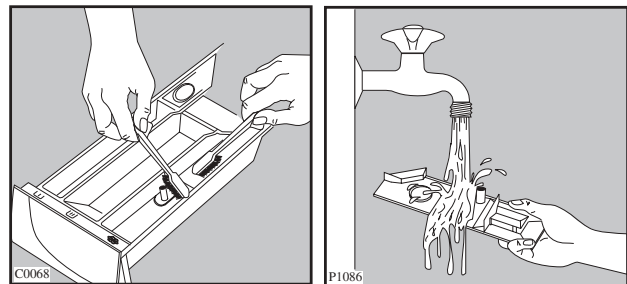
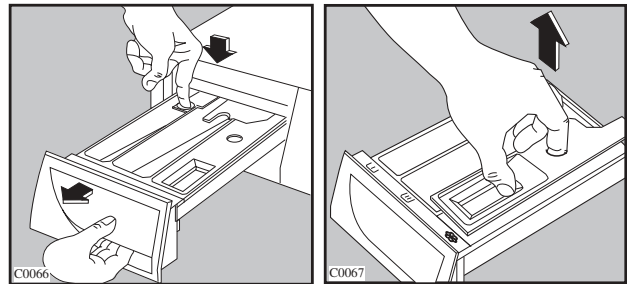

Cleaning the drawer recess

Having removed the drawer, use a small brush to clean the recess, ensuring that all washing powder residue is removed from the upper and lower part of the recess. Replace the drawer and run the rinse programme without any clothes in the drum.

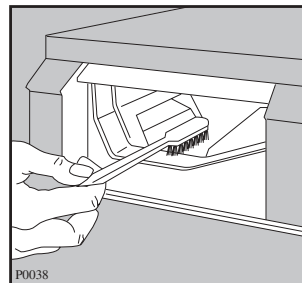

Cleaning the filter

The water drain filter

A clean filter is important for the correct operating of the machine, and should therefore be cleaned after every washing programme.

Open the filter door and place a container underneath to catch any spillage.

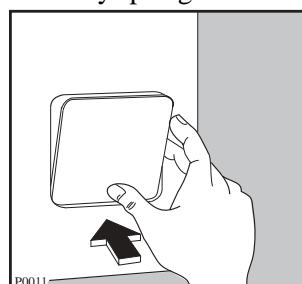

If the filter is blocked and the machine is unable to drain you will need to drain the water manually from the machine at this stage. To do this, unhook the drain hose from the standpipe or sink and hold the end of the hose over a bowl on the floor. The water should drain by gravity into the bowl. When the bowl is full, hook the hose back up and empty the bowl. Repeat the procedure until water stops flowing out.

Unscrew and remove the filter.

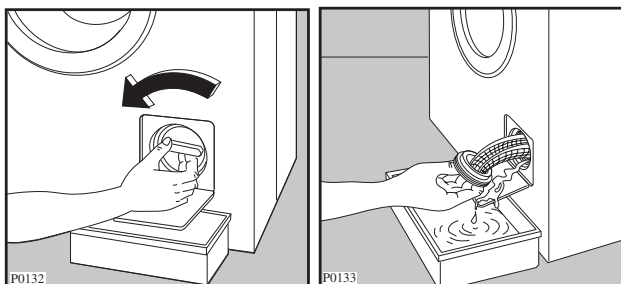

Clean carefully under a fast running tap.

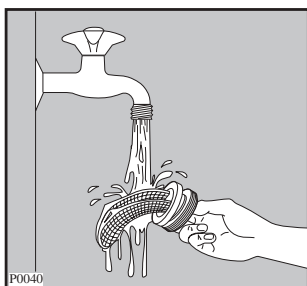

Clean the filters using a hard bristle brush. Tighten up the inlet hoses.

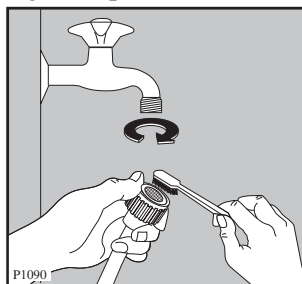

The dangers of freezing

If the machine is exposed to temperatures below 0°C, certain precautions should be taken.

- Turn off the water taps.
- Unscrew the inlet hoses.
- Unhook the drain hose from the rear support and position the end of this hose and that of the inlet hoses in a bowl. Run the draining programme.
- Disconnect the appliance.
- Screw the inlet hoses and reposition the drain hose.
- When you intend to start the machine again, make sure that the room temperature is above 0°C.

Warning

When the appliance is in use and depending on the programme selected there can be hot water in the filter. Never remove the filter during a wash cycle, always wait until the appliance has finished the cycle, and is empty. When replacing the filter, ensure it is securely retightened so as to stop leaks and young children being able to remove it.

The water inlet filters

If your water is very hard or contains traces of lime deposit, the water inlet filters may become clogged.



It is therefore a good idea to clean them from time to time.

Turn off the water taps. Unscrew the water inlet hoses.

Something Not Working

Certain problems are due to lack of simple maintenance or oversights, which can be solved easily without calling out an engineer. Before contacting your local Service Force Centre, please carry out the checks listed below.

IMPORTANT: if you call out an engineer to a fault listed below, or to repair a fault caused by incorrect use or installation, a charge will be made even if the appliance is under guarantee.

Symptom	Possible causes
The machine does not start	<ul style="list-style-type: none"> ● The door has not been closed. ● The plug is not properly inserted in the power socket. ● There is no supply at the socket ● The main fuse or the fuse in the plug has blown. ● The selector dial is not correctly positioned. ● The ON-OFF button has not been depressed.
The machine does not fill	<ul style="list-style-type: none"> ● Ensure the water taps are open. ● The filters in the inlet hoses are blocked. ● The inlet hoses may be squashed or kinked. ● The door has not been closed.
The machine fills then empties immediately	<ul style="list-style-type: none"> ● The end of the drain hose is too low. ● The end of the drain hose is submerged in water. ● There is no vent in the end of the drain hose.
The machine does not empty and/or does not spin	<ul style="list-style-type: none"> ● The drain hose may be squashed or kinked. ● The RINSE HOLD  or NO SPIN  option has been selected. ● The drain filter may be blocked. ● The drain hose extension, if fitted, is not correct. Follow the instructions for connecting to the waste. ● The drainage system pipes are blocked. ● The wash load is unbalanced: redistribute the clothes inside the drum to allow the machine to spin.
There is water on the floor	<ul style="list-style-type: none"> ● Too much detergent or unsuitable detergent has been used (creates too much foam). ● Check whether there are any leaks from one of the inlet hose(s) fittings. It is not always easy to see this as the water runs down the hose; check to see if it is damp. ● The drain hose may be damaged or not securely positioned. ● The detergent dispenser drawer or recess is clogged. ● The drainage system pipes are blocked.
Unsatisfactory washing results	<ul style="list-style-type: none"> ● Too little detergent or unsuitable detergent has been used. An insufficient amount of detergent leaves the laundry looking grey and causes lime scale to form. ● Stubborn stains have not been treated prior to washing ● The correct wash programme has not been selected. ● Too much laundry has been placed in the drum.
The machine vibrates when spinning	<ul style="list-style-type: none"> ● The internal packing has not been removed. ● The machine is in contact with the wall or furniture. ● The machine is not stable and level (check diagonally). ● The washing load is badly distributed in the drum. ● Maybe there is very little laundry in the drum.

Symptom	Possible causes
The door will not open	<ul style="list-style-type: none"> • The programme is still running. • The door lock has not yet released. • Water in the tub: the door cannot be opened if water is present in the tub.
Spinning starts late or the machine does not spin	<ul style="list-style-type: none"> • The electronic unbalance detection device has cut in because the laundry is not evenly distributed in the drum. The laundry is redistributed by reverse rotation of the drum. This may happen several times before the unbalance disappears and normal spinning can resume. If, after 20 minutes, the laundry is still not evenly distributed in the drum, the machine will not spin. In this case, redistribute the load manually and reselect the spin programme.
The machine makes an unusual noise	<ul style="list-style-type: none"> • The machine is fitted with a type of motor which makes an unusual noise compared with other traditional motors. This new motor ensures a softer start and more even distribution of the laundry in the drum when spinning, as well as increased stability of the machine.
No water is visible in the drum	<ul style="list-style-type: none"> • Machines based on modern technology operate very economically using very little water without affecting performance.
The machine does not dry or does not dry properly	<ul style="list-style-type: none"> • The drying time has not been selected • The water taps are not turned on • The drain filter is clogged • The machine is overloaded • The selected drying time/section is not suitable for the laundry or a lower spin speed has been selected.

Service & Spare Parts **SERVICE FORCE**

In the event of your appliance requiring service, or if you wish to purchase spare parts, please contact your local Service Force Centre by telephoning:

0870 5 929929

Your telephone call will be automatically routed to the Service Force Centre covering your post code area.

For the address of your local Service Force Centre and further information about Service Force, please visit the website at www.serviceforce.co.uk.

Before calling out an engineer, please ensure you have read the details under the heading "Something Not Working".

When you contact the Service Force Centre you will need to give the following details:

1. Your name, address and post code
2. Your telephone number
3. Clear and concise details of fault
4. The model and serial number of the appliance (found on the rating plate - see picture)
5. The purchase date.

Please note that a valid purchase receipt or guarantee documentation is required for in-guarantee service calls.

For Customer Care in the Republic of Ireland please contact us at the following address:

Zanussi-Electrolux
Electrolux Group (Ire) Ltd
Long Mile Road
Dublin 12

Republic of Ireland
Tel: +353 (0) 1 353 4090751
Email: service.eid@electrolux.ie

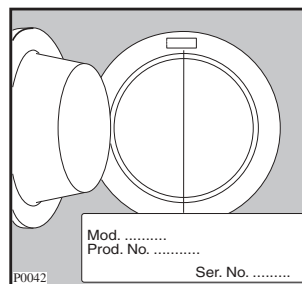

Customer Care

For general enquiries concerning your Zanussi Electrolux appliance or for further information on Zanussi Electrolux products, please contact our Customer Care Department by letter or telephone at the address below or visit our website at www.zanussi.co.uk

Customer Care Department
Zanussi Electrolux
55-77 High Street
Slough
Berkshire
SL1 1DZ
Tel 08705 727727*

* calls to this number may be recorded for training purposes.

Guarantee Conditions

Standard guarantee conditions

We, Zanussi Electrolux undertake that if, within 12 months of the date of the purchase, this Zanussi Electrolux appliance or any part thereof is proved to be defective by reason only of faulty workmanship or materials, we will, at our option, repair or replace the same **FREE OF ANY CHARGE** for labour, materials or carriage on condition that:

- The appliance has been correctly installed and used only on the electricity supply stated on the rating plate.
- The appliance has been used for normal domestic purposes only, and in accordance with the manufacturer's instructions.
- The appliance has not been serviced, maintained, repaired, taken apart or tampered with, by any person not authorised by us.

All service work under this guarantee must be undertaken by a Service Force Centre.

Any appliance or defective part replaced shall become the Company's property.

This guarantee is in addition to your statutory and other legal rights.

Home visits are made between **8.30am** and **5.30pm** Monday to Friday. Visits may be available outside these hours in which case a **premium** will be charged.

Exclusions

This guarantee does not cover:

- Damage or calls resulting from transportation, improper use or neglect, the replacement of any light bulbs or removable parts of glass or plastic.
- Costs incurred for calls to put right an appliance which is improperly installed or calls to appliances outside the United Kingdom.
- Appliances found to be in use within a commercial environment, plus those which are subject to rental agreements.
- Products of Zanussi Electrolux manufacture which are NOT marketed by Zanussi Electrolux.

European guarantee

If you should move to another country within Europe then your guarantee moves with you to your new home subject to the following qualifications:

- The guarantee starts from the date you first purchased your product.
- The guarantee is for the same period and to the same extent for labour and parts as exists in the new country of use for this brand or range of products.
- The guarantee relates to you and cannot be transferred to another user.
- Your new home is within the European Community (EC) or European Free Trade Area.
- The product is installed and used in accordance with our instructions and is only used domestically, i.e. a normal household.
- The product is installed taking into account regulations in your new country.

Before you move please contact your nearest Customer Care Centre, listed below, to give them details of your new home. They will then ensure that the local Service Organisation is aware of your move and able to look after you and your appliances.

France	Senlis	+33 (0)344 62 29 29
Germany	Nurnberg	+49 (0)800 234 7378
Italy	Pordenone	+39 (0)434 39 4700
Sweden	Stockholm	+46 (0)8 672 53 90
UK	Slough	+44 (0)1753 219897
Ireland	Dublin	+353 (0)1 4090751

Installation Instructions

- ⚠ It is dangerous to alter the specifications or attempt to modify this product in any way.
- ⚠ Care must be taken to ensure that the appliance does not stand on the electrical supply cable.
- ⚠ Any electrical work required to install this appliance should be carried out by a qualified electrician or competent person.
- ⚠ Any plumbing work required to install this appliance should be carried out by a qualified plumber or competent person.
- ⚠ Should the appliance power supply cable need to be replaced, this should be carried out by our Service Force Centre.

Technical Specifications

DIMENSIONS	Height Width Depth	85 cm 60 cm 58 cm
POWER SUPPLY VOLTAGE TOTAL POWER ABSORBED		230-240 V/50 Hz 2050 W (10A)
WATER PRESSURE	Minimum Maximum	50 kPa (0.5 bar) 800 kPa (8 bar)
LOAD CAPACITY	Washing Cotton, linen Synthetics Delicate fabrics Wool Drying Cotton, linen Synthetics	5 kg 2.5 kg 2.5 kg 1 kg 2.5 kg 1.5 kg
SPIN SPEED	Maximum	1200 rpm
CONSUMPTION DATA FOR WASHING 5 KG NORMALLY SOILED COTTON ITEMS AT 60°C WITH COLD WATER FILLING	Energy Water	1.10 kWh 63 litres 145 mins

- CE This appliance complies with the following E.E.C. Directives:
- 73/23 EEC of 19.2.73 (Low Voltage Directive) and subsequent modifications;
 - 89/336 EEC of 3.5.89 (Electromagnetic Compatibility Directive) and subsequent modifications.

Unpacking

! All transit bolts and packing must be removed before using the appliance.

You are advised to keep all the packaging for re-use in case the machine is to be transported again.

Using a spanner unscrew and remove the two rear bottom screws. Slide out the two plastic pins.

Lay the machine gently on its back, making sure that the hoses are not squashed.

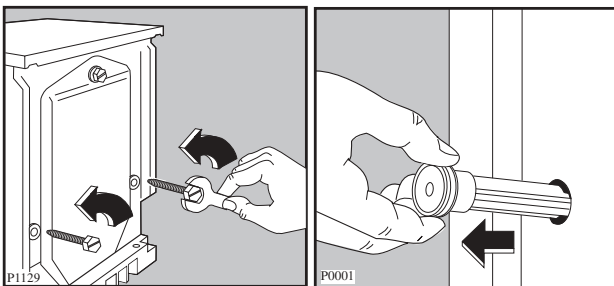

Remove the polystyrene block from the bottom of the machine and release the two plastic bags. Very carefully slide out the left polythene bag, removing it towards the right and then downwards.

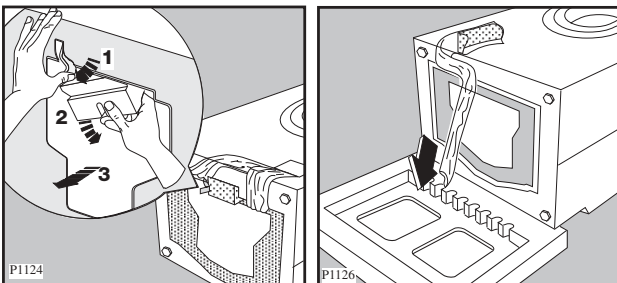

Repeat the operation for the right polythene bag, removing it towards the left and then upwards.

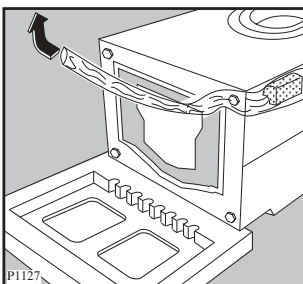

Remove the polystyrene base. Set the machine upright and unscrew the remaining rear screw. Slide out the relevant pin.

Fill all the holes with the plastic plugs supplied with the instruction booklet.

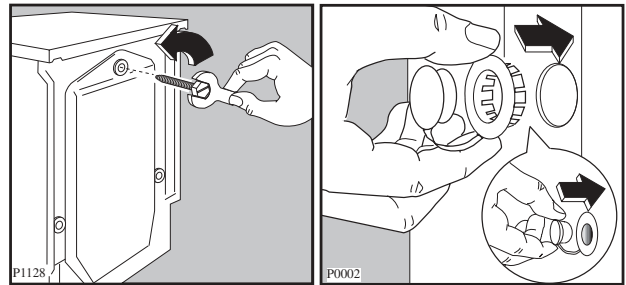

Important !

You are advised to keep all the packaging for re-use in case the machine is to be transported again. In case of moving out the same precautions as per paragraphe “The dangers of freezing” must be taken i.e. the residual water in the hoses must be pumped out.

Positioning

Install the machine on a flat hard floor. Make sure that air circulation around the machine is not impeded by carpets, rugs etc. Check that the machine does not touch the wall or other kitchen units. Never place cardboard, wood or similar materials under the machine to compensate for any unevenness in the floor.

Your new washing machine has been designed to be permanently plumbed in to your home's water supply and drainage system. However, if this is not possible, it may be connected to suitable existing taps with the drain hose discharging into a sink.

The appliance has two inlet hoses, hot and cold, with female 3/4" BSP thread connectors. If this connection is not compatible with the plumbing of the existing installation, a variety of connectors are available from good hardware stores and plumbers merchants to suit most domestic plumbing. Any alteration to your existing plumbing must be carried out by a competent person, or qualified plumber.

Installation on a Suspended Floor

Suspended wooden floors are particularly susceptible to vibration. To help prevent vibration we recommend you place a waterproof wood panel, at least 15 mm thick under the appliance, secured to at least 2 floor beams with screws. If possible install the appliance in one of the corners of the room, where the floor is more stable.

Water inlet

The inlets on the back of the appliance are colour coded, blue for cold and red for hot.

Connect the hose supplied with the machine to a tap with a 3/4" thread.

Do not use previously used hoses.

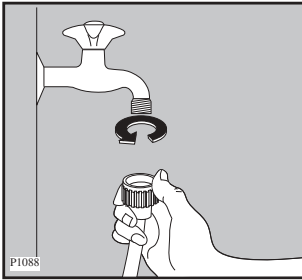

If only a cold water supply is available, connect the two hoses to a cold water outlet by means of a «Y» connection piece.

Installation should comply with local water authority and building regulations' requirements.

The appliance must be given a separate cold water supply and not be connected to a mixer tap, a single outlet water heater or a booster pump. A minimum water pressure of 50 kPa (0.48) bar is required for safe operation of the appliance.

If you cannot make the cold water connection direct from the rising mains, you may be able to operate the appliance from your cold water storage system.

There should be a minimum distance of 5.02m (16.5 ft) between the appliance's inlet and the bottom of the water storage tank.

There will be sufficient pressure for the hot water supply, providing there is a minimum height of 2.74 metres (9 ft) between the bottom of the cold water storage tank and the bottom of the hot water cylinder.

Set the hoses correctly by loosening the ring nuts. After positioning the inlet hoses, be sure to tighten the ring nuts again to prevent leaks.

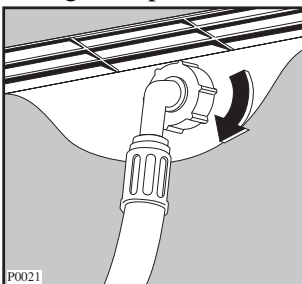

Water drainage

This appliance is designed to be permanently plumbed into your home's drainage system using one of the following methods.

1. Into a drainage standpipe.

Firstly form a hook in the end of the drain hose using the «U» piece" supplied.

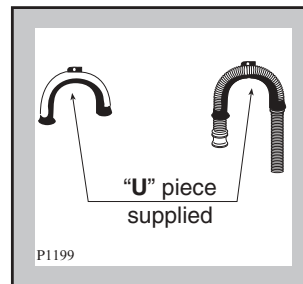

Place the drain hose into your standpipe, which should have an internal diameter of approximately 38mm thus ensuring there is an air break between the drain hose and standpipe.

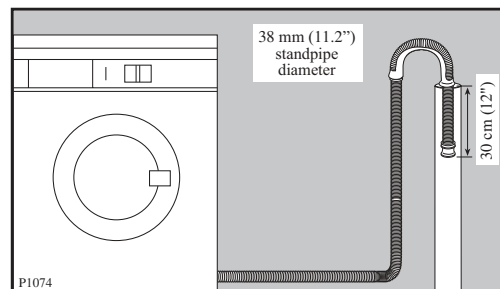

When discharging into a standpipe ensure that the top of the standpipe is no more than 90cm (35.4") and no less than 60cm (23.6") above floor level.

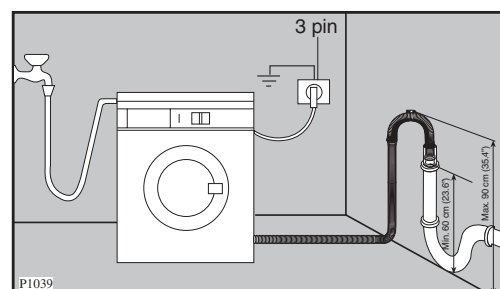

The drain hose may be extended to a maximum of 4 metres. An additional drain hose and joining piece is available from your local Service Force Centre. The joining piece must have an internal diameter of 18mm.

2. Onto a sink outlet spigot.

If the outlet spigot has not been used before, remove any blanking plug that may be in place.

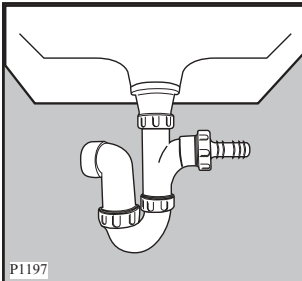

Push the drain hose onto the spigot and secure with a clip if required, ensure a loop is formed in the drain hose (see diagram) to prevent waste from the sink entering the washing machine.

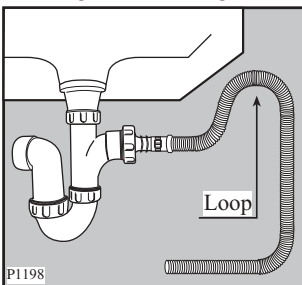

The drain hose may be extended to a maximum of 4 metres. An additional drain hose and joining piece is available from your local Service Force Centre. The joining piece must have an internal diameter of 18mm.

Important

Before connecting up the machine to new pipework or to pipework that has not been used for some time, run off a reasonable amount of water to flush out any debris that may have collected in the pipes.

Levelling

Level the washing machine by raising or lowering the feet. The feet may be tight to adjust as they incorporate a self locking nut, but the machine **MUST** be level and stable.

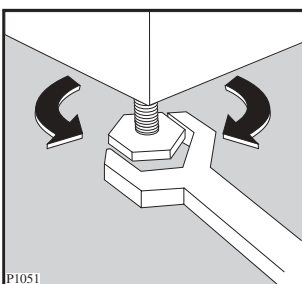

Any necessary adjustment can be made with a spanner. Accurate levelling prevents vibration, noise and displacement of the machine during operation.

Some vibration is inevitable, especially if mounted on a wooden floor. Sprung wooden floors are particularly susceptible to vibration. For advice, consult a builder. If possible, always place the machine on a solid floor.

Special conditions

If the floor is carpeted or covered with crumbly or soft material, insert a rigid support base under the feet to prevent noise, vibration or displacement. The base should protrude a few centimetres beyond the edges of the machine.

Warning

The machine should **NOT** be placed on deep pile carpeting.

Note

Please ensure that when the appliance is installed it is easily accessible for the engineer in the event of a breakdown.

In the interest of the environment

Washing machines and dishwashers should be connected to the FOUL drainage system, the water will then be taken to a sewage works for treatment before being discharged safely into a river.

It is essential that these appliances are not connected to the surface water drainage system as this water is discharged directly into a river or stream and may cause pollution.

If you require any further advice please contact your local water authority.

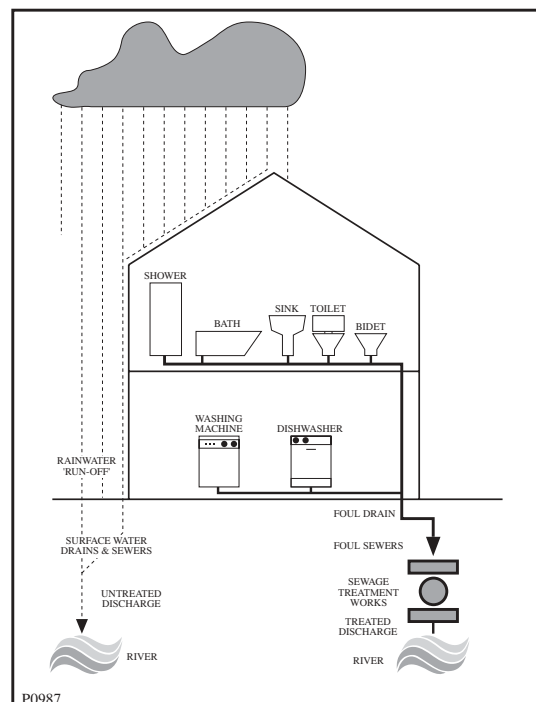

Electrical connection

Any electrical work required to install this appliance should be carried out by a qualified electrician or competent person.

! WARNING: THIS APPLIANCE MUST BE EARTHED.

The manufacturer declines any liability should this safety measure not be observed.

Before switching on, make sure the electricity supply voltage is the same as that indicated on the appliance's rating plate. The rating plate is located at the top of the rim of the open door.

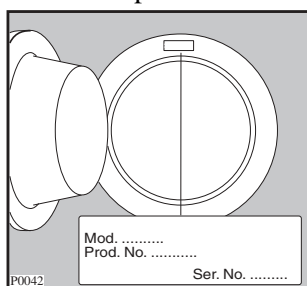

The appliance is supplied with a 13amp plug fitted. In the event of having to change the fuse in the plug supplied, a 13amp ASTA approved (BS1363A) fuse must be used.

Should the plug need to be replaced for any reason, proceed as described below.

The wires in the mains lead are coloured in accordance with the following code:

- | | |
|------------------|-----------|
| Green and Yellow | - Earth |
| Blue | - Neutral |
| Brown | - Live |

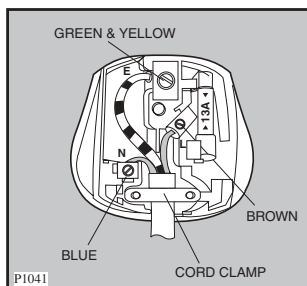

The wire coloured green and yellow must be connected to the terminal marked with the letter «E» or by the earth symbol \perp or coloured green and yellow.

The wire coloured blue must be connected to the terminal marked «N» or coloured black.

The wire coloured brown must be connected to the terminal marked «L» or coloured red.

Upon completion there must be no cut, or stray strands of wire present and the cord clamp must be secure over the outer sheath.

! WARNING:
A cut off plug inserted into a 13 amp socket is a serious safety (shock) hazard.
Ensure that the cut off plug is disposed of safely.

Should the appliance power supply cable need to be replaced, this should be carried out by our Service Force Centre.

Note

When the appliance is installed the power supply cable must be accessible.

Permanent connection

In the case of permanent connection it is necessary that you install a double pole switch between the appliance and the electricity supply (mains), with a minimum gap of 3mm between the switch contacts and of a type suitable for the required load in compliance with the current electrical regulations.

The switch must not break the yellow and green earth cable at any point.

 **From the Electrolux Group. The world's No. 1 choice.**

The Electrolux Group is the world's largest producer of powered appliances for kitchen, cleaning and outdoor use. More than 55 million Electrolux Group products (such as refrigerators, cookers, washing machines, vacuum cleaners, chain saws and lawn mowers) are sold each year to a value of approx. USD 14 billion in more than 150 countries around the world.

© Electrolux plc 2004

Free Manuals Download Website

<http://myh66.com>

<http://usermanuals.us>

<http://www.somanuals.com>

<http://www.4manuals.cc>

<http://www.manual-lib.com>

<http://www.404manual.com>

<http://www.luxmanual.com>

<http://aubethermostatmanual.com>

Golf course search by state

<http://golfingnear.com>

Email search by domain

<http://emailbydomain.com>

Auto manuals search

<http://auto.somanuals.com>

TV manuals search

<http://tv.somanuals.com>