

EN	User manual .....	2
CN	使用指南 .....	25

Washing machine

洗衣機

# USER MANUAL

ZWH7120 P

147214520

*la vita è bella*

**ZANUSSI**

ITALIAN SINCE 1916

## Contents

---

Safety information .....	2	Control panel.....	11
Environment concerns.....	4	Set your washing program.....	12
Product description.....	5	International wash code symbols.....	15
Technical data.....	5	Programs informations.....	16
Installation.....	6	Washing programs.....	17
First use.....	8	Care and cleaning.....	18
Daily use.....	8	Something not working.....	22

## Safety information

---



### Important!

- In the interest of your safety and to ensure the correct use, before installing and first using the appliance, read this user manual carefully, including its hints and warnings.
- To avoid unnecessary mistakes and accidents, it is important to ensure that all people using the appliance are thoroughly familiar with its operation and safety features.
- Save these instructions and make sure that they remain with the appliance if it is moved or sold, so that everyone using it through its life will be properly informed on appliance use and safety.

### General safety

- It is dangerous to alter the specifications or attempt to modify this product in anyway.
- During high temperature wash program the door glass may get hot. Do not touch it!
- Make sure that small pets do not climb into the drum. To avoid this, please check into the drum before using the appliance.
- Any objects such as coins, safety pins, nails, screws, stones or any other hard, sharp material can cause extensive damage and must not be placed into the machine.

- Only use the advised quantities of fabric softener and detergent. Damage to the fabric can ensue if you overfill. Refer to the manufacturer's recommendations of quantities.
- This appliance is not intended for use by persons (including children) with reduced physical, sensory or mental capabilities, or lack of experience and knowledge, unless they have been given supervision or instruction concerning use of the appliance by a person responsible for their safety.
- Wash small items such as socks, laces, washable belts etc in a washing bag or pillow case as it is possible for such items to slip down between the tub and the inner drum.
- Do not use your washing machine to wash articles with whalebones, material without hems or torn material.
- Always unplug the appliance and turn off the water supply after use and before cleaning or maintenance.
- Under no circumstances should you attempt to repair the machine yourself. Repairs carried out by inexperienced persons may cause injury or serious malfunctioning. Contact your local Service Centre. Always insist on genuine spare parts.

## Installation

- This appliance is heavy. Care should be taken when moving it.
- When unpacking the appliance, check that it is not damaged. If in doubt, do not use it and contact the Service Centre.
- All packing and transit bolts must be removed before use. Serious damage can occur to the product and to property if this is not adhered to. See relevant section in the user manual.
- After having installed the appliance, check that it is not standing on the inlet and drain hose and the worktop is not pressing the electrical supply cable.
- If the machine is situated on a carpeted floor, please adjust the feet in order to allow air to circulate freely.
- Always be sure, that there is no water leakage from hoses and their connections after the installation.
- Any plumbing work required to install this appliance should be carried out by a qualified plumber.
- Any electrical work required to install this appliance should be carried out by a qualified electrician.

## Use

- This appliance is designed for domestic use. It must not be used for purposes other than those for which it was designed.
- Only wash fabrics which are designed to be machine washed. Follow the instructions on each garment label.
- Do not overload the appliance. See the relevant section in the user manual.
- Before washing, ensure that all pockets are empty and buttons and zips are fastened. Avoid washing frayed or torn articles and treat stains such as paint, ink, rust, and grass before washing. Underwired bras must NOT be machine washed.

- Garments which have been in contact with volatile petroleum products should not be machine washed. If volatile cleaning fluids are used, care should be taken to ensure that the fluid is removed from the garment before placing in the machine.
- Never pull the power supply cable to remove the plug from the socket; always take hold of the plug itself.
- Never use the washing machine if the power supply cable, the control panel, the working surface or the base are damaged so that the inside of the washing machine is accessible.

## Child safety

- This washing machine is not intended for use by young children or infirm persons without supervision.
- Young children should be supervised to ensure that they do not play with the appliance.
- The packaging components (e.g. plastic film, polystyrene) can be dangerous to children - danger of suffocation! Keep them out of children's reach
- Keep all detergents in a safe place out of children's reach.
- Make sure that children or pets do not climb into the drum. To avoid this the machine incorporates special feature.

To **activate** this device, rotate the button (without pressing it) inside the door clockwise until the groove is horizontal. If necessary use a coin.

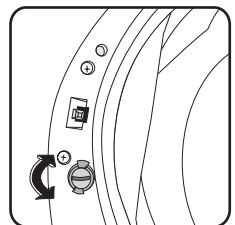

To **disable** this device and restore the possibility of closing the door, rotate the button anti-clockwise until the groove is vertical.

## Environment concerns

---

### Packaging materials

The materials marked with the symbol  are recyclable.

>PE<=polyethylene

>PS<=polystyrene

>PP<=polypropylene

This means that they can be recycled by disposing of them properly in appropriate collection containers.

### Old machine

Use authorised disposal sites for your old appliance. Help to keep your country tidy!

The symbol  on the product or on its packaging indicates that this product may not be treated as household waste. Instead it shall be handed over to the applicable collection point for the recycling of electrical and electronic equipment.

By ensuring this product is disposed of correctly, you will help prevent potential negative consequences for the environment and human health, which could otherwise be caused by inappropriate waste handling of this product.

For more detailed information about recycling of this product, please contact your local city office, your household waste disposal service or the shop where you purchased the product.

### Ecological hints

To save water, energy and to help protect the environment, we recommend that you follow these tips:

- Normally soiled laundry may be washed without prewashing in order to save detergent, water and time (the environment is protected too!).
- The machine works more economically if it is fully loaded.

- With adequate pre-treatment, stains and limited soiling can be removed; the laundry can then be washed at a lower temperature.
- Measure out detergent according to the water hardness, the degree of soiling and the quantity of laundry being washed.

## Product description

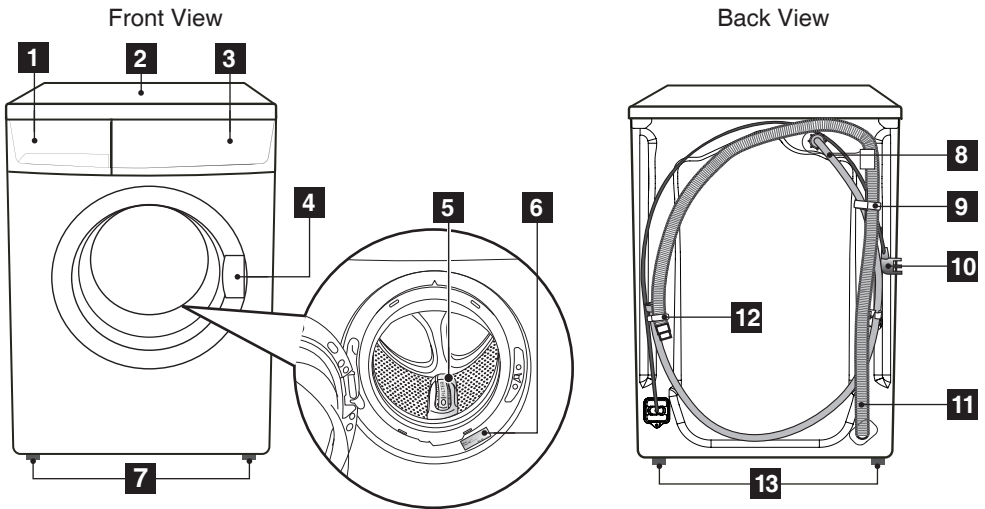

**1** Detergent Dispenser Drawer

**2** Worktop

**3** Control Panel

**4** Door Opening Handle

**5** Drain Filter

**6** Rating Plate

**7** Front Feet

**8** Water Inlet Hose

**9** Drain Hose Support

**10** Mains Cable

**11** Water Drain Hose

**12** Hose Holders

**13** Back Feet

## Technical data

Dimensions	Width	60 cm
	Height	85 cm
	Depth	54 cm
Power supply voltage/frequency		220-240 V/50 Hz
Total power absorbed		2000 W
Minimum fuse protection		10A
Water supply pressure	Minimum	0,05 MPa
	Maximum	0,8 MPa
Maximum Load	Cottons	7.0 kg
	Synthetics	2.5 kg
	Delicates	2.5 kg
	Hand Wash	2.0 kg
Spin Speed	Maximum :	1200 rpm

## Installation

### Unpacking

#### **Important!**

All transit bolts and packing must be removed before using the appliance.

You are advised to keep all transit devices so that they can be refitted if the machine ever has to be transported again.

- Using a spanner unscrew and remove the two rear bottom screws.

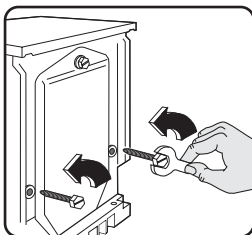

- Slide out the two plastic pins.

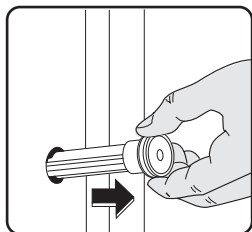

- Lay the machine on its back ensuring that the hoses are not crushed. Place one of the polystyrene angle packings under the machine.

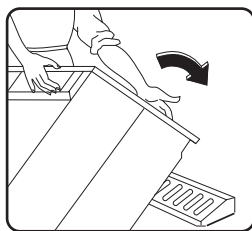

- Remove the polystyrene block (A) protecting the motor.

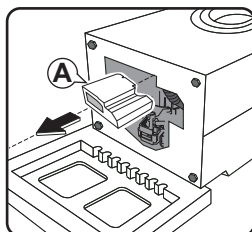

- Very carefully remove the front polystyrene block (B) by gently pulling the polyethylene bag (1) downwards then (2) out, ensuring not to tear the bag.

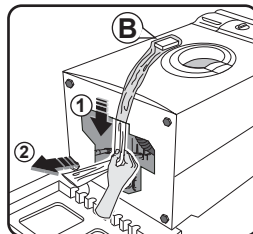

- Some models are provided with a bottom cover that will be found inside the washing machine drum. After ensuring the polyethylene bags have been removed, follow below instruction:

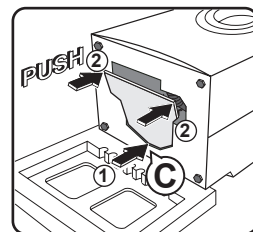

- Locate the bottom cover as shown in position (C).
- Then push the top end to lock to the bottom of washing machine.

- Remove the polystyrene base, set the machine upright and unscrew the remaining rear screw. Slide out the relevant pin.

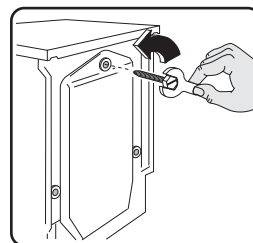

- Cover all the open holes with the plugs which you can find in the bag containing the instruction booklet.

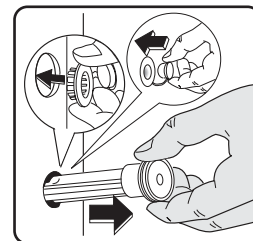

## Positioning

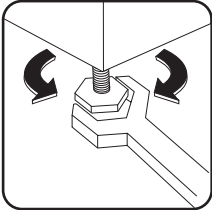
- Install the machine on a flat hard floor.
  - Make sure that air circulation around the machine is not impeded by carpets, rugs etc.
  - Check that the machine does not touch the wall or cupboard units.
  - Carefully level by screwing the adjustable front feet in or out.
- 
- Never place cardboard, wood or similar materials under the machine to compensate for any unevenness in the floor.

## Water inlet

- Connect the water inlet hose to a tap with 3/4" BSP thread.
- Use the hose supplied with the washing machine. **DO NOT USE OLD HOSES.**
- The other end of the inlet hose which connects to the machine can be turned in any direction.
- Simply loosen the fitting, rotate the hose and retighten the fitting, making sure there are no water leaks.

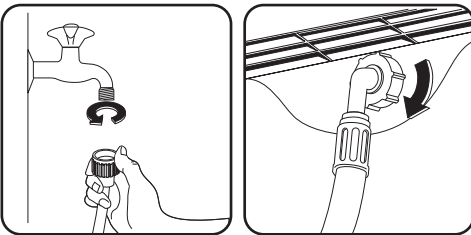

- The inlet hose must not be lengthened. If it is too short and you do not wish to move the tap, you will have to purchase a new, longer hose specially designed for this type of use.

## Water drainage

The end of the drain hose can be positioned in three ways:

### Hooked over the edge of a sink using the plastic hose guide supplied with the machine.

In this case, make sure the end cannot come unhooked when the machine is emptying.

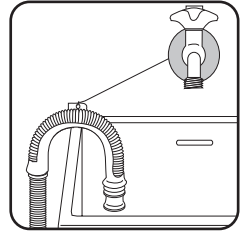

This could be done by tying it to the tap with a piece of string or attaching it to the wall.

**In a sink drain pipe branch.** This branch must be above the trap so that the bend is at least 60 cm above the ground.

**Directly into a drain pipe at a height** of not less than 60 cm and not more than 90 cm.

The end of the drain hose must always be ventilated, i.e. the inside diameter of the drain pipe must be larger than the outside diameter of the drain hose.

The drain hose must not be kinked. Run it along the floor; only the part near the drainage point must be raised.

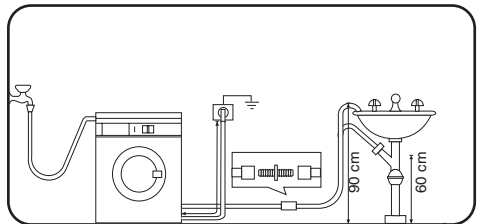

For the correct functioning of the machine the drain hose must remain hooked on the proper support piece situated on the top part of back side of the appliance.

## Electrical Connection

This machine is designed to operate on a 220-240 V, single-phase, 50 Hz supply.

**“An incorrect power supply may void your warranty.”**

Check that your domestic electrical installation can take the maximum load required (2.0 kW), also taking into account any other appliances in use.



### **Important!**

**Connect the machine to an earthed socket.**

The manufacturer declines any responsibility for damage or injury through failure to comply with the above safety precaution. Should the appliance power supply cable need to be replaced, this should be carried out by our Service Centre.

## First Use

- Run a cotton cycle at 90 °C, without any laundry in the machine, to remove any manufacturing residue from the drum and tub. Pour 1/2 a measure of detergent into the dispenser drawer and start the machine.
- Ensure that the electrical and water connections comply with the installation instructions.

## Daily Use

### **Sorting the laundry**

Follow the wash code symbols on each garment label and the manufacturer's washing instructions. Sort the laundry as follows: whites, coloureds, synthetics, delicates, woollens.

### **Before loading the laundry**

- Never wash whites and coloureds together. Whites may lose their "whiteness" in the wash.
- New coloured items may run in the first wash; they should therefore be washed separately the first time.
- **Make sure that no metal objects are left in the laundry (e.g. coins, hair clips, safety pins, pins).**
- Remove persistent stains before washing.
- Button up pillowcases, close zip fasteners, hooks and poppers. Tie any belts or long tapes.

- Rub particularly soiled areas with a special detergent or detergent paste. Treat curtains with special care. Remove hooks or tie them up in a bag or net.

### **Removing stains**

Stubborn stains may not be removed by just water and detergent. It is therefore advisable to treat them prior to washing.

**Blood:** treat fresh stains with cold water. For dried stains, soak overnight in water with a special detergent then rub in the soap and water.

**Oil based paint:** moisten with benzine stain remover, lay the garment on a soft cloth and dab the stain; treat several times.

**Dried grease stains:** moisten with turpentine, lay the garment on a soft surface and dab the stain with the fingertips and a cotton cloth.



**Rust:** oxalic acid dissolved in hot water or a rust removing product used cold. Be careful with rust stains which are not recent since the cellulose structure will already have been damaged and the fabric tends to hole.

**Mould stains:** treat with bleach, rinse well (whites and fast coloureds only).

**Grass:** soap lightly and treat with bleach (whites and fast coloureds only).

**Ball point pen and glue:** moisten with acetone (\*), lay the garment on a soft cloth and dab the stain.

**Lipstick:** moisten with acetone (\*) as above, then treat stains with methylated spirits. Remove any residual marks from white fabrics with bleach.

**Red wine:** soak in water and detergent, rinse and treat with acetic or citric acid, then rinse. Treat any residual marks with bleach.

**Ink:** depending on the type of ink, moisten the fabric first with acetone (\*), then with acetic acid; treat any residual marks on white fabrics with bleach and then rinse thoroughly.

**Tar stains:** first treat with stain remover, methylated spirits or benzine, then rub with detergent paste.

(\*) do not use acetone on artificial silk.

## Load the laundry

Open the door by carefully pulling the door handle outwards.

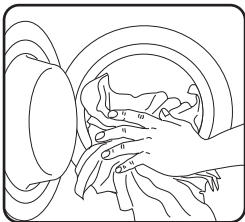

Place the laundry in the drum, one item at a time, shaking them out as much as possible. Close the door.

### **i** Maximum loads

Recommended loads are indicated in the program charts. General rules:

- **Cotton, linen:** drum full but not too tightly packed;
- **Synthetics:** drum no more than half full;
- **Delicate fabrics and woollens:** drum no more than one third full.

Washing a maximum load makes the most efficient use of water and energy. For heavily soiled laundry, reduce the load size.

## Detergents and additives

Good washing results also depend on the choice of detergent and use of the correct quantities to avoid waste and protect the environment. Although biodegradable, detergents contain substances which, in large quantities, can upset the delicate balance of nature.

The choice of detergent will depend on the type of fabric (delicates, woollens, cottons, etc.), the colour, washing temperature and degree of soiling.

Only low suds Front load washer detergents should be used in this appliance:

- powder detergents for all types of fabric.
- powder detergents for delicate fabrics (60 °C max) and woollens,
- liquid detergents, preferably for low temperature wash program (60 °C max) for all types of fabric, or special for woollens only.

The detergent and any additives must be placed in the appropriate compartments of the dispenser drawer before starting the wash program.

If using concentrated powder or liquid detergents, a program **without** prewash must be selected.

Any fabric softener or starching additives must be poured into the compartment marked "⊗" before starting the wash program.

Follow the product manufacturer's recommendations on quantities to use and **do not exceed the MAX mark in the detergent dispenser drawer.**

Do not spray stain pre-treatment products (e.g. Vanish) on or near the machine, as it can attack plastic materials reducing its life.

### Quantity of detergent to be used

The type and quantity of detergent will depend on the type of fabric, load size, degree of soiling and hardness of the water used.

Water hardness is classified in so-called "degrees" of hardness.

Information on hardness of the water in your area can be obtained from the relevant water supply company, or from your local authority.

Follow the product manufacturers' instructions on quantities to use.

### Not enough washing powder causes:

- the washload to turn grey,
- greasy clothes.

### Too much washing powder causes:

- sudsing,
- reduced agitation and washing effect,
- inadequate rinsing.

### Use less detergent if:

- you are washing a small load,
- the laundry is lightly soiled,
- large amounts of foam form during washing.

### Open the detergent dispenser drawer

The detergent dispenser is divided into three compartments.

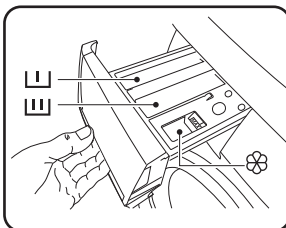

- Compartment **U** : this compartment is only used for washing powder when a program has Prewash or Stain.

- Compartment **U** : this compartment is used for washing powder or liquid.
- Compartment **⊗** : this compartment is used for fabric conditioner and starching agent.

Always add laundry detergents before switching the machine on and keep the dispenser clean and dry, so that the detergent can be efficiently dispensed from the unit.

### Measure out the detergent and the fabric softener

Measure out the amount of detergent required, pour it into the "main wash" compartment "**U**".

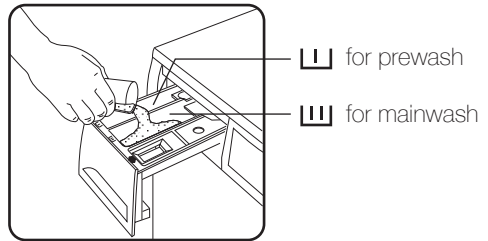

If you wish to carry out the "prewash" phase, pour it into the compartment marked "**U**".

If required, pour fabric softener into the compartment marked **⊗** (the amount used must not exceed the "MAX" mark in the drawer).

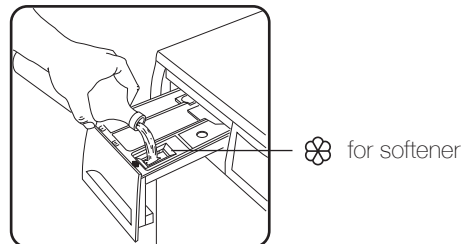

Close the drawer gently.

# Control panel

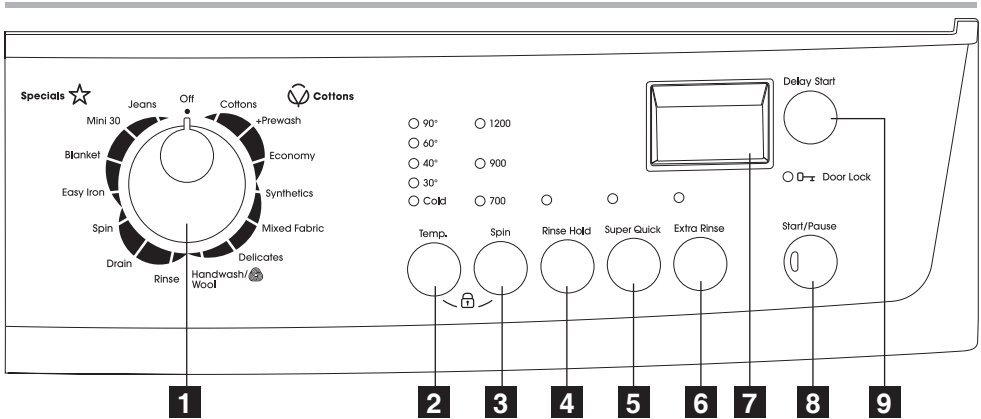

- 1** Program selector dial
- 2** Temperature button
- 3** Spin button
- 4** Rinse Hold button
- 5** Super Quick button

- 6** Extra Rinse Button
- 7** Display
- 8** Start/Pause button
- 9** Delay Start button

## Set your washing program

### Program selector dial

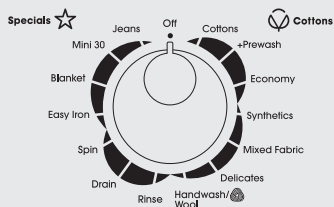

Turn the program selector dial to the required program. The green Start/Pause light starts to flash.

The selector dial is divided into following sections:

- (Cancelling/Off)
- 👤 (Cottons)
- +U (Cottons Prewash)
- 👤 (Cottons Economy)
- △ (Synthetics)
- MIX (Mixed Fabric)
- 🌸 (Delicates)
- 👤 (Wool/Handwash)
- 🚰 (Rinse)
- 👤 (Drain)
- 🌀 (Spin)
- 👤 (Easy Iron)
- 🛏️ (Blanket)
- 🕒 30' (Mini 30)
- 👤 (Jeans)

The selector dial can be turned either clockwise or anticlockwise. Position “Off” to Reset program/Switching OFF the machine.

**At the end of the program the selector dial must be turned to position “Off”, to switch the machine off.**

#### **Attention!**

If you turn the program selector dial to another program when the machine is working, the **red** Start/Pause pilot light will flash 3 times to indicate a wrong selection. The machine will not perform the new selected program.

#### **Cancelling a program**

Turn the selector dial to “Off” to cancel a program which is running. Now you can select a new program.

### Temperature selector

- 90°
- 60°
- 40°
- 30°
- Cold

Temp.



Press this button repeatedly to increase or decrease the temperature, if you want your laundry to be washed at a temperature different from the one proposed by the washing machine.

If a temperature is chosen that is not allowed with the selected program, the **red** pilot light of the **Start/pause** button will flash 3 times.

## Spin Buttons

1200

900

700

Spin



Press the Spin button repeatedly to change the spin speed, if you want your laundry to be spun at a speed different from the one proposed by the washing machine. The relevant light will light up.

## Rinse Hold



Rinse Hold



By selecting this option the water of the last rinse is not emptied out to prevent the fabrics from creasing.

### To empty out the water:

- turn the program selector dial to “Off”.
- select the **Drain** or **Spin** program.
- reduce the spin speed if needed, by means of the relevant button.
- depress **Start/Pause** button.

## Super Quick Buttons



Super Quick



This option can be used for lightly soiled in order to obtain a good washing result in a short time.

The washing time will be reduced according to type of fabric and the selected temperature.

If an option is chosen that is not allowed with the selected program, the **red** pilot light of the **Start/Pause** button will flash 3 times.

## Extra Rinse Option



Extra Rinse



This option is recommended for people who are allergic to detergents, and in areas where the water is very soft.

The machine performs some additional rinses.

## Display

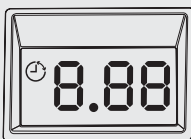

The display shows the following information:

### • Duration of the selected program.

After selecting a program the duration is displayed in hours and minutes (for example **2.05**).

The duration is calculated automatically on the basis of the maximum recommended load for each type of fabric.

## Display (continues)

After the program has started, the time remaining is updated every minute.

### • Delayed start

The selected delay (20 hours max) set by means of the relevant button appears on the display for about 3 seconds, then the duration of the previously selected program is displayed. The delay time value decreases by one unit every hour and then, when 1 hours remain, the time decreases every minute.

### • Incorrect option selection

If an option which is not compatible with the set wash programme is selected, the message **Err** is displayed for about 2 seconds and the integrated red Start/Pause light start flashing.

### • Alarm codes

In the event of operating problems, some alarm codes can be displayed, for example **E20** (see paragraph "Something not working").

### • End of programme

When the program has finished a flashing zero is displayed.

### • Door open

When the door has not been closed a flashing **E40** is displayed.

## Start/Pause button

Start/Pause



To start the selected program, press the **"Start/Pause"** button; the corresponding green pilot light stops flashing.

To interrupt a program which is running, depress the **"Start/Pause"** button: the corresponding green pilot light starts to flash.

To restart the program from the point at which it was interrupted, press the **"Start/Pause"** button again.

If you have chosen a delayed start, the machine will begin the countdown.

## Delay Start Button

Delay Start



Before you start the program, this option makes it possible to delay the starting of the washing program by 30 min - 60 min - 90 min, 2 hours and then by 1 hour till 20 hours.

The selected delay time will appear on the display for about 3 seconds, then the duration of the program will appear again.

## Delay Start Button (continues)

The above options must be selected after choosing the wash program with the dial, and before pressing the Start/Pause button.

**If after having set the delay start option (and pressed Start/Pause button) and you wish to cancel it, follow the below steps:**

- set the washing machine to PAUSE by pressing the Start/Pause button;
- deselect the Delay start option, changing the status;
- press the Start/Pause button to start the program.

### Important!

- The selected delay can be changed only after selecting the washing program again.
- The door will lock through out the delay time.
- If you need to open the door, you must first set the washing machine to PAUSE by pressing the Start/Pause button, after that you need to wait about 2-3 minutes to release door lock, the **Door Lock (  )** pilot light is flashing to show the door release is in process, pilot light switch off when the door can be opened.

## Child Lock Option ( )

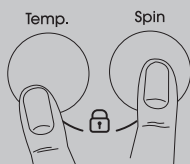

The "Child Lock" feature will allow you to lock the controls while the machine is running to prevent tampering.

ACTIVATE "Child Lock" by pressing the "Temperature" and "Spin" buttons about 3 seconds, the padlock symbol "  " is displayed on the screen.

To DE-ACTIVE "Child Lock" simply press the "Temperature" and "Spin" buttons about 3 seconds, the "  " padlock symbol in the screen will disappear.

Child Lock will remain activated until you de-activate it, even if the machine is turned off.

## Acoustic Signals Option

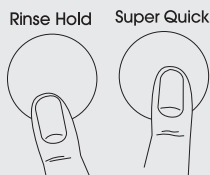

The machine is provided of an acoustic device, which sounds in the following cases:

- when selecting a wash program
- when depressing the options buttons
- at the end of the cycle
- in the event of operating problems

By pressing the "Rinse Hold" and "Super Quick" buttons simultaneously for about 3 seconds, the acoustic signal is deactivated (except for the events of operating problems). By pressing these 2 buttons again, the acoustic signal is reactivated.

## Altering an option or a running program

It is possible to change any option before the program carries it out. The option **“Super Quick”** cannot be modified after the Start/Pause has been pressed.

Changing a running program is possible **only by resetting it**. Turn the program selector dial to **“Off”** and then to the new program position. The washing water in the tub not be emptied out. Start the new program by depressing the **“Start/Pause”** button again.

## Interrupting a program

Depress the **“Start/Pause”** button to interrupt a program which is running, the corresponding light starts to flash. Depress the button again to restart the program.

## Opening the door after the program has started





























If you need to open the door, you must first set the washing machine to **PAUSE** by pressing the **Start/Pause** button, after that you need to wait about 2-3 minutes to release door lock.

If the machine is already heating or the water level is above the bottom edge of the door or that the drum is turning. In this case the door can not be opened.

If you can not open the door but you need to open it you have to switch the machine off by turning the selector dial to **“Off”**. After about 3 minutes the door can be opened (**pay attention to the water level and temperature!**).



## International wash code symbols

These symbols appear on fabric labels, in order to help you choose the best way to treat your laundry.



<b>Energetic wash</b>   <b>Delicate wash</b>	 Max. wash temperature <b>95 °C</b>	 Max. wash temperature <b>60 °C</b>	 Max. wash temperature <b>40 °C</b>	 Max. wash temperature <b>30 °C</b>	 Hand wash	 Do not wash at all
 <b>Bleaching</b>	 Bleach in cold water			 Do not bleach		
 <b>Ironing</b>	 Hot iron <b>max 200°C</b>	 Warm iron <b>max 150°C</b>	 Lukewarm iron <b>max 110°C</b>	 Do not iron		
 <b>Dry cleaning</b>	 Dry cleaning in all solvents	 Dry cleaning in perchlorethylene, petrol, pure alcohol, R 111 & R 113		 Dry cleaning in petrol, pure alcohol and R 113		 Do not dry clean
 <b>Drying</b>	 Flat	 On the line	 On clothes hanger	 high temperature  low temperature Tumble dry		 Do not tumble dry



## Programs informations

Off (Cancelling/Off)	To reset a programme and to switch off the machine turn the selector dial to " <b>Off</b> ". Now, a new programme can be selected.
Cottons	Washing programme for white and coloured cottons fabrics.
Cottons Prewash	select this program if you wish your laundry to be prewashed at 30° C before the main wash.
Cottons Economy	select this program if you wish your laundry to be washed is slightly/ normally soiled cottons. This program will obtain good washing results whilst saving energy.
Synthetics	Washing programme for synthetic or mixed fabrics.
Mixed Fabric	Highly energy efficient cold wash programme for lightly soiled laundry. This programme requires a detergent which is active in cold water.
Delicates	Washing programme for delicate fabrics.
Handwash/ Wool 	Washing programme for machine washable wool as well as for hand washable woollens and delicate fabrics with the "hand washing  " care symbol.
Rinse	With this programme it is possible to rinse and spin cotton garments which have been washed by hand. The machine performs 3 rinses, followed by a final spin at maximum speed. The spin speed can be reduced by pressing Spin button.
Drain	For emptying out the water of the last rinse in programmes with the " <b>Rinse Hold</b> " option. Turn first the programme selector dial to " <b>Off</b> ", then select programme Drain and press the Start/Pause button.
Spin	Separate spin for hand washed garments and after programmes with " <b>Rinse Hold</b> " option. Before selecting this programme the selector dial must be turned to " <b>Off</b> ". You can choose the speed by means of the relevant button to adapt it to the fabrics to be spun.
Easy Iron	Selecting this programme the laundry is gently washed and spun to avoid any creasing. In this way ironing is easier. Furthermore the machine will perform some additional rinses. This programme can be used only for cotton and synthetic fabrics.
Blanket	A gentle program designed for mixed fabrics found in delicate clothes.
Mini 30	Separate programme for lightly soiled synthetics, mixed fabrics and delicates.
Jeans	Trousers, shirts or jackets in denim and jersey realized with hi-tech materials. The Extra Rinse option is activated automatically.

## Washing programs

Program/ Temperature		Type of laundry	Description of program	Options	Max. Load
COTTONS 	<b>Cottons</b> Cold - 90° C	White, coloured cotton and linen (Normally soiled items):. e.g. shirts, underwear, towels.	- Main wash at Cold - 90° C - Rinses - Long spin	- Spin Reduction - Rinse Hold - Delay Start - Super Quick - Extra Rinse	7.0 kg
	<b>Prewash</b> Cold - 90° C	White, coloured cotton and linen (Heavy soiled items):. e.g. sheets, tablecloths, household linen.	- Main wash at Cold - 90° C - Rinses - Long spin	- Spin Reduction - Rinse Hold - Delay Start - Super Quick - Extra Rinse	7.0 kg
	<b>Economy</b> 40° - 60° C	White, coloured cotton and linen (slightly or normally soiled cotton items):. e.g. shirts, blouses, underwear, towels.	- Main wash at 40° - 60° C - Rinses - Long spin	- Spin Reduction - Rinse Hold - Delay Start - Extra Rinse	7.0 kg
<b>Synthetics</b> Cold - 60° C		Synthetic or mixed fabrics (Normally soiled items):. e.g. underwear, coloured garments, non-shrink shirts, blouses.	- Main wash at Cold - 60° C - Rinses - Long spin	- Spin Reduction - Rinse Hold - Delay Start - Super Quick - Extra Rinse	2.5 kg
<b>Mixed Fabric</b> Cold		Mixed fabrics (lightly soiled laundry).	- Main wash at Cold - Rinses - Long spin	- Spin Reduction - Rinse Hold - Delay Start - Extra Rinse	2.5 kg
<b>Delicates</b> Cold - 40° C		Delicate fabrics (Normally soiled items):. e.g. curtains, acrylics, viscose, polyester.	- Main wash at Cold - 40° C - Rinses - Short spin	- Spin Reduction (Maximum 700 rpm) - Rinse Hold - Delay Start - Super Quick - Extra Rinse	2.5 kg
<b>Handwash/ Wool</b>  Cold - 40° C		Woollens and hand washing fabrics.	- Main wash at Cold - 40° C - Rinses - Long spin	- Spin Reduction - Rinse Hold - Delay Start	2.0 kg
<b>Rinse</b>		Separate rinse cycle for hand washed items of cottons.	- Rinses - Long spin	- Spin Reduction - Rinse Hold - Delay Start - Extra Rinse	7.0 kg

Program/ Temperature	Type of laundry	Description of program	Options	Max. Load	
<b>Drain</b>	For emptying out the water left in the drum.	- Drain of water	Not available	7.0 kg	
<b>Spin</b>	Separate spin program for spin out the water from clothes.	- Drain - Long spin	- Spin Reduction - Delay Start	7.0 kg	
☆ <b>SPECIALS</b>	<b>Easy Iron</b> Cold - 40° C	Cottons and synthetic or mixed fabrics.	- Main wash at Cold - 40° C - Rinses - Short spin	- Spin Reduction (Maximum 900 rpm) - Rinse Hold - Delay Start - Extra Rinse	2.5 kg
	<b>Blanket</b> 30° - 40° C	A gentle program designed for mixed fabrics found in delicate clothes.	- Main wash at 30° - 40° C - Rinses - Short spin	- Spin Reduction (Maximum 700 rpm) - Delay Start	7.0 kg
	<b>Mini 30</b> 30° C	Synthetics and delicates (lightly soiled items) or which only needs freshening up.	- Main wash at 30° C - Rinses - Short spin	- Spin Reduction (Maximum 700 rpm) - Delay Start	2.5 kg
	<b>Jeans</b> Cold - 60° C	Trousers, shirts or jackets in denim and jersey realized with hi-tech materials.	- Main wash at Cold - 60° C - Rinses - Long spin	- Spin Reduction - Rinse Hold - Delay Start	2.5 kg

\* Cottons Economy at 60 °C is recommended for a full load of normally soiled cottons, and is the water and energy rating label program (in accordance with CEE 92/75 standards).

## Care and cleaning

### Important!

You must DISCONNECT the appliance from the electricity supply, before you can carry out any cleaning or maintenance work.

### Descaling

The water we use normally contains lime. It is a good idea to periodically use a water softening powder in the machine. Do this separately from any laundry washing, and according to the softening powder manufacturer's instructions. This will help to prevent the formation of lime deposits.

### After each wash

Leave the door open for a while. This helps to prevent mould and stagnant smells forming inside the appliance. Keeping the door open after a wash will also help to preserve the door seal.

### Maintenance Wash

With the use of low temperature washes it is possible to get a build up of residues inside the drum. We recommend that a maintenance wash be performed on a regular basis.

To run a maintenance wash:

- The drum should be empty of laundry.
- Select the hottest cotton wash program.
- Use a normal measure of detergent, must be a powder with biological properties.

## External cleaning

Clean the exterior cabinet of the appliance with soap and water only, and then dry thoroughly.

## Cleaning the dispenser drawer

The washing powder and additive dispenser drawer should be cleaned regularly.

Remove the drawer by pressing the catch downwards and by pulling it out.

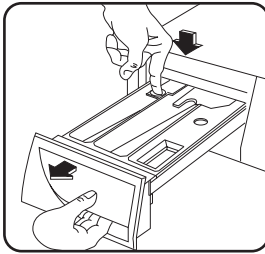

Flush it out under a tap, to remove any traces of accumulated powder.

To aid cleaning, the top part of the additive compartment should be removed.

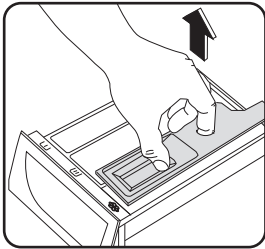

## Cleaning the drawer recess

Having removed the drawer, use a small brush to clean the recess, ensuring that all washing powder residue is removed from the upper and lower part of the recess.

use a small brush to clean the recess.

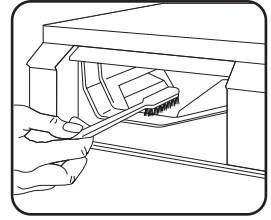

Replace the drawer and run the rinse programme without any clothes in the drum.

## Cleaning the drain filter

Drain filter collects lint and other items left in the dirty laundry to prevent pump blockage

The pump must be cleaned regularly. To clean the filter, proceed as follows:

- Turn programme selector dial to position Off (Off).
- Unplug the appliance.
- Open the door.
- Turn the drum and align the filter cover (FILTER) with the arrow on the door seal.

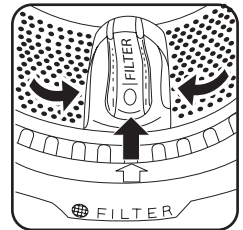
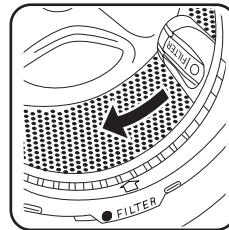

- Open the filter cover by pressing the special hook and by rotating the cover upwards.

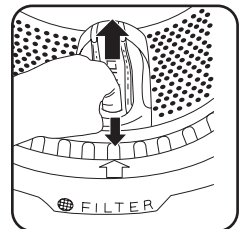
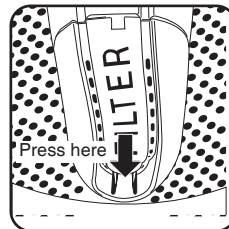

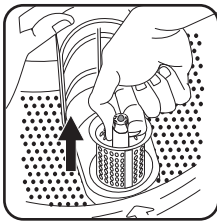

- Hold filter securely and pull upwards to remove it from its position.

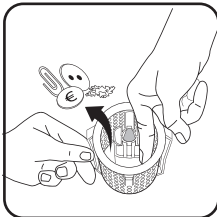

- Remove eliminate the eventual fluff or small objects around the filter.

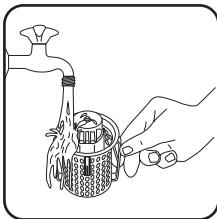

- Clean the filter under the water tap.

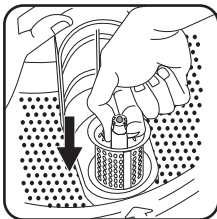

- After cleaning the filter, open the filter cover and insert the filter back to its position.



### Important!

The filter is inserted correctly when the indicator on this top is visible and you will hear "Click" sound.

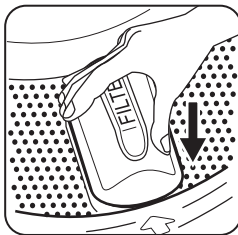
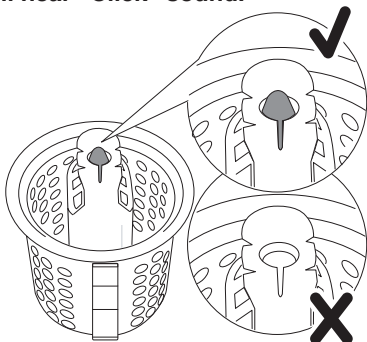

- close the filter cover.
- insert the mains plug again.



### Important!

**Do not start washing clothes without the filter in its place.**

### Cleaning the water inlet filter

If your water is very hard or contains traces of lime deposit, the water inlet filter may become clogged.

It is therefore a good idea to clean it from time to time.

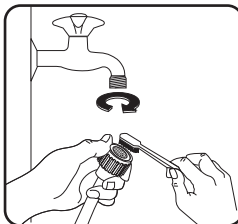

- Turn off the water tap.
- Unscrew the water inlet hose.
- Clean the filter using a hard bristle brush.
- Tighten up the inlet hose.

## Something not working

Certain problems are due to lack of simple maintenance or oversights, which can be solved easily without calling out an engineer. Before contacting your local Service Centre, please carry out the checks listed below.

During machine operation it is possible that the **red Start/Pause** pilot light flashes to indicate that the machine is not working.

Once the problem has been eliminated, press the **Start/Pause** button to restart the program. If after all checks, the problem persists, contact your local Service Centre.

Malfunction	Possible cause	Solution
The washing machine does not start:	The door has not been closed. <b>(Red Start/Pause pilot light flashes)</b>	Close firmly the door.
	The plug is not properly inserted in the power socket.	Insert the plug into the power socket.
	There is no power at the socket.	Please check your domestic electrical installation.
	The selector dial is not correctly positioned and the <b>Start/Pause</b> button has not been depressed.	Please turn the selector dial and press the <b>Start/Pause</b> button again.
	The delay start has been selected.	If the laundry are to be washed immediately, cancel the delay start.
The machine does not fill:	The water tap is closed. <b>(Red Start/Pause pilot light flashes)</b>	Open the water tap.
	The inlet hose is squashed or kinked. <b>(Red Start/Pause pilot light flashes)</b>	Check the inlet hose connection.
	The filter in the inlet hose is blocked. <b>(Red Start/Pause pilot light flashes)</b>	Clean the water inlet hose filter.
	The door is not properly closed. <b>(Red Start/Pause pilot light flashes)</b>	Close firmly the door.
The machine fills then empties immediately:	The end of the drain hose is too low.	Refer to relevant paragraph in "water drainage" section.
The machine does not empty and/or does not spin:	The drain hose is squashed or kinked. <b>(Red Start/Pause pilot light flashes)</b>	Check the drain hose connection.
	The drain filter is clogged. <b>(Red Start/Pause pilot light flashes)</b>	Clean the drain filter.
	The option <b>Rinse Hold</b> has been selected.	Disable the option <b>Rinse Hold</b> or select <b>Spin</b> program.
	The laundry is not evenly distributed in the drum.	Redistribute the laundry.

<b>Malfunction</b>	<b>Possible cause</b>	<b>Solution</b>
<b>There is water on the floor:</b>	Too much detergent or unsuitable detergent (creates too much foam) has been used.	Reduce the detergent quantity or use another one.
	Check whether there are any leaks from one of the inlet hose fittings. It is not always easy to see this as the water runs down the hose; check to see if it is damp.	Check the water inlet hose connection.
	The drain hose is damaged.	Change it with a new one.
<b>Unsatisfactory washing results:</b>	Too little detergent or unsuitable detergent has been used.	Increase the detergent quantity or use another one.
	Stubborn stains have not been treated prior to washing.	Use commercial products to treat the stubborn stains.
	The correct temperature was not selected.	Check if you have selected the correct temperature.
	Excessive laundry load.	Introduce into the drum less laundry.
<b>The door will not open:</b>	The program is still running.	Wait the end of washing cycle.
	The door lock has not been released.	Wait about 3 minutes.
	There is water in the drum.	Select drain or spin program to empty out the water.
<b>The machine vibrates or is noisy:</b>	The transit bolts and packing have not been removed.	Check the correct installation of the appliance.
	The support feet have not been adjusted.	Check the correct levelling of the appliance.
	The laundry is not evenly distributed in the drum.	Redistribute the laundry.
	Maybe there is very little laundry in the drum.	Load more laundry.
	Unstable floors eg. wooden floors.	
<b>The machine makes an unusual noise:</b>	The machine is fitted with a type of motor which makes an unusual noise compared with other traditional motors. This new motor ensures a softer start and more even distribution of the laundry in the drum when spinning, as well as increased stability of the machine.	

Malfunction	Possible cause	Solution
<b>Spinning starts late or the machine does not spin:</b>	The electronic unbalance detection device has cut in because the laundry is not evenly distributed in the drum. The laundry is redistributed by reverse rotation of the drum. This may happen several times before the unbalance disappears and normal spinning can resume. If, after 10 minutes, the laundry is still not evenly distributed in the drum, the machine will not spin. In this case, redistribute the load manually and select the spin programme.	Redistribute the laundry.
<b>No water is visible in the drum:</b>	Machines based on modern technology operate very economically using very little water without affecting performance.	

If you are unable to identify or solve the problem, contact our service centre. Before telephoning, make a note of the model, serial number and purchase date of your machine, the Service Centre will require this information.

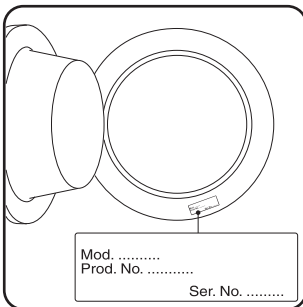

- Model description (MOD.).....
- Product number (PNC) .....
- Serial number (S.N.) .....



## Free Manuals Download Website

<http://myh66.com>

<http://usermanuals.us>

<http://www.somanuals.com>

<http://www.4manuals.cc>

<http://www.manual-lib.com>

<http://www.404manual.com>

<http://www.luxmanual.com>

<http://aubethermostatmanual.com>

Golf course search by state

<http://golfingnear.com>

Email search by domain

<http://emailbydomain.com>

Auto manuals search

<http://auto.somanuals.com>

TV manuals search

<http://tv.somanuals.com>