

Installation and Operating Guide | Warranty

Model Number | DVR313 | DVD Recorder



© Copyright 2003, Zenith Electronics Corporation



Safety Precautions



CAUTION
RISK OF ELECTRIC SHOCK
DO NOT OPEN



CAUTION: TO REDUCE THE RISK OF ELECTRIC SHOCK DO NOT REMOVE COVER (OR BACK) NO USER-SERVICEABLE PARTS INSIDE REFER SERVICING TO QUALIFIED SERVICE PERSONNEL.



This lightning flash with arrowhead symbol within an equilateral triangle is intended to alert the user to the presence of uninsulated dangerous voltage within the product's enclosure that may be of sufficient magnitude to constitute a risk of electric shock to persons.



The exclamation point within an equilateral triangle is intended to alert the user to the presence of important operating and maintenance (servicing) instructions in the literature accompanying the product.

WARNING: TO REDUCE THE RISK OF FIRE OR ELECTRIC SHOCK, DO NOT EXPOSE THIS APPARATUS TO RAIN OR MOISTURE.

CAUTION: TO PREVENT ELECTRIC SHOCK, MATCH WIDE BLADE OF PLUG TO WIDE SLOT, FULLY INSERT.

ATTENTION: POUR ÉVITER LES CHOC ÉLECTRIQUES, INTRODUIRE LA LAME LA PLUS LARGE DE LA FICHE DANS LA BORNE CORRESPONDANTE DE LA PRISE ET POUSSER JUSQU'AU FOND.

WARNING: Do not install this equipment in a confined space such as a bookcase or similar unit.

NOTE TO CABLE/TV INSTALLER: This reminder is provided to call the cable TV system installer's attention to Article 820-40 of the National Electric Code (U.S.A.). The code provides guidelines for proper grounding and, in particular, specifies that the cable ground shall be connected to the grounding system of the building, as close to the point of the cable entry as practical.

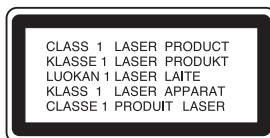

CAUTION:

This DVD Recorder employs a Laser System.

To ensure proper use of this product, please read this owner's manual carefully and retain for future reference. Should the unit require maintenance, contact an authorized service center.

Use of controls, adjustments, or the performance of procedures other than those specified herein may result in hazardous radiation exposure.

To prevent direct exposure to laser beam, do not try to open the enclosure. Visible laser radiation when open. DO NOT STARE INTO BEAM.

CAUTION: The apparatus should not be exposed to water (dripping or splashing) and no objects filled with liquids, such as vases, should be placed on the apparatus.

FCC WARNING: This equipment may generate or use radio frequency energy. Changes or modifications to this equipment may cause harmful interference unless the modifications are expressly approved in the instruction manual. The user could lose the authority to operate this equipment if an unauthorized change or modification is made.

REGULATORY INFORMATION: FCC Part 15

This product has been tested and found to comply with the limits for a Class B digital device, pursuant to Part 15 of the FCC Rules. These limits are designed to provide reasonable protection against harmful interference when the product is operated in a residential installation. This product generates, uses, and can radiate radio frequency energy and, if not installed and used in accordance with the instruction manual, may cause harmful interference to radio communications. However, there is no guarantee that interference will not occur in a particular installation. If this product does cause harmful interference to radio or television reception, which can be determined by turning the product off and on, the user is encouraged to try to correct the interference by one or more of the following measures:

- Reorient or relocate the receiving antenna.
- Increase the separation between the product and receiver.
- Connect the product into an outlet on a circuit different from that to which the receiver is connected.
- Consult the dealer or an experienced radio/TV technician for help.

FCC COMPLIANCE: The responsible party for this product's compliance is: Zenith Electronics Corporation, 2000 Millbrook Drive, Lincolnshire, IL 60069, USA.
Phone: 1-847-941-8000

SERIAL NUMBER: The serial number is found on the back of this unit. This number is for this unit only. You should record requested information here and retain this guide as a permanent record of your purchase.

Model No. _____

Serial No. _____

IMPORTANT SAFETY INSTRUCTIONS

CAUTION: PLEASE READ AND OBSERVE ALL WARNINGS AND INSTRUCTIONS IN THIS OWNER'S MANUAL. AND THOSE MARKED ON THE PRODUCT. RETAIN THIS MANUAL FOR FUTURE REFERENCE.

This product has been designed and manufactured to assure personal safety. Improper use can result in electric shock or fire hazard. The safeguards incorporated in this product will protect you if you observe the following procedures for installation, use, and servicing.

This product does not contain any parts that can be repaired by the user.

DO NOT REMOVE THE CABINET COVER, OR YOU MAY BE EXPOSED TO DANGEROUS VOLTAGE. REFER SERVICING TO QUALIFIED SERVICE PERSONNEL ONLY.

- 1. Read these instructions.** - All these safety and operating instructions should be read before the product is operated.
- 2. Keep these instructions.** - The safety, operating and use instructions should be retained for future reference.
- 3. Heed all warnings.** - All warnings on the product and in the operating instructions should be adhered to.
- 4. Follow all instructions.** - All operating and use instructions should be followed.
- 5. Do not use this product near water.** - For example: near a bath tub, wash bowl, kitchen sink, laundry tub, in a wet basement; or near a swimming pool; and other areas located near water.
- 6. Clean only with dry cloth.** - Unplug this product from the wall outlet before cleaning. Do not use liquid cleaners.
- 7. Do not block any ventilation openings. Install in accordance with the manufacturer's instructions.** - Slots and openings in the cabinet are provided for ventilation and to ensure reliable operation of the product and to protect it from over- heating. The openings should never be blocked by placing the product on a bed, sofa, rug or other similar surface. This product should not be placed in a built-in installation such as a bookcase or rack unless proper ventilation is provided or the manufacturer's instructions have been adhered to.
- 8. Do not install near any heat sources such as radiators, heat registers, stoves, or other apparatus (including amplifiers) that produce heat.**
- 9. Do not defeat the safety purpose of the polarized or grounding-type plug.** A polarized plug has two blades with one wider than the other. A grounding type plug has two blades and a third grounding prong. The wide blade or the third prong are provided for your safety. If the provided plug does not fit into your outlet, consult an electrician for replacement of the obsolete outlet.
- 10. Protect the power cord from being walked on or pinched particularly at plugs, convenience receptacles, and the point where they exit from the product.**
- 11. Only use attachments/accessories specified by the manufacturer.**
- 12. Use only with the cart, stand, tripod, bracket, or table specified by the manufacturer, or sold with apparatus. When a cart is used, use caution when moving the cart/product combination to avoid injury from tip-over.**
- 13. Unplug this product during lightning storms or when unused for long periods of time.**
- 14. Refer all servicing to qualified service personnel. Servicing is required when the product has been damaged in any way, such as power-supply cord or plug is damaged, liquid has been spilled or objects have fallen into the product, the product has been exposed to rain or moisture, does not operate normally, or has been dropped.**



Table of Contents

INTRODUCTION

Safety Precautions	2
IMPORTANT SAFETY INSTRUCTIONS	3
Table of Contents	4-5
DVR313 Overview	6-9
Recordable Discs	6
Playable Discs	6
Disc-related terms	6
Types of video CDs	6
About DVD-R and DVD-RW disc	7
What are 'recording modes'?	7
• Is editing a DVD like editing a video tape?	7
• About word 'Original' and 'Playlist'	7
About DVD recording	7-8
• Disc types and recording formats, modes, and settings	7
• Notes for recording	8
• Recording TV audio channels	8
• Restrictions on video recording	8
• What is 'CPRM'?	8
• Copyright	8
Precautions	9
• Handling the unit	9
• Cleaning the unit	9
Notes on Discs	9
• Handling discs	9
• Storing discs	9
• Cleaning discs	9
About Symbols	9
• About the  symbol display	9
• About the disc symbols for instructions	9
Front Panel	10
Function Display Window	11
Remote Control Overview	12
Controlling TVs and Cable Boxes (DBS)	13
Programming the Remote	13
Rear Panel	14

DVR HOOKUP

Connections	15-18
Connecting Antenna/Cable TV to DVD Recorder	15
Connecting to a TV	16
Connecting to Optional Equipment	17
Accessory Audio/Video (A/V) Connections to DVD Recorder	18
Connecting a Digital Camcorder	18
Before Operation	19-28
Initial Settings	19
General Operation	19
Setup	19-21
• EZ Channel Scan	19
• Tuning Band	19
• To Add or Erase Channels from Memory	19
• Auto Clock Set	20
• Manual Clock Set	20
• TV Aspect	20
• Progressive Scan	21
• PBC	21
• Set Initialize	21
Language	21
• Disc Language	21
• OSD Language	21
Audio	22
• Dolby Digital	22
• DTS	22
• MPEG	22
• Sampling Freq. (Frequency)	22
• Vocal	22
• Dynamic Range Control (DRC)	22
Lock (Parental Control)	23-24
• Rating	23
• Set Password	23
• Country Code	24
Recording	24-25
• Record Mode Set	24
• Record Aspect	24
• Auto Chapter	25
• DV Rec Audio	25
Disc	25-26
• Initialize	25
• Protection	25
• Finalize	26
• Disc Name	26
General Explanation of On-Screen Display	27
On-Screen Display	27-28
Using the built-in TV tuner	29
Changing TV Channels	29
Changing TV Audio Channel	29
Displaying OSD While Watching TV	29

Table of Contents

PLAYBACK

Operation with DVD and Video CD	30-33
Playing a DVD or Video CD	30
• Moving to another TITLE	30
• Moving to another CHAPTER/TRACK	30
• Slow Motion	30
• Still Picture and Frame-by-Frame Playback	31
• Search	31
• Random	31
• Repeat	31
• Repeat A-B	31
• Time Search	31
• Zoom	32
• Marker Search	32
• Checking the contents of DVD Video discs:	
• Menus	32
• Title Menu	32
• Disc Menu	32
• Camera Angle	32
• Changing the Audio Language	32
• Changing the Audio Channel	33
• 3D Surround	33
• Subtitles	33
• Commercial Skip	33
• Finding Locations on a Disc	33
• Last Condition Memory	33
Audio CD and MP3 Operation	34-35
Playing an Audio CD or MP3 Disc	34
Notes on MP3 Recordings	34
• Pause	35
• Moving to Another Track	35
• Repeat Track/All/Off	35
• Random	35
• Intro Scan	35
• 3D Surround	35
• Search	35
• Repeat A-B	35
Programmed Playback with Audio CD and MP3	36

RECORDING

Basic Recording	37
Basic Recording from a TV	37
Instant Timer Recording	37
Timer Recording	38
Checking Timer Recording Details	38
Canceling a Timer Recording	38
Stopping a Timer Recording in Progress	38
Timer Recording Troubleshooting	38
Recording from an External Input	39-40
Recording from External Components	39
Recording from a Digital Camcorder	39
Recording from the DV output	39
Playing your recordings on other DVD players	39
• Finalizing a Disc	39
What is DV?	40
• DV-Related Messages	40
• Troubleshooting	40



EDITING

VR Mode: Original and Playlist Editing	41-45
Titles and Chapters	41
Adding Chapter Markers	41
Using the Title List	41
Naming a Title	42
Using the Chapter List	42
Making a New Playlist (Program)	43
Adding Additional Title/Chapters to the Playlist (Program)	43
Changing Title or Chapter Thumbnails	44
Using the Playlist (Program)	44
Erasing an Original or Playlist Title/Chapter	44
Combining Two Chapters Into One	45
Moving a Playlist Chapter	45
Erasing a Section	45
Video Mode Original editing	46
Using the Title List	46
If the disc has already been finalized	46
Erasing a Title	46

REFERENCE

Language Code List	47
Country Code List	48
Troubleshooting	49-50
Specifications	51
Warranty	Back Cover

About the symbols for instructions

-  Indicates hazards likely to cause harm to the unit itself or other material damage.
-  Indicates special operating features of this unit.
-  Indicates tips and hints for making the task easier.

DVR313 Overview

Recordable Discs



12cm/8cm, single-sided, single layer disc
Approx. max. recording time (LQ mode):
240 minutes (4.7GB), 80 minutes (1.46GB)



12cm/8cm, single-sided, single layer disc
Approx. max. recording time (LQ mode):
240 minutes (4.7GB), 80 minutes (1.46GB)

Notes

- This recorder cannot record CD-R or CD-RW discs.
- DVD-R/RW and CD-R/RW discs recorded using a personal computer or a DVD or CD recorder may not play if the disc is damaged or dirty, or if there is dirt of condensation on the recorder's lens.
- If you record a disc using a personal computer, even if it is recorded in a compatible format, there are cases in which it may not play because of the settings of the application software used to create the disc. (Check with the software publisher for more detailed information.)

Playable Discs



DVD
(8 cm/12 cm disc)



Video CD (VCD)
(8 cm / 12 cm disc)



Audio CD
(8 cm/12 cm disc)

In addition, this unit can play a CD-R or CD-RW that contains audio titles or MP3 files, DVD-R, DVD-RW, and SVCD.

Notes

- Depending on the conditions of the recording equipment or the CD-R/RW (or DVD-R/RW) disc itself, some CD-R/RW (or DVD-R/RW) discs cannot be played on the unit.
- Do not attach any seal or label to either side (the labeled side or the recorded side) of a disc.
- Do not use irregularly shaped CDs (e.g., heart-shaped or octagonal). Doing so may result in malfunctions.

Regional code of the DVD Recorder and DVDs

This DVD Recorder is designed and manufactured for playback of Region 1 encoded DVD software. The region code on the labels of some DVD discs indicates which type of DVD Recorder can play those discs. This unit can play only DVD discs labeled 1 or ALL. If you try to play any other discs, the message "Incorrect region code. Can't playback" will appear on the TV screen. Some DVD discs may not have a region code label even though their playback is prohibited by area limits.



Notes on DVDs and Video CDs

Some playback operations of DVDs and Video CDs may be intentionally fixed by software manufacturers. As this unit plays DVDs and Video CDs according to disc content designed by the software manufacturer, some playback features of the unit may not be available or other functions may be added.

Refer also to the instructions supplied with the DVDs and Video CDs. Some DVDs made for business purposes may not be played on the unit.

Disc-related terms

Title (DVD only)

The main film content or accompanying feature content or music album.

Each title is assigned a title reference number enabling you to locate it easily.

Chapter (DVD only)

Sections of a picture or a musical piece that are smaller than titles. A title is composed of one or several chapters. Each chapter is assigned a chapter number to enable you to locate the chapter you want. Depending on the disc, chapters may not be labeled.

Track (Video CD and audio CD only)

Sections of a picture or a musical piece on a video CD or an audio CD. Each track is assigned a track number, enabling you to locate the track you want.

Scene

On a video CD with PBC (Playback control) functions, moving pictures and still pictures are divided into sections called "Scenes". Each scene available is displayed on the Scene menu and assigned a scene number, enabling you to locate the scene you want.

A scene may be composed of one or several tracks.

Types of video CDs

There are two types of video CDs:

Video CDs equipped with PBC (Version 2.0)

PBC (Playback control) functions allow you to interact with the system via menus, search functions, or other typical computer-like operations. Moreover, high resolution still pictures can be played if they are included on the disc.

Video CDs not equipped with PBC (Version 1.1)

Operated in the same way as audio CDs, these discs allow playback of video pictures as well as sound, but they are not equipped with PBC.

DVR313 Overview

About DVD-R and DVD-RW disc

How are DVD-R and DVD-RW discs different?

The essential difference between DVD-R and DVD-RW is that DVD-R is a record-once medium, while DVD-RW is a re-recordable/erasable medium. You can re-record/erase a DVD-RW disc approximately 1,000 times.

Can I play my recordable discs in a regular DVD player?

Generally, DVD-R discs and DVD-RW discs recorded in Video mode are playable in a regular DVD player, but they must be 'finalized' first. This process fixes the contents of the disc to make them readable to other DVD players as DVD-Video discs. DVD-RW discs recorded in VR (Video Recording) mode are playable in some players.



This indicates a product feature that is capable of playing DVD-RW discs recorded with Video Recording format.

What are 'recording modes'?



There are two recording modes available using this recorder: VR mode and Video mode. When recording to a DVD-R disc, recordings are always in Video mode. DVD-RW discs can be formatted for VR mode recording or Video mode recording.

VR mode recording

- 3 different picture quality/recording time settings available (HQ, SQ, LQ)
- Not playable on regular DVD players
- Recordings can be extensively edited

Video mode recording

- 3 different picture quality/recording time settings available (HQ, SQ, LQ)
- Playable on regular DVD players (after finalizing)
- Limited editing features

Many functions of this recorder are dependent on the recording mode. One or more of the symbols ( , ) appear by each function explained in this manual so that you can see at a glance whether it's relevant for the disc loaded.

You can find more information on disc formats and recording modes on next page.

Note

DVD-Video Format (Video mode) is a new format for recording on DVD-R/RW discs that was approved by the DVD Forum in 2000. You may therefore experience problems playing recordable DVD discs in some players. Symptoms include video artifacts, audio and/or video dropouts and playback suddenly stopping. Our company cannot take responsibility for problems playing discs recorded on this recorder in other players.

Is editing a DVD like editing a video tape?

No. When you edit a video tape you need one video deck to play the original tape and another to record the edits. With DVD, you edit by making a 'Playlist' of what to play and when to play it. On playback, the recorder plays the disc according to the Playlist.

About word 'Original' and 'Playlist'

Throughout this manual, you will often see the words Original and Playlist to refer to the actual content and the edited version.

- **Original:** content refers to what's actually recorded on the disc.
- **Playlist:** content refers to the edited version of the disc — how the Original content is to be played.

About DVD recording

Notes

- This recorder cannot make recordings on CD-R or CD-RW discs.
- Our company takes no responsibility for recording failure due to power cuts, defective discs, or damage to the recorder.
- Fingerprints and small scratches on a disc can affect playback and/or recording performance. Please take proper care of your discs.

Disc types and recording formats, modes, and settings

This recorder can play three different kinds of DVD disc: pre-recorded DVD-Video discs, DVD-RW and DVD-R discs. The disc format for DVD-R discs is always "Video format"—the same as pre-recorded DVD-Video discs. This means that once finalized, you can play a DVD-R in a regular DVD player.

By default, the DVD-RW disc format is Video Recording format, though you can change this to Video format, if required. (Reinitializing the disc will erase the contents of the disc.)

The recording mode is closely related to the disc format. If the disc format is Video Recording format, then the recording mode is VR mode; if the disc format is Video mode, then the recording mode is Video mode (except for DVD-Video, which is not recordable, and so does not have a recording mode).

Within the recording modes (which are fixed for the whole disc) are the record settings. These can be changed as required for each recording and determine the picture quality and how much space the recording will take up on the disc.

DVR313 Overview

Notes for recording

- The recording times shown are not exact because the recorder uses variable bit-rate video compression. This means that the exact recording time will depend on the material being recorded.
- When recording a TV broadcast, if the reception is poor or the picture contains interference, the recording times may be shorter.
- If you record still pictures or audio only, the recording time may be longer.
- The displayed times for recording and time remaining may not always add up to exactly the length of the disc.
- The recording time available may decrease if you heavily edit a disc.
- If using a DVD-RW disc, make sure you change the recording format (Video mode or VR mode) before you record anything on the disc. See page 25 (Initialize) for how to do this.
- When using a DVD-R disc, you can keep recording until the disc is full, or until you finalize the disc. Before you start a recording session, check the amount of recording time left on the disc.
- When using a DVD-RW disc in Video mode, recording time available will only increase if you erase the last title recorded on the disc.
- The Erase Title option in the Title List screen only hides the title, it does not actually erase the title from the disc and increase the recording time available (except for the last recorded title on a DVD-RW disc in Video mode).

Recording TV audio channels

This recorder can record one or two channel audio. For TV broadcasts, this usually means mono or stereo, but some programs are broadcast with a main and a SAP (Secondary Audio Program) audio channel. If you're recording in Video mode (or in VR mode), you can record either the main audio or the SAP audio.

Restrictions on video recording

- You cannot record copy-protected video using this recorder. Copy-protected video includes DVD-Video discs and some satellite broadcasts. If copy-protected material is encountered during a recording, recording will pause or stop automatically and an error message will be displayed on-screen.
- Video that is 'copy-once only' can only be recorded using a DVD-RW disc in VR mode with CPRM (see below).

What is 'CPRM'?

CPRM is a copy protection system (with scramble system) only allowing the recording of 'copy once' broadcast programs. CPRM stands for Content Protection for Recordable Media.

This recorder is CPRM compatible, which means that you can record copy-once broadcast programs, but you cannot then make a copy of those recordings. CPRM recordings can only be made on DVD-RW discs formatted in VR mode, and CPRM recordings can only be played on players that are specifically compatible with CPRM.

Copyright

- Audio and video recordings you make using this recorder are for your personal use only. You may not sell, lend or rent them to other people.
- This product incorporates copyright protection technology that is protected by method claims of certain U.S. patents and other intellectual property rights owned by Macrovision Corporation and other rights owners. Use of this copyright protection technology must be authorized by Macrovision Corporation, and is intended for home and other limited viewing uses only unless otherwise authorized by Macrovision corporation. Reverse engineering or disassembly is prohibited.

Disc type	Disc format	Recording mode	Functions
DVD-Video	Video format	n/a	Playback only
DVD-RW	Video Recording format (default)	VR mode	Playback, recording, Original/Playlist editing
	Video format	Video mode	Playback, limited recording, limited editing
DVD-R	Video format	Video mode	Playback, limited recording, limited editing

DVR313 Overview (Continued)

Precautions

Handling the unit

When shipping the unit

The original shipping carton and packing materials come in handy. For maximum protection, re-pack the unit as it was originally packaged at the factory.

When setting up the unit

The picture and sound of a nearby TV, VCR, or radio may be distorted during playback. In this case, position the unit away from the TV, VCR, or radio, or turn off the unit after removing the disc.

To keep the surface clean

Do not use volatile liquids, such as insecticide spray, near the unit. Do not leave rubber or plastic products in contact with the unit for a long period of time. They will leave marks on the surface.

Cleaning the unit

To clean the cabinet

Use a soft, dry cloth. If the surfaces are extremely dirty, use a soft cloth lightly moistened with a mild detergent solution. Do not use strong solvents such as alcohol, benzene, or thinner, as these might damage the surface of the unit.

To obtain a clear picture

The DVD Recorder is a high-tech, precision device. If the optical pick-up lens and disc drive parts are dirty or worn, the picture quality will be poor.

Regular inspection and maintenance are recommended after every 1,000 hours of use. (This depends on the operating environment.)

For details, please contact your nearest dealer.

Remote Control Operation Range

Point the remote control at the remote sensor and press the buttons.

- **Distance:** About 23 ft (7 m) from the front of the remote sensor.
- **Angle:** About 30° in each direction of the front of the remote sensor.

Remote Control Battery Installation

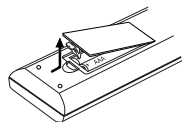

Detach the battery cover on the rear of the remote control, and insert two R03 (size AAA) batteries with + and - aligned correctly.



Caution
Do not mix old and new batteries. Never mix different types of batteries (standard, alkaline, etc.).

Notes on Discs

Handling discs

Do not touch the playback side of the disc. Hold the disc by the edges so that fingerprints will not get on the surface. Do not stick paper or tape on the disc.



Storing discs

After playing, store the disc in its case.

Do not expose the disc to direct sunlight or sources of heat, or leave it in a parked car exposed to direct sunlight, as there may be a considerable temperature increase inside the car.

Cleaning discs

Fingerprints and dust on the disc can cause poor picture quality and sound distortion. Before playing, clean the disc with a clean cloth. Wipe the disc from the center outward.

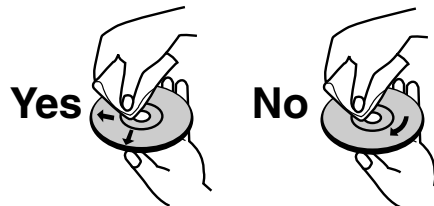

Do not use strong solvents such as alcohol, benzene, thinner, commercially available cleaners, or anti-static spray intended for older vinyl records.







About Symbols

About the symbol display

" " may appear on the TV screen during operation. This icon means the function explained in this owner's manual is not available on that specific disc.

About the disc symbols for instructions

A section whose title has one of the following symbols are applicable only to those discs represented by the symbol.

-  DVD-R/RW with Video recording mode
-  DVD-RW with VR recording mode
-  DVD-Video disc
-  Video CDs with the PBC (playback control) function.
-  Video CDs without the PBC (playback control) function.
-  Audio CDs.
-  MP3 Discs.

Front Panel

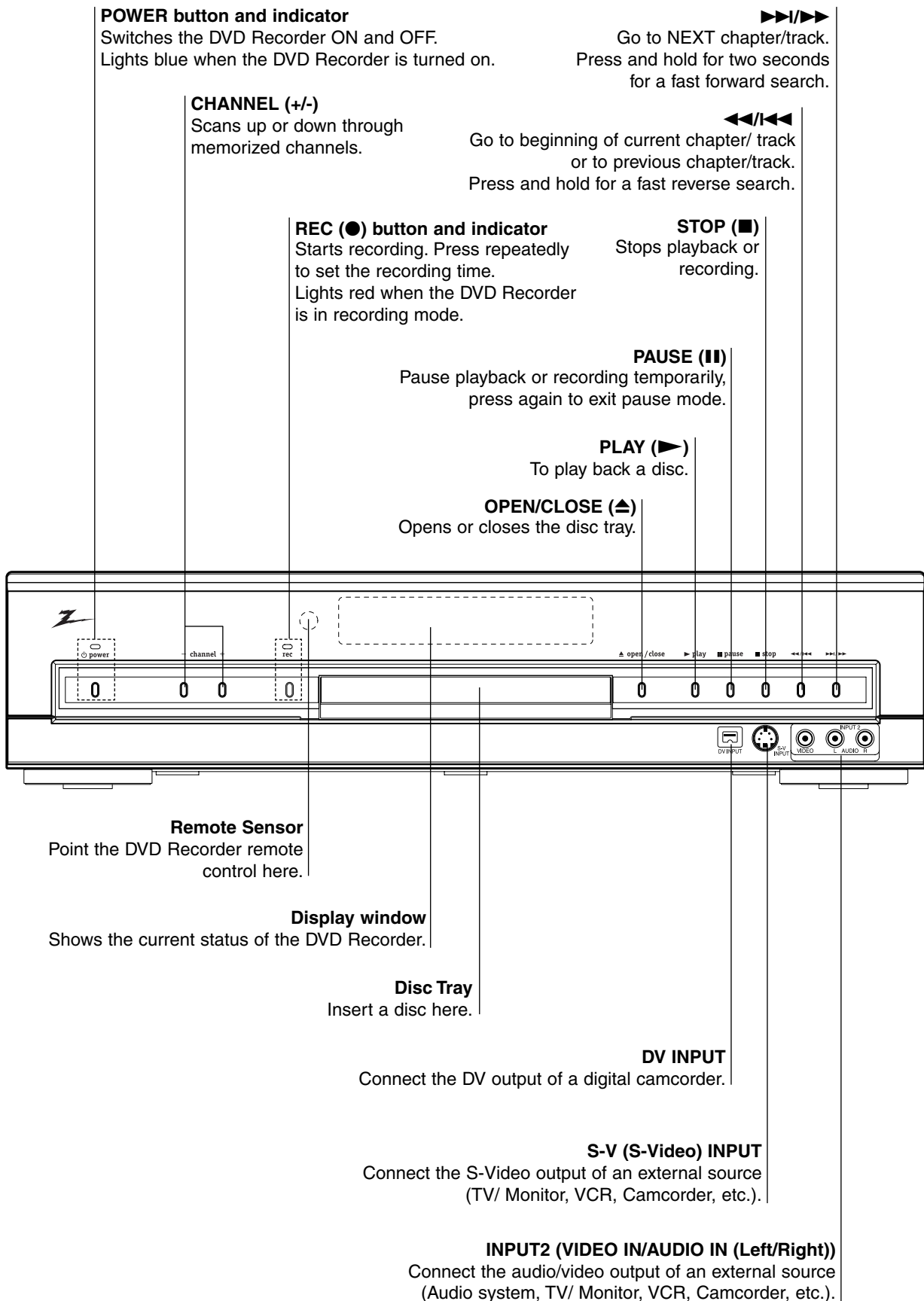

Function Display Window

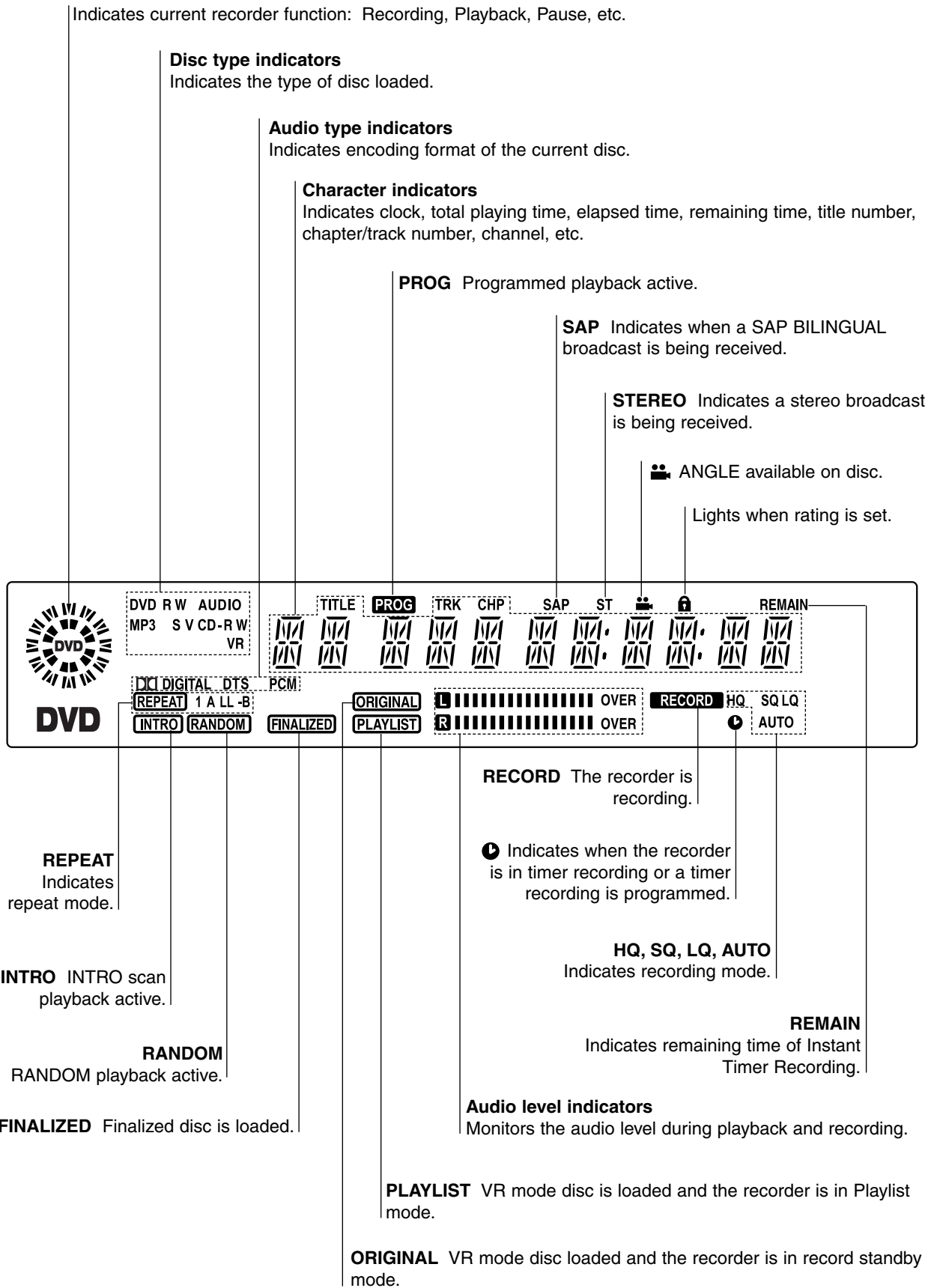

Remote Control Overview

POWER
Switches the DVD Recorder ON and OFF.

INPUT
Changes the input to use for recording (Tuner, AV INPUT 1 - 2, S-V, or DV IN).

TV, CATV, DVD buttons
Selects operational mode of remote control.

0-9 numerical buttons
Selects numbered options in a menu.

CH ADD/DEL
Add or erase channels manually from memory.

PLAY (▶)
Starts playback.

STOP (■)
Stops playback or recording.

SKIP/SCAN (▶▶)
Search forward*/go to next chapter or track.

SKIP/SCAN (◀◀)
Search backward*/go to beginning of current chapter or track or go to previous chapter or track.

* Press and hold button for about two seconds.

SLOW (I▶)
Forward slow playback.

PAUSE (II)
Pause playback or recording temporarily, press again to exit pause mode.

SLOW (◀I)
Reverse slow playback.

◀▶▲▼ (left/right/up/down)
- Selects an option in the menu.
- **CH (▲ / ▼)**: Selects the channel.
- **VOL (◀ / ▶)**: Changes volume of TV.

ENTER
- Acknowledges menu selection.
- Displays information while viewing a TV program.

REC (●)
Starts recording. Press repeatedly to set the recording time.

REC MODE
Selects the recording mode: HQ, SQ, or LQ.

TIMER REC
Displays Timer Record menu.

CHP.MARK (Chapter Mark)
Inserts a chapter marker when playing/recording a VR mode DVD-RW disc.

THUMBNAIL
Selects a thumbnail picture for the current title for use in the Title List

ZOOM
Enlarges DVD video image.

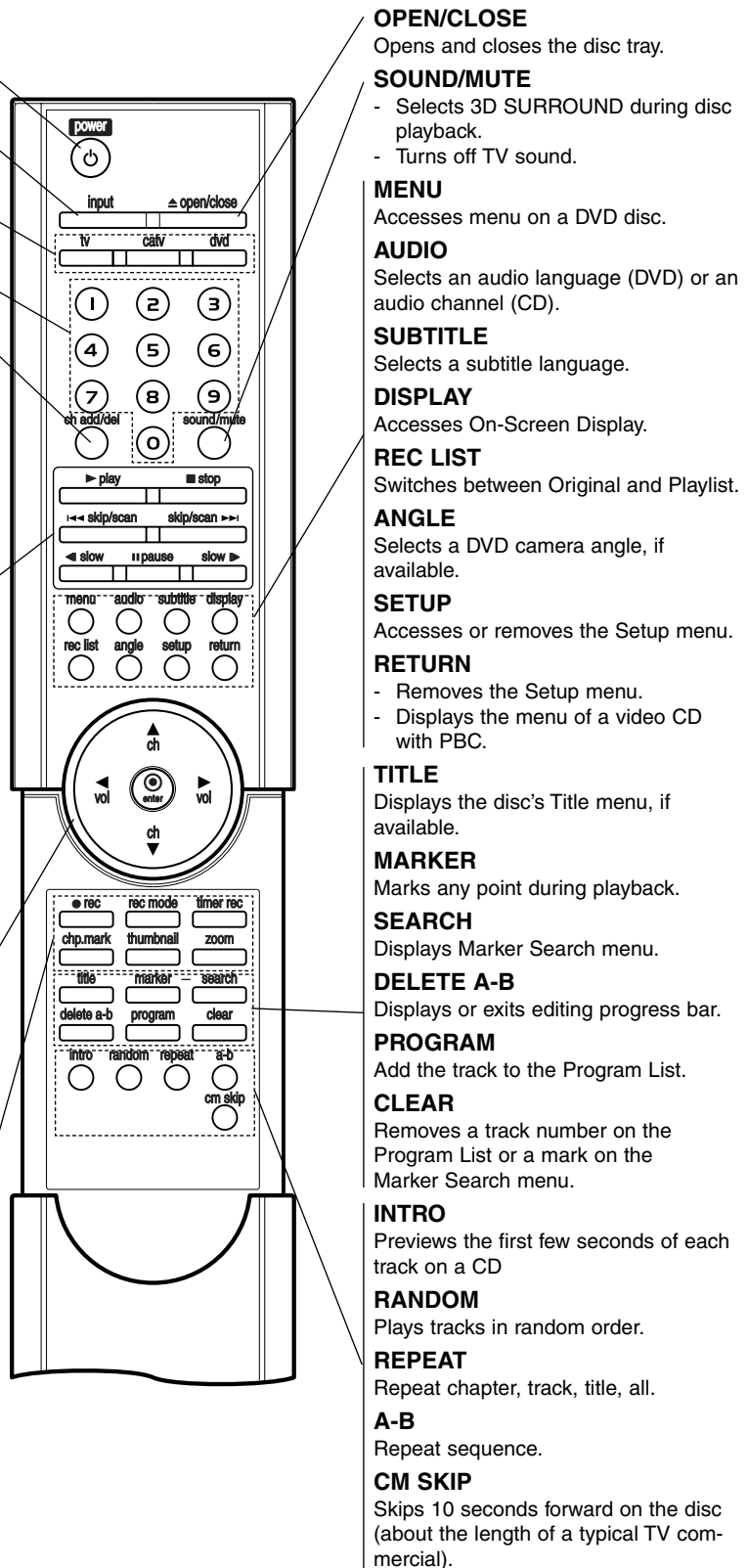

OPEN/CLOSE
Opens and closes the disc tray.

SOUND/MUTE
- Selects 3D SURROUND during disc playback.
- Turns off TV sound.

MENU
Accesses menu on a DVD disc.

AUDIO
Selects an audio language (DVD) or an audio channel (CD).

SUBTITLE
Selects a subtitle language.

DISPLAY
Accesses On-Screen Display.

REC LIST
Switches between Original and Playlist.

ANGLE
Selects a DVD camera angle, if available.

SETUP
Accesses or removes the Setup menu.

RETURN
- Removes the Setup menu.
- Displays the menu of a video CD with PBC.

TITLE
Displays the disc's Title menu, if available.

MARKER
Marks any point during playback.

SEARCH
Displays Marker Search menu.

DELETE A-B
Displays or exits editing progress bar.

PROGRAM
Add the track to the Program List.

CLEAR
Removes a track number on the Program List or a mark on the Marker Search menu.

INTRO
Previews the first few seconds of each track on a CD

RANDOM
Plays tracks in random order.

REPEAT
Repeat chapter, track, title, all.

A-B
Repeat sequence.

CM SKIP
Skips 10 seconds forward on the disc (about the length of a typical TV commercial).

Controlling TVs and Cable Boxes (DBS)

Your remote control operates the common features of most, but not all, models and brands of IR (infrared) controlled cable converters (DBS) and TVs.

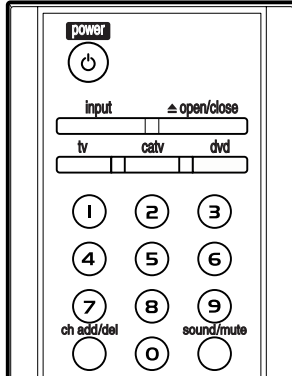

Note

Due to the variety of codes used by manufacturers, our company cannot guarantee this remote control will operate with every model of the brands listed.

Programming the Remote

- 1 In the chart, find the code corresponding to your brand of operational device.
- 2 While holding down the TV or CATV button, press 2 number buttons (0 - 9) to enter the code.

Some manufacturers have more than one code number. If the remote control does not operate the Cable box (DBS), or TV after setting a code number, try a different code.

Buttons used to operate the CATV (DBS)

POWER, Number (0 - 9), INPUT, CH (Channel) ▲ / ▼, and VOL (Volume) ◀ / ▶ buttons on the remote control are activated.

Buttons used to operate the TV

POWER, Number (0 - 9), INPUT, CH (Channel) ▲ / ▼, VOL (Volume) ◀ / ▶ and SOUND (MUTE) buttons on the remote control are activated.

TV MBR CODES BY BRAND

TV Brand Name	Codes	TV Brand Name	Codes
ADMIRAL	16,33,37,44,45	MONTGOMERY	01,06,08,09,
AIWA	70	WARD	23,24,32,33,34
AKAI	01	NEC	01,08
AMARK	09	NOBLEX	07
AOC	01	PACKARD BELL	43
BELL & HOWELL	33	PANASONIC	07,11,13,25,35,36
BROKSONIC	18,19	PHILCO	01,06,07,08,09,
CANDLE	51		15,38,43,58
CCE	07	PHILIPS	06,07,43,61,62,65
CENTURION	08	PIONEER	30
CINERAL	43	PORTLAND	09
CITIZEN	49,50,51,52,53,54,55	PROSCAN	03,37,44
CORONADO	09	QUASAR	11,13
CROWN	09	RADIO SHACK	16,17,23
CURTIS MATHES	01,03,08,33,35,37,44	RCA	01,03,37,44,69
DAEWOO	16,38,39,40,41,42,43	REALISTIC	16,17,23
DAYTRON	01,08	SAMPO	08
EMERSON	01,09,16,17,18,19	SAMSUNG	01,08,09,25,68
FISHER	28,29	SANYO	28,29
FUNAI	46,47	SCOTT	01,08
GENERAL ELECTRIC	03,10,11,13,37,44	SEARS	09,25,26,27,28,29
GRADIENTE	01,56,57,63,67	SEMP	64
HITACHI	09,14,15,43	SHARP	09,22,23,24,60,66
JC PENNEY	01,08,10,27,35	SIGNATURE 2000	01,06,08,09,10,
JVC	20,21,63,67		23,24,33,34
KIOTE	43	SONY	12,62
KMC	09	SOUNDESIGN	51
KTV	01,08,09,31	SYLVANIA	01,04,05,06,07,
LG (GOLDSTAR)	01,07,08,09,35,39,40		08,35,51
LODGENET	33	SYMPHONIC	46,47
LOGIK	33	TATUNG	11
LXI	09,24,25,26,27,28,29	TEKNIKA	07,09,16,33,51
MAGNAVOX	01,02,04,05,06,	TELERENT	09,33
	07,08,09,20,	THOMSON	69
	34,35,43,51,61,62,65	YORX	08
MAJESTIC	33	TOSHIBA	01,25,26,27,64
MARANTZ	01,32	WARDS	01,06,08,09,10,33,34
MEMOREX	33	XR1000	48
MGA/MITSUBISHI	01,08,32,34	ZENITH	02,33,59

CATV (DBS) MBR CODES BY BRAND

Cable Decoder Brand Name	Codes	Cable Decoder Brand Name	Codes
ALLEGRO	46	SCIENTIFIC ATLANTA	10,15,16,45,48
ARCHER	39	SLMARX	04,13
CABLEVIEW	39	SONY	49
CITIZEN	39	SPRUCER	04,13,19
CURTIS MATHES	15	STANDARD	29
EAGLE	24,25,28	COMPONENTS	
GEMINI	04,05,22,23	STARGATE	04,05,13
GENERAL ELECTRIC	43	TELEVIEW	04,13,39
GENERAL INSTRUMENT	04,05,07,09	TEXSCAN	31
GOBRAND	39	TOCOM	12,17,18,19,38
HAMLIN	33,34,35	UNIDEN	20
JERROLD	04,06,07,08,09,10,	UNIKA	39
	17,39	UNIVERSAL	46,47
KALEVISION	29	VID TECH	30
MACOM	03,40,41	VIDEO WAY	01,42
MAGNAVOX	24,25,28,29,36,37	VIEWSTAR	24,25,28
NSC	38	ZENITH	01,02,03
OAK	11,12,44	ZENITH HT-2000	01
PANASONIC	13,19,21	DBS Brand Name Codes	
PARAGON	01	DIRECTU	66
PHILIPS	24,25,26,27,28	EASTERN	57
PIONEER	13,14	GRADIENTE SKY	56
PLUSER	39	JERROLD	60,61,65
RCA	13,50	RCA	50
REGAL	28	SCIENTIFIC ATLANTA	58
REGENCY	32	SONY	49
SAMSUNG	04,13,29	TOCOM	58,59,62

Rear Panel

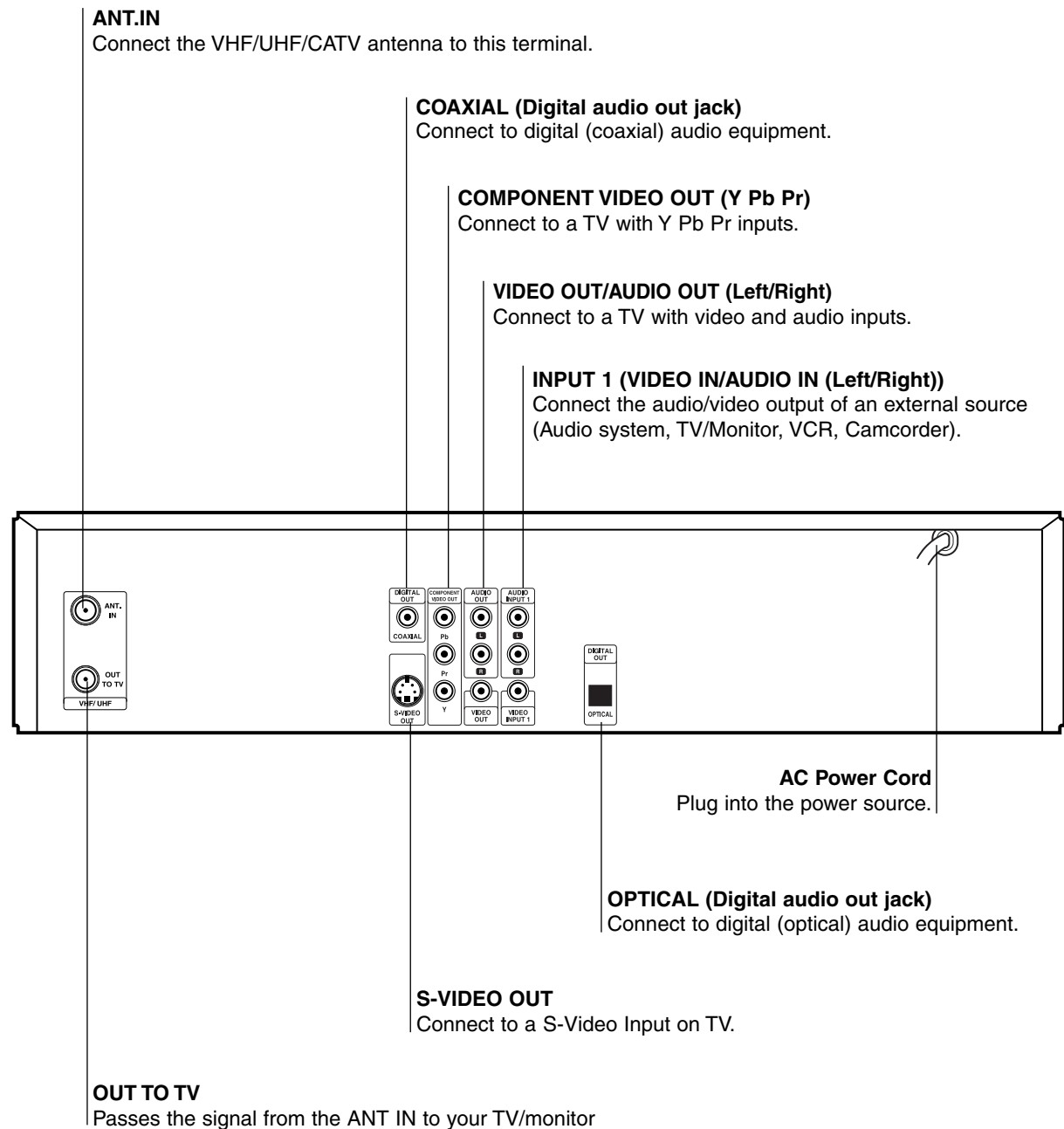

Caution

Do not touch the inner pins of the jacks on the rear panel. Electrostatic discharge may cause permanent damage to the unit.

Connections

Connecting Antenna/Cable TV to DVD Recorder

- 1** Disconnect the antenna leads from the rear of the TV.
- 2** Identify the type of cable from your antenna. If it is a round cable as illustrated, it is a 75 ohm coaxial antenna cable. This cable will connect directly to the jack marked ANT.IN on your DVD Recorder.

Tip

If your antenna lead wire is a flat type antenna cable, connect it to an Antenna Adapter (300-ohm to 75-ohm) (not supplied) and slip the Adapter onto the ANT.IN jack. The Adapter does not screw on to the DVD Recorder, it just slips over the jack.

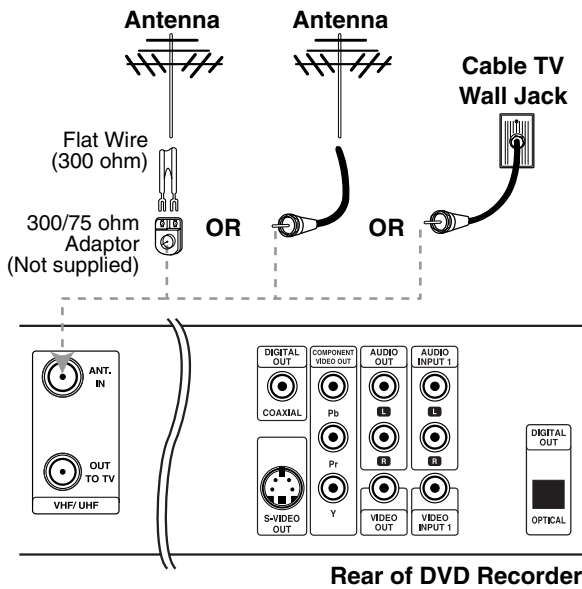

Cable Service Without Cable Box

If your cable wire is connected to your TV without a converter or descrambler box, unscrew the wire from your TV and attach it to the ANT.IN jack on the DVD Recorder. Use the supplied round coaxial cable to connect between the DVD Recorder's OUT TO TV jack and the 75 ohm antenna input jack on the TV. With this connection, you can receive all midband, super band, and hyperband channels. (All cable channels.)

Cable Service With Cable Box

If a converter is required in your cable system, follow the instruction below:

The cable hookup permits both TV and DVD Recorder operation.

To view or record a CATV channel

- 1** Tune the TV to the correct video input channel.
- 2** Set the DVD Recorder channel selector to the output channel of the Cable Converter box using CH (\blacktriangle / \blacktriangledown) or number (0-9) of your DVD Recorder. (Example: CH3)
- 3** Select the channel to view at the Cable Converter Box.

Note

If you are using a cable box to tune channels, it is not necessary to do EZ Channel Scan as indicated on page 19.

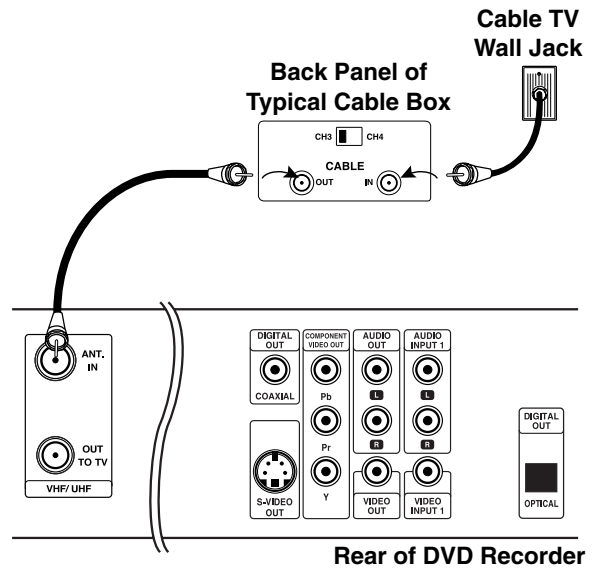

Connections (Continued)

Tips

- Depending on your TV and other equipment you wish to connect, there are various ways you could connect the recorder. Use only one of the connections described below.
- Please refer to the manuals of your TV, VCR, Stereo System or other devices as necessary to make the best connections.
- For better sound reproduction, connect the recorder's AUDIO OUT jacks to the audio in jacks of your amplifier, receiver, stereo or audio/video equipment. See "Connecting to Optional Equipment" on page 17.

Caution

- Make sure the DVD Recorder is connected directly to the TV. Tune the TV to the correct video input channel.
- Do not connect the DVD Recorder's AUDIO OUT jack to the phono in jack (record deck) of your audio system.
- Do not connect your DVD Recorder via your VCR. The DVD image could be distorted by the copy protection system.

Connecting to a TV

- Make one of the following connections, depending on the capabilities of your existing equipment.

RF coaxial connection

Connect the OUT TO TV jack on the DVD Recorder to the antenna in jack on the TV using the 75-ohm Coaxial Cable supplied (R). The OUT TO TV jack passes the signal through from the ANT IN jack.

Video connection

- 1 Connect the VIDEO OUT jack on the DVD Recorder to the video in jack on the TV using the video cable (V).
- 2 Connect the Left and Right AUDIO OUT jacks from the DVD Recorder to the audio left/right in jacks from the TV using the audio cables (A).

S-Video connection

- 1 Connect the S-VIDEO OUT jack on the DVD Recorder to the S-Video in jack on the TV using the S-Video cable (S).
- 2 Connect the Left and Right AUDIO OUT jacks from the DVD Recorder to the audio left/right in jacks on the TV using the audio cables (A).

Component Video (Color Stream®) connection

- 1 Connect the COMPONENT VIDEO OUT jacks on the DVD Recorder to the corresponding in jacks on the TV using an Y Pb Pr cable (C).
- 2 Connect the Left and Right AUDIO OUT jacks from the DVD Recorder to the audio left/right in jacks on the TV using the audio cables (A).

Progressive Scan (ColorStream® pro) connection

- If your television is a high-definition or "digital ready" television, you may take advantage of the DVD Recorder's progressive scan output for the highest video resolution possible.
- If your TV does not accept the Progressive Scan format, the picture will appear scrambled if you try Progressive Scan on the DVD Recorder.

- 1 Connect the COMPONENT VIDEO OUT jacks on the DVD Recorder to the corresponding in jacks on the TV using an optional Y Pb Pr cable (C).
- 2 Connect the Left and Right AUDIO OUT jacks from the DVD Recorder to the audio left/right in jacks on the TV using the supplied audio cables (A).

Notes

- Set Progressive Scan option to "ON" in the Setup menu, see page 21.
- Progressive scan does not work with the analog video connection (yellow VIDEO OUT jack).

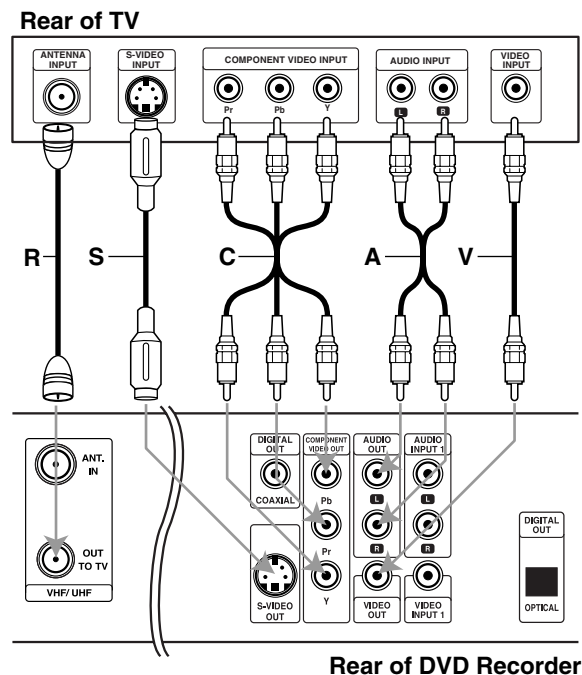

Connections (Continued)

Connecting to Optional Equipment

Connecting to an amplifier equipped with two channel analog stereo or Dolby Pro Logic II/ Pro Logic

Connect the Left and Right AUDIO OUT jacks on the DVD Recorder to the audio left and right in jacks on your amplifier, receiver, or stereo system, using the audio cables (A).

Connecting to an amplifier equipped with two channel digital stereo (PCM) or to an Audio/ Video receiver equipped with a multi-channel decoder (Dolby Digital™, MPEG 2, or DTS)

- 1 Connect one of the DVD Recorder's DIGITAL AUDIO OUT jacks (OPTICAL O or COAXIAL X) to the corresponding in jack on your amplifier. Use an optional digital (optical O or coaxial X) audio cable.
- 2 You will need to activate the recorder's digital output. (See "Audio" on page 22).

Digital Multi-channel sound

A digital multi-channel connection provides the best sound quality. For this you need a multi-channel Audio/Video receiver that supports one or more of the audio formats supported by your DVD Recorder (MPEG 2, Dolby Digital and DTS). Check the receiver manual and the logos on the front of the receiver.



Caution:

Due to the DTS Licensing agreement, the digital output will be in DTS digital out when DTS audio stream is selected.

Notes

- If the audio format of the digital output does not match the capabilities of your receiver, the receiver will produce a strong, distorted sound or no sound at all.
- Six Channel Digital Surround Sound via digital connection can only be obtained if your receiver is equipped with a Digital Multi-channel decoder.
- To see the audio format of the current DVD in the on-screen display, press AUDIO.

Note

This recorder does not perform internal (2 channel) decoding of a DTS sound track. To enjoy DTS multi channel surround, you must connect this recorder to a DTS compatible receiver via one of this recorder's digital audio outputs.

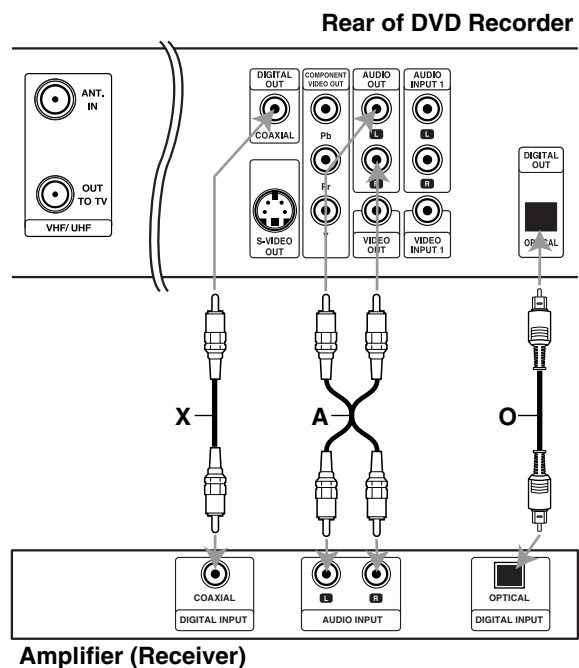

Connections (Continued)

Accessory Audio/Video (A/V) Connections to DVD Recorder

Connect the INPUT 1 or INPUT 2 jacks on the DVD Recorder to the audio/video out jacks on your accessory component, using optional audio/video cables.

Note

If you use the S-V INPUT jack on the front panel, the signal of VIDEO OUT jack on the front panel is not output.

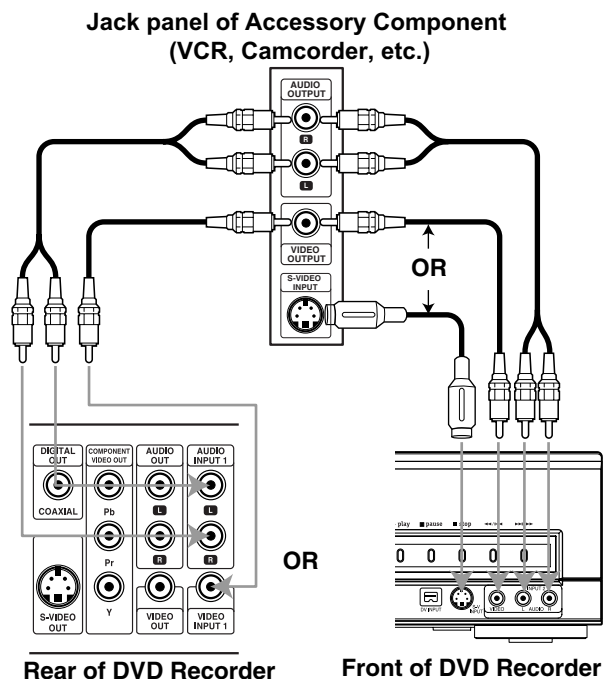

Connecting a Digital Camcorder

Using the front panel DV IN jack, it is possible to connect a DV digital camcorder or video deck or DVD-R/RW recorder and digitally transfer DV tapes or DVD-R/RW discs to DVD-R/RW.

Use a DV cable (not supplied) to connect the DV in/out jack of your DV camcorder/video deck to the front panel DV IN jack of this recorder.

Note

This jack is for connection to DV equipment only. It is not compatible with digital satellite tuners or D-VHS video decks.

DV Digital Camcorder

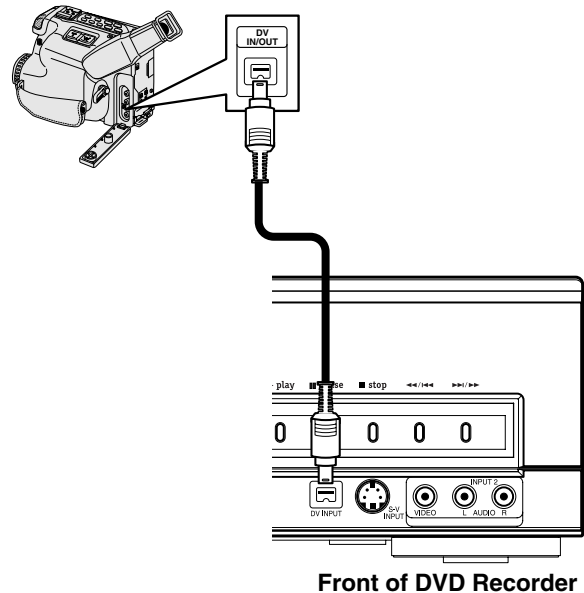

Before Operation

Initial Settings

In this menu system, there are several ways to customize the settings provided. Most menus consist of three levels to set up the options, but some require greater depth for the variety of settings. If you press SETUP, only the first and second level of the menu system will appear on the TV screen. The third level can be displayed by pressing ►. For navigating the menu levels, you will see "►" on the right side of the menu label to help you go to the next level.

To bring up and exit the Menu:

Press SETUP to bring up the menu. A second press of SETUP will take you back to initial screen.

To go to the next level:

Press ► on the remote control.

To go back to the previous level:

Press ◀ on the remote control.

General Operation

- 1 Press SETUP.**
The Setup menu appears.
- 2 Use ▲ / ▼ to select the desired option.**
- 3 While the desired item is selected, press ► to move to the second level.**
- 4 Use ▲ / ▼ to select the second desired option.**
- 5 Press ► to move to the third level.**
- 6 Use ▲ / ▼ to select the desired setting then press ENTER to confirm your selection.**
Some items require additional steps.
- 7 Press SETUP to exit the Setup menu.**

Setup

EZ Channel Scan

This DVD Recorder is equipped with a frequency synthesized tuner capable of receiving up to 181 channels. These include VHF channels 2-13, UHF channels 14-69 and CATV channels 1-125.

Preparation:

- Connect the DVD Recorder to the desired type of antenna or cable TV system, as shown in Connecting Antenna/Cable TV to DVD Recorder on page 15.

- 1 Press SETUP.**
The Setup menu appears.
- 2 Use ▲ / ▼ to select the Setup option.**

- 3 While the Setup option is selected, press ► to move to the second level.**
- 4 Use ▲ / ▼ to select the EZ Channel Scan option.**
- 5 Press ► to move to the third level.**
SET icon is highlighted.
- 6 Press ENTER to begin the channel search.**
The tuner will automatically cycle through all available channels in the area and place them in the tuner's memory.

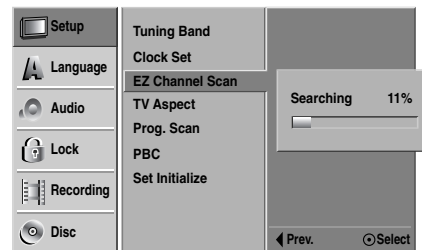

Tuning Band

After the EZ Channel Scan is complete, make sure the TV INPUT is set appropriately (TV or CATV). Remember, TV is for the air antenna reception, CATV is for cable or wireless cable connection.

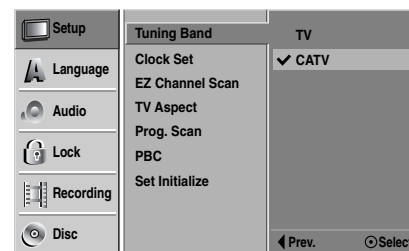

To Add or Erase Channels from Memory

To add channels to memory

This feature allows you to add to or erase channels from memory manually.

- 1 Use number (0-9) buttons to select a channel to add.**
The channel number flashes in the display window.
- 2 Press CH ADD/DEL to add the channel.**
Flashing of the channel number stops.
The channel is added to memory.

To erase channels from memory

- 1 Use CH (▲ / ▼) buttons to select a channel to erase.**
The channel number is displayed in the display window.
- 2 Use CH ADD/DEL to erase the channel.**
The channel number flashes in the display window.
The channel is erased from memory.

Before Operation

Auto Clock Set

The DVD Recorder gives you two ways to set the time and date: the Auto Clock Feature or manually. The Auto Clock Feature enables the DVD Recorder to set up the clock when the DVD Recorder is turned off or during PBS channel tuning.

The Clock Set feature is set to Auto at the factory. In the ON setting, the DVD Recorder looks for a channel carrying XDS (Extended Data Services) information. XDS updates the clock using the Coordinated Universal Time.

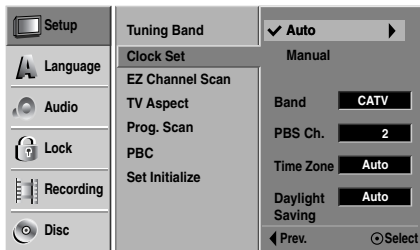

- 1 Press SETUP.**
The Setup menu appears.
- 2 Use ▲ / ▼ to select the Setup menu.**
- 3 While the Setup menu is selected, press ► to move to the second level.**
- 4 Use ▲ / ▼ to select the Clock Set option.**
- 5 Press ► to move to the third level.**
- 6 Use ▲ / ▼ to select the Auto option then press ENTER.**
The Auto option is set at the factory. In the Auto option, the DVD Recorder looks for a channel carrying XDS (Extended Data Services) information. XDS updates the clock using the Coordinated Universal Time.
- 7 Use ► to choose the BAND option.**
Use ▲ / ▼ to choose your TV BAND (TV or CATV).
- 8 Use ► to choose the PBS Ch. option.**
Use ▲ / ▼ to choose your local PBS channel.
- 9 Use ► to choose the Timezone option.**
Use ▲ / ▼ to choose your Time Zone.
You can set your local Time Zone manually. When Timezone is set to Auto, the DVD Recorder will use XDS information to determine the proper setting.
- 10 Use ► to choose the Daylight Saving option.**
Use ▲ / ▼ to choose Auto, On, or Off.
You can turn Daylight Savings On or Off manually. When it is set to Auto, the DVD Recorder will use XDS information to determine the proper setting.
- 11 Press ENTER to confirm your setting, then press SETUP to exit the Setup menu.**

Note

There are cases where the TV station does not send, or sends wrong date and/or time information and the DVD Recorder sets the incorrect time.

If this happens, we recommend that you set the clock manually.

Manual Clock Set

- 1 Follow steps 1-5 as shown above to the left (Auto Clock Set).**
- 2 Use ▲ / ▼ to select the Manual option then press ENTER.**

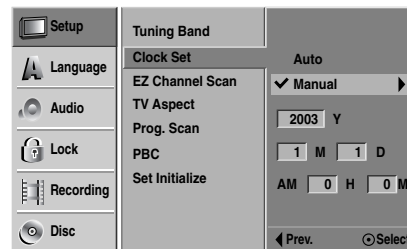

- 3 Enter the necessary information for date and time.**
◀ / ▶ (left/right): Moves the cursor to the previous or next column.
▲ / ▼ (up/down): Changes the setting at the current cursor position.
- 4 Press ENTER to confirm your setting, then press SETUP to exit the Setup menu.**

TV Aspect

- 4:3 Letter Box:** Select when a standard 4:3 TV is connected. Displays theatrical images with masking bars above and below the picture.
- 4:3 Pan Scan:** Select when a standard 4:3 TV is connected. Displays pictures cropped to fill your TV screen. Both sides of the picture are cut off.
- 16:9 Wide:** Select when a 16:9 wide TV is connected.

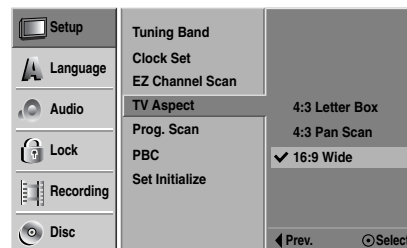

Before Operation

Progressive Scan

Progressive Scan Video provides the highest quality pictures with less flickering. If you are using the COMPONENT VIDEO OUT jacks, but are connecting the DVD recorder to a standard (analog) television, set Progressive Scan to OFF. If you are using the COMPONENT VIDEO OUT jacks for connection to a TV or monitor that is compatible with a progressive scan signal, set Progressive Scan to ON.

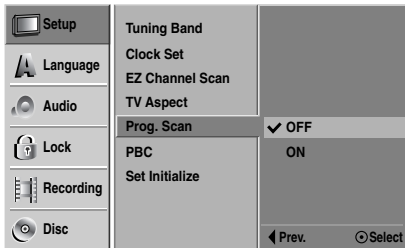

Caution

Once the setting for progressive scan output is entered, an image will only be visible on a progressive scan compatible TV or monitor. If you set Progressive Scan to ON in error, you must reset the unit. First, remove the disc in the DVD Recorder. Next, press STOP (■) again and hold it for five seconds before releasing it. The video output will be restored to the standard setting, and a picture will once again be visible on a conventional analog TV or monitor.

PBC

The PBC setting can be changed. Set Playback Control (PBC) to ON or OFF.

ON: Video CDs with PBC are played according to the PBC.

OFF: Video CDs with PBC are played the same way as Audio CDs.

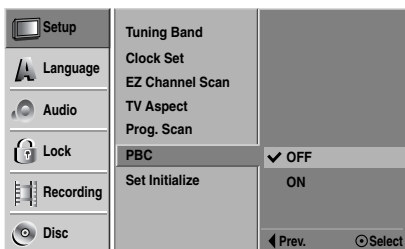

Set Initialize

If you need to, you can reset the recorder to all its factory settings. Select "SET" then press ENTER.

Note

Some options can not be reset. (Rating, Password, Country Code, OSD Language, and Progressive San)

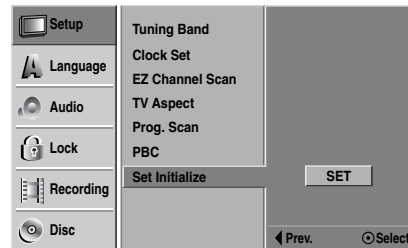

Language

Disc Language

Select a language for the disc's Menu, Audio, and Subtitle.

Original : The original language set for the disc is selected.

Other : To select another language, select Other option then press ENTER. Use the numbered and ENTER buttons to key-in the corresponding 4-digit number according to the language code list on page 47. If you a mistake before pressing ENTER, press ◀ repeatedly to delete one by one and correct it.



OSD Language

Select a language for the Setup menu and on-screen display.



Before Operation

Audio

Each DVD disc has a variety of audio output options. Set the recorder's Audio Output according to the type of audio system you use.

Dolby Digital

PCM: Select when connected to a 2-channel digital stereo amplifier. The DVD Recorder's digital audio outputs sounds in the PCM 2ch format when you play a DVD video disc recorded on the Dolby Digital recording system.

Bitstream: Select "Bitstream" if you connected the DVD Recorder's DIGITAL OUT jack to a Dolby Digital decoder (or an amplifier or other equipment with a Dolby Digital decoder).

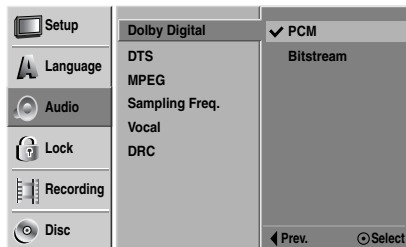

DTS

OFF: If you select "OFF", the DTS signal is not output through the DIGITAL OUT jack.

Bitstream: Select "Bitstream" if you connected the DVD Recorder's DIGITAL OUT jack to a DTS decoder (or an amplifier or other equipment with a DTS decoder).

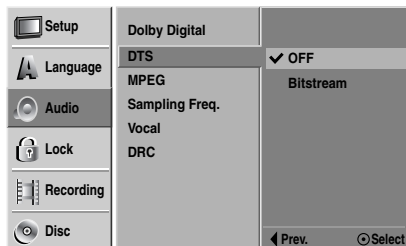

MPEG

PCM: Select when connected to a 2-channel digital stereo amplifier. The DVD Recorder's digital audio outputs sounds in the PCM 2ch format when you play a DVD video disc recorded on the MPEG1, or MPEG2 recording system.

Bitstream: Select "Bitstream" if you connected the DVD Recorder's DIGITAL OUT jack to a MPEG decoder (or an amplifier or other equipment with a MPEG decoder).

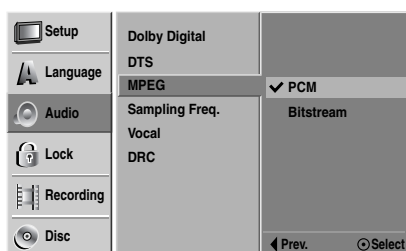

Sampling Freq. (Frequency)

If your receiver or amplifier is NOT capable of handling 96 kHz signals, select 48 kHz. When this choice is made, this unit will automatically convert any 96 kHz signals to 48 kHz so your system can decode them. If your receiver or amplifier is capable of handling 96 kHz signals, select 96 kHz. When this choice is made, this unit will pass each type of signal through without any further processing.

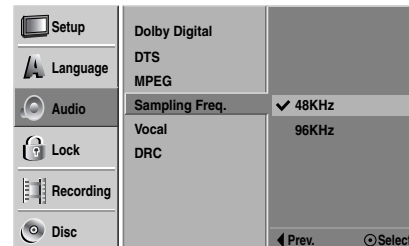

Vocal

Set Vocal to ON only when a multi-channel karaoke DVD is playing. The karaoke channels on the disc will mix into normal stereo sound.

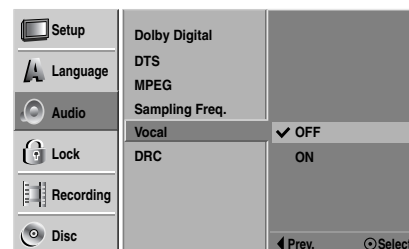

Dynamic Range Control (DRC)

With the DVD format, you can hear a program's soundtrack in the most accurate and realistic presentation possible, thanks to digital audio technology. However, you may wish to compress the dynamic range of the audio output (the difference between the loudest sounds and the quietest ones). Then, you may listen to a movie at a lower volume without losing clarity of sound. Set DRC to ON for this effect.

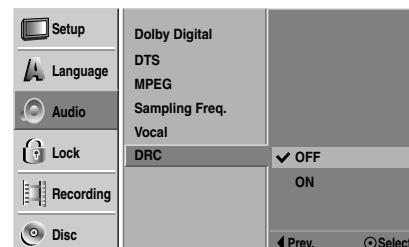

Before Operation (Continued)

Lock (Parental Control)

Rating

Movies on DVDs may contain scenes not suitable for children. Therefore, discs may contain Parental Control information that applies to the complete disc or to certain scenes on the disc. These scenes are rated from Level 1 to 8, and alternatively, more suitable scenes are available for selection on some discs. Ratings are country-dependent. The Parental Control feature allows you to prevent discs from being played by your children or to have certain discs played with alternative scenes.

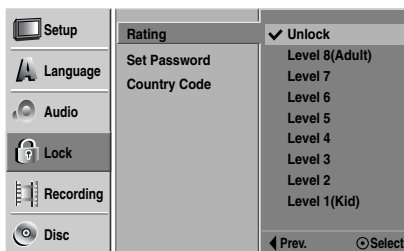

- 1 Press SETUP.**
The Setup menu appears.
- 2 Use ▲ / ▼ to select the Lock option.**
- 3 While the Lock option is selected, press ► to move to the second level.**
- 4 Use ▲ / ▼ to select the Rating option.**
- 5 Press ► to move to the third level.**
- 6 When you have not entered a password yet.**
Enter a 4-digit password using the numbered buttons to create a personal 4-digit security password, then press ENTER. Enter the 4-digit password again and press ENTER to verify.
When you have already entered a password;
Enter a 4-digit password using the numbered buttons to confirm the personal 4-digit security password, then press ENTER.

Tip

If you make a mistake before pressing ENTER, press ◀ repeatedly to delete password numbers one by one then correct it.

- 7 Select a rating from 1 to 8 using the ▲ / ▼ buttons. One (1) has the least playback restrictions. Eight (8) has the most playback restrictions.**
Unlock: If you select Unlock, Parental Control is not active. The disc will play in full.
Level 1 to 8: Some discs contain scenes not suitable for children. If you set a rating for the recorder, all disc scenes with the same rating or lower will be played. Higher rated scenes will not be played unless an alternative scene is available on the disc.

The alternative must have the same rating or a lower one. If no suitable alternative is found, playback will stop. You must enter the 4-digit password or change the rating level in order to play the disc.

- 8 Press ENTER to confirm your rating selection, then press SETUP to exit the menu.**

Set Password

Changing the 4-digit code

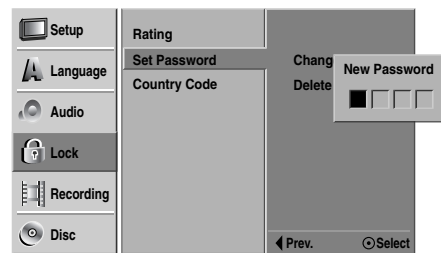

- 1 Follow steps 1-3 as shown above to the left (Rating).**
- 2 Use ▲ / ▼ to select the Set Password option.**
- 3 Press ► to move to the third level.**
- 4 Follow step 6 as shown above to the left (Rating).**
- 5 While "Change" is selected, press ENTER.**
If you select "Delete" then press ENTER. The password is deleted.
- 6 Enter a 4-digit password using the numbered buttons to create a personal 4-digit security password then press ENTER.**
- 7 Enter the 4-digit password again and press ENTER to verify.**

Tip

If you make a mistake before pressing ENTER, press ◀ repeatedly to delete password numbers one by one then correct it.

If you forget your 4-digit code

If you forget your password, to clear the current password, follow the procedure below.

- 1 Press SETUP to display the Setup menu.**
- 2 Use the Number buttons to enter the 5-digit number "21019".**
The message appears on the TV screen.
- 3 Select "yes" then press ENTER. The 4-digit password is cleared. Enter a new code as shown above.**

Before Operation (Continued)

Country Code

Enter the code of a country/area whose standards were used to rate the DVD video disc, referring to the list (See "Country Code List", page 48.).

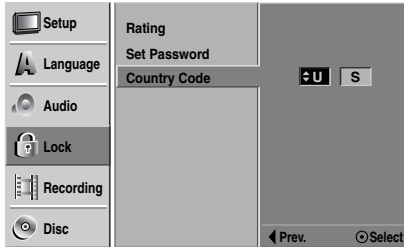

- 1 Press SETUP.**
The Setup menu appears.
- 2 Use ▲ / ▼ to select the Lock option.**
- 3 While the Lock option is selected, press ► to move to the second level.**
- 4 Use ▲ / ▼ to select the Country Code option.**
- 5 Press ► to move to the third level.**
- 6 When you have not entered a password yet.**
Enter a 4-digit password using the numbered buttons to create a personal 4-digit security password, then press ENTER. Enter the 4-digit password again and press ENTER to verify.
When you have already entered a password;
Enter a 4-digit password using the numbered buttons to confirm the personal 4-digit security password, then press ENTER.

Tip

If you make a mistake before pressing ENTER, press ◀ repeatedly to delete password numbers one by one then correct it.

- 7 Select the first character using the ▲ / ▼ buttons.**
- 8 Shift the cursor using ► buttons and select the second character using ▲ / ▼ buttons.**
- 9 Press ENTER to confirm your country code selection, then press SETUP to exit the menu.**

Recording

Record Mode Set

You can set the picture quality for recording; HQ (High Quality), SQ (Standard Quality), LQ (Low Quality).

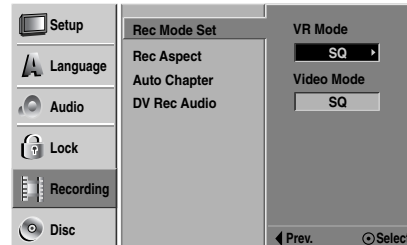

- 1 Press SETUP.**
The Setup menu appears.
- 2 Use ▲ / ▼ to select the Recording option.**
- 3 While the Recording option is selected, press ► to move to the second level.**
- 4 Use ▲ / ▼ to select the Rec Mode Set option.**
- 5 Press ► to move to the third level.**
- 6 Use ▲ / ▼ to select the Video Mode or VR Mode.**
- 7 Use ► to select a desired Record Mode (HQ, SQ, or LQ)**
- 8 Press ENTER to confirm your selection, then press SETUP to exit the menu.**

Record Aspect

When recording, you can set the recording aspect ratio to suit the material you're recording (16:9 widescreen, or 4:3 standard).

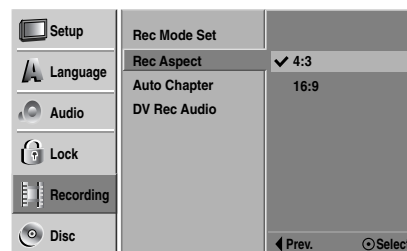

Before Operation (Continued)

Auto Chapter

When recording in Video mode, chapter markers are put in every three minutes on the default setting. You can change this interval to 3 minutes, 5 minutes or 10 minutes. If you select Not Use, switch off automatic chapter marking altogether with the No Separation setting

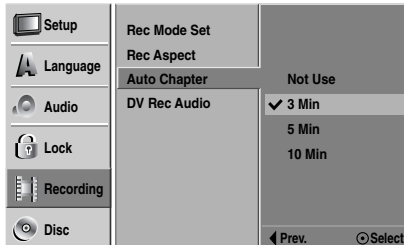

DV Rec Audio

You need to set this if you have a camcorder using 32kHz/12-bit sound connected to the front panel DV IN jack.

Some digital camcorders have two stereo tracks for audio. One is recorded at the time of shooting; the other is for overdubbing after shooting.

On the Audio 1 setting, the sound that was recorded while shooting is used.

On the Audio 2 setting, the overdubbed sound is used.

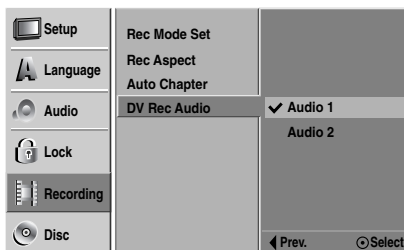

Disc

Initialize

If you're recording on a DVD-R disc, the recording mode will always be Video mode.

If you are using a DVD-RW disc, by default it will be VR mode. You can change this to Video mode from the Setup menu.

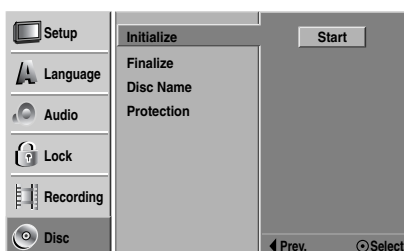

1 Press SETUP.

The Setup menu appears.

2

Use **▲ / ▼** to select the **Disc** option.

3

While the **Disc** option is selected, press **▶** to move to the second level.

4

Use **▲ / ▼** to select the **Initialize** option.

5

Press **▶** to move to the third level. Start icon is highlighted.

6

Press **ENTER**. Disc Initialize menu appears.



7

Use **◀ / ▶** to select a desired **Initialize Mode (VR Mode or Video Mode)** then press **ENTER**.

It takes a few moments to initialize the disc.



Caution

If you want to change the disc format, everything recorded on the disc will be erased.

8

Press **SETUP** to exit the menu.

Protection

When recording in VR mode, set to ON to prevent accidental recording, editing or erasing of the disc loaded. If you need to unlock the disc to make edits, select OFF.

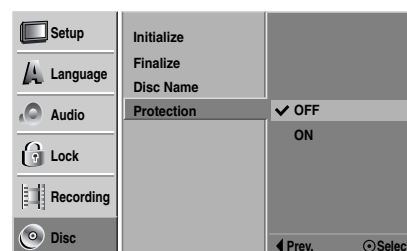

Before Operation (Continued)

Finalize

Finalizing 'fixes' the recordings in place so that the disc can be played on a regular DVD player or computer equipped with a suitable DVD-ROM drive.

Finalizing a Video mode disc creates a menu screen for navigating the disc. This is accessed by pressing MENU or TITLE.

⚠ Caution

- Once you've finalized a disc recording, you can't edit or record anything else on that disc. You can record and edit on this recorder after unfinalizing.

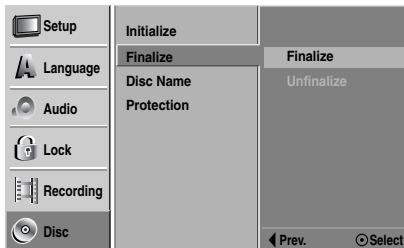

- 1 Follow steps 1-3 as shown on page 25 (Initialize).
- 2 Use ▲ / ▼ to select the Finalize option.
- 3 Press ► to move to the third level. Finalize is highlighted.
- 4 Press ENTER. Finalize menu appears.

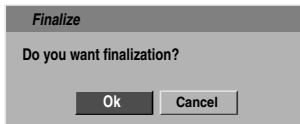

- 5 Select Ok then press ENTER. The recorder starts finalizing the disc.

Note

How long finalization takes depends on the type of disc, how much is recorded on the disc, and the number of titles on the disc. A disc recorded can take up to 3-4 minutes to finalize.

Tip

If you load a DVD-RW that has already been finalized on a different DVD Recorder, you can 'unfinalize' it by choosing Unfinalize from the Finalize menu. After doing this, you can edit and re-record onto the disc.

Disc Name

Use this to enter a name for the disc. This name appears when you load the disc and when you display disc information on-screen.

- The disc name can be up to 32 characters long.
- For discs formatted on a different DVD Recorder, you will see only a limited character set.

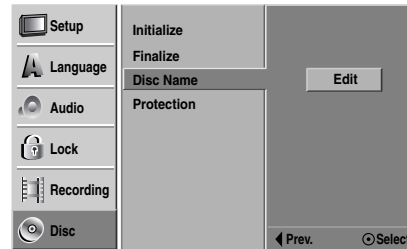

- 1 Follow steps 1-3 as shown Initialize on page 25.
- 2 Use ▲ / ▼ to select the Disc Name option.
- 3 Press ► to move to the third level. Edit icon is highlighted.
- 4 Press ENTER. Keyboard menu appears.

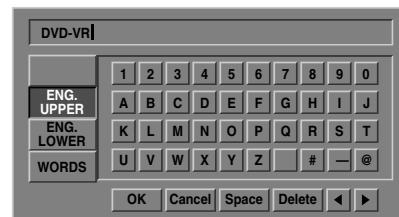

- 5 Enter a name for the disc. Use ▲ ▼ ◀ ▶ to select a character then press ENTER to confirm your selection.

- **ENG. UPPER:** Switch the keyboard to upper case characters.
- **ENG. LOWER:** Switch the keyboard to lower case characters.
- **WORDS:** Switch the keyboard to theme word.
- **OK:** Select to finish.
- **Cancel:** Deletes all the characters inputted.
- **Space:** Inserts a space at the cursor position.
- **Delete:** Deletes the character at the cursor position.
- **◀ / ▶:** Moves cursor to left or right.

- 6 Choose OK then press ENTER to fix the name and return to the Setup menu.

- 7 Press SETUP to exit the menu.

Note

You can also use the CLEAR button to delete characters directly.

Before Operation



Caution:

Before using the remote control, press the **DVD** button to operate this DVD Recorder.

General Explanation of On-Screen Display

This manual gives basic instructions for operating the DVD Recorder. Some DVDs require specific operation or allow only limited operation during playback. When this occurs, the symbol appears on the TV screen, indicating that the operation is not permitted by the DVD Recorder or is not available on the disc.

On-Screen Display

General playback status can be displayed on the TV screen. Some items can be changed on the menu.

On-screen display operation

1 Press **DISPLAY** during playback.

2 Use **▲ / ▼** to select a menu option.
The selected option will be highlighted.



Use **◀ / ▶** to change the setting of an option.

The number buttons can be also be used for setting numbers (e.g., title number). For some functions, press **ENTER** to execute the setting.

Temporary Feedback Field Icons

- Resume play from this point
- Action prohibited or not available



Notes

- Some discs may not provide all of the features on the on-screen display example shown below.
- If no button is pressed for 20 seconds, the on-screen display disappears.

DVD



Menu Options	Function (Use ▲ / ▼ to select desired option)	Selection Method
Title Number 	Shows the current title number and total number of titles, and skips to the desired title number.	◀ / ▶, or Numbers, ENTER
Chapter Number 	Shows the current chapter number and total number of chapters, and skips to the desired chapter number.	◀ / ▶, or Numbers, ENTER
Time search 	Shows the elapsed playing time, and searches the point by the elapsed time directly.	Numbers, ENTER
Audio language and Digital Audio Output mode 	Shows the current audio soundtrack language, encoding method, and channel number, and changes the setting.	◀ / ▶
Subtitle language 	Shows the current subtitles language, and changes the setting.	◀ / ▶
Angle 	Shows the current angle number and total number of angles, and changes the angle number.	◀ / ▶
Sound 	Shows the current sound mode, and changes the setting.	◀ / ▶

VCD2.0 VCD1.1

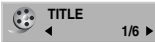
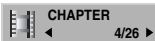

Menu Options	Function (Use ▲ / ▼ to select desired option)	Selection Method
Track Number 	Shows the current track number and total number of tracks or PBC On mode, and skip to the desired track number.	◀ / ▶, or Numbers, ENTER
Time 	Shows the elapsed playing time (Display only).	-
Audio Channel 	Shows the audio channel, and changes the audio channel.	◀ / ▶
Sound 	Shows the current sound mode, and changes the setting.	◀ / ▶

Before Operation

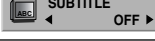
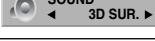
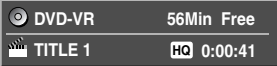
VR

Menu Options	Function (Use ▲ / ▼ to select desired option)	Selection Method
Title Number 	Shows the current title number and total number of titles, and skips to the desired title number.	◀ / ▶, or Numbers, ENTER
Chapter Number 	Shows the current chapter number and total number of chapters, and skips to the desired chapter number.	◀ / ▶, or Numbers, ENTER
Time search 	Shows the elapsed playing time, and searches the point by the elapsed time directly.	Numbers, ENTER
Digital Audio Output mode 	Shows the current audio encoding method, and channel number, and changes the setting.	◀ / ▶
Subtitle language 	Shows the current subtitles language, and changes the setting.	◀ / ▶
Sound 	Shows the current sound mode, and changes the setting.	◀ / ▶
	Shows the disc name, title number, record mode, total title time, and free space time on disc.	-

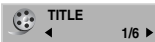
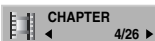
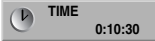
Video

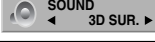
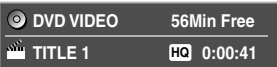
Menu Options	Function (Use ▲ / ▼ to select desired option)	Selection Method
Title Number 	Shows the current title number and total number of titles, and skips to the desired title number.	◀ / ▶, or Numbers, ENTER
Chapter Number 	Shows the current chapter number and total number of chapters, and skips to the desired chapter number.	◀ / ▶, or Numbers, ENTER
Time search 	Shows the elapsed playing time, and searches the point by the elapsed time directly.	Numbers, ENTER
Digital Audio Output mode 	Shows the current audio encoding method, and channel number, and changes the setting.	◀ / ▶
Sound 	Shows the current sound mode, and changes the setting.	◀ / ▶
	Shows the disc name, title number, record mode, total title time, and free space time on disc.	-

Using the Built-in TV Tuner

Changing TV Channels

If no disc is playing, you can change TV channels using the number or CH (▲ / ▼) buttons on the remote control, or the CH (+/-) buttons on the front panel.

Note

Antenna channels are numbered 2 through 69. Cable channels are numbered 1 through 125.

Changing TV Audio Channel

Some TV programs are broadcast with both a main and a Secondary Audio Program (SAP). You can change the TV audio using the AUDIO button.

Press AUDIO repeatedly to change the TV audio.
Stereo → SAP → Mono → Stereo

The current audio channel is displayed on-screen.

- If SAP is selected, but there is no SAP channel being broadcast, you will still hear the main audio channel.
- If the sound is of poor quality when set to Stereo, you can often improve it by changing to Mono.
- When an external input is selected, the audio channel can be switched only to Stereo.

Displaying OSD While Watching TV

Press ENTER to display/remove the information displayed on-screen.

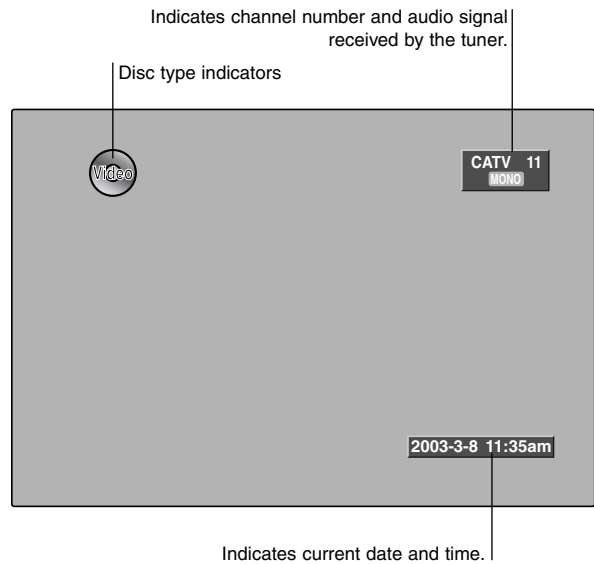

Operation with DVD and Video CD

Playing a DVD or Video CD

Playback Setup

- Turn the TV on and select the video input source connected to the DVD Recorder.
- Audio system: Turn the audio system on and select the input source connected to the DVD Recorder.

1 Press OPEN/CLOSE to open the disc tray.

2 Load your chosen disc in the tray, with the playback side down.

3 Press OPEN/CLOSE to close the tray. READING appears on the display window, and playback starts automatically. If playback does not start, press PLAY. In some cases, the disc menu might appear instead.

Tip

If a menu screen is displayed

The menu screen may be displayed first after loading a DVD or Video CD which contains a menu.

DVD

Use the ◀ ▶ ▲ ▼ buttons to select the title/chapter you want to view, then press ENTER to start playback. Press TITLE or MENU to return to the menu screen.

VCD2.0

- Use the number buttons to select the track you want to view. Press RETURN to return to the menu screen.
- Menu setting and the exact operating procedures for using the menu may differ depending on the disc. Follow the instructions on the each menu screen. You may also set PBC to OFF under Setup menu. See page 21.

Notes

- If Parental Control is set and the disc is not within the Rating settings (not authorized), the 4-digit code must be entered and/or the disc must be authorized (see “Rating”, on page 23).
- DVDs may have a Region Code. Your recorder will not play discs that have a region code different from your recorder. The region code for this recorder is 1 (one).

Note

Unless stated otherwise, all operations described use the remote control. Some features may also be available on the Setup menu.

Moving to another TITLE



When a disc has more than one title, you can move to another title as follows:

- Press DISPLAY then use ▲ / ▼ to select the title icon. Then, press the appropriate numbered button (0-9) or ◀ / ▶ to select a title number.

Moving to another CHAPTER/TRACK



When a title on a disc has more than one chapter/track, you can move to another chapter/track as follows:

- Press SKIP/SCAN (◀◀ or ▶▶) briefly during playback to select the next chapter/track or to return to the beginning of the current chapter/track.
- Press SKIP/SCAN (◀◀) twice briefly to step back to the previous chapter/track.
- To go directly to any chapter/track during playback, press DISPLAY. Then, use ▲ / ▼ to select chapter icon (or for a Video CD, select track icon). Then, enter the chapter/track number using the numbered buttons (0-9) or press ◀ / ▶.

Slow Motion



- 1 Press SLOW ◀ or ▶ during playback. The DVD Recorder will enter SLOW mode.
- 2 Use the SLOW ◀ or ▶ to select the required speed: ◀◀ 1/16, ◀◀ 1/8, ◀◀ 1/4, ◀◀ 1/2 or ◀◀ (backward), or ▶▶ 1/16, ▶▶ 1/8, ▶▶ 1/4, ▶▶ 1/2 or ▶▶ (forward). With a Video CD, the Slow speed changes: ▶▶ 1/8, ▶▶ 1/4 or ▶▶ 1/2 (forward).
- 3 To exit Slow Motion mode, press PLAY.

Note

Slow motion playback in reverse is not possible with Video CDs.

Operation with DVD and Video CD (Continued)

General Features (Continued)

Still Picture and Frame-by-Frame Playback

DVD **Video** **VR** **VCD2.0** **VCD1.1**

- 1 Press PAUSE (II) during playback. The recorder will now go into PAUSE mode.
- 2 You can advance or back up the picture frame-by-frame by pressing ◀ / ▶ repeatedly during PAUSE mode.

Note

The picture frame-by-frame in reverse is not available for Video CD.

Search **DVD** **Video** **VR** **VCD2.0** **VCD1.1**

- 1 Press and hold SKIP/SCAN (I◀◀ or ▶▶I) for about two seconds during playback. The recorder will now go into SEARCH mode.
- 2 Press and hold SKIP/SCAN (I◀◀ or ▶▶I) to select the required speed: ◀◀X2, ◀◀X4, ◀◀X8, ◀◀X16, ◀◀X100 (backward) or ▶▶X2, ▶▶X4, ▶▶X8, ▶▶X16, ▶▶X100 (forward). With a Video CD, the Search speed changes: ◀◀X2, ◀◀X4, ◀◀X8 (backward) or ▶▶X2, ▶▶X4, ▶▶X8 (forward).
- 3 To exit SEARCH mode, press PLAY (▶).

Random **Karaoke DVD** **VCD2.0** **VCD1.1**

- 1 Press RANDOM during playback or in Stop mode. The unit automatically begins Random Playback and "RANDOM" appears on the display window.
- 2 To return to normal playback, press RANDOM until "RANDOM" disappears from the display window.

Tip

By pressing SKIP/SCAN ▶▶I during Random playback, the unit selects another title (track) and resumes Random playback.

Note

- This function only works with DVD Karaoke discs or video CDs without PBC.
- On a Video CD with PBC, you must set PBC to OFF in the Setup menu to use the Random function. See page 21.

Repeat **DVD** **Video** **VR** **VCD2.0** **VCD1.1**



DVD Video Discs - Repeat Chapter/Title/Off

- 1 To repeat the currently playing chapter, press REPEAT. The REPEAT CHAPTER appears on the TV screen.
- 2 To repeat the title currently playing, press REPEAT a second time. The REPEAT TITLE appears on the TV screen.

- 3 To exit Repeat mode, press REPEAT a third time. The REPEAT OFF icon appears on the TV screen.

Video CDs - Repeat Track/All/Off

- 1 To repeat the track currently playing, press REPEAT. The REPEAT TRACK icon appears on the TV screen.
- 2 To repeat the disc currently playing, press REPEAT a second time. The REPEAT ALL icon appears on the TV screen.
- 3 To exit Repeat mode, press REPEAT a third time. The REPEAT OFF icon appears on the TV screen.

Note

On a Video CD with PBC, you must set PBC to OFF in the Setup menu to use the Repeat function. See page 21.

Repeat A-B

DVD **Video** **VR** **VCD2.0** **VCD1.1**



To repeat a sequence in a title:

- 1 Press A-B at your chosen starting point. REPEAT A- appears on the TV screen.
- 2 Press A-B again at your chosen end point. REPEAT A-B appears briefly on the TV screen, and the repeat sequence begins ("REPEAT A-B" also appears in the display window).
- 3 To cancel the sequence, press A-B repeatedly to select OFF.

Time Search **DVD** **Video** **VR**

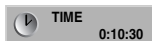

The Time Search function allows you to start playing at any chosen time on the disc.

- 1 Press DISPLAY during playback. The on-screen display appears on the TV screen. The Time Search box shows the elapsed playing time of the current disc.
- 2 Within 20 seconds, use ▲ / ▼ to select the Time Search icon in the on-screen display. The "0:00:00" appears in the Time Search box.
- 3 Within 20 seconds, use the number buttons to enter the required start time. Enter hours, minutes, and seconds from left to right in the box. You can not enter an invalid time. If you enter the wrong numbers, press ◀ / ▶ to move the under bar () to the wrong number. Then enter the correct numbers.
- 4 Within 20 seconds, press ENTER to confirm the start time. Playback starts from the selected time on the disc.

Operation with DVD and Video CD (Continued)

General Features (continued)

Zoom **DVD** **Video** **VR** **VCD2.0** **VCD1.1**

The Zoom function allows you to enlarge the video image and to move through the enlarged image.

- 1 Press ZOOM during playback or still playback to activate the Zoom function.

The square frame will be displayed in the right bottom of the picture. If no button is pressed for more than 5 seconds, the square frame will disappear.

Each press of the ZOOM button changes the TV screen in the sequence shown below.

normal size → X2 size → X4 size → normal size

- 2 Use the ◀▶▲▼ buttons to move through the zoomed picture.
- 3 To resume normal playback, press CLEAR or press ZOOM repeatedly until the normal picture appears.

Note

- The zoom function may not work for some DVDs.

Marker Search

DVD **Video** **VR** **VCD2.0** **VCD1.1**



You can start playback from a memorized point. Up to six points can be memorized.

To enter a mark, follow these steps.

- 1 During disc playback, press MARKER when playback reaches the spot that you want to memorize.
The Marker icon will appear on the TV screen briefly.
- 2 Repeat step 1 to enter up to six Marker points on a disc.

To Recall a Marked Scene

- 1 During disc playback, press SEARCH.
The Marker Search menu will appear on the TV screen.
- 2 Use the ◀▶▲▼ buttons to select a Marked scene that you want to recall.
- 3 Press ENTER.
Playback will start from the Marked scene.
- 4 To remove the Marker Search menu, press RETURN.

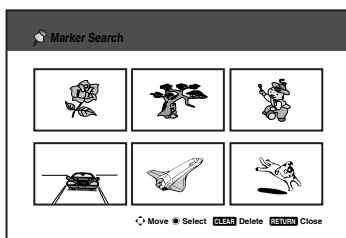

To clear a Marked Scene

- 1 During disc playback, press SEARCH.
The Marker Search menu will appear on the TV screen.
- 2 Use ◀▶▲▼ to select the Marked scene that you want to erase.
- 3 Press CLEAR.
“Delete selected marker? Proceed?” message appears.
- 4 Use ◀ / ▶ to select “Yes” then press ENTER.
- 5 Repeat steps 2-4 to erase additional Marked scene.
- 6 To remove the Marker Search menu, press RETURN.

Checking the Contents of DVD Video Discs: Menus

DVDs may contain menus that allow you to access special features. To open the disc menu, press MENU. Then, press the appropriate number button to select an option. Or, use the ◀▶▲▼ buttons to highlight your selection, then press ENTER.

Title Menu **DVD** **Video** **VR**

- 1 Press TITLE.
If the current title has a menu, the menu will appear on the TV screen. Otherwise, the disc menu may appear.
- 2 The menu may contain camera angles, spoken language and subtitle options, and chapters for the title.
- 3 To remove the title menu, press TITLE again.

Disc Menu **DVD**

- 1 Press MENU.
The disc menu is displayed.
- 2 To remove the disc menu, press MENU again.

Camera Angle **DVD**



If the disc contains scenes recorded at different camera angles, you can change to a different camera angle during playback.

- Press ANGLE then press ◀ / ▶ repeatedly during playback to select a desired angle.
The number of the current angle appears on the TV screen.

Tip

The ANGLE indicator will blink in the display window at scenes recorded at different angles to indicate that angle switching is possible.

Changing the Audio Language **DVD**

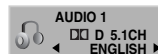

Press AUDIO then press ◀ / ▶ repeatedly during playback to hear a different audio language or audio track.

Operation with DVD and Video CD (Continued)

Changing the Audio Channel

VCD2.0 **VCD1.1** **VR** 

With a Video CD, press AUDIO then press ◀ / ▶ repeatedly during playback to hear a different audio channel (STEREO, LEFT or RIGHT).

With DVD-RW discs recorded in VR mode that have both a main and a Sub audio channel, you can switch between Main (L), SAP (R), or a mix of both (Main+Sub) by pressing AUDIO.

3D Surround

DVD **Video** **VR** **VCD2.0** **VCD1.1**

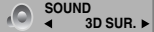

This unit can produce a 3D Surround effect, which simulates multi-channel audio playback from two conventional stereo speakers, instead of the five or more speakers normally required to listen to multi-channel audio from a home theater system.

- 1 Press SOUND then press ◀ / ▶ repeatedly during playback to select "3D SUR".
- 2 To turn off the 3D Surround effect, select "NORM".

Subtitles **DVD**

Press SUBTITLE then press ◀ / ▶ repeatedly during playback to see the different subtitle languages.

Commercial Skip **DVD** **Video** **VR**

Each press CM SKIP skips forward 10 seconds. Use CM SKIP to a maximum of 4 minutes. (approximately two average-length commercials).

ote

If  appears, the feature is not available on the disc.

Finding Locations on a Disc

VCD2.0 **VCD1.1**

You can directly access any point on a video CD using this function. Use this function only while a video CD is playing. Playback jumps to the point specified.

- 1 Press SEARCH during playback. The progress bar appears on the TV screen.

 33%

 33%

- 2 Use ◀ / ▶ to find a start position for playback.
- 3 Press ENTER to confirm the selected position. Playback starts from the selected position.

ote

This function works only when no marker is not be memorized.

Last Condition Memory

DVD **Video** **VR**

This recorder memorizes the user settings for the last disc that you have viewed. Settings remain in memory even if you remove the disc from the recorder or switch off the recorder. If you load a disc that had its settings memorized, the latest stop position is automatically recalled.

otes

- Settings are stored in memory for use any time.
- This recorder does not memorize settings of a disc if you switch off the recorder before commencing to play it.

Audio CD and MP3 Operation

Playing an Audio CD or MP3 Disc

CD **MP3**

The DVD Recorder can play audio CDs. Also, the DVD Recorder can play MP3 formatted recordings on CD-ROM, CD-R or CD-RW discs.

Before playing MP3 recordings, read the notes on MP3 Recordings on the right side of this page.

- 1 Insert a disc and close the tray.**
AUDIO CD or MP3 CD menu appears on the TV screen.

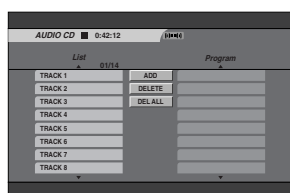

AUDIO CD Menu

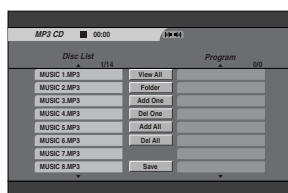

MP3 CD Menu

- 2 Use ▲ / ▼ to select a track then press PLAY or ENTER.**

Playback starts.

During playback, the current track's elapsed playing time will appear on the display window and menu. Playback will stop at the end of the disc.

Tips

- Press SLOW ▶ to move to the next page.
- Press SLOW ◀ to move to the previous page.
- If audio title and MP3 file are mixed on the disc, you can switch between AUDIO CD menu and MP3 CD menu by pressing TITLE repeatedly.
- On the MP3 CD menu, you can display the folders on the disc. Use ▲ ▼ ◀ ▶ to select the "Folder" icon on the MP3 CD menu then press ENTER. Also, you can display only tracks in the folders. Use ▲ ▼ ◀ ▶ to select a folder then press ENTER.
- On the MP3 CD menu, select "View All" then press ENTER to display all MP3 files on the disc.
- On the mixed CD with audio title and MP3 file, you can switch AUDIO CD menu and MP3 CD menu by pressing TITLE button repeatedly.

- 3 To stop playback at any other time, press STOP.**

Notes on MP3 Recordings

About MP3

- An MP3 file is audio data compressed by using the MPEG1 audio layer-3 file-coding scheme. We call files that have the ".mp3" file extension "MP3 files".
- The recorder can not read an MP3 file that has a file extension other than ".mp3".

MP3 Disc compatibility with this recorder is limited as follows:

1. CD-R physical format should be "ISO 9660" and "JOLIET".
2. If you record MP3 files using the software which cannot create a FILE SYSTEM, for example "Direct-CD" etc., it is impossible to playback MP3 files. We recommend that you use "Easy-CD Creator", which creates an ISO9660 or JOLIET file system.
3. Total number of files and folders on the disc should be less than 999.

This DVD Recorder requires discs/recordings to meet certain technical standards in order to achieve optimal playback quality. Pre-recorded DVDs are automatically set to these standards. There are many different types of recordable disc formats (including CD-R containing MP3 files) that require certain pre-existing conditions (see above) to insure compatible playback.

Customers should also note that permission is required in order to download MP3 files and music from the Internet. Our company has no right to grant such permission. Permission should always be sought from the copyright owner.

Audio CD and MP3 Operation (Continued)

Pause **CD** **MP3**

- 1 Press PAUSE during playback.
- 2 To return to playback, press PLAY or press PAUSE again.

Moving to Another Track **CD** **MP3**

- Press SKIP/SCAN **⏮** or **⏭** briefly during playback to go to the next track or to return to the beginning of the current track.
- Press SKIP/SCAN **⏮** twice briefly to step back to the previous track.
- On an Audio CD, to go directly to any track, enter the track number using the numbered buttons (0-9) during playback.

Repeat Track/All/Off **CD** **MP3**

- 1 To repeat the track currently playing, press REPEAT. The Repeat icon and "TRK" appear on the menu screen.
- 2 To repeat all tracks on a disc, press REPEAT a second time. The Repeat icon and "ALL" appear on the menu screen.
- 3 To cancel Repeat mode, press REPEAT a third time. The Repeat icon disappears from the menu display.

Random **CD** **MP3**

- 1 Press RANDOM during playback or when playback has stopped. The unit automatically begins Random Playback and RANDOM appears on the menu screen.
- 2 Press RANDOM during Random playback.
- 3 To return to normal playback, press RANDOM repeatedly until RANDOM disappears from the menu screen.

Intro Scan **CD** **MP3**

- 1 Press INTRO during playback or when playback has stopped. The unit previews the first few seconds of each track on a CD and "INTRO" appears on the menu screen.

Tips

- After Intro scan previews all of the tracks, it stops.
 - If you want to play the track that Intro scan is previewing, press INTRO (starts playing from the current track).
- 2 To return to normal playback, press INTRO repeatedly until INTRO disappears from the menu screen.

3D Surround **CD** **MP3**

This unit can produce a 3D Surround effect, which simulates multi-channel audio playback from two conventional stereo speakers, instead of the five or more speakers normally required to listen to multi-channel audio from a home theater system.

- 1 Press SOUND to select "3D SUR." during playback.
- 2 To turn off the 3D Surround effect, press SOUND until "3D SUR." disappears from the menu screen.

Search **CD**

- 1 Press and hold SKIP/SCAN **⏮** or **⏭** for about two seconds during playback. The recorder will now go into SEARCH mode.
- 2 Press and hold SKIP/SCAN **⏮** or **⏭** to select the required speed: **⏮X2**, **⏮X4**, **⏮X8** (backward) or **⏭X2**, **⏭X4**, **⏭X8** (forward). Search speed and direction are indicated on the menu screen.
- 3 To exit SEARCH mode, press PLAY.

Repeat A-B **CD**

To repeat a sequence in a title:

- 1 Press A-B at your chosen start point. Repeat icon and "A" appears on the menu screen.
- 2 Press A-B again at your chosen end point. The Repeat icon and "A - B" appears on the menu screen, and the repeat sequence begins.
- 3 To exit the sequence and return to normal play, press A-B again. The Repeat icon disappears from the menu screen.

Programmed Playback with Audio CD and MP3

The Program function enables you to store your favorite tracks from any disc in the recorder memory. Program can contain 30 tracks (Audio CD) or 256 tracks (MP3).

- 1 Insert an Audio CD or MP3 disc.**
Audio CD or MP3 CD menu will appear.
- 2 Use ▲▼◀▶ to select a track on the List.**

- 3 Use ▲▼◀▶ to highlight the "ADD" or "Add One" icon then press ENTER. Or, press PROGRAM.**

The selected track is added to the Program List.

- 4 Repeat steps 2-3 to place additional tracks on the Program list.**

- 5 Use ▲▼◀▶ to move to the Program list.**

T ip

On an MP3 CD menu, you can add all tracks on the List to the Program list. Select "Add All" then press ENTER.

- 6 Use ▲▼ to select the track you want to start playing.**

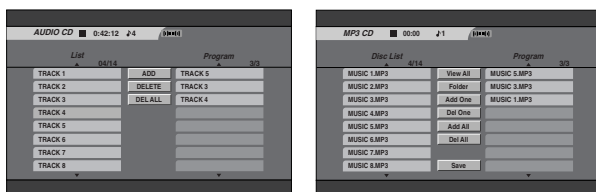

T ips

- Press SLOW ▶ to move to the next page.
- Press SLOW ◀ to move to the previous page.

- 7 Press PLAY or ENTER to start.**
Playback begins in the order in which you programmed the tracks and "PROG" indicator appears on the display window.
Playback stops after playing the last programmed track on the program list.

- 8 To resume normal playback from programmed playback, select a track on the List then press ENTER.**

"PROG" indicator disappears from the display window.

Repeat Programmed Tracks

- To repeat the track currently playing, press REPEAT. The Repeat icon and "TRK" appear on the menu screen.
- To repeat all tracks on the program list, press REPEAT a second time. The Repeat icon and "ALL" appear on the menu screen.
- To cancel Repeat mode, press REPEAT a third time. The Repeat icon disappears from the menu screen.

Erasing a Track from the Program List

- 1 Select the track that you wish to erase from the Program list.
- 2 Use ▲▼◀▶ to select the "DELETE" or "Del One" icon then press ENTER. Or, press CLEAR. The selected track is deleted on the program list.
- 3 Repeat steps 1-2 to delete additional tracks on the Program list.

Erasing the Complete Program List

Use ▲▼◀▶ to select the "DEL ALL" or "Del All" icon then press ENTER.

All tracks on the program list are deleted.

Save Your Program List **MP3**

This recorder memorizes the user program list for the disc that you have programmed. Program list remains in memory even if you remove the disc from the recorder or switch the recorder off. If you load a disc that has its program list memorized, the program list is automatically recalled.

- Use ▲▼◀▶ to select the "Save" icon on the MP3 CD menu then press ENTER.

Basic Recording

Basic Recording from a TV

Follow the instructions below to record a TV program. Recording starts immediately and continues until the disc is full or you stop the recording.

- 1 Switch on the recorder and load a recordable disc.**
Also make sure that the TV input is set to this recorder. If you load a completely blank disc, the recorder takes a short while to initialize the disc.
- 2 Set a recording mode as necessary by pressing REC MODE repeatedly. (HQ, SQ, LQ)**
HQ; High Quality, SQ; Standard Quality, LQ: Low Quality
- 3 Use CH (▲ / ▼) buttons to select the TV channel to record.**
- 4 Use AUDIO to select the audio channel to record. (Stereo, SAP, or Mono)**

The table below shows what will be recorded on the different settings for different types of broadcast. The last column (Monitor Audio) shows what you'll hear as it is recording.

For example, if the TV broadcast is in stereo, then setting the recorder to Stereo or SAP will record the broadcast in stereo, and the monitor audio is also stereo.

- If you set the audio channel to SAP, but there is no SAP channel being broadcast, the main audio (mono or stereo) will be recorded.

TV Broadcast	Selected Audio	Broadcast Audio		Monitor Audio
		L Ch	R Ch	
Mono	Stereo/Mono/SAP	Mono	Mono	Mono
Stereo	Stereo/SAP	L	R	Stereo
	Mono	Mono	Mono	Mono
Mono+SAP	Stereo/Mono	Mono	Mono	Mono
	SAP	SAP	SAP	SAP
Stereo+SAP	Stereo	L	R	Stereo
	Mono	Mono	Mono	Mono
	SAP	SAP	SAP	SAP

- 5 Press REC (●) once.**
Recording will start. (The RECORD indicator lights in the display window.)
 - Recording continues until you press STOP (■) or the disc is full.
 - To record for a fixed length of time, see Instant Timer Recording on right.
- 6 Press STOP (■) to stop recording.**

Instant Timer Recording

Instant Timer Recording allows you to make a recording easily of a preset length without using the program timer.

- 1 Follow steps 1-4 as shown left (Basic Recording from a TV).**
- 2 Press REC (●) repeatedly to select the recording time length.**
Recording starts after the first press. Each subsequent press increases the recording time by 10 minutes within free space (maximum 120 minutes). The recording time is displayed on the TV screen.

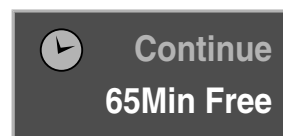

Instant Timer Record Menu

Checking the Recording Time

Press REC (●) once to check the recording time. The recalled setting will automatically return to the TV screen for a moment.

Also, remaining time of recording is shown in the display window.

To Extend the Recording Time

The recording time can be extended anytime by pressing REC (●).

Each subsequent press increases the recording time by 10 minutes within free space (maximum 120 minutes).

To Pause the Recording

- 1 Press PAUSE (||) to pause the disc during recording.**
- 2 When you want to continue recording, press PAUSE (||).**

Timer Recording

This DVD Recorder can be programmed to record up to 8 programs within a period of 1 month. For unattended recording, the timer needs to know the channels to be recorded, the starting time and length.

1 Press **TIMER REC**.

The Timer Record menu will appear.

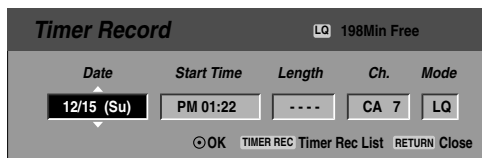

- **Date** – Choose a date up to 1 month in advance, or select a daily or weekly program.
- **Start Time** – Set the recording start time.
- **Length** – Set the recording length.
- **Ch.** – Choose a channel (2-69 or 1-125 for antenna or cable channels respectively, excluding skip channels), or one of the external inputs from which to record.
- **Mode** – Choose a record mode (HQ, SQ, LQ, or AUTO).
AUTO mode determines how much disc time is available and switches record mode, if necessary, to complete recording the program.

2 Enter the necessary information for your timer recording(s).

- ◀ / ▶ (left/right) – move the cursor left/right
- ▲ / ▼ (up/down) – change the setting at the current cursor position
- Press RETURN to exit the Timer Record menu.
- Press ENTER after filling in all the program information.
- Press **TIMER REC** to display Timer Record List.

3 Press **ENTER**, the program will be memorized by the DVD Recorder.

To check the programming, the Timer Record List will appear.

4 Press **RETURN** to exit the Program List.

5 Make sure that you load a recordable disc.

Notes

- The timer indicator lights in the display window. If the indicator blinks, it means that there is no disc loaded, or the disc loaded is not recordable.
- The recorder will record the audio according to the current TV tuner setting (Stereo, Mono or SAP). Use the **AUDIO** button to set the audio as you want before switching the recorder into standby.
- You must press **POWER** to stop the timer recording.

Checking Timer Recording Details

Programming can be checked whenever the DVD Recorder is turned on. Press **TIMER REC** twice.

- Use ▲ / ▼ to select a timer recording.
- Press **ENTER** to edit the selected program. Timer Record menu appears.
- Press **CLEAR** to delete the selected program from the Timer Record List.

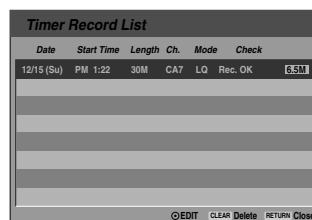

Canceling a Timer Recording

You can clear a timer setting anytime before the recording actually starts.

- Use ▲ / ▼ to select a program you want to erase on the Timer Recorder List. If you want to erase the program, press **CLEAR**.

Stopping a Timer Recording in Progress

After a timer recording has started, you can still cancel the program.

- Press **POWER**.

Timer Recording Troubleshooting

Even though the timer is set, the recorder will not record when:

- There is no disc loaded.
- A non-recordable disc is loaded.
- Protection is set to ON in the Setup menu (see page 25).
- There are already 99 titles recorded on the disc.

You cannot enter a timer program when:

- A recording is already underway.
- The time you're trying to set has already passed.
- There are already 8 timer programs set.

If two or more timer programs overlap:

- The earlier program takes priority.
- When the earlier program finishes, the later program starts.
- If two programs are set to start at exactly the same time, the program entered first takes priority.

Confirmation is not possible when:

- Protection setting is set to ON.
- There are already 99 titles recorded on the disc.

If the disc is damaged, the recording may not complete successfully. In this case even though the Check field shows "Rec. OK", it may not be.

Recording from an External Input

Recording from External Components

You can record from an external component, such as a camcorder or VCR, connected to any of the recorder's external inputs.

1 Make sure that the component you want to record from is connected properly to the DVD Recorder. See page 18.

2 Press INPUT repeatedly to select the external input to record from.

- Tuner: Built-in tuner
- AV1: Audio/Video Input mounted on back panel
- AV2: Audio/Video Input mounted on front panel
- DV: DV Input mounted on front panel

Note

Check that the Audio In settings DV Rec Audio are as you want them. See page 25 .

3 Load a recordable disc.

4 Select the recording mode as necessary by pressing REC MODE repeatedly. (HQ, SQ, LQ)
HQ: High Quality, SQ: Standard Quality, LQ: Low Quality

5 Press REC (●) once.

Recording will start. (The RECORD indicator lights in the display window.)

- Recording continues until you press STOP (■) or the disc is full.
- To record for a fixed length of time, see Instant Timer Recording on page 37.

6 Press STOP (■) to stop recording.

Note

If your source is copy-protected using CopyGuard, you will not be able to record it using this recorder. See Copyright on page 8 for more details.

Recording from a Digital Camcorder

You can record from a digital camcorder connected to the DV IN jack on the front panel of this recorder. Using the recorder's remote, you can control both the camcorder and this recorder.

Before recording, make sure that the audio input for the DV IN jack is set up (see page 25).

Tips

- The source signal must be DVC-SD format.
- Some camcorders cannot be controlled using this recorder's remote.
- If you connect a second DVD Recorder using a DV cable, you cannot control the second DVD from this one.
- You can't control this unit remotely from a component connected to the DV IN jack.
- You can't record date and time information from a DV cassette.

1 Make sure your digital camcorder is connected to the front panel DV IN jack. See page 18.

2 Check that the DV audio input is as you require.

- You can choose between Audio 1 (original audio) and Audio 2 (overdubbed audio).
- DV Input is set from the DV Rec Audio in sub-menu of the Setup menu. See DV Rec Audio on page 25 for more information.

3 Press INPUT repeatedly to select the DV input. DV appears in the display window and on the TV screen.

4 Find the place on the camcorder tape that you want to the recording to start from.

- For best results, pause playback at the point from which you want to record.
- Depending on your camcorder, you can use this recorder's remote to control the camcorder using the STOP, PLAY and PAUSE functions.

5 Press REC (●) once to start recording.

- Recording is automatically stopped if the recorder detects no signal.
- You can pause or stop the recording by pressing PAUSE or STOP. You cannot control the camcorder from this remote control during recording.
- In Video mode, the final frame of the recording may remain displayed on screen for a while after recording stops.

Playing Your Recordings on Other DVD Players

Most regular DVD players can play finalized discs recorded in Video mode. A small number of players can also play DVD-RW discs recorded in VR mode, finalized or not. Check the manual that came with the other player to check what kinds of discs it will play.

Finalizing a Disc

Finalizing 'fixes' the recordings in place so that the disc can be played on a regular DVD player or computer equipped with a suitable DVD-ROM drive. Finalizing a Video mode disc creates a menu screen for navigating the disc. This is accessed by pressing MENU or TITLE.

To finalize a disc, refer to "Finalize" on page 26.

Recording from an External Input (Continued)

What is DV?

Using DV, also known as i.LINK, you can connect a DV-equipped camcorder to this recorder using a single DV cable for input and output of audio, video, data and control signals.

The i.LINK interface is also known as IEEE 1394-1995. "i.LINK" and the "i.LINK" logo are trademarks.

- This recorder is only compatible with DV-format (DVC-SD) camcorders. Digital satellite tuners and Digital VHS video recorders are not compatible.
- You cannot connect more than one DV camcorder at a time to this recorder.
- You cannot control this recorder from external equipment connected via the DV IN jack (including two DVD recorders).
- It may not always be possible to control the connected camcorder via the DV IN jack.
- This recorder only outputs DVD video from the DV IN jack; signals from the built-in TV tuner, CD, Video CD, and other inputs cannot be output.
- Digital camcorders can usually record audio as stereo 16-bit/48kHz, or twin stereo tracks of 12-bit/32kHz. This recorder can only record one stereo audio track. Set DV Rec Audio to Audio 1 or Audio 2 as required (see page 25).
- Audio output from the DV IN jack is 16-bit only.
- Audio input to the DV IN jack should be 32 or 48kHz (not 44.1kHz).
- Picture disturbance on the recording may occur if the source component pauses playback or plays an unrecorded section of tape, or if the power fails in the source component, or the DV cable becomes disconnected.
- Although DV Rec Audio is set to Audio 2 and Audio 2 signal is not present, DV Rec Audio will be reset to Audio 1 automatically.

DV-Related Messages

You may see the following messages appear on your TV screen when using the DV IN jack.

Not connected to camcorder

The camcorder is not connected properly, or the camcorder is switched off.

Too many devices connected

The DV jack on this recorder supports connection to just one camcorder.

Check the tape

There is no cassette loaded into the connected equipment.

Uncontrollable device

This recorder cannot control the camcorder. Try switching off the camcorder then switching it back on.

Updating Information

Camcorder is updating information for DV.

Camera mode

Camcorder is set to camera mode.

Troubleshooting

If you can't get a picture and/or audio through the DV IN jack, check the bullet points:

- If the source signal is copy-protected, it will not be output through the DV IN jack.
- Make sure the DV cable is properly connected.
- Try switching off the connected equipment then switch back on.
- Try switching the audio input.
- Make sure that the Sampling Frequency setting is not set to 96kHz (see page 22).

Note

Depending on the connected camcorder, you may not be able to control it using the remote control supplied with this recorder.

VR Mode: Original and Playlist Editing

Edits you make to the Original content changes the actual content of the disc. For example, if you erase a title or chapter from the Original content (Title/Chapter List), that title or chapter is erased from the disc, freeing up extra recording time.

When you edit the Playlist, on the other hand, you are not changing the content of the disc. For example, when you erase a title from the Playlist (Program), you are just telling the recorder not to play that title; nothing is actually erased from the disc.

Titles and Chapters **VR**

Titles in the disc's original content contain one or more chapters.

When you insert a Original title into the Playlist (Program), all the chapters within that title also appear. In other words, chapters in the Playlist (Program) behave exactly as chapters on a DVD-Video disc. Adding a title or chapter to the Playlist (Program) creates a new title made up of chapters of an Original title. Erasing a chapter removes chapter of a title from the Original or Playlist (Program).

Caution

- When editing using the Erase, Add and Move functions, the start and end frames may not be exactly as set in the start and end point display.
- During Playlist playback, you may notice a momentary pause between edits. This is not a malfunction.

Adding Chapter Markers **VR**

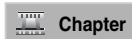

You can put a chapter marker anywhere in a Playlist or Original title during recording or playback. Once the chapter is marked, you can use the Chapter Search feature, as well as Erase, combine and move chapters in the Chapter List or Playlist (Program). You can insert up to 999 chapter markers in both the Original and Playlist contents.

Note

In Video mode, chapter markers are inserted at regular intervals automatically. You can change this interval from the Initial Setup menu (see Auto Chapter on page 25).

1 Play the title (Original or Playlist).

2 At the point you want to start a new chapter, press **CHP.MARK**.

- A chapter marker icon appears on the TV screen.
- You can also put chapter markers in during recording.

Using the Title List **VR**

The Title List is where you build and edit your Playlist, and where you can erase titles and make other changes to the Original content of the disc. You can also play individual titles directly from the Title List. The recorder must be stopped in order to edit using the Title List.

1 Press **REC LIST** to display the Title List.

- Use the **▲ / ▼** buttons to display the previous/next page if there are more than 6 titles/chapters.
- To exit the Title List, press **RETURN**.

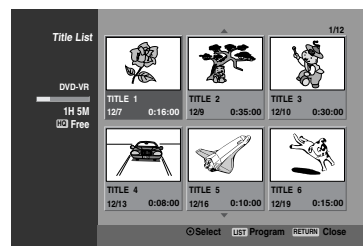

2 To switch between the Original (Title/Chapter List) and Playlist (Program) screens, press **REC LIST**.

The Title List and Program at the top of the screen indicate which you are in.

3 To view Title List options, select the title you want then press **ENTER**.

Title List options appears on the left side of the Title List display.

4 Use **▲ / ▼** to select an option then press **ENTER** to confirm.

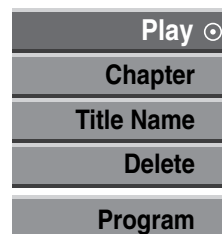

Play: Start playback the selected title.

Chapter: Moves Chapter List screen of the title. (page 42)

Title Name: Edits the title name. (page 42)

Delete: Deletes the title from the Title List. (page 44)

Program: Adds the title to the Program list. (page 43)

5 Press **RETURN** repeatedly to exit Title List.

Tip

Press **DISPLAY** to display more detailed title information for selected title.

VR Mode: Original and Playlist Editing (Continued)

Naming a Title **VR**

You can name Original and Playlist titles independently. Names can be up to 22 characters long.

- 1 Press REC LIST to display Title List.**
To switch between the Original (Title/Chapter List) and Playlist (Program) screens, press REC LIST.
- 2 Use ▲▼◀▶ to choose the title you want to name then press ENTER.**
Title List options appears on the left side of the Title List screen.
- 3 Use ▲/▼ to select 'Title Name' option from Title List options then press ENTER.**
Keyboard menu appears.

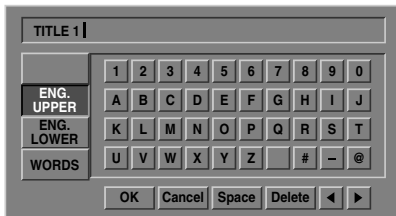

- 4 Enter a name for the disc. Use ▲▼◀▶ to select a character then press ENTER to confirm your selection.**
 - **ENG. UPPER:** Switches the keyboard upper case characters.
 - **ENG. LOWER:** Switches the keyboard to lower case characters.
 - **WORDS:** Switches the keyboard to theme word.
 - **OK:** Select to finish.
 - **Cancel:** Deletes all the characters input.
 - **Space:** Inserts a space at the cursor position.
 - **Delete:** Deletes the character at the cursor position.
 - **◀/▶:** Moves cursor to left or right.
- 5 Choose OK then press ENTER to fix the name and return to the Setup menu screen.**
- 6 Press RETURN repeatedly to exit Title List.**

Notes

- You can also use the CLEAR button to delete characters directly.
- Names can be up to 22 characters long.
- For discs formatted on a different DVD Recorder, you will see only a limited character set.

Using the Chapter List **VR**

- 1 Press REC LIST to display Title List.**
- 2 Use ▲▼◀▶ to choose the title you want to view Chapter List then press ENTER.**
Title List options appears on the left side of the Title List screen.
- 3 Use ▲/▼ to select 'Chapter' from Title List options then press ENTER.**
Chapter List appears on the TV screen.

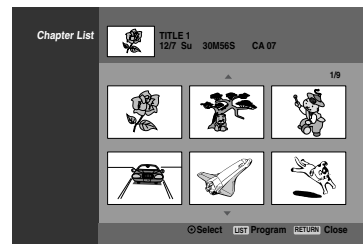

- 4 Use ▲/▼ to select an option then press ENTER to confirm.**
Chapter List options appears on the left side of the Chapter List screen.

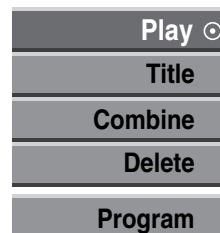

- Play:** Starts playback of the selected chapter.
- Title:** Moves to Title List screen. (page 41)
- Combine:** Combines two chapters into one. (page 45)
- Delete:** Deletes the chapter from the Chapter List. (page 44)
- Program:** Adds the chapter to the Program list. (page 43)

- 5 Press RETURN repeatedly to exit Chapter List.**

VR Mode: Original and Playlist Editing (Continued)

Making a New Playlist (Program) **VR**

Use this function to add an Original title or chapter to the Playlist (Program). When you do this, the whole title is put into the Playlist (you can erase bits you don't need later — see Erasing an Original or Playlist title/chapter on page 44).

The title appears in the Playlist complete with the chapter markers that appear in the Original. However, if you add more chapter markers to the Original later, these are not automatically copied over into the Playlist title.

You can add up to 99 chapters to one Playlist (Program) title or 999 chapters to one disc. If you only want to add a chapter of a title, use the Adding a title/chapter to the Playlist (Program) on page 43.

1 Press REC LIST to display Title List.

To switch between the Original (Title/Chapter List) and Playlist (Program) displays, press REC LIST. If you want to display the Chapter List screen, refer to "Using the Chapter List" on page 42.

2 Choose an Original title or chapter to put into the Playlist, then press ENTER.

Title List options appears on the left side of the Title List screen.



(Title List options) (Chapter List options)

3 Use ▲ / ▼ to select 'Program' from Title List or Chapter List options then press ENTER.

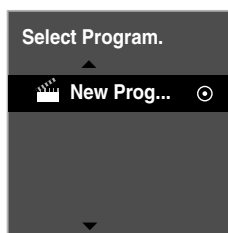

4 Select 'New Prog...' then press ENTER.

The new title appears in the updated Playlist (Program). All chapters of the title are added to the Playlist (Program).

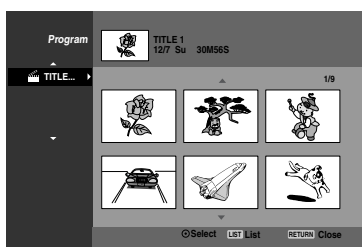

Adding Additional Title/Chapters to the Playlist (Program) **VR**

You can add an Original title/chapter to add to a Playlist title even if it is already registered.

1 Press REC LIST to display Title List.

To switch between the Original (Title/Chapter List) and Playlist (Program) displays, use REC LIST. If you want to show the Chapter List display, refer to "Using the Chapter List" on page 42.

2 Choose an Original title/chapter to put into the Playlist, then press ENTER.

Title List or Chapter List options appears on the left side of the Title List screen.

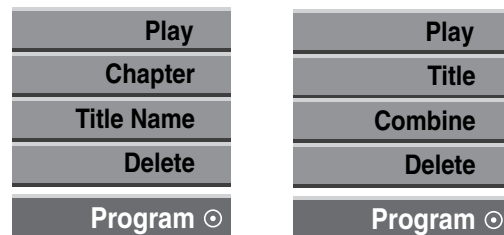

(Title List Options) (Chapter List Options)

3 Use ▲ / ▼ to select 'Program' from Title List or Chapter List options then press ENTER.

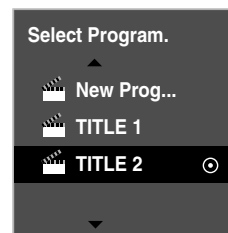

4 Choose the Playlist (Program) title that is already registered to insert a title/chapter, then ENTER.

The title appears in the updated Playlist.

5 Repeat steps 1-4 to add additional a part on the Playlist.

6 Press RETURN to exit, or REC LIST to go back to the Title List screen.

VR Mode: Original and Playlist Editing (Continued)

Changing Title or Chapter Thumbnails



Each title and chapter displayed in the Original (Title/Chapter List) or Playlist (Program) screen is represented by a thumbnail picture taken from the start of that title or chapter.

If you prefer, select a different still picture from within a title.

- 1 **Play the title (Original or Playlist).**
- 2 **Press THUMBNAIL to make the currently displayed picture the one that appears in the Original (Title/Chapter List) or Playlist (Program) display.**

The still picture that you choose appears in both the Original (Title/Chapter List) or Playlist (Program) display.

Using the Playlist (Program)

- 1 **Press REC LIST repeatedly to display the Playlist (Program).**
To switch between the Original (Title/Chapter List) and Playlist (Program) displays, use REC LIST.
- 2 **Use ▲ ▼ ◀ ▶ to choose a chapter or title then press ENTER.**
Playlist options appears on the left side of the Playlist (Program) screen.
- 3 **Use ▲ / ▼ to select an option then press ENTER to confirm.**



If you select a chapter.

Play: Starts playback from the chapter.

Move: Moves a chapter of Playlist (Program) to a position within the title. (page 45)

Combine: Combines two chapters into one. (page 45)

Del. Ch.: Deletes the chapter from the Playlist. (page 44)

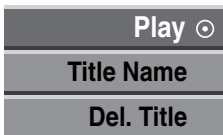

If you select a title.

Play: Starts playback of title.

Title Name: Edits the title name. (page 42)

Del. Title: Deletes the Playlist title from the Playlist. (page 44)

- 4 **Press RETURN repeatedly to exit Title List.**

Erasing an Original or Playlist Title/Chapter

When you erase a title or chapter from the Playlist (Program) screen, you only remove it from the Playlist; the title/chapter remains in the Original (Title/Chapter List).

If you choose to erase a title or chapter from the Original title/chapter list, the title or chapter is actually erased from the disc and the remaining time available for recording increases. Titles/chapters erased from the Original are also removed from the Playlist.

Note

It may not be possible to erase chapters that are less than 5 seconds long.

- 1 **Press REC LIST repeatedly to display Title List or Playlist (Program).**
If you want to display the Chapter List screen, refer to "Using the Chapter List" on page 42.
- 2 **Use ▲ ▼ ◀ ▶ to choose a chapter or title you want to erase then press ENTER.**
Playlist (program) or Original (Title/Chapter List) options appears on the left side of the screen.
- 3 **Use ▲ / ▼ to select 'Delete', 'Del. Ch.' or 'Del. Title' then press ENTER to confirm.**
After pressing ENTER, the new, updated title list is displayed.

e.g., If you select "Delete" on the Original (Title List).

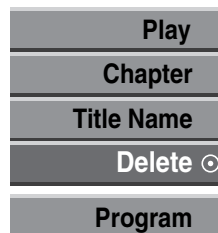

- 4 **Repeat steps 1 - 3 to continue to delete from the Original (Title/Chapter List) or Playlist (Program).**
- 5 **Press RETURN repeatedly to exit the Original (Title/Chapter List) or Playlist (Program) display.**

VR Mode: Original and Playlist Editing (Continued)

Combining Two Chapters Into One

VR

Use this function to combine two adjacent Playlist or Original chapters into one.

Note

This function is not available if there is only one chapter within the title.

1 Press REC LIST repeatedly to display Playlist (Program).

If you want to display the Chapter List, refer to "Using the Chapter List" on page 42.

2 First, select the second chapter of the two chapters you want to combine then press ENTER.

Playlist or Original (Chapter List) options appears on the left side of the screen.

3 Use ▲ / ▼ to select 'Combine'.

The combine indicator appears between the two chapters you want to combine.

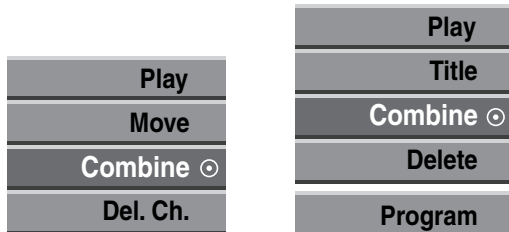

(Playlist Options)

(Chapter List Options)

4 Press ENTER to confirm.

After pressing ENTER, the updated Playlist is displayed.

Moving a Playlist Chapter

VR

Use this function to re-arrange the playing order of Playlist chapters within a title.

1 Press REC LIST repeatedly to display Playlist (Program).

Note

This function is not available if there is only one chapter.

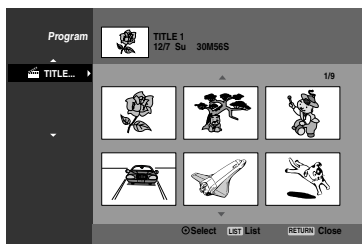

2 Select a chapter from the Playlist (Program).

3 Press ENTER.

Playlist (Program) options appears on the left side of the screen.

4 Use ▲ / ▼ to select 'Move' from Playlist options then press ENTER.



5 Use ▲ ▼ ◀ ▶ to choose the place you want to move the chapter to then press ENTER.

After pressing ENTER, updated Playlist is displayed.

Erasing a Section

VR

You can erase a section which you do not want in the title.

1 Starts playback.

2 Press DELETE A-B at the starting point (A) of the section you want to erase.

Progress bar appears on the TV screen and the recorder will now go into PAUSE mode.

3 Press ENTER.

Edit starts and progress is indicated in yellow on the Progress Bar.

You can cancel the Edit mode by pressing RETURN.



4 Press ENTER at the ending point (B) of the section you want to edit.

The recorder will now go into PAUSE mode. Then "Delete selected region? Proceed?" message will appear.

5 Use ◀ / ▶ to select "Yes" then press ENTER.

The selected section is erased then playback continues.

6 Repeat steps 2-5 to erase additional sections from the Program List.

Tips

- You can select starting (A) or ending (B) points by using ◀ / ▶ buttons in PAUSE mode.
- To change the position, you can select starting (A) or ending (B) point using ▲ / ▼ buttons during the edit.
- Use search and slow-motion to find the starting and ending points.

Video Mode: Original Editing

Using the Title List Video

From the Title List display you can play, name and erase titles.

Once a Video mode disc is finalized, the Title List screen changes its appearance and all you can do is select titles to play.

1 Press REC LIST to display the Title List.

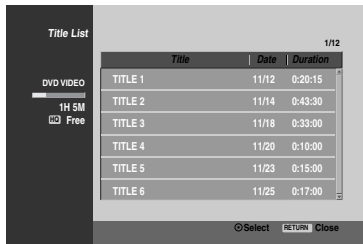

2 Use ▲ / ▼ to choose a title then press ENTER.

Title List options appears on the left side of the Title List display.

3 Use ▲ / ▼ to select an option then press ENTER to confirm.

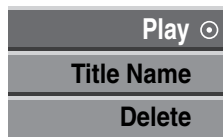

Play: Start playback the selected title.

Title Name: Edits the title name. (page 42)

Delete: Deletes the title from the Title List.

4 Press RETURN repeatedly to exit Title List.

Erasing a Title Video

Before a disc is finalized, you can erase titles recorded on the disc.

⚠ Caution

- If you erase a title from a DVD-R disc, the title will disappear from the Title List, but the available recording time will not increase.
- When erasing a title from a DVD-RW disc, the remaining time available for recording will only increase if it is the last title on the disc.

1 Press REC LIST to display Title List

2 Use ▲ ▼ ◀ ▶ to choose a title you want to erase then press ENTER.

Title List options appears on the left side of the Title List screen.

3 Use ▲ / ▼ to select 'Delete' then press ENTER to confirm.

After pressing ENTER, the new, updated title list is displayed.



4 Repeat steps 2-3 to delete additional titles from the Title List.

5 Press RETURN repeatedly to remove the Title List display.

If the disc has already been finalized

You should see a screen like the one below.

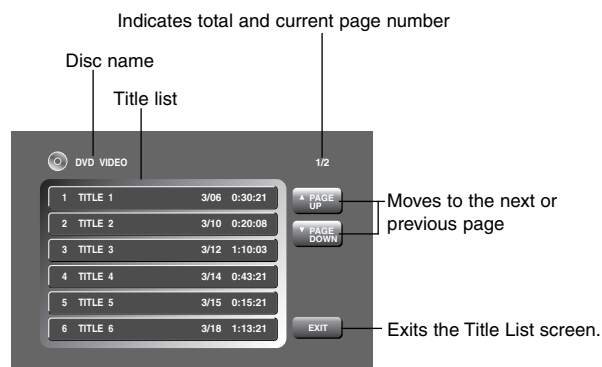

- Also you can exit the Title List display using TITLE or MENU.

Language Code List

Enter the appropriate code number for the initial settings "Disc Audio", "Disc Subtitle" and/or "Disc Menu" (See page 21).

Code	Language	Code	Language	Code	Language	Code	Language
6566	Abkhazian	7074	Fiji	7678	Lingala	8373	Singhalese
6565	Afar	7073	Finnish	7684	Lithuanian	8375	Slovak
6570	Afrikaans	7082	French	7775	Macedonian	8376	Slovenian
8381	Albanian	7089	Frisian	7771	Malagasy	8379	Somali
6577	Amharic	7176	Galician	7783	Malay	6983	Spanish
6582	Arabic	7565	Georgian	7776	Malayalam	8385	Sudanese
7289	Armenian	6869	German	7784	Maltese	8387	Swahili
6583	Assamese	6976	Greek	7773	Maori	8386	Swedish
6588	Aymara	7576	Greenlandic	7782	Marathi	8476	Tagalog
6590	Azerbaijani	7178	Guarani	7779	Moldavian	8471	Tajik
6665	Bashkir	7185	Gujarati	7778	Mongolian	8465	Tamil
6985	Basque	7265	Hausa	7865	Nauru	8484	Tatar
6678	Bengali; Bangla	7387	Hebrew	7869	Nepali	8469	Telugu
6890	Bhutani	7273	Hindi	7879	Norwegian	8472	Thai
6672	Bihari	7285	Hungarian	7982	Oriya	6679	Tibetan
6682	Breton	7383	Icelandic	8065	Panjabi	8473	Tigrinya
6671	Bulgarian	7378	Indonesian	8083	Pashto, Pushto	8479	Tonga
7789	Burmese	7365	Interlingua	7065	Persian	8482	Turkish
6669	Byelorussian	7165	Irish	8076	Polish	8475	Turkmen
7577	Cambodian	7384	Italian	8084	Portuguese	8487	Twi
6765	Catalan	7465	Japanese	8185	Quechua	8575	Ukrainian
9072	Chinese	7487	Javanese	8277	Rhaeto-Romance	8582	Urdu
6779	Corsican	7578	Kannada	8279	Romanian	8590	Uzbek
7282	Croatian	7583	Kashmiri	8285	Russian	8673	Vietnamese
6783	Czech	7575	Kazakh	8377	Samoan	8679	Volapük
6865	Danish	7589	Kirghiz	8365	Sanskrit	6789	Welsh
7876	Dutch	7579	Korean	7168	Scots Gaelic	8779	Wolof
6978	English	7585	Kurdish	8382	Serbian	8872	Xhosa
6979	Esperanto	7679	Laothian	8372	Serbo-Croatian	7473	Yiddish
6984	Estonian	7665	Latin	8378	Shona	8979	Yoruba
7079	Faeroese	7686	Latvian, Lettish	8368	Sindhi	9085	Zulu

Country Code List

Enter the appropriate code number for the initial setting "Country Code" (See page 24).

Code	Country	Code	Country	Code	Country	Code	Country
AD	Andorra	ER	Eritrea	LC	Saint Lucia	SC	Seychelles
AE	United Arab Emirates	ES	Spain	LI	Liechtenstein	SD	Sudan
AF	Afghanistan	ET	Ethiopia	LK	Sri Lanka	SE	Sweden
AG	Antigua and Barbuda	FI	Finland	LR	Liberia	SG	Singapore
AI	Anguilla	FJ	Fiji	LS	Lesotho	SH	Saint Helena
AL	Albania	FK	Falkland Islands	LT	Lithuania	SI	Slovenia
AM	Armenia	FM	Micronesia	LU	Luxembourg	SJ	Svalbard and Jan Mayen Islands
AN	Netherlands Antilles	FO	Faroe Islands	LV	Latvia	SK	Slovak Republic
AO	Angola	FR	France	LY	Libya	SL	Sierra Leone
AQ	Antarctica	FX	France (European Territory)	MA	Morocco	SM	San Marino
AR	Argentina	GA	Gabon	MC	Monaco	SN	Senegal
AS	American Samoa	GB	Great Britain	MD	Moldavia	SO	Somalia
AT	Austria	GD	Grenada	MG	Madagascar	SR	Suriname
AU	Australia	GE	Georgia	MH	Marshall Islands	ST	Saint Tome and Principe
AW	Aruba	GF	French Guyana	MK	Macedonia	SU	Former USSR
AZ	Azerbaijan	GH	Ghana	ML	Mali	SV	El Salvador
BA	Bosnia-Herzegovina	GI	Gibraltar	MM	Myanmar	SY	Syria
BB	Barbados	GL	Greenland	MN	Mongolia	SZ	Swaziland
BD	Bangladesh	GM	Gambia	MO	Macau	TC	Turks and Caicos Islands
BE	Belgium	GN	Guinea	MP	Northern Mariana Islands	TD	Chad
BF	Burkina Faso	GP	Guadeloupe (French)	MQ	Martinique (French)	TF	French Southern Territories
BG	Bulgaria	GQ	Equatorial Guinea	MR	Mauritania	TG	Togo
BH	Bahrain	GR	Greece	MS	Montserrat	TH	Thailand
BI	Burundi	GS	S. Georgia & S. Sandwich Isls.	MT	Malta	TJ	Tadjikistan
BJ	Benin	GT	Guatemala	MU	Mauritius	TK	Tokelau
BM	Bermuda	GU	Guam (USA)	MV	Maldives	TM	Turkmenistan
BN	Brunei Darussalam	GW	Guinea Bissau	MX	Mexico	TN	Tunisia
BO	Bolivia	GY	Guyana	MY	Malaysia	TO	Tonga
BR	Brazil	HK	Hong Kong	MZ	Mozambique	TP	East Timor
BS	Bahamas	HM	Heard and McDonald Islands	AN	Namibia	TR	Turkey
BT	Bhutan	HN	Honduras	NC	New Caledonia (French)	TT	Trinidad and Tobago
BV	Bouvet Island	HR	Croatia	NE	Niger	TV	Tuvalu
BW	Botswana	HT	Haiti	NF	Norfolk Island	TW	Taiwan
BY	Belarus	HU	Hungary	NG	Nigeria	TZ	Tanzania
BZ	Belize	ID	Indonesia	NI	Nicaragua	UA	Ukraine
CA	Canada	IE	Ireland	NL	Netherlands	UG	Uganda
CC	Cocos (Keeling) Islands	IL	Israel	NO	Norway	UK	United Kingdom
CF	Central African Republic	IN	India	NP	Nepal	UM	USA Minor Outlying Islands
CG	Congo	IO	British Indian Ocean Territory	NR	Nauru	US	United States
CH	Switzerland	IQ	Iraq	NU	Niue	UY	Uruguay
CI	Ivory Coast	IR	Iran	NZ	New Zealand	UZ	Uzbekistan
CK	Cook Islands	IS	Iceland	OM	Oman	VA	Vatican City State
CL	Chile	IT	Italy	PA	Panama	VC	Saint Vincent & Grenadines
CM	Cameroon	JM	Jamaica	PE	Peru	VE	Venezuela
CN	China	JO	Jordan	PF	Polynesia (French)	VG	Virgin Islands (British)
CO	Colombia	JP	Japan	PG	Papua New Guinea	VI	Virgin Islands (USA)
CR	Costa Rica	KE	Kenya	PH	Philippines	VN	Vietnam
CS	Former Czechoslovakia	KG	Kyrgyzstan	PK	Pakistan	VU	Vanuatu
CU	Cuba	KH	Cambodia	PL	Poland	WF	Wallis and Futuna Islands
CV	Cape Verde	KI	Kiribati	PM	Saint Pierre and Miquelon	WS	Samoa
CX	Christmas Island	KM	Comoros	PN	Pitcairn Island	YE	Yemen
CY	Cyprus	KN	Saint Kitts & Nevis Anguilla	PR	Puerto Rico	YT	Mayotte
CZ	Czech Republic	KP	North Korea	PT	Portugal	YU	Yugoslavia
DE	Germany	KR	South Korea	PW	Palau	ZA	South Africa
DJ	Djibouti	KW	Kuwait	PY	Paraguay	ZM	Zambia
DK	Denmark	KY	Cayman Islands	QA	Qatar	ZR	Zaire
DM	Dominica	KZ	Kazakhstan	RE	Reunion (French)	ZW	Zimbabwe
DO	Dominican Republic	LA	Laos	RO	Romania		
DZ	Algeria	LB	Lebanon	RU	Russian Federation		
EC	Ecuador			RW	Rwanda		
EE	Estonia			SA	Saudi Arabia		
EG	Egypt			SB	Solomon Islands		
EH	Western Sahara						

Troubleshooting

Check the following guide for the possible cause of a problem before contacting service.

Symptom	Cause	Solution
No power.	<ul style="list-style-type: none"> The power cord is disconnected. 	<ul style="list-style-type: none"> Plug the power cord into the wall outlet securely.
No picture.	<ul style="list-style-type: none"> The TV is not set to receive DVD Recorder signal output. 	<ul style="list-style-type: none"> Select the appropriate video input mode on the TV so the picture from the DVD Recorder appears on the TV screen.
	<ul style="list-style-type: none"> The video cable is not connected securely. 	<ul style="list-style-type: none"> Connect the video cable securely.
	<ul style="list-style-type: none"> The connected TV power is turned off. 	<ul style="list-style-type: none"> Turn on the TV.
No sound.	<ul style="list-style-type: none"> The equipment connected with the audio cable is not set to receive DVD Recorder signal output. 	<ul style="list-style-type: none"> Select the correct input mode on the audio receiver so you can listen to the sound from the DVD Recorder.
	<ul style="list-style-type: none"> The audio cables are not connected securely. 	<ul style="list-style-type: none"> Connect the audio cable securely.
	<ul style="list-style-type: none"> The power of the equipment connected with the audio cable is turned off. 	<ul style="list-style-type: none"> Turn on the equipment connected with the audio cable.
	<ul style="list-style-type: none"> The audio connecting cord is damaged. 	<ul style="list-style-type: none"> Replace it with new one.
The playback picture is poor.	<ul style="list-style-type: none"> The disc is dirty. 	<ul style="list-style-type: none"> Clean the disc.
The DVD Recorder does not start playback.	<ul style="list-style-type: none"> No disc is inserted. 	<ul style="list-style-type: none"> Insert a disc. (Check that the disc indicator in the display window is lit.)
	<ul style="list-style-type: none"> An unplayable disc is inserted. 	<ul style="list-style-type: none"> Insert a playable disc. (Check the disc type, color system, and regional code.)
	<ul style="list-style-type: none"> The disc is placed upside down. 	<ul style="list-style-type: none"> Place the disc with the playback side down.
	<ul style="list-style-type: none"> The disc is not placed within the guide. 	<ul style="list-style-type: none"> Place the disc on the disc tray correctly inside the guide.
	<ul style="list-style-type: none"> The disc is dirty. 	<ul style="list-style-type: none"> Clean the disc.
	<ul style="list-style-type: none"> The Rating level is set. 	<ul style="list-style-type: none"> Cancel the Rating function or change the rating level.
The picture from the external input is distorted	<ul style="list-style-type: none"> The video signal from the external component is copy-protected. 	<ul style="list-style-type: none"> You cannot connect via this recorder. Connect the component directly to your TV.
Some channels are skipped over when using CH (▲ / ▼)	<ul style="list-style-type: none"> Those channels were deleted with the CH ADD/DEL button. 	<ul style="list-style-type: none"> Use CH ADD/DEL button to restore channels. See "To Add or Erase Channels from Memory" on page 19.
The picture or sound of broadcasting channel is weak or missing.	<ul style="list-style-type: none"> Antenna or cables are loose. 	<ul style="list-style-type: none"> Tighten connections or replace cable.
	<ul style="list-style-type: none"> Wrong CHANNEL SOURCE option is being used. 	<ul style="list-style-type: none"> Try all TV Input options. See "Tuning Band" on page 19 for details.
Camcorder image is not shown.	<ul style="list-style-type: none"> Camcorder is off. 	<ul style="list-style-type: none"> Turn camcorder on and operate properly.
Camcorder image via A/V input or DV IN to DVD Recorder is not shown on TV screen.	<ul style="list-style-type: none"> DVD Recorder INPUT SELECT is not set to LINE1, LINE2 or DV IN. 	<ul style="list-style-type: none"> Use INPUT to select LINE input channel (LINE1, LINE2 or DV IN).

Troubleshooting (Continued)

Symptom	Cause	Solution
Can't play a disc recorded using this recorder on another player.	<ul style="list-style-type: none"> The disc was recorded in Video mode. 	<ul style="list-style-type: none"> Finalize the disc. (page 26)
	<ul style="list-style-type: none"> Some players will not play even a finalized disc recorded in Video mode. 	<ul style="list-style-type: none"> No solution.
	<ul style="list-style-type: none"> The disc was recorded in VR mode, 	<ul style="list-style-type: none"> The other player must be RW compatible in order to play it.
	<ul style="list-style-type: none"> Discs recorded with copy-once material cannot be played on other players. 	<ul style="list-style-type: none"> No solution.
Cannot record or did not record successfully.	<ul style="list-style-type: none"> The remaining blank space on the disc is insufficient. 	<ul style="list-style-type: none"> Use another disc.
	<ul style="list-style-type: none"> The source you are trying to record is copy protected. 	<ul style="list-style-type: none"> You cannot record the source.
	<ul style="list-style-type: none"> When setting the recording channel, the channel is tuned on the TV's own tuner. 	<ul style="list-style-type: none"> Select the channel on the recorder's built-in TV tuner.
	<ul style="list-style-type: none"> When recording to a Video mode disc, programs that are copy-once protected cannot be recorded. 	<ul style="list-style-type: none"> Use a VR mode formatted disc for copy-once material.
Timer recording is not possible.	<ul style="list-style-type: none"> Clock in DVD Recorder is not set to correct time. 	<ul style="list-style-type: none"> Set clock to correct time. See "Auto Clock Set" or "Manual Clock Set" on page 20.
	<ul style="list-style-type: none"> Timer has been programmed incorrectly. 	<ul style="list-style-type: none"> Reprogram Timer. See "Timer Recording" on page 38.
	<ul style="list-style-type: none"> TIMER indicator light does not appear after programming timer. 	<ul style="list-style-type: none"> Reprogram Timer.
Stereo Audio Record and/or Playback is not present.	<ul style="list-style-type: none"> TV is not Stereo-compatible. 	<ul style="list-style-type: none"> No solution.
	<ul style="list-style-type: none"> Broadcast program is not in stereo format. 	<ul style="list-style-type: none"> No solution.
	<ul style="list-style-type: none"> DVD Recorder A/V Out jacks are not connected to TV A/V In jacks. 	<ul style="list-style-type: none"> Make A/V connections. Stereo is available only via A/V output from DVD Recorder.
	<ul style="list-style-type: none"> DVD Recorder Audio/Video Out is not selected for viewing at the TV. 	<ul style="list-style-type: none"> Select AUX or A/V source as TV input.
	<ul style="list-style-type: none"> DVD Recorder's TV audio channel is set to SAP or MONO. 	<ul style="list-style-type: none"> Set TV audio channel mode to Stereo. See "Changing TV audio channel" on page 29.
The remote control does not work properly.	<ul style="list-style-type: none"> The remote control is not pointed at the remote sensor of the DVD Recorder. 	<ul style="list-style-type: none"> Point the remote control at the remote sensor of the DVD Recorder.
	<ul style="list-style-type: none"> The remote control is too far from the DVD Recorder. 	<ul style="list-style-type: none"> Operate the remote control within 23 ft (7 m).
	<ul style="list-style-type: none"> There is an obstacle in the path of the remote control and the DVD Recorder. 	<ul style="list-style-type: none"> Remove the obstacle.
	<ul style="list-style-type: none"> The batteries in the remote control are exhausted. 	<ul style="list-style-type: none"> Replace the batteries with new ones.

Moisture Condensation

Moisture condensation can occur:	In locations where moisture condensation may occur:
<ul style="list-style-type: none"> When the DVD Recorder is moved from a cold place to a warm place. Under extremely humid conditions. 	<ul style="list-style-type: none"> Keep the DVD Recorder plugged into an AC power outlet with POWER On. This will help prevent condensation. When condensation has occurred, wait a few hours for the DVD Recorder to dry before using it.

Specifications

General

Power requirements	AC 120V, 60 Hz
Power consumption	44W
Dimensions (approx.)	430 X 92 X 382.5 mm (16.9 x 3.6 x 15 inches) (w x h x d)
Mass (approx.)	6.4 kg (14.1 lbs)
Operating temperature	5°C to 35°C (41°F to 95°F)
Operating humidity	5 % to 90 %
Signal system	NTSC

Recording

Recording format	DVD VideoRecording, DVD-VIDEO
Recordable discs	DVD-ReRecordable, DVD-Recordable
Recordable time	Approx. 1 hour (HQ mode), 2 hours (SQ mode), 4 hours (LQ mode)
Video recording format	
Sampling frequency	27MHz
Compression format	MPEG 2
Audio recording format	
Sampling frequency	48kHz
Compression format	Dolby Digital

DVD Specifications

Laser system	Semiconductor laser, wavelength 650 nm
Frequency response	DVD (PCM 48 kHz): 8 Hz to 22 kHz, CD: 8 Hz to 20 kHz
Signal-to-noise ratio	More than 100 dB
Harmonic distortion	Less than 0.008%
Dynamic range	More than 95 dB

Inputs

ANTENNA IN	Antenna or CATV input, 75 ohms
VIDEO IN	1.0 Vp-p 75 ohms, sync negative, RCA jack x 2
AUDIO IN	0 dBm more than 47 kohms, RCA jack (L, R) x 2
DV IN	4 pin (i.LINK/IEEE 1394 standard)

Outputs

VIDEO OUT	1 Vp-p 75 Ω, sync negative, RCA jack x 1
S-VIDEO OUT	(Y) 1.0 V (p-p), 75 Ω, negative sync, Mini DIN 4-pin x 1 (C) 0.286 V (p-p) 75 Ω
COMPONENT VIDEO OUT	(Y) 1.0 V (p-p), 75 Ω, negative sync, RCA jack x 1 (Pb)/(Pr) 0.7 V (p-p), 75 Ω, RCA jack x 2
Audio output (digital audio)	0.5 V (p-p), 75 Ω, RCA jack x 1
Audio output (optical audio)	5 V (p-p), 75 Ω, Optical connector x 1
Audio output (analog audio)	2.0 Vrms (1 KHz, 0 dB), 600 Ω, RCA jack (L, R) x 1

Accessory:

Video cable1	Audio cable1
RF 75-ohm Coaxial Cable1	Blank DVD-RW disc1
Remote control1	Batteries2

- Design and specifications are subject to change without notice.

Manufactured under license from Dolby Laboratories. Dolby, Pro Logic and the double-D symbol are trademarks of Dolby Laboratories. Confidential unpublished works. Copyright 1992-1997 Dolby Laboratories. All rights reserved.

DTS and DTS Digital Out are registered trademarks of Digital Theater Systems, Inc.

**ZENITH ELECTRONICS CORPORATION
DVD Recorder DVR313 LIMITED WARRANTY – USA**



Zenith will repair or replace your product, at Zenith's option, if it proves to be defective in material or workmanship under normal use, during the warranty period ("Warranty Period") listed below, effective from the date ("Date of Purchase") of original consumer purchase of the product. This limited warranty is good only to the original purchaser of the product and effective only when used in the United States, excluding U.S. Territories.

<p>WARRANTY PERIOD:</p> <p>LABOR: 90 days from the Date of Purchase.</p> <p>Parts: One year from the Date of Purchase.</p> <p>* Parts replaced are warranted for the remaining portion of the original warranty period.</p>	<p>HOW SERVICE IS HANDLED:</p> <p>Carry-in Service: Please retain dealer's dated bill of sale or delivery ticket as evidence of the Date of Purchase for proof of warranty, and submit a copy of the bill of sale to the service person at the time warranty service is provided.</p> <p>Please call 1-877-9Zenith (1-877-993-6484) to locate your nearest Zenith Authorized Service Center.</p> <p>Or visit our website at http://www.zenithservice.com</p>
--	--

THIS WARRANTY IS IN LIEU OF ANY OTHER WARRANTIES, EXPRESS OR IMPLIED, INCLUDING WITHOUT LIMITATION, ANY WARRANTY OF MERCHANTABILITY OR FITNESS FOR A PARTICULAR PURPOSE. TO THE EXTENT ANY IMPLIED WARRANTY IS REQUIRED BY LAW, IT IS LIMITED IN DURATION TO THE EXPRESS WARRANTY PERIOD ABOVE. ZENITH WILL NOT BE LIABLE FOR ANY INCIDENTAL, CONSEQUENTIAL, INDIRECT, SPECIAL OR PUNITIVE DAMAGES OF ANY NATURE, EVEN IF ADVISED OF THE POSSIBILITY OF SUCH DAMAGES, INCLUDING WITHOUT LIMITATION, LOST REVENUES OR PROFITS, LOST OR CORRUPTED PROGRAMMING OR DATA, OR ANY OTHER DAMAGE WHETHER BASED IN CONTRACT, TORT OR OTHERWISE.

Some states do not allow the exclusion or limitation of incidental or consequential damages or limitation on how long an implied warranty lasts, so the above exclusion or limitation may not apply to you. This warranty gives you specific legal rights and you may also have other rights that may vary from state to state.

THIS LIMITED WARRANTY DOES NOT APPLY TO:

1. Damages or operating problems that result from shipping, installation, adjustment of user controls, calibration, maintenance or failure to maintain, or separate system components; and
2. Damages or operating problems that result from normal wear and tear, misuse, abuse, operation outside environmental specifications or contrary to the requirements or precautions in the Operating Guide, accident, lightning strikes or other natural causes, unauthorized modification or alteration, incorrect electrical current or voltage, signal reception or input, software not licensed directly by Zenith, software errors that do not disable functionality, operating and software protocols adopted after date of manufacture or for outside the US, institutional or commercial use, or other causes not arising out of defect in material or workmanship.
3. **Therefore, the cost of repair or replacement of such a defective product shall be borne by the consumer.**

CUSTOMER INTER-ACTIVE CENTER NUMBERS:

<p>For nearest Authorized Service Center, Where to buy, Product Assistance, or Customer Assistance</p>	<p>Call 1-877-9Zenith (1-877-993-6484) (Monday – Friday, 7 AM ~ 8 PM CT; and Saturday, 8 AM ~ 5 PM CT) and select appropriate option from the menu.</p> <p>Or visit our website at http://www.zenithservice.com</p>
---	---

ZENITH ELECTRONICS CORPORATION
2000 MILLBROOK DRIVE
LINCOLNSHIRE, IL 60069

Zenith Part No. 206-3891
GS# 3835RS0059B
Printed in Korea
Issue O

Free Manuals Download Website

<http://myh66.com>

<http://usermanuals.us>

<http://www.somanuals.com>

<http://www.4manuals.cc>

<http://www.manual-lib.com>

<http://www.404manual.com>

<http://www.luxmanual.com>

<http://aubethermostatmanual.com>

Golf course search by state

<http://golfingnear.com>

Email search by domain

<http://emailbydomain.com>

Auto manuals search

<http://auto.somanuals.com>

TV manuals search

<http://tv.somanuals.com>