



P/N: 55P5776

Converter Box

for the T221 Flat Panel Monitor

User's Guide

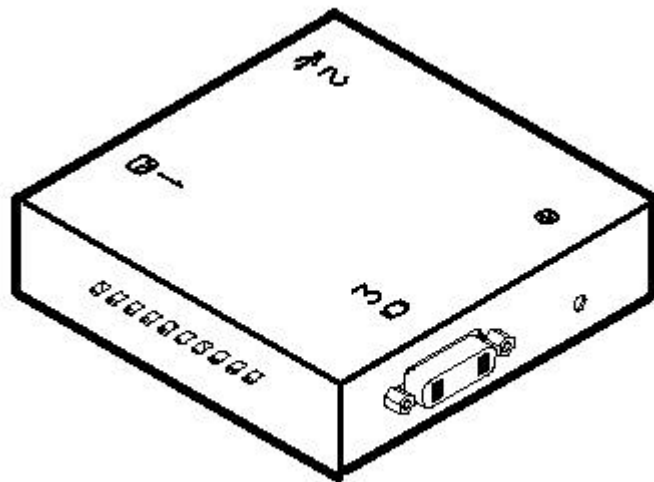



Preface

You will need a converter box if you are using an IBM T221 Flat Panel Monitor connected to a computer fitted with a graphics card that supports the DVI Dual Link interface. If your graphics card is not a dual-link type, do not use a converter box.

This manual describes the preparation required before using the converter box, how to connect the converter box to the monitor, how to adjust the monitor, and what to do if a problem occurs.

Trademarks

DVI is a trademark of the Digital Display Working Group (DDWG).

EDID is a trademark of the Video Electronics Standard Association (VESA).

ATI, FireGL, and RADEON are trademarks or registered trademarks of ATI Technologies Inc.

TMDS is a trademark of Silicon Image Incorporated.

nVIDIA, Quadro, FX-1000, FX-2000, and FX-3000 are trademarks or registered trademarks of nVIDIA Corporation.



Precautions for using the converter box safely and correctly



DANGER

To avoid electrical shock:

- **Never remove the cover of the converter box.**
- **Never connect or disconnect the converter box during an electrical storm.**
- **Any equipment to which the converter box is attached must also be connected to properly wired and grounded electrical outlets.**
- **The monitor to which the converter box is connected must be unplugged at the wall to disconnect it from the power supply. Connect the power plug into an easily accessible outlet.**

DANGER

Sequence for connecting and disconnecting cables

Electric current from the power cords and communication cables is hazardous. To avoid any risk of electrical shock, always connect and disconnect the cables as shown below when installing or moving the converter box or connected equipment, or when connecting other equipment.

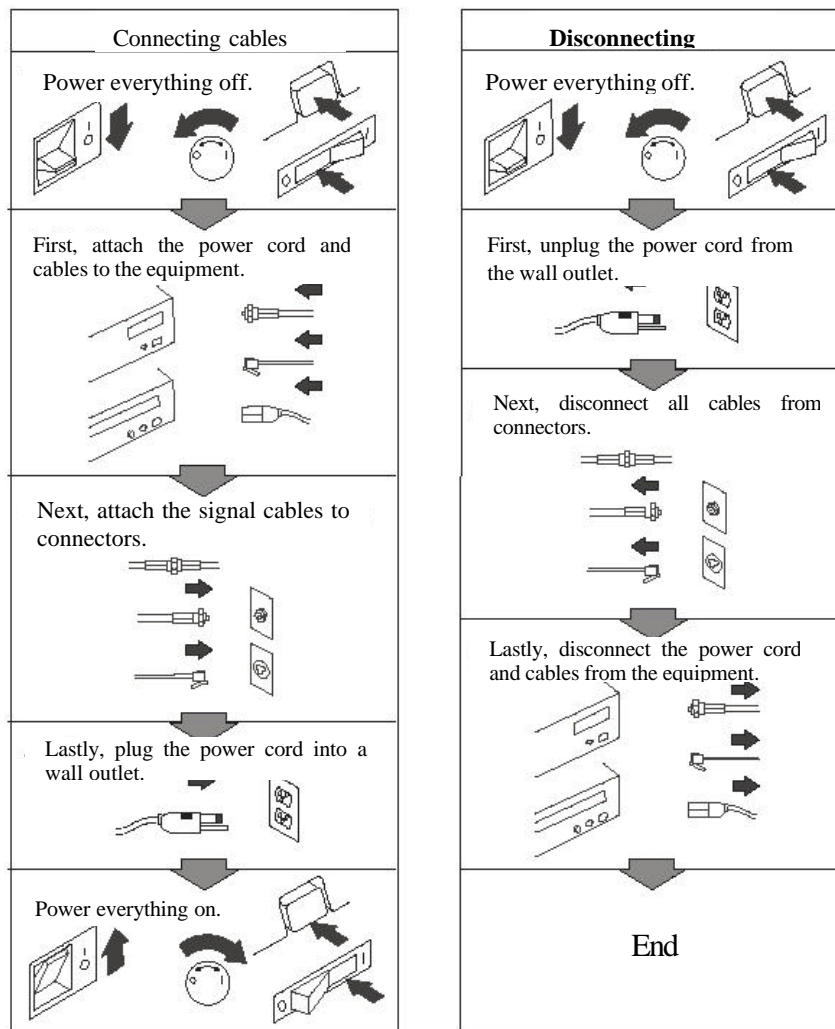



Contents

1. Preparation for Installation.....	6
1.1. Required System Configuration.....	6
1.2. Checking Parts.....	6
2. Connecting the Converter Box	7
2.1. Disconnecting the Existing Digital Signal Cable	7
2.2. Connecting the Converter Box Display Signal Cables	8
2.3. Setup	11
3. Changing the Monitor EDID Setting	11
4. Troubleshooting	12
Appendix A. Product Specifications	15
Appendix B. Regulatory Compliance	16

Figures

Fig. 1 Converter box.....	6
Fig. 2 USB cable (length 200cm approx.).....	6
Fig. 3 Converter signal cable (length 65cm approx.)	7
Fig. 4 User's guide (this book).....	7
Fig. 5 Dual Link signal cable (length 200cm approx.).....	7
Fig. 6 Dual Link	8
Fig. 7 Connection of the converter signal cable and the monitor.....	9
Fig. 8 Connection of the converter signal cable and the converter box.....	9
Fig. 9 Connection of the Dual Link signal cable and the converter box.....	10
Fig. 11 Connection of the Dual Link signal cable and a graphics card.....	10

Tables

Table 1 Problems and Actions.....	12
Table 2 Product specifications	15

1. Preparation for Installation

This chapter describes how to make sure that you have the required system configuration and components for using the converter box.

1.1. Required System Configuration

To use the converter box with an IBM T221 Flat Panel Monitor, you must have a computer fitted with a DVI-compliant graphics card that supports the DVI Dual Link interface.

See the T221 Flat-Panel Monitor Users Guide.

If your computer does not have a graphics card, install one before you use the converter box (for the installation procedure, see your graphics card manual). You can still get a picture on the monitor during card installation without using a converter box.

Important:

If you use a DVI video graphics card not supported by IBM, you will be liable for any damage or defects that may result. IBM offers no comments, advice, or guarantees regarding the functionality, quality, or performance of unsupported graphics cards.

The monitor firmware FPGA-LOGIC must be version 44, 48, 50, 52 or higher to use a converter box. See the T221 Flat-Panel Monitor Users Guide for more information.

1.2. Checking Parts

The converter box should be handled with care.

Check that you have the following components:

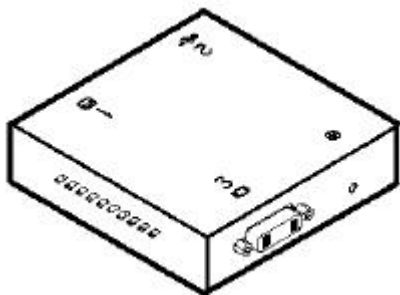
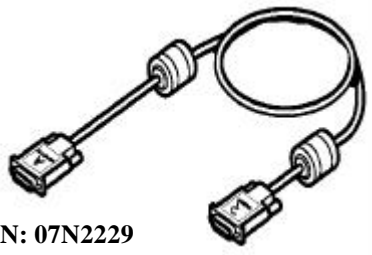

Fig. 1 Converter box



P/N: 55P5728

Fig. 2 USB cable (length 200cm approx.)



P/N: 07N2229

Fig. 3 Converter signal cable (length 65cm approx.)



Fig. 4 User's guide (this book)

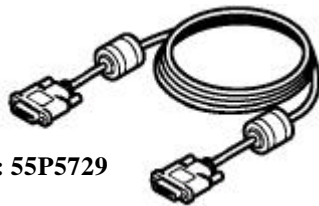

P/N: 55P5729

Fig. 5 Dual Link signal cable (length 200cm approx.)

Important:
Do not use other cables for T221 and the converter box.
Do not use these cables for other equipment than the T221 monitor and converter box.

2. Connecting the Converter Box

See your monitor manual for instructions and precautions on handling the monitor.

Important:
Use a large desk or table covered with a soft, thick cloth if you need to lay the monitor face down during installation. Make sure there are no pencils, clips, or other hard objects under the monitor screen, and avoid knocking or bumping the monitor. Such treatment could damage the monitor.

2.1. Disconnecting the Existing Digital Signal Cable

Power off both of the monitor and the computer.

Unplug the AC power cords of the monitor and computer from the wall outlets.

At the back of the monitor, remove the stand rear cover and connector cover, and disconnect the

digital signal cable. If two digital signal cables are attached, disconnect both.

Disconnect the digital signal cable from the computer. The disconnected digital signal cable is unnecessary with a converter box. Store the cable away.

Important:
Connecting or disconnecting cables while the monitor or computer is switched on may damage the computer or graphics card.

2.2. Connecting the Converter Box Display Signal Cables

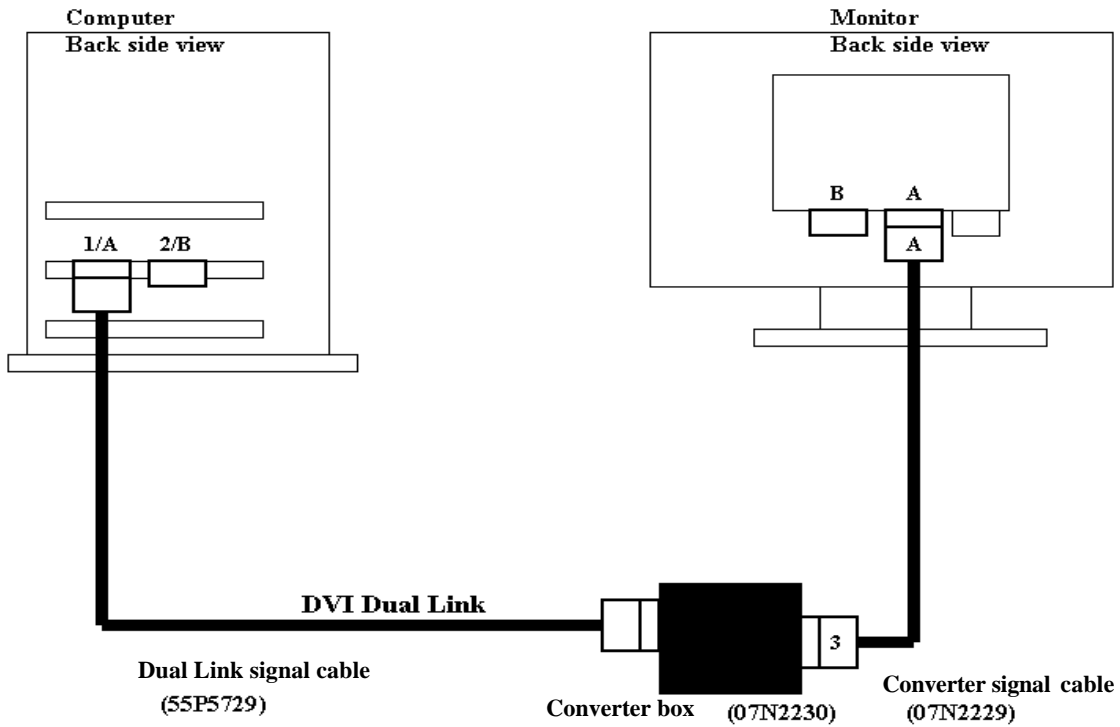

Fig. 6 Dual Link

Connect the end marked "A" of the converter signal cable (07N2229) to digital signal connector A at the rear of the monitor.

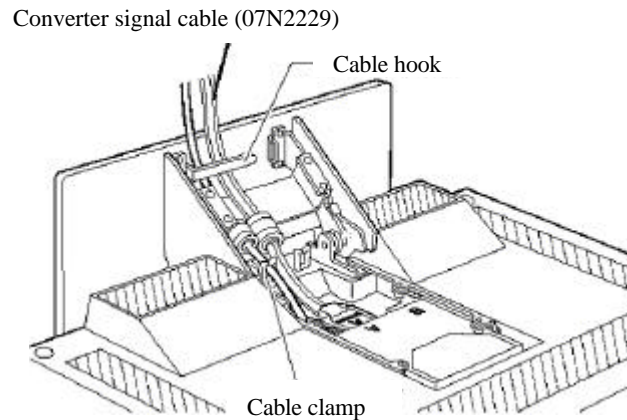

Fig. 7 Connection of the converter signal cable and the monitor

Connect the other end (marked "3") of the converter signal cable (07N2229) to the converter box.

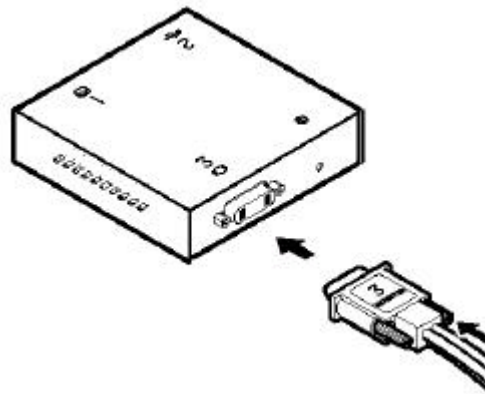

Fig. 8 Connection of the converter signal cable and the converter box

Connect the dual-link signal cable (55P5729) to the converter box.

It is only necessary to connect the USB cable (55P5728) to the converter box if you wish to use the monitor's Color Management Utility or Firmware Update Utility. In this case, the program(s) for either or both of those utilities must be installed prior to connecting the USB cable.

Important:

Do not connect the USB cable unless you are using the Color Management Utility or Firmware Update Utility.

Note:

The video input and video output are Safety Extra Low Voltage (SELV) circuits.

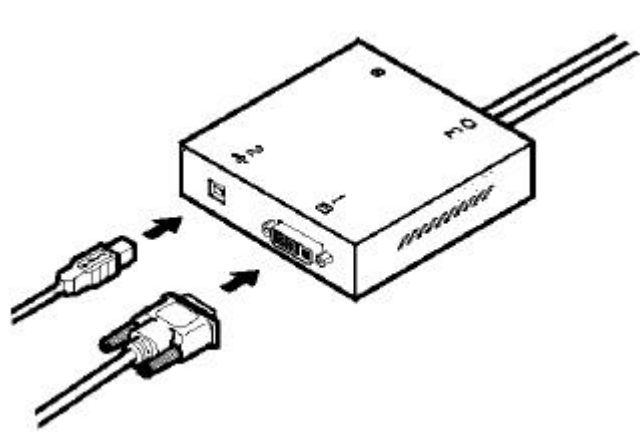

Fig. 9 Connection of the Dual Link signal cable and the converter box

Connect the opposite end of the dual-link signal cable (55P5729) to the computer.

If the computer graphics card has another connector that supports DVI Single Link out or Dual Link out in addition to the DVI Dual Link connector, connect the signal cable to the Dual Link connector. (The Dual Link connector is typically marked as "1" or "A". For details, see your graphics card manual or computer manual.)

The USB cable (55P5728) must also be connected to the computer to enable use of monitor's Color Management Utility or Firmware Update Utility.

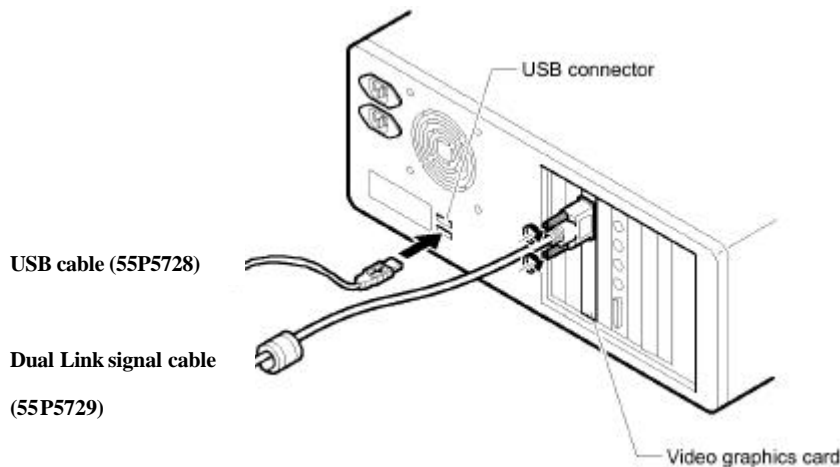

Fig. 11 Connection of the Dual Link signal cable and a graphics card



Important:

If the connector is not properly inserted, the computer or graphics card may be damaged when you power on the computer. Insert the connector straight and firmly so as not to bend the connector pins.

2.3.Setup

Replace the covers on the back of the monitor and return the monitor to the upright position. Plug the power cords of the monitor and computer into wall outlets.

The power lamp on the converter box should come on steady green, indicating normal operation. (The power lamp on the converter box does not come on unless the monitor is connected to an AC power supply.)

3. Changing the Monitor EDID Setting

Change the monitor's Extended Display Identification Data (EDID) setting to suit your particular graphics card. See the T221 Flat-Panel Monitor Users Guide for further information.

This completes converter box installation and setup.



4. Troubleshooting

This chapter explains what to do if a problem occurs while you are using the monitor.

Only problems related to the converter box are covered here. Refer also to your monitor manual for troubleshooting information.

Table 1 Problems and Actions

Problem	Cause and action
Blank screen (LED lamp on the monitor is steady amber or blinking amber.)	<p>Cause 1: No power to the converter box.</p> <p>Action 1: Power on the monitor and make sure that the monitor power lamp is steady amber or blinking amber. Then look at the power lamp on the converter box (next to the connector for the converter signal cable (07N2229)).</p> <p>If the lamp did not come on, the converter box has no power supply. Re-connect the cable between converter box and monitor, referring to the instructions in Chapter 2 for installing the converter box. Be sure to use the cable supplied with the converter box.</p> <p>If the lamp is green, the converter box is properly powered on. A green light with a blank screen means that the digital signal is disconnected somewhere. Check all the digital signal cable connections, referring to the instructions in Chapter 2 for installing the converter box.</p> <p>Cause 2: The monitor's EDID setting is incorrect.</p> <p>Action 2: Set the correct value for your graphics card, referring to the T221 Flat-Panel Monitor Users Guide.</p> <p>Cause 3: The converter box is connected only to the Connector-B of the monitor.</p> <p>Action 3: Connect the converter box to at least the Connector-A of the monitor, referring to the instructions in Chapter 2.</p>
Instead of one large screen, two identical side-by-side screens	<p>Cause 1: No converter box in use.</p> <p>Action 1: Use a converter box.</p>



<p>are squeezed together. Or, the text on the screen is distorted and unreadable.</p>	<p>Cause 2: The monitor has downlevel firmware that does not support a converter box. Action 2: Check the version of FPGA-LOGIC, as described in Chapter 1, Preparation for Installation. Dual-link (that is, a converter box) cannot be used with downlevel versions of FPGA-LOGIC. Use a display mode and EDID setting that does not require a converter box.</p>
	<p>Cause 3: Wrong cable connected between the converter box and computer. Action 3: Use the dedicated cable (dual-link signal cable (55P5729)) supplied with the converter box.</p>
	<p>Cause 4: Cable not attached properly. Action 4: Check the cable connections.</p>
	<p>Cause 5: The monitor's EDID setting is incorrect. Action 5: Set the correct value for your graphics card, referring to the T221 Flat-Panel Monitor Users Guide. Restart the system after making any changes.</p>
<p>Left half of the computer screen is displayed down the center of the monitor screen.</p>	<p>Cause 1: Cable not attached properly. Action 1: Check the cable connections.</p>
	<p>Cause 2: You are using an unsupported graphics card, or the device driver is downlevel. Action 2: Check that the graphics card is a supported type and that the latest level device drivers are being used (see the T221 Flat-Panel Monitor Users Guide for further information & details on how to access the web support page).</p>
<p>The left half and the right half of the computer screen interchange.</p>	<p>Cause 1: Cable not attached properly. Action 1: Check the cable connections.</p>
<p>The sizes of the left half and the right half of the computer screen differ.</p>	<p>Cause 1: Cable not attached properly. Action 1: Check the cable connections.</p>
	<p>Cause 2: The graphics card setting is incorrect. Action 2: Some graphics cards may require the video output setting changed, by using a software program associated with the graphics card. For details, refer to the user's manual for the graphics card.</p>



<p>The wrong display mode is displayed.</p>	<p>Cause 1: The converter box is not connected to the proper connector of the graphics card.</p> <p>Action 1: Connect the converter box to the connector supporting DVI Dual Link output, referring to the instructions in Chapter 2.</p> <p>Cause 2: The monitor's EDID setting is incorrect.</p> <p>Action 2: Set the correct value for your graphics card, referring to the T221 Flat-Panel Monitor Users Guide. Restart the system after making any changes.</p> <p>Cause 3: You are using an unsupported graphics card, or the device driver is downlevel.</p> <p>Action 3: Check that the graphics card is a supported type and that the latest level device drivers are being used (see the T221 Flat-Panel Monitor Users Guide for further information & details on how to access the web support page).</p> <p>Cause 4: The graphics card setting is incorrect.</p> <p>Action 4: Some graphics cards may require the video output setting changed, by using a software program associated with the graphics card. For the detail, refer to the user's manual for the graphics card.</p>
<p>The Color Management Utility or the Firmware Update Utility does not work.</p>	<p>Cause 1: The USB cable is connected to the connector B of the monitor.</p> <p>Action 1: Disconnect the USB cable, and then connect the USB cable to the converter box that is connected to the connector A of the monitor.</p>



Appendix A. Product Specifications

The following table shows the converter box specifications. They only apply when the converter box is used with the IBM T221 monitor.

Table 2 Product specifications

Item	Specification
Outer dimensions (converter box housing)	Width: 106.4 mm Height: 30.8 mm Depth: 107.6 mm
Weight (converter box housing)	350 g
Input voltage (supplied from monitor)	16 V
Power consumption (maximum)	3.5 W (maximum)
Video input	DVI™ Dual Link interface
Video output	TMDS™ interface (RGB: 8bits each)
Standards compliance	AN/NZS 3548 CISPR22 A FCC-A IEC 60950 3rd. Ed. UL 60950 3rd. Ed. / CSA C22.2 No. 60950-00 VCCI-A ISO 13406-2
Temperature	
Operating	0 ~ 35 deg C
Shipping (by air & within 24 hours)	-20 ~ 60 deg C
Storage / Shipping (other than above)	1 ~ 60 deg C
Humidity	
Operating	8 ~ 80 % (No Condensation)
Shipping (by air & within 24 hours)	8 ~ 80 % (No Condensation)
Storage / Shipping (other than above)	8 ~ 80 % (No Condensation)



Appendix B. Regulatory Compliance

Federal Communications Commission (FCC) Statement

IBM Converter box (P/N: 07N2230, FRU P/N: 13M3200)

This equipment has been tested and found to comply with the limits for a Class A digital device, pursuant to Part 15 of the FCC Rules. These limits are designed to provide reasonable protection against harmful interference when the equipment is operated in a commercial environment. This equipment generates, uses, and can radiate radio frequency energy and, if not installed and used in accordance with the instruction manual, may cause harmful interference to radio communications. Operation of this equipment in a residential area is likely to cause harmful interference, in which case the user will be required to correct the interference at his/her own expense.

Properly shielded and grounded cables and connectors must be used in order to meet FCC emission limits. IBM is not responsible for any radio or television interference caused by using other than recommended cables and connectors or by unauthorized changes or modifications to this equipment. Unauthorized changes or modifications could void the user's authority to operate the equipment.

This device complies with Part 15 of the FCC Rules. Operation is subject to the following two conditions: (1) this device may not cause harmful interference, and (2) this device must accept any interference received, including interference that may cause undesired operation.

Industry Canada Class A Emission Compliance Statement

This Class A digital apparatus complies with Canadian ICES-003.

Avis de Conformité à la Réglementation d'Industrie Canada

Cet appareil numérique de classe A est conforme à la norme NMB-003 du Canada.

Deutsche EMV - Direktive (electromagnetische Verträglichkeit)

Dieses Gerät ist berechtigt in Übereinstimmung mit dem deutschen EMVG vom 9.Nov.92 das EG-Konformitätszeichen zu führen.

Der Aussteller der Konformitätserklärung ist die IBM UK, Greenock.

Dieses Gerät erfüllt die Bedingungen der EN 55022 Klasse A. Für diese Klasse von Geräten gilt folgende Bestimmung nach dem EMVG:

Geräte dürfen an Orten, für die sie nicht ausreichend entstört sind, nur mit besonderer Genehmigung des Bundesministers für Post und Telekommunikation oder des Bundesamtes für Post und Telekommunikation betrieben werden. Die Genehmigung wird erteilt, wenn keine elektromagnetischen Störungen zu erwarten sind.



(Auszug aus dem EMVG vom 9.Nov.92, Para.3. Abs.4)

Hinweis: Dieses Genehmigungsverfahren ist von der Deutschen Bundespost noch nicht veröffentlicht worden.

European Union - EMC Directive

This product is in conformity with the protection requirements of the EU Council Directive 89/366/ECC on the approximation of the laws of the Member States relating to electromagnetic compatibility.

IBM cannot accept responsibility for any failure to satisfy the protection requirements resulting from a non-recommended modification of the product, including the fitting of non-IBM option cards.

This product has been tested and found to comply with the limits for Class A Information Technology Equipment according to CISPR 22/European Standard EN 55022. The limits for Class A equipment were derived for commercial and industrial environments to provide reasonable protection against interference with licensed communication equipment.

Warning: This is a Class A product. In a domestic environment this product may cause radio interference, in which case the user may be required to take adequate measures.

Union Européenne - Directive Conformité électromagnétique

Ce produit est conforme aux exigences de protection de la Directive 89/336/EEC du Conseil de l'UE sur le rapprochement des lois des États membres en matière de compatibilité électromagnétique.

IBM ne peut accepter aucune responsabilité pour le manquement aux exigences de protection résultant d'une modification non recommandée du produit, y compris l'installation de cartes autres que les cartes IBM.

Ce produit a été testé et il satisfait les conditions de l'équipement informatique de Classe A en vertu de CISPR22/Standard européen EN 55022. Les conditions pour l'équipement de Classe A ont été définies en fonction d'un contexte d'utilisation commercial et industriel afin de fournir une protection raisonnable contre l'interférence d'appareils de communication autorisés.

Avertissement: Ceci est un produit de Classe A. Dans un contexte résidentiel ce produit peut causer une interférence radio exigeant que l'utilisateur prenne des mesures adéquates.



Unione Europea - Normativa EMC

Questo prodotto è conforme alle normative di protezione ai sensi della Direttiva del Consiglio dell'Unione Europea 89/336/CEE sull'armonizzazione legislativa degli stati membri in materia di compatibilità elettromagnetica.

IBM non accetta responsabilità alcuna per la mancata conformità alle normative di protezione dovuta a modifiche non consigliate al prodotto, compresa l'installazione di schede e componenti di marca diversa da IBM.

Le prove effettuate sul presente prodotto hanno accertato che esso rientra nei limiti stabiliti per le apparecchiature di informatica Classe A ai sensi del CISPR 22/Norma Europea EN 55022. I limiti delle apparecchiature della Classe A sono stati stabiliti al fine di fornire ragionevole protezione da interferenze mediante dispositivi di comunicazione in concessione in ambienti commerciali ed industriali.

Avvertimento: Questo è un prodotto appartenente alla Classe A. In ambiente domestico, tale prodotto può essere causa di interferenze radio, nel qual caso l'utente deve prendere misure adeguate.

Unione Europea - Directiva EMC (Conformidad electromagnética)

Este producto satisface los requisitos de protección del Consejo de la UE, Directiva 89/336/CEE en lo que a la legislatura de los Estados Miembros sobre compatibilidad electromagnética se refiere.

IBM no puede aceptar responsabilidad alguna si este producto deja de satisfacer dichos requisitos de protección como resultado de una modificación no recomendada del producto, incluyendo el ajuste de tarjetas de opción que no sean IBM.

Este producto ha sido probado y satisface los límites para Equipos Informáticos Clase A de conformidad con el Estándar CISPR22 y el Estándar Europeo EN 55022. Los límites para los equipos de Clase A se han establecido para entornos comerciales e industriales a fin de proporcionar una protección razonable contra las interferencias con dispositivos de comunicación licenciados.

Advertencia: Este es un producto de Clase A. En un entorno doméstico este producto podría causar radiointerferencias en cuyo caso el usuario deberá tomar las medidas adecuadas.



電波障害自主規制届出装置の記述

この装置は、情報処理装置等電波障害自主規制協議会（VCCI）の基準に基づくクラスA 情報技術装置です。この装置を家庭環境で使用すると電波妨害を引き起こすことがあります。この場合には使用者が適切な対策を講ずるよう要求されることがあります。

Statements for Other Countries

警告使用者

這是甲類的資訊產品、在居住的環境中使用時、可能會造成射頻干擾、在這情況下、使用者會被要求採取某些適當的對策。

Free Manuals Download Website

<http://myh66.com>

<http://usermanuals.us>

<http://www.somanuals.com>

<http://www.4manuals.cc>

<http://www.manual-lib.com>

<http://www.404manual.com>

<http://www.luxmanual.com>

<http://aubethermostatmanual.com>

Golf course search by state

<http://golfingnear.com>

Email search by domain

<http://emailbydomain.com>

Auto manuals search

<http://auto.somanuals.com>

TV manuals search

<http://tv.somanuals.com>