

JVC

English

中文

MICRO COMPONENT MD SYSTEM

MD 微型组合音响

CA-UXJ55MD

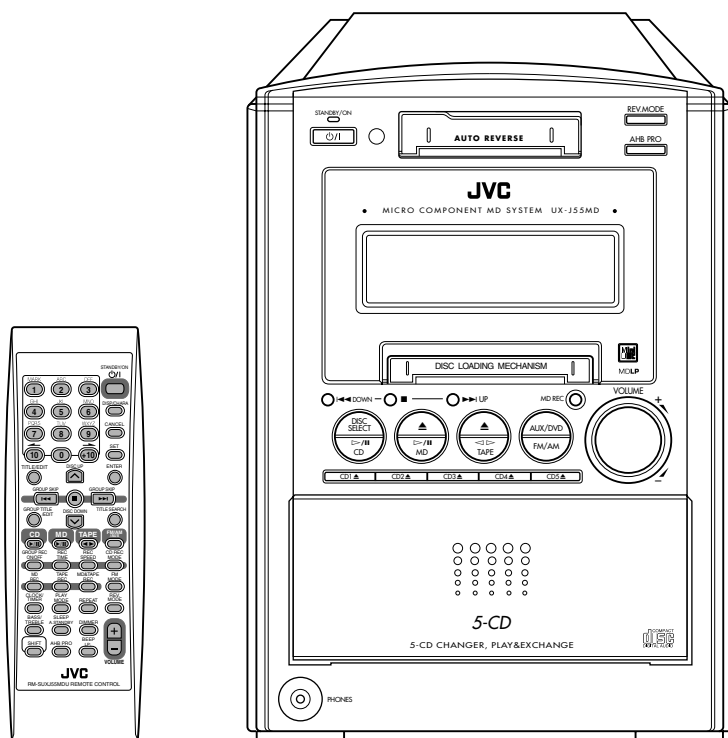

MDLP

COMPACT
disc
DIGITAL AUDIO

INSTRUCTIONS

使用说明书

Warnings, Cautions and Others

警告，注意及其他须知事项

CAUTION— button!

Disconnect the mains plug to shut the power off completely (the STANDBY/ON lamp goes off). The  button in any position does not disconnect the mains line.

- When the unit is on standby, the STANDBY/ON lamp lights red.
- When the unit is turned on, the STANDBY/ON lamp lights green.

The power can be remote controlled.

注意— 开关！

无论  开关在任何位置，电源线的电源还是没有被切断，若要将电源完全关闭，应把电源插头拔离插座（STANDBY/ON 灯熄灭）。

- 当主机正处于备用状态，STANDBY/ON 灯为红色。
- 当主机开启后，STANDBY/ON 灯为绿色。

电源开关可用遥控器控制。

CAUTION

To reduce the risk of electrical shocks, fire, etc.:

1. Do not remove screws, covers or cabinet.
2. Do not expose this appliance to rain or moisture.

注意

为了防止触电，火灾等危险：

1. 请勿擅自卸下螺丝钉，盖子或机壳。
2. 切勿让本机受雨淋或置于潮湿环境中。

CAUTION

- Do not block the ventilation openings or holes. (If the ventilation openings or holes are blocked by a newspaper or cloth, etc., the heat may not be able to get out.)
- Do not place any naked flame sources, such as lighted candles, on the apparatus.
- When discarding batteries, environmental problems must be considered and local rules or laws governing the disposal of these batteries must be followed strictly.
- Do not expose this apparatus to rain, moisture, dripping or splashing and that no objects filled with liquids, such as vases, shall be placed on the apparatus.

注意

- 请勿堵塞通风口或通风孔。
(如果通风口或通风孔被报纸或布等堵塞，热量将无法散出。)
- 请勿在本设备上放置任何裸露的火源，如点燃的蜡烛。
- 处理废弃电池时，必须考虑环境问题，并严格遵守当地关于处理废弃电池的有关法律或规定。
- 切勿将本装置暴露于雨水所及、潮湿、滴水或易于溅起水花的地方，亦不要将任何装满液体的物件（如花瓶）放置在本装置上。

IMPORTANT FOR LASER PRODUCTS

镭射产品的重要说明

REPRODUCTION OF LABELS / 说明文抄录

① CLASSIFICATION LABEL ON EXTERIOR SURFACE

① 位于机表的分类说明文

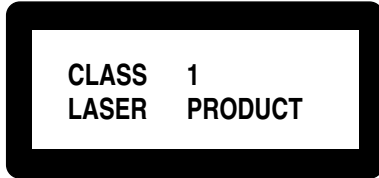

② WARNING LABEL INSIDE THE UNIT

② 位于机内的警告说明文

DANGER: Invisible laser radiation when open and interlock failed or defeated. AVOID DIRECT EXPOSURE TO BEAM. (e)

WARNING: Osynlig laserstrålning när denna del är öppnad och spärren är urkopplad. Betrakta ej strålen. (s)

ADVARSEL: Usynlig laserstrålning ved åbning, når sikkerhedsafbrydere er ude af funktion. Undgå udsættelse for strålning (d)

VARO: Avattaessa ja suojalukitus ohitettaessa olet alltiina näkymättömälle lasersäteilylle. Älä katso säteeseen. (f)

1. CLASS 1 LASER PRODUCT
2. **CAUTION:** Invisible laser radiation when open and interlock failed or defeated. Avoid direct exposure to beam.
3. **CAUTION:** Do not open the top cover. There are no user serviceable parts inside the Unit; leave all servicing to qualified service personnel.

1. 一级镭射产品
2. **注意:** 当内部锁定装置失效或者损坏后，打开盖板可能会产生不可见的镭射辐射。应避免受到光束直接照射。
3. **注意:** 请勿打开顶盖板，本机内部没有用户可自行维修的部件；所有维修工作应由有资格的人员完成。

Caution : Proper Ventilation

To avoid risk of electric shock and fire, and to prevent damage, locate the apparatus as follows:

1. Front : No obstructions and open spacing.
2. Sides / Top / Back : No obstructions should be placed in the areas shown by the dimensions below.
3. Bottom : Place on the level surface. Maintain an adequate air path for ventilation by placing on a stand with a height of 10 cm or more.

注意：正确通风

为避免发生触电和火警的危险，及防止本机受损，请将本机如下放置：

1. 前面：没有障碍物及地方开阔。
2. 侧面 / 顶面 / 背面：在图中所示范围中，不应放置任何障碍物。
3. 底部：放置在水平面上。放置在一个高 10 厘米或以上的台面上，以保持足够的通风道。

Front view

前面

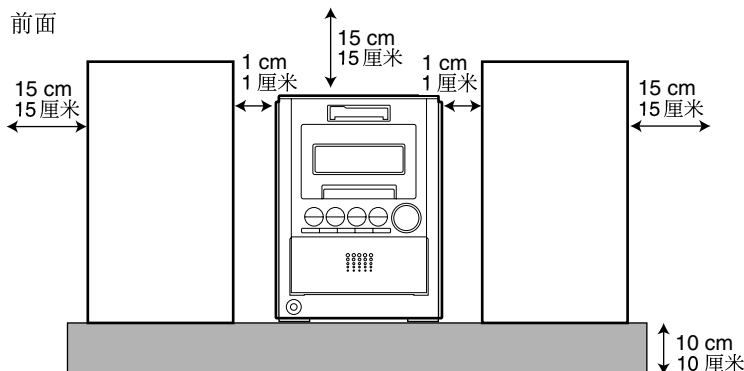

CA-UXJ55MD

Side view

侧面

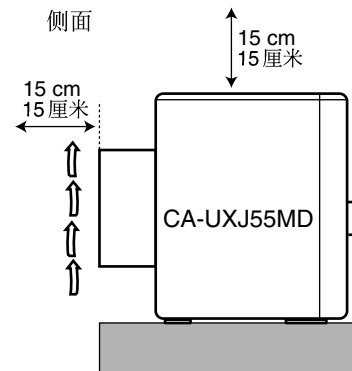

Introduction

We would like to thank you for purchasing one of our JVC products. Before operating this unit, read this manual carefully and thoroughly to obtain the best possible performance from your unit, and retain this manual for future reference.

About This Manual

This manual is organized as follows:

- **This manual mainly explains operations using the buttons on the remote control. You can use the buttons both on the remote control and on the unit for the same operations if they have the same or similar names (or marks), unless mentioned otherwise.**
- Basic and common information that is the same for many functions is grouped in one place, and is not repeated for each procedure. For instance, we do not repeat the information about turning on/off the unit, setting the volume, changing the sound effects, and others, which are explained in the section “Basic and Common Operations” on pages 9 to 12.
- The following symbols are used in this manual:



Gives you warning and caution to prevent damage or risk of fire/electric shock. In addition, we put information here about conditions which will prevent getting the best possible performance from the unit.



Gives you information and hints you need to know.

Precautions

Installation

- Install in a place which is level, dry and neither too hot nor too cold—between 5°C and 35°C.
- Install the unit in a location with adequate ventilation to prevent internal heat buildup.
- Leave sufficient distance between the unit and the TV.
- Keep the speakers away from the TV to avoid interference with TV.



DO NOT install the unit in a location near heat sources, or in a place subject to direct sunlight, excessive dust or vibration.

Power sources

- When unplugging the unit from the wall outlet, always pull on the plug, not the AC power cord.



DO NOT handle the AC power cord with wet hands.

Moisture condensation

Moisture may condense on the lenses inside the unit in the following cases:

- After starting to heat the room.
 - In a damp room.
 - If the unit is brought directly from a cold to a warm place.
- Should this occur, the unit may malfunction. In this case, leave the unit turned on for a few hours until the moisture evaporates, unplug the AC power cord, then plug it in again.

Others

- Should any metallic object or liquid fall into the unit, unplug the AC power cord and consult your dealer before operating any further.
- If you are not going to operate the unit for an extended period of time, unplug the AC power cord from the wall outlet.



DO NOT disassemble the unit since there are no user serviceable parts inside.

If anything goes wrong, unplug the AC power cord and consult your dealer.

Contents

Location of the Buttons and Controls	3	Recording on MDs	28
Front Panel	3	Before You Start Recording on an MD	28
Remote Control	5	Setting MD Recording Modes	30
Getting Started	6	Recording CD onto an MD	
Unpacking	6	—CD-MD Synchronized Recording	30
Connecting Antennas	6	Recording Other Sources onto an MD	32
Connecting Speakers	7	Recording on Tapes	33
Connecting External Equipment	8	Before You Start Recording on a Tape	33
Putting the Batteries into the Remote Control	8	Recording CD onto a Tape	
Basic and Common Operations	9	—CD-Tape Synchronized Recording	34
Setting the Clock	9	Recording onto a Tape	34
Turning On the Power and Starts Playback	10	Recording CD onto an MD and a Tape	
Turning On/Off the Key-touch Tone	10	—CD Synchronized Recording	36
Adjusting the Volume Level	11	Editing MDs	37
Reinforcing the Bass Sound	11	Guidance—MD Group Functions	37
Adjusting the Tone	12	Introducing Group Editing Functions	38
Changing the Display Brightness	12	Forming a Group—FORM GR	39
Listening to FM and AM Broadcasts	13	Adding a Track to a Group—ENTRY GR	40
Setting the AM Tuner Interval Spacing	13	Dividing a Group—DIVIDE GR	41
Tuning in to a Station	13	Joining Two Groups—JOIN GR	42
Presetting Stations	14	Moving a Group—MOVE GR	43
Tuning in to a Preset Station	14	Ungrouping Tracks—UNGROUP	44
Playing Back Discs on the 5-CD Changer	15	Dissolving All Groups—UNGR ALL	44
Loading Discs	15	Erasing Tracks in a Group—ERASE GR	45
Playing Back All the Discs—Continuous Play	15	Introducing Track Editing Functions	46
Start Continuous Play while a source other than “CD”		Dividing a Track—DIVIDE	47
is selected	16	Joining Two Tracks—JOIN	48
Basic Disc Operations	16	Moving a Track—MOVE	49
Programing the Track Playing Order		Erasing Tracks—ERASE	50
—Program Play	17	Erasing All Tracks—ALL ERASE	50
Playing at Random—Random Play	18	Assigning Titles to an MD	51
Repeating Tracks or Discs—Repeat Play	19	Using the Timers	54
Prohibiting Disc Ejection—Disc Lock	19	Using Recording Timer	54
Playing Back MDs	20	Using Daily Timer	56
Playing Back the Entire MD—Normal Play	20	Using Sleep Timer	58
Basic MD Operations	20	Timer Priority	58
Programing the Track Playing Order		Maintenance	59
—Program Play	22	Additional Information	60
Playing at Random—Random Play	23	MD Disc Types	60
Playing Tracks in a Group—Group Play	23	ATRAC (Adaptive TRansform Acoustic Coding)/	
Repeating Tracks—Repeat Play	24	ATRAC3 (MDLP)	60
Searching for Tracks to Play—MD Title Search	24	UTOC (User Table Of Contents)	60
Playing Back Tapes	26	Sound Skip Guard Memory	60
Playing Back a Tape	26	SCMS (Serial Copy Management System)	61
Listening to External Equipment	27	HCMS (High-speed Copy Management System)	61
Listening to External Equipment	27	CD/MD Messages	62
		Troubleshooting	63
		Specifications	64

Location of the Buttons and Controls

Become familiar with the buttons and controls on your unit.

Front Panel

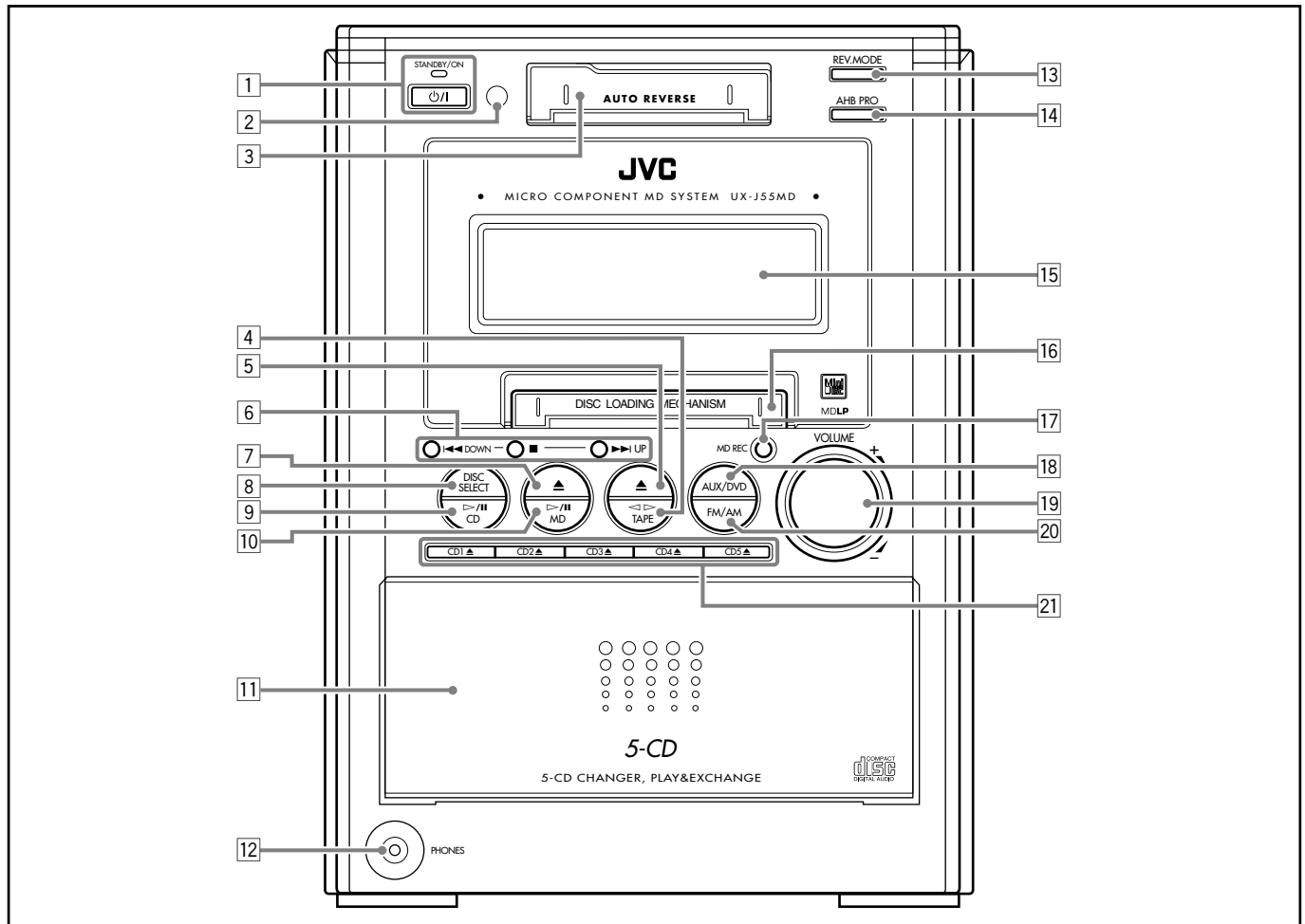

Front panel

See pages in parentheses for details.

- | | |
|--|--|
| <p>1 (standby/on) button and STANDBY/ON lamp (10, 13)</p> <p>2 Remote sensor (4)</p> <p>3 Cassette loading slot (26)</p> <p>4 (play/direction) TAPE button (10, 26, 32)</p> <ul style="list-style-type: none"> • Pressing this button also turns on the unit. <p>5 (TAPE eject) button (10, 26)</p> <ul style="list-style-type: none"> • Pressing this button also turns on the unit if the cassette is unlocked. <p>6 Multi operation buttons (13, 16 – 26, 31, 32, 34 – 36)</p> <p> (reverse)/ (fast-forward), DOWN/UP, (stop)</p> <p>7 (MD eject) button (10, 20, 22, 52, 53)</p> <ul style="list-style-type: none"> • Pressing this button also turns on the unit if the disc is unlocked. <p>8 DISC SELECT button (15, 16)</p> <p>9 (play/pause) CD button (10, 15, 16, 35)</p> <ul style="list-style-type: none"> • Pressing this button also turns on the unit. <p>10 (play/pause) MD button (10, 20, 34, 35)</p> <ul style="list-style-type: none"> • Pressing this button also turns on the unit. | <p>11 Disc trays compartment—5-CD changer (15, 17, 18, 30, 34, 36)</p> <p>12 PHONES jack (11)</p> <p>13 REV.MODE (reverse mode) button (26, 32, 35)</p> <p>14 AHB PRO (Active Hyper Bass Pro) button (11)</p> <p>15 Display window (4)</p> <p>16 MD loading slot (20)</p> <p>17 MD REC (recording) button (31, 32)</p> <p>18 AUX/DVD button (10, 27, 35)</p> <ul style="list-style-type: none"> • Pressing this button also turns on the unit. <p>19 VOLUME + / - control (11, 12, 27)</p> <p>20 FM/AM button (10, 13, 32, 34)</p> <ul style="list-style-type: none"> • Pressing this button also turns on the unit. <p>21 Disc eject buttons (10, 15, 16, 18, 19)</p> <p>CD1, CD2, CD3, CD4, and CD5</p> <ul style="list-style-type: none"> • Pressing one of these buttons also turns on the unit and opens the corresponding disc tray if the disc trays are unlocked. |
|--|--|

Display window on the front panel

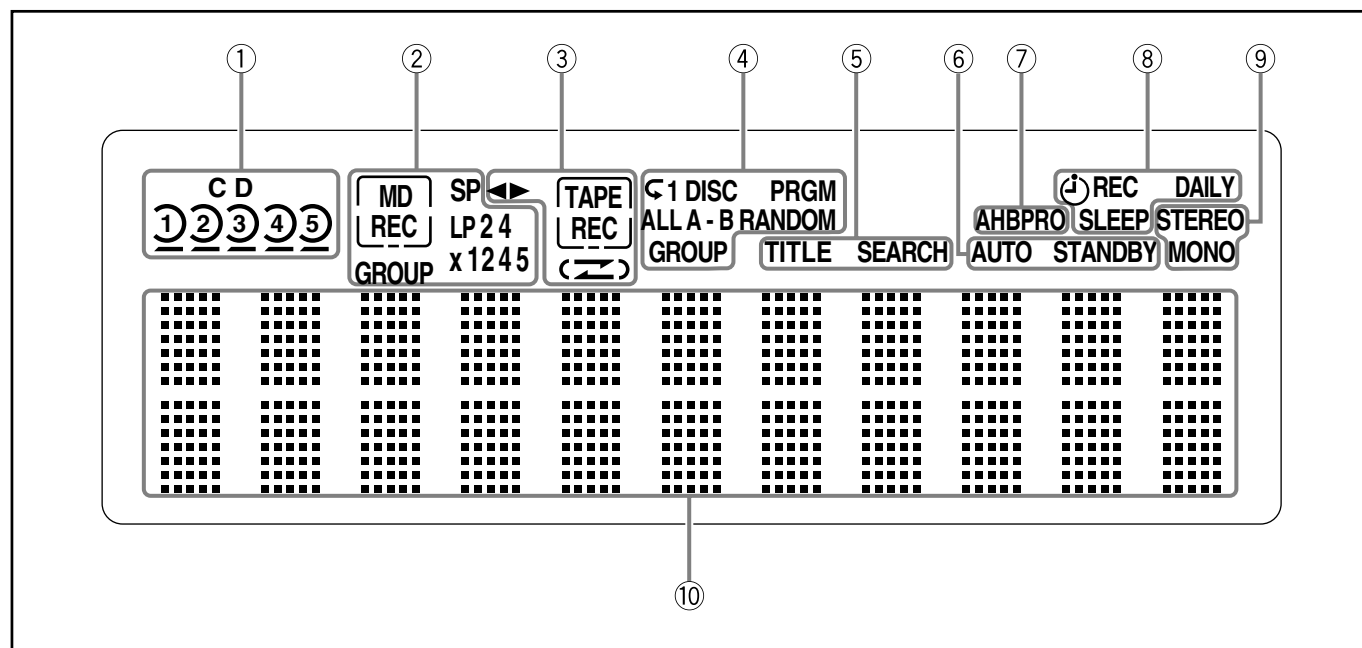

Display window

See pages in parentheses for details.

- ① CD operation indicators (15, 17 – 19, 34, 36)
 - CD indicator
 - Disc tray indicators
- ② MD operation indicators (20 – 25, 31, 32, 36, 39 – 45, 47 – 50, 52, 53)
 - MD indicator
 - REC (MD recording) indicator
 - GROUP indicator
 - Recording length mode indicators
SP, LP2, and LP4
 - Recording speed indicators
x1, x2, x4, and x5
- ③ Tape operation indicators (26, 34 – 36)
 - ◀▶ (tape direction) indicator
 - TAPE indicator
 - REC (tape recording) indicator
 - ⏮ (reverse mode) indicator
- ④ Play mode indicators (17 – 19, 22 – 24, 30)
 - Repeat mode indicators
↺ 1, ↺ 1 DISC, ↺ ALL, ↺ A - B
 - GROUP indicator
 - PRGM (program) indicator
 - RANDOM indicator
- ⑤ TITLE SEARCH indicator (24, 25)
- ⑥ AUTO STANDBY indicator (10)
- ⑦ AHBPRO (Active Hyper Bass Pro) indicator (11)
- ⑧ Timer indicators (54 – 58)
 - ⌚ (timer), REC (recording timer), SLEEP, DAILY
- ⑨ FM mode indicators (13)
 - STEREO and MONO
- ⑩ Main display
 - Shows the source name and other information.

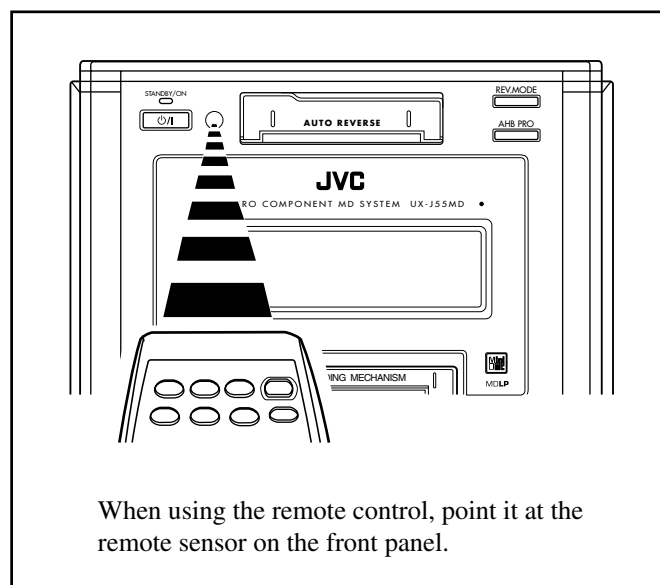

Remote Control

See pages in parentheses for details.

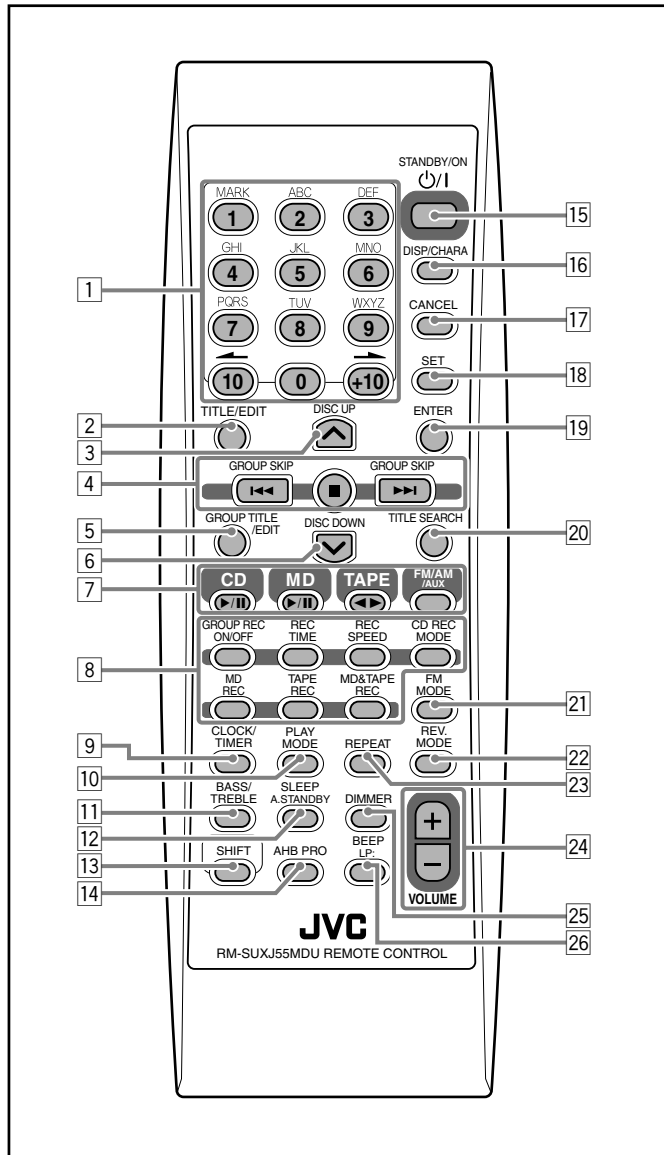

- 1 Number buttons
 - 1 – 10, 0 and +10 buttons (9, 14, 17, 21, 22, 25, 39 – 41, 47 – 50, 52, 55 – 57)
 - Character entry buttons (A – Z, 0 – 9) (25, 52)
 - MARK button (25, 52)
 - \blacktriangleleft and \blacktriangleright buttons (25, 47, 51 – 53)
- 2 TITLE/EDIT button (47 – 52)
- 3 DISC UP \blacktriangleup button (15 – 17, 30, 34, 56)
- 4 Multi operation buttons (9, 13 – 26, 31, 32, 34 – 36, 39 – 45, 47 – 50, 54 – 57)
 - $\blacktriangleleft\blacktriangleleft$ (reverse), $\blacktriangleright\blacktriangleright$ (fast-forward), GROUP SKIP $\blacktriangleleft\blacktriangleleft$ (reverse), GROUP SKIP $\blacktriangleright\blacktriangleright$ (fast-forward), \blacksquare (stop)
- 5 GROUP TITLE/EDIT button (39 – 45, 51, 52)
- 6 DISC DOWN \blacktriangledown button (15 – 17, 30, 34, 56)
- 7 Source selection buttons
 - CD $\blacktriangleright/\parallel$ (play/pause) button (10, 15 – 18, 30, 34 – 36)
 - MD $\blacktriangleright/\parallel$ (play/pause) button (10, 20, 22 – 24, 34, 35)
 - TAPE $\blacktriangleleft\blacktriangleright$ (play/direction) button (10, 26, 32)
 - FM/AM/AUX button (10, 13, 14, 27, 32, 34)

Pressing one of these buttons also turns on the unit.
- 8 Recording mode setting buttons
 - GROUP REC ON/OFF button (30)
 - REC TIME button (30)
 - REC SPEED button (30)
 - CD REC MODE button (31, 32)
 - MD REC button (31, 32)
 - TAPE REC button (34, 35)
 - MD&TAPE REC button (36)
- 9 CLOCK/TIMER button (9, 54 – 57)
- 10 PLAY MODE button (17, 18, 22 – 24)
- 11 BASS/TREBLE button (12)
- 12 SLEEP button (58)
- 13 A.STANDBY (Auto Standby) button (10)
- 14 SHIFT button (10, 23, 24, 30, 40 – 45)
- 15 AHB PRO (Active Hyper Bass Pro) button (11)
- 16 STANDBY/ON O/I button (10, 55, 57)
- 17 DISP/CHARA (display/character) button (10, 17, 21, 24, 27, 29, 31, 32, 35, 36, 52)
- 18 CANCEL button (9, 18, 22, 25, 39 – 45, 47 – 50, 52 – 57)
- 19 SET button (9, 14, 19, 27, 32, 39 – 45, 47 – 51, 53, 54 – 58)
- 20 ENTER button (25, 39 – 45, 47 – 50, 52, 53)
- 21 TITLE SEARCH button (24, 25)
- 22 FM MODE button (13)
- 23 REV.MODE (reverse mode) button (26, 32, 34 – 36, 54)
- 24 REPEAT button (19, 24)
- 25 VOLUME + / - buttons (11, 12, 27)
- 26 DIMMER button (9, 10, 12)
- 27 BEEP button (10)
- 28 LP: (prefix addition) button (30)

Unpacking

After unpacking, be sure that you have all the following items. The number in parentheses indicates the quantity of each piece supplied.

- FM antenna (1)
- AM loop antenna (1)
- Remote control (1)
- Batteries (2)

If any item is missing, consult your dealer immediately.

Connecting Antennas

FM antenna

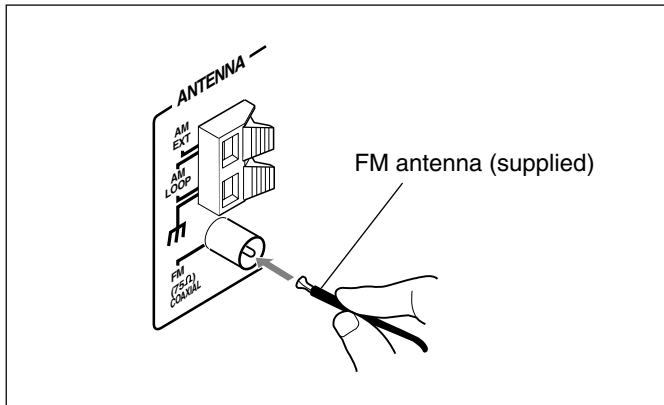

- 1 Attach the FM antenna to the FM (75 Ω) COAXIAL terminal.**
- 2 Extend the FM antenna.**
- 3 Fasten it up in a position which gives you the best reception, then attach it to the wall.**



About the supplied FM antenna

The FM antenna supplied with this unit can be used as a temporary measure. If reception is poor, you can connect an outdoor FM antenna.

To connect an outdoor FM antenna

Before connecting it, disconnect the supplied FM antenna.

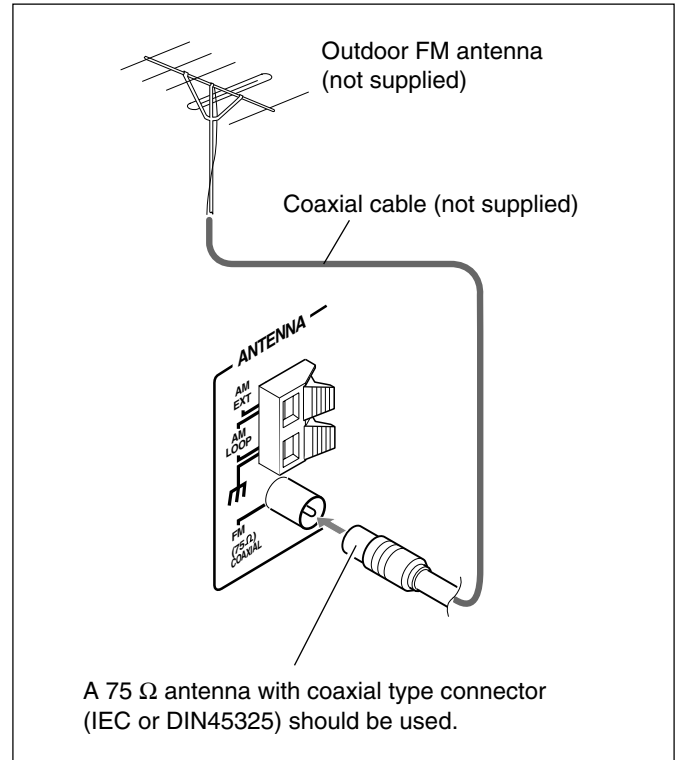

AM antenna

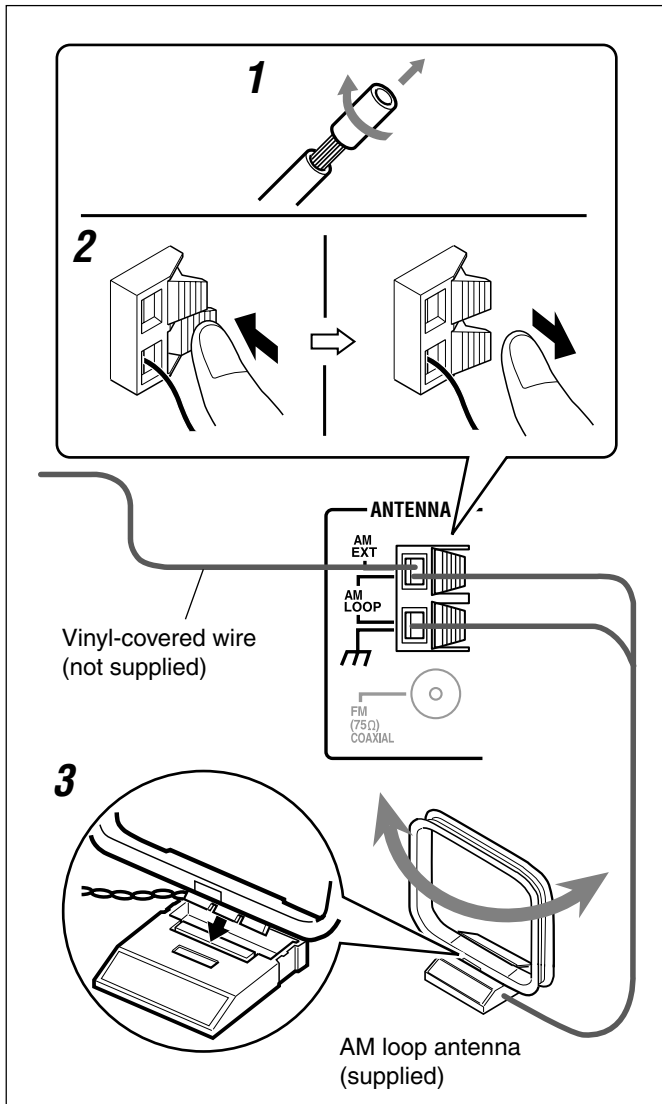

- 1** If the cords are covered with insulation, remove a short section of insulation at the end of each cord by twisting and pulling it off.
- 2** Connect the AM loop antenna to the AM LOOP terminals as illustrated.
- 3** Turn the AM loop antenna until you have the best reception.

To connect an outdoor AM antenna

When reception is poor, connect a single vinyl-covered wire to the AM EXT terminal and extend it horizontally. The AM loop antenna must remain connected.



For better reception of both FM and AM

- Make sure the antenna conductors do not touch any other terminals or connecting cords.
- Keep the antennas away from metallic parts of the unit, connecting cords, and the AC power cord.

Connecting Speakers

To connect speakers

You can connect the speakers using the speaker cords.

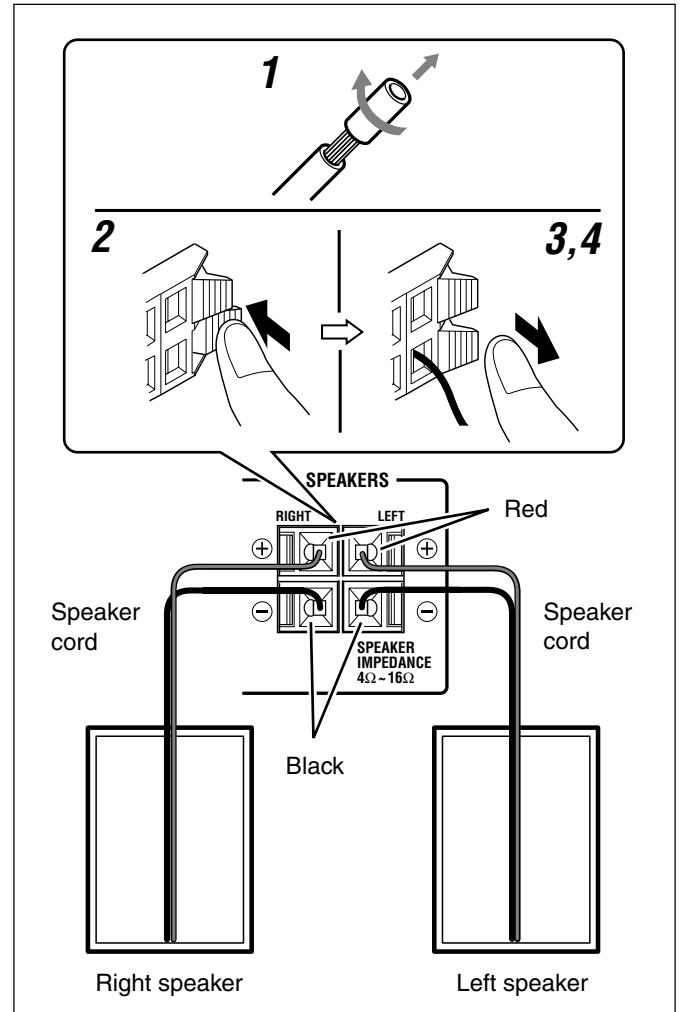

- 1** If the cords are covered with insulation, remove a short section of insulation at the end of each cord by twisting and pulling it off.
- 2** Hold the clamp of the speaker terminal.
- 3** Insert the end of the speaker cord into the terminal.
Match the polarity of the speaker terminals: Red cord to red terminal \oplus and black cord to black terminal \ominus .
- 4** Release your finger from the clamp.

IMPORTANT:

- Use only speakers with the same speaker impedance as indicated by the speaker terminals on the rear of the unit.
- DO NOT connect more than one speaker to one speaker terminal.

Connecting External Equipment

You can connect other equipment which can be used as a playback device.

When you connect and use the equipment, refer also to its manual supplied.



- DO NOT connect any equipment while the power is on.
- DO NOT plug in any equipment until all connections are complete.

To connect external equipment

Be sure that the plugs of the audio cords are color coded: White plugs and jacks are for left audio signals, and red ones for right audio signals.

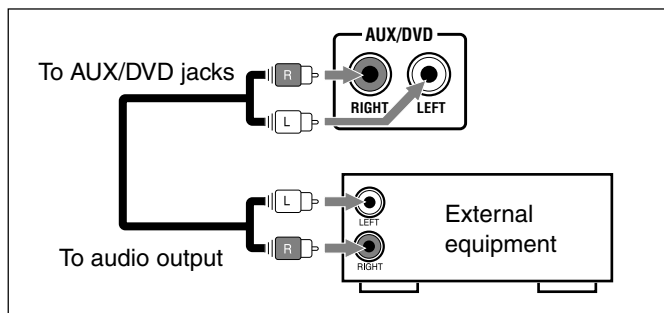

To play the other equipment through this unit, connect between the audio output jacks on the other equipment and AUX/DVD jacks by using audio cords (not supplied).

NOW you are ready to plug in the unit and any other connected equipment.

IMPORTANT:

Be sure to check that all connections have been made before plugging in the power cord.

Putting the Batteries into the Remote Control

Insert the batteries—R6S(SUM-3)/AA(15F)—into the remote control by matching the polarity (+ and –) on the batteries with the + and – marking on the battery compartment.

When the remote control can no longer operate the unit, replace both batteries at the same time.

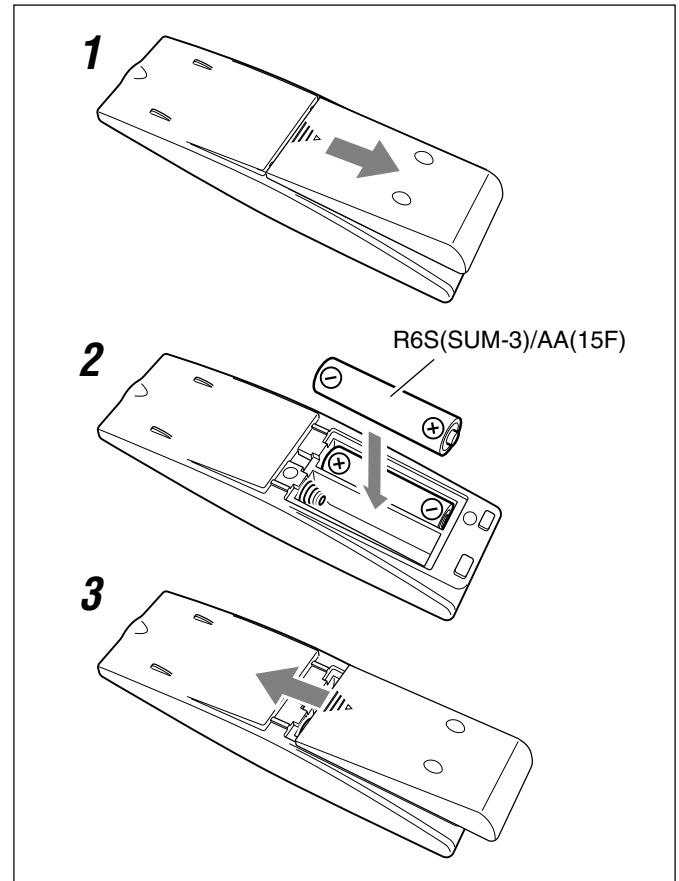

- DO NOT use an old battery together with a new one.
- DO NOT use different types of batteries together.
- DO NOT expose batteries to heat or flame.
- DO NOT leave the batteries in the battery compartment when you are not going to use the remote control for an extended period of time. Otherwise, the remote control will be damaged from battery leakage.

Basic and Common Operations

Setting the Clock

Before operating the unit any further, first set the built-in clock. When you plug in the power cord, "0:00" starts flashing on the display.

You can set the clock when the unit is either turned on or on standby (off). You cannot set the clock if the unit is on Power Save mode (see page 10).

On the remote control ONLY:

1 Press CLOCK/TIMER.

The hour digit starts flashing on the display.

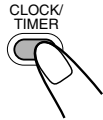
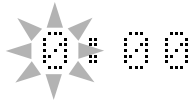

2 Press ►► or ◄◄ repeatedly to adjust the hour, then press SET.

The minute digits start flashing on the display.

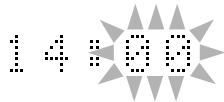

- Each time you press ►► or ◄◄, the hour digit(s) change(s) continuously.
- If you want to correct the hour again, press CANCEL. The hour digit(s) start(s) flashing again.

3 Press ►► or ◄◄ to adjust the minute, then press SET.

The built-in clock starts.



- Each time you press ►► or ◄◄, the minute digits change continuously.



Adjusting the hour and minute using the number buttons in steps 2 and 3

Ex.: To adjust the hour/minute to 5, press 5.

To adjust the hour/minute to 12, press +10, then 2.

To adjust the hour/minute to 20, press +10, then 10 (or press +10 twice, then 0).

- **When you unplug the power cord or if a power failure occurs**
The clock is reset to "0:00" right away. If this happens, set the clock again.
- **The clock may gain or lose 1 to 2 minutes per month**
If this happens, reset the clock.

To change the clock again

On the remote control ONLY:

Press CLOCK/TIMER repeatedly until the clock setting screen appears on the display.

The hour digit starts flashing. Then, perform steps 2 and 3 in "Setting the Clock" again.



To check the clock time with tones

When the key-touch tone is activated (see "Turning On/Off the Key-touch Tone" on page 10), the unit lets you know the time using long and short tones in different pitches ONLY while the unit is on standby (off).

On the remote control ONLY:

Press DIMMER while the unit is on standby (off).

"DIMMER OFF" appears, then the clock time is shown on the display with tones.



The time is represented by a four-digit number: two digits each for hours and minutes (ex. 2:58 = 0258).

Each digit is distinguished by a different pitch of tone, and numbers are made up of long and short tones.

The following shows the details.

Differentiation of digits:

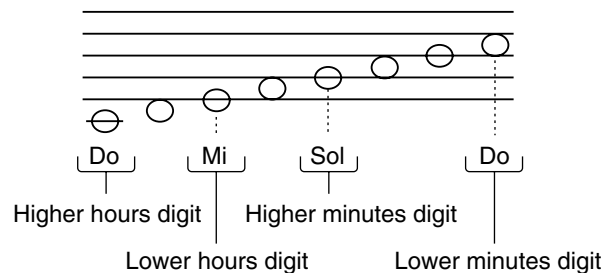

Representation of numbers:

Numbers	0	1	2	3	4
Tones	—	-	--	---	----
Numbers	5	6	7	8	9
Tones	•••••	•••••-	•••••--	•••••---	•••••----

* •••••: Five quick short tones

Ex.:

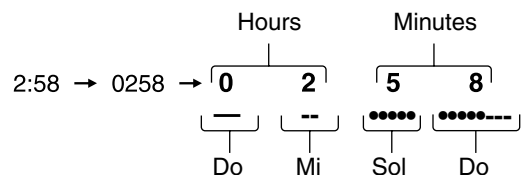

To turn off the clock indication (Power Save)

On the remote control ONLY:

Press **DISP/CHARA** while the unit is on standby (off).

“DISPLAY OFF” appears on the display for a while, then the clock indication goes off.



To turn on the clock indication, press **DISP/CHARA** again while the unit is on standby (off).

“DISPLAY ON” appears on the display for a while.

- Pressing **DIMMER** while the unit is on standby (off) will also activate the clock indication (see also “To check the clock time with tones” on page 9).

Turning On the Power and Starts Playback

To turn on the unit, press **STANDBY/ON** /I.

The **STANDBY/ON** lamp on the unit lights green.

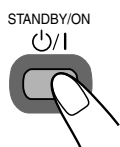



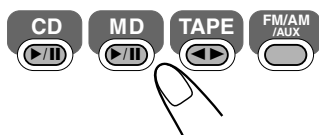

When you press one of the source selecting buttons, the unit automatically turns on (and starts playback if the source is ready).

On the remote control:

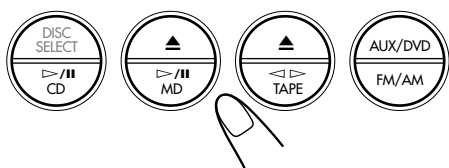

On the unit:



- Pressing one of the eject buttons on the unit—**CD1**  to **CD5** , **MD** eject  and **TAPE** eject —also turns on the unit if the disc trays, MD, and cassette are unlocked.
- When you press **FM/AM/AUX** repeatedly (or **AUX/DVD** on the unit) to operate the external equipment, see page 27 and the manuals supplied with it.

To turn off the unit (standby), press **STANDBY/ON** /I again. The **STANDBY/ON** lamp on the unit lights red.

- The clock time appears on the display if you have set the built-in clock. “0:00” will flash on the display if you have not set the built-in clock. To set the built-in clock, see “Setting the Clock” on page 9.
- A little power is always consumed even while the unit is on standby (off).

To switch off the power supply completely, unplug the AC power cord from the AC outlet.



When you unplug the AC power cord or if a power failure occurs

The clock is reset to “0:00” right away, while the tuner preset stations will be erased in a few days.

To turn off the unit automatically (Auto Standby)

Using Auto Standby, the unit automatically turns itself off (on standby) if no sound comes in for about 3 minutes except when **FM**, **AM**, or **AUX** is selected as the source.

If an operation is done within this 3-minute period, Auto Standby is canceled temporarily even though no sound comes in.

- You can also turn off the unit automatically by using the Sleep Timer. (See page 58.)

On the remote control ONLY:

To activate Auto Standby, press **A.STANDBY** while holding **SHIFT**.



“A.STANDBY ON” and the **AUTO STANDBY** indicator appear on the display.

- When no sound comes in, the **AUTO STANDBY** indicator starts flashing on the display. About 20 seconds before the unit turns itself off (on standby), “**AUTO STANDBY**” starts flashing on the display.

AUTO STANDBY indicator

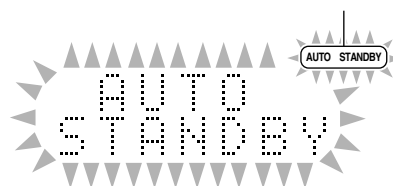

To deactivate Auto Standby, press **A.STANDBY** again while holding **SHIFT**.

“A.STANDBY OFF” appears on the display for a while and the **AUTO STANDBY** indicator goes off.

Turning On/Off the Key-touch Tone

If you do not want the key-touch tone to beep each time you press a button, you can deactivate it while the unit is turned on.

On the remote control ONLY:

Press **BEEP**.

- Each time you press the button, the key-touch tone turns on and off alternately.

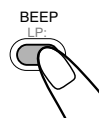

BEEP ON \longleftrightarrow BEEP OFF

Adjusting the Volume Level

You can adjust the volume level only while the unit is turned on. The volume level can be adjusted between “VOLUME 0” – “VOLUME 40.”

- The volume level has no effect on recording.

On the remote control:

To increase the volume level, press VOLUME +.

To decrease the volume level, press VOLUME –.

- When you press and hold either button, you can change the volume level continuously.



On the unit:

To increase the volume level, turn the VOLUME + / – control clockwise.

To decrease the volume level, turn the VOLUME + / – control counterclockwise.

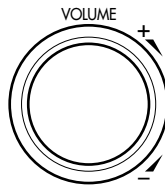

VOLUME 10



- If “CANNOT LISTEN” appears on the display
During high-speed recording (see page 29), you cannot listen to any source, and therefore, cannot adjust the volume level.
- For private listening
Connect a pair of headphones to the PHONES jack. No sound comes out of the speakers. Be sure to turn down the volume level before connecting or putting on the headphones.



DO NOT turn off (standby) the unit with the volume set to an extremely high level; otherwise, the sudden blast of sound can damage your hearing, speakers and/or headphones when you turn on the unit or start playing any source.
REMEMBER you cannot adjust the volume level while the unit is on standby (off).

Reinforcing the Bass Sound

The richness and fullness of the bass sound is clearly maintained regardless of how low you set the volume level —Active Hyper Bass Pro.

- This function only affects the playback sound, and does not affect your recording.
- This function also affects the sound from headphones.

To get the effect, press AHB PRO repeatedly.



The **AHBPRO** indicator also lights up on the display.



- Each time you press the button, the Active Hyper Bass Pro effect level changes as follows:

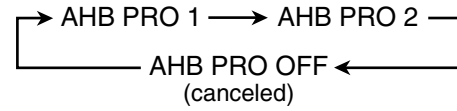

- “AHB PRO 2” is more effective than “AHB PRO 1.”

To cancel the effect, press AHB PRO repeatedly until “AHB PRO OFF” appears on the display.
The **AHBPRO** indicator goes off.

Adjusting the Tone

You can adjust the bass level (low frequency range) and the treble level (high frequency range) within a range of “-5” to “+5” only while the unit is turned on.

- This function only affects the playback sound, and does not affect your recording.
- This function also affects the sound from headphones.
- There is a time limit in doing the following steps. If the setting is canceled before you finish, start from step **1** again.

1 Press BASS/TREBLE to adjust the bass or treble level.

Current setting
 BASS 0
 Ex.: When you select “BASS.”



2 On the remote control:

Press **VOLUME +** to increase the level or press **VOLUME -** to decrease the level.



On the unit:

Turn **VOLUME + / -** control clockwise to increase the level or counterclockwise to decrease the level.

BASS +2

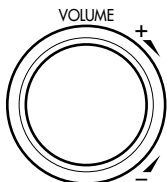

Changing the Display Brightness

You can change the display brightness only while the unit is turned on.

On the remote control ONLY:

Press **DIMMER** while the unit is turned on.

- Each time you press the button, the display brightness changes as follows:

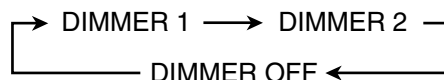
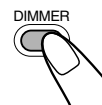

DIMMER 1: The display illumination dims.

DIMMER 2: The display illumination dims and the blue illumination on the display disappears.

DIMMER OFF: The display and blue illumination resumes.



Turning off (on standby) the unit sets the display brightness back to “DIMMER OFF.”

Listening to FM and AM Broadcasts

Setting the AM Tuner Interval Spacing

Some countries AM channel intervals are set to 9 kHz apart, and some countries use 10 kHz apart. When shipped, the built-in AM tuner is set to 9 kHz spacing. You can change the channel interval to 9 kHz or 10 kHz spacing.

On the unit ONLY:

To set the AM tuner to the 10 kHz spacing, be sure that the unit is turned off (on standby), but is plugged into a wall outlet. Press $\odot/|$ (standby/on) while holding $\blacktriangleright\blacktriangleright$. The unit turns on and tunes in to 530 kHz.



To set it back to the 9 kHz spacing, be sure that the unit is turned off (on standby), but is plugged into a wall outlet. Press $\odot/|$ (standby/on) while holding $\blacktriangleleft\blacktriangleleft$. The unit turns on and tunes in to 531 kHz.



When you change the AM channel interval spacing

The preset stations you have set (both FM and AM) will be erased. In this case, preset stations again. See "Presetting Stations" on page 14.

Tuning in to a Station

1 Press FM/AM/AUX (or FM/AM on the unit) to select either "FM" or "AM."



(On the remote control)

(On the unit)

The unit automatically turns on and tunes in to the previously received station—either FM or AM.

- Each time you press the button, the band changes as follows:

On the remote control:

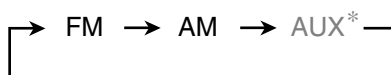

* For operating the external equipment, see page 27 and the manuals supplied with it.

On the unit:

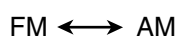

2 Press and hold $\blacktriangleright\blacktriangleright$ or $\blacktriangleleft\blacktriangleleft$ for more than 1 second.

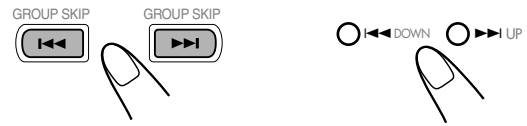

(On the remote control)

(On the unit)

- $\blacktriangleright\blacktriangleright$: Increases the frequencies.
- $\blacktriangleleft\blacktriangleleft$: Decreases the frequencies.

The unit starts searching for stations and stops when a station of sufficient signal strength is tuned in.

- If an FM program is broadcast in stereo, the **STEREO** indicator lights up on the display (only when the reception is good).

To stop during searching, press $\blacktriangleright\blacktriangleright$ or $\blacktriangleleft\blacktriangleleft$.



When you press $\blacktriangleright\blacktriangleright$ or $\blacktriangleleft\blacktriangleleft$ repeatedly

The frequency changes step by step.

To change the FM reception mode

When an FM stereo broadcast is noisy or hard to receive, you can change the FM reception mode to improve the reception.

On the remote control ONLY:

Press FM MODE so that the **MONO** indicator lights up on the display.

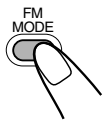

To restore the stereo effect, press FM MODE again so that the **MONO** indicator goes off. In stereo mode, you can hear stereo sound when a stereo program is broadcast.

- The **STEREO** indicator lights up only when the reception is sufficient.

Presetting Stations

You can preset 30 FM and 15 AM stations manually.

In some cases, test frequencies have been already stored for the tuner since the factory examined the tuner preset function before shipment. This is not a malfunction. You can preset the stations you want into memory by following the presetting method.

- There is a time limit in doing the following steps. If the setting is canceled before you finish, start from step **2** again.

On the remote control ONLY:

1 Tune in to the station you want to preset.

- See “Tuning in to a Station” on page 13.

2 Press SET.

“1” starts flashing on the display.

FM 1 87.50 MHz

Ex.: When you select an FM station in step 1.

3 Press ►► or ◀◀ to select a preset number.

FM 14 87.50 MHz

Ex.: When you select preset number 14.

You can also select the preset number using the number buttons.

- Ex.: For preset number 5, press 5.
 For preset number 15, press +10, then 5.
 For preset number 20, press +10, then 10.
 For preset number 30, press +10, +10, then 10.



4 Press SET again.

“STORED” appears on the display for a while.

STORED

The tuned station in step **1** is stored in the preset number selected in step **3**.

- Storing a new station on an already assigned number erases the previously stored one.



When you unplug the AC power cord or if a power failure occurs

The FM and AM preset stations will be erased in a few days. If this happens, preset the stations again.

Tuning in to a Preset Station

On the remote control ONLY:

1 Press FM/AM/AUX to select either “FM” or “AM.”

The unit automatically turns on and tunes in to the previously received station—either FM or AM.

- Each time you press the button, the band changes as follows:



* For operating the external equipment, see page 27 and the manuals supplied with it.

2 Press the number buttons to select the preset number you want.

Ex.: For preset number 5, press 5.

For preset number 15, press +10, then 5.

For preset number 20, press +10, then 10.

For preset number 30, press +10, +10, then 10.

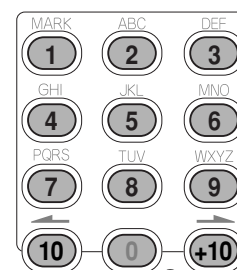

Playing Back Discs on the 5-CD Changer

This unit has been designed to play back the following discs—CD, CD-R, and CD-RW.

When playing a CD-R or CD-RW

User-edited CD-Rs (CD-Recordable) and CD-RWs (CD-ReWritable) can be played only if they are already “finalized.”

- Usually you can play back your original CD-Rs or CD-RWs recorded in audio CD format. However, sometimes they may not play depending on their characteristics or recording conditions.
- Before playing CD-Rs or CD-RWs, read their instructions or cautions carefully.
- Some CD-Rs or CD-RWs may not play on this unit because of their disc characteristics, damage or stain on them, or if the player’s lens is dirty.
- CD-RWs may require a longer readout time. This is because the reflectance of CD-RWs is lower than for regular discs.

Loading Discs

On the unit ONLY:

1 Press one of the disc eject buttons (CD1▲ – CD5▲) for the disc tray you want to load a disc onto.

The unit automatically turns on and the selected disc tray comes out if it is unlocked. See “Prohibiting Disc Ejection—Disc Lock” on page 19.



- Disc tray is counted from bottom to top. The bottom tray is disc tray 1 and top tray is disc tray 5.

2 Place a disc correctly on the circle of the disc tray, with its label side up.

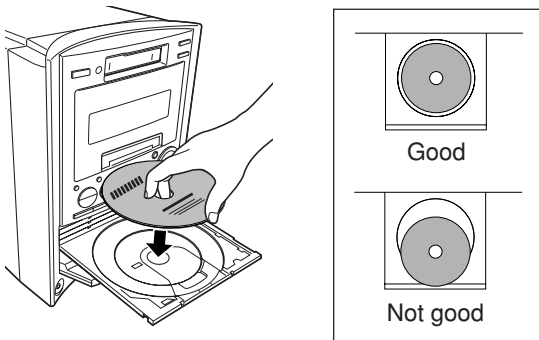

- When using a CD single (8 cm), place it on the inner circle of the disc tray.

3 Press the same disc eject button (CD1▲ – CD5▲) you have pressed in step 1.

The disc tray closes.

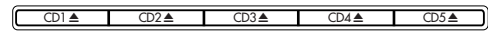

When loading more than one disc at a time

Press the disc eject button (CD1▲ – CD5▲) for the next tray you want to place a disc onto. The first disc tray automatically closes and the next disc tray comes out.

Playing Back All the Discs—Continuous Play

You can play discs continuously.

1 Load discs into the 5-CD changer.

- See “Loading Discs” on the left column.

2 Press DISC UP ▲ or DISC DOWN ▼ (or DISC SELECT on the unit) repeatedly to select the disc you want.



(On the remote control)



(On the unit)

Playback starts from the first track of the selected disc.

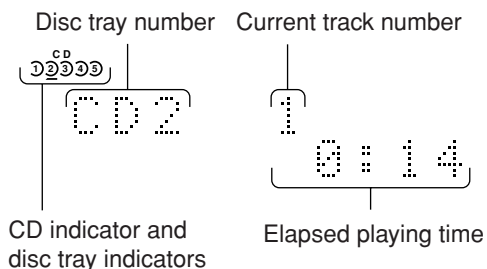

- You can also select a disc and start continuous play while a source other than “CD” is selected (see page 16).
- You can also select and start playback a desired track of the selected disc (see “To go to another track” on page 16 and “To go to another track directly using the number buttons” on page 17).
- Without selecting the disc number, pressing CD ►/II starts playing back the currently selected disc.

To stop play for a moment, press CD ►/II.

- While pausing, the elapsed playing time flashes on the display.
- When the key-touch tone is activated (see page 10), the unit keeps keeping while pausing.

To resume play, press CD ►/|| again.

To stop during play, press ■.

To remove discs, press the corresponding disc eject buttons (CD1▲ – CD5▲) on the unit.



Disc playback sequence in the 5-CD changer

When 5 discs are loaded on the disc trays*, they are played in the following sequence (when Repeat Play is not activated):

Ex.: When playback starts from the CD2 tray:

CD2 ⇒ CD3 ⇒ CD4 ⇒ CD5 ⇒ CD1 (then stops)

* If no disc is on the disc tray, the tray is skipped.

Start Continuous Play while a source other than “CD” is selected

1 Press DISC UP ▲ or DISC DOWN ▼ (or DISC SELECT on the unit) repeatedly to select a disc while listening to a source other than “CD.”

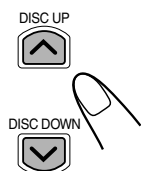

(On the remote control)



(On the unit)

The following indication appears on the display.



Disc tray number

- Each time you press the button, the disc tray number changes as follows*:

CD1 PLAY ? ↔ CD2 PLAY ? ↔ CD3 PLAY ?
 ↻ CD5 PLAY ? ↔ CD4 PLAY ? ↻

* When you press DISC SELECT repeatedly on the unit, the disc tray number changes only clockwise in the above sequence.

2 Press CD ►/|| while the indication in step 1 still remains on the display.

Now the source is changed to “CD” and Continuous Play starts from the selected disc.



Basic Disc Operations

To change a disc during playback of another disc

On the unit ONLY:

Press one of the disc eject buttons (CD1▲ – CD5▲) to eject one of the disc trays which is not playing currently.

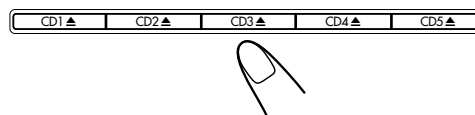

If discs are changed during play, playback will stop after playing all the newly inserted discs.

To start playing a disc during playback of another disc

Press DISC UP ▲ or DISC DOWN ▼ (or DISC SELECT on the unit) repeatedly to select the disc you want.

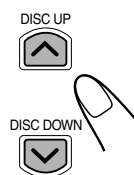

(On the remote control)



(On the unit)

Each time you press the button, the next (or previous) disc is selected. The selected disc starts playing.

To locate a particular point in a track during play

Press and hold ►►| or |◄◄.

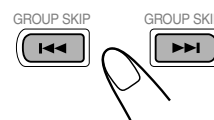

(On the remote control)



(On the unit)

- ►►|: Fast-forwards the tracks.
- |◄◄: Fast-reverses the tracks.

To go to another track

Press ►►| or |◄◄ repeatedly.

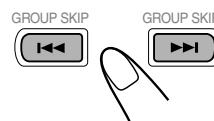

(On the remote control)



(On the unit)

- ►►|: Skips to the beginning of the next or succeeding tracks.
 - You can also skip to tracks on the next disc.
- |◄◄: Goes back to the beginning of the current or previous tracks.
 - You cannot skip back to tracks on the previous disc.

To go to another track directly using the number buttons

On the remote control ONLY:

Pressing the number button(s) allows you to start playing the track number on the current disc.

Ex.: For track number 5, press 5.

For track number 15, press +10, then 5.

For track number 20, press +10, then 10.

For track number 30, press +10, +10, then 10.



To change the information shown on the display

On the remote control ONLY:

Press DISP/CHARA.

Each time you press the button, the information on the display alternates between the source indication and the clock indication.



- If an MD is inserted, the MD remaining recording time ("REC REMAIN") is shown before the clock indication.

Programming the Track Playing Order —Program Play

You can arrange the order in which the tracks play before you start playing. You can program up to 32 tracks.

- To use Repeat Play (see page 19), press REPEAT after starting Program Play.
- There is a time limit in doing the following steps. If the setting is canceled before you finish, start from step 3 again.

1 Load discs into the 5-CD changer.

- If the current playing source is not "CD," press CD ►/II, then ■ before going to the next step.

On the remote control ONLY:

2 Press PLAY MODE repeatedly until "CD PROGRAM" appears on the display.

The PRGM indicator also lights up on the display.

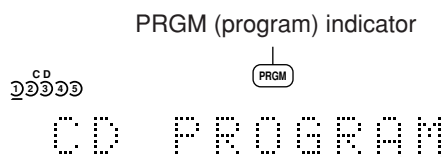

- Each time you press the button, play mode changes as follows:

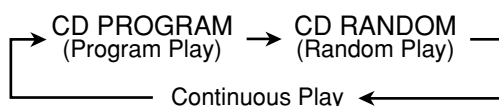

- Program Play can only function when all disc trays are closed.
- If a program has been stored in memory, the program is called up.
- Once the PRGM indicator lights, you cannot change a disc.

3 Press DISC UP ▲ or DISC DOWN ▼ to select the disc number you want to play.

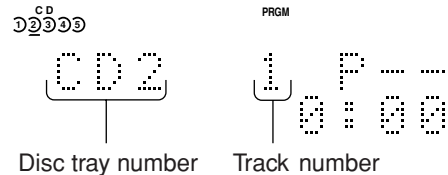

- If "CD1*NO READ" appears on the display, press PLAY MODE repeatedly to select Continuous Play. Then, press DISC UP ▲ or DISC DOWN ▼ to select the disc so that its disc information is shown on the display, then press ■. Start from step 2 again.

* Selected disc number appears.

4 Press the number buttons to select a track from the selected disc in the previous step.

- For how to use the number buttons, see "To go to another track directly using the number buttons" on the left column.

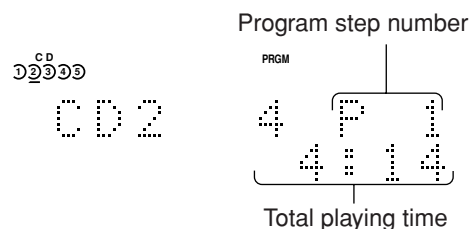

5 Program other tracks you want.

- To program tracks from the same disc, repeat step 4.
- To program tracks from a different disc, repeat steps 3 and 4.

6 Press CD ►/II.

The tracks are played in the order you have programmed. Program Play ends when all the programmed tracks are played once (when Repeat Play is not activated).



To stop during play, press ■.

To exit from Program Play, before or after play, press PLAY MODE once or twice so that the unit enters another play mode (Random Play or Continuous Play).

The PRGM indicator goes off.

- Turning off the unit also cancels Program Play and changes play mode to Continuous Play. The program you have made is still stored in the memory until you erase the entire program (see page 18).

If **Program Play** is still activated, you cannot eject the discs.

To open disc trays (eject discs), before or after play, press **PLAY MODE** once or twice so that the unit enters another play mode (Random Play or Continuous Play) before pressing the disc eject buttons (CD1▲ to CD5▲).

To check the program contents

On the remote control ONLY:

Before playing, you can check the program contents by pressing **▶▶|** or **◀◀|**.

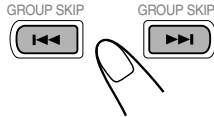

- **▶▶|**: Shows the programmed tracks in the programmed order.
- **◀◀|**: Shows them in the reverse order.
 - Pressing **◀◀|** first time after you have programmed shows the first track in the program.

To modify the program

On the remote control ONLY:

Before playing, you can erase the last programmed track by pressing **CANCEL**. Each time you press the button, the last programmed track is erased from the program.

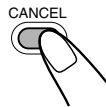

To add tracks to the program before playing, simply select the disc numbers and track numbers you want to add by following steps **3** and **4** in Program Play.

To erase the entire program

1 Press **■** to stop playback.



2 Press **PLAY MODE** once or twice so that the unit enters another playback mode (Random Play or Continuous Play).



3 Press disc eject buttons (CD1▲ to CD5▲) on the unit to eject all the discs used for making the program.

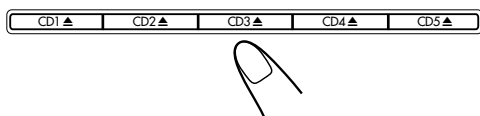

The program will also be erased, when you unplug the AC power cord or a power failure occurs.



- If you try to program a 33rd track “MEMORY FULL” will appear on the display.

If your entry is ignored

You are trying to program a track from an empty tray, or a track number that does not exist on the disc.

If “NO READ” appears on the display

You are selecting the disc that the unit has not yet read. Press **DISC UP ▲** or **DISC DOWN ▼** to select the disc so that its disc information is shown on the display.

If the total playing time is 100 minutes or more

The total playing time on the display will not be shown. “-- : --” will appear.

Playing at Random—Random Play

The tracks of all loaded discs will be played at random.

- To use Repeat Play (see page 19), press **REPEAT** after starting Random Play.

1 Load discs into the 5-CD changer.

- If the current playing source is not “CD,” press **CD ▶/||**, then **■** before going to the next step.

On the remote control ONLY:

2 Press **PLAY MODE** repeatedly until “CD RANDOM” appears on the display.

The **RANDOM** indicator also lights up on the display.



- Each time you press the button, play mode changes as follows:

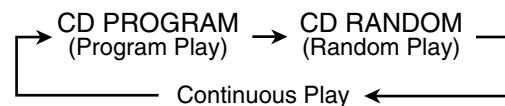

3 Press **CD ▶/||**.

The tracks are played at random. Random Play ends when all the tracks are played once (when Repeat Play is not activated).

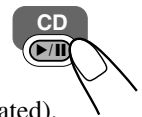

To stop during play, press **■**.

- Opening a disc tray also stops and cancels Random Play.

To skip the current playing track, press **▶▶|**.

To skip back to the beginning of the current track, press **◀◀|**.

- You cannot go back to the previous tracks.

To exit from Random Play, before or after play, press **PLAY MODE** once or twice so that the unit enters another play mode (Continuous Play or Program Play). The **RANDOM** indicator goes off.

- Turning off the unit also cancels Random Play and changes play mode to Continuous Play.

Repeating Tracks or Discs—Repeat Play

You can repeat each track, each disc, or all discs in the 5-CD changer as many times as you like.

You can also repeat your program or repeat all the tracks randomly during Random Play.

On the remote control ONLY:

Press **REPEAT** repeatedly during or before playing.

Repeat mode indicator

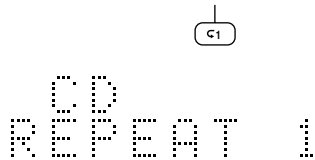

- Each time you press the button, Repeat Play and its indicator change and appear on the display as follows:

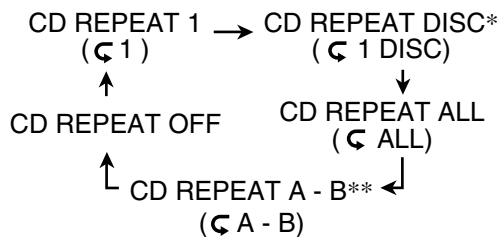

REPEAT 1: Repeats one track continuously.

REPEAT DISC*: Repeats all tracks on a disc.

REPEAT ALL: Repeats all tracks on all discs (continuously or at random), or all tracks in the program.

REPEAT A-B:** Repeats the selected portion. (See below.)

REPEAT OFF: Cancels Repeat Play.

* "REPEAT DISC" is not used for Program Play and Random Play.

** "REPEAT A-B" can be used only during play.

A-B Repeat Play

While playing, you can select a portion of sound you want to repeat.

- During Program Play (see page 17) or Random Play (see page 18), you cannot perform A-B Repeat Play.

On the remote control ONLY:

1 Press **REPEAT** repeatedly during play to select "REPEAT A-B."

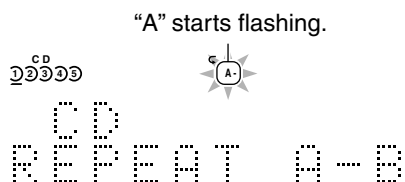

"A" starts flashing.



2 Press **SET** at the start point from which you want to repeat (point A).

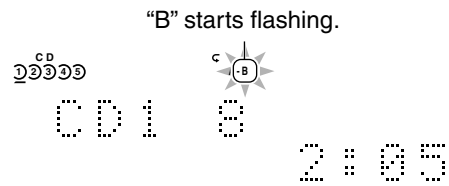

"B" starts flashing.

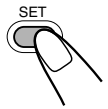

3 Press **SET** again at the end point to which you want to stop repeat (point B).

The unit automatically locates point A and starts repeating the portion between points A and B.

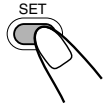

To cancel A-B Repeat Play, press **REPEAT** to select "REPEAT OFF." A-B Repeat Play is canceled and Continuous Play continues from that point.



More about A-B Repeat Play

- Pressing **▶▶1** or **1◀◀** cancels the A-B Repeat Play.
- A-B Repeat Play can be performed only within the same disc.

Prohibiting Disc Ejection—Disc Lock

You can prohibit disc ejection from the unit and can lock discs—Disc Lock.

You can lock or unlock discs only when the unit is on standby (off).

On the unit ONLY:

Press **CD1▲** while holding **■** to lock the disc.



"LOCKED" appears on the display for a while, and the disc trays are locked.

- The loaded MD or cassette is also locked. (See pages 25 and 26.)

LOCKED

If you try to eject a disc, "LOCKED" appears to inform you that the Disc Lock is in use.

To cancel the prohibition and unlock the disc, repeat the above procedure.

"UNLOCKED" appears on the display for a while, the disc trays, MD, and cassette are unlocked.

Playing Back the Entire MD —Normal Play

1 Insert an MD into the MD loading slot.

The MD is pulled in automatically.

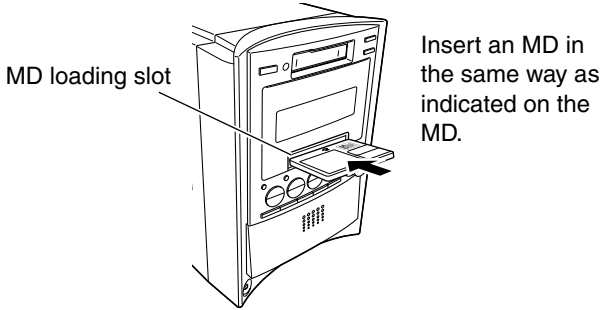

CAUTION:

During Power Save (see page 10), do not insert an MD. Before inserting an MD, cancel Power Save or turn on the unit first.

- The following indications appear when the current source is “MD”:

MD LOADING



MD indicator



MD READING



Total track number Total group number*

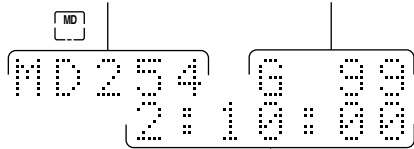

Total playing time**

* When the loaded MD has no group, the total group number will be indicated by “-”.

• To make or edit groups, see pages 39 to 45.

** Disc title appears/scrolls before the total playing time if the loaded MD has a title.

2 Press MD ▶/II.

MD playback starts from the first track. The recording length mode (SP/LP2/LP4) appears on the display.

- Track title appears/scrolls before the recording length mode if the track has a title.



MD playback stops automatically after playing all the tracks on the MD.

To stop during play, press ■.

To remove the disc, press ▲ (MD eject) on the unit.



- Pressing ▲ (MD eject) button also turns on the unit if the MD is unlocked.
- If the MD has a disc/performer name or track has a title**
The title will be shown at the lower part of the display for a while. (If a title is long and cannot be shown at a time, the unit scrolls the title to show the entire title.)
- About recording length mode**
MDs are played back in the same recording length mode as they were recorded. When an MD starts playing, the recording length mode of the currently playing track appears on the display.
SP: Indicates the tracks recorded in standard stereo recording mode on this unit or those recorded on an MD recorder incompatible with MDLP (see below).
LP2: Indicates the tracks recorded in 2 times long-hour stereo recording mode.
LP4: Indicates the tracks recorded in 4 times long-hour stereo recording mode.
For more details, see page 29.

MDLP features a new sound compression method (ATRAC3, see page 60) and enables a 2 times (or 4 times) long-hour stereo recording and playing function. The MDLP logo is marked on the MD recorders and players compatible with MDLP. It is also marked on MDs pre-recorded in ATRAC3 (excluding recordable MDs).

Basic MD Operations

While playing an MD, you can do the following operations.

To stop play for a moment

Press MD ▶/II.

The elapsed playing time starts flashing on the display.

- When the key-touch tone is activated (see page 10), the unit keeps beeping while pausing.

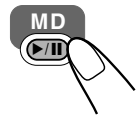

To resume playback, press MD ▶/II again.

To locate a particular point in a track during play

Press and hold ►► or ◀◀.



(On the remote control)

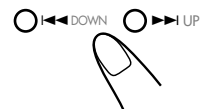

(On the unit)

- : Fast-forwards the track.
- ◀◀: Fast-reverses the track.

To go to another track

Press **▶▶** or **◀◀** repeatedly.

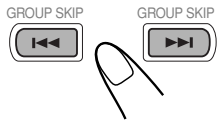

(On the remote control)

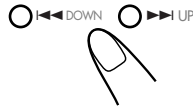

(On the unit)

- **▶▶**: Skips to the beginning of the next or succeeding tracks.
- **◀◀**: Goes back to the beginning of the current or previous tracks.

To go to another track directly using the number buttons

On the remote control ONLY:

Pressing the number button(s) allows you to start playing the track number you want.

- Ex.: For track number 5, press 5.
 For track number 15, press +10, then 5.
 For track number 20, press +10, then 10.
 For track number 32, press +10, +10, +10, then 2.



To change the information shown on the display

On the remote control ONLY:

Press **DISP/CHARA**.

Each time you press the button, the information on the display changes as on the right column:



While playing or pausing:

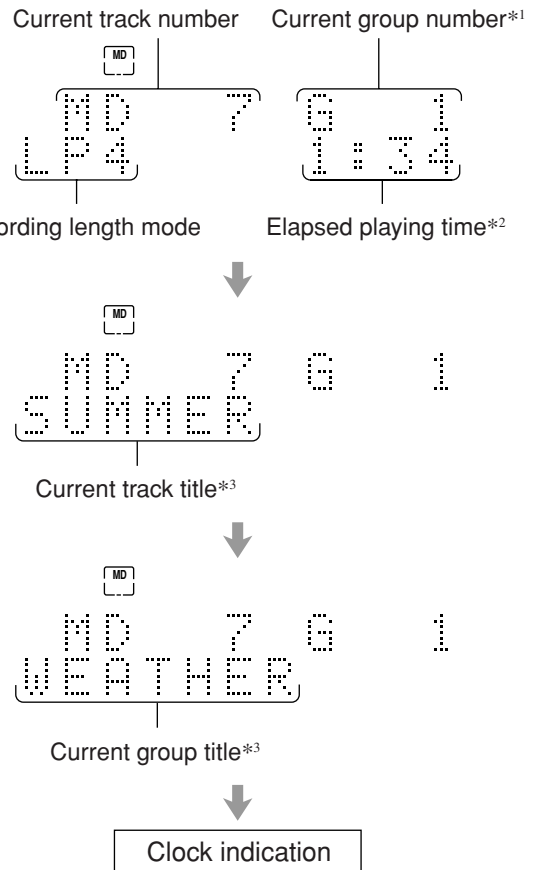

When the MD recorder stops:

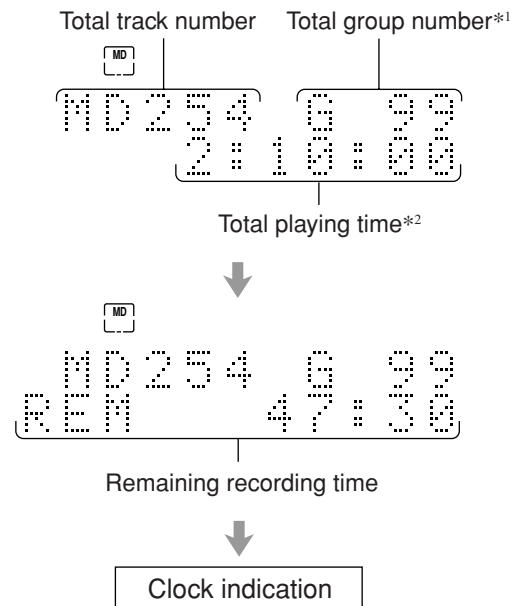

*1 When the current track does not belong to any group or when the disc has no group, “-” will appear on the display.

*2 When the current track or disc has a title, its title will appear/scroll on the display.

*3 When the track/group has no title, “NO TR TITLE” or “NO GR TITLE” appears on the display.

Programming the Track Playing Order —Program Play

You can arrange the order in which the tracks play before you start playing. You can program up to 32 tracks.

- There is a time limit in doing the following steps. If the setting is canceled before you finish, start from step **3** again.

1 Load an MD.

- If the current playing source is not “MD,” press MD ►/II, then ■ before going to the next step.

On the remote control ONLY:

2 Press PLAY MODE repeatedly until “MD PROGRAM” appears on the display.

The PRGM indicator lights up on the display.

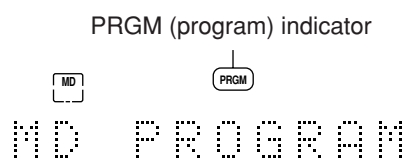

- Each time you press the button, play mode changes as follows:

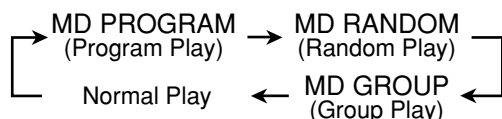

If a program has been stored in memory, the program is called up.

3 Press the number buttons to select the tracks.

- For how to use the number buttons, see “To go to another track directly using the number buttons” on page 21.

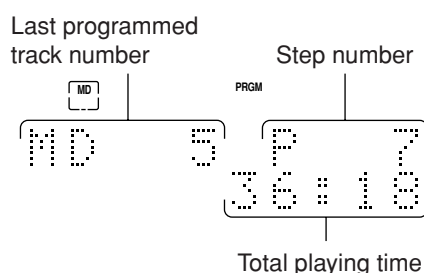

4 Repeat step 3 to program other tracks you want.

5 Press MD ►/II.

The tracks are played in the order you have programmed. Program Play ends when all the programmed tracks are played once (when Repeat Play is not activated).



To stop during play, press ■.

To exit from Program Play, before or after play, press PLAY MODE repeatedly so that the unit enters another play mode (Random Play, Group Play, or Normal Play).

The PRGM indicator goes off.

- Turning off the unit also cancels Program Play and changes the play mode to Normal Play. The program you have made is still stored in the memory until you erase the entire program (see below).

To check the program contents

On the remote control ONLY:

Before playing, you can check the program contents by pressing ►►I or I◀◀.

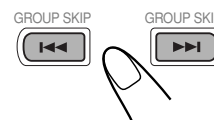

- ►►I: Shows the programmed tracks in the programmed order.
- I◀◀: Shows them in the reverse order.

To modify the program

On the remote control ONLY:

Before playing, you can erase the last programmed track by pressing CANCEL.

Each time you press the button, the last programmed track is erased from the program.



To add tracks in the program before playing, simply select the track numbers you want to add by following step **3** in Program Play.

To erase the entire program, press ▲ (MD eject) on the unit to eject the MD.

- The program will be erased when you unplug the AC power cord or a power failure occurs.



- If you try to program a 33rd track “MEMORY FULL” will appear on the display.
- If your entry is ignored You are trying to program a track that does not exist on the MD (for example, selecting track 14 on an MD that only has 12 tracks).
- If the total playing time is 150 minutes or more The total playing time on the display will not be shown. “-- : --” will appear.

Playing at Random—Random Play

The tracks of the loaded MD will be played at random.

1 Load an MD.

- If the current playing source is not “MD,” press MD ►/II, then ■ before going to the next step.

On the remote control ONLY:

2 Press PLAY MODE repeatedly until “MD RANDOM” appears on the display.

The **RANDOM** indicator lights up on the display.

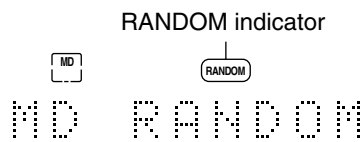

- Each time you press the button, play mode changes as follows:

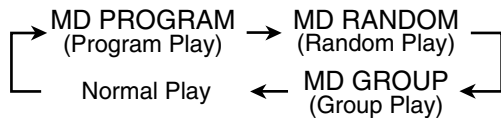

3 Press MD ►/II.

The tracks are played at random.
Random Play ends when all the tracks are played once (when Repeat Play is not activated).

To stop during play, press ■.

To skip the current playing track, press ►►.

To skip back to the beginning of the current track, press ◀◀.

- You cannot go back to the previous tracks.

To exit from **Random Play**, before or after play, press PLAY MODE repeatedly so that the unit enters another play mode (Group Play, Normal Play, or Program Play).
The **RANDOM** indicator goes off.

- Turning off the unit or ejecting MD also cancels Random Play and changes the playback mode to Normal Play.

Playing Tracks in a Group—Group Play

You can play back tracks in a group.

- To make or edit groups, see pages 39 to 45.

1 Load an MD including groups.

- If the current playing source is not “MD,” press MD ►/II, then ■ before going to the next step.

On the remote control ONLY:

2 Press PLAY MODE repeatedly until “MD GROUP” appears on the display.

The **GROUP** indicator lights up on the display.

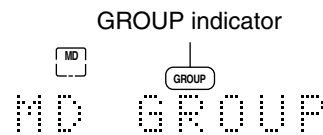

- Each time you press the button, play mode changes as follows:

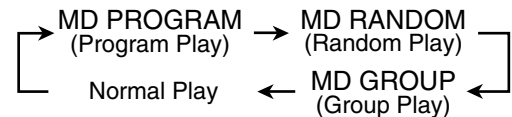

3 Press GROUP SKIP ►► or GROUP SKIP ◀◀ while holding SHIFT to select a group.

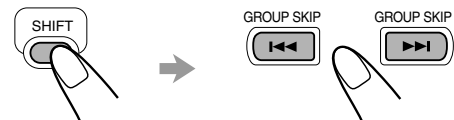

- GROUP SKIP ►►: Selects group numbers in the increasing order.
- GROUP SKIP ◀◀: Selects group numbers in the decreasing order.

The first track of Group 5 Current group number

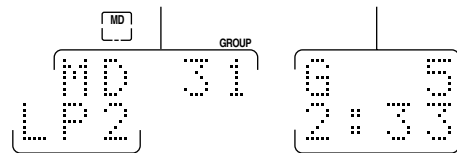

Recording length mode
of the current track

Total playing time
of the current track

4 Press MD ►/II.

The tracks in the selected group starts playing.

- When the loaded MD has no groups, all the tracks on the MD are played back in the same way as Normal play.

Group Play ends when all the tracks in the selected group are played once (when Repeat Play is not activated).

To go to another track in the same group, press **▶▶|** or **|◀◀** repeatedly.

- **▶▶|**: Skips to the beginning of the next or succeeding tracks in the same group.
- **|◀◀**: Goes back to the beginning of the current or previous tracks in the same group.

To go to another group, press **GROUP SKIP ▶▶|** or **GROUP SKIP |◀◀** repeatedly while holding **SHIFT** during Group Play.

- **GROUP SKIP ▶▶|**: Skips to the first track in the next or succeeding groups.
- **GROUP SKIP |◀◀**: Goes back to the first track in the current or previous groups.

To stop during play, press **■**.

To exit from Group Play, before or after play, press **PLAY MODE** repeatedly so that the unit enters another play mode (Normal Play, Program Play, or Random Play).

- Turning off the unit also cancels Group Play and changes the playback mode to Normal Play.

Repeating Tracks—Repeat Play

You can have all the tracks, the program, the individual track or group currently playing repeat as many times as you like.

On the remote control ONLY:

Press **REPEAT** during or before play.

- Each time you press the button, Repeat Play changes as follows:

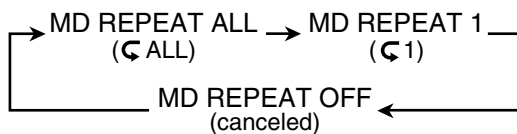

- **MD REPEAT ALL:**
 - For Normal Play or Random Play: Repeats all the tracks on the MD.
 - For Group Play: Repeats all the tracks in a group.
 - For Program Play: Repeats all the tracks in the program.
- **MD REPEAT 1:** Repeats one track.
- **MD REPEAT OFF:** Cancels Repeat Play. Ejecting the MD or turning off the unit will also cancel the Repeat Play.

To stop during play, press **■**.

Searching for Tracks to Play —MD Title Search

You can search for the tracks by their titles and play them back.

For details on assigning a title, see pages 51 – 53.

1 Load an MD.

- If the current playing source is not “MD,” press **MD ▶/||**, then **■** before going to the next step.

On the remote control ONLY:

2 Press TITLE SEARCH.

The **TITLE SEARCH** indicator lights up on the display. Play mode changes to Normal Play.

“TITLE” appears on the display and the character entry position flashes.

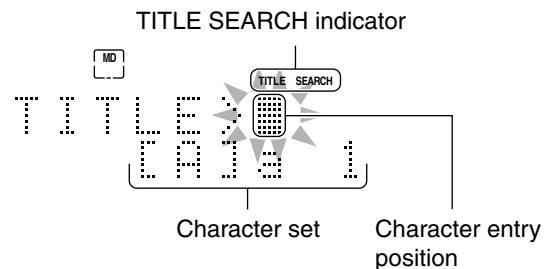

3 Enter the character(s) to search for the track title.

You can enter up to 5 characters. The unit will search for the tracks which have the entered characters at the beginning of their titles.

- You can also search for the tracks without a title. In this case, go to step 4 without entering any character.

1) Press **DISP/CHARA** to select the character set you want.

- Each time you press the button, character set changes as follows:

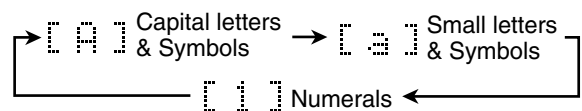

2) Press the character entry button for a character you want to enter.

Ex.:

- To enter an "A" or "a," press ABC once.
- To enter a "B" or "b," press ABC twice.
- To enter a "C" or "c," press ABC three times.
- To enter a symbol, press MARK repeatedly until the mark you want appears.
- To enter a numeral, press 0 – 9.
- To enter a space while entering a title, press \rightarrow twice.
- To move the character entry position while entering a title, press \rightarrow or \leftarrow .
- If you have entered an incorrect character, press \rightarrow or \leftarrow to select the character you want to correct, then press CANCEL to delete it.



3) Repeat steps 3 – 1) and 3 – 2) to enter other characters.

- If the character you want to enter next is assigned to the same button you have just pressed in step 3 – 2), press \rightarrow once to move the character entry position to the right.

4 Press ENTER.

"SEARCH....." scrolls and the **TITLE SEARCH** indicator starts flashing on the display. The unit starts searching for the track.



- When the track with the desired title is found, the unit plays back the track. (After the track is played, the unit starts searching for the next matching track.)
- If no track with the desired title is found, "SEARCH END" appears on the display and Normal Play resumes. The **TITLE SEARCH** indicator goes off.

To skip the current playback and search for the next track, press $\blacktriangleright\blacktriangleright$.

To cancel title searching, press TITLE SEARCH or \blacksquare . When you press the button during playback or search, Normal Play resumes.



If you press $\blacktriangleleft\blacktriangleleft$, the current playing track will go back to the beginning or previous track, but title search is still activated.

Available symbols are as follows:

(Blank)	!	"	#	\$	%	&	'	()
*	+	,	-	.	/	:	;	< =
>	?	@	_	\				

To prohibit MD ejection—MD Lock

You can prohibit MD, disc, and cassette ejection from the unit, and lock the disc.

See "Prohibiting Disc Ejection—Disc Lock" on page 19 for details.

Playing Back Tapes

Playing Back a Tape

You can play back type I tapes.

1 Insert a cassette into the cassette loading slot with the exposed part of the tape facing left.

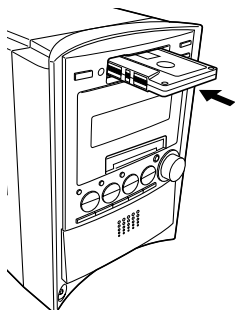

- When the unit is turned on, the **TAPE** indicator appears on the display.
- If you insert the cassette when the unit is on tape mode, “TAPE LOADING” appears on the display.

Tape operation indicators

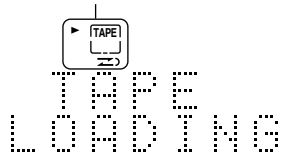

2 Press TAPE ◀▶.

Playback starts (if the unit has been on standby, the unit automatically turns on).



To change the tape direction, press the button again.

- Each time you press the button, the tape direction changes as follows:
 - ▶ : Plays the front side.
 - ◀ : Plays the reverse side.

Tape direction indicator TAPE indicator

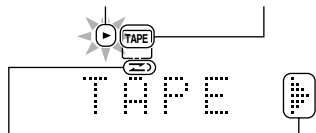

Reverse Mode indicator Tape direction

When the tape plays to the end, the deck automatically stops if Reverse Mode is set to ◀▶ or ▶◀. (See “To play both sides—Reverse Mode” on the right column.)

To stop during play, press ■.

To fast-wind the tape rightward or leftward, press ▶▶▶ or ◀◀◀.

The tape direction indicator (▶ or ◀) starts flashing rapidly on the display.

To remove the cassette, press ▲ (TAPE eject) on the unit. The **TAPE** and tape operation indicators go off.



Pressing ▲ (TAPE eject) button also turns on the unit if the cassette is unlocked.



DO NOT press ▲ (TAPE eject) during tape play.

To play both sides—Reverse Mode

You can set the deck to play just one side or both sides of a tape once, or both sides continuously.

Press **REV.MODE**.

- Each time you press the button, Reverse Mode changes as follows:

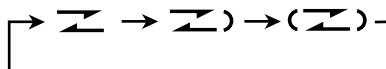
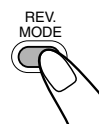

- ▶▶ : Plays back only one side (front or reverse).
- ▶▶◀ : Plays back the front and reverse sides once.
- (▶▶) : Plays back both front and reverse sides continuously.



When you eject the cassette, Reverse Mode changes to ▶▶ automatically.



- The use of C-120 or longer tape is not recommended, since characteristic deterioration may occur and this tape easily jams in the pinch rollers and the capstans.
- You can also play back type II and type IV tapes; however, the sound quality (tone) may not be reproduced properly.

To prohibit cassette ejection—Cassette Lock

You can prohibit cassette, disc, and MD ejection from the unit, and lock the cassette.

See “Prohibiting Disc Ejection—Disc Lock” on page 19 for details.

Listening to External Equipment

Listening to External Equipment

You can listen to external equipment connected to the AUX/DVD jacks on the rear of the unit.

- First make sure that the external equipment is properly connected as follows (see also “Connecting External Equipment” on page 8):



DO NOT connect other equipment while the power is on.

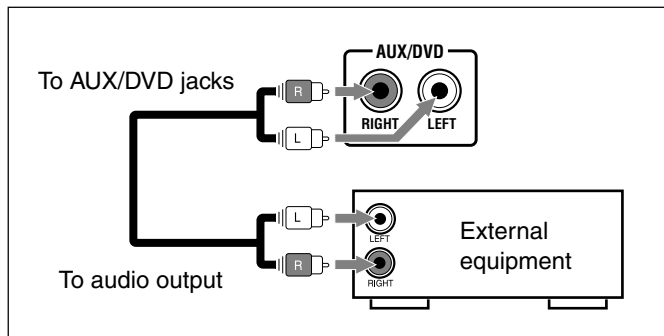

1 On the remote control:

Press FM/AM/AUX repeatedly until “AUX” appears on the display.

- Each time you press the button, the source changes as follows:

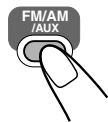
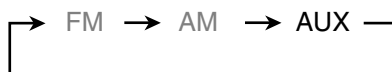

On the unit:

Press AUX/DVD.

- “AUX” appears on the display.



2 Turn down the volume level to “VOLUME 0.”



(On the remote control)

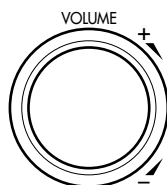

(On the unit)

3 Start playing the external equipment.

- For operation of the external equipment, refer to the manuals supplied with it.

4 Adjust the volume level to your desired listening level.

5 Apply sound effects, if you wish.

- For how to apply sound effects, see pages 11 and 12.

To adjust the Audio Input Level

If the sound from the component connected to the AUX/DVD jacks is too loud or is not loud enough when changing from another source to “AUX,” you can change the audio input level through the AUX/DVD jacks (without changing the volume level).

On the remote control ONLY:

Press and hold SET for more than 2 seconds while the source is “AUX.”

- Each time you press and hold the button, the audio input level alternates between “LEVEL 1” and “LEVEL 2.”

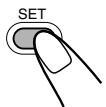

AUX
LEVEL 1

LEVEL 1: Select this when the sound is too loud (initial setting).

LEVEL 2: Select this when the sound is not loud enough.

To change the information shown on the display

On the remote control ONLY:

Press DISP/CHARA.

Each time you press the button, the information on the display alternates between the source indication and the clock indication.

- If an MD is inserted, the MD remaining recording time (“REC REMAIN”) is shown before the clock indication.



Before You Start Recording on an MD

- **It may be unlawful to record or play back copyrighted material without the consent of the copyright owner.**
- When you record onto partially recorded MD, its contents are not erased or overwritten. The recording starts from the point following the last recorded track of the MD.
If you want to record on such an MD from the beginning, you have to erase its contents first (see “Erasing All Tracks —ALL ERASE” on page 50).
- When an MD is fully recorded, recording will stop automatically.
- The recording level is automatically set correctly, so it is not affected by the volume level. Thus, during recording you can adjust the sound you are actually listening to without affecting the recording level.
- While recording, you can hear sound mode effect and/or the AHB PRO (Active Hyper Bass PRO) effect through the speakers or headphones. However, the sound is recorded without these effects (see pages 11 and 12).
- You can make a digital to digital recording from an audio CD onto an MD.
When selecting FM, AM, TAPE, or AUX as the source, you can make an analog to digital recording only.
- You cannot record more than 254 tracks onto an MD, even if there is still enough recording time remaining on it.

About the track marks

When playing an MD, you can move among the tracks. You can do this because there is a mark recorded at the beginning of each track enabling you to locate the track. This mark is called a “track mark” and the portion between two adjacent track marks is called a “track.”

- **When using CD synchronized recording**, a track mark is recorded at the beginning of each track. You cannot put a track mark manually.
- **When recording from an analog source such as FM, AM, TAPE, or AUX**, you can select “Auto Track Recording” and “Manual Track Recording” by pressing CD REC MODE (see page 32).

To add a track mark after recording is over, you can use the DIVIDE function (see page 47).

To avoid erasing important recordings

The recordable MD has an erasure prevention tab so that important recordings are not accidentally erased. When you finish recording or editing, slide to open the erasure prevention tab on the cartridge side surface. New recording or editing is now no longer possible. (If you try to do, “DISC PROTECTED” appears on the display.) To do re-recording or editing, return the tab to the closed position.

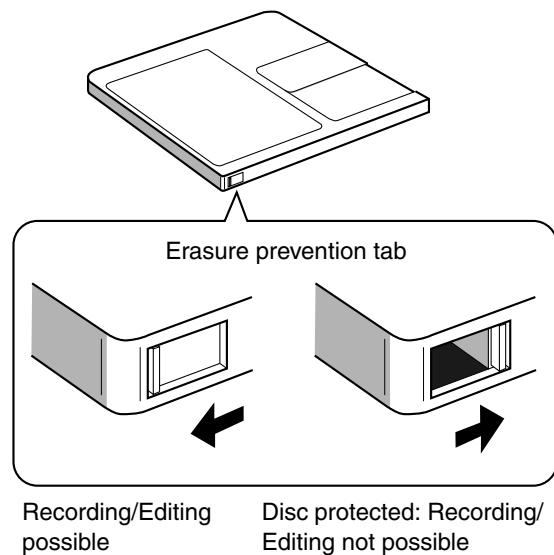

If “PLAY BACK DISC” appears on the display when you try to record on an MD

The MD is only for playback use, not for recording (see page 63).

Stereo Long-Hour Recording (MDLP)

On conventional MD recorders, 2 times long-hour recording on MDs has been possible only in monaural sound, but this unit allows for 2 times or 4 times long-hour recording without losing stereo sound.

With this feature, songs (tracks) can be recorded on a single MD using different recording length modes—SP: Standard Play, LP2: 2 Times Long Play, LP4: 4 Times Long Play.

- SP:** Signifies standard-hour stereo recording. The amount of time usable for recording is the same as shown on the package of the MD.
- LP2:** Signifies 2 times long-hour stereo recording. The amount of time usable for recording is twice as long as shown on the package of the MD.
- LP4:** Signifies 4 times long-hour stereo recording. The amount of time usable for recording is 4 times as long as shown on the package of the MD.

REMEMBER to check the remaining recording time of MDs before start recording

The remaining recording time of MDs will be calculated and shown, based on the recording length mode (SP/LP2/LP4) currently selected.

Before start recording or using the Recording Timer, check the remaining recording time on the MD for each recording length mode (SP/LP2/LP4) and select the optimum recording length mode.

To check the remaining recording time

Press DISP/CHARA repeatedly until “REC REMAIN” and the remaining time based on the current recording mode appear on the display.

Precautions for performing long-hour stereo recording

After having made long-hour stereo recordings on this unit, pay attention to the following:

- Songs (tracks) recorded in 2 times or 4 times long-hour recording mode can only be played back on the equipment provided with MDLP, compatible with a long-hour stereo recording function; otherwise, “LP:” is displayed before a title and playback proceeds without sounds.
- When editing songs (tracks) on an MD, you cannot join (JOIN) songs (tracks) recorded in different recording length modes (SP/LP2/LP4).



More about MDLP

- You cannot make a long-hour monaural recording using this unit.
- Sound quality will decrease as the recording length mode changes to LP2 (little) and LP4 (much). To obtain the best sound quality, it is recommended to use the SP mode when recording.

About High-Speed Recording

The time for high-speed recording is half or quarter as long as the time for normal speed recording.

There are some restrictions to observe for high-speed recording (x2 speed recording: two times as quick as normal speed recording, x4 speed recording: four times as quick as normal speed recording, x5 speed recording: five times as quick as normal speed recording) to protect copyrights. (HCMS: see page 61.)

This unit is so designed that a song (track) recorded from a CD using high-speed recording cannot be re-recorded until 74 minutes elapse after the previous recording started.

If you try to re-record the same song (track) within the 74 minutes, recording is canceled and “HCMS CANNOT COPY” appears on the display as a warning.

REMEMBER if you are trying to record a program including the same song (track) twice using high-speed recording, recording will stop at the beginning of the 2nd recording of the same song (track). (“HCMS CANNOT COPY” will appear on the display.)



During high-speed recording

You cannot listen to any source, and therefore, cannot adjust the volume level. (“CANNOT LISTEN” will appear on the display if you try to do.)

Setting MD Recording Modes

Before recording on MDs, set the recording length mode (SP/LP2/LP4), “LP:”-prefix addition mode, and the group recording mode.

On the remote control ONLY:

To set the recording length mode

The recording length mode can be set and stored for each source.

1) Select the source (FM, AM, CD, TAPE, or AUX) to record.

2) Press REC TIME.

- Each time you press the button, the recording length mode changes as follows:

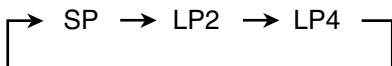
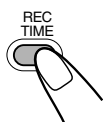

SP: Records using standard-hour stereo recording.

The **SP** indicator lights up on the display.

LP2: Records using 2 times long-hour stereo recording. The **LP2** indicator lights up on the display.

LP4: Records using 4 times long-hour stereo recording. The **LP4** indicator lights up on the display.

To set “LP:”-prefix addition mode

You can select whether or not to add “LP:” to the beginning of the title for the tracks recorded using the stereo long-hour recording mode (LP2 or LP4).

Press LP: while holding SHIFT.

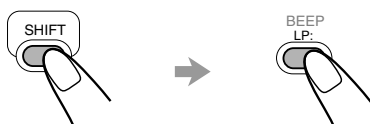

- Each time you press these buttons, the “LP:”-prefix addition mode alternates between on and off.

(LP:) ON ↔ (LP:) OFF

(LP:) ON: Adds “LP:” to the beginning of the track title. The total number of characters you can enter for an MD is reduced (for details, see pages 51 – 53).

(LP:) OFF: Does not add “LP:” to the beginning of the track title.

To set group recording mode

You can form a new group (up to 99 groups) easily while recording using group recording mode.

Press **GROUP REC ON/OFF**.

- Each time you press the button, group recording mode turns on and off.



MD GROUP ON ↔ MD GROUP OFF

MD GROUP ON: All the tracks recorded at a time will form a new group. The **GROUP** indicator lights up on the display.

MD GROUP OFF: Cancels group recording function. The **GROUP** indicator goes off from the display.

Recording CD onto an MD —CD-MD Synchronized Recording

Using the CD synchronized recording method, you can start and stop CD play and MD recording at the same time.

1 Load discs into the 5-CD changer.

- If the current playing source is not “CD,” press CD ▶/II, then ■ before going to the next step.
- You can make a program (see page 17) or select Random Play (see page 18) if you want.

On the remote control ONLY:

2 Press DISC UP ^ or DISC DOWN v to select the disc you want to record, then ■ before going to the next step.

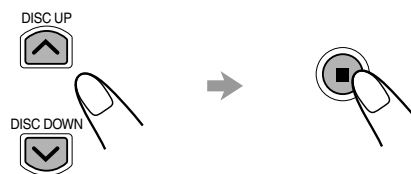

3 Insert a recordable MD into the MD loading slot.

- Set the MD recording length mode, “LP:”-prefix addition mode, and group recording mode (see left column and above).

4 Press REC SPEED to select the recording speed you want.

- Each time you press the button, recording speed changes as follows:

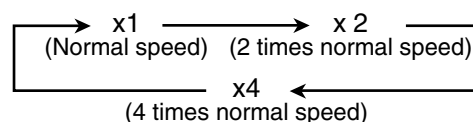
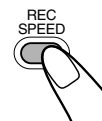

- If you have selected Program Play or Random Play, go to step 6.

5 Press CD REC MODE to select the recording mode.

- Each time you press the button, recording mode changes as follow:

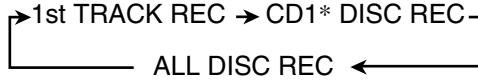

- 1st TRACK REC:** Records the first track of all the loaded CDs (up to 5 discs).
 - This allows you to make a directory of all your favorite CDs.
- CD1* DISC REC:** Records the selected CD entirely.
 - * Selected disc number appears on the display.
- ALL DISC REC:** Records all the loaded CDs.

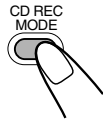

6 Press MD REC when the selected recording mode in step 5 is still shown on the display.

The recording starts and the **REC** (MD recording) indicator starts flashing on the display.

- When you have selected a track by pressing **▶▶** or **◀◀** before pressing CD REC MODE in step 5, recording starts from the selected track (except when Program Play mode is selected).
- If you do not select the recording mode in step 5, the current CD will be recorded entirely.
- When you have selected Program Play or Random Play mode, you cannot record using x4 speed recording (“CANNOT REC x1 or x2 ONLY” will appear).
- You can use x4 speed recording during Program Play or Random Play to record only the current playing track.
- Recording speed will be “x5” to record an entire CD whose playing time is more than 28 minutes with “x4” recording speed selected.

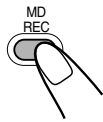

The track number on the disc currently being recorded Remaining playing time

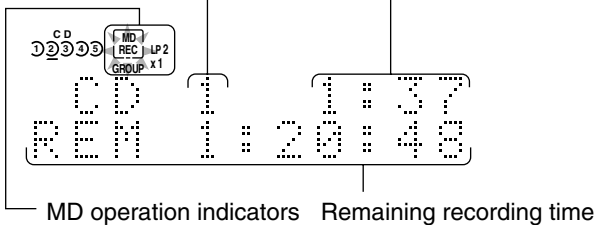

Ex.: Track 1 of CD2 is now recorded on an MD using LP2 and Group recording at normal speed (x1).

When the CD player stops, the MD recorder also stops automatically.

To record a single track during play or pause

While playing back or pausing a track you want to record, press MD REC.

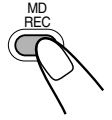

The playback of the track is stopped, and the same track starts playing from the beginning again. This time, the MD recorder starts recording the track. The **REC** (MD recording) indicator flashes on the display.

- After the track is recorded, both the CD player and the MD recorder stop automatically. “WRITING” flashes on the display and the unit beeps for a while if the key-touch tone is activated (see page 10).

To change the information shown on the display

On the remote control ONLY:

Press **DISP/CHARA**.

- Each time you press the button, the recording indications, the current track numbers of both the disc and the MD, and the clock indication appear in sequence on the display.

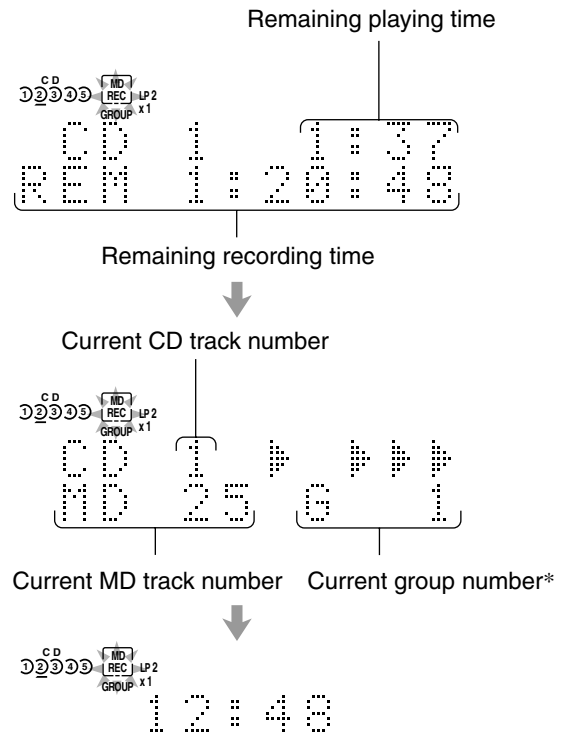

* If the loaded MD does not contain any group or more than 99 groups, “G - -” will appear on the display.



When recording from a CD-R/RW

You cannot make a digital recording from a digital-copied CD-R/RW on an MD. “SCMS CANNOT COPY” appears on the display and an analog recording starts (see page 61). The recording speed is automatically set to x1 (normal speed).

If CD REC MODE is used, recording stops automatically if “SCMS CANNOT COPY” appears on the display.

Recording Other Sources onto an MD

1 Prepare the source to record from.

To record from FM/AM broadcasts:

- 1) Press FM/AM/AUX (or FM/AM on the unit) to select either "FM" or "AM."



(On the remote control)



(On the unit)

- 2) Tune in to a preset station you want (see page 14).

To record from a tape:

- 1) Insert a cassette into the cassette loading slot.
 - If the current playing source is not "TAPE," press TAPE ◀▶, then ■ before going to the next step.
- 2) Press REV.MODE to select Reverse Mode (see page 26).

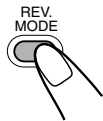

To record from external equipment:

Press FM/AM/AUX (or AUX/DVD on the unit) to select "AUX" and prepare the external equipment to play.



(On the remote control)



(On the unit)

- Adjust the audio input level if necessary (see page 27).
- For operation of the external equipment, see the manuals supplied with it.

2 Insert a recordable MD into the MD loading slot.

- Set the MD recording length mode, "LP:"-prefix addition mode, and group recording mode (see "Setting MD Recording Modes" on page 30).

On the remote control ONLY:

3 Press CD REC MODE to select track mark entry mode.

- Each time you press the button, entry mode alternates between auto and manual entry:

MANUAL TRK REC ↔ AUTO TRK REC

MANUAL TRK REC: Separates tracks manually by adding track marks at the places where you want.

- Press SET to add a track mark while recording.

AUTO TRK REC: The unit automatically separates and put a track mark if there is a silence of 3 seconds or more between tracks.

- By pressing SET, you can also enter a track mark manually.



* See "About the track marks" on page 28 for details.

4 Press MD REC.

The REC (MD recording) indicator starts flashing on the display.

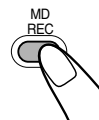

When the source is "FM" or "AM," recording starts.

When the source is "TAPE," playback and recording starts—Synchronized Recording.

When the cassette player stops, recording also stops automatically.

When the source is "AUX," starts playback after "AUX → MD" appears on the display.

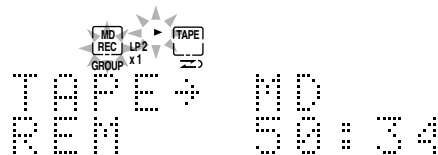

Ex.: When recording a tape using LP2 and Group recording.

To stop recording, press ■.

"WRITING" flashes on the display and the unit beeps for a while if the key-touch tone is activated (see page 10).



When recording from the external equipment

Recording starts automatically when the source sound comes into the unit, and stops automatically if no sound comes into the unit for about 30 seconds (Sound Synchronized Recording).

To change the information shown on the display

On the remote control ONLY:

Press DISP/CHARA.

- Each time you press the button, the information on the display changes as follows:

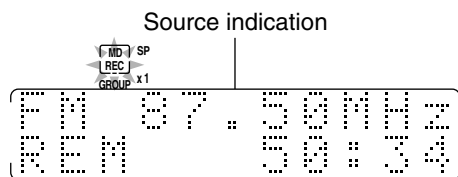

Remaining recording time

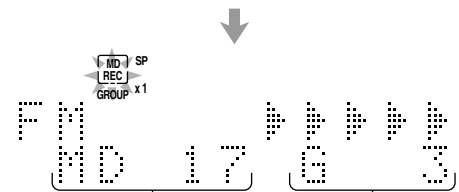

MD track number MD group number*

Ex.: When you record an FM broadcast.

* When group recording is not activated, "--" will appear on the display.

Recording on Tapes

Before You Start Recording on a Tape

- It may be unlawful to record or play back copyrighted material without the consent of the copyright owner.
- The recording level is automatically set correctly, so it is not affected by the volume level. Thus, during recording you can adjust the sound you are actually listening to without affecting the recording level.
- While recording, you can hear sound mode effect and/or the AHB PRO (Active Hyper Bass PRO) effect through the speakers or headphones. However, the sound is recorded without these effects (see pages 11 and 12).
- If recordings you have made have excessive noise or static, the unit may be too close to a TV. Place the unit away from the TV.
- You can use only type I tapes for recording.

To protect your recordings

Cassettes have two small tabs on the back to protect unexpected erasure or recording.

To protect your recording, remove these tabs.

To re-record on a protected tape, cover the holes with adhesive tape.

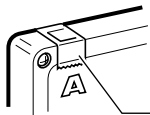

Adhesive tape



The use of the C-120 or longer tape is not recommended, since characteristic deterioration may occur and this tape easily jams in the pinch rollers and the capstans.

To keep the best recording and playback sound quality

You need to clean the heads.

- Clean the heads after every 10 hours of use with a wet-type head cleaning tape (available at electronic and audio shops).

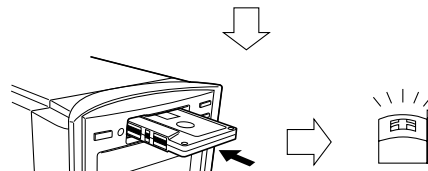
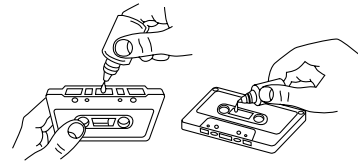

When the head becomes dirty, the following symptoms will occur:

- Sound quality is reduced.
- Sound level decreases.
- Sound drops out.
- Do not play dirty or dusty tapes.
- Do not touch the highly-polished head with any metallic or magnetic tools.

To demagnetize the head

Turn off (on standby) the unit, and use a head demagnetizer (available at electronics and audio shops).



At the start and end of cassette tapes

There is leader tape which cannot be recorded onto. Thus, when recording discs, MDs, or radio broadcasts, wind the leader tape first to ensure that the recording will be made without any music part lost.

Recording CD onto a Tape —CD-Tape Synchronized Recording

1 Load discs into the 5-CD changer.

- If the current playing source is not “CD,” press CD ►/||, then ■ before going to the next step.
- You can make a program (see page 17) or select Random Play (see page 18) if you want. → Go to step 3.

On the remote control ONLY:

2 Press DISC UP ▲ or DISC DOWN ▼ to select the disc you want to record, then ■ before going to the next step.

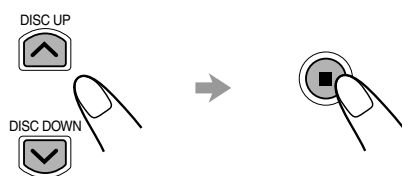



3 Put a recordable cassette into the cassette loading slot.

4 Press REV.MODE to select a reverse mode.

- Each time you press the button, the reverse mode changes as follows:

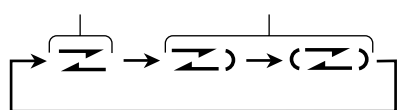
Recording on one side. Recording on both sides once.



*  will be shown during recording when you select .

- If you have selected Program Play or Random Play, go to step 6.

5 Press CD REC MODE to select the recording mode.

- Each time you press the button, recording mode changes as follow:

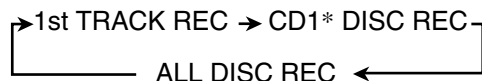

- 1st TRACK REC: Records the first track of all the loaded CDs (up to 5 discs).
 - This allow you to make a directory of all your favorite CDs.
- CD1* DISC REC: Records the selected CD entirely.
 - * Selected disc number appears on the display.
- ALL DISC REC: Records all the loaded CDs.

6 Press TAPE REC when the selected recording mode in step 5 is still shown on the display.

The recording starts and the REC (tape recording) and tape direction indicators start flashing on the display.

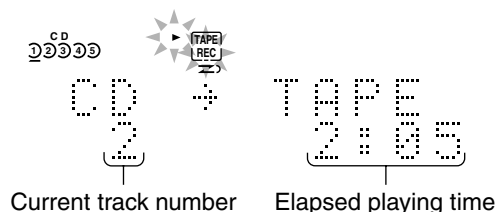

Recording onto a Tape

You can use only type I tapes for recording.

1 Prepare the source to record from.

To record from a disc:

1) Load discs into the 5-CD changer.

- If the current playing source is not “CD,” press CD ►/||, then ■ before going to the next step.
- You can make a program (see page 17) or select Random Play (see page 18) if you want. → Go to step 2.

2) Press DISC UP ▲ or DISC DOWN ▼ to select a disc to record, then ■ before going to the next step.



To record from an MD:

Insert an MD into the MD loading slot.

- If the current playing source is not “MD,” press MD ►/||, then ■ before going to the next step.
- You can make a program (see page 22), select Random Play (see page 23) or Group Play (see page 23) if you want.

To record from FM/AM broadcasts:

1) Press FM/AM/AUX (or FM/AM on the unit) to select either “FM” or “AM.”



(On the remote control)

(On the unit)

2) Tune in to a preset station you want (see page 14).

To record from external equipment:

- 1) Press FM/AM/AUX (or AUX/DVD on the unit) to select "AUX."



(On the remote control)



(On the unit)

- 2) Prepare the external equipment to play.
- Adjust the audio input level if necessary (see page 27).
 - For operation of the external equipment, see the manuals supplied with it.

2 Put a recordable cassette into the cassette loading slot.

3 Press REV.MODE to select Reverse Mode.

- Each time you press the button, Reverse Mode changes as follows:

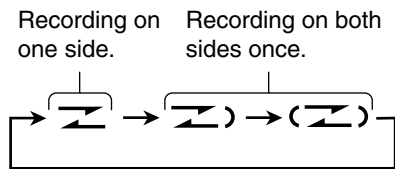
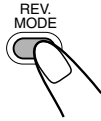

* will be shown during recording when you select .

4 Press TAPE REC.

The REC (tape recording) and tape direction indicators start flashing on the display.

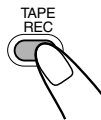

When the source is "FM" or "AM," recording starts.

When the source is "CD" or "MD," playback and recording starts—Synchronized Recording. When the CD or MD player stops, recording also stops automatically.

When the source is "AUX," starts playback after "AUX → TAPE" appears on the display.

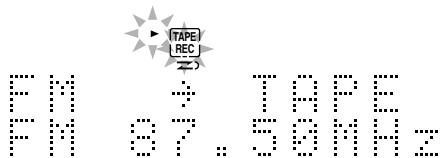

Ex.: When you record an FM broadcast

- When you select a track by pressing or before pressing TAPE REC, recording starts from the selected track (except when Program Play is selected).
- When recording from an external equipment, start playback after "AUX → TAPE" appears on the display.

To record a single track of a CD/MD during play

On the remote control ONLY:

While playing back a track of a CD or MD you want to record, press TAPE REC.



The playback of the track is stopped, and the same track starts playing from the beginning again. This time, the cassette deck starts recording the track.

- After the track is recorded, both playback and recording stop automatically.



When you press TAPE REC while pausing a track Recording starts from that point.

To change the information shown on the display

On the remote control ONLY:

Press DISP/CHARA.

- Each time you press the button, the information on the display alternates between the recording indication and the clock indication.



When recording a disc or an MD

- A 4-second blank is automatically made on the tape before each track. To record without the blank, press CD or MD twice in step 1, then press TAPE REC.
- When the front side of the tape ends in the middle of a track, the recording on the reverse side starts from the beginning of that track (if the reverse mode is set to). However, if the front side ends within 12 seconds from the beginning of a track, recording on the reverse side starts from the previous track.

To stop recording, press .

Recording CD onto an MD and a Tape —CD Synchronized Recording

With this recording method, you can start and stop CD play, MD and tape recordings at the same time.

1 Load discs into the 5-CD changer.

- If the current playing source is not “CD,” press CD ►/II, then ■ before going to the next step.
- You can make a program (see page 17) or select Random Play (see page 18) if you want. → Go to step 3.

On the remote control ONLY:

2 Press DISC UP ^ or DISC DOWN v to select the disc you want to record, then ■ before going to the next step.

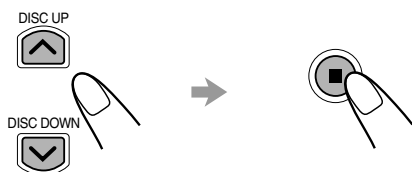

3 Insert a recordable MD into the MD loading slot and put a recordable cassette into the cassette loading slot.

For the MD:

Set the MD recording length mode, “LP:”-prefix addition mode, and group recording mode (see “Setting MD Recording Modes” on page 30).

- Set the MD recording speed to “x1.”

For the cassette:

Press REV.MODE to select Reverse Mode as necessary.

4 Press MD&TAPE REC.

CD play and recording start.

- When you select a track by pressing ►► or ◀◀ before pressing MD&TAPE REC, recording starts from the selected track (except when Program Play is selected).



The **REC** (MD recording) and **REC** (tape recording) indicators start flashing on the display.

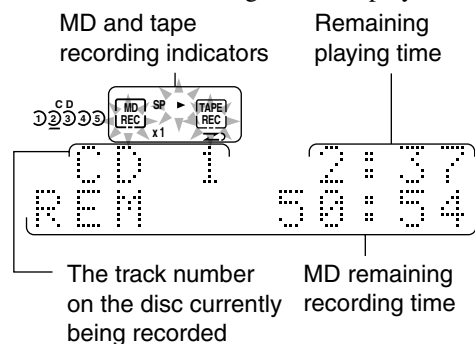

When CD player stops, MD recorder and the cassette deck stop automatically.

To stop recording, press ■.

“WRITING” flashes on the display for a while.

To eject the MD or tape, press ■ to stop the recording, then press the corresponding eject button.

To record a single track during play or pause

On the remote control ONLY:

While playing back or pausing a track you want to record, press MD&TAPE REC.



The playback of the track is stopped, and the same track starts playing from the beginning again. This time, the MD recorder and cassette deck start recording the track.

- After the track is recorded, both playback and recording stop automatically.

To change the information shown on the display

On the remote control ONLY:

Press DISP/CHARA.

- Each time you press the button, the recording indications, the current track numbers of both the disc and the MD, and the clock indication appear in sequence on the display.



- **When recording from a CD-R/RW**
You cannot make a digital recording from a digital-copied CD-R/RW on an MD. “SCMS CANNOT COPY” appears on the display and an analog recording starts (see page 63).
- **When recording on an MD and a tape at the same time**
A 4-second blank before each track is not made on the tape.

Editing MDs

Guidance—MD Group Functions

To add to the conventional MD Editing functions (called the track editing functions in this manual), MD Group functions help you to classify the tracks by making groups on your MD.

Classifying the tracks on an MD

MDLP enables you to record more tracks on a single MD than usual. So, there are many tracks which have been recorded from the various sources—CDs, FM, and so on—on your MD.

In that case, if you can classify the tracks by source, by album, or by artist, the playback of your favorite songs becomes much easier.

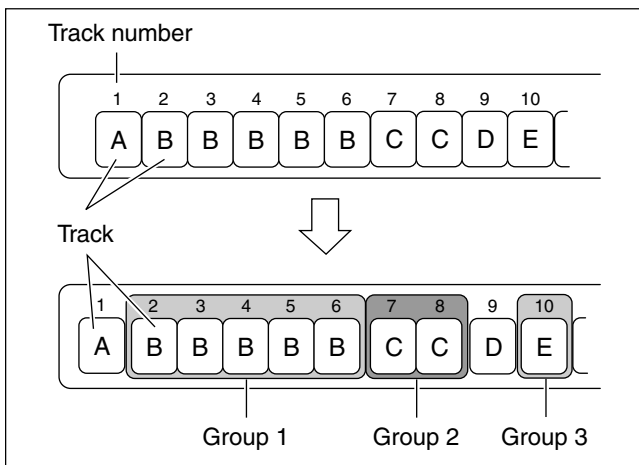

In the figure above, as an example, there are 5 different genres (from A to E) of tracks on the MD. Using MD Group functions, you can form a group by genre B tracks as Group 1, genre C tracks as Group 2, etc.

By forming groups on the MD, you can classify the tracks by each genre—the album title, the artist, etc. You can also assign a name to each group (see pages 51 – 53).

Using MD Groups as a separate item

You can enjoy playback, recording, and editing groups.

- **Playback (see page 23):**
You can play back and repeat the desired group without making a program: For example, you can play back repeatedly genre B tracks by selecting Group 1 in the left figure—Group Play.
- **Recording (see page 30):**
You can form a group while tracks are being recorded.
- **Editing:**
You can edit the groups using the following functions:
 - Forming a group (FORM GR)
 - Adding a track to a group (ENTRY GR)
 - Dividing a group (DIVIDE GR)
 - Joining two groups (JOIN GR)
 - Moving a group (MOVE GR)
 - Ungrouping tracks (UNGROUP)
 - Dissolving all groups (UNGR ALL)
 - Erasing tracks in a group (ERASE GR)

How to make up Groups

You can make up groups using two methods: Forming-a-group function and Group recording function.

- **Forming-a-group function—FORM GR:**
Select this when you want to make groups after recording (see page 39).
- **Group recording function:**
Press GROUP REC ON/OFF to record and group tracks at the same time (for details, see page 30).

Introducing Group Editing Functions

The groups and tracks can be edited in many ways (Group editing functions and Track editing functions). From this page to page 45, the group editing functions are explained. For details on the track editing functions, see pages 46 to 50.

Forming a group (FORM GR): Page 39

This function forms a series of tracks or a single track into a new group.

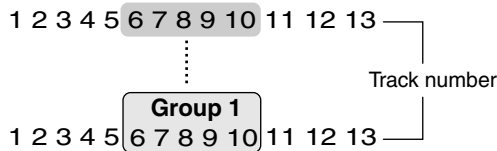

Adding a track to a group (ENTRY GR): Page 40

This function enters the selected track into a group.

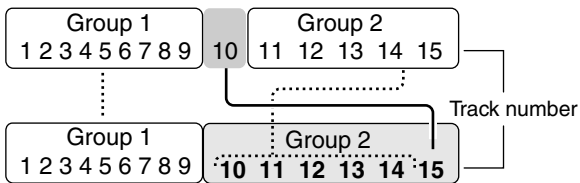

Dividing a group (DIVIDE GR): Page 41

This function divides a group containing plural tracks.

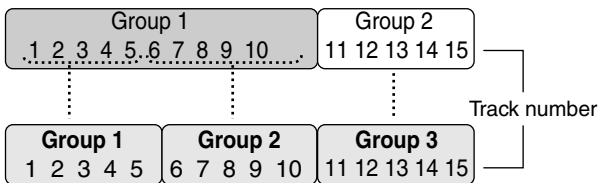

Joining two groups (JOIN GR): Page 42

This function joins two adjacent groups into a single group.

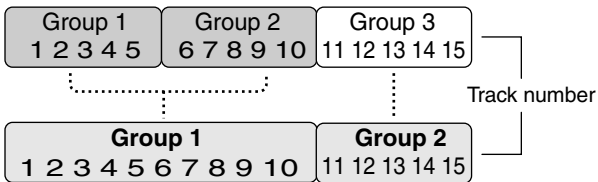

Moving a group (MOVE GR): Page 43

This function moves the selected group by reordering the group and track numbers.

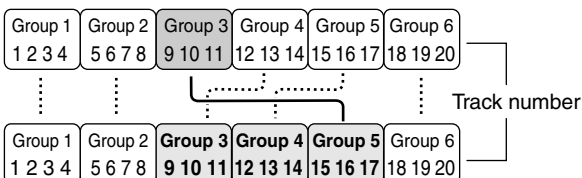

Ungrouping tracks (UNGROUP): Page 44

This function dissolves a group.

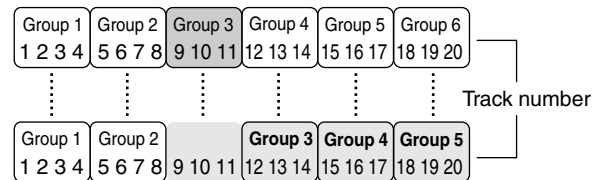

Dissolving all groups (UNGR ALL): Page 44

This function dissolves all the groups.

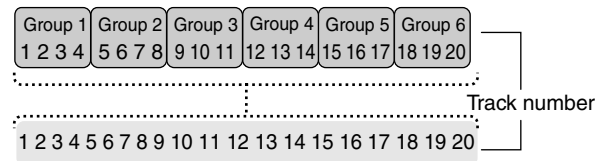

Erasing tracks in a group (ERASE GR): Page 45

This function erases the tracks in the selected group.

- Group numbers and track numbers are renumbered automatically.

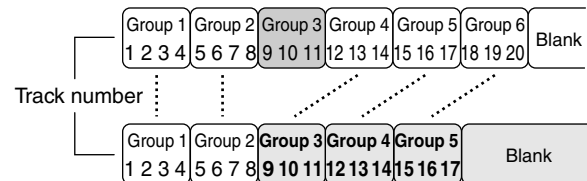

- If "PLAY BACK DISC" or "DISC PROTECTED" appears when you try to edit an MD
You cannot edit such MDs. See pages 62 and 63.
- During Program Play or Random Play
You can edit the MD as long as the playback is stopped. However, editing groups will resume Normal Play (the program in memory will be cleared).

In the following examples of group editing, the process is explained from the very first—that is, inserting a disc. You can also edit an MD during playback (in Normal Play).

Forming a Group—FORM GR

This function allows you to form a group from a series of tracks which do not belong to the other groups. You can form a group from a single track.

Once a new group is formed, the other groups are renumbered.

- You can form up to 99 groups on a single MD.
- To stop any time during the editing process below before step 8, press GROUP TITLE/EDIT.

1 Insert an MD you want to edit into the MD loading slot.

On the remote control ONLY:

2 Press GROUP TITLE/EDIT repeatedly until “FORM GR ?” appears on the display.



FORM GR ?
YES? → SET

- If you want to stop this editing process, press CANCEL.

3 Press SET.

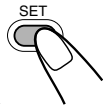

T 1 → I - - ?
OK? → SET

- **During playback:**
The currently playing track number starts flashing.

4 Press ►► or ◀◀ to select the first track of a new group.

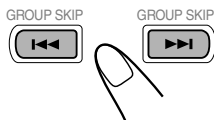

- You can also select the track using the number buttons. In this case, the selected track starts playback repeatedly.

T 3 → I - - ?
OK? → SET

Ex.: When track 3 is selected.

5 Press SET.

- If the track selected as the first track belongs to another group, “GROUP TRACK” appears on the display. Select another track again (repeat step 4).
- If you want to form a group from the selected track only, go to step 7.
- To cancel the setting, press CANCEL, then repeat from step 4.

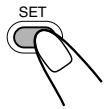

6 Press ►► or ◀◀ to select the last track of the new group.

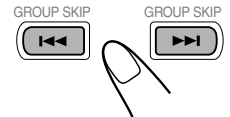

- You can also select the track using the number buttons. In this case, the selected track starts playback repeatedly.

T 3 → I 5 ?
OK? → SET

Ex.: When track 5 is selected.

7 Press SET.

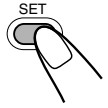

<FORM GR>
YES? → ENTER

- If the last selected track belongs to another group, “GROUP TRACK” appears on the display. Select another track again (repeat step 6).
- To cancel the setting, press CANCEL, then repeat from step 4.

8 Press ENTER.

“EDITING” appears on the display. Then “WRITING” and the REC (MD recording) indicator flash while the editing you have made is being recorded on the MD and playback stops.



To dissolve the group, see the UNGROUP function on page 44.



When “CANNOT FORM!” appears on the display in step 7

You are trying to form a new group which includes another group between the first and the last track. In this case, dissolve the previous group and form a new one again.

Adding a Track to a Group—ENTRY GR

This function allows you to enter a track into a group. The track will be added as the last track in the selected group. The track numbers will be renumbered.

- To stop any time during the editing process below before step 8, press GROUP TITLE/EDIT.

1 Insert an MD you want to edit into the MD loading slot.

On the remote control ONLY:

2 Press GROUP TITLE/EDIT repeatedly until “ENTRY GR ?” appears on the display.

ENTRY GR ?
YES? → SET



- If you want to stop this editing process, press CANCEL.

3 Press SET.

TR 1?
OK? → SET

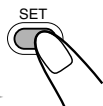

- During playback:**
The currently playing track number starts flashing.

4 Press ►► or ◀◀ to select the track.

- You can also select the track using the number buttons. In this case, the selected track starts playback repeatedly.

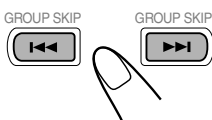

TR 13?
OK? → SET

Ex.: When track 13 is selected.

5 Press SET.

GROUP 1?
OK? → SET

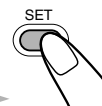

- If the loaded MD has no group, you cannot go to the following steps.
- When the selected track belongs to a group, its group number appears on the display.
- To cancel the setting, press CANCEL, then repeat from step 4.

6 Press GROUP SKIP ►► or GROUP SKIP ◀◀ while holding SHIFT to select the group.

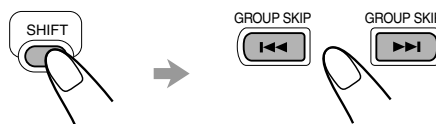

GROUP 18?
OK? → SET

Ex.: When group 18 is selected.

7 Press SET.

<ENTRY GR>
YES? → ENTER

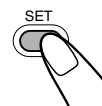

- To cancel the setting, press CANCEL, then repeat from step 4.

8 Press ENTER.

“EDITING” appears on the display. Then “WRITING” and the REC (MD recording) indicator flash while the editing you have made is being recorded on the MD and playback stops.



notes When “CANNOT ENTRY!” appears on the display in step 7

You are trying to enter the selected track into the same group again. Repeat procedure from step 6.

Dividing a Group—DIVIDE GR

This function allows you to divide one group into two separate groups.

You cannot divide the group containing only a single track. When the original group has a title, two separate groups are reassigned the same title as the original group. Once a new group is divided, the other groups are renumbered.

- To stop any time during the editing process below before step 7, press GROUP TITLE/EDIT.

1 Insert an MD you want to edit into the MD loading slot.

On the remote control ONLY:

2 Press GROUP TITLE/EDIT repeatedly until “DIVIDE GR?” appears on the display.



DIVIDE GR?
YES?→SET

- If you want to stop this editing process, press CANCEL.

3 Press SET.

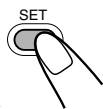

G 1 T
OK?→SET

- If the loaded MD has no group, you cannot go to the following steps.
- During playback:**
The current playing track number and its group number will appear. If the track does not belong to any group, the group number will be indicated as “--.”

4 Press GROUP SKIP ►► or GROUP SKIP ◀◀ while holding SHIFT to select the group you want to divide.

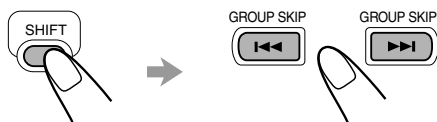

The first track of the selected group

G 2 T
OK?→SET

Ex.: When group 2 is selected.

5 Press ►► or ◀◀ to select the track as the dividing point.

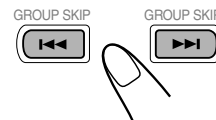

The track selected in this step will be the first track in the divided group.

- You can also select the track using the number buttons. In this case, the selected track starts playback repeatedly.

G 2 T
OK?→SET

Ex.: When track 18 is selected.

- You cannot select the first track in a group or an ungrouped track as a dividing point.

6 Press SET.

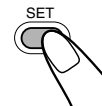

< DIVIDE GR >
YES?→ENTER

- To cancel the setting, press CANCEL, then repeat from step 4.

7 Press ENTER.



“EDITING” appears on the display. Then “WRITING” and the REC (MD recording) indicator flash while the editing you have made is being recorded on the MD and playback stops.

To join the divided groups, see the JOIN GR function on page 42.

Joining Two Groups—JOIN GR

This function allows you to join two adjacent groups into a single group.

When the groups have their own titles, the title of the preceding group is reassigned to the newly joined group. Once two groups are joined, the other groups are renumbered.

- To stop any time during the editing process below before step **6**, press GROUP TITLE/EDIT.

1 Insert an MD you want to edit into the MD loading slot.

On the remote control ONLY:

2 Press GROUP TITLE/EDIT repeatedly until “JOIN GR ?” appears on the display.



JOIN GR ?
YES? → SET

- If you want to stop this editing process, press CANCEL.

3 Press SET.

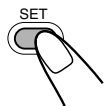

G 7+G 8?
OK? → SET

- If the loaded MD has only one or no group, you cannot go to the following steps.
- **During playback:**
The group number of the currently playing track will appear on the right. If the track does not belong to any group, the group number will be indicated as “--.”

4 Press GROUP SKIP or GROUP SKIP while holding SHIFT to select the two adjacent groups you want to join.

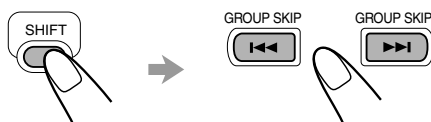

G 7+G 8?
OK? → SET

Ex.: When groups 7 and 8 are selected.

5 Press SET.

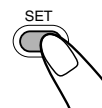

JOIN GR ?
YES? → ENTER

- To cancel the setting, press CANCEL, then repeat from step **4**.

6 Press ENTER.



“EDITING” appears on the display. Then “WRITING” and the **REC** (MD recording) indicator flash while the editing you have made is being recorded on the MD.

To divide the group, see the DIVIDE GR function on page 41.



notes When “CANNOT JOIN” appears on the display in step **5**

You are trying to join two groups which are separated by another track(s) in-between. In this case, you need to move either of the groups (see page 43) or the track(s) (see page 49).

Moving a Group—MOVE GR

This function allows you to move a group. Once a group is moved, the tracks and the other groups are renumbered.

- To stop any time during the editing process below before step 8, press GROUP TITLE/EDIT.

1 Insert an MD you want to edit into the MD loading slot.

On the remote control ONLY:

2 Press GROUP TITLE/EDIT repeatedly until “MOVE GR ?” appears on the display.



MOVE GR ?
YES? → SET

- If you want to stop this editing process, press CANCEL.

3 Press SET.

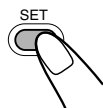

G +G 1?
OK? → SET

- If the loaded MD has only one or no group, you cannot go to the following steps.
- During playback:**
The group number of the currently playing track will appear. If the track does not belong to any group, the group number will be indicated as “- -.”

4 Press GROUP SKIP ►► or GROUP SKIP ◄◄ while holding SHIFT to select the group you want to move.

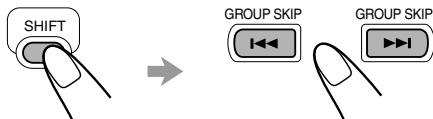

G +G 3?
OK? → SET

Ex.: When group 3 is selected.

5 Press SET.

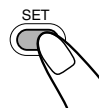

G +G 3?
OK? → SET

- To cancel the setting, press CANCEL, then repeat from step 4.

6 Press GROUP SKIP ►► or GROUP SKIP ◄◄ while holding SHIFT to select the position where you want to move the group to.

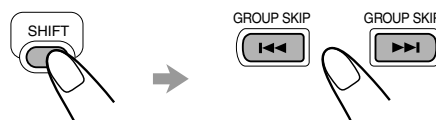

G +G 10?
OK? → SET

Ex.: When group 3 is moved to group 10.

7 Press SET.

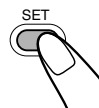

<MOVE GR>
YES? → ENTER

- To cancel the setting, press CANCEL, then repeat from step 4.

8 Press ENTER.

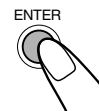

“EDITING” appears on the display. Then “WRITING” and the REC (MD recording) indicator flash while the editing you have made is being recorded on the MD.

Ungrouping Tracks—UNGROUP

This function allows you to dissolve a group. You cannot erase the tracks using this function. Once tracks are ungrouped, the other groups are renumbered.

- To stop any time during the editing process below before step **6**, press GROUP TITLE/EDIT.

1 Insert an MD you want to edit into the MD loading slot.

On the remote control ONLY:

2 Press GROUP TITLE/EDIT repeatedly until “UNGROUP ?” appears on the display.



UNGROUP ?
YES? → SET

- If you want to stop this editing process, press CANCEL.

3 Press SET.

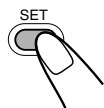

GROUP -- ?
YES? → SET

- If the loaded MD has no group, you cannot go to the following steps.
- During playback:** The group number of the currently playing track will appear. If the track does not belong to any group, the group number will be indicated as “--”.

4 Press GROUP SKIP ►► or GROUP SKIP ◄◄ while holding SHIFT to select the group you want to dissolve.

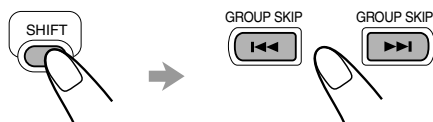

GROUP 3 ?
YES? → SET

Ex.: When group 3 is selected.

5 Press SET.

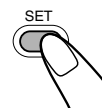

<UNGROUP ?>
YES? → ENTER

- To cancel the setting, press CANCEL, then repeat from step **4**.

6 Press ENTER.



“EDITING” appears on the display. Then “WRITING” and the REC (MD recording) indicator flash while the editing you have made is being recorded on the MD.

Dissolving All Groups—UNGR ALL

This function allows you to dissolve all the groups. You cannot erase the tracks using this function.

- To stop any time during the editing process below before step **4**, press GROUP TITLE/EDIT.

1 Insert an MD you want to edit into the MD loading slot.

On the remote control ONLY:

2 Press GROUP TITLE/EDIT repeatedly until “UNGR ALL ?” appears on the display.



UNGR ALL ?
YES? → SET

- If you want to stop this editing process, press CANCEL.

3 Press SET.

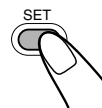

<UNGR ALL ?>
YES? → ENTER

- To cancel the setting, press CANCEL.

4 Press ENTER.



“EDITING” appears on the display. Then “WRITING” and the REC (MD recording) indicator flash while the editing you have made is being recorded on the MD.

Erasing Tracks in a Group—ERASE GR

This function allows you to erase a group together with tracks in the group.

You cannot resume the tracks in the erased group.

Once a group is erased, the other tracks and groups are renumbered.

- To stop any time during the editing process below before step **6**, press GROUP TITLE/EDIT.

1 Insert an MD you want to edit into the MD loading slot.

On the remote control ONLY:

2 Press GROUP TITLE/EDIT repeatedly until “ERASE GR ?” appears on the display.

ERASE GR ?
YES?→SET



- If you want to stop this editing process, press CANCEL.

3 Press SET.

G 6 ERASE?
ERASE?→SET

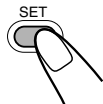

- If the loaded MD has no group, you cannot go to the following steps.
- During playback:**
The group number of the currently playing track will appear. If the track does not belong to any group, the group number will be indicated as “—.”

4 Press GROUP SKIP ►► or GROUP SKIP ◀◀ while holding SHIFT to select the group you want to erase.

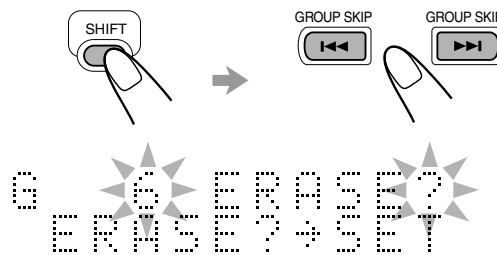

Ex.: When group 6 is selected

5 Press SET.

<ERASE GR>
YES?→ENTER

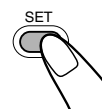

- To cancel the setting, press CANCEL, then repeat from step **4**.

6 Press ENTER.

“EDITING” appears on the display. Then “WRITING” and the **REC** (MD recording) indicator flash while the editing you have made is being recorded on the MD.



Introducing Track Editing Functions

The groups and tracks can be edited in many ways (Group editing functions and Track editing functions). From this page to page 50, the track editing functions are explained. For details on the group editing functions, see pages 37 to 45.

Dividing a track (DIVIDE): Page 47

This function divides a track by adding a track mark(s) in the middle or where you want to search for later.

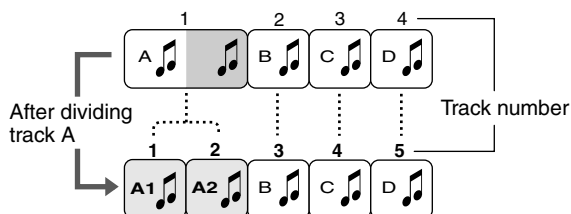

Joining two tracks (JOIN): Page 48

This function joins two adjacent tracks into a single track by deleting a track mark.

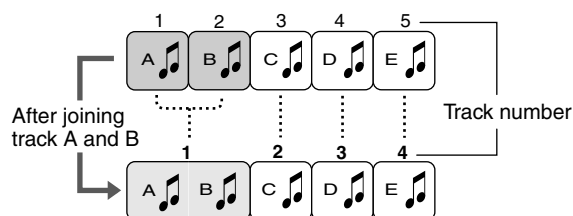

Moving a track (MOVE): Page 49

This function moves a track by reordering the track numbers.

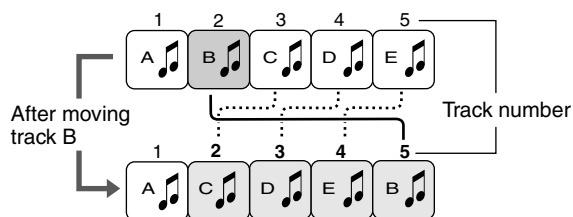

Erasing tracks (ERASE): Page 50

This function erases selected tracks. After the erasure, the subsequent tracks are justified and their track numbers are renumbered automatically. You can erase up to 15 tracks at a time.

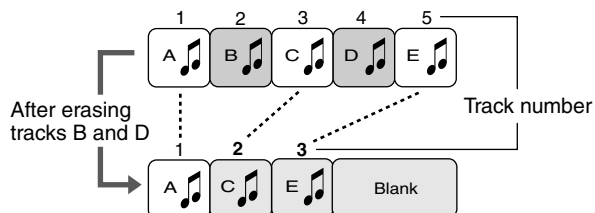

Erasing all tracks (ALL ERASE): Page 50

This function erases all data on a disc entirely.

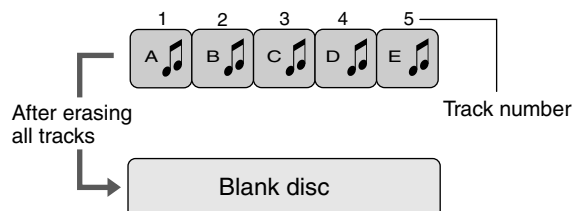

Erasing a portion of a track

By combining "DIVIDE," "ERASE" and "JOIN," for example, it is possible to erase only a part of an existing track.

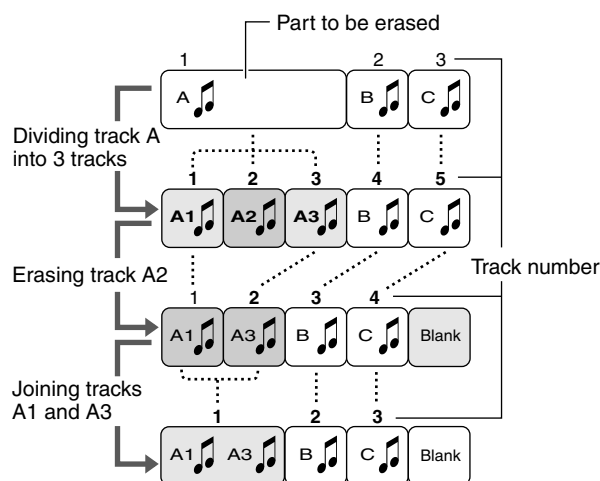

- If "PLAY BACK DISC" or "DISC PROTECTED" appears when you try to edit an MD
You cannot edit such MDs. See pages 62 and 63.
- During Program Play or Random Play
You can edit the MD as long as the playback is stopped. However, editing tracks will resume Normal Play (the program in memory will be cleared).

In the following examples of track editing, the process is explained from the very first—that is, inserting a disc. You can also edit an MD during playback (in Normal Play).

Dividing a Track—DIVIDE

This function allows you to divide one track into two separate tracks. It is useful, for example, when you want to add track marks at a certain point within a track or if you want to separate a recording.

When the original track has a title, two separate tracks are reassigned the same title as the original track in the same group (if the original track is belonged to a group).

Once a track is divided, the other tracks are renumbered.

- To stop any time during the editing process below before step 8, press TITLE/EDIT.

1 Insert an MD you want to edit into the MD loading slot.

On the remote control ONLY:

2 Press TITLE/EDIT repeatedly until “DIVIDE ?” appears on the display.

DIVIDE
YES? → SET



- If the loaded MD has no track, “DIVIDE ?” will not appear on the display.
- If you want to stop this editing process, press CANCEL.

3 Press SET.

The first track on the MD starts playback repeatedly.

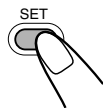

4 Press >>> or <<< to select the track you want to divide.

- You can also select the track using the number buttons.

12 2:50
YES? → SET

Ex.: When track 12 is selected.

- If you press and hold >>> or <<<, you can fast-forward or fast-reverse the selected track.

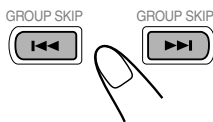

5 Press SET when you find the point where you want to divide the track.

“POSIT. (position) 0” appears on the display, and the unit repeats the selected point—a 3-second period following the dividing point.

POSIT. 0
OK? → SET



- If the loaded MD has 254 tracks, “DISC FULL” will appear (see “MD limitations” on page 61) and you cannot go to the following steps.
- If the dividing point is satisfactory, go to step 7. If not, go to the next step.
- To cancel the setting, press CANCEL, then repeat from step 4.

6 Press > or < to precisely adjust the dividing point.

When you stop pressing the button, the unit repeats the newly selected dividing point.

- You can shift the dividing point up to ± 128 . This range (± 128) corresponds to approximately ± 8 seconds* from the original point (position 0).

POSIT. -103
OK? → SET

Ex.: When adjusting the point by -103.

* When the recording length mode of the selected track is “SP.” For “LP2,” it is approximately ± 16 seconds, and for “LP4” approximately ± 32 seconds.

- When you find the correct position, go to the next step.
- To cancel the setting, press CANCEL, then repeat from step 4.

7 Press SET.

< DIVIDE >
YES? → ENTER

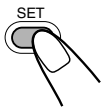

8 Press ENTER.

“EDITING” appears on the display. Then “WRITING” and the REC (MD recording) indicator flash while the editing you have made is being recorded on the MD.



To join the divided tracks, see the JOIN function on page 48.

Joining Two Tracks—JOIN

This function allows you to join two adjacent tracks into one track.

When the tracks have their own titles, the title of the preceding track is reassigned to the newly joined track. Once two tracks are joined, the other tracks and/or the groups are renumbered.

- To stop any time during the editing process below before step 6, press TITLE/EDIT.

1 Insert an MD you want to edit into the MD loading slot.

On the remote control ONLY:

2 Press TITLE/EDIT repeatedly until “JOIN ?” appears on the display.



JOIN
YES? → SET

- If the loaded MD has no track, “JOIN ?” will not appear.
- If you want to stop this editing process, press CANCEL.

3 Press SET.

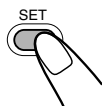

1
OK? → SET

- If the loaded MD has only one track, you cannot go to the following steps.

4 Press or to select the two adjacent tracks you want to join.

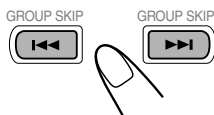

- You can also select the tracks using the number buttons*. In this case, the selected track starts playing repeatedly.

2+ 3
OK? → SET

Ex.: When tracks 2 and 3 are selected.

* Select the succeeding track of two tracks when you use the number buttons.

5 Press SET.

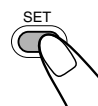

<JOIN>
YES? → ENTER

- To cancel the setting, press CANCEL, then repeat from step 4.

6 Press ENTER.



“EDITING” appears on the display. Then “WRITING” and the REC (MD recording) indicator flash while the editing you have made is being recorded on the MD.

To divide the joined tracks, see the DIVIDE function on page 47.



- If “CANNOT JOIN” appears in step 5
You cannot join the following tracks.
 - Tracks recorded using different recording length modes (SP, LP2, LP4). (See page 30.)
 - Digital-recording tracks and analog-recording tracks.
 - Tracks recorded using monaural long recording method (not possible on this unit) and stereo-recording tracks.
- When the track belongs to a group
If the preceding track of two tracks you want to join belongs to a group, the newly joined track will belong to that group. On the other hand, if the preceding track does not belong to any group, the newly joined track will not belong to any group even if the succeeding track belongs to a group.

Moving a Track—MOVE

This function allows you to move a track to the position you prefer. It is useful to change the order of the tracks as you like.

Once a track is moved, the tracks and/or the groups are renumbered.

- To stop any time during the editing process below before step 8, press TITLE/EDIT.

1 Insert an MD you want to edit into the MD loading slot.

On the remote control ONLY:

2 Press TITLE/EDIT repeatedly until “MOVE ?” appears on the display.

MOVE
YES? → SET



- If the loaded MD has no track, “MOVE ?” will not appear on the display.
- If you want to stop this editing process, press CANCEL.

3 Press SET.

+ 1
OK? → SET

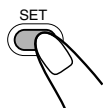

- If the loaded MD has only one track, you cannot go to the following steps.

4 Press >>> or <<<< to select the track you want to move.

- You can also select the track using the number buttons. In this case, the selected track starts playing repeatedly.

+ 3
OK? → SET

Ex.: When track 3 is selected.

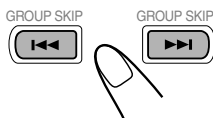

5 Press SET.

OK? → SET

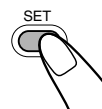

- To cancel the setting, press CANCEL, then repeat from step 4.

6 Press >>> or <<<< to select the position where you want to move the track to.

- You can also select the track using the number buttons. In this case, the selected track starts playing repeatedly.

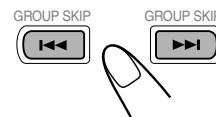

+ 8
OK? → SET

Ex.: When track 3 is moved to track 8.

- If the track selected in this step belongs to a group, the track selected in step 4 will be entered into the same group with the current track after moving.

7 Press SET.

<MOVE>
YES? → ENTER

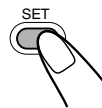

- To cancel the setting, press CANCEL, then repeat from step 4.

8 Press ENTER.

“EDITING” appears on the display. Then “WRITING” and the REC (MD recording) indicator flash while the editing you have made is being recorded on the MD.

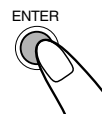

Erasing Tracks—ERASE

This function allows you to erase unwanted tracks.

You cannot resume the erased tracks.

Once tracks are erased, the other tracks and/or groups are renumbered.

You can erase up to 15 tracks at a time.

- To stop any time during the editing process below before step 8, press TITLE/EDIT.

1 Insert an MD you want to edit into the MD loading slot.

On the remote control ONLY:

2 Press TITLE/EDIT repeatedly until “ERASE?” appears on the display.



ERASE?
YES? → SET

- If the loaded MD has no track, “ERASE?” will not appear.
- If you want to stop this editing process, press CANCEL.

3 Press SET.

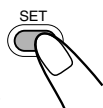

ERASE?
ERASE → SET

4 Press ►► or ◀◀ to select the track you want to erase.



- You can also select the track using the number buttons. In this case, the selected track starts playing repeatedly.

5 Press SET.

“✓” appears on the display.

The track marked with “✓” will be erased.

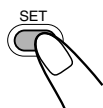

✓
5 ERASE?
NO? → CANCEL

Ex.: When track 5 is selected.

- When you do not want to erase the track, press CANCEL to remove “✓”

6 Repeat steps 4 and 5 to select all the tracks you want to erase.

- You can select up to 15 tracks. If you select a 16th track to erase, “MEMORY FULL” will appear on the display.

7 Press ENTER.



<ERASE>
YES? → ENTER

8 Press ENTER.



“EDITING” appears on the display. Then “WRITING” and the REC (MD recording) indicator flash while the editing you have made is being recorded on the MD.

Erasing All Tracks—ALL ERASE

This function allows you to erase all the tracks on an MD.

You cannot resume the erased tracks.

1 Insert an MD you want to edit into the MD loading slot.

On the remote control ONLY:

2 Press TITLE/EDIT repeatedly until “ALL ERASE?” appears on the display.



ALL ERASE?
YES? → SET

- If you want to stop this editing process, press CANCEL.

3 Press SET.

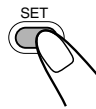

<ALL ERASE>
YES? → ENTER

- To cancel the setting, press CANCEL.

4 Press ENTER.



“EDITING” appears on the display. Then “WRITING” and the REC (MD recording) indicator flash while the editing you have made is being recorded on the MD. “BLANK DISC” appears on the display.

Assigning Titles to an MD

You can assign a name to each MD, to each group and to each track using alphabetic characters (uppercase and lowercase), symbols and numerals. Once a title is assigned, it is displayed for your confirmation.

- You cannot edit titles composed of more than 61 characters.

About the number of characters entered for an MD

The total number of characters that you can enter for an MD is 1792. The maximum number that you can enter for a disc/track title is 61. (However, the actual number you can enter may be slightly less than the maximum numbers due to the MD limitations—see page 61.)

- A space can be counted as one character.
- When the stereo long-hour recording (LP2 or LP4, see page 30) method is used for recording, the maximum number you can enter for a track title is automatically reduced since “LP:” and a space are automatically added to the beginning of the track title. Consequently this reduces the total number of characters you can enter for an MD.

Ex.: You can enter up to 10 characters for each track if an MD is composed of 120 tracks recorded using the stereo long-hour recording method.

In the following example, the process is explained from the very first—that is, inserting a disc. If you have already started recording or playing, start from step 2.

- You can edit titles during playback (in Normal Play).
- To exit from the title entry screen any time during the process, press TITLE/EDIT or GROUP TITLE/EDIT repeatedly.

1 Insert an MD you want to edit into the MD loading slot.

2 Enter the unit into the title entry mode.

For the disc and track title:

Press TITLE/EDIT.

- During stop mode:
Disc title entry screen appears on the display.

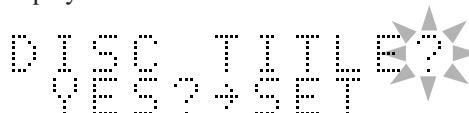

- During play mode:
Track title entry screen appears on the display.

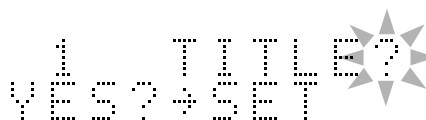

TITLE/EDIT



For the group title:

Press GROUP TITLE/EDIT.

- Group title entry screen appears on the display.

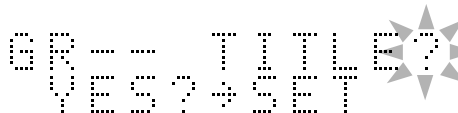

GROUP TITLE EDIT



- If the loaded MD has no group, you cannot go to the following steps.

3 Press \rightarrow or \leftarrow to change the title entry mode.

- Each time you press the button, the title entry mode changes as follows:

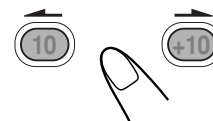

For the disc and track title:

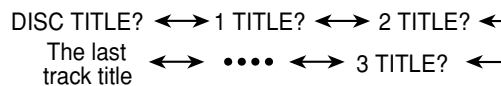

For the group title:

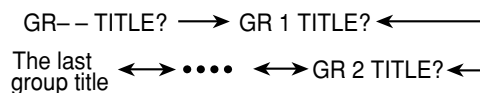

4 Press SET to enter the unit into the selected title entry mode.

Character entry position

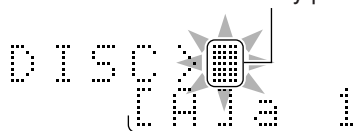

Character set

Ex.: When the disc has no title.

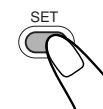

5 Enter characters.



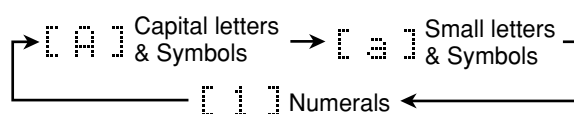

1) Press DISP/CHARA to select the character set you want.

- Each time you press the button, the character set changes as follows:



2) Press the character entry button for a character you want to enter.

Ex.:

- To enter an “A” or “a,” press ABC once.
- To enter a “B” or “b,” press ABC twice.
- To enter a “C” or “c,” press ABC three times.
- To enter a symbol, press MARK repeatedly until the mark you want appears. For available symbols, see page 53.
- To enter a numeral, press 0 – 9.
- To enter a space while entering a title, press  twice.
- To move the character entry position while entering a title, press  or .
- If you have entered an incorrect character, press  or  to select the character you want to correct, then press CANCEL to delete it.



* If you press  repeatedly during recording, the entered characters may be displayed incorrectly. In this case, press TITLE/EDIT or GROUP TITLE/EDIT, then repeat from step 2 again.

3) Repeat steps 5 – 1) and 5 – 2) to enter other characters.

- If the character you want to enter next is assigned to the same button you have just pressed in step 5 – 2), press  once to move the character entry position to the right.
- The display can only show 6 characters at a time. If you enter the 7th character, the first character disappears, and so on.

6 Press ENTER to finish the current title entry.

“EDITING” appears on the display for a while, then the next title entry screen appears.

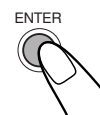

• For the disc title:

The track title entry screen for the track 1 appears.

• For the track title:

The next track title entry screen appears (or the unit exits from the title entry screen if the current track is the last one on the disc).

• For the group title:

The next group title entry screen appears (or the same screen still remains if the current group is the last one on the disc).

If you want to continue assigning a title, repeat steps 3 to 6.

7 Press CANCEL to exit from the title entry mode.

- While recording, do not go to the next step until the recording ends.

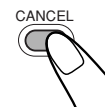

8 Press (MD eject) on the unit to eject the MD.

“WRITING” and the REC (MD recording) indicator flash while the editing you have made is being recorded on the MD.





You can assign titles during play or recording

• During play:

Entering a track title

The MD recorder repeats playback of the current track until you press ENTER in step **6**. When you press ENTER, the next track will be played.

Entering a disc title

The MD recorder repeats playback of all tracks of the MD until you press ENTER in step **6**. When you press ENTER, the MD recorder enters the track title entry mode.

Entering a group title

The MD recorder repeats playback of the tracks in the group until you press ENTER in step **6**. When you press ENTER, the MD recorder enters the next group title entry mode.

• During recording:

Entering a track title

The MD recorder continues recording even after you press ENTER in step **6**. When you press ENTER, a track title is assigned to the track where you have started the title entry. If you do not press ENTER before recording ends, the track title assigned will be canceled.

• During CD-MD or CD Synchronized Recording (see pages 30 and 36):

You can assign the disc title, and 16 track titles one after another as recording goes on. The track titles you have entered are automatically assigned to the tracks recorded on the MD in sequential order.

“EDITING” appears on the display for a while, then the next title entry screen appears. If you enter 17th track title or more, they are ignored.



When you unplug the AC power cord or if a power failure occurs before step **8**

The editing you have made is not recorded on the MD.

Available symbols are as follows:

(Blank)	!	"	#	\$	%	&	'	()
*	+	,	-	.	/	:	;	< =
>	?	@	_	\				

Changing the Title

You can make a correction or change the title.

1 Follow steps **1** to **4** on page 51.

2 Select the character you want to correct, by pressing

→ or ←.

- Make sure that the character you want to change is flashing.

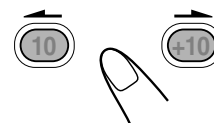

3 Press **CANCEL** to delete the character you have selected in the above step.



4 Enter the correct character, referring to step **5** on page 52.

5 Repeat steps **2** to **4** of the current procedure to correct more characters.

6 Press **ENTER** to finish correcting the title.

“EDITING” appears on the display for a while, then the next title entry screen appears.

- If you want to correct another title, select another title entry mode by pressing → or ←, press SET, then repeat from step **2** above.
- If you want to finish the correction, go to the next step.



7 Press **▲** (MD eject) on the unit to eject the MD.

“WRITING” and the **REC** (MD recording) indicator flash while the editing you have made is being recorded on the MD.



To erase all the characters, press **CANCEL** repeatedly in step **3** above to erase all the characters, then go to step **6**.

There are three timers available—Recording Timer, Daily Timer and Sleep Timer.

- Before using these timers, make sure the built-in clock is set correctly (see page 9).
- When using the tuner as the source, preset stations in advance (see page 14).

Using Recording Timer

With Recording Timer, you can make an unattended recording.

- You can set Recording Timer whether the unit is turned on or off (on standby).
- To correct a mis-entry any time during the setting process, press CANCEL.
- To exit from the timer setting during the process, press CLOCK/TIMER repeatedly until the source indication appears.

How Recording Timer actually works

The unit automatically turns on, muting the volume, and starts recording on the MD or on the tape when the start time comes. Then, when the shut-off time comes, the unit automatically turns off (on standby).

Recording Timer works only once, but the timer settings remain stored in memory until you reset them or unplug the AC power cord.

On the remote control ONLY:

1 Press CLOCK/TIMER repeatedly until “REC TIMER” appears on the display.

The  (timer) indicator lights up and the REC (recording timer) indicator starts flashing on the display.

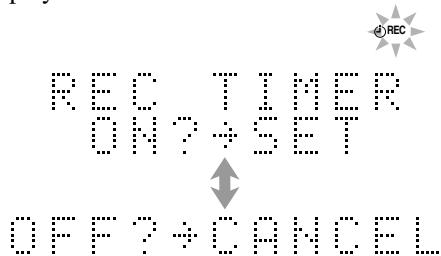

- Each time you press the button, the timer changes as follows:

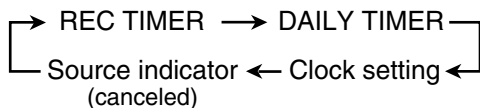

2 Press SET.

The source name flashes on the display.

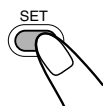

3 Select the source to record from.

1) Press or repeatedly to select the source.

- Each time you press the button, the source changes as follows:

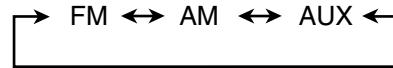
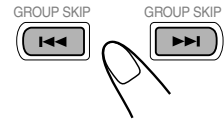

2) When you select “FM” or “AM,” press SET, then select a preset number by pressing or .



When you select “AUX,” set the timer function of the external component as well.

3) Press SET.

A device to record onto flashes on the display.

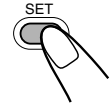

4 Select the device to record onto.

1) Press or repeatedly to select the device.

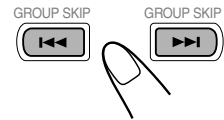
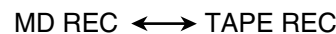

2) Press SET.

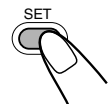

3) When you select “MD REC,” select the recording length mode (see page 30) by pressing or , then press SET again.

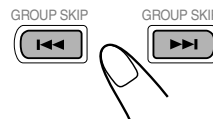

When you select “TAPE REC,” select Reverse Mode (see page 26) by pressing REV.MODE when you prepare the device.



When recording starts, reverse mode indicator changes to  automatically.

The hour digits of the start time start flashing.

5 Set the start time.

- 1) Press **▶▶** or **◀◀** repeatedly to adjust the hour.

You can also adjust the hour using the number buttons.



- 2) Press **SET**.

The minute digits start flashing.

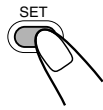

- 3) Press **▶▶** or **◀◀** repeatedly to adjust the minute.

You can also adjust the minute using the number buttons.



REC TIMER
ON 11:30

Ex.: When you set start time to 11:30.

- 4) Press **SET**.

The hour digits of the shut-off time start flashing.

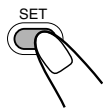

6 Set the shut-off time.

- 1) Press **▶▶** or **◀◀** repeatedly to adjust the hour.

You can also adjust the hour using the number buttons.



- 2) Press **SET**.

The minute digits start flashing.

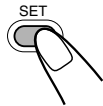

- 3) Press **▶▶** or **◀◀** repeatedly to adjust the minute.

You can also adjust the minute using the number buttons.



REC TIMER
OFF 13:00

Ex.: When you set shut-off time to 13:00.

- 4) Press **SET**.

The **REC** (recording timer) indicator stops flashing and remains lit. The contents of this setting appear on the display for your confirmation.

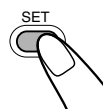

7 Press **STANDBY/ON** to turn off the unit if you have set the timer with the unit turned on.

To record onto an MD using the Group recording, press **GROUP REC ON/OFF** to turn on the Group recording after setting the Recording Timer (before turning off the unit).



Before the start time, the **REC** (recording timer) indicator and “REC TIMER STANDBY” start flashing on the display.

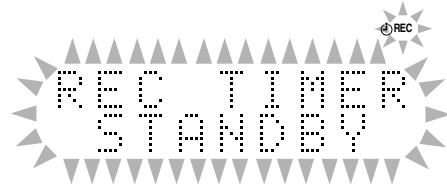

Before the shut-off time, the display changes as follow if MD is selected as the device to record:

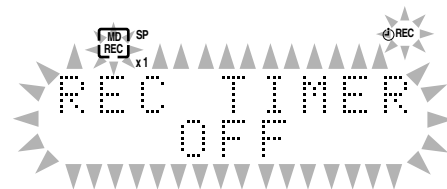

Clock indication

To turn off the Recording Timer after its setting is done

- 1 Press **CLOCK/TIMER** repeatedly until “REC TIMER” appears on the display.
- 2 Press **CANCEL**.
The  (timer) and **REC** (recording timer) indicators go off from the display.

To turn on the Recording Timer again

- 1 Press **CLOCK/TIMER** repeatedly until “REC TIMER” appears on the display.
- 2 Press **SET** repeatedly until the settings are shown on the display for your confirmation.
The  (timer) and **REC** (recording timer) indicators light up on the display.



- **Adjusting the hour and minute of the start and shut-off time using the number buttons in steps 5 - 1), 5 - 3), 6 - 1), and 6 - 3)**

Ex.: To adjust the hour/minute to 5, press 5.

To adjust the hour/minute to 12, press +10, then 2.

To adjust the hour/minute to 20, press +10, then 10 (or press +10 twice, then 0).

- **When you press  while Recording Timer works**
The recording stops but the timer is not canceled. The unit automatically turns off (on standby) when the shut-off time comes.
- **If the unit is kept turned on when the start time comes**
Recording Timer does not work at all.

Using Daily Timer

With Daily Timer, you can wake up to your favorite music or radio program.

- You can set Daily Timer whether the unit is turned on or off (on standby).
- To correct a mis-entry any time during the setting process, press CANCEL.
- To exit from the timer setting during the process, press CLOCK/TIMER repeatedly until the source indication appears.

How Daily Timer actually works

The unit automatically turns on, and starts playing the specified source when the timer-on time comes. Then, when the timer-off time comes, the unit automatically turns off (on standby).



Daily Timer works every day, and the timer settings remain stored in memory until you reset them or unplug the AC power cord.

On the remote control ONLY:

1 Press CLOCK/TIMER repeatedly until "DAILY TIMER" appears on the display.

The  (timer) indicator lights up and the **DAILY** indicator starts flashing on the display.



  **DAILY TIMER**
ON? → SET

↕

OFF? → CANCEL

- Each time you press the button, the timer changes as follows:

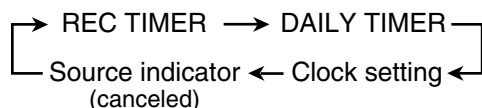

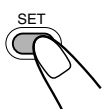

2 Press SET.

The source name flashes on the display.



3 Select the source to play back.





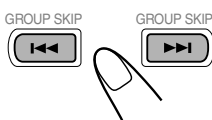
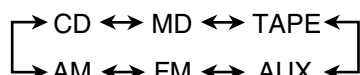

- 1) Press  or  repeatedly to select the source.

- Each time you press the button, the source changes as follows:





You can also use the source selecting buttons.

When you select "CD"



1. Press SET.
 2. Select the disc number by pressing  or  (or DISC UP  or DISC DOWN ) , then press SET again.
 3. Press  or  to select the track number.
- If there is no disc on the selected disc tray and if the selected track is the first track, the first track of next disc will be selected and starts playback when the on-time comes.

When you select "MD"

1. Press SET.
2. Press  or  to select the track number.

When you select "TAPE," prepare it for playback.

When you select "FM" or "AM"

1. Press SET.
2. Select a preset number by pressing  or .



When you select "AUX," set the timer function of the external component as well.

2) Press SET.

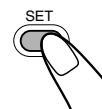
The hour digits of the start time start flashing.



4 Set the start time.

- 1) Press  or  repeatedly to adjust the hour.

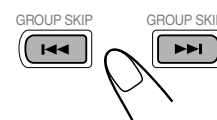

You can also adjust the hour using the number buttons.

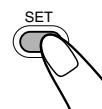

- 2) Press SET.

The minute digits start flashing.



- 3) Press  or  repeatedly to adjust the minute.

You can also adjust the minute using the number buttons.

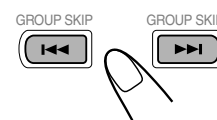

  **DAILY TIMER**
ON 7:00

Ex.: When you set start time to 7:00.

- 4) Press SET.

The hour digits of the shut-off time start flashing.

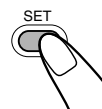

5 Set the shut-off time.

- 1) Press ►► or ◀◀ repeatedly to adjust the hour.

You can also adjust the hour using the number buttons.

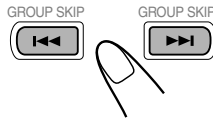

- 2) Press SET.

The minute digits start flashing.

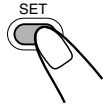

- 3) Press ►► or ◀◀ repeatedly to adjust the minute.

You can also adjust the minute using the number buttons.

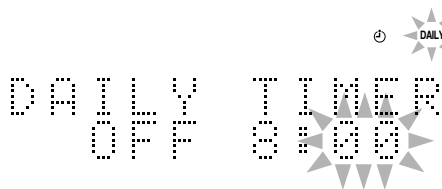
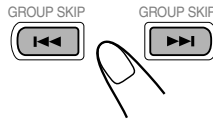

Ex.: When you set shut-off time to 8:00.

- 4) Press SET.

The volume setting appears on the display.

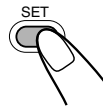

6 Adjust the volume level.

- 1) Press ►► or ◀◀ repeatedly to adjust the volume level.

- You can adjust the volume level to “- -” or within the range of 0 (silent) to 40 (maximum).
- When you select “VOLUME - -,” the volume is set to the volume level when you turn off the unit.

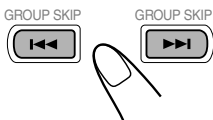

- 2) Press SET.

The **DAILY** indicator stops flashing and remains lit. The contents of this setting appear on the display for your confirmation.

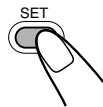

7 Press STANDBY/ON \odot /I to turn off the unit if you have set the timer with the unit turned on.



Before the start time, the **DAILY** indicator and “DAILY TIMER STANDBY” start flashing on the display.

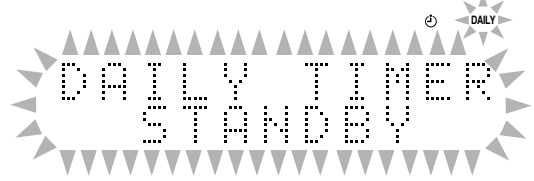

Before the shut-off time, the **DAILY** indicator and “DAILY TIMER OFF” start flashing on the display.

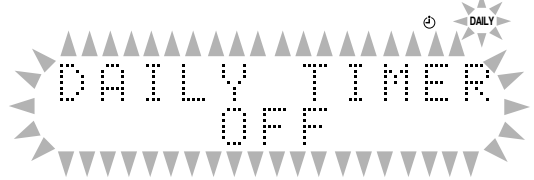

Clock indication

To turn off the Daily Timer after its setting is done

- Press CLOCK/TIMER repeatedly until “DAILY TIMER” appears on the display.
- Press CANCEL.
The \odot (timer) and **DAILY** indicators go off from the display.

To turn on the Daily Timer again

- Press CLOCK/TIMER repeatedly until “DAILY TIMER” appears on the display.
- Press SET repeatedly until the settings are shown on the display for your confirmation.
The \odot (timer) and **DAILY** indicators light up on the display.



- Adjusting the hour and minute of the start and shut-off time using the number buttons in steps 4 - 1), 4 - 3), 5 - 1), and 5 - 3)**

Ex.: To adjust the hour/minute to 5, press 5.

To adjust the hour/minute to 12, press +10, then 2.

To adjust the hour/minute to 20, press +10, then 10 (or press +10 twice, then 0).

- If the unit is kept turned on when the start time comes**
Daily Timer does not work at all.
- Daily Timer will be canceled and the unit will not turn off automatically in the following cases:**
 - When you change the source.
 - When you enter the MD editing or title entry mode.
 - When you turn off the Daily Timer (see above).

Using Sleep Timer

With Sleep Timer, you can fall asleep to your favorite music.

- You can set Sleep Timer when the unit is turned on.

How Sleep Timer actually works

The unit automatically turns off after the specified time length passes.

On the remote control ONLY:

1 Press SLEEP (A.STANDBY) repeatedly.

The ⏸ (timer) and the SLEEP indicators start flashing on the display.

“SLEEP 10” appears on the display for a while.



- Each time you press the button, the time length changes as follows:

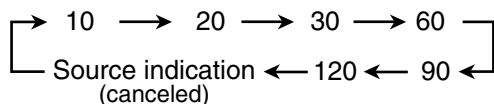

2 Press SET or wait for about 5 seconds.

The ⏸ (timer) and the SLEEP indicators stop flashing and remain lit.

The display dims automatically.

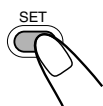

To check the remaining time until the shut-off time, press SLEEP once. The remaining time until the shut-off time appears for about 5 seconds.

To change the shut-off time, press SLEEP repeatedly until the time length you want appears.

To cancel the setting, press SLEEP repeatedly until the ⏸ (timer) and SLEEP indicators go off from the display.



Sleep Timer will be also canceled in the following cases:

- When you turn off the unit.
- When you operate other timer settings.
- When you adjust the clock.

To sleep with the Sleep Timer and wake up with the Daily Timer

The unit turns off (on standby) when the shut-off time comes (set by the Sleep Timer), and turns on when the start time (set by the Daily Timer) comes.

- Set the Daily Timer as explained on pages 56 and 57.
- Start playing back any source you want to listen to before sleep.
- Set the Sleep Timer.

Timer Priority

Since each timer can be set separately, you may wonder what happens if the setting for these timers overlaps. Below is the example of timer priority.

A timer with the earlier start time has priority.

If Recording Timer is set to come on while Daily Timer is operating, Recording Timer will not work.

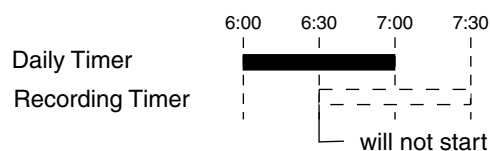

Sleep Timer always has priority.

If Sleep Timer is set to come on while Recording Timer is operating, Recording Timer will be canceled when the shut-off time comes.

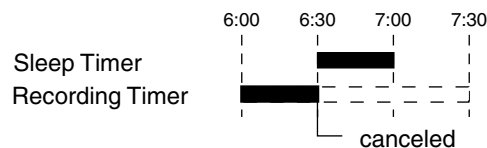

Sleep timer and Auto Standby (see page 10) can be used at the same time.

Maintenance

To get the best performance of the unit, keep your discs, tapes and mechanism clean.

General Notes

In general, you will have the best performance by keeping your discs, tapes and the mechanism clean.

- Store discs and tapes in their cases, and keep them in cabinets or on shelves.
- Keep the unit's disc trays closed when not in use.

Continued use of irregular shape discs (heart-shape, octagonal, etc.) can damage the unit.



Handling discs



- Remove the disc from its case by holding it at the edge while pressing the center hole lightly.
- Do not touch the shiny surface of the disc, or bend the disc.
- Put the disc back in its case after use to prevent warping.

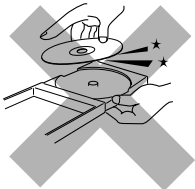

- Be careful not to scratch the surface of the disc when placing it back in its case.
- Avoid exposure to direct sunlight, temperature extremes, and moisture.



To clean the disc

Wipe the disc with a soft cloth in a straight line from center to edge.



DO NOT use any solvent—such as conventional record cleaner, spray, thinner, or benzine—to clean the disc.

Handling MDs

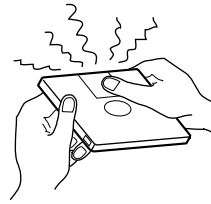

- Do not open the shutter.
 - The shutter is locked so that it will not open. Trying to force it open will break the MD. If the shutter opens accidentally, close it again quickly without touching the MD inside.

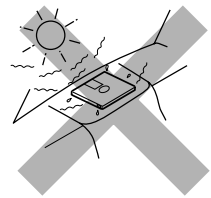

- Do not place MDs in the following places:
 - High temperature areas such as in direct sunlight or inside a car.
 - High humidity areas, e.g. in a bathroom.
 - On a beach or sandy area.

- Clean MDs regularly.
 - If dust or dirt gets on cartridge, wipe it off with a soft dry cloth.

Handling cassette tapes

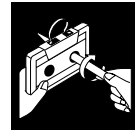

- If the tape is loose in its cassette, take up the slack by inserting a pencil in one of the reels and rotating.
- If the tape is loose, it may get stretched, cut, or caught in the cassette.

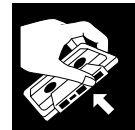

- Be careful not to touch the tape surface.



- Avoid storing tapes in any of the following places:
 - In dusty places
 - In direct sunlight or heat
 - In moist areas
 - On a TV or speaker
 - Near a magnet

Cleaning the unit

- **Stains on the unit**

Should be wiped off with a soft cloth. If the unit is heavily stained, wipe it with a cloth soaked in water-diluted neutral detergent and wrung well, then wipe clean with a dry cloth.
- **Since the unit may deteriorate in quality, become damaged or have its paint peel off, be careful about the following:**
 - DO NOT wipe it with a rough cloth.
 - DO NOT wipe it too vigorously.
 - DO NOT wipe it with thinner or benzine.
 - DO NOT apply any volatile substance such as an insecticide to it.
 - DO NOT allow any rubber or plastic to remain in contact with it for a long time.

MD Disc Types

There are two types of MDs: Premastered (prerecorded) and Recordable (blank).

Premastered MDs

Premastered MDs, which have been recorded at music studio, can be played back like regular CDs. On an MD of this type, data is recorded as the presence or absence of tiny pits. A laser beam focuses on the pits on the surface of the MD and reflects the detection back to the lens in the MD recorder. The MD recorder then decodes the signals and plays them back as music. This type of MD is called an “optical disc.”

Recordable MDs

Recordable MDs, which use magneto-optical technology, can be recorded and played back repeatedly. The laser inside the MD recorder applies heat to the MD, demagnetizing the magnetic layer of the MD for recording and playback. This type of MD is called a “magnetic-optical disc.”

ATRAC (Adaptive TRansform Acoustic Coding)/ATRAC3 (MDLP)

The MD provides 80 minute recording and playback time, much more than an audio CD, but in a diameter of only 64 mm. This ability to store such a large amount of data is the result of ATRAC, an audio compression technique developed for MD. This technology cuts out faint sounds that would not be heard by the human beings. This technology, based on human sensitivity to sounds, reduces recorded data volume up to about one-fifth of the original data volume.

Furthermore, this unit takes advantage of the latest ATRAC3 techniques, which can reduce the amount of data to record to one-tenth or one-twentieth of the original data volume. This allows for 2 times or 4 times long-hour stereo recording on this unit.

UTOC (User Table Of Contents)

Found only on recordable MDs, this area contains sub-data (track number, recording data, etc.) which can be rewritten by the user.

UTOC enables us to search for tracks quickly and edit tracks on the MD.

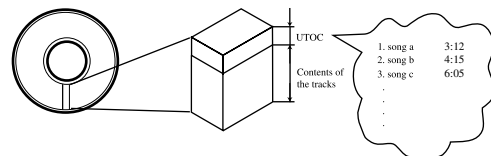

Sound Skip Guard Memory

The biggest weakness of discs is their susceptibility to vibration. The “Sound Skip Guard Memory” has been developed to cope with this weakness.

With this function, a few seconds of signals read by the optical read head from the MD are first stored in memory before being reproduced as audio signals. Thus, even when vibration or shock interrupts signals being read, these stored signals can continue to reproduce sounds for that few seconds. Thus, the user will enjoy uninterrupted music.

Normally...

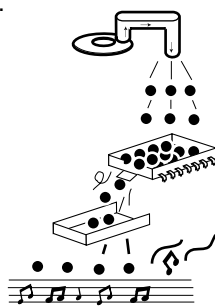

When “vibrated”....

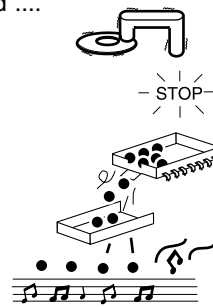

SCMS (Serial Copy Management System)

The MD recorder integrated to this unit uses the Serial Copy Management System which allows only first-generation digital copies to be made of premastered software (like CDs or prerecorded MDs).

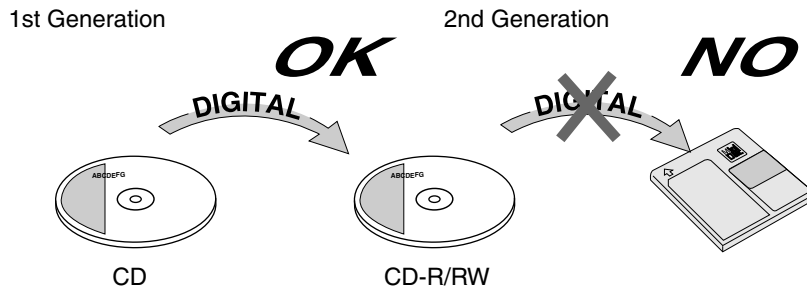

HCMS (High-speed Copy Management System)

Now onto recordable MDs (minidiscs), you can record (copy) sound at a recording speed exceeding the normal speed. This fact requires some restrictions for protecting copyrights.

On this unit, you cannot re-record, at either high speed or normal speed, a song (track) that has been recorded once from a CD at high speed, until 74 minutes elapse after the first recording of the song started.

For example, after having recorded the first song (track) of a CD at high speed, you cannot record it again, at either high speed or normal speed, until 74 minutes elapse after the first recording of that song started.

MD limitations

The MD records data in an original format that differs from that of conventional cassette tapes or DATs. Since there are some limitations with this recording format, the following types of symptoms may occur. These symptoms are not malfunctions.

Symptoms	Cause
“DISC FULL” appears, even though there is still enough remaining time on an MD.	There is a maximum number of tracks which can be recorded, regardless of recording time. More than 254 tracks cannot be recorded on an MD.
“DISC FULL” appears, even though the number of tracks and recording time do not reach the limit.	Repeating erasure and recording on the same MD creates many blank portions sparsely on the MD. When recording on such an MD, a track is recorded on these blank portions sparsely. If a track is divided and recorded into so many portions, “DISC FULL” appears.
<ul style="list-style-type: none"> The JOIN function sometimes does not work. The remaining time on the MD does not increase even when tracks are erased. 	If a divided portion of less than 8 seconds is made while a track is recorded on the MD, that track cannot be joined to another track using the JOIN function. Furthermore, if that track is erased, the remaining time of the MD may not increase exactly by the erased amount.
The sound drops out during fast forward or fast reverse.	If a track has been divided into many portions while being recorded on the MD, sounds will drop out while fast forwarding or reversing such an MD.
The amount of recorded time on the MD added to the amount of remaining time is shorter than the MD’s total possible recording time.	You cannot record on a blank portion of less than 12 seconds (SP mode) on the MD. For this reason, the actual recording time of discs may become shorter.

CD/MD Messages

For CD:

Message	Signification	Solution
CANNOT PLAY	You are trying to play back a unplayable CD or a CD with scratches, etc.	Change the CD.
CD1* NO DISC (* Selected disc number appears.)	<ul style="list-style-type: none"> No disc is on the disc tray. You are trying to play back an unfinalized CD-R/RW. 	<ul style="list-style-type: none"> Place a disc on the disc tray. This is not a malfunction. You can play back “finalized” CD-R/RWs.
CANNOT REC x1 REC ONLY	You are trying to record a CD onto a MD and a tape at the same time using x2 or x4 speed recording.	This is not a malfunction. Select normal recording speed (x1). (See page 30.)

For MD:

Message	Signification	Solution
BLANK DISC	The disc is blank.	Change the MD if you want to enjoy playback.
CANNOT ENTRY!	The track has already been in the selected group.	This is not a malfunction. (See “Adding a Track to a Group—ENTRY GR” on page 40.)
CANNOT FORM!	You are trying to form a new group including other groups.	This is not a malfunction. (See “Forming a Group—FORM GR” on page 39.)
CANNOT GROUP!	There is no more space for storing information concerning MD group.	You cannot form a group any more on the MD.
CANNOT JOIN	You are trying to join tracks (shorter than 8 seconds) or groups which cannot be joined.	This is not a malfunction. (See pages 42 and 48.)
CANNOT LISTEN	You are trying to listen to the sound during high-speed recording.	This is not a malfunction. You cannot listen to the sound during high-speed recording.
CANNOT REC x1 or x2 ONLY	You are trying to record a CD in Program Play or Random Play using x4 speed recording.	This is not a malfunction. Select other recording speeds. (See page 30.)
CANNOT TITLE	You are trying to enter the title on the MD which already has over 1792 characters in total.	This is not a malfunction. (See “Assigning Titles to an MD” on page 51.)
DISC FULL	There is no more space on the MD or there are over 254 tracks.	Use another recordable MD or erase some tracks.
DISC PROTECTED	MD is write-protected.	Unprotect the MD or use another. (See page 28.)
EMERGENCY STOP	A malfunction has occurred during recording.	Stop playback, and eject the MD and re-insert it.
GROUP FULL	You are trying to form over 99 groups.	This is not a malfunction. There can be up to 99 groups on an MD.
GROUP TRACK	You are trying to make a group by including a track which belongs to another group.	This is not a malfunction. (See “Forming a Group—FORM GR” on page 39.)
HCMS CANNOT COPY	You are trying to re-record a song that has been recorded once at high speed, before 74 minutes have passed after its first recording.	An internal timer works to protect copyrights. Wait for 74 minutes or more, then start recording.
LOAD ERROR	MD is not loaded correctly.	Eject the MD and re-insert it.
LOW TEMP CANNOT COPY	The room temperature is too low to record using x4 speed recording.	This is not a malfunction. You can record using x4 speed recording within 5°C–35°C.

Message	Signification	Solution
MD NO DISC	There is no MD.	Put an MD.
NON AUDIO (or DVD) CAN NOT COPY	You are trying to copy a non-audio disc like a CD-ROM, Video CD, or DVD.	Stop recording.
PLAY BACK DISC	You are trying to edit or record on a playback-only MD.	Use a recordable MD.
READ ERROR	The UTOC fails to be read.	Turn off the unit, then turn on it again.
SCMS CANNOT COPY	Digital copy of the 2nd generation is prohibited.	You cannot make a digital recording from a duplicated CD-R/RW onto an MD. If you try to do so, the unit will automatically convert the digital signals to analog signals and record them at x1 speed (normal speed).

Troubleshooting

If you are having a problem with your unit, check this list for a possible solution before calling for service.

If you cannot solve the problem from the hints given here, or the unit has been physically damaged, call a qualified person, such as your dealer, for service.

Symptom	Possible Cause	Action
Power does not come on.	The power cord is not connected to an AC outlet.	Insert the plug into the socket.
Operations are disabled.	The built-in microprocessor has malfunctioned due to external electrical interference.	Unplug the AC power cord then plug it back in.
No sound is heard.	<ul style="list-style-type: none"> • Connections are incorrect or loose. • A pair of headphones is connected. 	<ul style="list-style-type: none"> • Check all connections and make corrections. (See pages 6 to 8.) • Unplug the headphones from the PHONES jack.
Unable to operate the unit by the remote control.	<ul style="list-style-type: none"> • The path between the remote control and the remote sensor on the unit is blocked. • The batteries are exhausted. • You are using the remote control too far from the unit. 	<ul style="list-style-type: none"> • Remove the obstruction. • Replace the batteries. (See page 8.) • Signals cannot reach the remote sensor. Move closer to the unit.
Hard to listen to broadcasts because of noise.	<ul style="list-style-type: none"> • Antennas are disconnected. • The AM loop antenna is too close to the unit. • The FM antenna is not properly extended and positioned. 	<ul style="list-style-type: none"> • Reconnect the antenna correctly and securely. • Change the position and direction of the AM loop antenna. • Extend FM antenna and orient to the best reception position.
Loaded discs, MD, and cassette cannot be ejected.	<ul style="list-style-type: none"> • The AC power cord is not plugged in. • The Disc Lock function is in use. 	<ul style="list-style-type: none"> • Plug in the AC power cord. • Cancel the Disc Lock function. (See page 19.)
The disc does not play.	The disc is upside down.	Put the disc in with the label side up.
The CD skips.	The CD is dirty or scratched.	Clean or replace the CD. (See page 59.)
Unable to record on an MD.	<ul style="list-style-type: none"> • You are using a protected MD. • The MD is write protected. 	<ul style="list-style-type: none"> • Change it with a recordable MD. • Unprotect the MD. (See page 28.)
Impossible to record on a tape.	Small tabs on the back of the cassette are removed.	Cover the holes with adhesive tape.

Specifications

CA-UXJ55MD

Amplifier

Output Power (IEC 268-3):

40 W (20 W + 20 W) at 4 Ω (MAX.)

30 W (15 W + 15 W) at 4 Ω (10 % THD)

Audio input sensitivity/Impedance (at 1 kHz)

Analog input:

AUX/DVD: 400 mV/47 kΩ
(at "Input LEVEL 1")

200 mV/47 kΩ
(at "Input LEVEL 2")

Speakers/Impedance: 4 Ω – 16 Ω

Tuner

FM tuning range: 87.50 MHz—108.00 MHz

AM tuning range: 531 kHz—1 710 kHz (at 9 kHz
channel spacing)
530 kHz—1 710 kHz (at 10 kHz
channel spacing)

CD player

CD Capacity: 5 CDs

Dynamic range: 87 dB

Signal-to-noise ratio: 90 dB

Wow and flutter: Immeasurable

MD recorder

Audio playing system: MiniDisc digital audio system

Recording system: Magneto-optical overwrite
system

Reading system: Non-contact, semiconductor laser
pickup ($\lambda=780$ nm)

Error correction system: CIRC (Cross Interleave Reed-
Solomon Code)

Recording/Playback time (when using a 80-minute MD)

SP: 80 minutes

LP2: 160 minutes

LP4: 320 minutes

Sampling frequency: 44.1 kHz

Audio compression system: ATRAC (Adaptive TRansform
Acoustic Coding)/ATRAC3
(MDLP)

Cassette deck

Frequency response:

Normal (type I): 60 Hz—14 000 Hz

Wow and flutter: 0.15 % (WRMS)

General

Power requirement: AC 230 V \sim , 50 Hz

Power consumption: At operation: 50 W

On standby: 11.8 W
0.9 W (in Power Save)

Dimensions (approx.):

175 mm x 239.5 mm x 378 mm (W/H/D)

Mass (approx.): 7.8 kg

Supplied accessories

See page 6.

Design and specifications are subject to change without notice.



JVC
VICTOR COMPANY OF JAPAN, LIMITED

Free Manuals Download Website

<http://myh66.com>

<http://usermanuals.us>

<http://www.somanuals.com>

<http://www.4manuals.cc>

<http://www.manual-lib.com>

<http://www.404manual.com>

<http://www.luxmanual.com>

<http://aubethermostatmanual.com>

Golf course search by state

<http://golfingnear.com>

Email search by domain

<http://emailbydomain.com>

Auto manuals search

<http://auto.somanuals.com>

TV manuals search

<http://tv.somanuals.com>