

JVC



MICRO COMPONENT SYSTEM

微型组合音响

ระบบไมโครคอมโพเนนท์

UX-P38V

Consists of CA-UXP38V and SP-UXP38V

由CA-UXP38V及SP-UXP38V组成

ประกอบด้วย CA - UXP38V และ SP-UXP38V

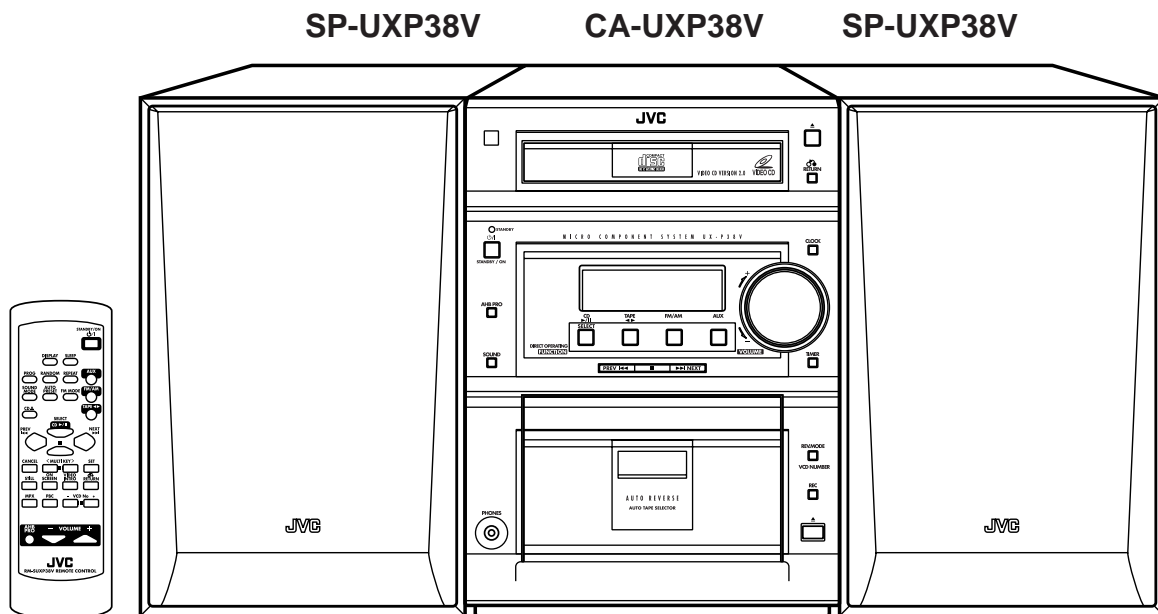

INSTRUCTIONS

使用说明书

คำแนะนำ

For Customer Use:

Enter below the Model No. and Serial No. which are located either on the rear, bottom or side of the cabinet. Retain this information for future reference.

Model No. _____

Serial No. _____

GVT0068-003A
[US, UN, UB]

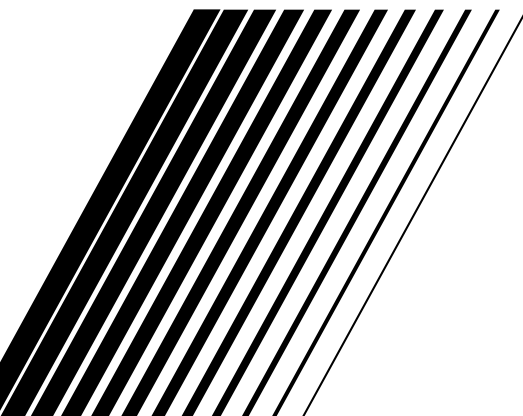

Warnings, Cautions and Others

警告，注意及其他须知事项

คำเตือน ข้อควรระวัง และอื่นๆ

Caution — ๐/I STANDBY/ON button!

Disconnect the mains plug to shut the power off completely. The ๐/I STANDBY/ON button in any position does not disconnect the mains line. The power can be remote controlled.

注意 — ๐/I STANDBY/ON 开关！

无论 ๐/I STANDBY/ON 开关在任何位置，电源线的电源还是没有被切断，若要将电源完全关闭，应把电源插头拔离插座，电源开关可用遥控器控制。

ข้อควรระวัง — ๐/I STANDBY/ON ปุ่มพร้อมทำงาน/เปิด!

ดึงปลั๊กหลักออกเพื่อปิดเครื่องอย่างถูกต้อง ๐/I STANDBY/ON ปุ่มพร้อมทำงาน/เปิดในตำแหน่งใดๆ ก็ตามจะไม่สามารถตัดการเชื่อมต่อสายไฟหลักได้ ท่านสามารถเปิดปิดโดยใช้รีโมตคอนโทรล

CAUTION

To reduce the risk of electrical shocks, fire, etc.:

1. Do not remove screws, covers or cabinet.
2. Do not expose this appliance to rain or moisture.

警告

为了减低触电，火灾等危险：

1. 请勿擅自卸下螺丝钉，盖子或机壳。
2. 切勿让本机受雨淋或置潮湿环境中。

ข้อควรระวัง

เพื่อเลี่ยงการถูกไฟฟ้าดูด ไฟไหม้ ฯลฯ:

1. ห้ามถอดน็อต ฝา หรือโครงเครื่องออกมา
2. อย่าให้อุปกรณ์นี้ถูกฝนหรือความชื้น

CAUTION

- Do not block the ventilation openings or holes. (If the ventilation openings or holes are blocked by a newspaper or cloth, etc., the heat may not be able to get out.)
- Do not place any naked flame sources, such as lighted candles, on the apparatus.
- When discarding batteries, environmental problems must be considered and local rules or laws governing the disposal of these batteries must be followed strictly.
- Do not use this apparatus in a bathroom or places with water. Also do not place any containers filled with water or liquids (such as cosmetics or medicines, flower vases, potted plants, cups, etc.) on top of this apparatus.

注意

- 请勿堵塞通风口或通风孔。（如果通风口或通风孔被报纸或布等堵塞，热量将无法散出。）
- 请勿在本设备上放置任何裸露的火源，如点燃的蜡烛。
- 处理废弃电池时，必须考虑环境问题，并严格遵守当地关于处理废弃电池的有关法律或规定。
- 请勿在浴室里或有水汽的地方使用本设备。亦请勿在本设备的上方放置任何装有水或液体的容器（如化妆品，药品，花瓶，花盆，杯子等）。

ข้อควรระวัง

- อย่าให้มีสิ่งกีดขวางช่องเปิดหรือรูระบายอากาศ (หากช่องเปิดหรือรูระบายอากาศมีกระดาษหนังสือพิมพ์หรือผ้า ฯลฯ วางทับอยู่ ความร้อนอาจไม่สามารถระบายออกไปได้)
- ห้ามวางไฟซึ่งไม่มีที่กำบังไว้บนอุปกรณ์ เช่นเทียนที่จุดแล้ว
- ในการกำจัดแบตเตอรี่ที่ไม่ใช้แล้วจะต้องคำนึงถึงปัญหาด้านสิ่งแวดล้อม และต้องทำตามระเบียบหรือกฎหมายเกี่ยวกับการกำจัดแบตเตอรี่ในประเทศของท่านอย่างเคร่งครัด
- ห้ามใช้อุปกรณ์นี้ในห้องน้ำหรือในที่เปียกน้ำ รวมทั้งห้ามวางภาชนะที่มีน้ำหรือของเหลวบรรจุอยู่ (เช่น เครื่องสำอาง แจกันดอกไม้ กระถางต้นไม้ ถ้วย ฯลฯ) ไว้บนอุปกรณ์

IMPORTANT FOR LASER PRODUCTS

雷射产品的重要说明

มีความสำคัญสำหรับผลิตภัณฑ์เลเซอร์

REPRODUCTION OF LABELS / 标签内容说明 / การทำสำเนาแผ่นฉลาก

- ① CLASSIFICATION LABEL, PLACED ON REAR ENCLOSURE
- ② WARNING LABEL, PLACED INSIDE THE UNIT
- ① 分类标签，贴在机壳背后
- ② 警告标签，贴于机内
- ① ป้ายแบ่งประเภทผลิตภัณฑ์ด้านหลัง
- ② ป้ายเตือนติดไว้ภายในอุปกรณ์



CAUTION: Invisible laser radiation when open and interlock failed or defeated. AVOID DIRECT EXPOSURE TO BEAM. (e)

ADVARSEL: Usynlig laserstråling ved åbning, når sikkerhedsafbrydere er ude af funktion. Undgå udsættelse for stråling (d)

WARNING: Osynlig laserstråling när denna del är öppenad och spärren är urkopplad. Beträkta ej strålen. (s)

VARO: Avattaessa ja suo-jälukitus ohitettaessa olet alltiina näkymättömälle lasersäteilylle. Älä katso säteeseen. (f)

1. CLASS 1 LASER PRODUCT
 2. **CAUTION:** Invisible laser radiation when open and interlock failed or defeated. Avoid direct exposure to beam.
 3. **CAUTION:** Do not open the top cover. There are no user serviceable parts inside the Unit; leave all servicing to qualified service personnel.
1. 一级雷射产品
2. **危险：**当内部锁定装置失效或者损坏后，打开盖板可能会产生不见的雷射辐射。应避免受到光束直接照射。
3. **注意：**请勿打开顶盖板，本机内部没有用户可自行维修的部件；所有维修工作应由有资格的人员完成。

1. ผลิตภัณฑ์เลเซอร์ประเภท 1
2. ข้อควรระวัง: เมื่อเปิดเครื่องและอุปกรณ์อินเตอร์ล็อกไม่ทำงานหรือล้มเหลว ต้องระวังรังสีเลเซอร์ซึ่งมองไม่เห็น และควรหลีกเลี่ยงการถูกลำแสงตรงๆ
3. ข้อควรระวัง: ห้ามเปิดฝาด้านบน ภายในอุปกรณ์นี้ไม่มีชิ้นส่วนใดที่ผู้ใช้สามารถซ่อมแซมได้ด้วยตัวเอง ควรให้เจ้าหน้าที่ผู้เชี่ยวชาญเป็นผู้ซ่อมแซมเท่านั้น

Caution: Proper Ventilation

To avoid risk of electric shock and fire, and to prevent damage, locate the apparatus as follows:

1 Front:

No obstructions and open spacing.

2 Sides/ Top/ Back:

No obstructions should be placed in the areas shown by the dimensions below.

3 Bottom:

Place on the level surface. Maintain an adequate air path for ventilation by placing on a stand with a height of 10 cm or more.

注意：正确通风

为免发生触电和火警的危险，及防止本机受损，请将本机如下放置：

1. 前面：没有障碍物及地方开阔。
2. 侧面 / 顶面 / 背面：在图中所示范围中，不应放置任何障碍物。
3. 底部：放置在水平面上。放置在一个高 10 厘米或以上的台上，以保持足够的通风道。

ข้อควรระวัง: การระบายอากาศที่เหมาะสม

เพื่อป้องกันการถูกไฟฟ้ดูดและไฟไหม้ รวมทั้งเพื่อป้องกันความเสียหายที่อาจเกิดขึ้นได้ ควรติดตั้งอุปกรณ์ตามคำแนะนำต่อไปนี้:

1. ด้านหน้า: มีที่ว่างมากเพียงพอและไม่มีสิ่งกีดขวาง
2. ด้านข้าง/ด้านบน/ด้านหลัง: ไม่ให้มีสิ่งกีดขวางในระยะที่แสดงไว้ด้านล่างนี้
3. ด้านล่าง: วางบนพื้นผิวที่เรียบเสมอกัน และให้มีที่ว่างสำหรับการระบายอากาศโดยวางบนชั้นที่สูงจากพื้น 10 ซม. หรือมากกว่า

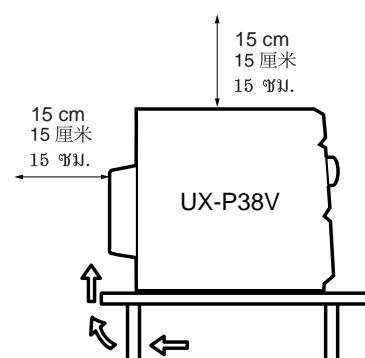
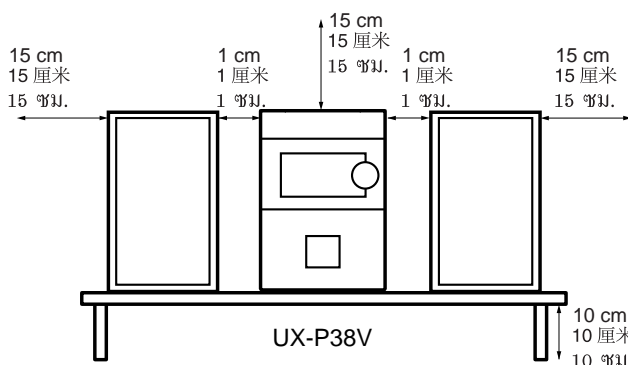

Introduction

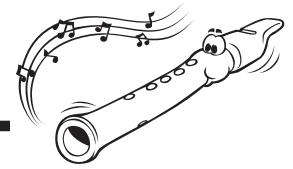

We would like to thank you for purchasing one of our JVC products. Before operating this unit, read this manual carefully and thoroughly to obtain the best possible performance from your unit, and retain this manual for future reference.

About This Manual

This manual is organized as follows:

- **The manual mainly explains operations using the buttons on the remote control. You can use the buttons both on the remote control and on the unit for the same operations if they have the same or similar names (or marks), unless mentioned otherwise.**
- Basic and common information that is the same for many functions is grouped in one place, and is not repeated in each procedure. For instance, we do not repeat the information about turning on/off the unit, setting the volume, changing the sound effects, and others, which are explained in the section "Common Operations" on pages 9 to 10.
- The following marks are used in this manual:



Gives you warnings and cautions to prevent from damage or risk of fire/electric shock. Also gives you information which is not good for obtaining the best possible performance from the unit.



Gives you information and hints you had better know.

Precautions

Installation

- Install in a place which is level, dry and neither too hot nor too cold — between 5°C (41°F) and 35°C (95°F).
- Install the unit in a location with adequate ventilation to prevent internal heat built-up in the unit.
- Leave sufficient distance between the unit and the TV.
- Keep the speakers away from the TV to avoid interference with TV.



DO NOT install the unit in a location near heat sources, or in a place subject to direct sunlight, excessive dust or vibration.

Power sources

- When unplugging from the wall outlet, always pull the plug, not the AC power cord.



DO NOT handle the AC power cord with wet hands.

Moisture condensation

Moisture may condense on the lens inside the unit in the following cases:

- After starting heating in the room
- In a damp room
- If the unit is brought directly from a cold to a warm place

Should this occur, the unit may malfunction. In this case, leave the unit turned on for a few hours until the moisture evaporates, unplug the AC power cord, and then plug it in again.

Others

- Should any metallic object or liquid fall into the unit, unplug the unit and consult your dealer before operating any further.
- If you are not going to operate the unit for an extended period of time, unplug the AC power cord from the wall outlet.



DO NOT disassemble the unit since there are no user serviceable parts inside.

If anything goes wrong, unplug the AC power cord and consult your dealer.

Which compact discs can be used?

Many types of compact discs are sold for a variety of uses. The player can play the following compact discs:

Video CD discs both with and without PBC.



Audio CD discs



Discs you cannot playback

Any other discs than listed above (such as CD-ROM, DVD, CD-G or CD-I Discs) cannot be played. Playing back such discs may generate noise and damage your speakers.

Even though a logo listed above is printed on the disc, it may not be played if it is a non-standard disc.

Contents

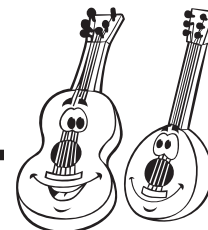

Location of the Buttons and Controls	3	Using the Video CD Player	
Front Panel	3	(Video CDs)	15
Remote Control	5	Setting the TV System	15
Getting Started	6	Playing Video CDs with the PBC Function	15
Supplied Accessories	6	Playing Video CDs with the PBC Function without	
Putting the Batteries into the Remote Control	6	Using the Menu Screen (Continuous Play)	15
Connecting Antennas	6	Playing Video CDs with the PBC Function	
Connecting Speakers	7	Using the Menu Screen (Menu-Driven Play)	16
Connecting Other Equipment	7	Playing Video CDs without the PBC Function	17
Adjusting the Voltage Selector	8	Various Functions to Enhance Your Enjoyment	17
Common Operations	9	Playing Back Tapes	19
Turning On the Power	9	Playing Back a Tape	19
Setting the Clock	9	Recording	20
Setting the AM Tuner Interval Spacing	9	Recording on a Tape	20
Selecting the Sources and Starting Play	10	CD Direct Recording	21
Adjusting the Volume	10	One Track Recording	21
Reinforcing the Bass Sound	10	Using the Multiplex CDs	22
Selecting the Sound Modes	10	Using the Timers	23
Listening to FM and AM Broadcasts	11	Using Daily Timer and Recording Timer	23
Tuning in a Station	11	Using Sleep Timer	24
Presetting Stations	11	Maintenance	25
Tuning in a Preset Station	11	Troubleshooting	26
Playing Back CDs (CD/CD-R/CD-RW)	12	Specifications	26
Playing Back the Entire CD — Normal Play	12		
Basic CD Operations	12		
Programming the Playing Order of the Tracks			
— Program Play	13		
Playing at Random — Random Play	13		
Repeating Tracks — Repeat Play	14		
Prohibiting Disc Ejection — Tray Lock	14		

Location of the Buttons and Controls



Become familiar with the buttons and controls on your unit.

Front Panel

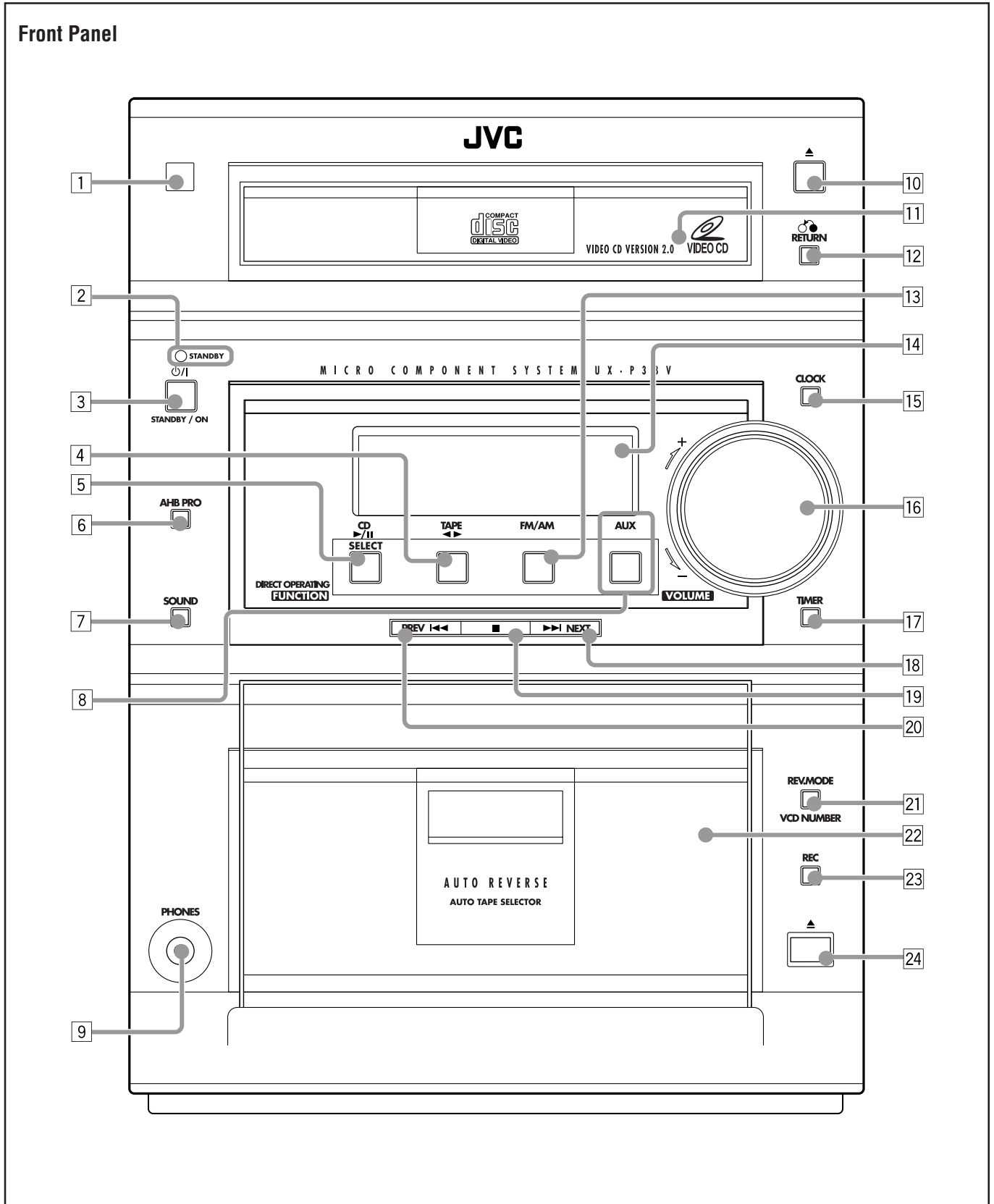

Display Window

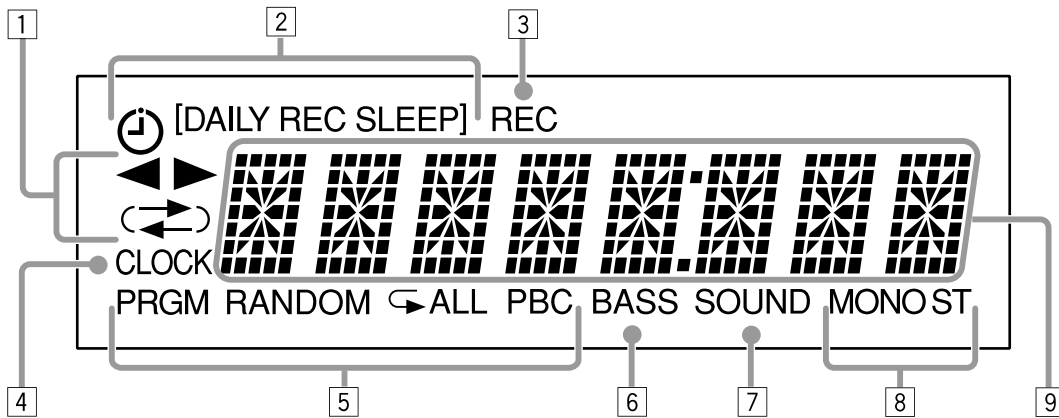

See pages in the parentheses for details.

Front Panel

- 1 Remote sensor
- 2 STANDBY lamp (9)
- 3 \odot/I STANDBY/ON button (9, 14, 24)
- 4 TAPE $\blacktriangleleft\blacktriangleright$ button (19 – 20)
Pressing this button also turns on the unit.
- 5 CD $\blacktriangleright/\text{II}$ SELECT (play/pause) button (9, 15 – 16, 18)
Pressing this button also turns on the unit.
- 6 AHB (Active Hyper Bass) PRO button (10)
- 7 SOUND button (10)
- 8 AUX button (9 – 10)
Pressing this button also turns on the unit.
- 9 PHONES jack (10)
- 10 \blacktriangle (disc tray open/close) button (12)
Pressing this button also turns on the unit.
- 11 Disc tray
- 12 \odot RETURN button (17)
- 13 FM/AM button (9, 11)
Pressing this button also turns on the unit.
- 14 Display window
- 15 CLOCK button (9)
- 16 VOLUME + / - control (10)
- 17 TIMER button (23 – 24)
- 18 $\blacktriangleright\blacktriangleright/\text{I}$ NEXT (forward search) button (9, 15 – 18)
- 19 \blacksquare (stop) button (12, 14 – 15, 19 – 21)
- 20 PREV $\blacktriangleleft\blacktriangleleft$ (reverse search) button (9, 15 – 18)
- 21 REV.MODE (reverse mode) VCD NUMBER button (16, 20 – 21)
- 22 Cassette holder
- 23 REC button (20 – 21)
- 24 \blacktriangle (eject) button for cassette deck (19 – 21)

Display Window

- 1 Tape operation indicators
 - $\blacktriangleleft\blacktriangleright$ (tape direction) and $\blacktriangleleft\blacktriangleright$ (reverse mode) indicators
- 2 Timer indicators
 - \odot (timer), DAILY, REC and SLEEP indicators
- 3 REC indicator
- 4 CLOCK indicator
- 5 CD play mode indicators
 - PRGM (program), RANDOM, repeat ($\blacktriangleleft/\blacktriangleright$ ALL) and PBC indicators
- 6 BASS (Active Hyper Bass) indicator
- 7 SOUND (sound mode) indicator
- 8 Tuner operation indicators
 - MONO and ST (stereo) indicators
- 9 Main display
 - Shows the source name, frequency, etc.

Remote Control

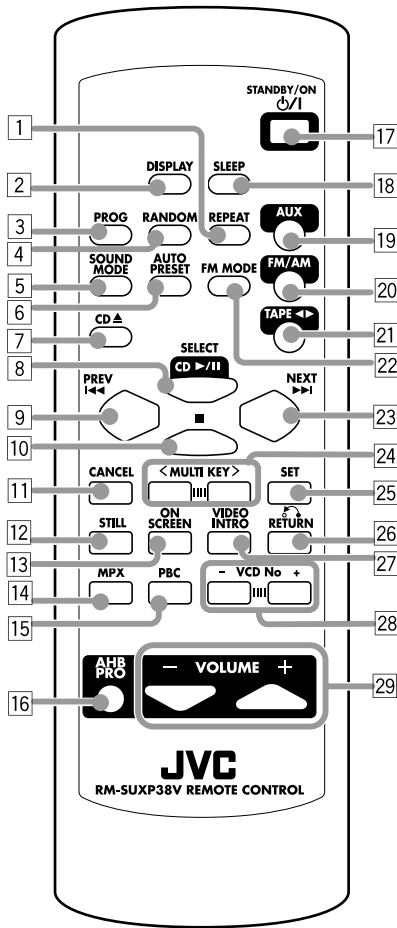

Remote Control

- 1 REPEAT button (14 - 15)
- 2 DISPLAY button (9)
- 3 PROG (program) button (13)
- 4 RANDOM button (13 - 15)
- 5 SOUND MODE button (10)
- 6 AUTO PRESET button (11)
- 7 CD ▲ (disc tray open/close) button (12)
Pressing this button also turns on the unit.
- 8 SELECT CD ►/|| button (12 - 13, 15 - 18)
Pressing this button also turns on the unit.
- 9 PREV ◀◀ (reverse search) button (11 - 13, 16)
- 10 ■ (stop) button (12 - 14, 16)
- 11 CANCEL button (13)
- 12 STILL button (17)
- 13 ON SCREEN button (18)
- 14 MPX button (22)
- 15 PBC button (15 - 16)
- 16 AHB (Active Hyper Bass) PRO button (10)
- 17 STANDBY/ON ⏻/⏻ button (9)
- 18 SLEEP button (24)
- 19 AUX button (10)
Pressing this button also turns on the unit.
- 20 FM/AM button (11)
Pressing this button also turns on the unit.
- 21 TAPE ◀▶ button (19)
Pressing this button also turns on the unit.
- 22 FM MODE button (11)
- 23 NEXT ▶▶ (forward search) button (11 - 13, 16)
- 24 MULTI KEY >/< button (11 - 13)
- 25 SET button (11)
- 26 ⏪ RETURN button (16 - 17)
- 27 VIDEO INTRO button (18)
- 28 VCD No + / - button (16, 18)
- 29 VOLUME + / - buttons (10)

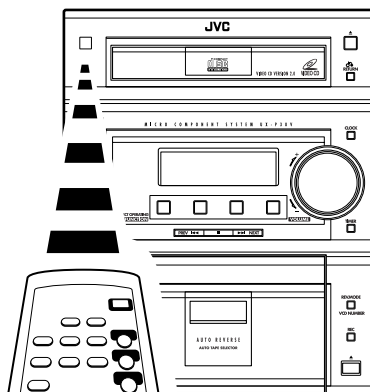

When using the remote control, point it at the remote sensor on the front panel.

Getting Started



Supplied Accessories

Make sure that you have all the following items. The number in the parentheses indicates the quantity of the pieces supplied.

- AM loop antenna (1)
- FM antenna (1)
- Remote control (1)
- Batteries (2)
- AC plug adaptor (1)
- Video cord (1)

If anything is missing, consult your dealer immediately.

Putting the Batteries into the Remote Control

Insert the batteries — R6(SUM-3)/AA(15F) — into the remote control, by matching the polarity (+ and -) on the batteries with the + and - markings on the battery compartment. When the remote control can no longer operate the unit, replace both batteries at the same time.

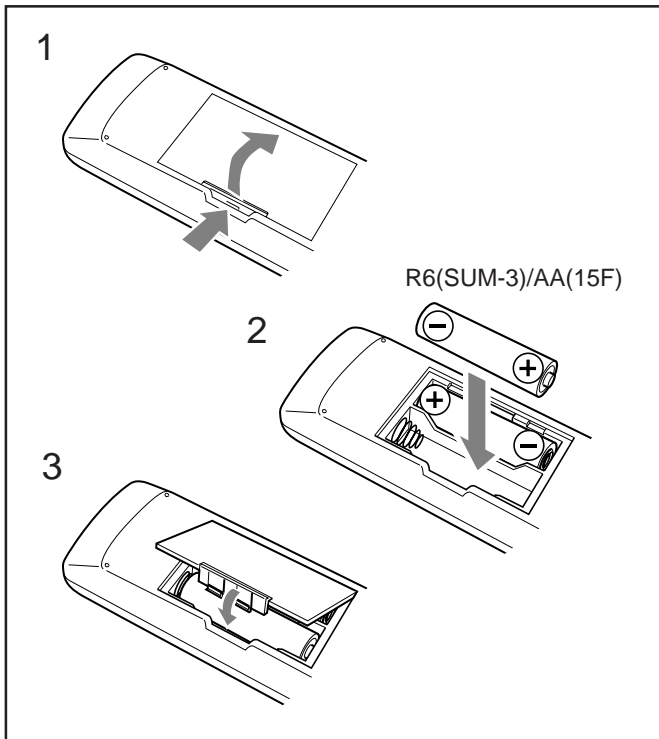

- DO NOT use an old battery together with a new one.
- DO NOT use different types of batteries together.
- DO NOT expose batteries to heat or flame.
- DO NOT leave the batteries in the battery compartment when you are not going to use the remote control for an extended period of time. Otherwise, it will be damaged from battery leakage.

Connecting Antennas

FM antenna

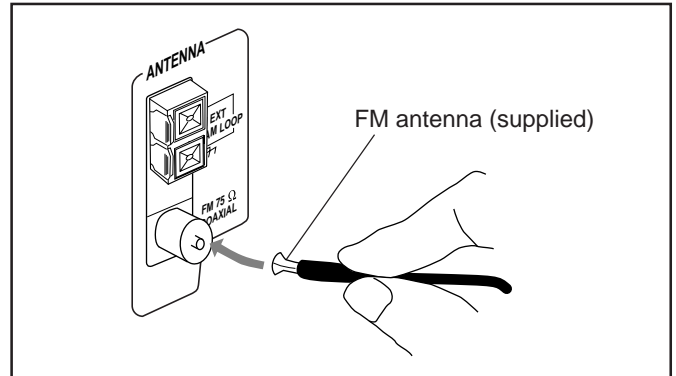

- 1 Attach the FM antenna to the FM 75 Ω COAXIAL terminal.
- 2 Extend the FM antenna.
- 3 Fasten it up in the position which gives you the best reception, then fix it on the wall, etc.



About the supplied FM antenna

The FM antenna supplied with this unit can be used as temporary measure. If reception is poor, you can connect an outdoor FM antenna.

To connect an outdoor FM antenna

Before connecting it, disconnect the supplied FM antenna.

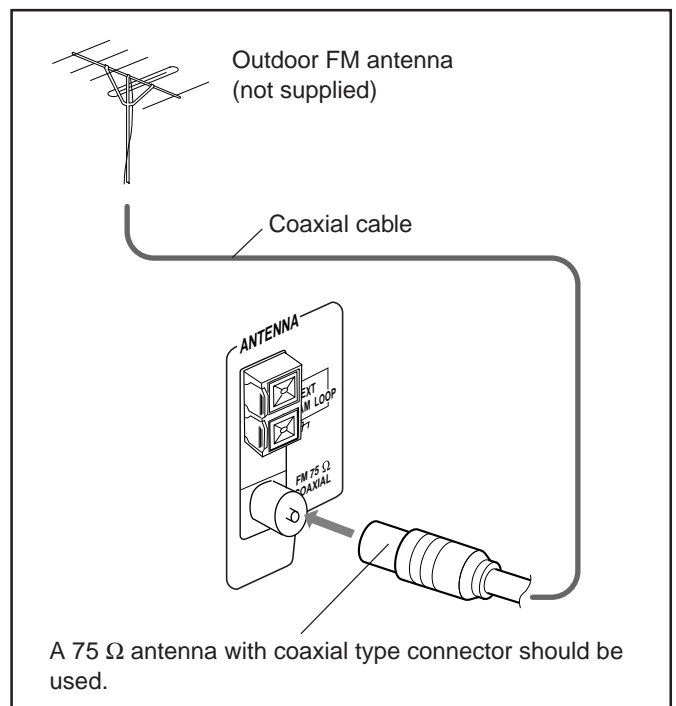

AM antenna

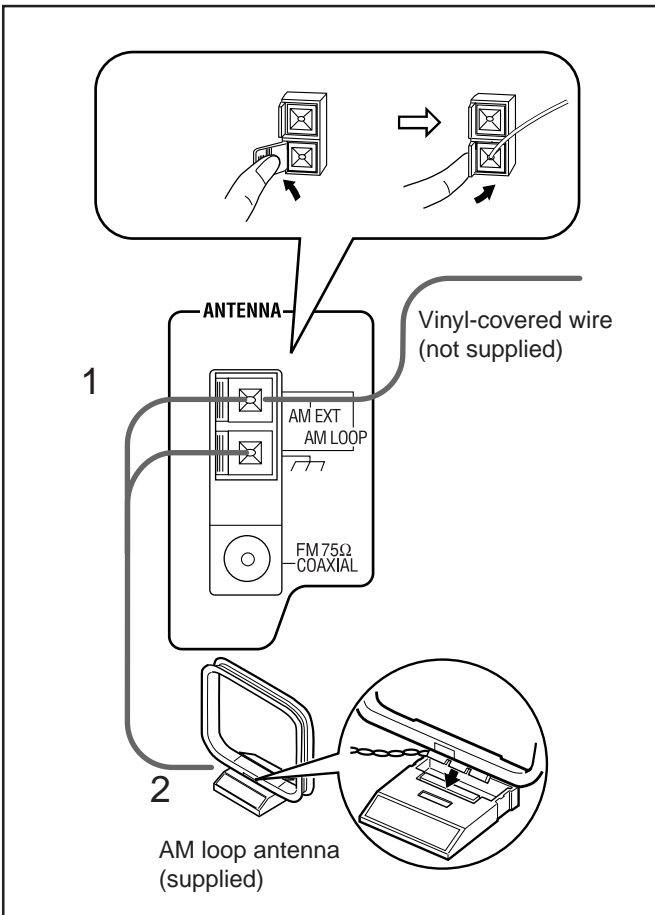

1 Connect the AM loop antenna to the AM LOOP terminals as illustrated.

- If the AM loop antenna wire is covered with vinyl, remove the vinyl by twisting it as shown in the diagram.

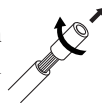

2 Turn the AM loop antenna until you have the best reception.

To connect an outdoor AM antenna

When reception is poor, connect a single vinyl-covered wire to the AM EXT terminal and extend it horizontally. (The AM loop antenna must remain connected.)



For better reception of both FM and AM

- Make sure the antenna conductors do not touch any other terminals and connecting cords.
- Keep the antennas away from metallic parts of the unit, connecting cords, and the AC power cord.

Connecting Speakers

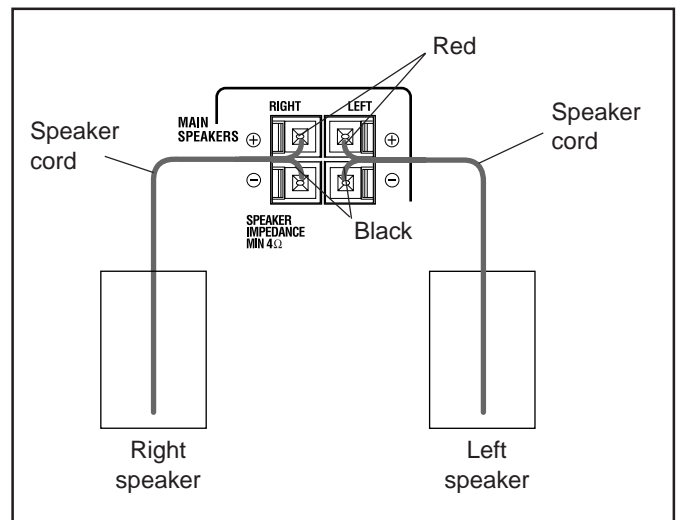

1 Press and hold the clamp of the speaker terminal on the rear of the unit.

2 Insert the end of the speaker cord into the terminal.

Match the polarity of the speaker terminals: Red (+) to red (+) and black (-) to black (-).

3 Release the finger from the clamp.

IMPORTANT: Use only speakers with the same speaker impedance as indicated by the speaker terminals on the rear of the unit.

Connecting Other Equipment

You can connect audio equipment — used only as a playback device.



- DO NOT connect any equipment while the power is on.
- DO NOT plug in any equipment until all connections are complete.

To connect audio equipment

Be sure that the plugs of the audio cords are colored: White plugs and jacks are for left audio signals, and red ones for right audio signals.

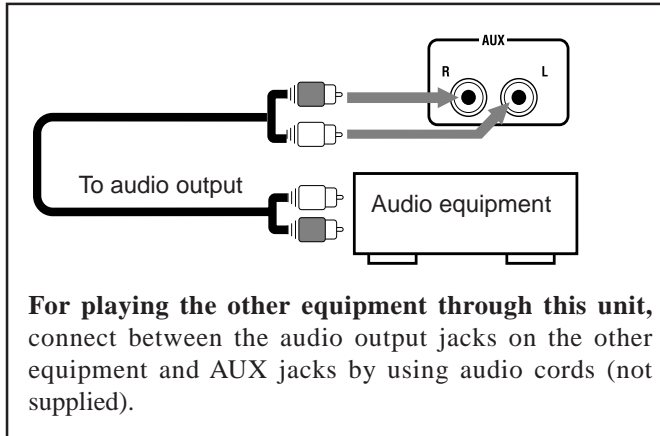

To connect audio equipment with an optical digital input terminal (For Hong Kong only)

You can record CD sound onto the connected digital equipment.

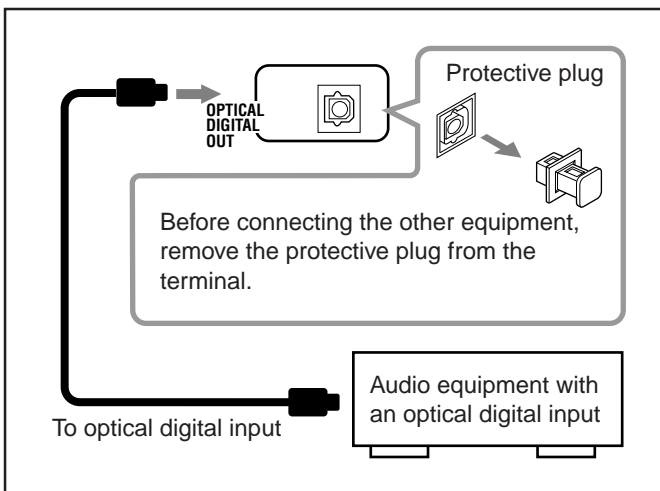

Connect an optical digital cord (not supplied) between the optical digital input terminal on the other equipment and the OPTICAL DIGITAL OUT terminal.

To connect a TV set

You can connect a TV with a video input jack: used as a monitor for video CD playback.

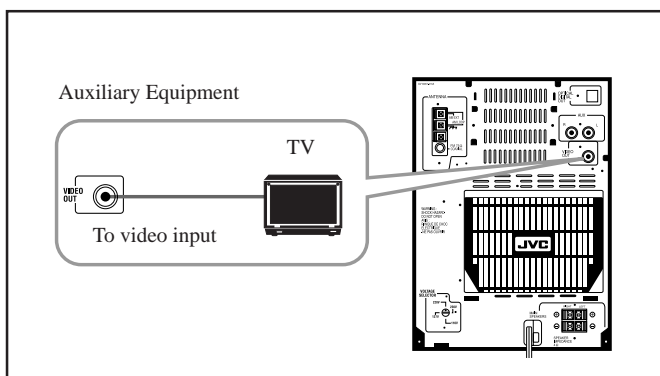

Adjusting the Voltage Selector

Before plugging in the unit, set the correct voltage for your area with the voltage selector on the rear of the unit.

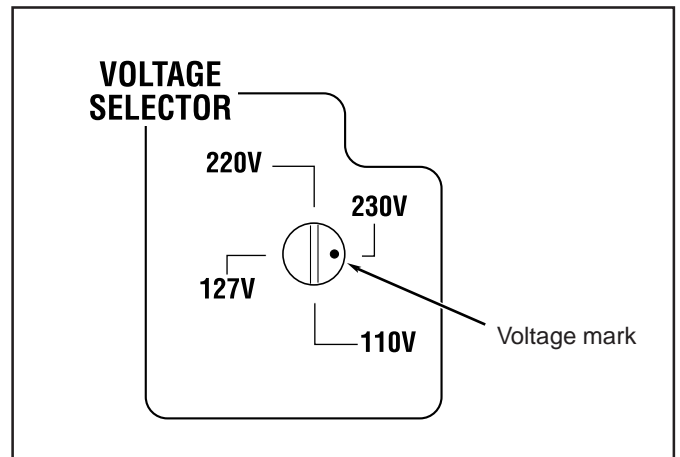

Use a screwdriver to rotate the voltage selector so the voltage number the voltage mark is pointing at is the same as the voltage where you are plugging in the unit. (See the back cover page.)



DO NOT plug in before setting the voltage selector on the rear of the unit and all connection procedures are complete.

Now, you can plug the AC power cord.

IMPORTANT: Be sure to check all connections to be done before plugging the AC power cord into a wall outlet.

Common Operations

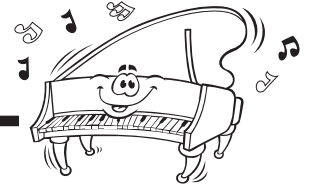

Turning On the Power

When you press the play button — CD ►/|| SELECT, TAPE ◀▶, or the source selecting button — FM/AM and AUX, the unit automatically turns on and starts playback if the source is ready.

To turn on the unit, press STANDBY/ON. The STANDBY lamp on the unit lights green.

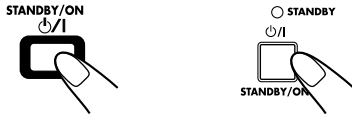

To turn off the unit (on standby), press STANDBY/ON again.

The STANDBY lamp lights red.

- The CLOCK indicator flashes on the display until you set the built-in clock. After setting the clock, the clock time will appear on the display while the power is off.
- A little power is always consumed even while the unit is on standby.

To switch off the power supply completely, unplug the AC power cord from the AC outlet.



When you unplug the AC power cord or if a power failure occurs

The clock is reset to “0:00” right away, while the tuner preset stations (see page 11) will be erased in a few days.

Setting the Clock

Before operating the unit any further, first set the clock built in this unit. When you plug the AC power cord into the wall outlet, the CLOCK indicator starts flashing on the display. You can set the clock whether the unit is on or off.

- There is a time limit in doing the following steps. If the setting is canceled before you finish, start from step 1 again.

On the unit ONLY:

1 Press CLOCK for more than 2 seconds.

The hour digits start flashing on the display.



2 Press ►►| NEXT or PREV ◀◀ to adjust the hour, then press CLOCK.

The minute digits start flashing on the display.



3 Press ►►| NEXT or PREV ◀◀ to adjust the minute, then press CLOCK.

The CLOCK indicator remains lit on the display.



To check the clock time

Press DISPLAY on the remote control (or CLOCK on the unit) while playing any source.

- Each time you press the button, the source indication and the clock time alternate on the display.

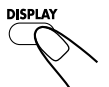

- When you unplug the AC power cord or if a power failure occurs, the clock loses the setting and is reset to “0:00.” You need to set the clock again.
- The clock may gain or lose 1 to 2 minutes per month.

Setting the AM Tuner Interval Spacing

When shipped, the AM tuner interval is set to 10 kHz or 9 kHz spacing. You can change it to 10 kHz or 9 kHz spacing.

On the unit ONLY:

To select 10 kHz intervals, while holding down ►►| NEXT in standby mode, press STANDBY/ON to turn on the power (at the same time, the 10 kHz spacing is selected for AM broadcast.)

To select 9 kHz intervals, while holding down PREV ◀◀ in standby mode, press STANDBY/ON to turn on the power.

[10 kHz Intervals]

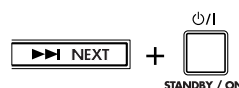

[9 kHz Intervals]

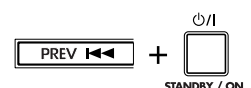

When you change the setting

The preset stations are erased. You will need to preset the stations again. (See page 11.)

Selecting the Sources and Starting Play

To playback CDs, press SELECT CD ►/II. (See pages 12 – 14.)

To playback tapes, press TAPE ◀▶. (See page 19.)

To listen to the FM/AM broadcasts, press FM/AM. (See page 11.)

To select the external equipment as the source, press AUX.



Adjusting the Volume

You can adjust the volume level only while the unit is turned on. The volume level can be adjusted between “VOLUME 0” and “VOLUME 40”.

When using the remote control, press VOLUME + to increase the volume or press VOLUME – to decrease it.



When using the unit, turn VOLUME + / – clockwise (+) to increase the volume or counterclockwise (–) to decrease it.

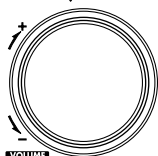

VOLUME 15



For private listening

Connect a pair of headphones to the PHONES jack. No sound comes out of the speakers. Be sure to turn down the volume before connecting or putting on headphones.



DO NOT turn off (on standby) the unit with the volume set to an extremely high level; otherwise, a sudden blast of sound can damage your hearing, speakers and/or headphones when you turn on the unit or start playing any source next time. REMEMBER you cannot adjust the volume level while the unit is on standby.

Reinforcing the Bass Sound

You can reinforce the bass sound to maintain rich (“AHB 1” and “AHB 2”), full bass at low volume. This function only affects the playback sound, but does not affect your recording.

To get the effect, press AHB (Active Hyper Bass) PRO until “AHB 1” or “AHB 2” appears on the display. The BASS indicator also lights up on the display.



- Each time you press the button, the bass sound change as follows:

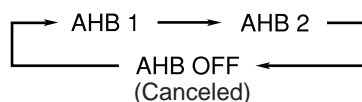

“AHB 2” has much more bass reinforcement effect than “AHB 1.”

To cancel the effect, press AHB PRO until “AHB OFF” appears on the display. The BASS indicator goes off.

Selecting the Sound Modes

You can select one of the 4 preset sound modes. This function only affects the playback sound, but does not affect your recording.

To select the sound modes, press SOUND MODE on the remote control (or SOUND on the unit) until the sound mode you want appears on the display. The SOUND indicator also lights up on the display.

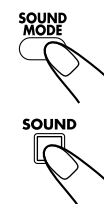

- Each time you press the button, the sound modes change as follows:

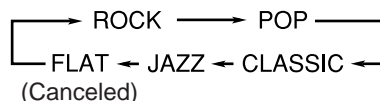

ROCK: Gives a heavy sound. Boosts low and high frequency.

POP: Good for vocal music.

CLASSIC: Good for classical music.

JAZZ: Gives a feeling of live atmosphere. Good for acoustic music.

FLAT: The sound mode is canceled. The SOUND indicator goes off.

Listening to FM and AM Broadcasts



Tuning in a Station

1 Press FM/AM.

The unit automatically turns on and tunes in the previously tuned station (either FM or AM).

- Each time you press the button, the band alternates between FM and AM.



2 Press and hold NEXT ►► or PREV ◄◄ for more than 1 second.

The unit starts searching for stations and stops when a station of sufficient signal strength is tuned in.

If a program is broadcast in stereo, the ST (stereo) indicator lights up.

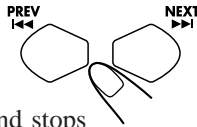

To stop searching, press NEXT ►► or PREV ◄◄.



When you press NEXT ►► or PREV ◄◄ briefly and repeatedly

The frequency changes step by step.

To change the FM reception mode

When an FM stereo broadcast is hard to receive or noisy, press FM MODE on the remote control so that the MONO indicator lights up on the display. Reception improves.



To restore the stereo effect, press FM MODE again so that the MONO indicator goes off. In this stereo mode, you can hear stereo sounds when a program is broadcasted.

Presetting Stations

You can preset 30 FM and 15 AM stations — using either automatic presetting or manual presetting.

In some cases, test frequencies have been already memorized for the tuner since the factory examined the tuner preset function before shipment. This is not a malfunction. You can preset the stations you want into memory by following the presetting method.

To preset stations automatically — Automatic Presetting

You need to preset stations separately for the FM and AM bands.

On the remote control ONLY:

1 Press FM/AM to select the band.

- Each time you press the button, the band alternates between FM and AM.



2 Press and hold AUTO PRESET for more than 2 seconds.

Local stations with strong signals are searched and stored in memory automatically.

When automatic presetting is over, the station stored in preset number 1 is received.



3 Repeat steps 1 and 2 to store stations for the other band.



When you cannot automatically store stations you want Stations with weak signals cannot be detected with this automatic presetting. To store such a station, use the manual presetting.

To preset stations manually — Manual Presetting

- There is a time limit in doing the following steps. If the setting is canceled before you finish, start from step 2 again.

On the remote control ONLY:

1 Tune in the station you want to preset.

- See “Tuning in a Station.”

2 Press SET.

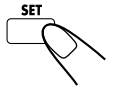

3 Press MULTI KEY > or MULTI KEY < to select a preset number.

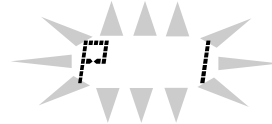
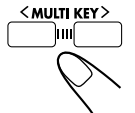

4 Press SET again.

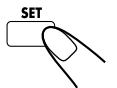

The tuned station in step 1 is stored in the preset number selected in step 3.

- Storing a new station on a used number erases the previously stored one.



When you unplug the AC power cord or if a power failure occurs

The preset stations will be erased in a few days. If this happens, preset the stations again.

Tuning in a Preset Station

On the remote control ONLY:

1 Press FM/AM.

The unit automatically turns on and tunes in the previously tuned station (either FM or AM).

- Each time you press the button, the band alternates between FM and AM.



2 Press MULTI KEY > or MULTI KEY < to select a preset number.

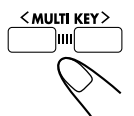

Playing Back CDs (CD/CD-R/CD-RW)



This unit has been designed to playback the following CDs:

- CD
- CD-R
- CD-RW

Continued use of irregular shape CDs (heart-shape, octagonal, etc.) can damage the unit.

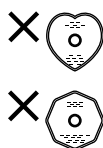

General Notes

In general, you will have the best performance by keeping your CDs and the mechanism clean.

- Store CDs in their cases, and keep them in cabinets or on shelves.
- Keep the unit's disc tray closed when not in use.

When playing a CD-R or CD-RW

User-edited CD-Rs (CD-Recordable) and CD-RWs (CD-ReWritable) can be played back only if they are already "finalized".

- You can playback your original CD-Rs or CD-RWs recorded in music CD format. (However, they may not be played back depending on their characteristics or recording conditions.)
- Before playing back CD-Rs or CD-RWs, read their instructions or cautions carefully.
- Some CD-Rs or CD-RWs may not be played back on this unit because of their disc characteristics, damage or stain on them, or if the player's lens is dirty.
- CD-RWs may require a longer readout time. (This is caused by the fact that the reflectance of CD-RWs is lower than for regular CDs.)

Playing Back the Entire CD — Normal Play

1 Press CD ▲ on the remote control (or ▲ on the CD player section).

The unit automatically turns on and the disc tray comes out.

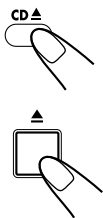

2 Place a disc correctly on the circle of the disc tray, with its label side up.

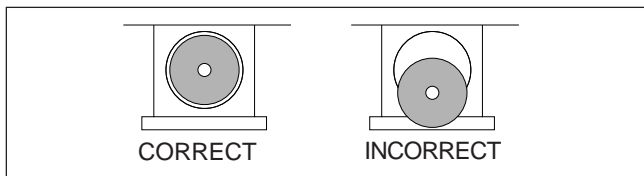

- When using a CD single (8 cm), place it on the inner circle of the disc tray.

3 Press SELECT CD ►/II.

The disc tray automatically closes and the first track of the CD starts playing.



Track number Elapsed playing time

- The CD automatically stops when the last track of the CD has finished playing.

To stop playing, press ■.



Total track number Total playing time

To remove the disc, press CD ▲ on the remote control (or ▲ on the CD player section).



- **If the CD cannot be read correctly (because it is scratched, for example)**
"00 0000" appears on the display.
- **If no CD is inserted**
"NO DISC" appears on the display.
During Reading period, sometimes noise is generated by CD mechanism.
- **If an unreadable CD-R or CD-RW is inserted**
"BLANK CD" appears on the display.



DO NOT try to open or close the CD tray by hand as it will be damaged.

Basic CD Operations

While playing a CD, you can perform the following operations.

To stop playing for a moment

Press SELECT CD ►/II.

While pausing, the elapsed playing time flashes on the display.



To resume playing, press SELECT CD ►/II again.

To go to another track

Press MULTI KEY >/MULTI KEY < or NEXT ►►/PREV ◀◀ repeatedly before or during playback.



- MULTI KEY > or NEXT ►► :
Skips to the beginning of the next or succeeding tracks.
- MULTI KEY < or PREV ◀◀ :
Goes back to the beginning of the current or previous tracks.

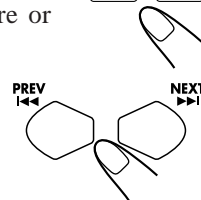

To locate a particular point in a track

During play, press and hold NEXT ►► or PREV ◀◀.

- NEXT ►► : Fast-forwards the tracks.
- PREV ◀◀ : Fast-reverses the tracks.

Programming the Playing Order of the Tracks — Program Play

You can arrange the order in which tracks play before you start playing. **You can program up to 50 tracks.**

On the remote control ONLY:

1 Load a CD.

- If the current playing source is not the CD player, press SELECT CD ►/||, then ■ button before going to the next step.

2 Press PROG (program).

The PRGM (program) indicator lights up on the display.



3 Press MULTI KEY > or MULTI KEY < to select the track number, then press SET.

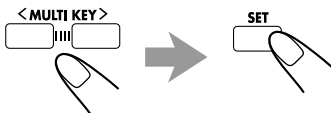

Track number Program step number

4 Repeat step 3 to program other tracks you want.

5 Press SELECT CD ►/||.

The tracks are played in the order you have programmed.



To stop playing, press ■.

To exit from Program mode, press PROG button (during CD stop mode). The PRGM indicator goes off. All the programmed tracks will be cleared.

To check the program contents

You can check the program contents on the display by pressing PREV ◀◀ or ▶▶ NEXT under stop condition. The programmed tracks are shown in the programmed order.

To modify the program

Before or after playing, you can erase the last programmed track by pressing CANCEL on the remote control.

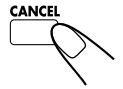

- Each time you press the button, the last programmed track is erased from the program.

To add tracks in the program before playing, simply select the track numbers you want to add by following step 3 of the programming procedure.



- If you try to program the 51st track "FULL" will appear on the display.

Playing at Random — Random Play

The tracks will play in no particular order when you use this mode.

On the remote control ONLY:

To use Random play mode, press RANDOM before play.

The RANDOM indicator lights up on the display.



The tracks are played at random.

Random play ends when all the tracks are played once.

To skip the current track, press NEXT ▶▶ or MULTI KEY >.

- You cannot go back to the previous track by pressing PREV ◀◀ or MULTI KEY <.

To stop playing, press ■.

- Random play mode is also canceled.

To exit from Random play mode, press RANDOM again before play. Random play mode is canceled and Normal play resumes.

Repeating Tracks — Repeat Play

You can have all the tracks, the program or individual track currently playing to repeat as many times as you like.

On the remote control ONLY:

To repeat playing, press REPEAT before or during playing.

- Each time you press the button, Repeat play mode changes as follows, and the following indicator lights up on the display:

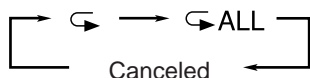

- ↶ : Repeats one track.
- ↶ ALL : In Normal play mode, repeat all the tracks.
In Program play mode, repeat all the tracks in the program.
In Random play mode, repeats all the tracks in random order.

To stop playing, press ■.

To cancel Repeat play, press REPEAT repeatedly until the repeat indicator goes off from the display.

- In Random play ↶ cannot be selected. If ↶ is selected when you press RANDOM, it is canceled (goes off).
- Repeat mode remains in effect even when you change the play mode.

Prohibiting Disc Ejection — Tray Lock

You can lock the disc tray and prohibit to eject the CD.

- This is possible only while the unit is turned on.

On the unit ONLY:

To prohibit disc ejection, press \odot/I STANDBY/ON while holding ■. (If the disc tray is opened, close it first.) “LOCKED” appears for a while, and the disc tray is locked.

LOCKED

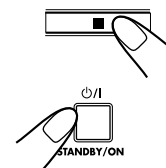

To cancel the prohibition and unlock the CD, press \odot/I STANDBY/ON while holding ■. “UNLOCKED” appears for a while, and the disc tray is unlocked.

UNLOCKED

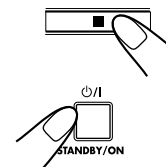

If you try to eject the CD, “LOCKED” appears to inform you that the disc tray is locked.

Using the Video CD Player (Video CDs)

You can play video CDs (with or without the Playback Control (PBC) function) to watch the picture on your TV while listening to the sound through your JVC Micro Component System.



Before playing video CDs

Make sure that the connection between the System and your TV is correct. (See page 8)

Setting the TV System

To view a picture of video CDs, it is required that you set your CD player's TV output mode according to your TV's color system.

Relationship among the playable CDs, System's TV output mode and your TV's color system:

Playable CD	Player's TV output mode	Your TV's color system
NTSC/PAL	NTSC	NTSC
NTSC/PAL	PAL	PAL
NTSC/PAL	PAL AUTO	Multisystem

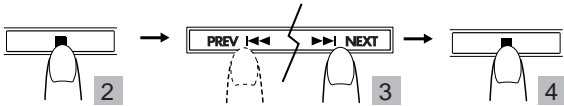

1 Turn off the power to put the System into Standby mode.

2 Press the **■** button on the Unit for more than 2 seconds.

The current TV output mode ("NTSC" for example) appears on the display for five seconds.

3 Within five seconds, press the **▶▶** NEXT or **◀◀** PREV button on the Unit to select the System's TV output mode.

Each time you press the button, the TV output mode changes as follows:

NTSC ⇄ PAL ⇄ PAL AUTO ⇄ (back to beginning)

NTSC: for NTSC exclusive TV

PAL: for PAL exclusive TV

PAL AUTO: for multisystem TV

4 Within five seconds, press the **■** button on the Unit to apply the changes.

5 Turn on the TV and select the video input on the TV.

6 Press the CD **▶/||** SELECT button to turn on the System.

"JVC VIDEO CD/CD PLAYER" screen will appear on the TV without distortion.



- If you play an NTSC CD in PAL AUTO mode on a PAL exclusive TV, the image may be distorted. If this happens change the CD Player's TV output mode to "PAL".
- When you play an NTSC CD in PAL AUTO mode on a multisystem TV, the image may blink for a moment. This symptom occurs when the System detects the formula of the CD and is not a malfunction.
- You can configure the current TV output mode anytime by pressing the **■** button on the Unit for more than 2 seconds.

Playing Video CDs with the PBC Function

The System provides Playback Control (PBC) which utilizes a procedure (menu selection) programed into a VCD.

What is the Playback Control (PBC) function?

PBC allows you to enjoy the following features:

- Menu-Driven Play
You can interact with the TV screen using a menu display to select and play an entry.
- High resolution still image playback
You can display high-quality images four times clearer than video pictures.

You can play video CDs with PBC function using the menu screen (Menu-Driven Play) or without using the menu screen (Continuous Play).



- The playback operation procedure may differ depending on the video CD you use.
- Sometimes due to improper manufacturing, video CDs will function differently.

Playing Video CDs with the PBC Function without Using the Menu Screen (Continuous Play)

You can play video CDs with PBC without using the menu screen, as if the CDs had no PBC function.



1 Load a video CD with PBC.

2 Press the SELECT CD **▶/||** button.

Program Play, Random Play, Repeating Tracks:

Select the mode by pressing the respective button on the Remote Control in the same way as for audio CDs. (See pages 13 and 14)

Playing Video CDs with the PBC Function Using the Menu Screen (Menu-Driven Play)

Before playing, make sure that Repeat indicator “” or “ ALL” is not lit. If lit, press the REPEAT button on the Remote Control until “PBC” appears on the display.

1 Load a video CD with PBC.

Do not press the SELECT CD  button yet.



2 Press “PBC” button on the remote control.

3 Press the SELECT CD button.

“PLAY” appears on the display and the first menu will appear on the TV screen.

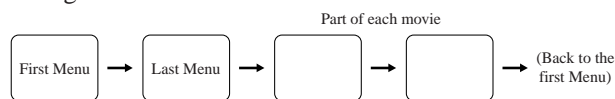
- If you leave your System on its own, the TV screen will change as follows:





To return to the previous menu, press the  RETURN button on the Unit or the  RETURN button on the Remote Control.

4 To move through the next menu, press the following buttons.

On the Unit:

Press the  NEXT or PREV  button.



On the Remote Control:

Press the NEXT  or PREV  button.

5 To select the item (track) in the menu and play it, press the following buttons.

On the Unit:

1. Press the REV.MODE / VCD NUMBER button for more than 2 seconds. “SEL 1” will blink on the display.

2. Press the  NEXT / PREV  buttons to select the item (“SEL XX”) and press the CD  SELECT button to play it back.

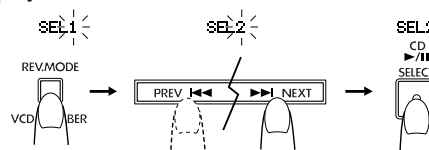

On the Remote Control:

1. Press the VCD No +/- button to select the item (“SEL XX”) you want to play.
2. Press the SELECT CD  button to play it back.

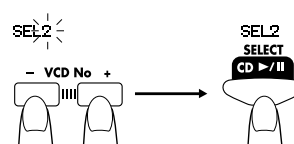

- The next track will be automatically played after the current track is finished.
- While a part of a movie is displayed on the TV in step 2, pressing the SELECT button on the Unit or the Remote Control causes the track being played to restart.

To pause, press the SELECT CD  button on the Remote Control.

To stop playback and return to the first menu, press the  RETURN button repeatedly.











To stop the video CD, press the .

To select other items during playback, repeat step 4.



- Program Play, Random Play and Repeating Tracks cannot be performed during Menu-Driven Play.

Basic Remote Control and Unit Button Functions for Menu-Driven Play:

Remote Control	Unit*	Function
PREV  / NEXT 	PREV  /  NEXT	Move through menu.
+ VCD No -	REV.MODE / VCD NUMBER ↓ PREV  /  NEXT	Select a specific menu item.
SELECT CD 	CD  SELECT	Enters the selected video CD number or item. When a part of movie is displayed on the TV screen, starts playing that track from the beginning.
 RETURN	 RETURN	Returns to the previous menu during playback.

* The PBC function button names on the unit and the remote control are printed in orange.

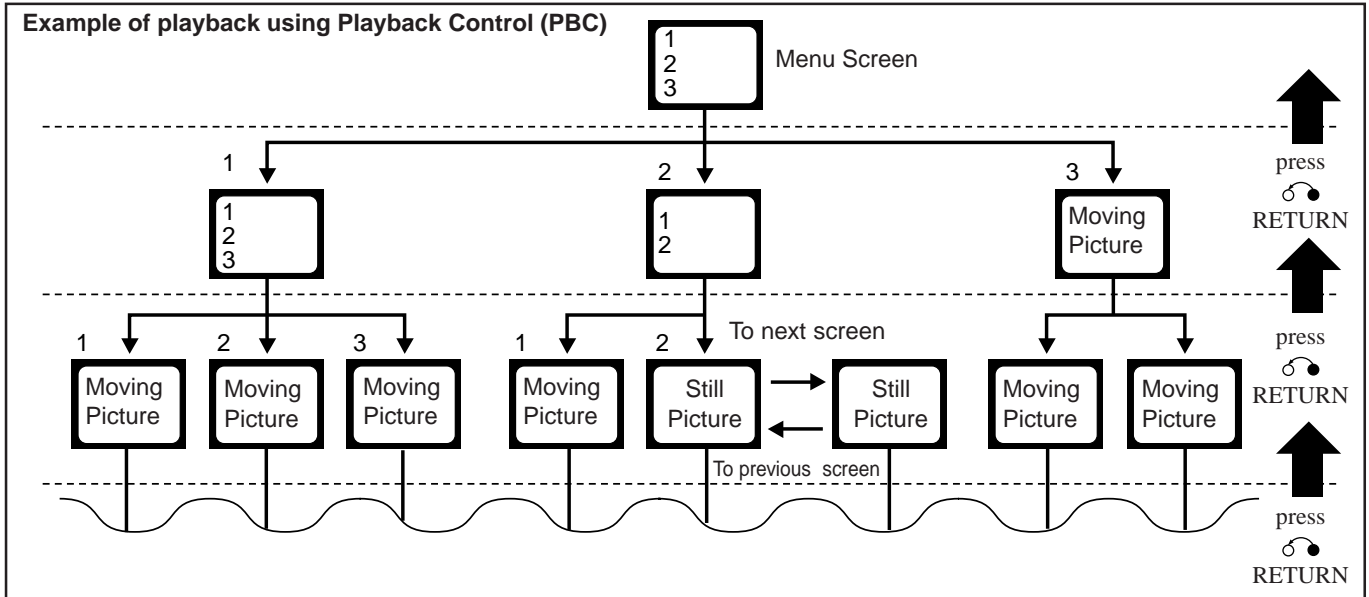

A selection menu is displayed when you start playing a video CD with PBC. The selection menu shows a list of numbers for selection. Some video CDs may show moving pictures or a divided screen.

- When a list of numbers is displayed, selecting a number shows its contents.
- When a moving picture is displayed, pressing CD ►/|| SELECT when the part of the movie you desire is shown plays the movie.
- When the selection menu is re-displayed after you have played your selection, selecting a number again can replay its contents. (Some video CDs may show the menu screen several times)

When “NEXT” and “PREV” are shown, pressing ►►| NEXT or PREV |◀◀ can change the selection menu.

- After playback, press ◂● RETURN to go back to the previous screen. After playback, pressing ◂● RETURN for 2 seconds or more causes it to stop. Some video CDs may return you to the menu screen shown before playback.



- When a menu screen of a karaoke disc is displayed for about a few minutes without any selection being made, it automatically starts playing from the first song.
- When using the REPEAT function, the PBC function is not available.

Playing video CDs without the PBC Function

Basic playback procedures for video CDs are the same as for audio CDs. (See page 12)

- When you start playing a video CD without PBC, “VIDEO CD” appears on the display.



- During playback of a video CD, the following operations may distort the image on the TV screen.
Searching for the beginning of the track, Skipping tracks, Stopping/pausing the tracks, or frame-by-frame playback.

Various Functions to Enhance Your Enjoyment

You can use the following features using the Remote Control.

Frame-by-Frame Playback

Frame-by-Frame playback is possible only when moving pictures (of the video CDs with or without PBC) are played.

During playback, press the STILL button to pause the video CD.

Each time you press the STILL button, the picture advances by one frame. During Frame-by-Frame playback, no sound will be heard.

To resume Normal Play, press the SELECT CD ►/|| button.



- You cannot return to the previous frame.

Display of Operating Status

You can view the current operating status on the TV screen.

Press the ON SCREEN button.

Pressing the above button alternates between on-screen display ON and OFF.

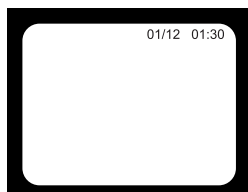

- Once you have turned on the on-screen display, the track number and playing time are always displayed on the TV screen.

Viewing the Video Intro of Video CDs

You can check the contents of a video CD, watching the first 5 seconds of each track on the disc.

1 Play the video CD with or without PBC.

- Load the video CD with or without PBC.
- Press the SELECT CD ►/|| button, then press the ■ button.

2 Press the VIDEO INTRO button.

The Video Intro Play starts and the first 5 seconds portions of the first nine tracks are played in sequence.

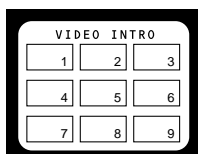

- If the video CD has more than nine tracks, the tracks whose track number is greater than nine will be displayed on the next page when the MULTI KEY > or NEXT ►►| is pressed.
- This function is not available in PBC mode or during playback.

To select a track during Video Intro Play, press the VCD No +/- buttons on the Remote Control to select the track and then press the SELECT CD ►/|| button. Continuous play starts from the selected track. When you use the Unit, press the REV.MODE/VCD NUMBER button and press the PREV |◀◀ or ►►| NEXT buttons to select the track, then press the CD ►/|| SELECT button.

To stop and cancel the Video Intro Play, press the ■.

Playing Back Tapes



You can playback type I, type II, and type IV tapes without changing any settings.

Playing Back a Tape

1 Press button for cassette deck.

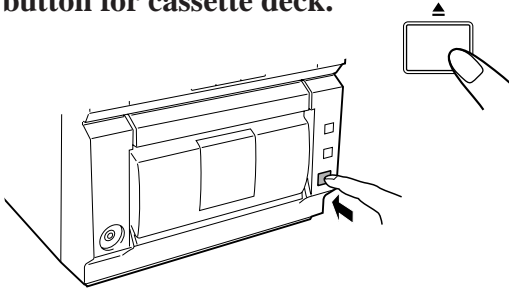

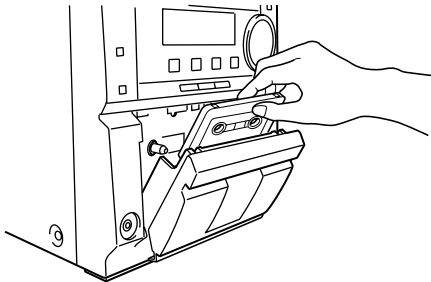

2 Put a cassette in with the exposed part of the tape down.



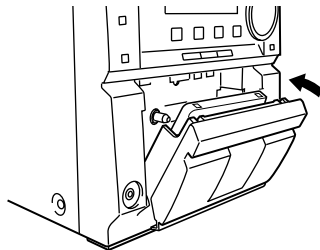

3 Close the cassette holder gently.



4 Press TAPE .

The unit automatically turns on and the tape play starts. The tape direction indicator ( or ) flashes slowly on the display.



- Each time you press the button, the tape direction changes.



-  : plays the front side.
-  : plays the reverse side.



When the tape plays to the end, the deck automatically stops if the reverse mode is set to . (See “To play both sides — Reverse Mode.”)

To stop playing, press .

To fast-wind to the left or to the right, press  NEXT or PREV .

The tape direction indicator ( or ) starts flashing quickly on the display.

To remove the cassette, press  button for cassette deck.

To play both sides — Reverse Mode





You can set the deck to play just one side of a tape, both sides once, or both sides continuously.

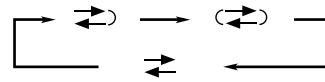

Press REV.MODE on the unit.

- Each time you press the button, reverse mode changes as follows:



-  : The deck automatically stops after playing both sides of the tape. (Stops when playback in the  direction is finished.)
-  : The deck continues to play both sides of the tape until  is pressed.
-  : The deck automatically stops after playing one side of the tape.



The use of the C-120 or thinner tape is not recommended, since characteristic deterioration may occur and this tape easily jams in the pinch-rollers and the capstans.

Recording



IMPORTANT:

- It may be unlawful to record or playback copyrighted material without the consent of the copyright owner.
- The recording level is automatically set correctly, so it is not affected by the VOLUME, AHB (Active Hyper Bass) PRO, and SOUND MODE settings. Thus, during recording you can adjust the sound you are actually listening to without affecting the recording level.
- If recordings you have made have excessive noise or static, the unit may be too close to a TV. Increase the distance between the TV and the unit.
- You can use type I tape for recording.

To protect your recording

Cassettes have two small tabs on the back to protect from unexpected erasure or re-recording.

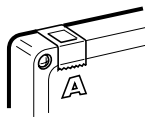

To protect your recording, remove these tabs.

To re-record on a protected tape, cover the holes with adhesive tape.

To keep the best recording and playback sound quality

If the heads, capstans, and pinch rollers of the cassette decks become dirty, the following will occur:

- Impaired sound quality
- Discontinuous sound
- Fading
- Incomplete erasure
- Difficulty in recording

To clean the heads, capstans, and pinch rollers

Use a cotton swab moistened with alcohol.

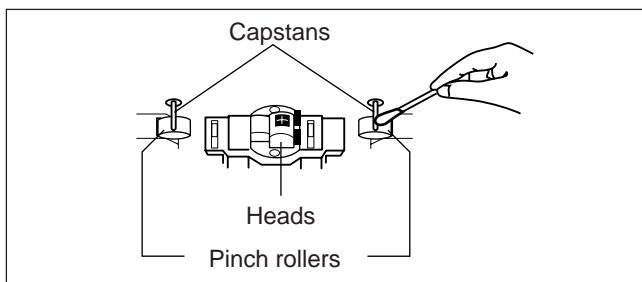

To demagnetize the heads

Turn off the unit, and use a head demagnetizer (available at electronics and audio shops).



At the start and end of cassette tapes

There is leader tape which cannot be recorded onto. Thus, when recording CDs or radio broadcasts, wind on the leader tape first to ensure that the recording will be made without any music part lost.

Recording on a Tape

On the unit ONLY:

- 1 Put a recordable cassette in with the exposed part of the tape down.

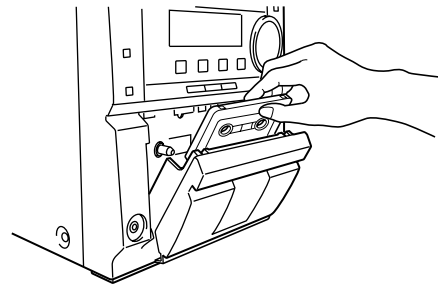

- 2 Close the cassette holder gently.

- If you want to record on both sides of a tape, see “To record on both sides — Reverse Mode.”

- 3 Check the recording direction for the tape.

- If the tape direction is not correct, press TAPE ◀▶ twice then ■ to change the tape direction.

- 4 Start playing the source — FM, AM or auxiliary equipment connected to AUX jacks.

- When the source is CD, see “CD Direct Recording” on page 21.

- 5 Press REC.

The REC indicator lights up on the display and recording starts.



To stop recording, press ■.

To remove the cassette, press ▲ for cassette deck.

To record on both sides — Reverse Mode

Press REV.MODE on the unit until the ◀▶ indicator is lit.

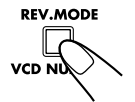

- When using the reverse mode for recording, start recording in the forward (▶) direction first. Otherwise, recording will stop when recording is done only on one side (reverse) of the tape.

CD Direct Recording

Everything on the CD goes onto the tape in the order it is on the CD, or according to the order you have made for Program play.

On the unit ONLY:

1 Put a recordable cassette in with the exposed part of the tape down.

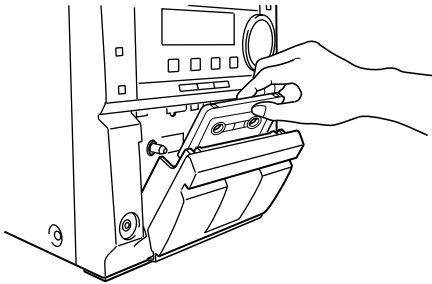

2 Place a disc correctly on the circle of the disc tray, with its label side up.

- If the current playing source is not from the CD player, press CD ►/|| SELECT to select CD player source, then press ■ to stop playing.
- If you want to record on both sides of a tape, see “To record on both sides — Reverse Mode.”
- If you do not want pauses of about 4 seconds recorded between selections, press CD ►/|| SELECT twice. If nothing is done, non-recorded pause will be automatically recorded between selections.



CD source should not be playing on its own before recording.

3 Press REC.

The REC indicator lights up on the display and recording starts. After recording, the CD player and cassette deck automatically stop.



To stop CD Direct Recording, press ■. The tape stops after 4 seconds.

To remove the cassette, press ▲ for the cassette deck.

To record on both sides — Reverse Mode

Press REV.MODE on the unit until the ⇄ indicator is lit.

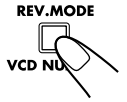

- When using the reverse mode for CD Direct Recording, start recording in the forward (►) direction first. When the tape reaches its end while recording a song in the forward direction (►), the last song will be re-recorded at the beginning of the reverse side (◄).

If you start recording on the reverse side (◄), recording will stop when recording is done only on one side (reverse) of the tape.



When making SLEEP timer settings while doing CD Direct recording

Set enough time to allow for the CD to finish playing, otherwise the power will go off before recording is completed.

One Track Recording

This recording method is convenient when you record tracks while playing a CD. You can only record your favorite songs on the tape.

On the unit ONLY:

1 Put a recordable cassette in with the exposed part of the tape down.

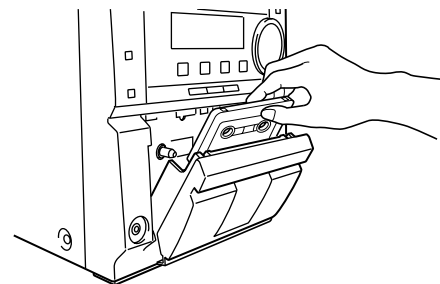

2 Play the track on the CD you wish to record.

3 Press REC.

The CD player returns to the beginning of that track and the track is recorded on the tape. After recording, the CD player and cassette deck automatically stop.



4 Repeat steps 2 and 3 to record other tracks you want.



Using the Multiplex CDs

If the source you are going to play is a multiplex CD, you can use the Multiplex Sound function.

What is Multiplex Sound?

In a multiplex CD or VCD, two separate languages are recorded on the left and right channel. With this system, you can select your choice of language you wish to listen to.

1 Turn on the TV and select the video input on the TV.

2 Press the MPX button on the remote control to select the MPX mode.

Each time you press the button, MPX mode changes as follows.

MPX: LCH MONO → RCH MONO → STEREO

LCH MONO: Only the left channel (instrumental parts) are played through both speakers.

RCH MONO: Only the right channel (vocal parts) are played through both speakers.

STEREO: Normal stereo mode.

- You can also use MPX mode during playback.
- MPX status is not indicate on the display.
- **To return to Normal stereo mode press the MPX button on the remote control until “STEREO” appear on the display.**

3 Play a multiplex CD.

To play a video CD with PBC, see page 15.

4 Adjust the main volume control to the loudness you want.

- If you want to record on a tape, carry out CD Direct Recording or One Track Recording. (See page 21.)

Using the Timers



There are three timers available — Daily Timer, Recording Timer, and Sleep Timer.

Before using the timers, you need to set the clock built in the unit (see page 9). When you press **TIMER** on the unit for more than 3 seconds, the display alternates between “ADJUST” and “CLOCK” for about 5 seconds.

Using Daily Timer and Recording Timer

You can set the timer whether the unit is on or off.

When the on-time comes, the unit automatically turns on (the \odot indicator flashes just before the on-time, and continues flashing while the timer is operating.) Then, when the off-time comes, the unit automatically turns off (on standby). The timer setting remains in memory until you change it.

- When the **DAILY** indicator is lit on the display, the timer acts as the Daily Timer. Once the Daily Timer has been set, it will be activated at the same time everyday until the timer is turned off.
- When the **REC** indicator is lit on the display, the timer acts as the Recording Timer. After the Recording Timer has been performed, the details of the setting remain stored but the timer is turned off.

Before you start...

When using “TUNER” as the source to play, make sure to select the desired station before turning off the power.

- There is a time limit in doing the following steps. If the setting is canceled before you finish, start from step 1 again.

On the unit ONLY:

1 Press and hold **TIMER** for more than 3 seconds.

The timer (\odot) indicator lights up, and the timer mode indicator (**DAILY** or **REC**) and the current on-time flash on the display.

The unit enters on-time setting mode.



2 Set the on-time you want the unit to turn on at.

- 1) Press \ggg **NEXT** or **PREV** \lll to set the hour, then press **TIMER**.
- 2) Press \ggg **NEXT** or **PREV** \lll to set the minute, then press **TIMER**.
The unit enters off-time setting mode.

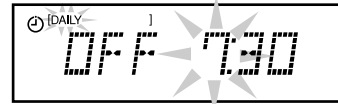

3 Set the off-time you want the unit to turn off (on standby) at.

- 1) Press \ggg **NEXT** or **PREV** \lll to set the hour, then press **TIMER**.
- 2) Press \ggg **NEXT** or **PREV** \lll to set the minute, then press **TIMER**.
The unit enters source selecting mode.

4 Press \ggg **NEXT** or **PREV** \lll to select the timer mode (Daily Timer or Recording Timer) and the source to play, then press **TIMER**.

- Each time you press \ggg **NEXT** or **PREV** \lll , the timer mode and the source change as follows:

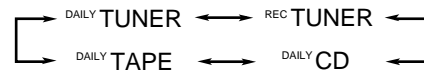

DAILY TUNER: tunes into the last station you were listening to. (Daily Timer)

REC TUNER: records the last station you were listening to. (Recording Timer)

- Put a recordable cassette into the deck.

DAILY CD: plays a CD. (Daily Timer)

DAILY TAPE: plays a tape. (Daily Timer)

- Make sure that the tape direction is correct.

5 Press \ggg **NEXT** or **PREV** \lll to set the volume level.

- You can select the volume level (“VOLUME 0” to “VOLUME 40” and “VOLUME –”). If you select “VOLUME –,” the volume is set to the last level when the unit has been turned off.

To turn off the volume while the Recording Timer (REC TUNER**) is working, set the volume level “VOLUME 0”.**

6 Press **TIMER** to complete the timer setting.



7 Press **⏻/⏻** **STANDBY/ON** to turn off the unit (on standby) if you have set the timer with the unit turned on.

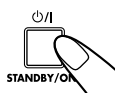

- When the timer turns on the unit, the timer (⌚) indicator and the selected timer mode indicator (DAILY or REC) start flashing.

To cancel the setting, press and hold **TIMER** until the timer (⌚) indicator goes off from the display.



- **If the unit is turned on when the timer-on time comes**
Timer does not work.
- **When you unplug the AC power cord or if a power failure occurs**
The timer will be canceled. You need to set the clock first, then the timer again.

Using Sleep Timer

With Sleep Timer, you can fall asleep to music. You can set Sleep Timer when the unit is turned on.

How Sleep Timer actually works

The unit automatically turns off after the specified time length passes.

On the remote control ONLY:

1 Press **SLEEP**.

The time length until the shut-off time appears and the **SLEEP** indicator lights up on the display.



- Each time you press the button, the time length changes as follows:

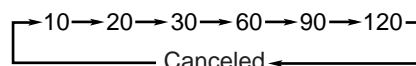

2 Wait for about 5 seconds after specifying the time length.

To check the remaining time until the shut-off time, press **SLEEP** once so that the remaining time until the shut-off time appears for about 5 seconds.

To change the shut-off time, press **SLEEP** repeatedly until the desired time length appears on the display.

To cancel the setting, press **SLEEP** repeatedly until the **SLEEP** indicator goes off.

- Sleep Timer is also canceled when you turn off the unit.



- **If you set the Sleep Timer after Daily Timer starts playing the selected source**
Daily Timer is canceled.
- **If you set the Sleep Timer after Recording Timer starts recording**
Recording Timer is canceled, but recording continues until Sleep Timer shuts off the power.

Maintenance



To get the best performance of the unit, keep your discs, tapes, and mechanism clean.

Handling discs



- Remove the disc from its case by holding it at the edge while pressing the center hole lightly.
- Do not touch the shiny surface of the disc, or bend the disc.
- Put the disc back in its case after use to prevent warping.

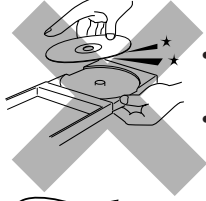

- Be careful not to scratch the surface of the disc when placing it back in its case.
- Avoid exposure to direct sunlight, temperature extremes, and moisture.



To clean the disc

Wipe the disc with a soft cloth in a straight line from center to edge.



DO NOT use any solvent — such as conventional record cleaner, spray, thinner, or benzine — to clean the disc.

Cleaning the unit

Stains on the unit

Should be wiped off with a soft cloth. If the unit is heavily stained, wipe it with a cloth soaked in water-diluted neutral detergent and wrung well, then wipe clean with a dry cloth.

- **Since the unit may deteriorate in quality, become damaged or get its paint peeled off, be careful about the followings.**
 - DO NOT wipe it with a hard cloth.
 - DO NOT wipe it strong.
 - DO NOT wipe it with thinner or benzine.
 - DO NOT apply any volatile substance such as insecticides to it.
 - DO NOT allow any rubber or plastic to remain in contact with it for a long time.

Handling cassette tapes

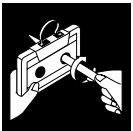

- If the tape is loose in its cassette, take up the slack by inserting a pencil in one of the reels and rotating.
- If the tape is loose, it may get stretched, cut, or caught in the cassette.



- Be careful not to touch the tape surface.



- Avoid the following places to store the tape:
 - In dusty places
 - In direct sunlight or heat
 - In moist areas
 - On a TV or speaker
 - Near a magnet

Troubleshooting



If you are having a problem with your unit, check this list for a possible solution before calling for service.

If you cannot solve the problem from the hints given here, or the unit has been physically damaged, call a qualified person, such as your dealer, for service.

Symptom	Cause	Action
No sound is heard.	<ul style="list-style-type: none"> • Connections are incorrect or loose. • Headphones are connected. 	<ul style="list-style-type: none"> • Check all connections and make corrections. (See pages 6 to 8.) • Disconnect the headphones.
Hard to listen to broadcasts because of noise.	<ul style="list-style-type: none"> • Antennas are disconnected. • The AM loop antenna is too close to the unit. • The FM antenna is not properly extended and positioned. 	<ul style="list-style-type: none"> • Reconnect the antennas correctly and securely. • Change the position and direction of the AM loop antenna. • Extend the FM antenna at the best position.
The disc tray does not open or close.	The AC power cord is not plugged in.	Plug the AC power cord.
The disc does not play.	The disc is placed upside down.	Place the disc with the label side up.
The disc sound is discontinuous.	The disc is scratched or dirty.	Clean or replace the disc. (See page 24.)
The cassette holder cannot be opened.	Power supply from the AC power cord has been cut off while the tape was running.	Turn on the unit.
Impossible to record.	Small tabs on the back of the cassette are removed.	Cover the holes with adhesive tape.
Operations are disabled.	The built-in microprocessor may malfunction due to external electrical interference.	Unplug the AC power cord and then plug it back in.
Unable to operate the unit from the remote control.	<ul style="list-style-type: none"> • The path between the remote control and the remote sensor on the unit is blocked. • The batteries are exhausted. 	<ul style="list-style-type: none"> • Remove the obstruction. • Replace the batteries.

Specifications

Design and specifications are subject to change without notice.

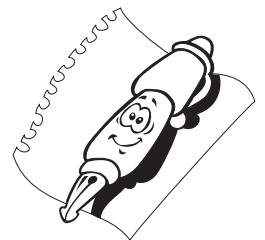

UX-P38V (CA-UXP38V and SP-UXP38V)

Amplifier

Output Power	40 W (20 W + 20 W) at 4 Ω (MAX.) 36 W (18 W + 18 W) at 4 Ω (10 % THD)
Audio input sensitivity/Impedance (at 1 kHz)	AUX: 400 mV/48 kΩ
Digital Output – OPTICAL DIGITAL OUT (For Hong Kong only)	Signal wave length: 660 nm Output level: -21 dBm to -15 dBm
Speakers/Impedance	4 Ω – 16 Ω

Tuner

FM tuning range	87.50 MHz – 108.00 MHz
AM tuning range	At 9 kHz intervals: 531 kHz – 1 710 kHz At 10 kHz intervals: 530 kHz – 1 710 kHz

CD player

Dynamic range	85 dB
Signal-to-noise ratio	90 dB
Wow and flutter	Immeasurable

Cassette deck

Frequency response	Normal (type I): 50 Hz – 14 000 Hz
Wow and flutter	0.15 % (WRMS)

General

Power requirement	AC 110 V/AC 127 V/AC 220 V/AC 230 V \sim , adjustable with the voltage selector, 50 Hz/60 Hz
Power consumption	55 W (at operation) 3.4 W (on standby)
Dimensions (approx.)	505 mm x 256 mm x 295 mm (W/H/D) (20 1/8 in. x 10 1/8 in. x 11 5/8 in.)
Mass (approx.)	8.5 kg (18.8 lbs)

Supplied Accessories

See page 6.

Speaker

Speaker units	10 cm (3 15/16 in.) cone x 1
Impedance	4 Ω
Dimensions (approx.)	160 mm x 256 mm x 205 mm (W/H/D) (6 5/16 in. x 10 1/8 in. x 8 in.)
Mass (approx.)	2.1 kg (4.6 lbs)

Mains (AC) Line Instruction (not applicable for Europe, U.S.A., Canada, Australia, and U.K.)

主 (AC) 电源线路说明 (不适用于欧洲、美国、加拿大、澳洲及英国型号)

คำแนะนำเกี่ยวกับสายไฟหลัก (AC) (ยกเว้นประเทศในยุโรป สหรัฐอเมริกา แคนาดา ออสเตรเลีย และสหราชอาณาจักร)

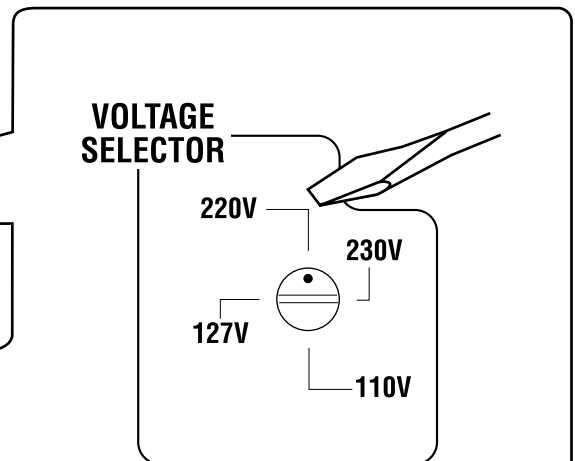
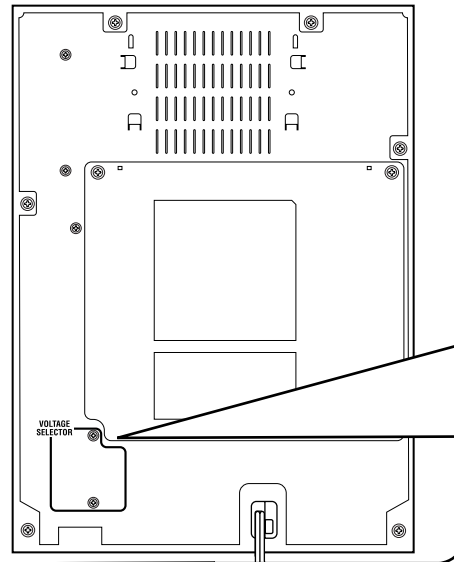

IMPORTANT for mains (AC) line

BEFORE PLUGGING IN, do check that your mains (AC) line voltage corresponds with the position of the voltage selector switch provided on the outside of this equipment and, if different, reset the voltage selector switch, to prevent from a damage or risk of fire/electric shock.

สิ่งสำคัญเกี่ยวกับสายไฟหลัก (AC)

ก่อนเสียบปลั๊ก ให้ตรวจสอบแรงดันไฟฟ้าของสายไฟหลัก (AC) ของท่านว่าเท่ากับกับตำแหน่งของสวิตช์เลือกแรงดันไฟฟ้าที่อยู่นอกอุปกรณ์หรือไม่ หากแรงดันไฟฟ้าไม่เท่ากันกัน ให้ตั้งสวิตช์ใหม่เพื่อป้องกันความเสียหายและเสี่ยงการเกิดไฟไหม้/ไฟดูด

有关主 (AC) 电源线路的重要事项

接插电源以前，务请检查当地的主(AC)电源线路电压是否和位于本机外面的电压选择开关设定的位置一致。如果不一致，即重新设定电压选择开关使符合当地电压，以免损坏机器或引起火灾/触电的危险。

Free Manuals Download Website

<http://myh66.com>

<http://usermanuals.us>

<http://www.somanuals.com>

<http://www.4manuals.cc>

<http://www.manual-lib.com>

<http://www.404manual.com>

<http://www.luxmanual.com>

<http://aubethermostatmanual.com>

Golf course search by state

<http://golfingnear.com>

Email search by domain

<http://emailbydomain.com>

Auto manuals search

<http://auto.somanuals.com>

TV manuals search

<http://tv.somanuals.com>