

JVC



COMPACT COMPONENT SYSTEM

KOMPAKTES KOMPONENTENSYSYEM
SYSTEME DE COMPOSANTS COMPACT
KOMPACTO KOMPONENTEN-SYSTEEM
SISTEMA DE COMPONENTES COMPACT
IMPIANTO A COMPONENTI COMPATTO

CA-D672TR

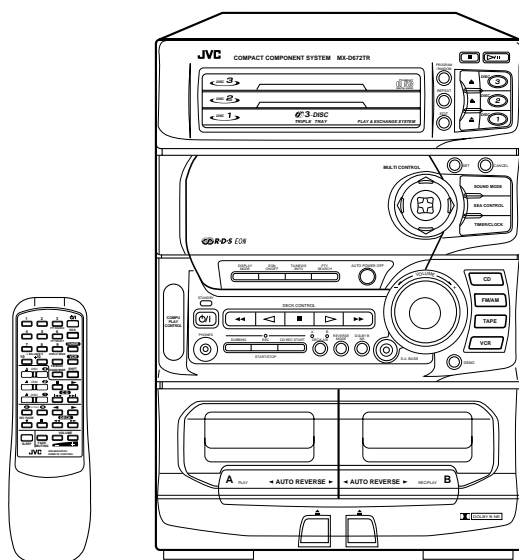

COMPACT
disc
DIGITAL AUDIO

 R-D-S EON

INSTRUCTIONS
BEDIENUNGSANLEITUNG
MANUEL D'INSTRUCTIONS
GEBRUIKSAANWIJZING
MANUAL DE INSTRUCCIONES
ISTRUZIONI

For Customer Use:

Enter below the Model No. and Serial No. which are located either on the rear, bottom or side of the cabinet. Retain this information for future reference.

Model No. _____

Serial No. _____

GVT0001-006A

[E]

Warnings, Cautions and Others / Warnung, Achtung und sonstige Hinweise / Mises en garde, précautions et indications diverses / Waarschuwingen, voorzorgen en andere mededelingen / Avisos, precauciones y otras notas / Avvertenze e precauzioni da osservare

IMPORTANT for the U.K.

DO NOT cut off the mains plug from this equipment. If the plug fitted is not suitable for the power points in your home or the cable is too short to reach a power point, then obtain an appropriate safety approved extension lead or consult your dealer.

BE SURE to replace the fuse only with an identical approved type, as originally fitted.

If nonetheless the mains plug is cut off ensure to remove the fuse and dispose of the plug immediately, to avoid a possible shock hazard by inadvertent connection to the mains supply.

If this product is not supplied fitted with a mains plug then follow the instructions given below:

IMPORTANT:

DO NOT make any connection to the terminal which is marked with the letter E or by the safety earth symbol or coloured green or green-and-yellow.

The wires in the mains lead on this product are coloured in accordance with the following code:

Blue : Neutral
Brown : Live

As these colours may not correspond with the coloured markings identifying the terminals in your plug proceed as follows:

The wire which is coloured blue must be connected to the terminal which is marked with the letter N or coloured black.

The wire which is coloured brown must be connected to the terminal which is marked with the letter L or coloured red.

IF IN DOUBT - CONSULT A COMPETENT ELECTRICIAN.

Per l'Italia:

"Si dichiara che il questo prodotto di marca JVC è conforme alle prescrizioni del Decreto Ministeriale n.548 del 28/08/95 pubblicato sulla Gazzetta Ufficiale della Repubblica Italiana n.301 del 28/12/95."

Caution — ⏻ switch!

Disconnect the mains plug to shut the power off completely. The ⏻ switch in any position does not disconnect the mains line. The power can be remote controlled.

Achtung — ⏻/I-Schalter!

Den Netzstecker aus der Steckdose ziehen, um die Stromversorgung vollkommen zu unterbrechen. Der Schalter ⏻/I unterbricht in keiner Stellung die Stromversorgung vollkommen. Die Stromversorgung kann mit der Fernbedienung ein- und ausgeschaltet werden.

Attention — Commutateur ⏻/I!

Déconnecter la fiche de secteur pour couper complètement le courant. Le commutateur ⏻/I ne coupe jamais complètement la ligne de secteur, quelle que soit sa position. Le courant peut être télécommandé.

Voorzichtig — ⏻/I schakelaar!

Om de stroomtoevoer geheel uit te schakelen, trekt u de stekker uit het stopcontact. Anders zal er altijd een geringe hoeveelheid stroom naar het apparaat lopen, ongeacht de stand van de ⏻/I schakelaar. U kunt het apparaat ook met de afstandsbediening aan- en uitschakelen.

Precaución — Interruptor ⏻/I!

Desconectar el cable de alimentación para desactivar la alimentación totalmente. Cualquier que sea la posición de ajuste del interruptor ⏻/I, la alimentación no es cortada completamente. La alimentación puede ser controlada remotamente.

Attenzione — L'interruttore ⏻/I!

Disinserire la spina del cavo di alimentazione dalla presa della rete elettrica per staccare completamente l'alimentazione. L'interruttore ⏻/I in nessuna posizione stacca la linea di alimentazione elettrica principale. È possibile il controllo remoto dell'alimentazione.

CAUTION

To reduce the risk of electrical shocks, fire, etc.:

1. Do not remove screws, covers or cabinet.
2. Do not expose this appliance to rain or moisture.

ACHTUNG

Zur Verhinderung von elektrischen Schlägen, Brandgefahr, usw.:

1. Keine Schrauben lösen oder Abdeckungen entfernen und das Gehäuse nicht öffnen.
2. Dieses Gerät weder Regen noch Feuchtigkeit aussetzen.

ATTENTION

Afin d'éviter tout risque d'électrocution, d'incendie, etc.:

1. Ne pas enlever les vis ni les panneaux et ne pas ouvrir le coffret de l'appareil.
2. Ne pas exposer l'appareil à la pluie ni à l'humidité.

VOORZICHTIG

Ter vermindering van gevaar voor brand, elektrische schokken, enz.:

1. Verwijder geen schroeven, panelen of de behuizing.
2. Stel het toestel niet bloot aan regen of vocht.

PRECAUCIÓN

Para reducir riesgos de choques eléctricos, incendio, etc.:

1. No extraiga los tornillos, los cubiertas ni la caja.
2. No exponga este aparato a la lluvia o a la humedad.

ATTENZIONE

Per ridurre il rischio di shock elettrici, incendi, ecc...

1. Non togliete viti, coperchi o la scatola.
2. Non esponete l'apparecchio alla pioggia e all'umidità.

Caution: Proper Ventilation

To avoid risk of electric shock and fire, and to prevent damage, locate the apparatus as follows:

- 1 Front:
No obstructions and open spacing.
- 2 Sides/ Top/ Back:
No obstructions should be placed in the areas shown by the dimensions below.
- 3 Bottom:
Place on the level surface. Maintain an adequate air path for ventilation by placing on a stand with a height of 10 cm or more.

Achtung: Ausreichende Belüftung

Zur Vermeidung von elektrischen Schlägen, Feuer und sonstigen Schäden sollte das Gerät unter folgenden Bedingungen aufgestellt werden:

- 1 Vorderseite:
Hindernisfrei und gut zugänglich.
- 2 Seiten- und Rückwände:
Hindernisfrei in allen gegebenen Abständen (s. Abbildung).
- 3 Unterseite:
Die Stellfläche muß absolut eben sein. Sorgen Sie für ausreichende Luftzufuhr durch Aufstellung auf einem Stand mit mindestens 10 cm Höhe.

Attention: Aération correcte

Pour prévenir tout risque de décharge électrique ou d'incendie et éviter toute détérioration, installez l'appareil de la manière suivante:

- 1 Avant:
Bien dégagé de tout objet.
- 2 Côtés/dessus/dessous:
Assurez-vous que rien ne bloque les espaces indiqués sur le schéma ci-dessous.
- 3 Dessous:
Posez l'appareil sur une surface plane et horizontale. Veillez à ce que sa ventilation correcte puisse se faire en le plaçant sur un support d'au moins dix centimètres de hauteur.

Voorzichtig: Goede ventilatie vereist

Om brand, elektrische schokken en beschadiging te voorkomen, moet u het toestel als volgt opstellen:

- 1 Voorkant:
Geen belemmeringen en voldoende ruimte.
- 2 Zijkanten/boven-/onderkant:
Geen belemmeringen plaatsen in de hieronder aangegeven zones.
- 3 Onderkant:
Op vlakke ondergrond plaatsen. Voldoende ventilatieruimte voorzien door het toestel op een onderstel met een hoogte van 10 cm of meer te plaatsen.

Precaución: ventilación correcta

Para evitar el riesgo de descargas eléctricas e incendio y prevenir posibles daños, instale el equipo en un lugar que cumpla los siguientes requisitos:

- 1 Parte frontal:
Sin obstrucciones, espacio abierto.
- 2 Lados/parte superior/parte posterior:
No debe haber ninguna obstrucción en las áreas mostradas por las dimensiones de la siguiente figura.
- 3 Parte inferior:
Sitúe el equipo sobre una superficie nivelada. Mantenga un espacio adecuado para permitir el paso del aire y una correcta ventilación, situando el equipo sobre un soporte de 10 o más cm de altura.

Attenzione: Per una corretta ventilazione

Per prevenire il rischio di scosse elettriche e di incendio ed evitare possibili danni, collocare le apparecchiature nel modo seguente:

- 1 Parte anteriore:
Nessun ostacolo e spazio libero.
- 2 Lati/Parte superiore/Retro:
Lasciare libere le zone indicate dalle dimensioni di seguito.
- 3 Base:
Collocare su una superficie piana. Consentire un'adeguata ventilazione dell'impianto appoggiandolo su un tavolinetto alto almeno 10 cm.

Front view
Vorderansicht
Face
Vooraanzicht
Vista frontal
Vista frontale

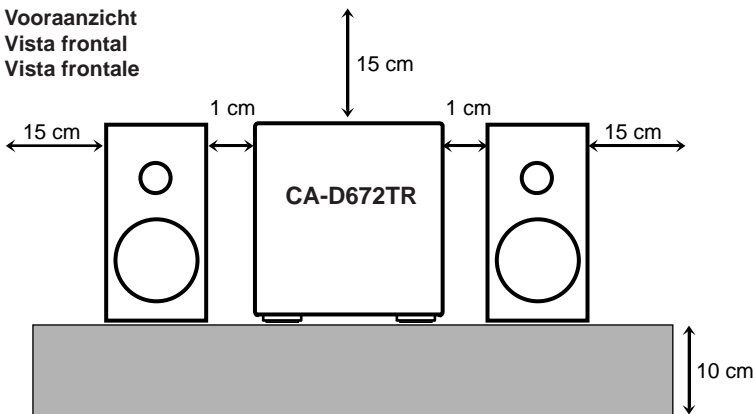

Side view
Seitenansicht
Côté
Zijaanzicht
Vista lateral
Vista laterale

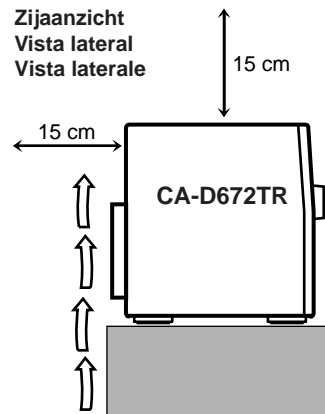

IMPORTANT FOR LASER PRODUCTS/ WICHTIGER HINWEIS FÜR LASER-PRODUKTE / IMPORTANT POUR LES PRODUITS LASER /BELANGRIJKE INFORMATIE VOOR LASERPRODUKTEN / IMPORTANTE PARA LOS PRODUCTOS LASER / IMPORTANTE PER I PRODOTTI LASER

REPRODUCTION OF LABELS/ANBRINGUNGSORTE FÜR LASER-PRODUKTE/REPRODUCTION DES ETIQUETTES/ VERKLARING VAN DE LABELS/REPRODUCCIÓN DE ETIQUETAS/RIPRODUZIONE DELLE ETICHETTE

- | | |
|--|---|
| ① CLASSIFICATION LABEL, PLACED ON REAR ENCLOSURE | ② WARNING LABEL, PLACED INSIDE THE UNIT |
| ① KLASSIFIKATIONSETIKETTE AN DER RÜCKSEITE | ② WARNETIKETTE IM GERÄTEINNEREN |
| ① ETIQUETTE DE CLASSIFICATION, PLACÉE A L'ARRIÈRE DU COFFRET | ② ETIQUETTE D'AVERTISSEMENT PLACÉE À L'INTERIEUR DE L'APPAREIL |
| ① KLASSIFIKATIELABEL, OP DE ACHTERZIJDE VAN HET APPARAAT | ② WAARSCHUWINGSLABEL, IN HET APPARAAT |
| ① ETIQUETA DE CLASIFICACIÓN, PEGADA EN LA PARTE POSTERIOR DE LA CAJA | ② ETIQUETA DE ADVERTENCIA, PEGADA EN EL INTERIOR DE LA UNIDAD |
| ① ETICHETTA DI CLASSIFICAZIONE, SITUATA SUL RIVESTIMENTO POSTERIORE | ② ETICHETTA DI AVVERTENZA, SITUATA ALL'INTERNO DELL'APPARECCHIO |

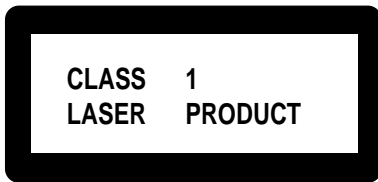

DANGER: Invisible laser radiation when open and interlock failed or defeated. AVOID DIRECT EXPOSURE TO BEAM. (e)	VARNING: Osynlig laserstrålning när denna del är öppenad och spärren är urkopplad. Betrakta ej strålen. (s)	AVVARSEL: Usynlig laserstrålning ved åbning, når sikkerhedsafbrydere er ude af funktion. Undgå udsættelse for stråling (d)	VARO: Avattaessa ja suo- jalukitus ohitettaessa olet alttiina näkymättömälle lasersäteilylle. Älä katso säteeseen. (f)
---	--	---	---

1. CLASS 1 LASER PRODUCT
2. **DANGER:** Invisible laser radiation when open and interlock failed or defeated. Avoid direct exposure to beam.
3. **CAUTION:** Do not open the top cover. There are no user serviceable parts inside the Unit; leave all servicing to qualified service personnel.

1. LASER-PRODUKT DER KLASSE 1
2. **GEFAHR:** Unsichtbare Laserstrahlung bei Öffnung und fehlerhafter oder beschädigter Sperr. Direkten Kontakt mit dem Strahl vermeiden!
3. **ACHTUNG:** Das Gehäuse nicht öffnen. Das Gerät enthält keinerlei Teile, die vom Benutzer gewartet werden können. Überlassen Sie Wartungsarbeiten bitte qualifizierten Kundendienst-Fachleuten.

1. PRODUIT LASER CLASSE 1
2. **ATTENTION:** Radiation laser invisible quand l'appareil est ouvert ou que le verrouillage est en panne ou désactivé. Eviter une exposition directe au rayon.
3. **ATTENTION:** Ne pas ouvrir le couvercle du dessus. Il n'y a aucune pièce utilisable à l'intérieur. Laisser à un personnel qualifié le soin de réparer votre appareil.



1. KLAS 1 LASERPRODUKT
2. **GEVAARLIJK:** Onzichtbare laserstraling wanneer open en de beveiliging faalt of uitgeschakeld is. Voorkom het direct blootstaan aan de straal.
3. **VOORZICHTIG:** De bovenkap niet openen. Binnenin het toestel bevinden zich geen door de gebruiker te repareren onderdelen: laat onderhoud over aan bekwaam vakpersoneel.

1. PRODUCTO LASER CLASE 1
2. **PELIGRO:** En el interior hay radiación láser invisible. Evite el contacto directo con el haz.
3. **PRECAUCIÓN:** No abra la tapa superior. En el interior de la unidad no existen piezas reparables por el usuario; deje todo servicio técnico en manos de personal calificado.

1. PRODOTTO LASER CLASSE 1
2. **PERICOLO:** Radiazione laser invisibile quando l'apparecchio è aperto ed il dispositivo di sicurezza è guasto o disattivato. Evitare l'esposizione diretta ai raggi.
3. **ATTENZIONE:** Non aprire il coperchio superiore. Non vi sono parti adoperabili dall'utente all'interno di questo apparecchio; lasciare tutti i controlli a personale qualificato.

Thank you for purchasing the JVC Compact Component System.
 We hope it will be a valued addition to your home, giving you years of enjoyment.
 Be sure to read this instruction manual carefully before operating your new stereo system.
 Here you will find all the information you need to set up and use the system.
 For questions that are not be answered in the manual, please contact your dealer.

Features

- Easy operation** Here are some of the things that make your CA-D672TR powerful and easy to use.
-  **COMPU PLAY**
- The controls and operations have been redesigned to make them very easy to use so you can spend your time listening to music.
 - With the One Touch Operation feature of JVC's **COMPU PLAY** you can turn on the CA-D672TR and start the radio, the Cassette Deck, or the CD Player with a single touch.
 - You can use the **MULTI CONTROL** stick to set the CD Player, Tuner, Timer, and Sound Mode operations.
- Great sound**
- To get such great sound from such a compact package the CA-D672TR has:
 - Programmed sound mode includes live surround effects **D. CLUB, HALL, and STADIUM**. It also includes S.E.A (Sound Effect Amplifier) effects **ROCK, POP, and CLASSIC**. You can also register up to three customized settings.
-  **RDS EON**
- CA-D672TR is compatible with RDS (Radio Data System) broadcasting.
 - The EON data enables you to standby for desired information.
 - The PTY Search function searches for programmes in the category you wish.
 In addition, Radio Text can be displayed using data sent by station.
- Triple Tray**
- CD changer function can operate 3 discs.
 - Discs can be changed during play using the **TRIPLE TRAY**.
 - Continuous, random or program play of 3 discs.
- Three timers**
- The three timers, **DAILY Timer, REC (Recording) Timer, and SLEEP Timer** are extremely easy to set.
 - The Displays are large and clear. They are organized so you can tell at a glance what's happening because functions light up as you use them, and blink to tell you they are ready. They provide some important messages like "NO DISC", and other informations.

How This Manual Is Organized

In this manual we have incorporated some special features:

- Basic information that is the same for many different functions is grouped in one place, and not repeated in each procedure. For instance, in the section on playing a CD, we do not repeat the information about setting the volume and the sound conditions, which are discussed in the Using the Amplifier section.
 - Name of buttons and controls are written in all capital letters like this: **SOUND MODE**.
 - When we are talking about the Function, rather than the **BUTTON** or **DISPLAY**, only the first letter is capitalized. The manual has a table of contents to help you quickly look up what you want to know.
- We've enjoyed making this manual for you, and hope you will use it to enjoy the sound and many features built into your CA-D672TR.

IMPORTANT CAUTIONS

1. **Installation of the Unit**
 - Select a place which is level, dry and neither too hot nor too cold. (Between 5°C and 35°C or 41°F and 95°F.)
 - Leave sufficient distance between the Unit and a TV.
 - Do not use the Unit in a place subject to vibrations.
2. **Power cord**
 - Do not handle the power cord with wet hands!
 - Some power (24 watts) is always consumed as long as the power cord is connected to the wall outlet.
 - When unplugging the Unit from the wall outlet, always pull the plug, not the power cord.
3. **Malfunions, etc.**
 - There are no user serviceable parts inside. If anything goes wrong, unplug the power cord and consult your dealer.
 - Do not insert any metallic object into the Unit.

Table of Contents

Features	1	To Play a Disc	20
How This Manual Is Organized	1	RESUME	20
IMPORTANT CAUTIONS	1	To Change Discs While Playing	20
		To Select a Disc, Track or Passage Within a Track	21
Getting Started	3	To Select a Track	21
Accessories	3	To Select a Passage Within a Track	21
How To Put Batteries In the Remote Control	3	Locating a Track With the Remote Control	
Using the Remote Control	3	Directly	21
Connecting the FM Antenna	4	Programming the Playing Order of the Tracks	21
Connecting the AM (MW/LW) Antenna	4	To Check the Program	23
Connecting the Speakers	5	To Modify the Program	23
Connecting a VCR	5	Random Play	23
DEMO Mode	6	Repeating a Selection or the Discs	24
COMPU PLAY	6	Tray Lock Function	24
Adjusting the Brightness of the Display	6	Locking the Electronic Lock	24
		Unlocking the Electronic Lock	24
Using the Amplifier	7	Using the Cassette Deck (Listening to a Tape)	25
Turning the Power On and Off	7	One Touch Play	26
Turning the CA-D672TR On	7	Regular Play	26
Turning the CA-D672TR Off	7	Fast Left and Fast Right	26
Adjusting the Volume	8	Music Scan	27
FADE MUTING Function	8	To Find the Beginning of the Current Selection ..	27
Balance adjustment	8	To Find the Beginning of the Next Selection ...	27
S.A. Bass Mode	8	Other Useful Features of the Cassette Deck	27
Sound Modes	9		
Selecting a Sound Mode	9	Using the Cassette Deck (Recording)	28
Customizing a Sound Mode	10	Things To Know Before You Start Recording ..	28
Auto Power Off	11	Standard Recording	29
Using a VCR	11	To Record Any Sound Source To Tape	29
Listening to a VCR	11	CD Direct Recording	30
Recording to a VCR	11	Auto Edit Recording	31
		Tape to Tape Recording (Dubbing)	32
Using the Tuner	12	How to Use the DUBBING Button	32
One Touch Radio	12	Using the Timers	33
Tuning In a Station	12	Setting the Clock	33
Switching between Frequency Bands	12	Setting the DAILY Timer	34
Selecting a radio station	13	Turning the DAILY Timer On and Off	36
Presetting Stations	13	Setting the REC (Recording) Timer	37
To Change the FM Reception Mode	13	Turning the REC Timer On and Off	38
Receiving FM Stations with RDS	14	Setting the SLEEP Timer	38
What Information RDS can Provide	14	Timer Priority	39
Changing the Display	15	Care And Maintenance	40
Searching for Programmes by PTY codes	15	Troubleshooting	41
EON Function	16	Specifications	42
ALARM function	17		
Using the CD Player	18		
The Quickest Way To Start a CD Is With			
the One Touch Operation	19		
Basics of Using the CD Player — Continuous Play	19		
To Insert Discs	19		

Accessories

Check that you have all of the following items, which are supplied with the CA-D672TR.

- AM (MW/LW) Loop Antenna (1)
- Remote Control (1)
- Batteries (2)
- FM Wire Antenna (1)

If any of these items is missing, contact your dealer immediately.

How To Put Batteries In the Remote Control

Match the polarity (+ and -) on the batteries with the + and - markings in the battery compartment.

R6P (SUM-3)/AA (15F)

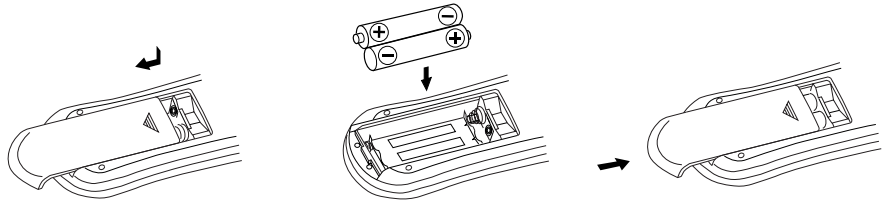

CAUTION: Handle batteries properly.

To avoid battery leakage or explosion:

- Remove batteries when the Remote Control will not be used for a long time.
- When you need to replace the batteries, replace both batteries at the same time with new ones.
- Don't use an old battery with a new one.
- Don't use different types of batteries together.

Using the Remote Control

The Remote Control makes it easy to use many of the functions of the CA-D672TR from a distance of up to 7m (23 feet) away.

You need to point the Remote Control at the remote sensor on the CA-D672TR's front panel.

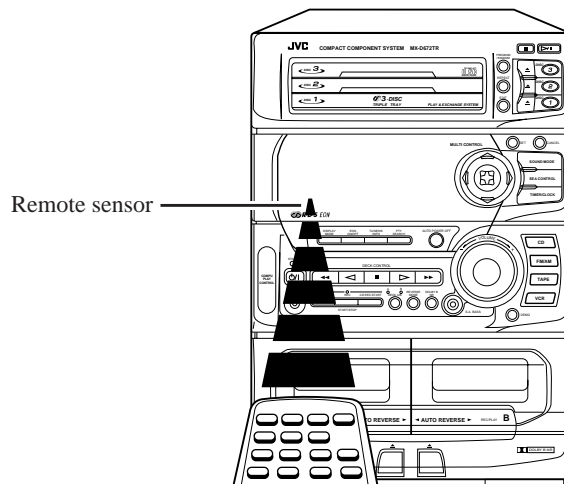

CAUTION: Make all connections before plugging the Unit into an AC power outlet.

Connecting the FM Antenna

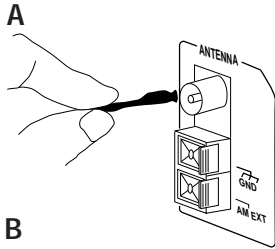

A. Using the Supplied Wire Antenna

The FM Wire Antenna provided can be connected to a FM 75-ohm COAXIAL as temporary measure.

Extend the supplied wire antenna horizontally.

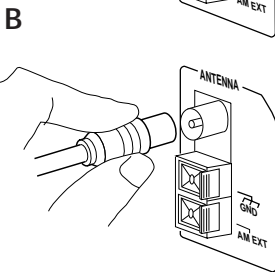

B. Using the Coaxial Type Connector (Not Supplied)

A 75-ohm antenna with coaxial type connector (DIN 45325) should be connected to the FM 75-ohm COAXIAL terminal.

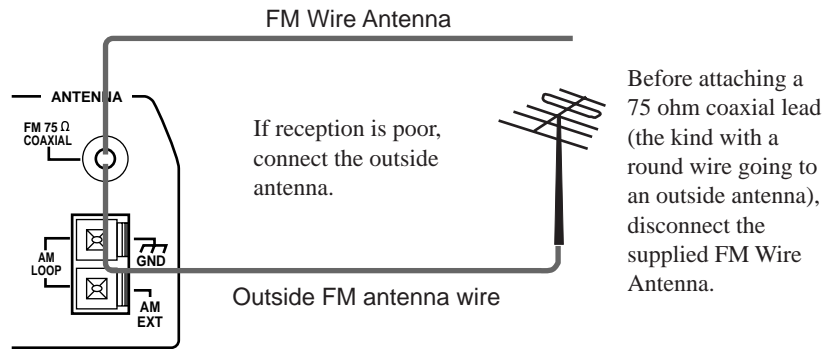

CAUTION: To avoid noise, keep antennas away from metallic parts of the CA-D672TR, connecting cord and the AC power cord.

Connecting the AM (MW/LW) Antenna

AM antenna wire (Not supplied)

If reception is poor, connect the outside antenna.

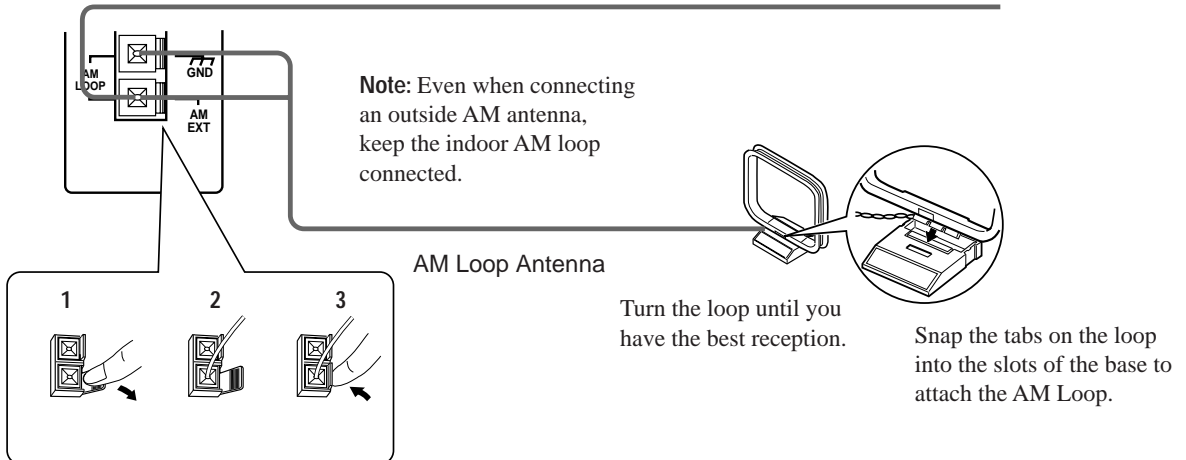

CAUTION: Make all connections before plugging the Unit into an AC power outlet.

Connecting the Speakers *(Please refer to instructions for speakers as will when you connect speakers.)*

For each speaker, connect one end of the speaker wire to the speaker terminals on the back of the CA-D672TR and the other end to the speaker.

1. Open each of the terminals and insert the speaker wires firmly (be sure to remove the insulation at the end of each wire first), then close the terminals.
2. Connect the red (+) and black (-) terminals of the right side speaker to the red (+) and black (-) terminals marked RIGHT on the CA-D672TR.
Connect the red (+) and black (-) terminals of the left side speaker to the red (+) and black (-) terminals marked LEFT on the CA-D672TR.

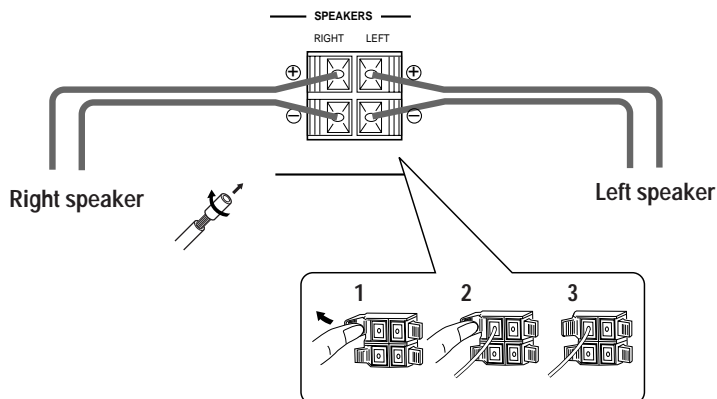

IMPORTANT: Use speakers with the correct impedance only. The correct impedance is indicated on the back panel.

CAUTION: If a TV is installed near speakers, the TV may display irregular colours. In this case, set the speakers away from the TV.

Connecting a VCR

Connect the VCR to the VCR terminal.

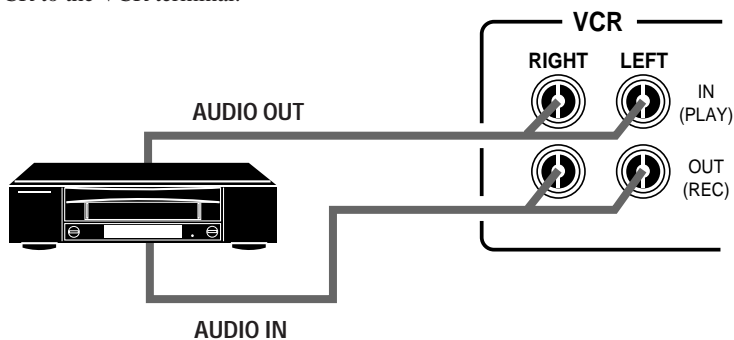

Now you can plug the AC power cord into the wall outlet, and your CA-D672TR is at your command!

DEMO Mode

When the CA-D672TR is connected to an AC power outlet, a DEMO mode displaying some of the system's features automatically starts.

The DEMO display cycles through the following items repeatedly.

- Scrolling display of "DEMO MODE START".
- Demo of MULTI CONTROL.
- Demo of Sound Modes.
- Demo of continuous play from DISC-1 to DISC-3.
- Scrolling display of "TUNER RANDOM 40CH PRESET".

To turn the DEMO display off, press any of the operation buttons. "DEMO OFF" appears on the display and the DEMO display automatically stops.



DEMO OFF

To turn the DEMO display on, press the DEMO button.

Notes:

- The DEMO display automatically starts when the power cord is inserted into a wall outlet.
- The DEMO display will not start if VCR is selected as a music source.

COMPU PLAY

COMPU PLAY is JVC's feature that lets you control the most frequently used functions of the CA-D672TR with a single touch.

One Touch Operation starts playing a CD, turns on the radio, plays a tape, etc. with a single press of the play button for that function. What One Touch Operation does for you is to turn the power on, then start the function you have specified. If the Unit is not ready, such as no CD or tape in place, the Unit still powers on so you can insert a CD or tape.

How One Touch Operation works in each case is explained in the section dealing with that function. The COMPU PLAY buttons are:

On the Unit

- CD button
- CD Player ▷/|| button
- CD Player DISC-1 to DISC-3 buttons
- CD Player Open/Close (▲) buttons
- FM/AM button
- TAPE button
- DECK CONTROL ◀, ▶ buttons
- VCR button

On the Remote Control

- TUNER button
- VCR button
- CD control ► button
- CD control DISC 1 to DISC 3 buttons
- CD control Open/Close (▲) buttons
- Deck control ◀, ► buttons

Adjusting the Brightness of the Display

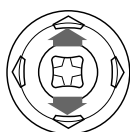

In Standby mode, you can adjust the brightness of the clock display.

Pressing the MULTI CONTROL stick in the upwards direction makes the display brighter.

Pressing the MULTI CONTROL stick in the downwards direction makes the display darker.

Using the Amplifier

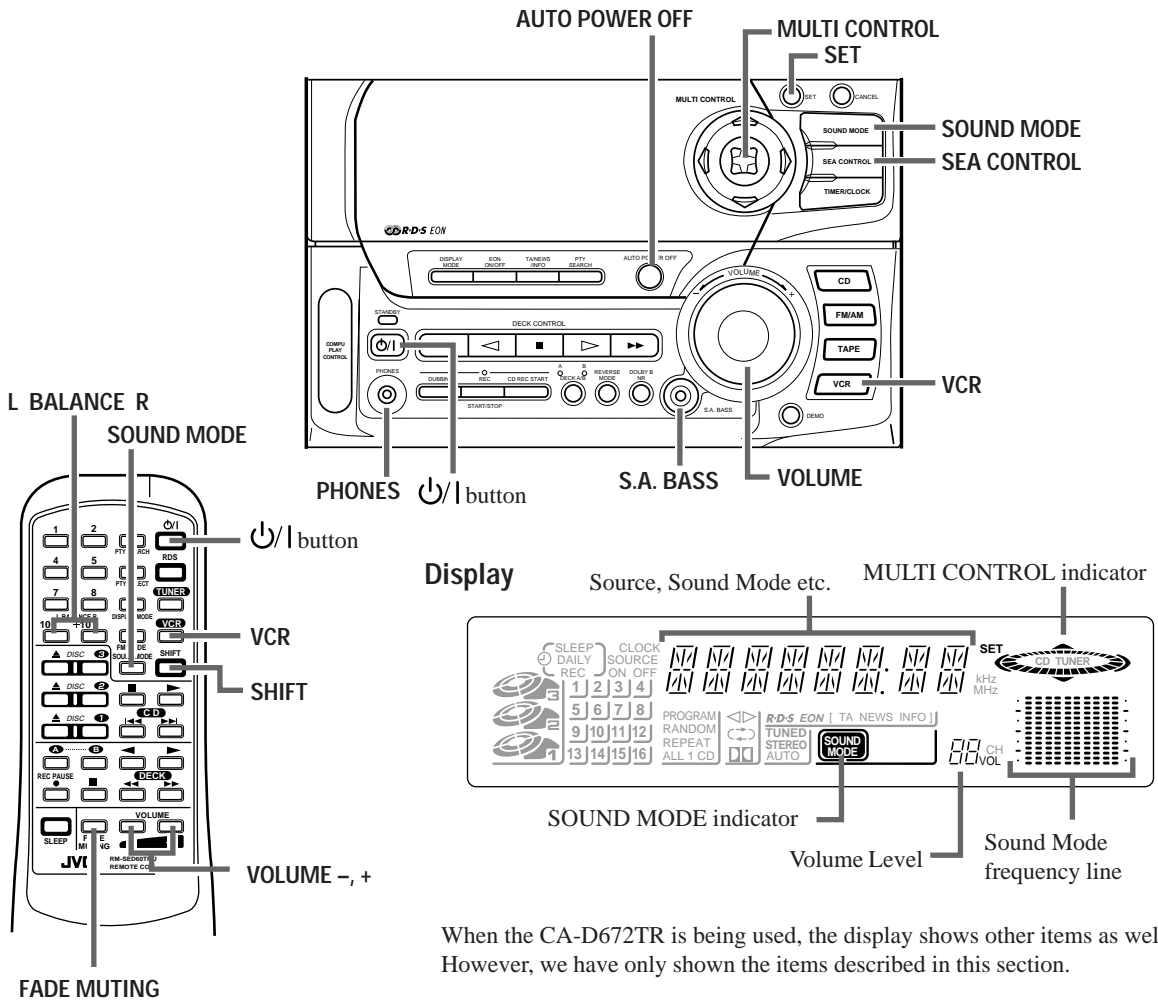

When the CA-D672TR is being used, the display shows other items as well. However, we have only shown the items described in this section.

Turning the Power On and Off

Turning the CA-D672TR On

Press the button.

The display comes on and the STANDBY indicator goes out.

The CA-D672TR comes on ready to continue in the mode it was in when the power was last turned off.

- If the last thing you were doing was listening to a tape in Deck B, you are now ready to listen to a tape again in Deck B, or you can change to another source.
- If you were listening to the Tuner last, the Tuner comes on playing the station it was last set to.

Turning the CA-D672TR Off

Press the button again.

The STANDBY indicator lights up and the display is blank, except for the clock display.

- Some power (24 watts) is always consumed even though power is turned off (called Standby Mode).
- To switch off the Unit completely, unplug the AC power cord from the AC outlet. When you unplug the AC power cord, the clock will be reset to 0:00 immediately, and preset Tuner stations will be erased after a few days.

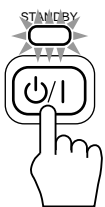

Adjusting the Volume

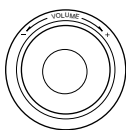

Turn the VOLUME control clockwise to increase the volume or anticlockwise to decrease it. Turning the VOLUME control quickly also adjusts the volume level quickly. When using the Remote Control, press the VOLUME + button to increase the volume or press the VOLUME – button to decrease it. You can adjust the volume level between 0 and 50.

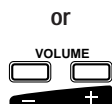

- ❑ When the CA-D672TR is turned on from Standby mode, the volume is set to 0 and automatically increases to the previous volume level. To stop this automatic volume adjustment, turn the VOLUME control slightly or press the VOLUME button on the Remote Control.

For private listening

Connect a pair of headphones to the PHONES jack. No sound comes out of the speakers. Be sure to turn down the volume before connecting or putting on headphones.



FADE MUTING Function

Set the Volume Level to 0 by pressing the FADE MUTING button on the Remote Control. Press this button again to restore the Volume Level to its previous level.

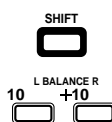

Balance adjustment

You can use the Remote Control to adjust the left and right balance of the speakers.

1. Press the SHIFT button.
2. Press the L BALANCE R buttons (10 or +10).
The display changes to show the balance adjustment.

L --- * --- R

Pressing the L button (10) moves the pointer to the left, pressing the R button (+10) moves the pointer to the right.

L |--- * --- R

Display when set for no
sound from the right speaker.

L --- * --- R

Display at the
centre position.

L --- * --- |R

Display when set for no
sound from the left speaker.

- ❑ The balance is normally set to the centre position.

Note: If no adjustments are made for 5 seconds in balance adjustment mode, the display reverts to the previous display. Once the balance adjustment is performed, the number keys on the Remote Control enter balance adjustment mode. To use the number keys for tuner, press the TUNER button. To use them for CD player, press the CD ► button.

S.A. Bass Mode

The richness and fullness of the bass sound is maintained regardless of how low you set the volume. The degree of bass is automatically controlled to suit the music source being played back. You can use this effect only for playback.

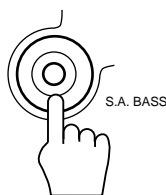

To get the effect, press the S.A. BASS (Signal Adaptive Bass) button repeatedly until the S.A. Bass mode you want appears on the display. The S.A. BASS indicator lights up.

→ SA BASS1 → SA BASS2 → OFF → (back to the beginning)

To cancel the effect, press the same button until “OFF” appears on the display. The S.A. BASS indicator goes out.

The CA-D672TR has some preset sound effects that give you control of the way your music sounds, so you can tailor it for your room and for the quality of the source. We can give you some idea of how each one affects the music, but the only way to really tell is to try them yourself. You can also create up to three of your own customized S.E.A. (Sound Effect Amplifier) settings and store them in the unit's memory.

- The preset sound modes include modes using surround effects and modes using S.E.A. effects.
- Sound Mode effects cannot be recorded.

Surround effect modes

- D. CLUB (Dance Club)** Increases resonance and bass.
- HALL** Adds depth and brilliance to the sound, like in a concert hall.
- STADIUM** Adds clarity and spreads the sound, like in an outdoor stadium.

S.E.A. effect modes

- ROCK** Boosts low and high frequencies.
- POP** Good for vocal music.
- CLASSIC** Set for wide and dynamic sound stereo systems.

Selecting a Sound Mode

Using the Unit

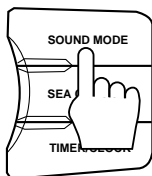

1. Press the **SOUND MODE** button.

The currently selected Sound mode appears on the display.

The **MULTI CONTROL** indicators light up to indicate the directions in which you can use the controller.

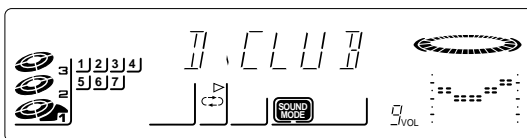

Note: If no adjustments are made for 5 seconds in Sound mode after the **SOUND MODE** button is pressed, the display reverts to the previous display.

2. Press the **MULTI CONTROL** stick to the left or right to select a Sound mode.

Use the **MULTI CONTROL** stick to select a Sound mode while sound mode is displayed. If the display reverts to the previous display, press the **SOUND MODE** button again and use the **MULTI CONTROL** stick to select a mode.

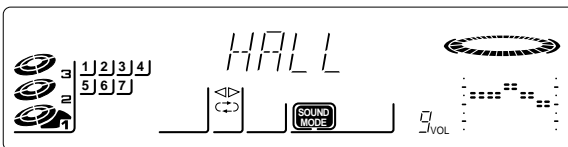
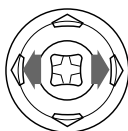

- The display also displays the frequency for the selected mode.

Moving the **MULTI CONTROL** stick to the right →
 ↔ D, CLUB ↔ HALL ↔ STADIUM ↔ ROCK ↔ POP ↔ CLASSIC ↔ MANUAL1 ↔ MANUAL2 ↔ MANUAL3 ↔ OFF ↔
 ← Moving the **MULTI CONTROL** stick to the left

To cancel **Sound mode**, select "OFF".

Unless sound mode "OFF" is selected, the red perimeter line around the **SOUND MODE** indicator is lit. If "OFF" is selected, the perimeter line goes out.



SOUND MODE ON



SOUND MODE OFF



Using the Remote Control

Press the **SOUND MODE** button.

The display changes with each press of the button as shown below.

→D, CLUB→HALL→STADIUM→ROCK→POP→CLASSIC→MANUAL 1→MANUAL 2→
MANUAL 3→OFF→ (back to the beginning)

Customizing a Sound Mode

You can change an existing sound mode to suit your own preferences. These changed settings can be stored in the CA-D672TR's sound mode memory.

1. Select the sound mode you want to change.

If you select D. CLUB, HALL, or STADIUM, the surround effect remains unchanged, but you can adjust the S.E.A. effect.

2. Press the SEA CONTROL button.

"SEA CONT" appears in the display, then the low tone section of the tone equalizer is displayed and the MULTI CONTROL indicators light up to indicate the directions in which you can use the controller.

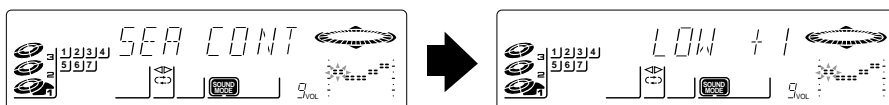
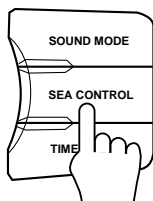

Note: If no adjustments are made for 5 seconds after the SEA CONTROL button is pressed, Sound mode appears on the display then reverts to the previous display.

3. Adjust the settings using the MULTI CONTROL stick.

- Adjust the level by adjusting the MULTI CONTROL stick up and down.
The level can be set between +3 and -3 in seven steps.

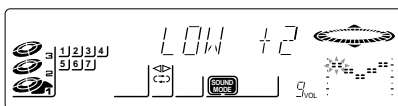

- Select the tone range by adjusting the MULTI CONTROL stick left and right.
You can select LOW, MID, or HIGH tones.

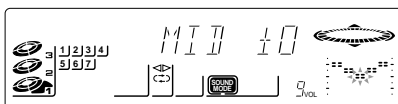
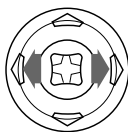

4. Press the SET button.

"MANUAL 1" appears on the display.

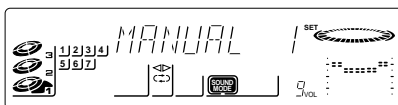

5. Select the memory number by adjusting the MULTI CONTROL stick left and right.

You can choose from "MANUAL 1" to "MANUAL 3".

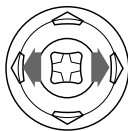

6. Press the SET button again.

"MEMORY" appears on the display and the settings are stored in the memory number selected.

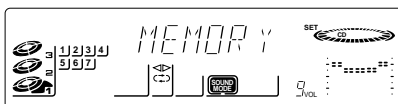

- The sound mode is set to the settings you have stored.
- If you store new settings to a memory number that has already been used, the new settings replace the existing setting.

Auto Power Off

When playing either a tape or a CD, Auto Power Off will shut the Unit off when the tape or CD comes to an end. Although Auto Power Off is very useful for shutting off the CA-D672TR at night, you can also use it if you think you might forget to turn the Unit off when leaving the house or your room at other times of the day.

AUTO POWER OFF



To Use Auto Power Off

Press the AUTO POWER OFF button, the AUTO POWER OFF button lights up.

To Cancel Auto Power Off

Press the AUTO POWER OFF button again, the AUTO POWER OFF button goes out.

Important Information On Using Auto Power Off

- ❑ The end of CD playback varies depending on the play mode of the CD Player. If the play mode is Continuous or “RANDOM”, when all tracks on the disc set in the CD player end, the power is automatically turned off. If the play mode is “PROGRAM”, the power is automatically turned off when the last track you programmed ends.
- ❑ Auto Power Off will still work even though you press the REPEAT button.
 - Repeat Mode (“REPEAT ALL” indicator lights up on the display):**
This automatically turns off the power after all the tracks on the CDs in the CD Player have been played.
 - Repeat 1 CD Mode (“REPEAT 1 CD” indicator appears on the display):**
This automatically turns the power off after all of the tracks on the CD have been played.
 - Repeat 1 Mode (“REPEAT 1” indicator lights up on the display):**
This automatically turns the power off after the selected track has been played.
- ❑ If you press the AUTO POWER OFF button while the tape is playing:
 - If Reverse Mode is off, the Unit turns off when the current side finishes.
 - If Reverse Mode is on, the Unit will turn off when the tape finishes playing in the ◀ direction.

Using a VCR

Listening to a VCR

By playing the sound from VCR through the CA-D672TR, you can gain control over how the music or program sounds. Once the connected equipment is playing through the CA-D672TR, you can apply the sound effects.

- ❑ First make sure that the optional equipment is properly connected to the CA-D672TR. (See page 5).

1. Set the VOLUME control to 0.

2. Press the VCR button.

When CA-D672TR is in Standby mode, the Unit is automatically turned on and “VCR” appears on the display.

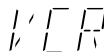

3. Start playing the equipment.

4. Adjust the VOLUME control to the desired listening level.

5. Select a sound effect mode, if you wish.

To Cancel the Setting

Change the source by starting any one of the CA-D672TR’s built-in sound sources, such as the Tuner or CD Player.

Recording to a VCR

To record to a VCR, start playback of the recording source of the CA-D672TR and start recording on your VCR. (Refer to the VCR’s instruction manual for details on the recording procedure for your VCR.)

- ❑ You cannot record using Sound mode effects.

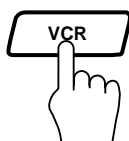

Using the Tuner

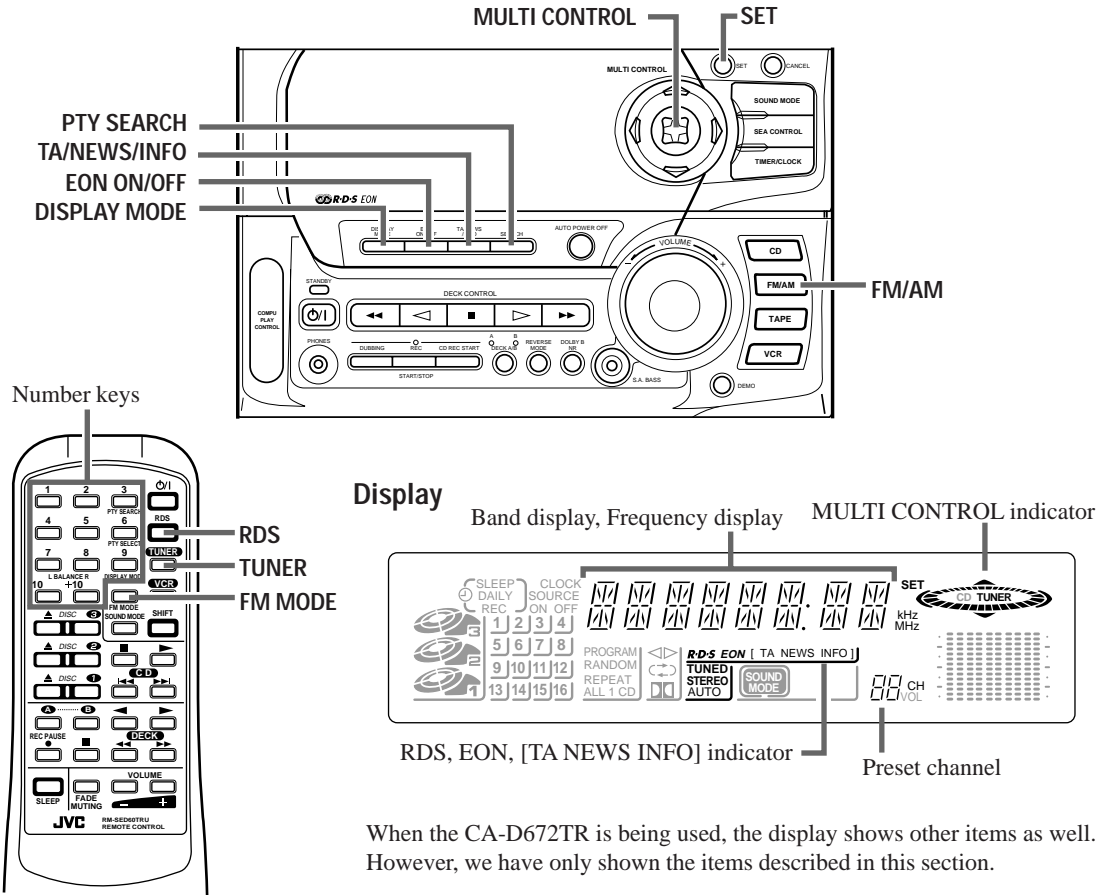

When the CA-D672TR is being used, the display shows other items as well. However, we have only shown the items described in this section.

You can listen to both FM and AM (MW/LW) stations. Stations can be tuned in manually, automatically, or from preset memory storage.

- Before listening to the radio:
 - Check that both the FM and AM (MW/LW) antennas are firmly connected. (See page 4).

One Touch Radio

Just press the FM/AM button (or the TUNER button on the Remote Control) to turn on the Unit and start playing the most recent station tuned in.

- You can switch from any other sound source to the radio by pressing the FM/AM button (or the TUNER button on the Remote Control).

Tuning In a Station

Press the FM/AM button (or the TUNER button on the Remote Control) to turn on the radio. The Frequency of the previously selected channel appears on the display.



Switching between Frequency Bands

Press the FM/AM button.

Each time you press the button, the band alternates between FM and AM (MW/LW).



Selecting a radio station

- ❑ Select a frequency by adjusting the MULTI CONTROL stick up or down. The frequency changes in one step increments. "TUNED" appears on the display when a signal is found. This is called Manual Tuning.
The frequency increases when MULTI CONTROL stick is pressed upwards, and decreases when the MULTI CONTROL stick is pressed downwards.
- ❑ If the MULTI CONTROL stick is pressed up or down continuously for a few seconds, the frequency changes continuously until a signal is found, then "TUNED" appears on the display. This is called Auto Tuning.
- ❑ Possible only after presetting stations.

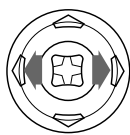

Using the Unit

Select a preset channel by adjusting the MULTI CONTROL stick left or right.

Using the Remote Control

1. Press the TUNER button so that you can receive the most recent station tuned in.
2. Select the station by entering the preset number in the number keys of the Remote Control.
 - ❑ Example: for channel 5, press 5. For channel 15, press +10 then 5. For channel 20, press +10, then 10. For channel 32, press +10 three times, then 2.



Presetting Stations

You can store up to 40 of your favourite radio stations (FM and AM (MW/LW)) in memory, giving you quick, easy access to the stations.

Note: In some cases, test frequencies have been already memorized for the tuner since the factory examined the tuner preset function before shipment. This is not a malfunction. You can preset the stations you want into memory by following the presetting method.



1. Select a frequency band by pressing the FM/AM button.

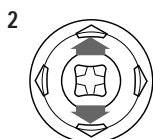

2. Tune to a station by adjusting the MULTI CONTROL stick up or down.



3. Press the SET button.

On the display, "SET" will blink for 5 seconds.

- ❑ During these 5 seconds while "SET" is blinking, you can assign a channel number to the station and enter it into the memory.

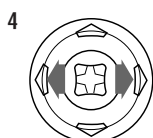

4. Select a preset number by adjusting the MULTI CONTROL stick left or right.

5. Press the SET button and the station will be assigned to the channel number showing on the display.

"MEMORY" appears in the display.

MEMORY

- ❑ If a station has been previously stored using the same channel number, this will be erased and the newly selected station will be stored.
- ❑ If "SET" in the display goes off, start again from step 3.



6. Repeat steps 1 - 5 for each station you want to store in memory with a preset number.

CAUTION: If the Unit is unplugged or if a power failure occurs, the preset stations will be erased after a few days. If this happens, preset the station again.

To Change the FM Reception Mode



When an FM stereo broadcast is hard to receive or noisy, press the FM MODE button on the Remote Control so that the "AUTO" indicator goes off in the display. Reception improves, but there are no stereo effects. In this monaural mode, noise comes out while tuning in stations (since muting is also cancelled).

To restore the stereo effect, press the FM MODE button on the Remote Control so that the "AUTO" indicator lights up. In this stereo mode, no noise comes out while tuning in stations, and you can hear stereo sounds when a program is broadcast in stereo.

Receiving FM Stations with RDS



RDS (Radio Data System) is a broadcasting service which a growing number of FM stations are now providing. It allows the FM stations to send additional signals along with their regular programme signals. For example, the stations send their station names and information about what type of programme they broadcast, such as sports or music, etc.

When tuned to an FM station which provides the RDS signal, the RDS indicator lights up and the station frequency (and then the station name if sent) is displayed.

One convenient RDS service is “Enhanced Other Networks (EON)”. This allows the Unit to automatically switch to a programme type of your choice when one starts in your broadcast area.

- ❑ Not all FM stations provide RDS service, nor do all RDS stations provide the same services. If in doubt, check with local radio stations for details on RDS services in your area.

Note: RDS may not work correctly if the station to which you are tuned is not transmitting properly or if the signal strength is weak.

What Information RDS can Provide

CA-D672TR can use the following RDS service.

PS (Program Service name)

Identifies each station by a name.

TA (Traffic Announcement Identification)

Identifies that a traffic announcement is being broadcast in your area.

RT (Radio Text)

Allows the RDS station to send text messages that appear on the display of the unit.

PTY (Programme Type)

Identifies the type of RDS programme. This allows you to locate a specific type of programme being broadcast.

The programme types are as follows:

TRAFFIC:	Traffic announcement
NEWS:	News
INFO:	Information.
POP M:	Pop music
ROCK M:	Rock music
M.O.R. M:	Middle-of-the-road music (usually called “easy listening”)
LIGHT M:	Light music
CLASSICS:	Classics
OTHER M:	Other music
AFFAIRS:	Topical programme expanding on current news or affairs
SPORT:	Sports events
EDUCATE:	Educational programmes
DRAMA:	Radio plays
CULTURE:	Programmes on national or regional culture
SCIENCE:	Programmes on natural sciences and technology
VARIED:	Other programmes like comedies or ceremonies
NONE:	Undefined
ALARM:	Emergency broadcasts

EON (Enhanced Other Networks)

Provides information available on RDS stations other than the one which is being received.

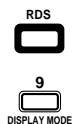
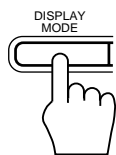

Changing the Display

You can see RDS information on the display.
 To view RDS information on the display, press the DISPLAY MODE button. (When using the Remote Control, press the DISPLAY MODE button after pressing the RDS button.)
 Each time you press the button, the display changes to show the following information:

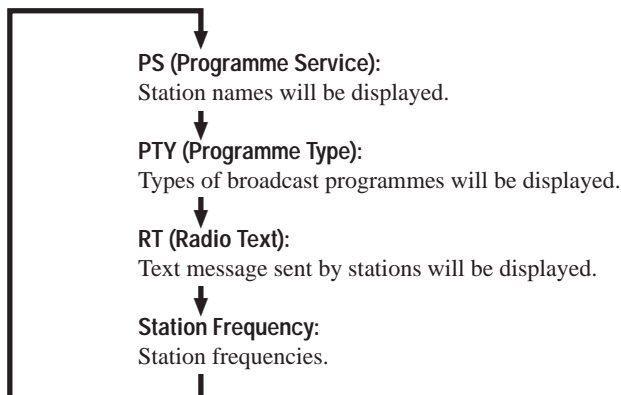

- ❑ While RDS information is being received from a station, “WAIT PS”, “WAIT PTY”, or “WAIT RT” may appear on the display.

Searching for Programmes by PTY codes

One of the advantages of the RDS service is that you can locate a particular kind of programme by specifying the PTY codes.

- ❑ The PTY Search function is applicable to preset stations only.

To search for a programme using the PTY codes, follow this procedure:
 Using the Unit

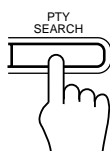
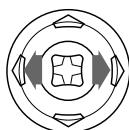
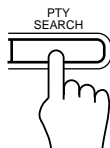

1. Press the PTY SEARCH button.

“PTY” and “SELECT” appear alternately on the display.

Note: If no adjustments are made for 5 seconds in PTY Search mode, the display reverts to the previous display. Perform the next step while “PTY” and “SELECT” are being displayed.

2. Press the MULTI CONTROL stick to the left or right to select a PTY.

The display changes with each press of the MULTI CONTROL stick as shown below:

Moving the MULTI CONTROL stick to the right →
 ↔ TRAFFIC ↔ NEWS ↔ INFO ↔ POPM ↔ ROCKM ↔ M.O.R.M ↔ LIGHTM ↔ CASSICS ↔
 OTHER M ↔ AFFAIRS ↔ SPORT ↔ EDUCATE ↔ DRAMA ↔ CULTURE ↔
 SCIENCE ↔ VARIED ↔
 ← Moving the MULTI CONTROL stick to the left

3. Press the PTY SEARCH button again.

While the search function is running, the selected programme type and “SEARCH” alternate on the display. The preset number also change.

Using the Remote Control

1. Press the RDS button.

2. Press the PTY SEARCH button.

“PTY” and “SELECT” appear alternately on the display.

Note: If no adjustments are made for 5 seconds in PTY Search mode, the display reverts to the previous display. Perform the next step while “PTY” and “SELECT” are being displayed.



3. Press the **PTY SELECT** button to choose a PTY.

- The programme type display changes with each press of the PTY SELECT button as shown below.
TRAFFIC → NEWS → INFO → POP M → ROCK M → M.O.R. M → LIGHT M → CLASSICS → OTHER M → AFFAIRS → SPORT → EDUCATE → DRAMA → CULTURE → SCIENCE → VARIED → (back to the beginning)



4. Press the **PTY SEARCH** button again.

While the search function is running, the selected programme type and “SEARCH” alternate on the display. The preset number also change.

Once the station which is broadcasting the selected PTY (Programme Type) is located, searching will stop. Then the station name (if PS code is being sent) will be indicated and the broadcast will commence. The Display will stay blinking for 10 seconds from the end of the searching function. If you press the PTY SEARCH button again during this period, search for the same PTY (Programme Type) will restart.

The PTY Search function is completed when the indicated preset Number changes from blinking to continuously lit.

- If a station broadcasting a selected PTY(Program Type) cannot be found, “NOT” and “FOUND” are displayed alternately on the display after the Unit has searched through the preset numbers. The Unit will then return to the station to which it was tuned prior to the start of the PTY Search.

To cancel a PTY Search operation, use the PTY SEARCH button and MULTI CONROL stick to select another function.

Note: PTY Search can be used even while AM (MW/LW) broadcasts are being received.

EON Function

With the EON (Enhanced Other Networks) code, the Unit can perform a standby reception which will enable you to obtain desired information which is available from other stations.

- “EON” will be displayed while receiving stations with an EON code.
- EON Standby reception is applicable for preset stations only.
- You can set EON Standby reception regardless of types of receiving bands.

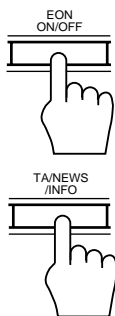

Setting EON Standby reception

1. Press the **EON ON/OFF** button.

[TA NEWS INFO], or the last EON information type selected, is displayed.

2. Select information you want by pressing the **TA/NEWS/INFO** button.

TA: Identifies that a traffic announcement is being broadcast in your area.

NEWS: News

INFO: Programs on medical service, weather forecast, etc.

- With each pressing of the TA/NEWS/INFO button, indications will change as follows:

[**TA**] → [**NEWS**] → [**INFO**] →
 [**TA NEWS**] → [**NEWS INFO**] → [**TA INFO**] →
 [**TA NEWS INFO**] → (back to the beginning)

As soon as your selection is entered the Unit will go into EON Standby reception mode.

If you want to cancel the EON function, turn off the [TA NEWS INFO] indicator by pressing the EON ON/OFF button.

When this Unit carries out EON Standby reception, the indication will change as follows:

1. Waiting for EON Standby reception

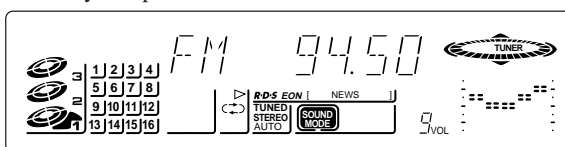

2. Preset stations are being searched for and while preparing to change the station, sound will be muted.

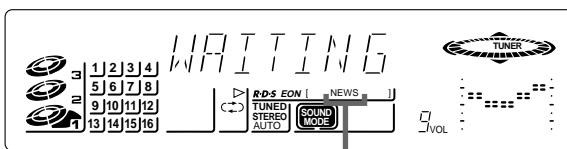

Blinking

3. The station will be changed and the programme type being received will appear on the display.

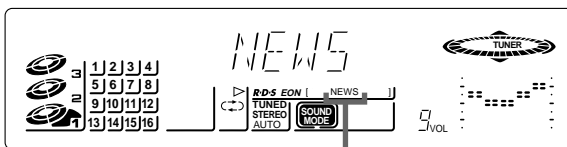

Blinking

- When using the DISPLAY MODE button to change the display, use the appropriate setting for the type of display.

Notes:

- EON broadcasts of some stations may not be compatible with this Unit. In the case of an incompatible EON broadcast, “EON” will not appear on the display.
- While the Unit is receiving information for an EON code you have selected for EON Standby, you cannot use the following operations: MULTI CONTROL stick, TA/NEWS/INFO button or PTY SEARCH button. In addition, if a station transmits information for a programme type you have selected without sending the EON code, the EON Standby operation is still performed. Therefore, you will not be able to use the operations listed above during this period.
- If the reception is unsatisfactory for a station among the preset stations, “WAITING” appears on the display and the station is searched for again. If after searching through the channels five times, the broadcasting station cannot be found, “NOT” and “FOUND” are displayed alternately on the display. The Unit will then return to the station to which it was previously tuned.

When broadcasting of the desired information has been completed, “EON END” will be indicated and the Unit will automatically go back to the station which had previously been tuned to.

- While receiving information on EON Standby reception, the station will not change to other stations even if the same information is available from them.
- If you cancel the EON function when in EON Standby reception mode by either pressing the EON ON/OFF button, the Unit will automatically return to the station which had been previously tuned-in.

If the information you are waiting for is available from the current station, the indicator will blink.

ALARM function

If an ALARM (Emergency) signal is received while receiving an EON code from a station, “ALARM” blinks on the display and the Unit automatically switches to the station broadcasting the ALARM signal.

When an ALARM broadcast of PTY is being received from the currently tuned-in station, “ALARM” will blink on the display for your attention.

Using the CD Player

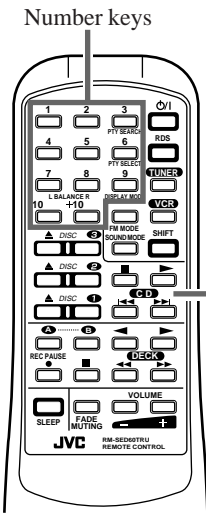
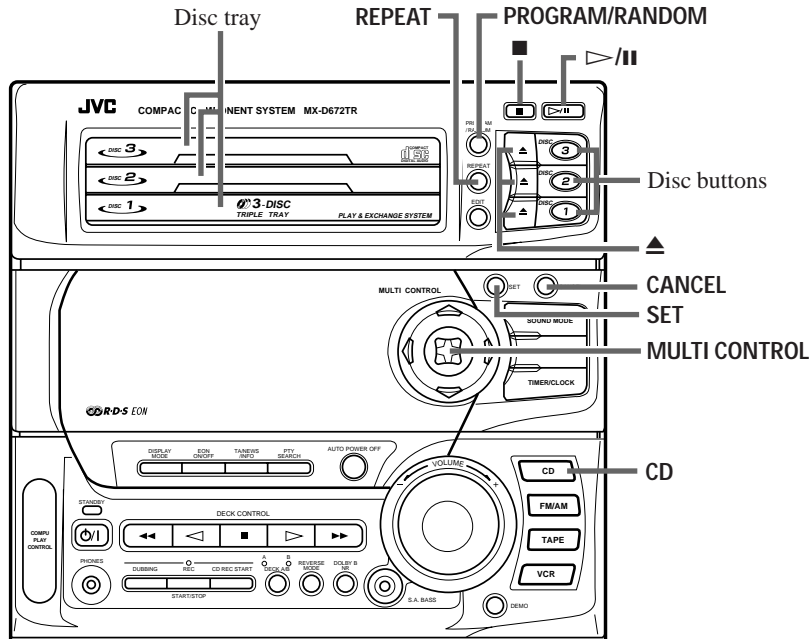

Display

Disc display Track number, Playing time, step number

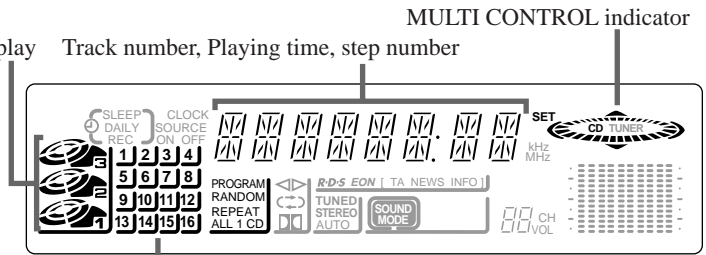

All track numbers of the loaded CD

When the CA-D672TR is being used, the display shows other items as well. However, we have only shown the items described in this section.

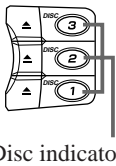

DISC indicator

Each of the Disc buttons acts as an indicator.

The indicator is off when the CD Player is checking that there is no disc in the disc tray for the corresponding disc number.

Pressing the button turns the indicator on.

During playback, the disc indicator for the disc being played flashes.



Disc display

A red marker lights on the disc display for the disc number you have selected. This disc display blinks while a CD is being played.

The centre of the disc display is not lit while CD Player is checking that there is no disc in the disc tray for the corresponding disc number.

The CA-D672TR's CD Player has an Automatic Changer with 3 disc trays. You can use Continuous, Random, Program or Repeat Play for the discs in DISC-1, DISC-2 and DISC-3. Repeat Play can repeat all the tracks on all the CD's, the tracks on one of the CD's or one track on one CD. There is also the Tray Lock function, which safely keeps discs in the trays.

Here are the basic things you need to know to play a CD and locate the different selections on it. Each selection is called a track, so when we are talking about locating a track, we are also talking about how you find a certain song or performance.



The Quickest Way To Start a CD Is With the One Touch Operation

The power comes on, and operations are done automatically.

- Press the CD or button (or the button on the Remote Control).
 - If there is a CD in the disc tray of the selected (lit) disc number, playback continues from the track where it was interrupted.
 - If there is no CD in any of the disc trays, the message "OPEN" appears in the display after a few seconds and the disc tray for the marked disc opens.
- Press a DISC button (1 to 3).
 - If there is a CD in the disc tray for the disc number you have selected, playback begins from the first track of that disc. If there is no CD in the disc tray, the message "OPEN" appears in the display after a few seconds and the disc tray opens.
- Press the button.
 - The power turns on, and the tray opens automatically.

Basics of Using the CD Player — Continuous Play

You can play the discs continuously in the DISC 1 to DISC 3 trays.



or



To Insert Discs

1. Press the button on the left of the Disc button you want to insert the disc into.
The disc tray slides out automatically.
2. Place a CD, with its label side up, onto the tray.

ATTENTION: To avoid malfunctions when you play a CD, please set the CD in the right place at the centre of the tray.

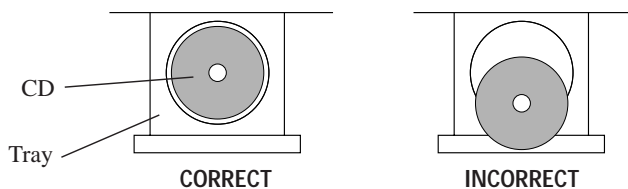

3. Press the button to close the tray.
4. Repeat steps 1 to 3 to insert other discs into other trays.
 - To continue putting discs into other trays, even if a tray is open, by pressing the button of another disc tray, the open tray will close automatically, and the new disc tray will slide out.

- To put an 8 cm CD into a tray, insert it so that it is aligned with the groove in the tray's centre.
- "OPEN" appears in the display when a tray opens, and "CLOSE" when a tray closes.
- If a tray is open when the CA-D672TR switches to Standby mode, the tray is closed automatically.

Note: When the CD Player is reading a disc, " - - - " appears in the display. While this is being displayed, the button or DISC button cannot be used. Once the display changes from " - - - " to another display, the button and DISC button can be used.

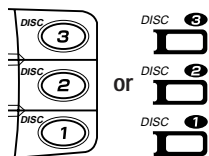

To Play a Disc

This function plays the disc in the Unit continuously.

1. Prepare the discs.

2. Press the DISC button (1-3) of the disc you want to play.

The first track of the selected disc will begin playing.

When the selected disc finishes playing, the next disc will begin playing automatically.

When the last disc has finished playing, the Unit will stop automatically.

- When a DISC button is pressed while a tray is open, the open tray will close automatically and Continuous Play from the first track of the disc.

To use Continuous Play from the first track of the disc selected by the disc marker, you do not need to press a DISC button (1-3), just press the ▷/|| or CD button (or ► button on the Remote Control).

Playing order of discs

- When playback starts from DISC-1, the playing order is DISC-1 → DISC-2 → DISC-3. When DISC-3 has finished, the CD Player selects DISC-1 (the disc marker is on) and stops.
- When playback starts from DISC-2, the playing order is DISC-2 → DISC-3 → DISC-1. When DISC-1 has finished, the CD Player selects DISC-2 (the disc marker is on) and stops.
- When playback starts from DISC-3, the playing order is DISC-3 → DISC-1 → DISC-2. When DISC-2 has finished, the CD Player selects DISC-3 (the disc marker is on) and stops.
 - If any of the disc trays are empty, the CD Player skips that disc tray and continues through the remaining disc trays in the order shown above.

Note: If there is no CD in disc tray for the DISC button you pressed, the message “OPEN” appears in the display and the disc tray automatically opens. If there is no disc in the disc tray for the selected disc number, when the ▷/|| or CD button (or the ► button on the Remote Control) is pressed, playback begins from the next disc.

To stop play the disc, press the ■ button.

To stop play and remove the disc, press the ▲ button for the disc being played.

To pause, press the ▷/|| button. The Disc display will blink. (The Pause function cannot be used with the ► button on the Remote Control.)

To cancel pause, press the ▷/|| button again (or press the ► button on the Remote Control). Play continues from the point where it was paused.

RESUME

When the ■ button is pressed during playback, and the source is changed, the track number is memorized even when the power is turned off. The next time the ▷/|| or CD button (or the ► button on the Remote Control) is pressed, play resumes from the track where it was interrupted.

- To start playback from the first track, press the DISC button.

To Change Discs While Playing

You can replace a CD in a tray not being used, while another CD is playing.

1. Press the ▲ button of the tray not being used.

The tray opens.

2. Replace the disc in the tray.

3. Press the ▲ button to close the tray.

To Select a Disc, Track or Passage Within a Track

Press the **DISC** button (1-3) for the disc tray containing the track you want to listen to.

Playback starts from the first track of the disc you selected.

- Example: for the third disc, press 3.

To Select a Track

Using the Unit

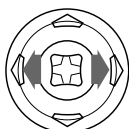

Select a track by adjusting the **MULTI CONTROL** stick left or right.

- The **MULTI CONTROL** stick adjustments step through the tracks on the CD one track at a time.
 - Moving the **MULTI CONTROL** stick to the right selects the next track.
 - Moving the **MULTI CONTROL** stick to the left select the previous track.
- If the **MULTI CONTROL** stick is held down continuously, the CD Player skips through the tracks on the CD continuously in the selected direction.

Using the Remote Control

Press the **◀◀** or **▶▶** button to select the track.



- Each time you briefly press and release the **◀◀** or **▶▶** button, the track changes by one.
 - Press and release the **▶▶** button to go ahead one track at a time.
 - Press and release the **◀◀** button to go back one track at a time.
- Holding down the **◀◀** or **▶▶** button allows you to change tracks continuously.

To Select a Passage Within a Track

While a CD is playing, press the **MULTI CONTROL** stick up or downwards continuously.



- If the **MULTI CONTROL** stick is pressed upwards the CD is played forwards quickly, if the controller is press downwards the CD is played backwards quickly. Release the controller when the CD reaches the passage you want to hear.

Note: You cannot perform these fast forwards or fast backwards operation with the remote control.

Locating a Track With the Remote Control Directly

Using the number keys on the Remote Control allows you to go directly to the beginning of any track.

1. Press the **DISC** button (1-3) for the disc tray containing the track you want to listen to.

- Example: for the third disc, press 3.

2. Enter the number of the track you want to listen to with the number keys.

The selected track starts playing.

- Example: for track 5, press 5. For track 15, press +10 then 5. For track 20, press +10, then 10. For track 32, press +10 three times, then 2.

Programming the Playing Order of the Tracks

You can change the order in which the discs and tracks play, and select only the discs and tracks you want from among those loaded in the CD Player.

- You can program up to 32 steps in any desired order from among the discs in the player.
- You can only make or change a program when the CD Player is stopped.

Using the Unit

PROGRAM
/RANDOM



1. Press the **PROGRAM/RANDOM** button.

The message "PROGRAM" appears on the display and the **PROGRAM** indicator comes on.

If you have already created a program, the last step of the previous program is displayed.

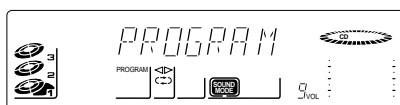

- The display changes with each press of the **PROGRAM/RANDOM** button, as shown below.
→ **PROGRAM** → **RANDOM** → Off (Continuous Play) → (back to the beginning)

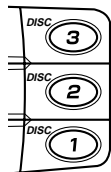

2. Select a disc with the DISC buttons (1 to 3).

The display changes to the Program Entry display and the disc number and track number sections blink for a few seconds.

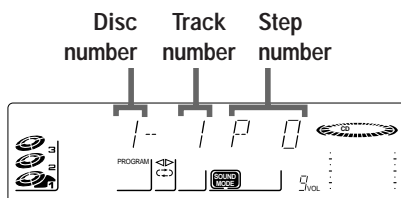

- While the display is blinking, perform the operations in steps 3 to 4. When the blinking display changes to the “PROGRAM” display, repeat the operations in steps 2 to 4.

3. Select a track for the program by adjusting the MULTI CONTROL stick left or right.

The track number appears on the display.

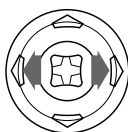

4. Press the SET button.

The blinking disc number and track number changes to a steady light, and the step number is displayed.

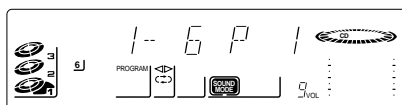

5. Repeat steps 2 to 4 to select the other tracks for the program.

- To select another track from the same disc, repeat the procedure from step 3.

6. Press the ▷/|| or CD button.

The Unit plays the tracks in the order you have programmed them.

Using the Remote Control

1. Press the PROGRAM/RANDOM button on the Unit.

The message “PROGRAM” appears in the display and the PROGRAM indicator comes on. If you have already created a program, the last step of the previous program is displayed.

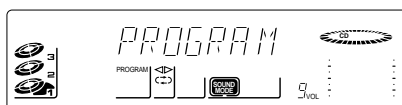

- The display changes with each press of the PROGRAM/RANDOM button, as shown below.
→ PROGRAM → RANDOM → Off (Continuous Play) → (back to the beginning)

2. Select a disc with the DISC buttons (1-3).

The display changes to the Program Entry display and the disc number and track number sections blink for a few seconds.

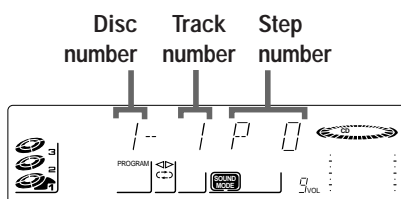

- While the display is blinking, perform the operations in step 3. When the blinking display changes to the “PROGRAM” display, repeat the operations in steps 2 to 3.

3. Press the number keys (1 to 10 and +10) to select the track to program.

- ❑ Example: For track 5, press 5. For track 15, press +10 then 5. For track 20, press +10 then 10. For track 32, press +10 three times, then 2.

The blinking disc number and track number changes to a steady light, and the step number is displayed.

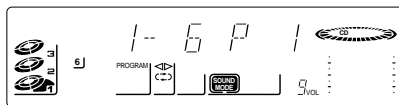

4. Repeat steps 2 to 3 to select the other tracks for the program.

5. Press the ► button.

The Unit plays the tracks in the order you have programmed them.



- ❑ If you try to program a 33rd step, the CA-D672TR lets you know that the program is full by displaying the message “FULL” on the display.
- ❑ If you try to program an disc tray that is empty, or a track number that does not exist on a disc (for example, selecting track 14 on a disc that only has 12 tracks), the selected disc or track are skipped when the program is played.
- ❑ You can skip to a particular program step during program play. To do this from the unit, move the MULTI CONTROL stick left or right, to do so from the remote control press the ◀◀ or ▶▶ buttons.
- ❑ To play the programmed tracks over and over, press the REPEAT button. The Repeat mode indicators light up in sequence with each press of the REPEAT button.

To stop playing, press the ■ button.

To delete all the tracks in a program, keep pressing the CANCEL button on the Unit until all the tracks in the program have been deleted, or press the ▲ button for each disc in the program.

To exit Program Mode, press the PROGRAM/RANDOM button twice to change to Continuous Play mode.

To Check the Program

While the CD Player is stopped, use the ◀◀ or ▶▶ buttons on the remote control to check the contents of the program.

Each time you press the ▶▶ button, the program contents are shown on the display in the programmed order. Pressing the ◀◀ button displays the previous step in the program.

To Modify the Program

Modify the contents of a program while the CD Player is stopped.

Press the CANCEL button on the Unit, the last track in the program is deleted.

Each time you press the button, the last track listed in the program is deleted from the program.

To add a track to the program, follow the procedure above (on either the Unit or the Remote Control). The new tracks are added to the end of the program.

Random Play

The tracks will play in no special order when you use this mode.

1. Press the PROGRAM/RANDOM button while the CD Player is stopped to change to the Random Mode display.



- ❑ The display changes with each press of the PROGRAM/RANDOM button, as shown below.
→ PROGRAM → RANDOM → Off (Continuous Play) → (back to the beginning)

2. Press the ▷/|| or CD button (or the ► button on the Remote Control).

The tracks are played in random order.

When all of the tracks have been played, the CD Player stops.

Note: Press the DISC buttons (1-3), or the number keys, to cancel Random play and begin playback in Continuous Play mode.

- ❑ Press the REPEAT button before or during random play to instruct the CA-D672TR to continue with a different random track selection after the last selection is played.

To cancel random play, press the ■ button, then press the PROGRAM/RANDOM button to select another mode.

Repeating a Selection or the Discs

You can have all the discs, the program or the individual selection currently playing repeat as many times as you like.



Press the REPEAT button on the CA-D672TR.

The display changes with each press of the button, as shown below.

→ REPEAT ALL → REPEAT 1 CD → REPEAT 1 → blank display → (back to the beginning)

REPEAT ALL: Repeats all the tracks on the CD's in the CD Player, or all the tracks in the program.

REPEAT 1 CD: Repeats all the tracks on one CD.

REPEAT 1: Repeats one track on a CD.

- ❑ "REPEAT ALL" and "REPEAT 1" remain on the display even when you change the play mode.
- ❑ The three Repeat Modes above can be selected during Continuous Play, however, during Program Play and Random Play, you can only select REPEAT ALL or REPEAT 1.

To exit Repeat Mode, press the REPEAT button until the Repeat mode indicator on the display goes out.

Tray Lock Function

In order to safely keep the discs in the CD Player, the three trays can be electronically locked in a single operation.

When the electronic lock is on, the trays cannot be opened even if the ▲ button is pressed.

This function can only be accessed by using the buttons on the Unit itself.

Locking the Electronic Lock

1. Put the CA-D672TR's power into STANDBY mode.
2. While pressing the ■ button, press the ▲ button for DISC 1's tray on the Unit.

"LOCKED" appears on the display to let you know that the trays have been locked.

L O C K E D

When the CD Player trays are locked, pressing the ▲ buttons displays the message "LOCKED" on the display and the trays do not open. But, the ▲ button can be used to automatically turn on the power.

Unlocking the Electronic Lock

1. Put the CA-D672TR's power into STANDBY mode.
 2. While pressing the ■ button, press the ▲ button for DISC 1's tray on the Unit.
- When the unlock operation is done, "UNLOCKED" appears in the display to show that the lock has been taken off.

U N L O C K E D

The trays can now be opened by pressing the ▲ buttons.

The ▲ button can also be used to automatically turn on the power.

Using the Cassette Deck (Listening to a Tape)

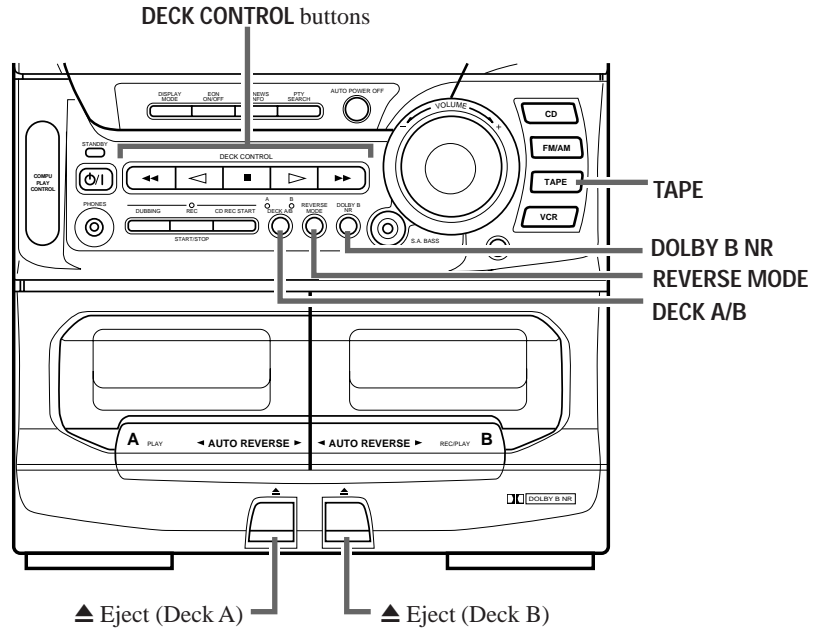

Display

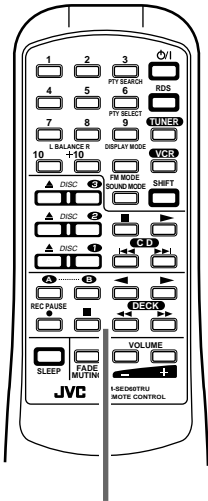

Cassette Deck control buttons



- ◀▶ : Tape Direction indicator
- ↺↻ : Reverse Mode indicator
- DB : DOLBY B NR indicator

Tape Direction Indicator on the Display

The Tape Direction indicator tells you which direction the selected tape deck will use for playback. During playback, the direction indicator blinks slowly. During fast left or fast right, the indicator blinks quickly. During Music Scan mode, the direction indicator alternates between blinking slowly and quickly repeatedly.

When the CA-D672TR is being used, the display shows other items as well. However, we have only shown the items described in this section.

The Cassette Deck allows you to play, record and dub audio tapes.

- ❑ Most tapes are now recorded with the Dolby NR system, so first check which type of the Dolby NR system has been used on the tape. Only Dolby B NR is incorporated into the CA-D672TR.
- ❑ With Automatic Tape Detection, you can listen to type I or II tapes without changing any settings.

The use of tapes longer than 120 minutes is not recommended, since characteristic deterioration may occur and these tapes easily jam in the pinch-rollers and the capstans.



One Touch Play

- ❑ Press the TAPE button.
The power comes on and “TAPE” lights up on the display . If there is a tape in the deck corresponding to the Deck Indicator DECK A/B, that tape starts to playback. If there is no tape in the deck corresponding to the Deck Indicator, the CA-D672TR automatically turns on the power and displays “TAPE” then the message “NO TAPE” and waits for you to insert a tape or select another function.
- ❑ Press the ◁ or ▷ button (or the ◀ or ▶ button on the Remote Control).
The power comes on and “TAPE” appears in the display. When a tape is already in the tape deck, the tape is played in the direction of the button pressed. If there is no tape in the deck corresponding to the Deck Indicator, the CA-D672TR automatically turns on the power and displays “TAPE” then the message “NO TAPE” and waits for you to insert a tape or select another function.

Regular Play

If the power is already on, you can use this basic procedure:

1. Press the ▲ button for the deck you want to use.
2. When the cassette holder opens, put the cassette in, with the exposed part of the tape down, toward the base of the CA-D672TR.
 - ❑ If the cassette holder does not open, turn the Unit off, then back on and press the ▲ button again.
3. Close the holder gently.
When both Deck A and Deck B contain a tape, the last deck to have a tape inserted is selected. To change the selected deck, press the DECK A/B button.
When using the Remote Control, press the A or B button.
4. Press the ◁ or ▷ button (or ◀ or ▶ button on the Remote Control).
The tape is played in the direction of the button pressed for the selected deck.
 - ❑ The Cassette Deck automatically stops when one side of a tape has finished playing.

To stop playing, press the ■ button.

To remove the tape, stop the tape, and press the ▲ button.

To change deck while playing a tape, press the ◁ or ▷ button after pressing the DECK A/B button on the Unit or press the ◀ or ▶ button after pressing the A or B button on the Remote Control.



Fast Left and Fast Right

- ❑ While the tape is stopped, press the ◀◀ button and the tape will wind rapidly onto the left side of the cassette without playing.
- ❑ While the tape is stopped, press the ▶▶ button and the tape will wind rapidly onto the right side of the cassette without playing.

Note: Deck A and Deck B cannot be used for playback at the same time.

Music Scan

To find the beginning of a music track during play, use the Music Scan function. Music Scan searches for blank portions that usually separate selections, then plays the next selection.

To Find the Beginning of the Current Selection

Press the ◀◀ or ▶▶ button during play.

- ❑ Make sure that you press the ◀◀ or ▶▶ button in the opposite direction to that in which the tape is playing. Searching stops at the beginning of the current selection, and the current selection starts automatically.

To Find the Beginning of the Next Selection

Press the ◀◀ or ▶▶ button during play.

- ❑ Make sure that you press the ◀◀ or ▶▶ button in the same direction as that in which the tape is playing. Searching stops at the beginning of the next selection, and the next selection starts automatically.

Music Scan works by detecting a 4-second long blank at the beginning of each selection, so it won't work well if your tape has:

- No blank at the beginning of a selection .
- Noise (often caused by much use or poor quality dubbing) which fills the blank with noise.
- Long, very soft passages or pauses in a selection. The scan will detect these as 4-second long blanks. If this happens, just scan again until you reach the selection you want.

Other Useful Features of the Cassette Deck



- ❑ Use **Reverse Mode** to make the tape automatically reverse at the end of a side and start playing the other side. Press the REVERSE MODE button to change from Reverse Mode on to Reverse Mode off, or from off to on.



Reverse Mode ON



Reverse Mode OFF



- ❑ **Continuous Play:** With the Reverse Mode indicator on, when tape playback in the ◀ direction finishes, the Unit always checks to see if a tape is in the other deck. If there is, it automatically starts playing. This Continuous Play function works regardless of which deck starts first.
- ❑ Press the DOLBY B NR button to switch Dolby B Noise Reduction on (the indicator lights up) or off (the indicator goes off). If a tape is recorded with the Dolby B NR system, playing it back with the Dolby NR on will reduce tape noise and improve the clarity of the sound.

Dolby noise reduction manufactured under license from Dolby Laboratories Licensing Corporation.
 “DOLBY” and the double-D symbol are trademarks of Dolby Laboratories Licensing Corporation.

Using the Cassette Deck (Recording)

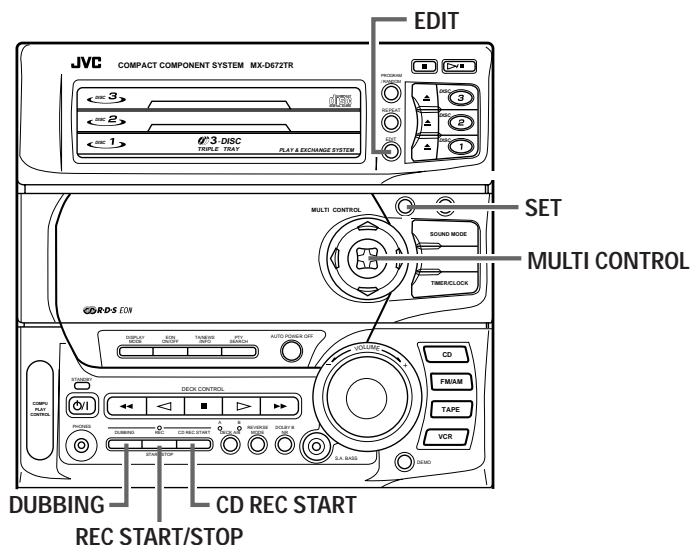

Recording onto a cassette from any of the sound sources is simple. Just place a tape in Deck B, have the source ready, make one or two settings, and you're ready to record. For each source the procedure is a little different and now we'll explain just what to do for each one. If you forget, just come back to the section which has the specific procedures you need. But first, here are a few things to make your recordings better.

Things To Know Before You Start Recording

- ❑ It should be noted that it may be unlawful to re-record pre-recorded tapes, records, or discs without the consent of the owner of copyright in the sound or video recording, broadcast or cable programme and in any literary, dramatic, musical, or artistic embodied therein.
- ❑ Press the DOLBY B NR button — the indicator lights up — to reduce tape hiss, except when dubbing tapes, since Dolby NR is inactive in Dubbing Mode regardless of the setting of DOLBY B NR. The dubbed tape automatically contains the same processing as the source tape.
- ❑ When you want to record onto both sides of a tape, you can set Reverse mode on to do so. However, recording automatically stops after recording in the ◀ direction in Reverse mode. Therefore, make sure that the tape direction is ▶ when recording with Reverse mode on.
- ❑ The recording level, which is the volume at which the new tape is being made, is automatically set correctly, so it is not affected by the VOLUME control on the CA-D672TR. Thus, during recording you can adjust the sound you are actually listening to without affecting the recording level.
- ❑ Two small tabs on the back of the cassette tape, one for side A and one for side B, can be removed to prevent accidental erasure or re-recording. To record on a cassette with the tabs removed, you must cover the holes with adhesive tape first. However, when a type II tape is used, only cover part of the hole as shown, since the other part of the hole is used to detect the tape type.

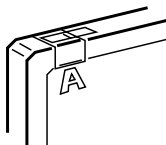

- ❑ When recording, you can hear Sound Mode effects through the speakers or headphones. However, the sound is recorded without Sound Mode effects.
- ❑ Type I and Type II tapes can be used for recording.

Note: At the start and end of cassette tapes, there is leader tape which cannot be recorded onto. Depending on the recording source, the first part of the recording may be missing because of the leader. When recording CDs or radio broadcasts, to get the beginning of the recording on the tape, first wind on the leader before beginning recording.

CAUTION: If recordings you have made have excessive noise or static, the Unit may be too close to a TV which was on during the recording. Either turn off the TV or increase the distance between the TV and the CA-D672TR.

Standard Recording

This is the basic method for recording any source. The CA-D672TR also has special ways for recording CD to tape, and tape to tape, which save you time and effort, as well as give you some special effects. However, when you need to add a selection to a tape you have made, or are combining selections from several sources on one tape, use the method described below; just substitute the source you want into this procedure, such as a tape in Deck A, a CD, or the Tuner. You can also record from VCR with this procedure.

To Record Any Sound Source To Tape

Follow these steps to record from any sound source onto a tape in Deck B.

Using the Unit

1. Insert a blank or erasable tape into Deck B.
2. Press the **REVERSE MODE** button if you want to record on both sides of the tape.
Reverse Mode comes on.
 - When using Reverse Mode, insert the tape so that it will be recorded in the forwards ► direction.
3. Check the recording direction for the tape.
Check that the Tape Direction indicator is the same as that for the tape in the tape deck. If the directions are different, press the ■ button after pressing the ◀ or ▶ button to set the tape direction.
 - When using Reverse Mode to record both sides of a tape, check that the Tape Direction indicator is in the forwards ► direction. If the direction indicator is not in the forwards ► direction, press the ▶ button then press the ■ button.
4. Prepare the source, by, for example, tuning in a radio station, loading CDs, or turning on connected equipment.
5. Press the **REC START/STOP** button.
The Recording indicator light comes on and the CA-D672TR begins recording.

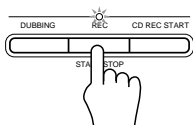

Using the Remote Control

1. Insert a blank or erasable tape into Deck B.
2. Press the **REC PAUSE** button.
The Recording indicator light comes on.
3. Press the **REVERSE MODE** button on the Unit if you want to record on both sides of the tape.
Reverse Mode comes on.
 - When using Reverse Mode, insert the tape so that it will be recorded in the forwards ► direction.
4. Prepare the source by, for example, tuning in a radio station, loading CDs, or turning on connected equipment.
5. Press the ◀ or ▶ button.
Recording starts in the direction of the button pressed.
 - When using Reverse Mode to record both sides of a tape, press the ► button.



CAUTION: Operations other than using **AUTO POWER OFF**, the **SLEEP** timer or changing the CD for the other disc trays, may cause the recording source to be changed.

If you are recording an AM (MW/LW) broadcast and you hear interference, move BEAT CUT switch on the back panel from position 1 (the normal mode) to position 2.

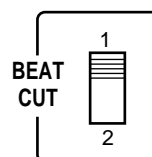

Notes for using Reverse Mode for recording

When recording in Reverse Mode, the CA-D672TR automatically stops when it reaches the end of the reverse ◀ direction. To record on both sides of a tape, make sure that the recording direction for the tape inserted into Deck B is forwards ▶, and that the Tape Direction indicator is also forwards ▶, before you start recording.

To Pause at Any Time During the Recording Process

Press the REC PAUSE button on the Remote Control. Then press either the ◀ or ▶ button on the Remote Control or REC START/STOP button on the Unit to restart recording.

To Stop at Any Time During the Recording Process

Press the REC START/STOP button on the Unit again, or press the ■ button.

CD Direct Recording

Everything on the CD goes onto the tape in the order it is on the CD, or according to the order you have set in a program.

1. Prepare CDs. (See page 19.)

Check that the CD Player is not playing a CD.

2. Insert a cassette in Deck B to record on.

- When you want to record on both sides of a tape, press the REVERSE MODE to turn Reverse Mode on. Check that the recording direction for the tape and the Tape Direction indicator are correct. (See “Notes for using Reverse Mode for recording” earlier on this page.)

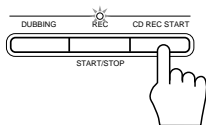

3. Press the CD REC START button.

“CD REC” is displayed on the display then the Unit plays the CD and starts recording.

At the end of the tape, the CA-D672TR automatically goes back to the beginning of the last selection and re-records it, this time gently fading out at the end. If you selected Reverse Mode, “TAPE SIDE-B STANDBY” scrolls through the display then the reverse side starts with the last selection of the first side. The last selection of the first side will fade out at the end. (A 10 second blank is created at the beginning of the reverse side.)

When the recording is finished, the message “CD REC FINISHED” scrolls by on the display. The CD Player and Cassette Deck stop.

To Stop at Any Time During the Recording Process

Press the REC START/STOP button or the ■ button on the Cassette Deck or CD Player (or the ■ button on the Remote Control).

Notes:

- When the Auto Power Off function is turned on while recording a CD, the power will automatically turn off when the CD finishes. Be careful when the Auto Power Off function is turned on while recording a CD in Repeat Mode, as repeat will be cancelled and the power will automatically turn off with Repeat Mode (“REPEAT ALL”, “REPEAT 1 CD”, or “REPEAT 1”). (Page 11)
- When making SLEEP timer settings while doing CD Direct recording, set the time so that there is enough leeway to finish the recording before the power goes off. If the time is set to about the length of the CD, the power may go off before recording finishes.

For CD Direct Recording using more than one disc, use a blank tape, If you use a prerecorded tape, prerecorded material may not be erased between newly-recorded tracks.

Using Auto Edit, you can record the CD tracks to fit the tape, so a selection isn't cut off. Auto Edit is one of the best ways to copy all of a CD onto a tape.

Auto Edit programs the CD tracks in numerical order. To prevent the end of the last track on the front side from being cut off, the last track on the front side is selected to fit on the remaining tape length.

1. Prepare CDs. (See page 19.)

2. Press the EDIT button on the Unit.

"DISC--" appears in the display.

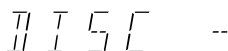

3. Press the DISC button for the disc you want to record.

After "TAPE C --" appears on the display, the optimum tape length for the disc you want to record is displayed.

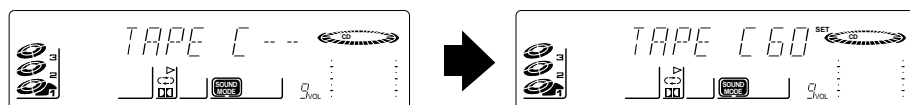
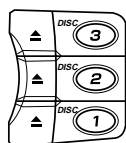

- You can select a different length of tape, depending on the actual size of the tape you are using, from eleven possibilities programmed into the CA-D672TR: 40, 46, 50, 54, 60, 64, 70, 74, 80, 84, 90. Select the tape length that corresponds to the length of tape you are using, or the nearest length to it, by adjusting the MULTI CONTROL stick left or right.
 - If you pick a tape length shorter than the total playing time of the CD, the last tracks on both sides of the tape will be faded out as the tape ends.

4. Press the SET button.

The tracks to be recorded on side B of the tape appear on the display.



- To display the tracks that will be recorded on side A of the tape, press the SET button again. The Unit switches between side A and side B with each press of the SET button.
- To check the tracks that will be recorded, press the ◀◀ or ▶▶ buttons on the Remote Control.

5. Insert a cassette in Deck B to record on.

When you want to record on both sides of a tape, press the REVERSE MODE button to turn Reverse mode on.

6. Press the CD REC START button.

The Unit plays the CD and starts recording. If the tape has not been rewound, the Unit rewinds the tape before starting to record the CD.

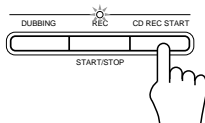

When the tape is ready, to prevent the start of a track being cut, the CA-D672TR creates a blank period of 10 seconds before it starts to record the CD. While a blank period is being created, "TAPE SIDE-A STANDBY" scrolls through the display. (The CA-D672TR also creates a 10 second blank period at the start of side B of the tape. While a blank period is being created, "TAPE SIDE-B STANDBY" scrolls through the display.)

When the recording is finished, the message "CD REC FINISHED" scrolls by on the display. The CD Player and Cassette Deck stop.

To stop at any time while recording, press the ■ button (CD control or Cassette Deck control) or the REC START/STOP button. If you press the CD control ■ button, the Cassette Deck creates a four second blank space after the CD Player stops. If you press any other button to stop the recording, the CD Player and Cassette Deck stop at the same time.

To cancel Auto Edit, press the ▲ button for disc number being recorded, or press the PROGRAM/RANDOM button while the CD Player is stopped.

Note: When making SLEEP timer settings while doing Auto Edit recording, set the time so that there is enough leeway to finish the recording before the power goes off. If the time is set to about the length of the CD, the power may go off before recording finishes.

Tape to Tape Recording (Dubbing)

Recording from one tape to another is called dubbing.

You can dub tapes simply, with just a single button.

- When dubbing tapes, make sure that the playback direction of Deck A and Deck B are the same.
- When you want to record both sides of a tape, press the REVERSE MODE button to turn Reverse mode on.
- It is preferable that the type of tape (Type I or Type II) you record from be the same as the type you record onto.

How to Use the DUBBING Button

1. Insert the source cassette you want to copy from into Deck A for playback.
2. Insert the blank or erasable cassette you want to copy onto in to Deck B for recording.
3. Press the DUBBING button.
Deck A and Deck B will start simultaneously.

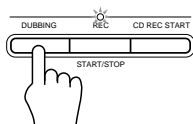

To stop dubbing, press the ■ button or REC START/STOP button.

- Dolby NR is inactive in dubbing mode regardless of the setting of DOLBY B NR. The dubbed tape automatically contains the same processing as the source tape.
- When doing dubbing with the DUBBING button, you can hear Sound Mode effects through the speakers or headphones. However, the sound is dubbed without Sound Mode effects.

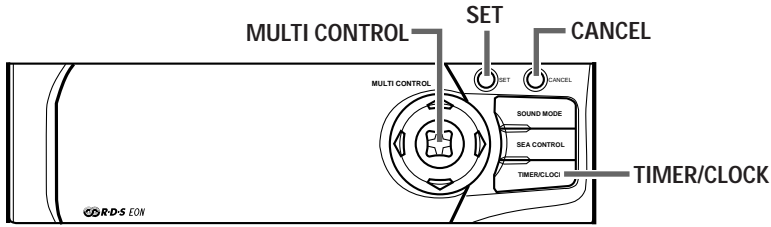
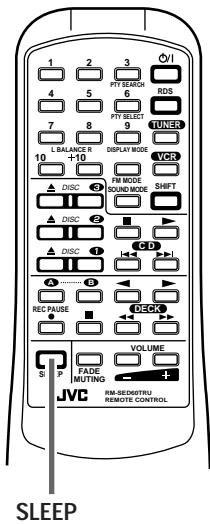

Display

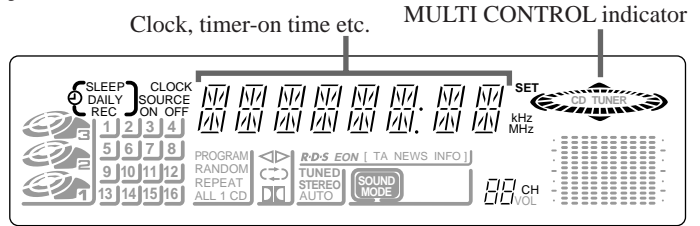

When the CA-D672TR is being used, the display shows other items as well. However, we have only shown the items described in this section.

The timers lets you control recording and listening functions automatically.

Three types of timers are available:

- DAILY Timer** — Use this timer to set wake up everyday to music from any source, instead of an alarm clock.
- REC (Recording) Timer** — Unattended recording of radio broadcasts. You can set the starting time and length of the recording.
- SLEEP Timer** — Fall asleep and have your CA-D672TR turn off automatically after a certain length of time.

Setting the Clock

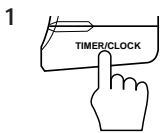

The timers depend on the clock: the clock must be right for the timers to work as you expect. You can set the clock whether the Unit is on or off.

Note that the clock must be set, or the timers cannot be set.



1. Press the TIMER/CLOCK button.

The “CLOCK” indicator and the hour digits blink on the display.

2. Set the hour by adjusting the MULTI CONTROL stick left or right.

Adjust the MULTI CONTROL stick to the right to advance the hour setting, adjust it to the left to decrease the setting. Press the MULTI CONTROL stick continuously to increase or decrease the hour setting rapidly.



3. Press the SET button.

The minute digits blink on the display.



4. Set the minute by adjusting the MULTI CONTROL stick left or right.

Adjust the MULTI CONTROL stick to the right to advance the minute setting, adjust it to the left to decrease the setting. Press the MULTI CONTROL stick continuously to increase or decrease the minute setting rapidly in 10 minute steps.



5. Press the SET button.

“CLOCK OK” appears on the display, and the clock starts at zero seconds from the set time.

CAUTION: If there is a power failure, the clock loses its setting. The display shows "0:00", and the clock must be reset.

Setting the DAILY Timer

With this timer you can wake up to music from a CD, tape, your favourite radio program, or other source.

- ❑ You can set the DAILY Timer whether the Unit is on or off.

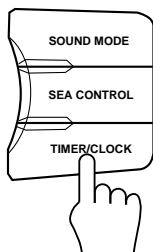

Procedure For Setting the DAILY Timer

1. Press the TIMER/CLOCK button so that "DAILY Timer" appears in the display.
The message "DAILY" blinks and the DAILY indicator light blinks on the display.

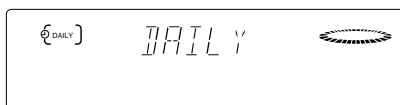

- ❑ The display changes with each press of the button, as shown below.
DAILY (blinks) → ON TIME (blinks) → REC (blinks) → ON TIME (blinks) → CLOCK (blinks) (Clock setting mode) → original display before the TIMER/CLOCK button was pressed → (back to the beginning)

Note: If the clock has not been set, even if the TIMER/CLOCK button is pressed you cannot select the DAILY Timer.

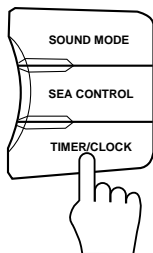

2. Press the TIMER/CLOCK button again.
The display changes to the On Time display.

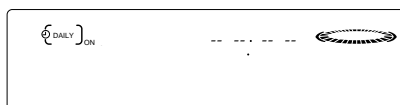

3. Set the time you want the Unit to turn on.
Set the time by adjusting the MULTI CONTROL stick left or right in the same way you set the time for the clock. Press the SET button to set the on time.

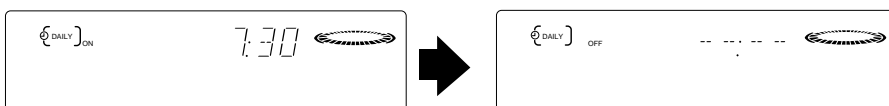

The "OFF time" hour setting starts to blink after the "ON time" minute setting is set.

4. Set the time you want the Unit to turn off.
Set the time by adjusting the MULTI CONTROL stick left or right in the same way you set the time for the clock. Press the SET button to set the off time.

- ❑ When the off time has been set, the display changes to the source selection display.

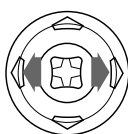
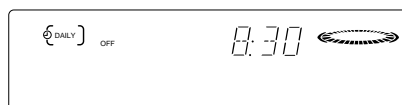

5. Select the source you want to listen to.

To use the Tuner as the source:

1. Adjust the MULTI CONTROL stick left or right until “TUNER” blinks in the display.



2. Adjust the MULTI CONTROL stick up or down to select the preset channel you want to listen to. (possible only after presetting stations.)

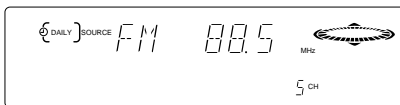

3. Press the SET button.

To use a CD as the source:

1. Adjust the MULTI CONTROL stick left or right until “- CD - - -” blinks in the display.

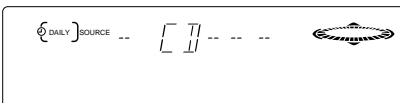

2. Adjust the MULTI CONTROL stick up or down to select the disc tray containing the CD you want to play.

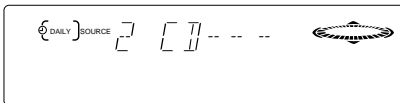

3. Press the SET button.
If you press the SET button without selecting a disc, the last disc played by the CA-D672TR will be used.

4. Adjust the MULTI CONTROL stick up or down to select the starting track of the CD. You can only select up to 20 tracks.

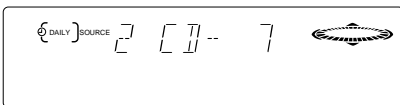

5. Press the SET button.
If you press the SET button without selecting a track, playback will start from the first track on the CD.

To use a Cassette Deck as the source:

1. Adjust the MULTI CONTROL stick left or right until “TAPE” blinks in the display.



2. Press the SET button.

To use another source:

Use this to select a radio station that has not been preset.

1. Adjust the MULTI CONTROL stick left or right until “- - - -” blinks in the display.

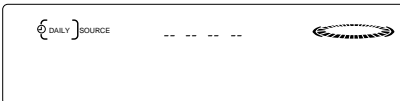

2. Press the SET button.
The last source used is selected.

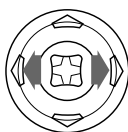
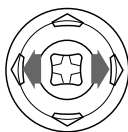
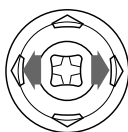

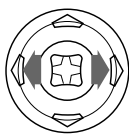

6. Setting the Volume Level.

Adjust the MULTI CONTROL stick left or right to set the volume level.



VOLUME - A: Sets the volume level to 10.

VOLUME - B: Sets the volume level to 15.

VOLUME - C: Sets the volume level to 20.

VOLUME - - : Sets the volume to the last volume setting used.



7. Press the SET button.

The “DAILY” indicator changes from a blinking display to a steady display. The ON TIME, OFF TIME, PLAYBACK SOURCE (including the disc number and track number if a CD source is selected) are displayed then the display reverts to the previous display, before the Timer was set.

Turn the power off if you made the timer settings with the power turned on.

- A few seconds before the start for the timer, the CA-D672TR automatically turns on the power, and the “DAILY TIMER” blinks on the display. When the set time is reached, playback starts using the selected source. After the finish time for the timer is reached, the power is automatically turned off again.
- If a button is pressed when the DAILY Timer is operating, playback continues but the timer is cancelled.

Before Turning Off the Unit

- If the source is a CD, make sure that there is a CD in the selected disc number.
- If the source is a tape:
 - The tape in the deck corresponding to the Deck Indicator mark is played. Make sure that there is a tape in the selected Cassette Deck.
 - Check that the tape direction is correct. This is important especially when Reverse Mode is off.
 - Set Reverse Mode on if you want to play both sides of the tape.
- Select the Sound Mode if you want to listen using a Sound Mode effect.

To change the DAILY Timer setting

To change the settings for the DAILY Timer, repeat the setting procedure from the beginning.

Turning the DAILY Timer On and Off

Once the DAILY Timer has been set it will be activated at the same time every day until the setting is turned off.

To turn the DAILY Timer off, press the TIMER/CLOCK button until “DAILY” appears in the display. Press the CANCEL button, “OFF” appears in the display and the DAILY indicator goes out.

To turn the DAILY TIMER on again, press the TIMER/CLOCK button until “DAILY” appears in the display, then press the SET button. The Timer ON TIME, OFF TIME, PLAYBACK SOURCE (including the disc number and track number if a CD source is selected) are displayed on the display.

CAUTION: If the CA-D672TR is unplugged, or a power failure occurs, the timer setting will be erased in a few days. If the settings are erased in this way, reset the timer settings.

Setting the REC (Recording) Timer

With the Recording Timer you can make a tape of a radio broadcast automatically whether or not you are home. For the timer to work correctly, you need to make sure of the following in addition to setting the time for the Tuner and Cassette Deck to come on:

- You can set the REC Timer whether the Unit is on or off.
- The tape you want to record onto must be in Deck B.

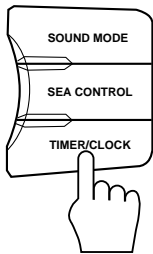

Procedure for Setting the REC Timer

1. Press the **TIMER/CLOCK** button so that "REC Timer" appears in the display.
The message "REC" blinks and the REC indicator light blinks on the display.



- The display changes with each press of the button, as shown below.
DAILY (blinks) → **ON TIME** (blinks) → **REC** (blinks) → **ON TIME** (blinks) → **CLOCK** (blinks) (Clock setting mode) → original display before the **TIMER/CLOCK** button was pressed → (back to the beginning)

Note: If the clock has not been set, even if the **TIMER/CLOCK** button is pressed you cannot select the REC Timer.

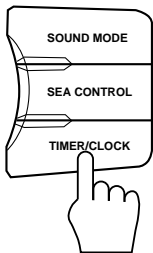

2. Press the **TIMER/CLOCK** button again.
The display changes to the On Time display.

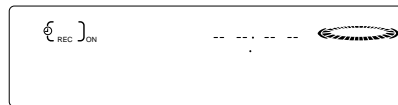

3. Set the time you want the Unit to be turned on.
Set the time by adjusting the **MULTI CONTROL** stick left or right in the same way you set the time for the clock. Press the **SET** button to set the on time.
4. Set the time you want the Unit to be turned off.
Set the time by adjusting the **MULTI CONTROL** stick left or right in the same way you set the time for the clock. Press the **SET** button to set the off time.
5. Select the radio station you want to record.
Set the radio station you want to record by adjusting the **MULTI CONTROL** stick up or down.



6. Press the **SET** button.
The "REC" indicator changes from a blinking display to a steady display. The **ON TIME**, **OFF TIME**, and preset channel number are displayed then the display reverts to the previous display, before the Timer was set.
Turn the power off if you made the timer settings with the power turned on.

- A few seconds before the start time for the recording, the CA-D672TR automatically turns on the power, and "REC TIMER" blinks on the display. When the start time is reached, recording starts using the selected source. After the finish time for the recording is reached, the power is automatically turned off again.
- If a button is pressed when the REC Timer is operating, recording continues but the timer is cancelled.

Before the Timer Starts

- Check that tape direction is correct. This is important especially when Reverse Mode is off.
- Set Reverse Mode on if you want to record on both sides of the tape.
- The **VOLUME** control is automatically set to 0 when REC Timer is recording.

It is very easy, and can be very disappointing, to forget to put in a tape, or to accidentally leave a tape in Deck B you don't want recorded over. Although this happens to almost everyone at one time or another, we hope it won't happen to you!

To Change the Recording Timer Setting

To change the settings for the REC Timer, repeat the setting procedure from the beginning.

Turning the REC Timer On and Off

Once the REC Timer has been used to record a source, the setting is maintained but the Timer is set to OFF.

To turn the REC Timer off before the timer starts, press the TIMER/CLOCK button until "REC" appears in the display, then press the CANCEL button. "OFF" appears in the display and the REC indicator goes out.

To record at the same time again, press the TIMER/CLOCK button until "REC" appears in the display, then press the SET button. The ON TIME, OFF TIME, channel frequency, and preset channel number are displayed then the display reverts to the previous display, before the Timer was set.

CAUTION: If the CA-D672TR is unplugged, or a power failure occurs, the timer setting will be erased in a few days. If the settings are erased in this way, reset the timer settings.

Setting the SLEEP Timer

Use the Sleep Timer to turn the Unit off after a certain number of minutes when it is playing. By setting this timer, you can fall asleep to music and know your Unit will turn off by itself rather than play all night.

❑ You can only set the Sleep Timer when the Unit is on and a source is playing.

To set the SLEEP Timer, follow this procedure:



1. With the CA-D672TR on and a source playing, press the SLEEP button on the Remote Control. The message "SLEEP" appears on the display.

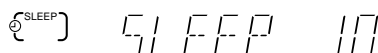

2. Set the length of time you want the source to play before shutting off.

❑ Each time you press this button while the "SLEEP" indicator is blinking, it changes the number of minutes shown on the display in this sequence:

→ 10 → 20 → 30 → 60 → 90 → 120 → Cancelled → (back to the beginning)

When the number of minutes you want shows on the display, just wait 5 seconds until the indicator stops blinking, and is lighted steadily.

The Unit is now set to turn off after the number of minutes you set.

To Change the SLEEP Timer Setting

Press the SLEEP button until the number of minutes you want appears on the display.

To Cancel the SLEEP Timer Setting

Press the SLEEP button until the "SLEEP" indicator goes off on the display.

Turning off the Unit also cancels the SLEEP Timer.

Timer Priority

Since each timer can be set independently, you may wonder what happens if the settings overlap. Here are the priorities for each timer:

- ❑ The REC Timer always has priority. This means that:
 - If another timer is set to come on during a time when the REC Timer is operating, the other timer just won't come on at all, so you will always get the entire program on tape.
 - If the REC Timer is set to come on while another timer is operating, the other timer will shut off 10 seconds before the REC Timer is set to turn on, and the REC Timer will then take over.
- ❑ The SLEEP Timer has the least priority. This means that if the SLEEP Timer is set while the DAILY Timer is operating, the DAILY Timer settings are cancelled. However, if the DAILY Timer is set to come on while the SLEEP Timer is operating, the SLEEP Timer setting will be cancelled and the Unit will use the settings from the DAILY Timer.

Example 1

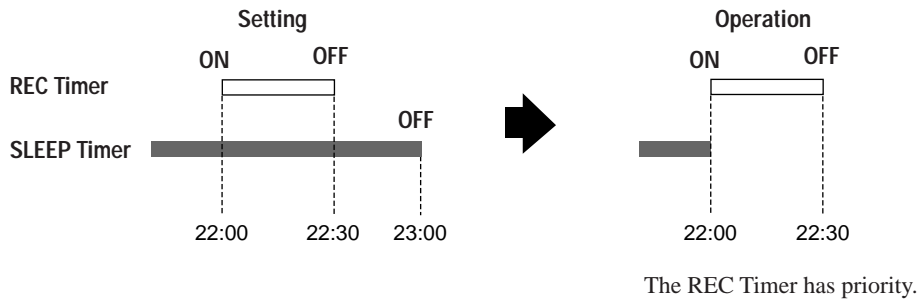

Example 2

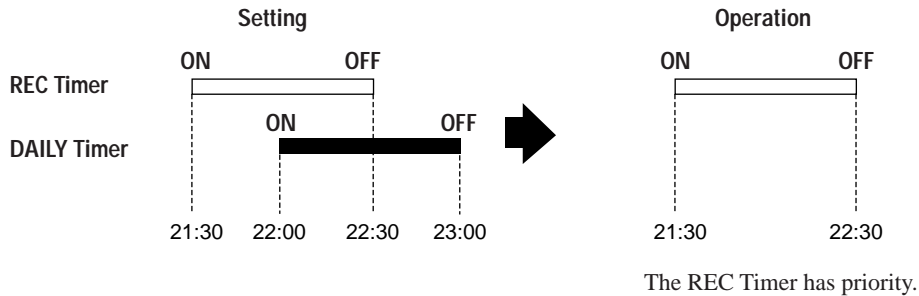

Care And Maintenance

Compact Discs



Handle your compact discs, cassette tapes, and Cassette Deck carefully, and they will last a long time.

- Remove the CD from the case by holding it at the edges while pressing the centre hole lightly.
- Do not touch the shiny surface of the CD, or bend the CD.
- Put the CD back in its case after use to prevent warping.
- Be careful not to scratch the surface of the CD when placing it back in the case.
- Avoid exposure to direct sunlight, temperature extremes, and moisture.
- A dirty CD may not play correctly. If a CD does become dirty, wipe it with a soft cloth in a straight line, from centre to edge.



CAUTION: Do not use any solvent (for example, conventional record cleaner, spray thinner, benzine, etc.) to clean a CD.

Moisture Condensation



Moisture may condense on the lens inside the Unit in the following cases:

- After starting the heating in the room.
- In a damp room.
- If the unit is brought directly from a cold to a warm place.

Should this occur, the Unit may malfunction. In this case, leave the unit turned on for a few hours until the moisture evaporates, unplug the AC power cord, and then plug it in again.

General Notes

In general, you will have the best performance by keeping your tapes, CDs, and the mechanism clean.

- Store tapes and CDs in their cases, and keep them in cabinets or on shelves.
- Keep the Cassette Deck's tape holder and the CD trays closed when not in use.

Cassette Tapes



- If the tape is loose in its cassette, take up the slack by inserting a pencil in one of the reels and rotating.
- If the tape is loose, it may get stretched, cut, or caught in the cassette.



- Do not touch the tape surface.



- Do not store the tape:
 - In dusty places
 - In direct sunlight or heat
 - In moist areas
 - On a TV or speaker
 - Near a magnet

Cassette Deck

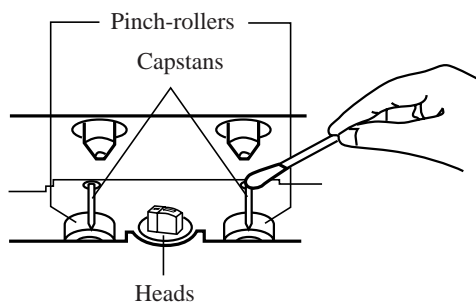

- If the heads, capstans, and pinch-rollers of the Cassette Deck become dirty, the following will occur:
 - Loss of sound quality
 - Discontinuous sound
 - Fading
 - Incomplete erasure
 - Difficulty recording
- Clean the heads, capstans, and pinch-rollers using a cotton swab moistened with alcohol.



- If the heads become magnetized, the Unit will produce noise or lose high frequencies.
- To demagnetize the heads, turn off the Unit, and use a head demagnetizer (available at electronics and record shops).

Troubleshooting

- If you are having a problem with your CA-D672TR, check this list for a possible solution before calling for service.
- If you cannot solve the problem from the hints given here, or the Unit has been physically damaged, call a qualified person, such as your dealer, for service.

Symptom	Possible Cause	Action
No sound is heard.	Connections are incorrect, or loose.	Check all connections and make corrections. (See pages 4 - 5.)
Unable to record.	Cassette record protect tabs are removed.	Cover holes on back edge of cassette with tape.
Poor radio reception	<ul style="list-style-type: none"> • The antenna is disconnected. • The AM Loop Antenna is too close to the Unit. • The FM Wire Antenna is not properly extended and positioned. 	<ul style="list-style-type: none"> • Re-connect the antenna securely. • Change the position and direction of the AM Loop Antenna. • Extend FM Wire Antenna to the best reception position.
The CD skips.	The CD is dirty or scratched.	Clean or replace the CD.
Unable to operate the Remote Control.	<ul style="list-style-type: none"> • The path between the Remote Control and the sensor on the Unit is blocked. • The batteries have lost their charge. 	<ul style="list-style-type: none"> • Remove the obstruction. • Replace the batteries.
The CD tray cannot be opened.	The main AC power cord is not plugged in.	Plug in the AC power plug.
The CD does not play.	The CD is upside down.	Put the CD in with the label side up.
Operations are disabled.	The built-in microprocessor has malfunctioned due to external electrical interference.	Unplug the Unit then plug it back in.
The cassette door cannot be opened.	During tape playing, the power cord was unplugged.	Plug in the power cord, press the  button, and then the  button.

Specifications

Amplifier Section

Output Power (IEC 268-3/DIN)	70 watts per channel, min. RMS, both channels driven, into 6 ohms at 1 kHz with no more than 0.9% total harmonic distortion.
Input Sensitivity/Impedance (1 kHz)	
VCR	300 mV/45 kohms
Speaker terminals	
Main speakers	6 - 16 ohms

Cassette Deck Section

Frequency Response	
Type II (CrO ₂) :	30 - 16,000 Hz
Type I (NORMAL) :	30 - 15,000 Hz
Wow And Flutter	0.15% (WRMS)

CD Automatic Changer Section

CD Capacity	3 discs
Dynamic Range	93 dB
Signal-To-Noise Ratio	98 dB
Wow And Flutter	Unmeasurable

Tuner Section

FM Tuner	
Tuning Range	87.5 - 108.0 MHz
AM Tuner	
Tuning Range	
MW	522 - 1,629 kHz
LW	144-288 kHz

Dimensions	245 x 345 x 350.2 mm (W/H/D) (9-11/16 x 13-5/8 x 13-13/16 inches)
Mass	9.0 kg (19.9 lbs)

Accessories

AM (MW/LW) Loop Antenna	(1)
Remote Control	(1)
Batteries R6P (SUM-3)/AA (15F)	(2)
FM Wire Antenna	(1)

Power Specifications

Power Requirements	AC 230 V \sim , 50 Hz
Power Consumption	185 watts 24 watts (in standby mode)

Design and specifications are subject to change without notice.

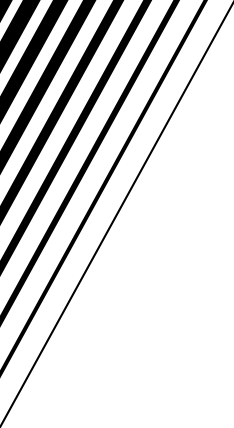

JVC
VICTOR COMPANY OF JAPAN, LIMITED

Free Manuals Download Website

<http://myh66.com>

<http://usermanuals.us>

<http://www.somanuals.com>

<http://www.4manuals.cc>

<http://www.manual-lib.com>

<http://www.404manual.com>

<http://www.luxmanual.com>

<http://aubethermostatmanual.com>

Golf course search by state

<http://golfingnear.com>

Email search by domain

<http://emailbydomain.com>

Auto manuals search

<http://auto.somanuals.com>

TV manuals search

<http://tv.somanuals.com>