

JVC



COMPACT COMPONENT SYSTEM

FS-GD7

—Consists of CA-FSGD7 and SP-FSGD7

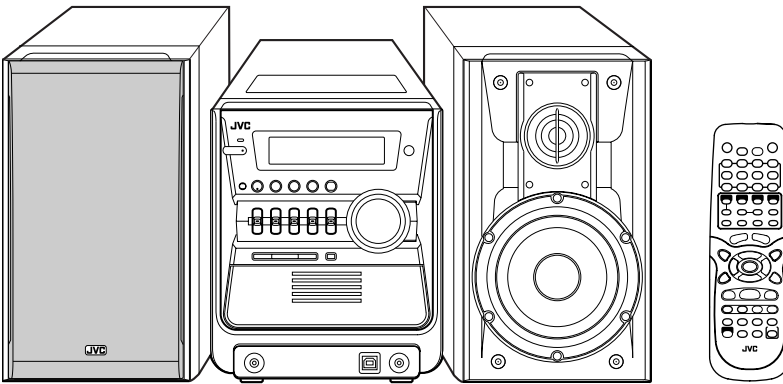

Digital Direct Progressive Scan

INSTRUCTIONS

For Customer Use:

Enter below the Model No. and Serial No. which are located either on the rear, bottom or side of the cabinet. Retain this information for future reference.

Model No. _____

Serial No. _____

LVT1348-001C

[J]

Warnings, Cautions and Others Mises en garde, précautions et indications diverses



CAUTION
RISK OF ELECTRIC SHOCK
DO NOT OPEN



CAUTION: TO REDUCE THE RISK OF ELECTRIC SHOCK, DO NOT REMOVE COVER (OR BACK). NO USER SERVICEABLE PARTS INSIDE. REFER SERVICING TO QUALIFIED SERVICE PERSONNEL.

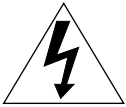

The lightning flash with arrowhead symbol, within an equilateral triangle is intended to alert the user to the presence of uninsulated "dangerous voltage" within the product's enclosure that may be of sufficient magnitude to constitute a risk of electric shock to persons.



The exclamation point within an equilateral triangle is intended to alert the user to the presence of important operating and maintenance (servicing) instructions in the literature accompanying the appliance.

WARNING: TO REDUCE THE RISK OF FIRE OR ELECTRIC SHOCK, DO NOT EXPOSE THIS APPLIANCE TO RAIN OR MOISTURE.

CAUTION

To reduce the risk of electrical shocks, fire, etc.:

- 1 Do not remove screws, covers or cabinet.
- 2 Do not expose this appliance to rain or moisture.

ATTENTION

Afin d'éviter tout risque d'électrocution, d'incendie, etc.:

- 1 Ne pas enlever les vis ni les panneaux et ne pas ouvrir le coffret de l'appareil.
- 2 Ne pas exposer l'appareil à la pluie ni à l'humidité.

CAUTION— ϕ /I (standby/on) button!

Disconnect the mains plug to shut the power off completely (all lamps and indications go off). The ϕ /I button in any position does not disconnect the mains line.

- When the unit is on standby, the STANDBY lamp lights in red.
- When the unit is turned on, the STANDBY lamp goes off.

The power can be remote controlled.

Attention—Touche ϕ /I (attente/sous tension)!

Deconnectez la fiche secteur pour mettre l'appareil complètement hors tension (tous les témoins et toutes les indications s'éteignent). La touche ϕ /I dans n'importe quelle position ne deconnecte pas l'appareil du secteur.

- Quand l'appareil est en mode d'attente, le témoin STANDBY est allumé en rouge.
- Quand l'appareil est sous tension, le témoin STANDBY s'éteint.

L'alimentation ne peut pas être commandée à distance.

Caution: Proper Ventilation

To avoid risk of electric shock and fire, and to prevent damage, locate the apparatus as follows:

1. Front: No obstructions and open spacing.
2. Sides/ Top/ Back: No obstructions should be placed in the areas shown by the dimensions below.
3. Bottom: Place on the level surface. Maintain an adequate air path for ventilation by placing on a stand with a height of 10 cm or more.

Attention: Aération correcte

Pour prévenir tout risque de décharge électrique ou d'incendie et éviter toute détérioration, installez l'appareil de la manière suivante:

1. Avant: Bien dégagé de tout objet.
2. Côtés/dessus/dessous: Assurez-vous que rien ne bloque les espaces indiqués sur le schéma ci-dessous.
3. Dessous: Posez l'appareil sur une surface plane et horizontale. Veillez à ce que sa ventilation correcte puisse se faire en le plaçant sur un support d'au moins dix centimètres de hauteur.

**Front
Face**

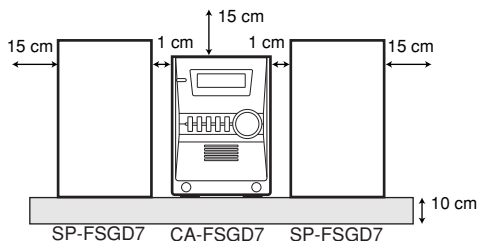

**Side
Côté**

**Cooling fan*
Ventilateur de
refroidissement***

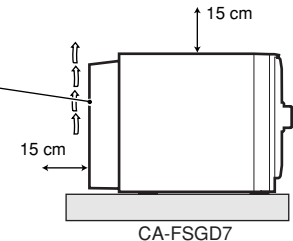

* About the cooling fan

A cooling fan is mounted on the rear panel of the unit to prevent abnormal temperature inside the unit, thus assuring normal operation of the unit. The cooling fan automatically starts rotating to intake external cool air when the volume is increased up to more than a certain level.

* À propos du ventilateur de refroidissement

Un ventilateur de refroidissement se trouve sur le panneau arrière de l'appareil afin d'éviter la création d'une température anormale à l'intérieur de l'appareil et permettre ainsi un fonctionnement normal de l'appareil. Le ventilateur de refroidissement commence à tourner et à aspirer de l'air frais automatiquement quand le volume est augmenté au-dessus d'un certain niveau.

For U.S.A.

This equipment has been tested and found to comply with the limits for a Class B digital device, pursuant to part 15 of the FCC Rules. These limits are designed to provide reasonable protection against harmful interference in a residential installation.

This equipment generates, uses and can radiate radio frequency energy and, if not installed and used in accordance with the instructions, may cause harmful interference to radio communications. However, there is no guarantee that interference will not occur in a particular installation. If this equipment does cause harmful interference to radio or television reception, which can be determined by turning the equipment off and on, the user is encouraged to try to correct the interference by one or more of the following measures:

- Reorient or relocate the receiving antenna.
- Increase the separation between the equipment and receiver.
- Connect the equipment into an outlet on a circuit different from that to which the receiver is connected.
- Consult the dealer or an experienced radio/TV technician for help.

CAUTION

Changes or modifications not approved by JVC could void the user's authority to operate the equipment.

For the main unit:

Declaration of Conformity

Model Number: FS-GD7

Trade Name: JVC

Responsible Party: JVC Americas Corp.

Address: 1700 Valley Road, Wayne
New Jersey 07470

Telephone Number: 973-317-5000

This device complies with Part 15 of FCC Rules. Operation is subject to the following two conditions: (1) This device may not cause harmful interference, and (2) this device must accept any interference received, including interference that may cause undesired operation.

For Canada/pour le Canada

CAUTION: TO PREVENT ELECTRIC SHOCK, MATCH WIDE BLADE OF PLUG TO WIDE SLOT, FULLY INSERT.

ATTENTION: POUR EVITER LES CHOCS ELECTRIQUES, INTRODUIRE LA LAME LA PLUS LARGE DE LA FICHE DANS LA BORNE CORRESPONDANTE DE LA PRISE ET POUSSER JUSQU'AU FOND.

Note to CATV system installer:

This reminder is provided to call the CATV system installer's attention to section 820-40 of the NEC which provides guidelines for proper grounding and, in particular, specifies that the cable ground shall be connected to the grounding system of the building, as close to the point of cable entry as practical.

For Canada/pour le Canada

THIS DIGITAL APPARATUS DOES NOT EXCEED THE CLASS B LIMITS FOR RADIO NOISE EMISSIONS FROM DIGITAL APPARATUS AS SET OUT IN THE INTERFERENCE-CAUSING EQUIPMENT STANDARD ENTITLED "DIGITAL APPARATUS," ICES-003 OF THE DEPARTMENT OF COMMUNICATIONS.

CET APPAREIL NUMERIQUE RESPECTE LES LIMITES DE BRUITS RADIOELECTRIQUES APPLICABLES AUX APPAREILS NUMERIQUE DE CLASSE B PRESCRITES DANS LA NORME SUR LE MATERIEL BROUILLEUR; "APPAREILS NUMERIQUE", NMB-003 EDICTEE PAR LE MINISTRE DES COMMUNICATIONS.

IMPORTANT FOR LASER PRODUCTS

- 1 CLASS 1 LASER PRODUCT
- 2 **CAUTION:** Do not open the top cover. There are no user serviceable parts inside the unit; leave all servicing to qualified service personnel.
- 3 **CAUTION:** Visible and invisible laser radiation when open and interlock failed or defeated. Avoid direct exposure to beam.
- 4 REPRODUCTION OF LABEL: CAUTION LABEL, PLACED INSIDE THE UNIT.

IMPORTANT POUR PRODUITS LASER

- 1 PRODUIT LASER CLASSE 1
- 2 **ATTENTION:** N'ouvrez pas le couvercle superieur. Il n'y a aucune piece reparable par l'utilisateur a l'interieur de l'appareil; confiez toute reparation a un personnel qualifié.
- 3 **ATTENTION:** Risque de radiations laser visible et invisible quand l'appareil est ouvert et que le système de verrouillage ne fonctionne pas ou a été mis hors service. Évitez toute exposition directe au rayon.
- 4 REPRODUCTION DE L'ETIQUETTE: ÉTIQUETTE DE PRÉCAUTION PLACÉE L'INTERIEUR DE L'APPAREIL.

CAUTION : Visible and invisible laser radiation when open and interlock failed or defeated. AVOID DIRECT EXPOSURE TO BEAM. (e)

ADVARSEL : Synlig og usynlig laserstråling når maskinen er åben eller interlocken fejler. Undgå direkte eksponering til stråling. (d)

WARNING : Synlig och osynlig laserstråling när den öppnas och spårren är urkopplad. Betrakta ej strålen. (s)

VARO : Avattaessa ja suojalukitus ohitettuna tai viallisena olet alttiina näkyvälle ja näkymättömälle lasersäteilylle. Vältä säteen kohdistumista suoraan itseesi. (f)

CONTENTS



Introduction	2	On-Screen Disc Operations	25
Precautions	2	On-screen Bar Information	25
How to Read This Manual	2	Operations Using the On-screen Bar	26
Getting Started	3	Operations on the CONTROL Screen	28
Step 1: Unpack	3	Timer Operations	30
Step 2: Prepare the Remote Control	3	Setting the Daily Timer.....	30
Step 3: Hook Up	4	Setup Menu Operations	32
Changing the Scanning Mode	6	Operating Procedure	32
Before Operating the System	7	■ LANGUAGE Setup Menu	33
Playable Disc Types	7	■ PICTURE Setup Menu	33
Display Indicators	8	■ AUDIO Setup Menu	34
Daily Operations—Playback	10	■ OTHERS Setup Menu	35
Listening to the Radio	11	Operating the TV	36
Playing Back a Disc	12	Operating TV	36
Playing Back from the PC.....	14	Additional Information	37
Playing Back from Other Equipment	14	Learning More about This System.....	37
Daily Operations—Sound&Other Adjustments	15	Maintenance	39
Adjusting the Volume	15	Troubleshooting	40
Adjusting the Sound	15	Language Code List	41
Making DVD Voice Clear—CLEAR VOICE	16	OPTICAL DIGITAL OUT Signals.....	42
Presetting Automatic DVD Sound Increase Level.....	16	Parts Index.....	43
Changing the Display Brightness.....	16	Specifications	44
Changing the Picture Tone.....	16		
Setting the Clock	17		
Turning Off the Power Automatically	18		
Unique DVD/VCD Operations	19		
Selecting the Sound Track.....	19		
Selecting the Subtitle Language	20		
Selecting the View Angle.....	20		
Playing Back a Bonus Group	20		
Selecting Browsable Still Pictures	21		
Special Effect Playback.....	21		
Advanced Disc Operations	22		
Programming the Playing Order—Program Play.....	22		
Playing at Random—Random Play.....	23		
Playing Repeatedly.....	24		
Prohibiting Disc Ejection—Child Lock	24		

Introduction

Precautions

Installation

- Install in a place which is level, dry and neither too hot nor too cold—between 5°C and 35°C (41°F and 95°F).
- Install the System in a location with adequate ventilation to prevent internal heat buildup inside the System.



DO NOT install the System in a location near heat sources, or in a place subject to direct sunlight, excessive dust or vibration.

- Leave sufficient distance between the System and the TV.
- Keep the speakers away from the TV to avoid interference with TV.

Power sources

- When unplugging the System from the wall outlet, always pull on the plug, not the AC power cord.



DO NOT handle the AC power cord with wet hands.

Moisture condensation

Moisture may condense on the lenses inside the System in the following cases:

- After starting to heat the room
- In a damp room
- If the System is brought directly from a cold to a warm place.

Should this occur, the System may malfunction. In this case, leave the System turned on for a few hours until the moisture evaporates, unplug the AC power cord, then plug it in again.

Internal heat

- A cooling fan is mounted on the rear panel to prevent heat buildup inside the main unit (see page G-1).



For safety, observe the following carefully:

- Make sure there is good ventilation around the main unit. Poor ventilation could overheat and damage the System.
- DO NOT block the cooling fan and the ventilation openings or holes. If they are blocked by a newspaper or cloth, etc., the heat may not be able to get out.

Others

- Should any metallic object or liquid fall into the System, unplug the AC power cord and consult your dealer before operating any further.



DO NOT disassemble the System since there are no user serviceable parts inside.

- If you are not going to operate the System for an extended period of time, unplug the AC power cord from the wall outlet.

If anything goes wrong, unplug the AC power cord and consult your dealer.

How to Read This Manual

To make in this manual as simple and easy-to-understand as possible, we have adapted the following methods:

- Button and control operations are explained as listed in the table below. In this manual, the operations using the remote control is mainly explained; however, you can use the buttons and controls on the main unit if they have the same (or similar) name and marks.
- **Some related tips and notes are explained later in the sections “Learning More about This System” (on pages 37 to 38) and “Troubleshooting” (on page 40), but not in the same section explaining the operations.** If you want to know more about the functions, or if you have a doubt about the functions, go to these sections and you will find the answers.

	Indicates that you press the button briefly .
	Indicates that you press the button briefly and repeatedly until an option you want is selected.
	Indicates that you press one of the buttons.
	Indicates that you press and hold the button for a specified period. <ul style="list-style-type: none"> • The number inside the arrow indicates the period of press (in this example, 2 seconds). • If no number is inside the arrow, press and hold until the entire procedure is complete or until you get a result you want.
	Indicates that you turn the control toward the specified direction(s).
	Indicates that this operation is only possible using the remote control.
	Indicates that this operation is only possible using the buttons and controls on the main unit.

Getting Started

Step 1: Unpack the package and check the accessories.

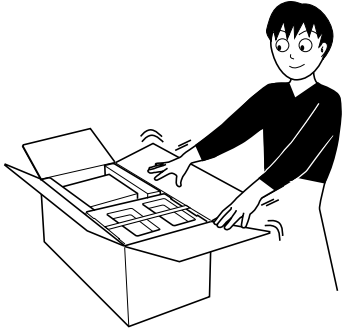

Step 1: Unpack

After unpacking, check to be sure that you have all the following items. The number in parentheses indicates the quantity of each piece supplied.

- FM antenna (1)
- AM loop antenna (1)
- Remote control (1)
- Composite video cord (1)
- Batteries (2)

If any item is missing, consult your dealer immediately.

Step 2: Prepare the Remote Control

Insert the batteries into the remote control by matching the polarity (+ and -) correctly.

Step 2: Prepare the remote control.

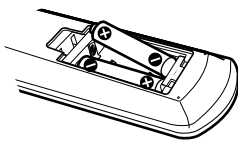

1

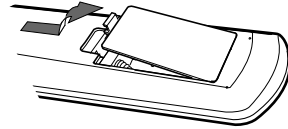

2

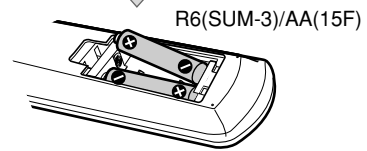

3

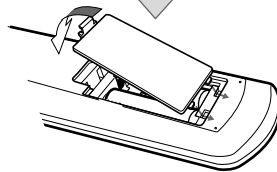

Step 3: Hook up the components such as AM/FM antennas, speakers, etc. (see pages 4 to 6).

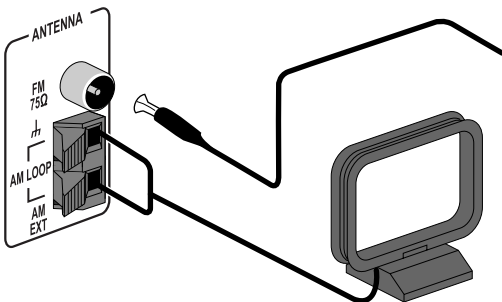

Finally plug the AC power cord.
Now you can operate the System.

- DO NOT use an old battery together with a new one.
- DO NOT use different types of batteries together.
- DO NOT expose batteries to heat or flame.
- DO NOT leave the batteries in the battery compartment when you are not going to use the remote control for an extended period of time. Otherwise, the remote control will be damaged from battery leakage.



Step 3: Hook Up

If you need more detailed information, see page 6.

Illustrations of the input/output terminals below are typical examples. When you connect other components, refer also to their manuals since the terminal names actually printed on the rear may vary.

Turn the power off to all components before connections.

AM loop antenna (supplied)
Turn it until the best reception is obtained.

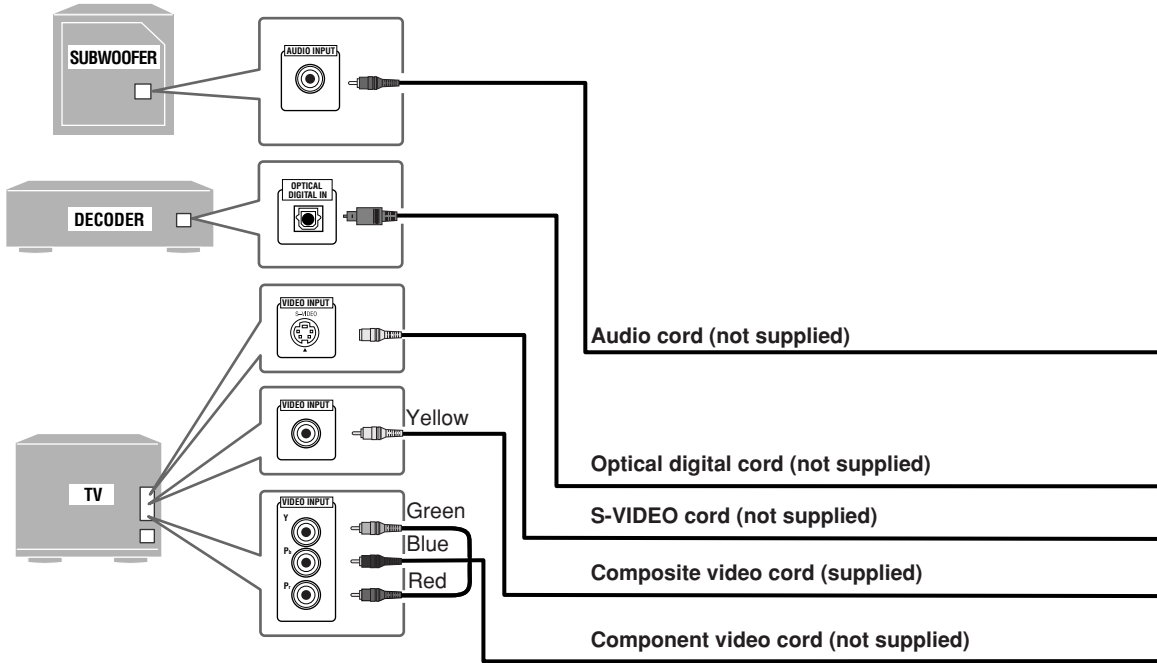
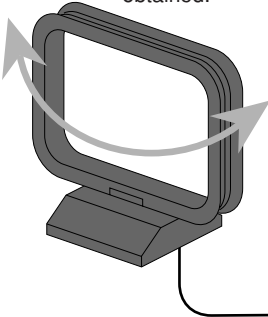

To a wall outlet
Plug the AC power cord only after all connections are complete.

For better FM/AM reception

Vynile-covered wire (not supplied)

Extend it horizontally.

AM loop antenna
Keep it connected.

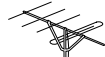
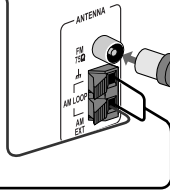

Outdoor FM antenna
(not supplied)

Disconnect the supplied FM antenna, and connect to an outdoor FM antenna using a 75 Ω wire with coaxial type connector.

FM antenna (supplied)

Extend it so that you can obtain the best reception.

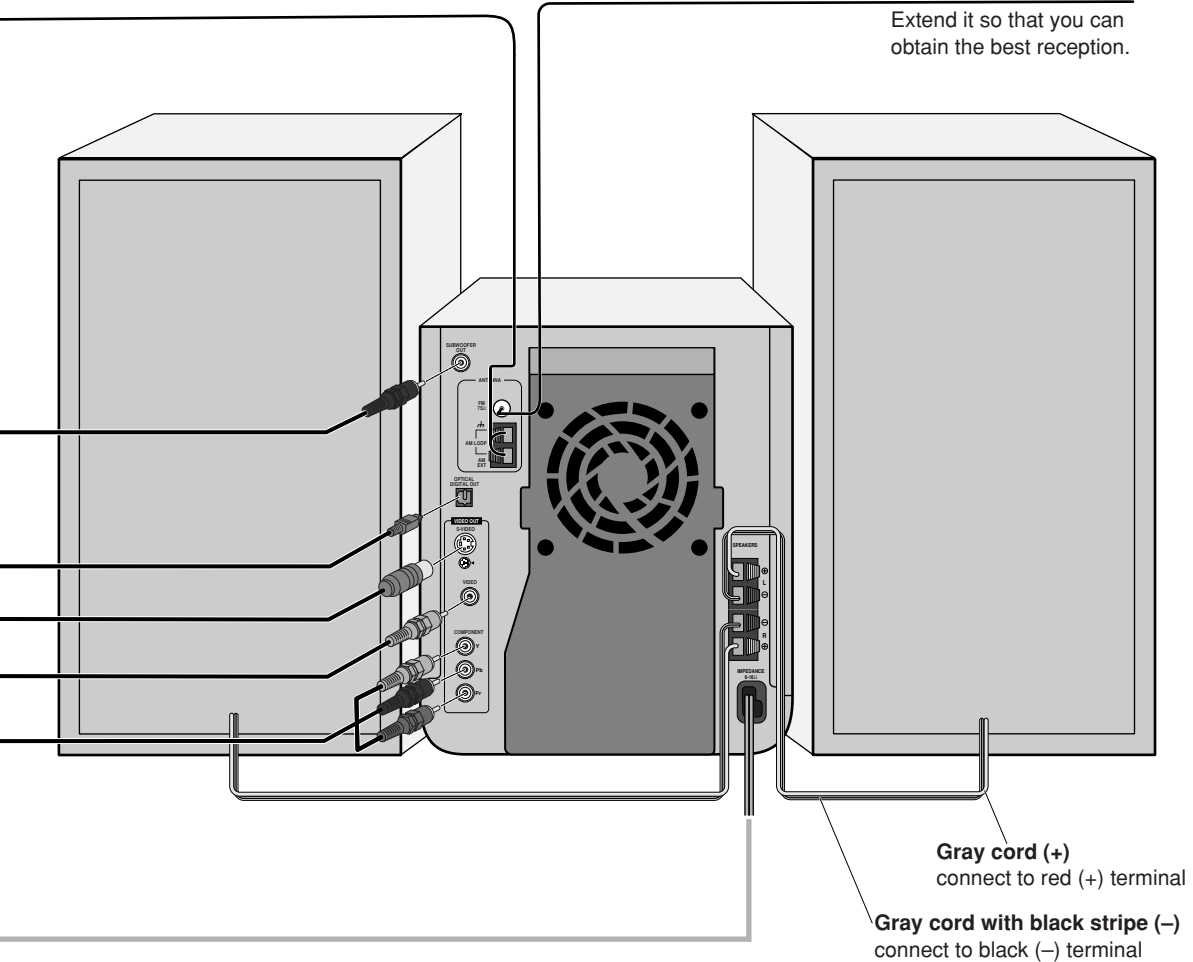

Gray cord (+)
connect to red (+) terminal

Gray cord with black stripe (-)
connect to black (-) terminal

To assemble and connect the AM loop antenna

To assemble the AM loop antenna

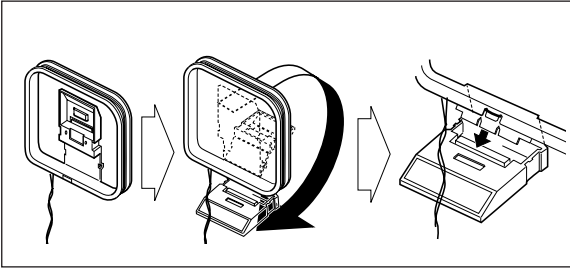

To connect the AM loop antenna

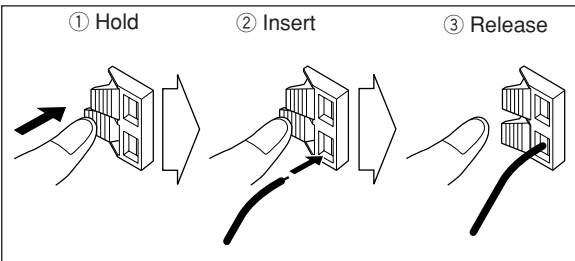

- If the AM loop antenna wire or speaker cords are covered with vinyl, remove the vinyl to expose the tip of the antenna by twisting the vinyl.
- Make sure the antenna conductors do not touch any other terminals, connecting cords and power cord. Also, keep the antennas away from metallic parts of the System, connecting cords, and the AC power cord. This could cause poor reception.

To connect the speaker cords

Connect the right speaker to the R terminals, and the left speaker to the L terminals.

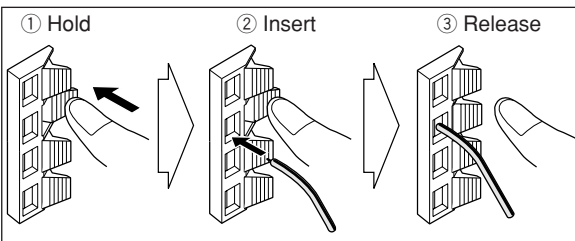

When connecting the speaker cords, match the polarity of the speaker terminals: gray cord (+) to red (+) and gray cord with black stripe (-) to black (-).



- DO NOT connect more than one speaker to each terminal.
- DO NOT allow the conductor of the speaker cords to be in touch with the metallic parts of the System.

Changing the Scanning Mode



This System supports progressive scanning.

If you connect a progressive TV through the COMPONENT jacks, you can enjoy a high quality picture from the built-in DVD player by selecting progressive mode.

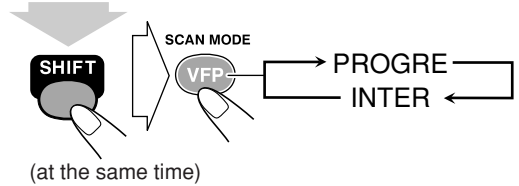

PROGRE (Progressive)

Progressive scanning.
For a progressive TV. The
PROGRESSIVE indicator lights.

INTER (Interlaced)

Interlaced scanning.
For a conventional TV.

Before Operating the System

Playable Disc Types

This System has been designed to play back the following discs:

Disc Type	Mark (Logo)	Video Format	Region Code* Number
DVD Video		NTSC	1 or ALL
DVD Audio			
Video CD (VCD)			
Super Video CD (SVCD)			
Audio CD		—	—
CD-R	The System can play back CD-R or CD-RW recorded in the Audio CD, Video CD, SVCD, MP3, and JPEG formats.		
CD-RW			
DVD-R	The System can play back DVD-R or DVD-RW recorded in the video format.		
DVD-RW			

In addition to the above discs, this system can play back audio data recorded on CD Text, CD-G (CD Graphics), and CD-Extra.

- The following discs cannot be played back: DVD-ROM, DVD-RAM, DVD+R, DVD+RW, CD-I (CD-I Ready), CD-ROM, Photo CD, SACD, etc. Playing back these discs will generate noise and damage the speakers.
- In this manual, “file” and “track” are interchangeably used for MP3/JPEG operations.

* Note on Region Code

DVD players and DVDs have their own Region Code numbers. This System can play back only DVDs recorded with the NTSC color system whose Region Code numbers including “1.”

Ex.:



If a DVD with the improper Region Code numbers is loaded, “RGN ERR (REGION CODE ERROR)” appears on the display and playback will not start.

Caution for DualDisc playback:

The Non-DVD side of a “DualDisc” does not comply with the “Compact Disc Digital Audio” standard. Therefore, the use of Non-DVD side of a DualDisc on this product may not be recommended.

DVD Video—digital audio formats

The System can play back the following digital audio formats.

- Linear PCM:** Uncompressed digital audio, the same format used for CDs and most studio masters.
- Dolby Digital:** Compressed digital audio, developed by Dolby Laboratories, which enables multi-channel encode to create the realistic surround sound.
- DTS (Digital Theater Systems):** Compressed digital audio, developed by Digital Theater Systems, Inc., which enables multi-channel like Dolby Digital. As the compression ratio is lower than for Dolby Digital, it provides wider dynamic range and better separation.

When playing a multi-channel encoded DVD, the System properly converts these multi-channel signals into 2 channels, and emits the downmixed sound from the speakers.

- To enjoy the powerful sound of these multi-channel encoded DVDs,** connect a proper decoder or an amplifier with a proper built-in decoder to the digital output terminal on the rear.

IMPORTANT: Before playing a disc, make sure of the following...

- Turn on the TV and select an appropriate input mode on the TV to view the pictures or on-screen displays on the TV screen.
- For disc playback, you can change the initial setting to your preference. See “Setup Menu Operations” on page 32.

If “⊗” appears on the TV screen when you press a button, the disc cannot accept the operation you have tried to do, or data required for that operation is not recorded on the disc.

- Manufactured under license from Dolby Laboratories. “Dolby”, “Pro Logic”, “MLP Lossless”, and the double-D symbol are trademarks of Dolby Laboratories.
- “DTS” and “DTS 2.0 + DIGITAL OUT” are trademarks of Digital Theater Systems, Inc.

“DVD Logo” is a trademark of DVD Format/Logo Licensing Corporation registered in the US, Japan and other countries.





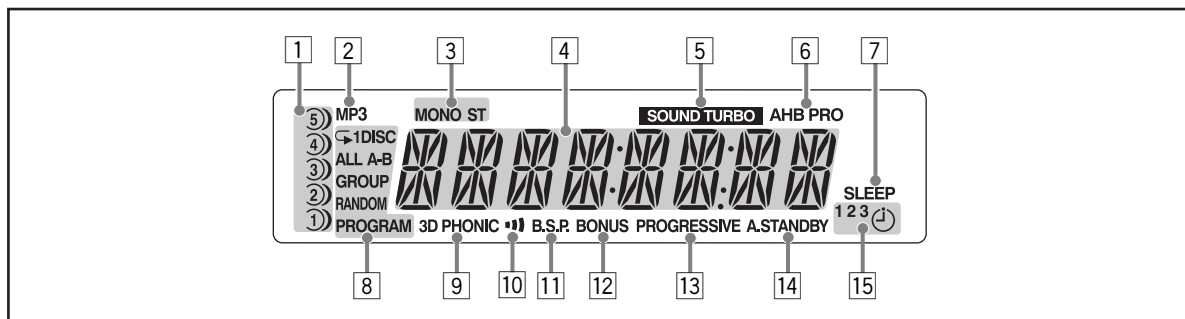

Display Indicators

The indications on the display teach you a lot of things while you are operating the System. Before operating the System, be familiar with when and how the indicator illuminates on the display.

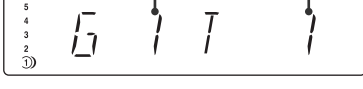

- 1 Disc tray indicators
 - 1–5: Disc tray number indicators.
 - ○ (tray indicator):
 - Lights when the disc is detected.
 - Blinking while playing back a disc.
 - Goes off when there is no disc in the tray.
 - ◐ (disc indicator): Lights below when the tray indicator indicates the current selected disc.
- 2 MP3 indicator
 - Lights when the current track is recorded in MP3 format.
- 3 FM reception indicators
 - MONO: Lights when FM reception mode is monaural.
 - ST (stereo): Lights while an FM stereo station with sufficient signal strength is tuned in.
- 4 Main display
 - While listening to radio; band (or preset number) and station frequency appear.
 - While selecting “AUX”; “AUX” appears.
 - While playing a disc; see “Indications on the main display while operating a disc” on page 9.
- 5 SOUND TURBO indicator
 - Lights when SOUND TURBO II is activated (see page 15).
- 6 AHB (active hyper bass) PRO indicator
 - Lights when AHB PRO is activated (see page 15).
- 7 SLEEP indicator
 - Lights when the Sleep Timer is activated. (see page 18)
- 8 Disc operation indicators
 - ↺ : Lights when Repeat mode is activated.
 - 1: Lights when One Track Repeat is activated.
 - 1DISC: Lights when One Disc Repeat is activated.
 - ALL: Lights when All Disc Repeat is activated.
 - A-B: Lights when A-B Repeat is activated.
 - GROUP: Lights when Group Repeat is activated.
 - RANDOM: Lights when Random Play mode is activated.
 - PROGRAM: Lights when Program Play mode is activated.
- 9 3D PHONIC indicator
 - Lights when 3D PHONIC is activated (see page 13).
- 10 Clear Voice indicator
 - Lights when Clear Voice function is activated (see page 16).
- 11 B.S.P. indicator
 - Lights when the current disc is DVD Audio with browsable still picture (see page 21).
- 12 BONUS indicator
 - Lights when a DVD Audio with a bonus group is detected (see page 20).
- 13 PROGRESSIVE indicator
 - Lights when progressive scanning mode is selected (see page 6).
- 14 A. (auto) STANDBY indicator
 - Lights when Auto Standby is activated.
 - Flashes when disc playback stops with Auto Standby activated.
- 15 Timer indicators
 - ⌚ : Lights when Daily Timer stands by; flashes while working.
 - 1/2/3: Lights up when a Daily Timer (1, 2, or 3) stands by; flashes while setting or working.

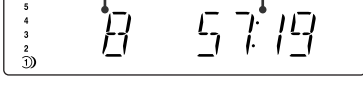
Indications on the main display while operating a disc

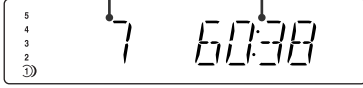
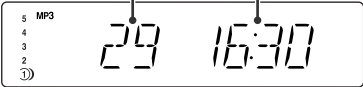
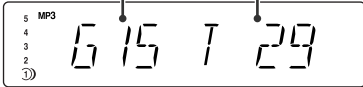
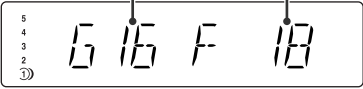
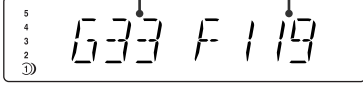
While playing back a disc:	While disc play is stopped:
<ul style="list-style-type: none"> DVD Video: <div style="display: flex; justify-content: space-around; margin-top: 10px;"> Chapter no. Elapsed playing time </div>  By pressing SHIFT+DISPLAY, you can show the current title and chapter numbers for a few seconds. 	<ul style="list-style-type: none"> DVD Video: <div style="display: flex; justify-content: space-around; margin-top: 10px;"> Total title no. </div> 
<ul style="list-style-type: none"> DVD Audio: <div style="display: flex; justify-content: space-around; margin-top: 10px;"> Track no. Elapsed playing time </div>  By pressing SHIFT+DISPLAY, you can show the current group and track numbers for a few seconds. 	<ul style="list-style-type: none"> DVD Audio: <div style="display: flex; justify-content: space-around; margin-top: 10px;"> Group no. Track no. </div> 
<ul style="list-style-type: none"> Audio CD: <div style="display: flex; justify-content: space-around; margin-top: 10px;"> Track no. Elapsed playing time </div>  	<ul style="list-style-type: none"> Audio CD: <div style="display: flex; justify-content: space-around; margin-top: 10px;"> Total track no. Total playing time </div> 
<ul style="list-style-type: none"> SVCD/VCD: <div style="display: flex; justify-content: space-around; margin-top: 10px;"> Track no. Elapsed playing time* </div>  * "PBC" appears while playing a disc with PBC. 	<ul style="list-style-type: none"> SVCD/VCD: <div style="display: flex; justify-content: space-around; margin-top: 10px;"> Total track no.* Total playing time </div>  * Changes to "PBC" when stopping PBC playback.
<ul style="list-style-type: none"> MP3: <div style="display: flex; justify-content: space-around; margin-top: 10px;"> Track no. Elapsed playing time </div>  By pressing DISPLAY, you can show the current group and track numbers for a few seconds. 	<ul style="list-style-type: none"> MP3: <div style="display: flex; justify-content: space-around; margin-top: 10px;"> Current group no. Current track no. </div> 
<ul style="list-style-type: none"> JPEG: <div style="display: flex; justify-content: space-around; margin-top: 10px;"> Group no. File no. </div>  	<ul style="list-style-type: none"> JPEG: <div style="display: flex; justify-content: space-around; margin-top: 10px;"> Current group no. Current file no. </div> 

• If "RESUME" is "ON" (see page 35), "RESUME" appears when you stop playback (except for Audio CD and MP3/JPEG discs).

Daily Operations—Playback

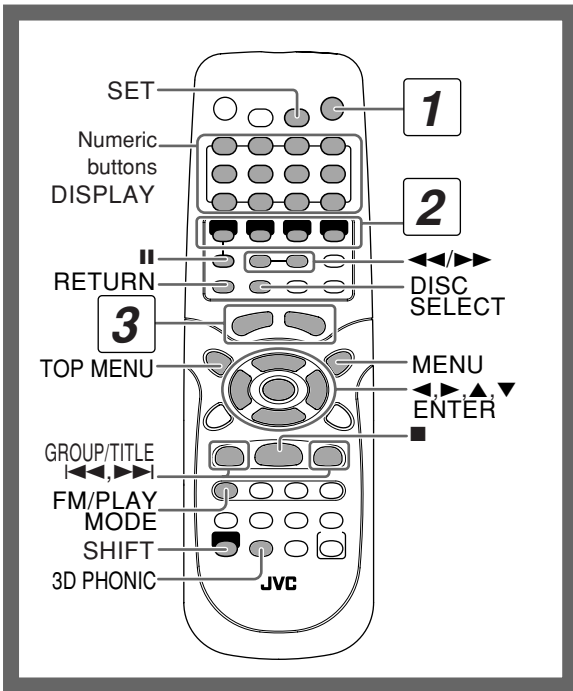

1 Turn on the power.

The STANDBY lamp on the main unit turns off.

- Without pressing AUDIO $\phi/1$, the System turns on by pressing one of the source selecting buttons in the next step.

2 Select the source.

Playback automatically starts if the selected source is ready to start.

- If you press AUX or USB, start playback source on the external component.

3 Adjust the volume.

4 Operate the target source as explained later.

To turn off (standby) the System

AUDIO



The STANDBY lamp on the main unit lights up.

- A small amount of power is always consumed even while on standby.

For private listening

Connect a pair of headphones to the PHONES jack on the main unit. The sound will no longer come out of the speakers. Be sure to turn down the volume before connecting or putting the headphones.

- Disconnecting the headphones will activate the speakers again.

DO NOT turn off (standby) the System with the volume set to an extremely high level; otherwise, the sudden blast of sound can damage your hearing, speakers and/or headphones when you turn on the System or start playback.

To turn off the clock indication to save the power

While the System is turned off...

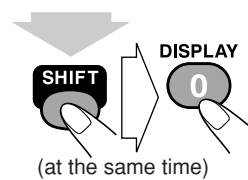

- Press the button again, to display the clock indication.

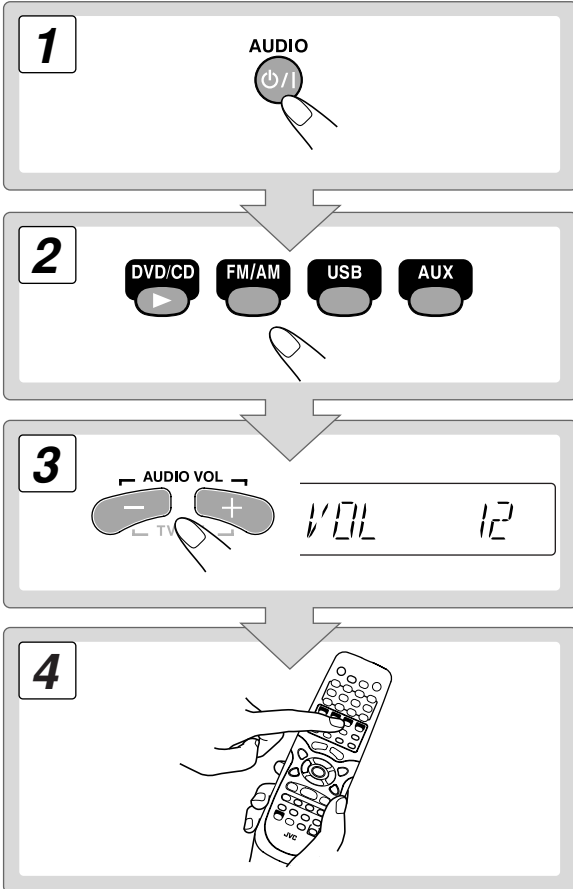

Listening to the Radio

To select the band (FM or AM)

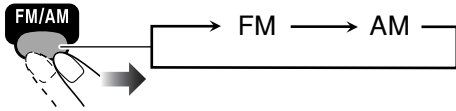

To tune in to a station

While FM or AM is selected...

Remote control:	Main unit:

Frequency starts changing on the display.

When a station (frequency) with sufficient signal strength is tuned in, the frequency stops changing.

- When you repeatedly press the button, the frequency changes step by step.

To stop searching manually, press either button.

If the received FM station is hard to listen



The MONO indicator lights on the display. Reception will improve though stereo effect is lost—Monaural reception mode.

To restore the stereo effect, press the button again (the MONO indicator goes off).

To preset the stations



You can preset 30 FM and 15 AM stations.

1 Tune in to a station you want to preset.

- You can also store the monaural reception mode for FM preset stations if selected.

2 Activate the preset number entry mode.

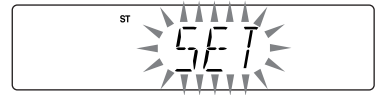

- Finish the following process while the indication on the display is flashing (5 seconds).

3 Select a preset number for the station you store.

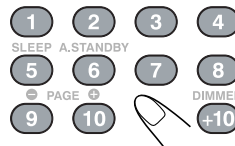

Examples:

To select preset number 5, press 5.

To select preset number 15, press +10, then 5.

To select preset number 30, press +10, +10, then 10.



4 Store the station.



To tune in to a preset station



1 Select a band (FM or AM).

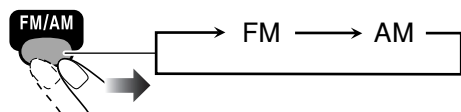

2 Select a preset number you have stored.

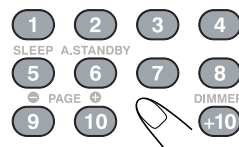

- You can also use the ◀▶ buttons to select a preset station.

Playing Back a Disc ●●●●●●●●

Before operating a disc, be familiar how a disc is recorded.

- DVD Video comprises of “Titles” which includes “Chapters,” DVD Audio/MP3 comprise of “Groups” which includes “Tracks,” and CD/SVCD/VCD comprise of only “Tracks.”
- For JPEG playback, see “Operations on the CONTROL Screen” on page 28.

To insert a disc

You can insert a disc while playing another source.

Main Unit:

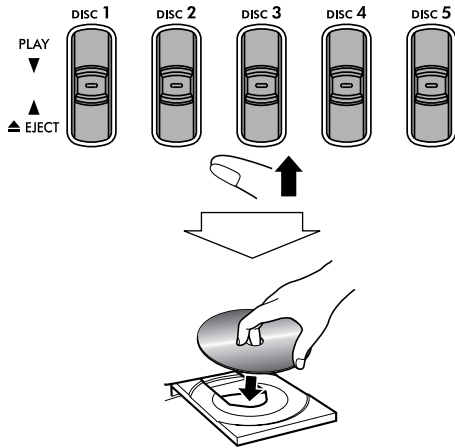

To close the disc tray and start playback, press down the same lever again.

- When current selected disc tray open, you can use DVD/CD ► to close the disc tray and start playback (depending on how the disc is programmed internally).
- When you press up ▲ EJECT for the next tray you want to place another disc onto, the first disc tray automatically closes and then next tray comes out.

To start:	To pause:	To stop:
	<p>To release, press DVD/CD ►.</p>	

- **While playing DVD/SVCD/VCD:** This System can store the stop point, and when you start playback again by pressing DVD/CD ►, it starts from the position where you have stopped—Resume Play. (“RESUME” appears on the display when you stop playback.)

To stop completely while Resume is activated, press ■ twice. (To cancel Resume, see “RESUME” on page 35.)

- When operating the System, the on-screen guide icon (see the following table) appears on the TV screen.

To deactivate the on-screen guide icons, see “ON SCREEN GUIDE” on page 35.

On-screen guide icons

- During DVD Video playback, the following icons may appear on the TV screen:

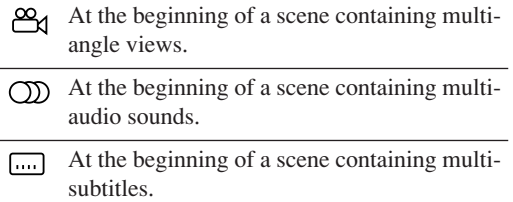

- The following icons will be also shown on the TV screen to indicate your current operation (for more details, see page 25).



To select a disc

Remote Control:

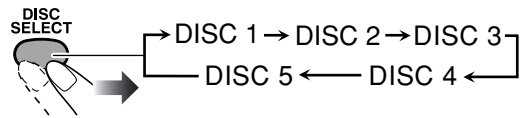

- When current source is not disc, press DVD/CD ► to select the disc player as the source during “PLAY” flashing on the display.

Main Unit:

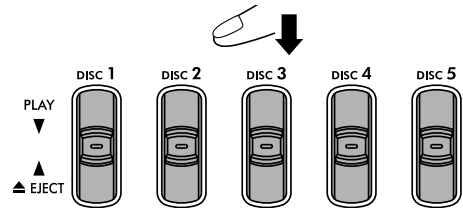

To select a title/group



While playing...

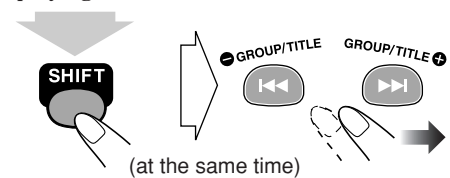

- Group name appears for MP3 discs.

To select a chapter/track

While playing...



- First time you press ◀◀, you can go back to the beginning of the current chapter/track.

To locate a particular portion



While playing a disc except MP3...



- No sound comes out while searching on DVD Video/SVCD/VCD.

To return to normal playback, press DVD/CD ►.

To locate an item directly



You can select a title/chapter/track directly and start playback.

- For DVD Video, you can select a **title before starting playback**.
- For DVD Video, you can select a **chapter after starting playback**.

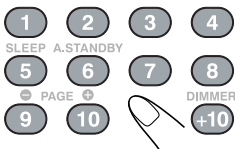

Examples:

- To select number 5, press 5.
- To select number 15, press +10, then 5.
- To select number 30, press +10, +10, then 10.

To use 3D PHONIC

While playing...

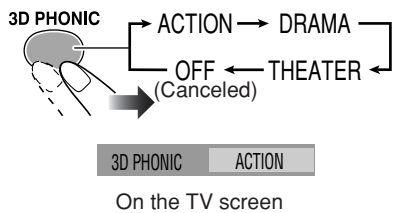

ACTION	Suitable for action movies and sports programs.
DRAMA	Creates natural and warm sound. Enjoy movies in a relaxed mood.
THEATER	Enjoy sound effects like in a major theater.

- 3D PHONIC indicator also lights up.

To play back using the disc menu



You can operate a disc—DVD and SVCD/VCD with Playback Control (PBC)—using the disc menu shown on the TV screen.

■ For DVD Video/DVD Audio:

1 Show the disc menu.

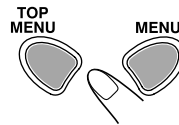

2 Select an item on the disc menu.

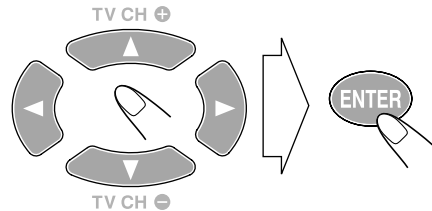

- You cannot use this function while **displaying the pull-down menu** (see page 26).
- With some discs, you can also select items by entering the number using the numeric buttons.

■ For SVCD/VCD with PBC:

While playing a disc with PBC, “PBC” appears on the display.

When disc menu appears on the TV screen, select an item on the menu. Playback of the selected item starts.

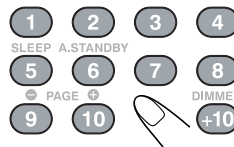

Examples:

- To select number 5, press 5.
- To select number 15, press +10, then 5.
- To select number 30, press +10, +10, then 10.

To move to the next or previous page of the current menu:

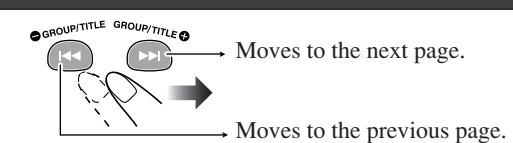

To return to the previous menu:

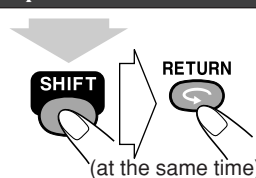

To cancel PBC

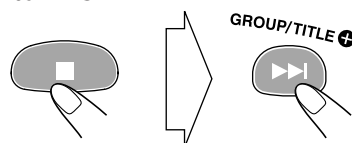

- You can also cancel PBC function by pressing the numeric buttons to select a track.

To reactivate PBC, press ■, then press ◀◀.

Playing Back from the PC

This System is equipped with a USB terminal on the front panel. You can connect your PC to this terminal and enjoy sound reproduced through your PC.

When you connect your PC for the first time, follow the procedure below.

- Remember you cannot send any signal or data to your PC from this System.

IMPORTANT

- Always set volume to “VOL MIN” when connecting or disconnecting the other equipment.

How to install the USB drivers

1 Turn on your PC and start running Windows® 98, Windows® 98SE, Windows® Me, Windows® 2000, or Windows® XP.

- If the PC has been turned on, quit all the applications running.

2 Select USB for the source.



3 Connect the System to the PC using a USB cable (not supplied).

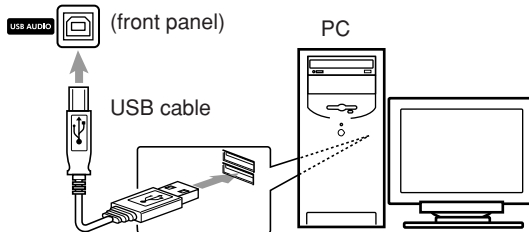

- Use “USB series A plug to B plug” cable when connecting.

4 The USB drivers are installed automatically.

To play back sounds on the PC

Refer to the manuals supplied with the sound reproduction application installed in the PC.

* Microsoft®, Windows® 98, Windows® 98SE, Windows® Me, Windows® 2000 and Windows® XP are registered trademarks of Microsoft corporation.

Playing Back from Other Equipment

To connect other equipment

By using a stereo mini plug cord (not supplied), you can connect other equipment with analog audio output jacks, such as an MD player, a TV, etc.

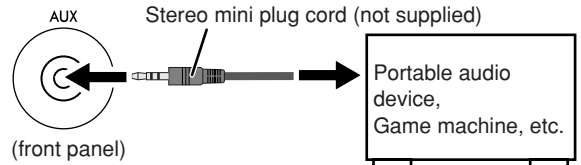

If the audio output on the other equipment is not stereo mini plug type,

Use a plug adapter to convert the stereo mini plug to the corresponding plug of the audio output.

- Refer to the manuals supplied with the other equipment.

IMPORTANT

- Always set volume to “VOL MIN” when connecting or disconnecting the other equipment.

To select other equipment for the source



Daily Operations—Sound&Other Adjustments

Remote control

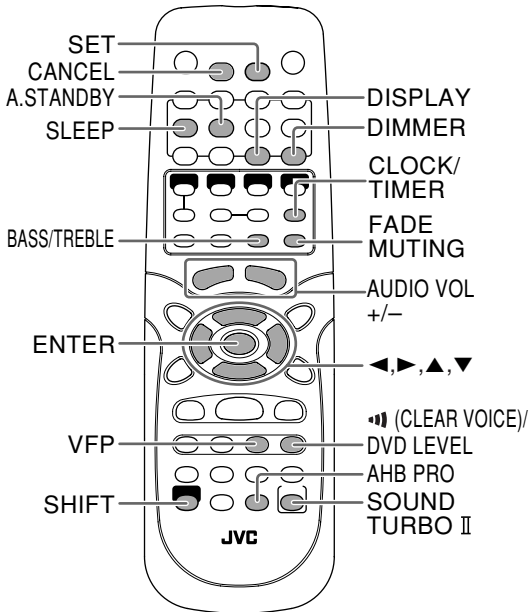

Main unit

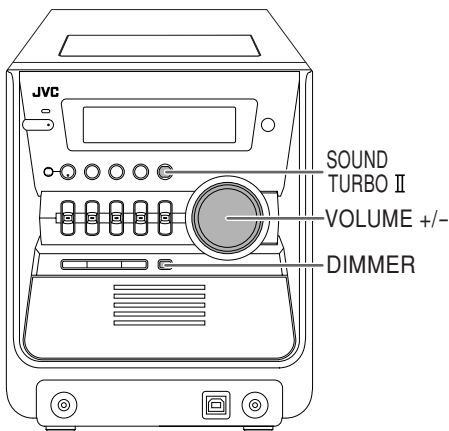

Adjusting the Volume

You can adjust the volume level from level 0 (VOL MIN) to level 31 (VOL MAX).

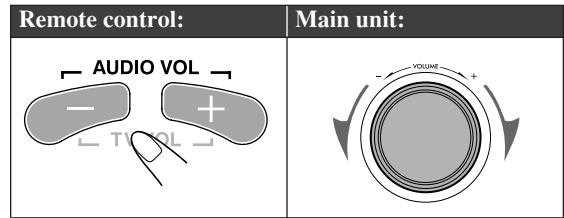

To drop the volume in a moment



To restore the volume, press again, or adjust the volume level.

Adjusting the Sound

To emphasize the sound—SOUND TURBO II

This function emphasizes the sound.

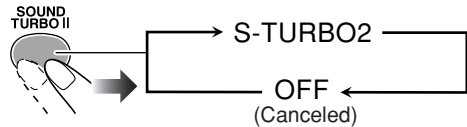

To emphasize heavy bass sound—AHB PRO



This function dynamically enhances bass response.

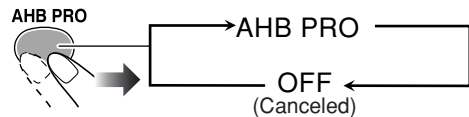

To adjust the tone—BASS/TREBLE



You can adjust the bass and treble level from 0 to +5.

- When you adjust this setting, the SOUND TURBO II is canceled automatically.

To adjust the bass

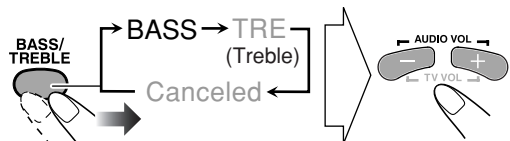

To adjust the treble

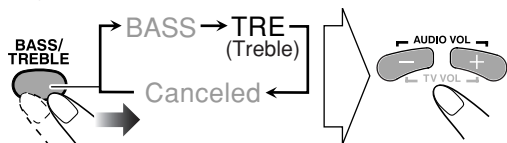

Making DVD Voice Clear—CLEAR VOICE



This function allows you to easily understand the dialog of DVD even with the volume turned down.

- This function only works for center-channel signal encoded multi-channel disc.

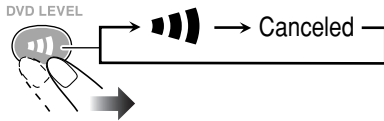

Presetting Automatic DVD Sound Increase

Level—DVD LEVEL



The DVD sound is sometimes recorded at a lower level than for other discs and sources. You can set the increase level for the currently loaded DVD.

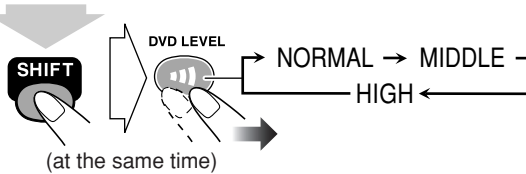

NORMAL	Original recording level.
MIDDLE	Output level is increased (less than “HIGH”).
HIGH	Output level is increased (more than “MIDDLE”).

- Once the current DVD is ejected, this setting is canceled and set automatically to “NORMAL.”

Changing the Display Brightness—DIMMER

You can dim the display window.

Remote Control:

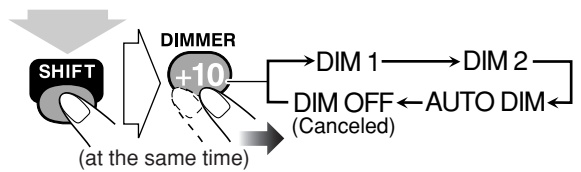

Main Unit:

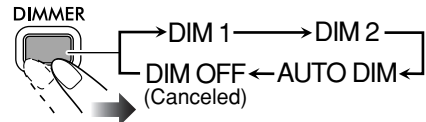

DIM 1	Dims the display.
DIM 2	Erases the display illumination.
AUTO DIM	Erases the display illumination when disc playback starts. <ul style="list-style-type: none"> • This function works only when playing DVD/VCD/SVCD or JPEG files. • The display illuminates when playback stops.

Changing the Picture Tone—VFP (Video

Fine Processor)



While showing a playback picture on the TV screen, you can select the preset picture tone, or adjust it and store your own likeliness.

To select a preset picture tone

1 Activate VFP.

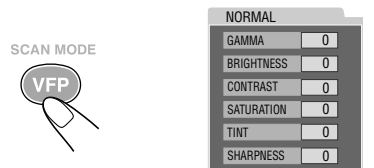

2 Select a preset picture tone.

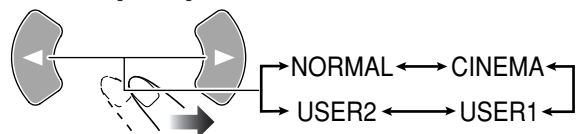

NORMAL	Normally select this.
CINEMA	Suitable for a movie source.
USER1/USER2	You can adjust parameters and can store the settings (see next page).

To adjust the picture tone

1 Select "USER1" or "USER2."

- Follow steps 1 and 2 explained on page 16.

2 Select a parameter you want to adjust.

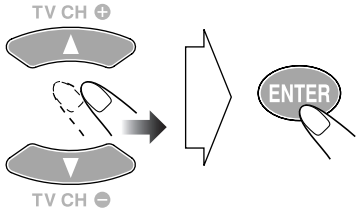

GAMMA	Adjust if the neutral color is bright or dark (-3 to +3).
BRIGHTNESS	Adjust if the entire picture is bright or dark (-8 to +8).
CONTRAST	Adjust if the far and near positions are unnatural (-7 to +7).
SATURATION	Adjust if the picture is whitish or blackish (-7 to +7).
TINT	Adjust if the human skin color is unnatural (-7 to +7).
SHARPNESS	Adjust if the picture is indistinct (-8 to +8).

3 Adjust the parameter.

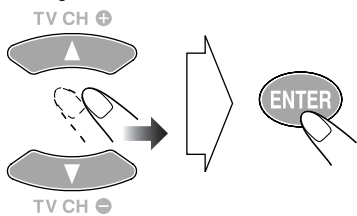

4 Repeat steps 2 to 3 to adjust other parameters.

To erase the screen, press VFP again.

Setting the Clock

Without setting the built-in clock, you cannot use the Daily Timer (see page 30) and Sleep Timer (see page 18).

- To exit from the clock setting, press CLOCK/TIMER as required.
- To go back to the previous step, press CANCEL.

1 Activate the clock setting mode.



- If you have already adjusted the clock before, press the button repeatedly until the clock setting mode is selected (see page 30).

2 Adjust the hour.

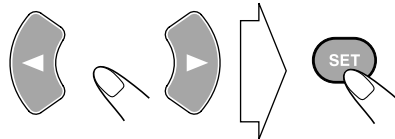

3 Adjust the minute.

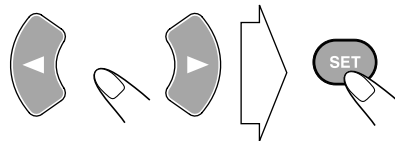

Now the built-in clock starts working.

To check the current clock time during play

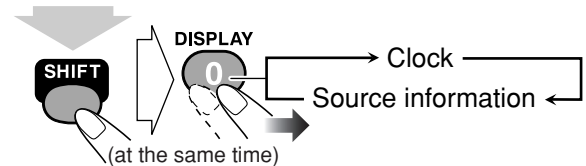

- While playing a DVD or MP3, you cannot check the current clock time (see page 9).

Turning Off the Power Automatically



To turn off the System after playback is over—Auto Standby

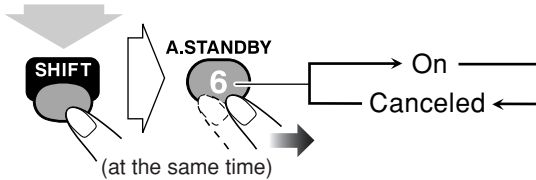

When Auto Standby is in use, the A.STANDBY indicator lights on the display. When the disc play stops, the A.STANDBY indicator starts flashing. If no operation is done for about 3 minutes while the indicator is flashing, the System turns off (in standby) automatically.

- Auto Standby does not work while you are listening to radio (FM/AM) and the external component (AUX and USB).

To turn off the System after a certain period of time—Sleep Timer

1 Specify the time (in minutes).

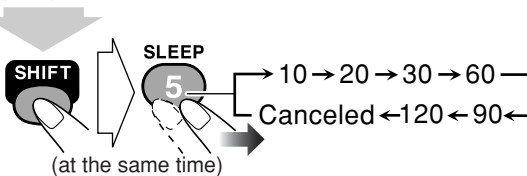

- SLEEP indicator also lights up on the display.

2 Wait until the set time goes off.

To check the time remaining until the shut-off time

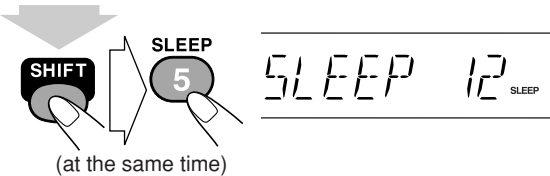

- If you press the button repeatedly, you can change the shut-off time.

Unique DVD/VCD Operations

Remote control

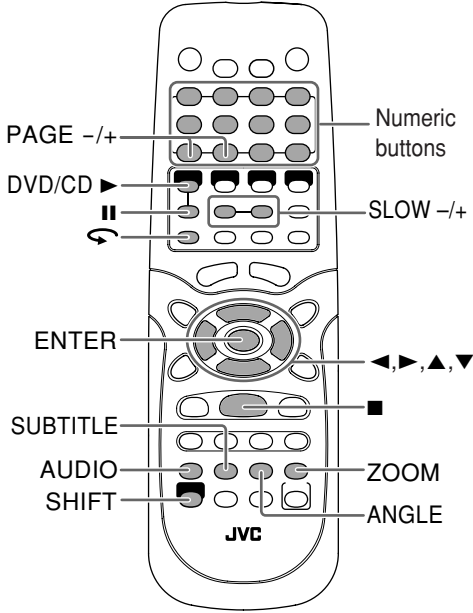

Selecting the Sound Track



For DVD Video: While playing back a chapter containing audio languages, you can select the language to listen to.

For DVD Audio: While playing back a track containing audio channels, you can select the audio channel to listen to.

For SVCD/VCD: While playing back a track, you can select the audio channel to play.

- You can also select the audio track using the on-screen bar (see page 25).



While playing a DVD Video...

Ex.:

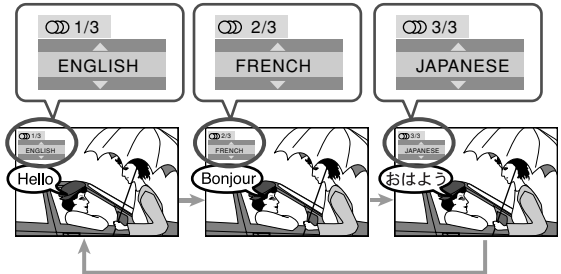

While playing a DVD Audio...

Ex.:

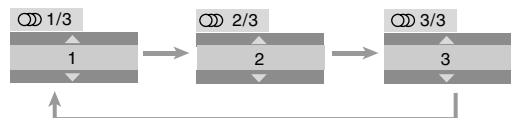

While playing an SVCD or VCD...

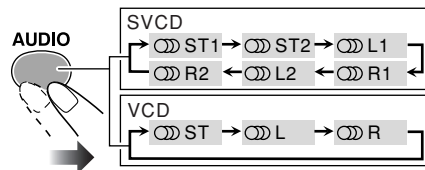

ST1/ST2/ST To listen to normal stereo (2 channel) playback.

L1/L2/L To listen to the left audio channel.

R1/R2/R To listen to the right audio channel.

- SVCD can have 4 audio channels. Karaoke SVCD usually uses these 4 channels to record two 2-channel recordings (ST1/ST2).

Selecting the Subtitle Language

For DVD Video: While playing back a chapter containing subtitles in different languages, you can select the subtitle language to display on the TV screen.

For SVCD: While playing back a track, you can select the subtitles even if no subtitles are recorded on the disc.

- You can also select the subtitle language using the on-screen bar (see page 25).

While playing a DVD Video...

1 Display the subtitle selection window.



2 Select the subtitle language.

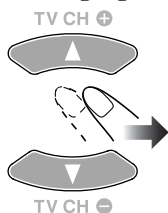

Ex.:

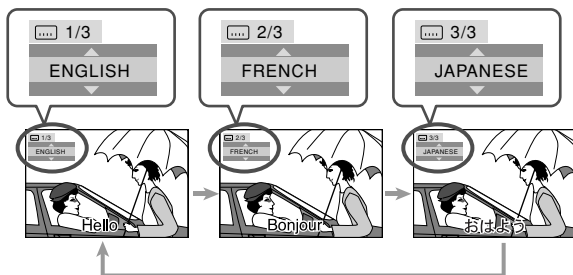

While playing an SVCD video...

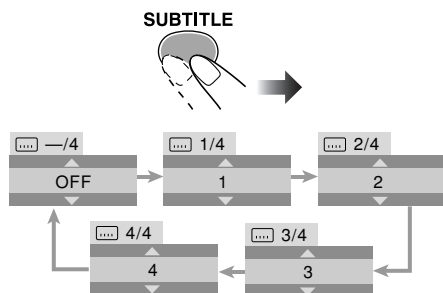

Selecting the View Angle

- This function is only used while playing DVD Video.

While playing back a chapter containing multi-view angles, you can view the same scene from different angles.

- You can also select the multi-view angles using the on-screen bar (see page 25).

While playing...

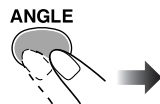

Ex.:

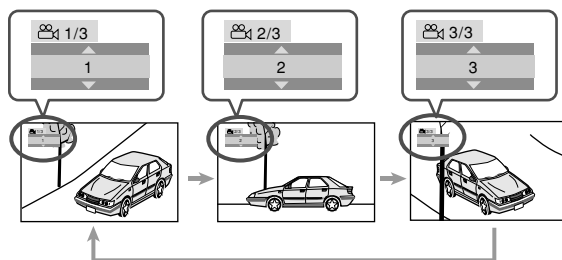

Playing Back a Bonus Group

- This function is only used while playing DVD Audio.

Some DVD Audios have a special group called “bonus group” whose contents are not open to the public.

- To play back a bonus group, you have to enter the specific “key number” (a kind of password) for the bonus group.

The way of getting the key number depends on the disc.

1 Select the bonus group.

- The bonus group is usually recorded as the last group (for example, if a disc contains 4 groups including a bonus group, “group 4” is the bonus group).

- When the bonus group is detected, BONUS indicator lights up.

- For how to select the group, see “To select a title/group” on page 12.

2 Enter the key number.

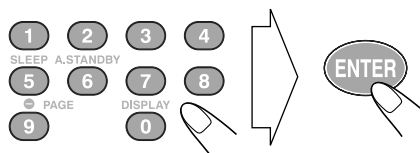

3 Follow the interactive instructions shown on the TV screen.

To cancel the key number entry, press ■.

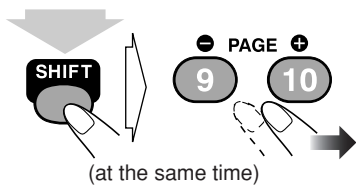

Selecting Browsable Still Pictures

- This function is only used while playing DVD Audio.
- While playing back a track linked to browsable still pictures (B.S.P.), you can select the still picture (turn the page) to be shown on the TV screen.
- When a DVD Audio with a bonus group is detected, B.S.P. indicator lights up.
- If a track is linked to browsable still pictures (B.S.P.), they are usually shown in turn automatically during playback.
- You can also select the page using the on-screen bar (see page 25).



Special Effect Playback

Still picture playback

To start still picture playback:	To resume normal playback:
While playing... 	

Frame-by-frame playback

1 While playing...



Still picture playback starts.

2 Advance the still picture frame by frame.



To resume normal playback, press DVD/CD ►.

Slow-motion playback

1 While playing...



Still picture playback starts.

2 Select slow-motion speed.

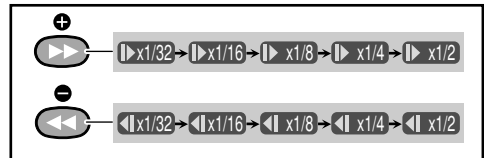
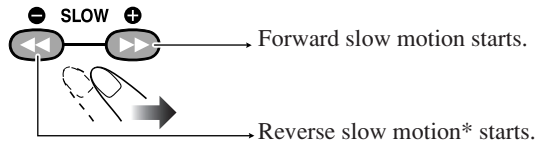

* Not available for SVCD/VCD.

To resume normal playback, press DVD/CD ►.

To replay the previous scenes (One touch replay function)

- This function is only used while playing DVD Video.

RETURN The playback position moves back about 10 seconds before the current position (only within the same title).



Zoom

1 While playing back...

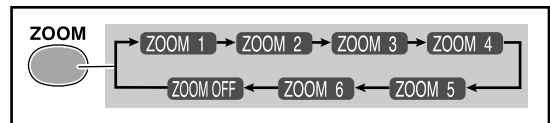
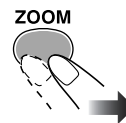

- As the number increases, magnification also increases.

2 Move the zoomed-in position.

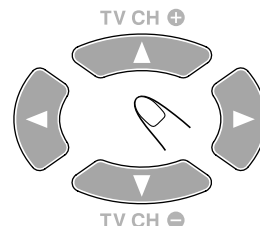

To resume normal playback, press ZOOM repeatedly until “ZOOM OFF” appears on the TV screen.

To use this function for JPEG (still pictures), see “To zoom in the still picture” on page 29.

Advanced Disc Operations

Remote control

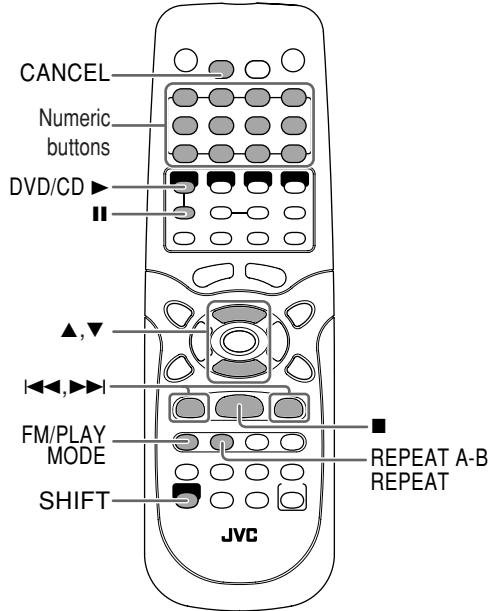

Main unit

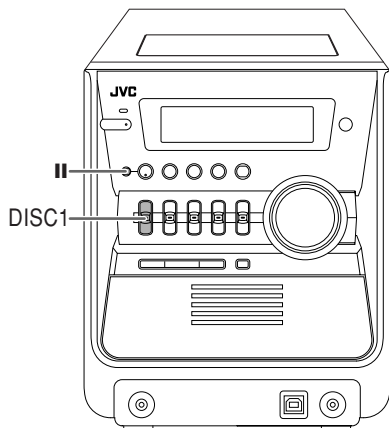

Programming the Playing Order

Program Play

You can arrange the playing order of the chapters or tracks (up to 99) before you start playback.

1 Before starting playback, activate Program Play.

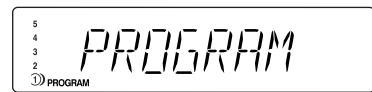
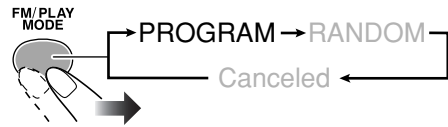

On the display

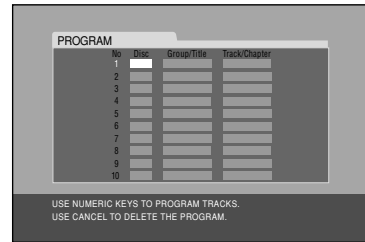

On the TV screen

2 Select chapters or tracks you want to program.

• For DVD/MP3:

- ① Select a disc number.
- ② Select a title or group number.
- ③ Select a chapter or track number.

• For SVCD/VCD/CD:

- ① Select a disc number.
- ② Select tracks.

• If the disc is not in current tray, the System may prompt for the group number entry as well, however, during playback, the System will ignore these entries.

To enter the numbers:

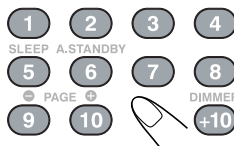

Examples:

To enter number 5, press 5.
 To enter number 15, press +10, then 5.
 To enter number 30, press +10, +10, then 10.

3 If you want to program the other chapters or tracks, repeat the above step 2.

4 Start playback.



Playback starts in the order you have programmed.

To skip a step:	To pause:	To stop:
	<p>To release, press DVD/CD ►.</p>	

To check the programmed contents

Before or after playback...

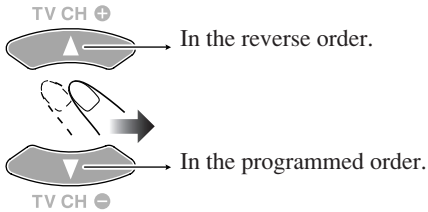

To modify the program

Before or after playback...

To erase the last step:	To erase the entire program:
To add steps in the program: Repeat step 2 on page 22.	

To exit from Program Play

Before or after playback...

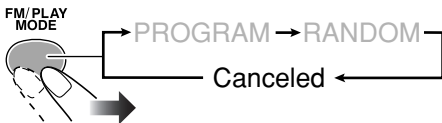

Playing at Random—Random Play



You can play the chapters or tracks of all loaded discs at random.

- Random Play cannot be used for some DVDs.

1 Before starting playback, activate Random Play.

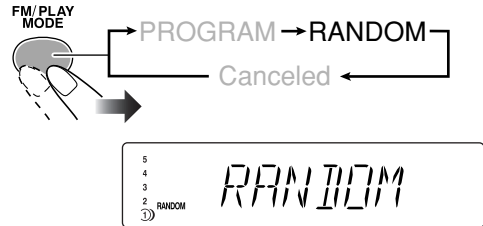

2 Start playback.



Playback starts in random order. Random Play continues to the disc on the next tray when all the chapters or tracks in current disc are played once (when Repeat Play is not activated).

- Playback ends when all the discs are played once (when Repeat Play is not activated).

To skip a chapter/track:	To pause:	To stop:
<p>To skip to the beginning of the current track, press ◀◀.</p>	<p>To release, press DVD/CD ►.</p>	

- During Random Play, you cannot select disc by using DISC SELECT.

To exit from Random Play

Before or after playback...

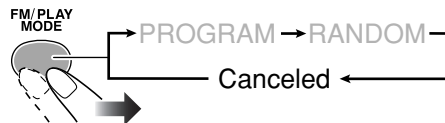

Playing Repeatedly



- You can also select the repeat mode using the on-screen bar (see page 26).

Repeat Play

You can repeat playback.

• For DVD Video:

During playing...

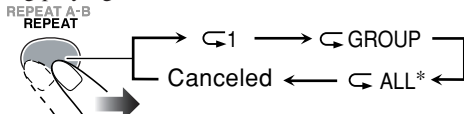

Before playback...

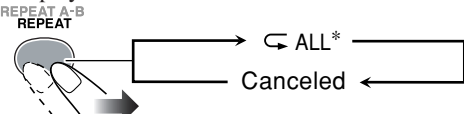

• For DVD Audio:

During or before playback...

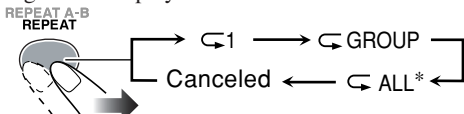

• For MP3:

During or before playback...

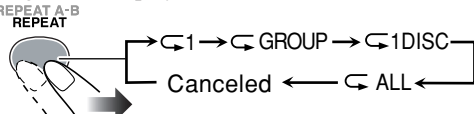

• For CD/SVCD/VCD:

During or before playback without PBC...

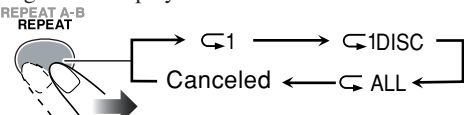

During playback with PBC...

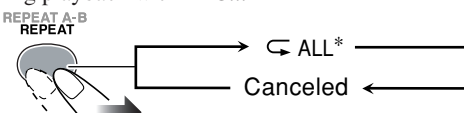

• For Program Play:

During or before playback...

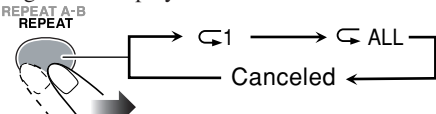

• For Random Play:

During or before playback...

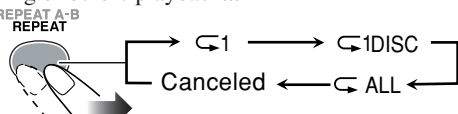

↶ ALL*	Repeats all discs in all tray or all programmed tracks.
↶ 1	Repeats the current chapter/track.
↶ GROUP	Repeats the current title/group.
↶ 1DISC	Repeats the current disc.
Canceled	Cancels Repeat Play mode.

*When DVD Video, DVD Audio or SVCD/VCD with PBC is loaded in the System, this function may not work correctly.

A-B Repeat

You can repeat playback of a desired portion by specifying the beginning (point A) and the ending (point B).

- A-B Repeat cannot be used for MP3 and for some DVDs.
- A-B Repeat can be used within the same title while playing a DVD Video, and within the same track for the other discs.

1 While playing (without PBC for SVCD/VCD), select the start point (A).

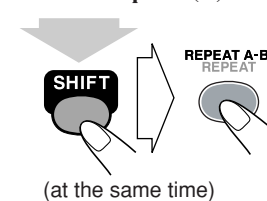

(at the same time)

↶ A- lights on the display.

- ↶ A- appears on the TV screen if the TV is turned on.

2 Select the end point (B).

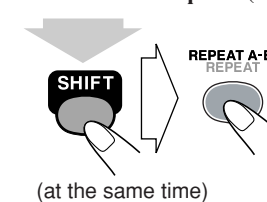

(at the same time)

↶ A- changes to ↶ A-B.

- ↶ A-B appears on the TV screen and A-B Repeat starts.
- You can search for the end point using ►►.

To cancel A-B Repeat, press REPEAT A-B again while holding SHIFT.

Prohibiting Disc Ejection—Child Lock



You can lock the disc trays so that no one can eject the loaded disc.

- This is possible while the System is on standby and the clock indication is turned on (see page 10).

While the disc trays are closed...

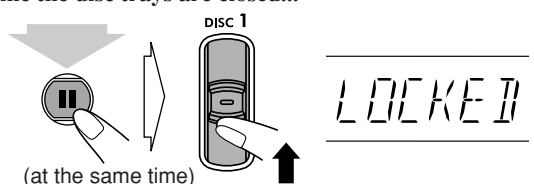

(at the same time)

To cancel the prohibition, repeat the same procedure. "UNLOCKED" appears on the display.

On-Screen Disc Operations

Remote control

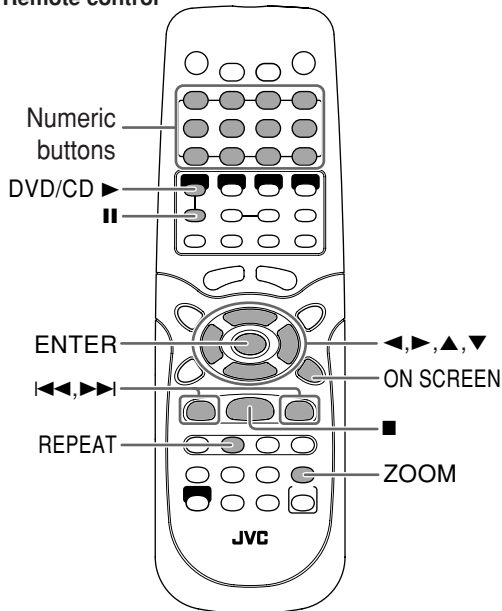

On-screen bars

DVD Video



DVD Audio



SVCD



VCD



CD

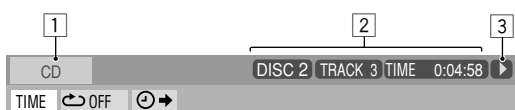

On-screen Bar Information

You can check the disc information (except for MP3/JPEG) and use some functions through the on-screen bar.

1 Disc type

2 Playback information

Indication	Meanings
Mbps	Current transfer rate (Megabits per second)
DISC 2	Current disc
TITLE 2	Current title
CHAP 3	Current chapter
GROUP 1	Current group
TRACK 14	Current track
TIME 1:25:58	Time indications

3 Operation modes

Indication	Meanings
[PLAY]	Playback
[FF] / [REW]	Forward/Reverse search
[SLOW FF] / [SLOW REW]	Forward/Reverse slow-motion
[PAUSE]	Pause
[STOP]	Stop

4 Function icons (on the pull-down menu)

Indication	Meanings
TIME	Select to change the time indication.
[REPEAT]	Select to repeat playback.
[SEARCH]	Select for time search.
CHAP. [RIGHT]	Select for chapter search.
TRACK [RIGHT]	Select for track search.
[AUDIO] 1/3	Select to change the audio language or channel (see also page 19).
[SUBTITLE] 1/3	Select to change subtitle language (see also page 20).
[VIEW] 1/3	Select to change the view angle (see also page 20).
PAGE 1/5	Select to change the page (see also page 21).

- You cannot use [LEFT], [RIGHT], [UP], and [DOWN] buttons to select the disc menu while displaying the pull-down menu.

Operations Using the On-screen Bar

Ex.: Selecting a subtitle (French) for DVD Video:
While a disc is selected as the source...

1 Display the on-screen bar with the pull-down menu.

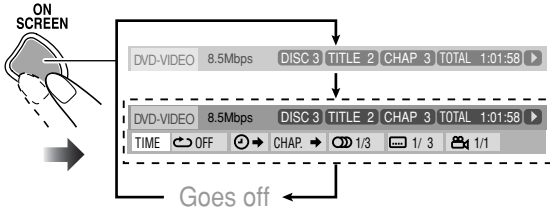

2 Select (highlight) the item you want.



3 Display the pop-up window.

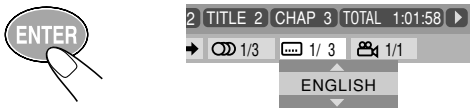

4 Select the desired option in the pop-up window.

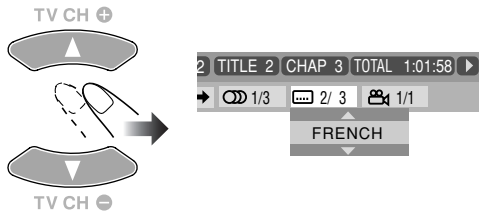

5 Finish the setting.



Pop-up window goes off.

To erase the on-screen bar



For detailed operations of the following functions, see also "Operations Using the On-screen Bar" on the left.

Changing the time information

You can change the time information in the on-screen bar and the display window on the main unit.

1 Display the on-screen bar with the pull-down menu.



2 Make sure **TIME** is selected (highlighted).

3 Change the time indication.

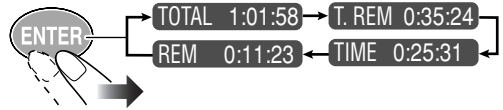

TOTAL	Elapsed disc time.
T. REM	Remaining disc time.
TIME	Elapsed playing time of the current chapter/track.
REM	Remaining time of the current chapter/track.

To erase the on-screen bar



Repeat Play

• See also page 24.

1 While playing (without PBC for SVCD/VCD), display the on-screen bar with the pull-down menu.

2 Select **OFF**.

3 Display the pop-up window.



4 Select the repeat mode you want.

ALL	Repeats all discs or all programmed tracks.
A-B	Repeats a desired portion (see next column).
TITLE	Repeats the current title.
GROUP	Repeats the current group.
DISC	Repeats the current disc (except for DVD).
CHAPTER	Repeats the current chapter.
TRACK*	Repeats the current track.
OFF	Cancels Repeat Play.

*During Program Play and Random Play, “STEP” appears.

5 Finish the setting.



A-B Repeat

• See also page 24.

1 While playing, display the on-screen bar with the pull-down menu.

2 Select [OFF].

3 Display the pop-up window.



4 Select “A-B”.



5 Select the start point (A).



6 Select the end point (B).



A-B Repeat starts. The selected portion plays repeatedly.

- Before pressing ENTER, you can search for the end point using ►►.

Time Search

You can move to a particular point by specifying the elapsed playing time.

For DVD Video/DVD Audio:

You can specify the elapsed time for the current title.

For CD/SVCD/VCD:

- While playing back, you can specify the elapsed time for the current track.
- While playback is stopped, you can specify the elapsed time for the disc. (You cannot use this function for SVCD/VCD with PBC)

1 Display the on-screen bar with the pull-down menu.

2 Select [TIME].

3 Display the pop-up window.



4 Enter the time.

You can specify the time in hours/minutes/seconds.

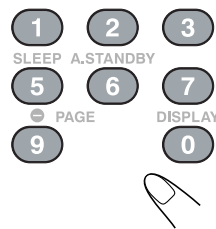

Examples:

To move to a point of 1 (hours): 02 (minutes): 00 (seconds), press 1, 0, 2, 0, then 0.

To move to a point of 54 (minutes): 00 (seconds), press 0, 5, 4, 0, then 0.

- It is always required to enter the hour digit (even “0” hour), but it is not required to enter trailing zeros (the last two digits in the examples above).
- To correct a misentry, press cursor ◀ to erase the last entry.

5 Finish the setting.



The System starts playing the disc from the selected playing time.

Chapter/Track Search

You can search for the chapter (DVD Video) or track (DVD Audio) number to play.

- 1 While playing, display the on-screen bar with the pull-down menu.
- 2 Select [CHAP. →] or [TRACK →].
- 3 Display the pop-up window.

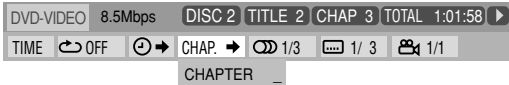

- 4 Enter the desired chapter/track number.

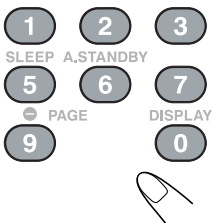

Examples:

To select chapter/track number 5, press 5.

To select chapter/track number 15, press 1, then 5.

To select chapter/track number 30, press 3, then 0.

- To correct a misentry, press the numeric buttons until the desired number shown in the pop-up window.

- 5 Finish the setting.



The System starts playing the searched chapter or track.

Operations on the CONTROL Screen

The CONTROL screen automatically appears on the TV screen when you load an MP3 or JPEG.

You can search for and play the desired tracks through the CONTROL screen.

- If both types of files (MP3 and JPEG) are recorded on a disc, select the file type to play (see page 34).

CONTROL screen
Ex.: When the MP3 disc is loaded.

1	Group : (2 / 3)	Track : (5 / 14 (Total 41))
2	Blue	Cloudy.mp3
3	Red	Fair.mp3
4	Green	Fog.mp3
		Hail.mp3
		Indian summer.mp3
5	Track Information	Rain.mp3
	Title	Shower.mp3
	Rain	Snow.mp3
	Artist	Thunder.mp3
	Album	Typhoon.mp3
		Wind.mp3
		Winter sky.mp3

- 1 Current group number/total group number
- 2 Current group
- 3 Group list
- 4 Current track (in blue)
- 5 Track information (ID3 Tag Version 1.0: only for MP3)
- 6 Repeat Play setting
- 7 Elapsed playing time of the current track (only for MP3)
- 8 Operation mode icon
- 9 Current track number/total number of tracks in the current group (total number of tracks on the disc)
- 10 Highlight (green) bar
- 11 Track list

To move the highlight bar between group list and track list

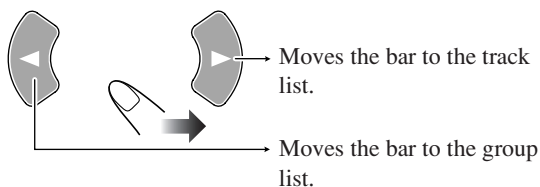

To select a group/track in the list

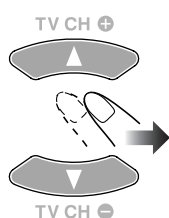

Move the highlight bar to a desired item.

- If you move the highlight bar while playing back an MP3 disc, the selected track starts playback automatically.

To start playback

For MP3:	
	Playback starts with the selected track. • Pressing DVD/CD ► also starts playback.
For JPEG:	
	The selected track (still picture) is displayed until you change it.
	Slide-show playback starts. Each track (still picture) is shown on the screen for few seconds, then changes one after another.

- Once you start playing back a JPEG track, the CONTROL screen goes off.
- To cancel slide-show and display the current still picture, press ENTER.

To skip a track:	To pause:	To stop playback:
	To release, press DVD/CD ►.	

To repeat slide-show for JPEG

While playing or before starting playback...

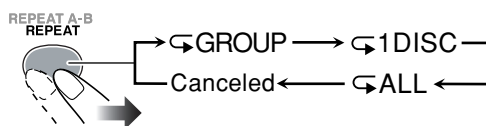

GROUP Repeats the current group.

1 DISC Repeats the current disc.

ALL Repeats all discs.

- For Repeat Play of MP3, see page 24.

To zoom in the still picture

- You cannot zoom in the still picture during slide-show.

1 While playing...

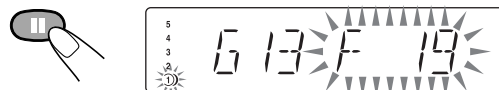

2 Change the magnification.

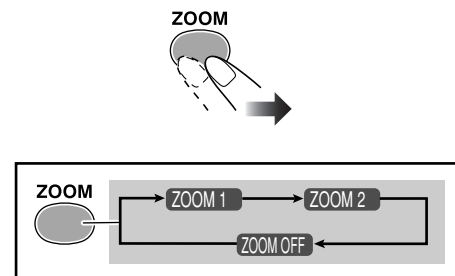

As the number increases, magnification also increases.

3 Move the zoomed-in position.

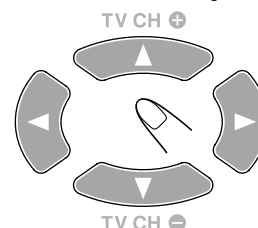

To resume normal playback, press ZOOM repeatedly until "ZOOM OFF" appears on the TV screen.

Timer Operations

Remote control

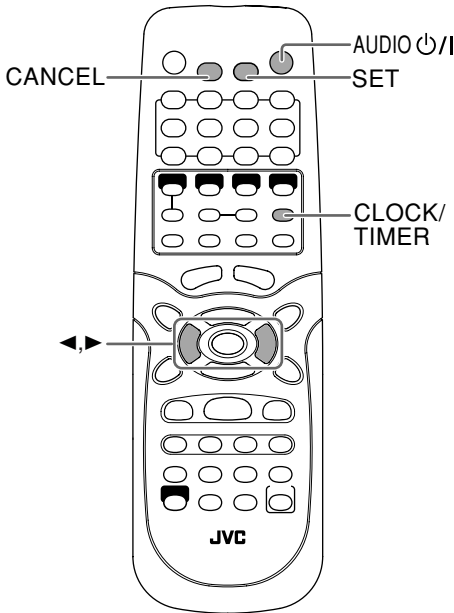

Setting the Daily Timer



Using Daily Timer, you can wake up with your favorite music.

You can store three Daily Timer settings; however, you can activate only one of the timers at a time.

- To exit from the timer setting, press **CLOCK/TIMER** as required.
- To correct a misentry during the process, press **CANCEL**. You can return to the previous step.

1 Select one of the timer setting modes you want to set—Daily 1 ON time, Daily 2 ON time, or Daily 3 ON time.

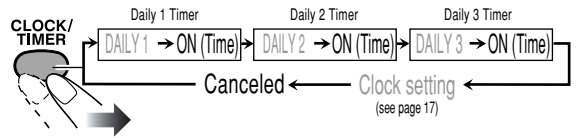

Ex.: When Daily Timer 1 setting mode is selected

- When the clock has not been adjusted, pressing **CLOCK/TIMER** makes the System enter the clock setting mode.

2 Make the timer setting as you want.

Repeat the following operations until you finish setting in the following order—

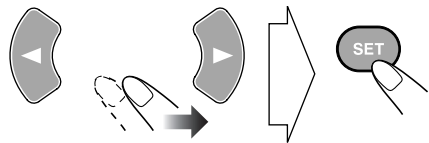

- ① Set the hour then the minute for on-time.
- ② Set the hour then the minute for off-time.
- ③ Select the playback source—"TUNER FM," "TUNER AM," "DISC," or "AUX."

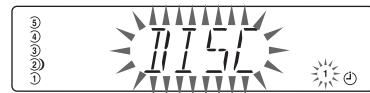

- ④ For "TUNER FM" and "TUNER AM": Select a preset channel (see page 11).
 - Select "FM --" or "AM --" for the last selected station.

For "DISC": Select the disc number, group number, then the track number (see page 12).

- Select "DISC -" for the last selected disc tray number.

For "AUX": Connect the other equipment (see page 14).

⑤ **Select the volume level.**

- You can select the volume level (“1” to “MAX” and “VOL --”). If you select “VOL --,” the volume is set to the last level when the System has been turned off.

Once settings are complete, the Timer setting information appears in sequence.

3 Turn off the System (on standby) if you have set the timer with the System turned on.



How Daily Timer actually works

Once the Daily Timer has been set, the timer (⊕) indicator and timer number indicator (1/2/3) are lit on the display. Daily Timer is activated at the same time everyday until the timer is turned off manually (see the next column) or another timer is activated.

When the on-time comes

The System turns on, tunes in to the specified station or start playing the loaded disc with the specified track, and sets the volume level to the preset level.

- You cannot start the specified title/chapter/track of DVD-Video/SVCD/VCD, though you can select it at the timer setting.
DVD-Video/SVCD/VCD starts playback from the beginning.
- While Daily Timer is working, the timer (⊕) indicator and timer number indicator (1/2/3) flash on the display.

When the off-time comes

The System stops playback, and turns off (on standby) automatically.

- The timer setting remains in memory until you change it.

To turn off the Timer after its setting is done

Since Daily Timer is activated at the same time everyday, you may need to cancel it on some particular days.

1 Select the Timer you want to cancel.

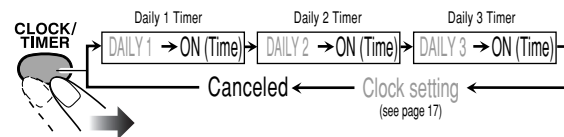

Ex.: To cancel Daily Timer 1

2 Turn off the selected Timer.



To turn on the Timer

1 Select the Timer (DAILY 1, DAILY 2, or DAILY 3) you want to activate.

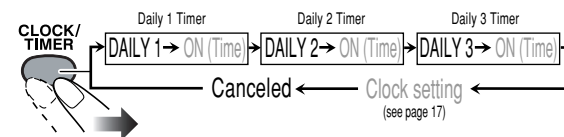

Ex.: When Daily Timer 1 is selected

2 Activate the selected Timer.



Setup Menu Operations

Remote control

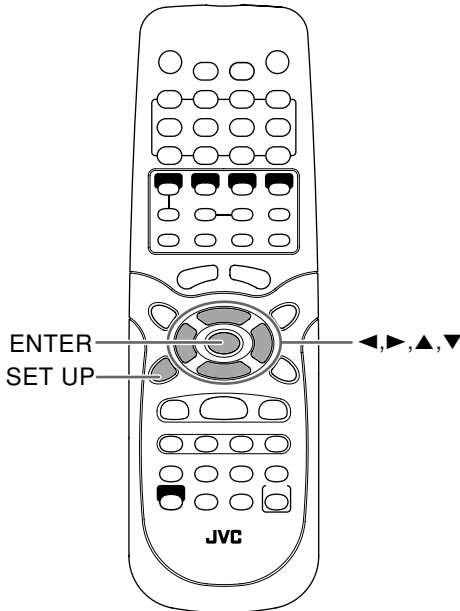

Setup Menu Icons

The icon for the selected Setup Menu will be highlighted.

Ex.: LANGUAGE Setup Menu is selected.

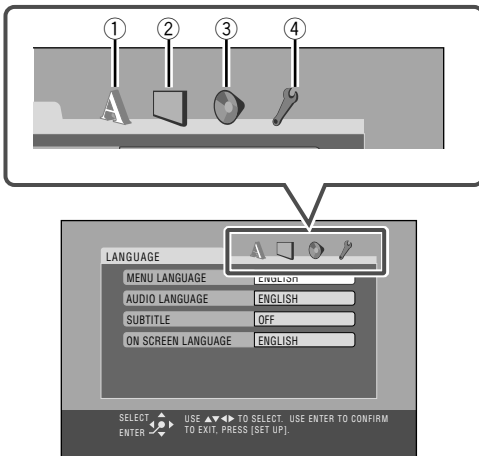

- ① LANGUAGE Setup Menu
- ② PICTURE Setup Menu
- ③ AUDIO Setup Menu
- ④ OTHERS Setup Menu

Operating Procedure

You can use the Setup Menus only when a disc is selected as the source and its playback is not yet started.

Ex.: Selecting "STILL PICTURE" for "FILE TYPE":

1 Display the Setup Menu.

SET UP



2 Select one of the Setup Menus.

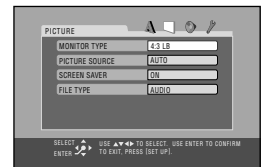

3 Select the item you want to adjust.

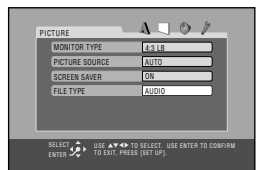
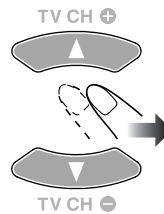

4 Display the pop-up window.

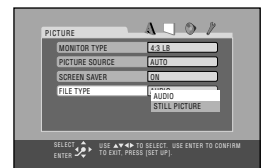

5 Select the desired option in the pop-up window.

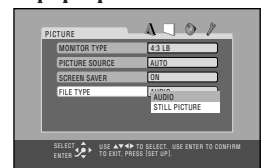
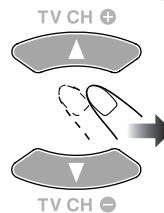

6 Finish the setting.



- 7 Repeat steps 3 to 4 to set other items on the same Setup Menu.
Repeat steps 2 to 4 to set other items on another Setup Menu.

To erase the Setup Menu



■ LANGUAGE Setup Menu

You can select the initial languages for disc playback. You can also select the language shown on the TV screen while operating this System.

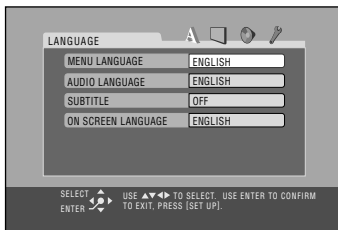

MENU LANGUAGE

Some discs have multiple menu languages. Select from—ENGLISH, SPANISH, FRENCH, CHINESE, GERMAN, ITALIAN, JAPANESE, AA – ZU (see “Language Code List” on page 41).

AUDIO LANGUAGE

Some discs have multiple audio languages. Select from—ENGLISH, SPANISH, FRENCH, CHINESE, GERMAN, ITALIAN, JAPANESE, AA – ZU (see “Language Code List” on page 41).

SUBTITLE

Some discs have multiple subtitle languages. Select from—ENGLISH, SPANISH, FRENCH, CHINESE, GERMAN, ITALIAN, JAPANESE, AA – ZU (see “Language Code List” on page 41) or “OFF (no subtitle).”

ON SCREEN LANGUAGE

Select one of the languages shown on the TV screen from—ENGLISH, SPANISH and FRENCH.

■ PICTURE Setup Menu

You can select the desired options concerning a picture or monitor screen.

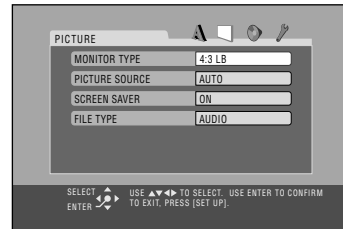

MONITOR TYPE

Select the monitor type of your TV to play DVD Video recorded with aspect ratio of 16:9.

Select one of the following:

16:9:

Select when the aspect ratio of your TV is 16:9 and when the TV has the screen size adjustment function.

4:3 LB (Letter Box):

Select when the aspect ratio of your TV is 4:3 (conventional TV). While viewing a wide screen picture, the black bars appear on the top and the bottom of the screen.

4:3 PS (Pan Scan):

Select when the aspect ratio of your TV is 4:3. While viewing a wide screen picture, the black bars do not appear; however, the left and right edges of the pictures will not be shown on the screen.

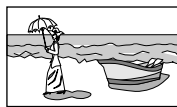

Ex.: 16:9



Ex.: 4:3 LB

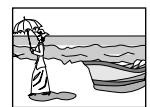

Ex.: 4:3 PS

PICTURE SOURCE

You can obtain optimal picture quality by selecting an appropriate option—picture source type (either video source or film source).

Select one of the following:

AUTO: Normally select this.
When playing back a disc containing both video and film sources, the System automatically changes the processing to match it to the picture type (film or video source) of the current chapter.

FILM: To play a film source disc.

VIDEO: To play a video source disc.

SCREEN SAVER

You can activate or deactivate screen saver while operating the built-in disc player.

Select one of the following:

ON: The picture on the TV screen becomes dark when no operation is done for about 5 minutes.

OFF: To cancel the screen saver.

FILE TYPE

If both audio tracks (MP3 files) and still pictures (JPEG files) are recorded on a disc, you can select which to play.

Select one of the following:

AUDIO: To play MP3 files.

STILL PICTURE: To play JPEG files.

■ AUDIO Setup Menu

You can adjust the sound settings of the System.

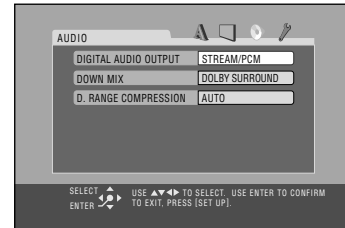

DIGITAL AUDIO OUTPUT

When using the digital output terminal on the rear, set this correctly according to the connected component.

Select one of the following:

PCM ONLY: To connect to a linear PCM digital equipment.

DOLBY DIGITAL /PCM: To connect to a Dolby Digital decoder or an amplifier with a built-in Dolby Digital decoder.

STREAM/PCM: To connect to a DTS decoder or an amplifier with a built-in DTS decoder.

• See also “OPTICAL DIGITAL OUT Signals” on page 42.

DOWN MIX

When using the digital output on the rear, set this correctly according to the connected component.

When playing a multi-channel DVD, the System converts the signals into 2 channels properly.

Select one of the following:

DOLBY SURROUND: To connect an amplifier with the Dolby Pro Logic decoder.

STEREO: To connect a conventional stereo amplifier, receiver, MD recorder, etc.

D. (Dynamic) RANGE COMPRESSION

You can compress the dynamic range (the difference between the loudest sound and the softest sound) to enjoy a powerful sound even at a low volume level when listening to Dolby Digital software. This is useful at night.

- The effectiveness varies depends on a software.

Select one of the following:

AUTO: To apply the compression effect to the downmixed multi-channel sound.

ON: To always apply the compression effect for all Dolby Digital software. Loud sound will become low and vice versa.

■ OTHERS Setup Menu

You can change some other convenient functions.



RESUME

You can activate or deactivate Resume for disc playback (see pages 12).

Select one of the following:

ON: To activate Resume.

OFF: To cancel Resume.

ON SCREEN GUIDE

You can activate or deactivate the on-screen guide icons (see pages 12 and 25).

- When recording the picture on a VCR, select "OFF" to avoid recording the guide icons on your video tape.

Select one of the following:

ON: To activate the on-screen guide icons.

OFF: To cancel the on-screen guide icons.

Operating the TV





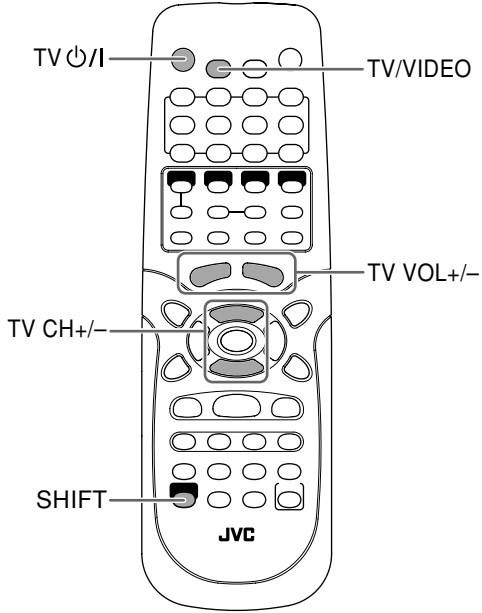

Remote control

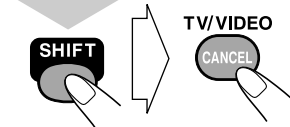

Operating TV

You can operate the JVC's TV using this remote control.

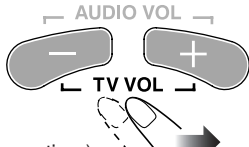
To operate the TV

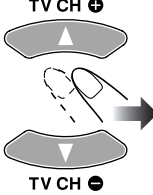
To turn on or off the TV:	To select the input mode (either TV or VIDEO):
	 <p>(at the same time)</p>
To adjust the TV volume:	
	 <p>(at the same time)</p>
To select the TV channel:	
	 <p>(at the same time)</p>

Additional Information

Learning More about This System ● ● ●

Getting Started (see pages 3 to 6)

Changing the Scanning Mode:

- To enjoy the progressive video picture, connect a TV with the progressive video input using component video cord.

Daily Operations—Playback (see pages 10 to 14)

Listening to the Radio:

- If you store a new station into an occupied preset number, the previously stored station in that number will be erased.
- When you unplug the AC power cord or if a power failure occurs, the preset stations will be erased in a few days. If this happens, preset the stations again.

Playing Back a Disc:

- When using an 8 cm (3-3/16 inch) disc, place it on the inner circle of the disc tray.
- On some DVD, SVCD, or VCD discs, the actual operations may be different from what is explained in this manual, due to the programming and disc structure; such differences are not malfunction of this System.
- When discs* in more than one tray are loaded on the disc trays, they are played in sequence as follows. (When DVD Video, DVD Audio or SVCD/VCD with PBC is loaded in the System, playback of the disc next to these discs will not start.):

Ex.: When DISC 2 is selected:

DISC 2⇒DISC 3⇒DISC 4⇒DISC 5⇒DISC 1⇒
(then stops)

- * When no disc is loaded on the disc tray, that disc number is skipped.
- You can exchange discs while playing or selecting another disc.
- Some DVD Audio discs prohibit downmixed output. When you play back such a disc, “LR ONLY” appears on the display and the System plays back the left front and right front signals.
- 3D Phonic setting is also applied to the optical digital output signals through the OPTICAL DIGITAL OUT terminal.
- For MP3/JPEG playback...
 - This System cannot play “packet write” discs.
 - MP3/JPEG discs require a longer readout time than regular CDs. (It depends on the complexity of the group/file configuration.)
 - Some MP3/JPEG files cannot be played back and will be skipped. This result from their recording processes and conditions.
 - When making MP3 discs, use ISO 9660 Level 1 or Level 2 for the disc format.
 - This System can play back MP3/JPEG files with the extension code <.mp3> or <.jpg> (regardless of the letter case—upper/lower).
 - It is recommended that you make each MP3 file at a sampling rate of 44.1 kHz and at bit rate of 128 kbps.

- This System can recognize the total of 1000 tracks and of 99 groups (each group can contain up to 150 tracks). Those exceeding the maximum number cannot be recognized.
- This System can show up to 23 characters of the file (track) names (except for extension) and 30 characters of the ID3 tags on the display and the TV screen.
- Some characters or symbols will not be shown (and will be blanked) on the display.
- When using Resume on SVCD or VCD with PBC, the playback might start on a position slightly different from where you have stopped.
- You can use Resume only for the DVD/SVCD/VCD except for some discs—depending how the disc is programmed.

Playing Back from the PC:

- Check if your PC equipped with the CD-ROM drive is running on Windows® 98*, Windows® 98SE*, Windows® Me*, Windows® 2000*, or Windows® XP* and prepare its CD-ROM.
- DO NOT turn off the System or disconnect the USB cable while installing the drivers and for a several seconds each time your PC is recognizing the System.
- Use a full speed USB cable (version 1.1).
- If your PC does not recognize the System, disconnect the USB cable and connect it again. If this does not work, restart Windows.
- The drivers installed can be recognized only when the USB cable is connected between the System and your PC.
- The sound may not be played back correctly—interrupted or degraded—due to your PC settings or PC specifications.

* Microsoft®, Windows® 98, Windows® 98SE, Windows® Me, Windows® 2000 and Windows® XP are registered trademarks of Microsoft corporation.

Daily Operations—Sound&Other Adjustments (see pages 15 to 18)

Adjusting the Volume:

- Be sure to turn down the volume before connecting or putting the headphones.

Adjusting the Sound:

- This function also affects the sound through the headphones.

Setting the clock:

- “AM 12:00” will flash on the display until you set the clock.
- The clock may gain or lose 1 to 2 minutes per month. If this happens, reset the clock.

Unique DVD/VCD Operations (see pages 19 to 21)

- During slow-motion playback, no sound will be reproduced.
- One touch replay function works only within the same title, though it works between chapters.
- While zoomed in, the picture may look coarse.

Advanced Disc Operations (see pages 22 to 24)

Programming the Playing Order—Program Play:

- If you try to program a 100th track, “MEM FULL (memory full)” appears on the display.
- While programming steps...
Your entry will be ignored if you have tried to program an item number that does not exist on the disc (for example, selecting track 14 on a disc that only has 12 tracks).
- You cannot use Program Play and Random Play for JPEG discs.
- You cannot eject tray while in Program Play.

Playing at Random—Random Play:

- The **◀◀** button does not work for skipping chapters or tracks, but only work for going back to the beginning of the current chapter or track.

On-Screen Disc Operations (see pages 25 to 29)

- For JPEG files playback...
 - It is recommended that you record a file at 640 x 480 resolution. (If a file has been recorded at a resolution of more than 640 x 480, it will take a long time to be shown.)
 - This System can play only baseline JPEG files. Progressive JPEG files or lossless JPEG files cannot be played.
 - Baseline JPEG format: Used for digital cameras, web, etc.
 - Progressive JPEG format: Used for web.
 - Lossless JPEG format: An old type and rarely used now.
 - This System may not play back JPEG files properly which are recorded by the devices other than digital still camera.
 - If progressive or lossless JPEG files are played back, a black screen appears. In this case, stop playback and select a baseline JPEG file. Note that it may take a long time to select another file.

Timer Operations (see pages 30 and 31)

- When you unplug the AC power cord or if a power failure occurs, the timer will be canceled. You need to set the clock first, then the timer again.
- If you set the Sleep Timer after Daily Timer starts playing the selected source, Daily Timer is canceled.

Setup Menu Operations (see pages 32 to 35)

LANGUAGE Setup Menu:

- When the language you have selected for “MENU LANGUAGE,” “AUDIO LANGUAGE,” or “SUBTITLE” is not recorded on a disc, the original language is used as the initial language.

PICTURE Setup Menu—MONITOR TYPE:

- Even if “4:3 PS” is selected, the screen size may become 4:3 letter box with some DVD Video discs. This depends on how the discs are recorded.
- When you select “16:9” for a picture whose aspect ratio is 4:3, the picture slightly changes due to the process for converting the picture width.

AUDIO Setup Menu—DOWN MIX:

- This setting is not effective when DTS multi-channel software is played back.

OTHERS Setup Menu—ON SCREEN GUIDE:

Setup Menus and on-screen bar will be displayed (and recorded) even though this function is set to “OFF.” Subtitles and the information for zooming in always appear on the display regardless of this setting.

MP3/JPEG groups/tracks configuration

This System plays back the tracks as follows.

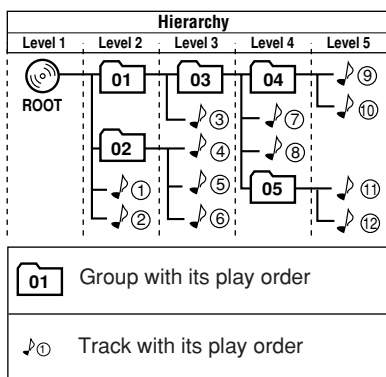

Maintenance

To get the best performance of the System, keep your discs and mechanism clean.

Handling discs

- When removing the disc from its case, hold it at the edge while pressing the center hole lightly.
- Do not touch the shiny surface of the disc, or bend the disc.
- Put the disc back in its case after use to prevent warping.
- Be careful not to scratch the surface of the disc.
- Avoid exposure to direct sunlight, temperature extremes, and moisture.

To clean the disc:

Wipe the disc with a soft cloth in a straight line from center to edge.

Cleaning the System

- Stains should be wiped off with a soft cloth. If the System is heavily stained, wipe it with a cloth soaked in water-diluted neutral detergent and wrung well, then wipe clean with a dry cloth.
- Since the System may deteriorate in quality, become damaged or get its paint peeled off, be careful about the following:
 - DO NOT wipe it with a hard cloth.
 - DO NOT wipe it strongly.
 - DO NOT wipe it with thinner or benzine.
 - DO NOT apply any volatile substance such as insecticides to it.
 - DO NOT allow any rubber or plastic to remain in contact for a long time.

To remove the speaker grilles

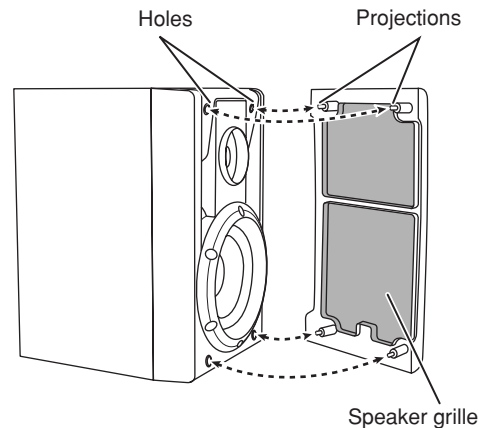

Troubleshooting ● ● ● ● ● ● ● ●

If you are having a problem with your System, check this list for a possible solution before calling for service.

General:

Adjustments or settings are suddenly canceled before you finish.

⇒ There is a time limit. Repeat the procedure again.

Operations are disabled.

⇒ The built-in microprocessor may malfunction due to external electrical interference. Unplug the AC power cord and then plug it back in.

Unable to operate the System from the remote control.

- ⇒ The path between the remote control and the remote sensor on the System is blocked.
- ⇒ Point it at the remote sensor on the front panel.
- ⇒ Signals cannot reach the remote sensor. Move closer to the System.
- ⇒ The batteries are exhausted.

No sound is heard from the speakers.

- ⇒ Speaker connections are incorrect or loose.
- ⇒ Headphones are connected.

No picture is displayed on the TV screen, the picture is blurred, or the picture is divided into two parts.

- ⇒ The video cord connections are incorrect or loose.
- ⇒ The System is connected to a TV which does not support progressive scanning.

The left and right edges of the picture are missing on the screen.

- ⇒ Select “4:3 LB” for “MONITOR TYPE” (see page 33).

Radio Operations:

Hard to listen to broadcasts because of noise.

- ⇒ Antennas connections are incorrect or loose.
- ⇒ The AM loop antenna is too close to the System.
- ⇒ The FM antenna is not properly extended and positioned.

Disc Operations:

The disc does not play.

- ⇒ The disc is placed upside down. Place the disc with the label side up.

ID3 Tag on an MP3 disc cannot be shown.

- ⇒ There are two types of ID3 Tag—Version 1 and Version 2. This System can show ID3 Tag Version 2.4 or earlier.

MP3/JPEG groups and tracks are not played back as you expect.

- ⇒ The playing order is determined when the disc was recorded. It depends on the writing application.

MP3/JPEG tracks are not played back.

- ⇒ The inserted disc may include both type of tracks (MP3 files and JPEG files). In this case, you can only play back the files selected by the “FILE TYPE” setting (see page 34).
- ⇒ You have changed the “FILE TYPE” setting after you inserted a disc. In this case, reload the disc.

“NO AUDIO” appears.

- ⇒ This System cannot play back illegally produced DVD Audio discs.

“LR ONLY” appears.

- ⇒ Some DVD Audio discs prohibit downmixed output. When you play back such a disc, this System plays back the left front and right front signals only.

The disc sound is discontinuous.

- ⇒ The disc is scratched or dirty.

The disc tray does not open or close.

- ⇒ The AC power cord is not plugged in.
- ⇒ Child Lock is in use (see page 24).

USB Operations:

Unable to play back through the USB connection.

- ⇒ USB connection and setting is incorrect (see page 14).

Timer Operations:

Daily Timer does not work.

- ⇒ The System has been turned on when the on-time comes. Timer starts working only when the System is turned off.

Setup Menu Operations:

No subtitle appears on the display though you have selected the initial subtitle language.

- ⇒ Some DVDs are programmed to always display no subtitle initially. If this happens, press SUBTITLE after starting play (see page 20).

Audio language is different from the one you have selected as the initial audio language.

- ⇒ Some DVDs are programmed to always use the original language initially. If this happens, press AUDIO after starting play (see page 19).

Language Code List

AA	Afar
AB	Abkhazian
AF	Afrikaans
AM	Ameharic
AR	Arabic
AS	Assamese
AY	Aymara
AZ	Azerbaijani
BA	Bashkir
BE	Byelorussian
BG	Bulgarian
BH	Bihari
BI	Bislama
BN	Bengali, Bangla
BO	Tibetan
BR	Breton
CA	Catalan
CO	Corsican
CS	Czech
CY	Welsh
DA	Danish
DZ	Bhutani
EL	Greek
EO	Esperanto
ET	Estonian
EU	Basque
FA	Persian
FI	Finnish
FJ	Fiji
FO	Faroese
FY	Frisian
GA	Irish
GD	Scots Gaelic
GL	Galician
GN	Guarani
GU	Gujarati
HA	Hausa
HI	Hindi
HR	Croatian
HU	Hungarian
HY	Armenian
IA	Interlingua
IE	Interlingue
IK	Inupiak
IN	Indonesian
IS	Icelandic
IW	Hebrew
JI	Yiddish

JW	Javanese
KA	Georgian
KK	Kazakh
KL	Greenlandic
KM	Cambodian
KN	Kannada
KO	Korean (KOR)
KS	Kashmiri
KU	Kurdish
KY	Kirghiz
LA	Latin
LN	Lingala
LO	Laothian
LT	Lithuanian
LV	Latvian, Lettish
MG	Malagasy
MI	Maori
MK	Macedonian
ML	Malayalam
MN	Mongolian
MO	Moldavian
MR	Marathi
MS	Malay (MAY)
MT	Maltese
MY	Burmese
NA	Nauru
NE	Nepali
NL	Dutch
NO	Norwegian
OC	Occitan
OM	(Afan) Oromo
OR	Oriya
PA	Panjabi
PL	Polish
PS	Pashto, Pushto
PT	Portuguese
QU	Quechua
RM	Rhaeto-Romance
RN	Kirundi
RO	Rumanian
RU	Russian
RW	Kinyarwanda
SA	Sanskrit
SD	Sindhi
SG	Sangho
SH	Serbo-Croatian
SI	Singhalese
SK	Slovak

SL	Slovenian
SM	Samoaian
SN	Shona
SO	Somali
SQ	Albanian
SR	Serbian
SS	Siswati
ST	Sesotho
SU	Sundanese
SV	Swedish
SW	Swahili
TA	Tamil
TE	Telugu
TG	Tajik
TH	Thai
TI	Tigrinya
TK	Turkmen
TL	Tagalog
TN	Setswana
TO	Tonga
TR	Turkish
TS	Tsonga
TT	Tatar
TW	Twi
UK	Ukrainian
UR	Urdu
UZ	Uzbek
VI	Vietnamese
VO	Volapuk
WO	Wolof
XH	Xhosa
YO	Yoruba
ZU	Zulu

OPTICAL DIGITAL OUT Signals

DIGITAL AUDIO OUT Playback disc	Output Signals		
	STREAM/PCM	DOLBY DIGITAL/PCM	PCM ONLY
DVD Video			
with 48 kHz, 16/20/24 bit Linear PCM	48 kHz, 16 bit Linear PCM* ¹		
with 96 kHz, Linear PCM	48 kHz, 16 bit Linear PCM		
with Dolby Digital	Dolby Digital bitstream		48 kHz, 16 bit Linear PCM
with DTS	DTS bitstream	48 kHz, 16 bit Linear PCM	
DVD Audio			
with 48/96/192 kHz, 16/20/24 bit Linear PCM	no output* ²		
with 44.1/88.2/176.4 kHz, 16/20/24 bit Linear PCM	no output* ³		
with Dolby Digital	Dolby Digital bitstream		48 kHz, 16 bit Linear PCM
with DTS	DTS bitstream	48 kHz, 16 bit Linear PCM	
SVCD, VCD, CD	44.1 kHz, 16 bit Linear PCM/48 kHz, 16 bit Linear PCM		
CD with DTS	DTS bitstream	44.1 kHz, 16 bit Linear PCM	
MP3 disc	32/44.1/48 kHz, 16 bit Linear PCM		

*¹ While playing some DVDs, digital signals may be emitted at 20 bits or 24 bits (at their original bit rate) through the DIGITAL AUDIO OUT terminal if the discs are not copy-protected.

*² When the disc is not copyright protected, "48 kHz, 16 bit Linear PCM" signal is output.

*³ When the disc is not copyright protected, "44.1 kHz, 16 bit Linear PCM" signal is output.

Parts Index

Refer to the pages to see how to use the buttons and controls.

Remote control

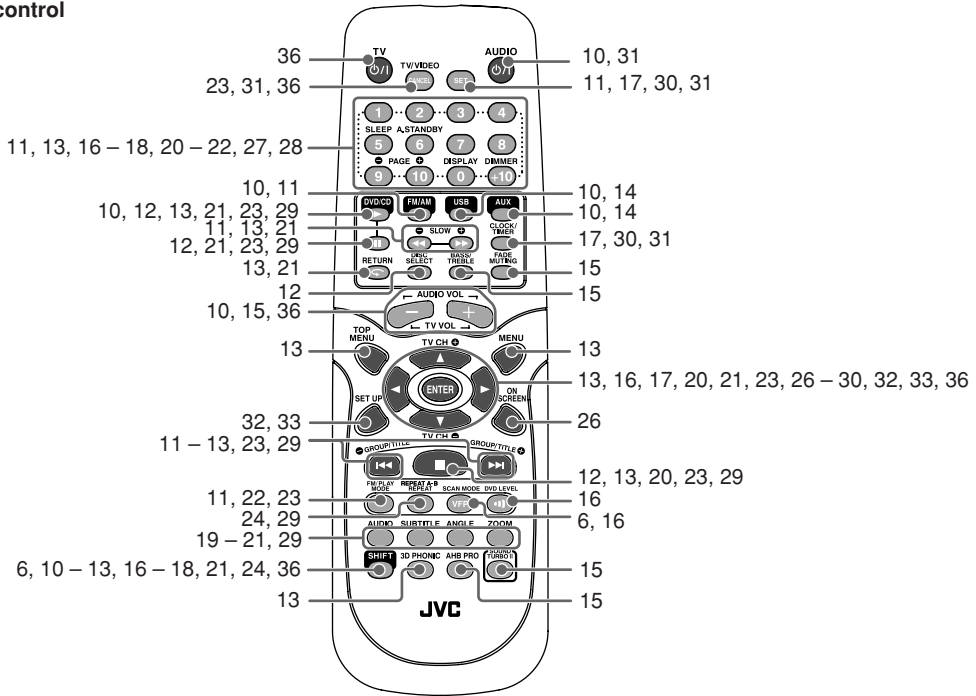

Main unit

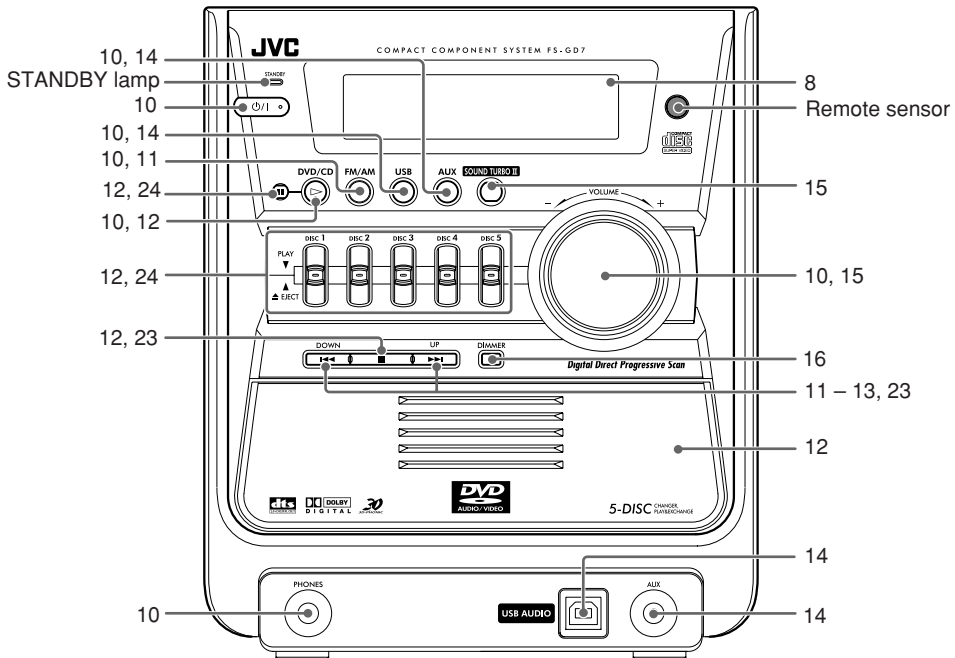

Specifications

Amplifier section

Output Power: 90 W per channel, min. RMS, driven into 6 Ω at 1 kHz with no more than 10% total harmonic distortion.

Analog input:

AUX: Sensitivity/Impedance (at 1 kHz)
400 mV/47 k Ω

USB input:

USB Ver.1.1

Digital output:

OPTICAL DIGITAL OUT:
-21 dBm to -15 dBm (660 nm \pm 30 nm)

VIDEO OUT:

Color system: NTSC
VIDEO (composite): 1 V(p-p)/75 Ω
S-VIDEO: Y (luminance) 1 V(p-p)/75 Ω
C (chrominance, burst) 0.286 V(p-p)/75 Ω
COMPONENT:(Y) 1 V(p-p)/75 Ω
(P_B/P_R) 0.7 V(p-p)/75 Ω

Speaker terminals: Impedance 6 Ω – 16 Ω

Tuner section

FM tuning range: 87.5 MHz – 108.0 MHz
AM tuning range: 530 kHz – 1 710 kHz

Disc player section

Playable disc: DVD Video/DVD Audio
CD/VCD/SVCD
CD-R/CD-RW (recorded in Audio CD/
Video CD/ Super Video CD/ MP3/ JPEG
format)
DVD-R/DVD-RW (recorded in video
format)

Horizontal resolution: 500 lines

Wow and flutter: Immeasurable

General

Power requirement: AC 120 V \sim , 60 Hz
Power consumption: 150 W (at operation)
26 W (on standby)
1.3 W (with deactivating the clock
indication)
Dimensions (approx.): 189 mm x 224 mm x 406 mm
(7-1/2 inch x 8-7/8 inch x 16 inch)
(W/H/D)
Mass (approx.): 6.5 kg (14.4 lbs)

Speakers

Type: 2-way Bass-reflex type
Magnetically shielded
Speaker systems: Woofer: 12 cm (4-3/4 inch) cone x 1
Tweeter: 4 cm (1-5/8 inch) cone x 1
Power handling capacity: 90 W
Impedance: 6 Ω
Frequency range: 45 Hz – 20 000 Hz
Sound pressure level: 84 dB/W•m
Dimensions (approx.): 165 mm x 286 mm x 237 mm
(6-1/2 inch x 11-5/16 inch x
9-3/8 inch)
(W/H/D)
Mass (approx.): 2.8 kg (6.2 lbs) each

Supplied Accessories

See page 3.

- This product incorporates copyright protection technology that is protected by U.S. patents and other intellectual property rights. Use of this copyright protection technology must be authorized by Macrovision, and is intended for home and other limited viewing uses only unless otherwise authorized by Macrovision. Reverse engineering or disassembly is prohibited.

“CONSUMERS SHOULD NOTE THAT NOT ALL HIGH DEFINITION TELEVISION SETS ARE FULLY COMPATIBLE WITH THIS PRODUCT AND MAY CAUSE ARTIFACTS TO BE DISPLAYED IN THE PICTURE. IN CASE OF 525 OR 625 PROGRESSIVE SCAN PICTURE PROBLEMS, IT IS RECOMMENDED THAT THE USER SWITCH THE CONNECTION TO THE ‘STANDARD DEFINITION’ OUTPUT. IF THERE ARE QUESTIONS REGARDING OUR TV SET COMPATIBILITY WITH THIS MODEL 525p AND 625p DVD PLAYER, PLEASE CONTACT OUR CUSTOMER SERVICE CENTER.”

Design and specifications are subject to change without notice.

TO OUR VALUED CUSTOMER ———

THANK YOU FOR PURCHASING THIS JVC PRODUCT.
WE WANT TO HELP YOU ACHIEVE A PERFECT EXPERIENCE.

**NEED HELP ON HOW TO HOOK UP?
NEED ASSISTANCE ON HOW TO OPERATE?
NEED TO LOCATE A JVC SERVICE CENTER?
LIKE TO PURCHASE ACCESSORIES?**

JVC[®] IS HERE TO HELP!
TOLL FREE: 1(800)252-5722
<http://www.jvc.com>

Remember to retain your Bill of Sale for Warranty Service.

————— **Do not attempt to service the product yourself** —————

Caution

To prevent electrical shock, do not open the cabinet.
There are no user serviceable parts inside.
Please refer to qualified service personnel for repairs.



LIMITED WARRANTY

AUDIO-1

JVC COMPANY OF AMERICA (JVC) warrants this product and all parts thereof, except as set forth below ONLY TO THE ORIGINAL RETAIL PURCHASER to be FREE FROM DEFECTIVE MATERIALS AND WORKMANSHIP from the date of original purchase for the period shown below. ("The Warranty Period")

PARTS	1 YR	LABOR	1 YR
-------	------	-------	------

THIS LIMITED WARRANTY IS VALID ONLY IN THE FIFTY (50) UNITED STATES, THE DISTRICT OF COLUMBIA AND IN THE COMMONWEALTH OF PUERTO RICO.

WHAT WE WILL DO:

If this product is found to be defective within the warranty period, JVC will repair or replace defective parts with new or rebuilt equivalents at no charge to the original owner. Such repair and replacement services shall be rendered by JVC during normal business hours at JVC authorized service centers. Parts used for replacement are warranted only for the remainder of the Warranty Period. All products may be brought to a JVC authorized service center on a carry-in basis. Color televisions with a screen size of 27" or greater qualify for in-home service. In such cases, a technician will come to your home and either repair the TV there or remove and return it if it cannot be repaired in your home.

WHAT YOU MUST DO FOR WARRANTY SERVICE:

Please do not return your product to the retailer

Instead, return your product to the JVC authorized service center nearest you. If shipping the product to the service center, please be sure to package it carefully, preferably in the original packaging, and include a brief description of the problem(s). Please call 1-800-252-5722 to locate the nearest JVC authorized service center. Service locations can also be obtained from our website <http://www.jvc.com>. If your product qualifies for in-home service, the service representative will require clear access to the product.

If you have any questions concerning your JVC Product, please contact our Customer Relations Department at 800-252-5722

WHAT IS NOT COVERED:

This limited warranty provided by JVC does not cover:

1. Products which have been subject to abuse, accident, alteration, modification, tampering, negligence, misuse, faulty installation, lack of reasonable care, or if repaired or serviced by anyone other than a service facility authorized by JVC to render such service, or if affixed to any attachment not provided with the products, or if the model or serial number has been altered, tampered with, defaced or removed;
2. Initial installation, installation and removal from cabinets or mounting systems.
3. Operational adjustments covered in the Owner's Manual, normal maintenance, video and audio head cleaning;
4. Damage that occurs in shipment, due to act of God, and cosmetic damage;
5. Signal reception problems and failures due to line power surge;
6. Video Pick-up Tubes/CCD Image Sensors are covered for 90 days from the date of purchase;
7. Accessories;
8. Batteries (except that Rechargeable Batteries are covered for 90 days from the date of purchase);
9. Products used for commercial purposes, including, but not limited to rental.

There are no express warranties except as listed above.

THE DURATION OF ANY IMPLIED WARRANTIES, INCLUDING THE IMPLIED WARRANTY OF MERCHANTABILITY, IS LIMITED TO THE DURATION OF THE EXPRESS WARRANTY HEREIN.

JVC SHALL NOT BE LIABLE FOR ANY LOSS OF USE OF THE PRODUCT, INCONVIENCE, OR ANY OTHER DAMAGES, WHETHER DIRECT, INCIDENTAL OR CONSEQUENTIAL (INCLUDING, WITHOUT LIMITATION, DAMAGE TO TAPES, RECORDS OR DISCS) RESULTING FROM THE USE OF THIS PRODUCT, OR ARISING OUT OF ANY BREACH OF THIS WARRANTY. ALL EXPRESS AND IMPLIED WARRANTIES, INCLUDING THE WARRANTIES OF MERCHANTABILITY AND FITNESS FOR PARTICULAR PURPOSE, ARE LIMITED TO THE WARRANTY PERIOD SET FORTH ABOVE.

Some states do not allow the exclusion of incidental or consequential damages or limitations on how long an implied warranty lasts, so these limitations or exclusions may not apply to you. This warranty gives you specific legal rights and you may also have other rights which vary from state to state.

JVC COMPANY OF AMERICA
 DIVISION OF JVC AMERICAS CORP. <http://www.jvc.com>

1700 Valley Road
 Wayne, NJ 07470

REFURBISHED PRODUCTS CARRY A SEPARATE WARRANTY, THIS WARRANTY DOES NOT APPLY. FOR DETAIL OF REFURBISHED PRODUCT WARRANTY, PLEASE REFER TO THE REFURBISHED PRODUCT WARRANTY INFORMATION PACKAGED WITH EACH REFURBISHED PRODUCT.

For customer use:

Enter below the Model No. and Serial No. which is located either on the rear, bottom or side of the cabinet. Retain this information for future reference.

Model No. : _____ Serial No. : _____
 Purchase date : _____ Name of dealer : _____

JVC

JVC

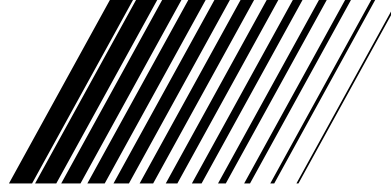

English

Français

COMPACT COMPONENT SYSTEM SYSTEME DE COMPOSANTS COMPACT

FS-GD7

—Consists of CA-FSGD7 and SP-FSGD7
—Composé du CA-FSGD7 et du SP-FSGD7

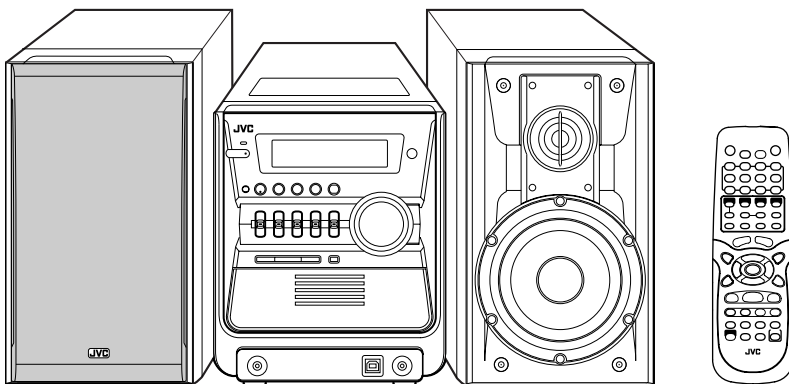

Digital Direct Progressive Scan

INSTRUCTIONS MANUEL D'INSTRUCTIONS

LVT1348-002A
[C]

Warnings, Cautions and Others Mises en garde, précautions et indications diverses



CAUTION
RISK OF ELECTRIC SHOCK
DO NOT OPEN



CAUTION: TO REDUCE THE RISK OF ELECTRIC SHOCK, DO NOT REMOVE COVER (OR BACK). NO USER SERVICEABLE PARTS INSIDE. REFER SERVICING TO QUALIFIED SERVICE PERSONNEL.



The lightning flash with arrowhead symbol, within an equilateral triangle is intended to alert the user to the presence of uninsulated "dangerous voltage" within the product's enclosure that may be of sufficient magnitude to constitute a risk of electric shock to persons.



The exclamation point within an equilateral triangle is intended to alert the user to the presence of important operating and maintenance (servicing) instructions in the literature accompanying the appliance.

WARNING: TO REDUCE THE RISK OF FIRE OR ELECTRIC SHOCK, DO NOT EXPOSE THIS APPLIANCE TO RAIN OR MOISTURE.

CAUTION

To reduce the risk of electrical shocks, fire, etc.:

- 1 Do not remove screws, covers or cabinet.
- 2 Do not expose this appliance to rain or moisture.

ATTENTION

Afin d'éviter tout risque d'électrocution, d'incendie, etc.:

- 1 Ne pas enlever les vis ni les panneaux et ne pas ouvrir le coffret de l'appareil.
- 2 Ne pas exposer l'appareil à la pluie ni à l'humidité.

CAUTION— ϕ /I (standby/on) button!

Disconnect the mains plug to shut the power off completely (all lamps and indications go off). The ϕ /I button in any position does not disconnect the mains line.

- When the unit is on standby, the STANDBY lamp lights in red.
- When the unit is turned on, the STANDBY lamp goes off.

The power can be remote controlled.

Attention—Touche ϕ /I (attente/sous tension)!

Deconnectez la fiche secteur pour mettre l'appareil complètement hors tension (tous les témoins et toutes les indications s'éteignent). La touche ϕ /I dans n'importe quelle position ne deconnecte pas l'appareil du secteur.

- Quand l'appareil est en mode d'attente, le témoin STANDBY est allumé en rouge.
- Quand l'appareil est sous tension, le témoin STANDBY s'éteint.

L'alimentation ne peut pas être commandée à distance.

Caution: Proper Ventilation

To avoid risk of electric shock and fire, and to prevent damage, locate the apparatus as follows:

1. Front: No obstructions and open spacing.
2. Sides/ Top/ Back: No obstructions should be placed in the areas shown by the dimensions below.
3. Bottom: Place on the level surface. Maintain an adequate air path for ventilation by placing on a stand with a height of 10 cm or more.

Attention: Aération correcte

Pour prévenir tout risque de décharge électrique ou d'incendie et éviter toute détérioration, installez l'appareil de la manière suivante:

1. Avant: Bien dégagé de tout objet.
2. Côtés/dessus/dessous: Assurez-vous que rien ne bloque les espaces indiqués sur le schéma ci-dessous.
3. Dessous: Posez l'appareil sur une surface plane et horizontale. Veillez à ce que sa ventilation correcte puisse se faire en plaçant sur un support d'au moins dix centimètres de hauteur.

**Front
Face**

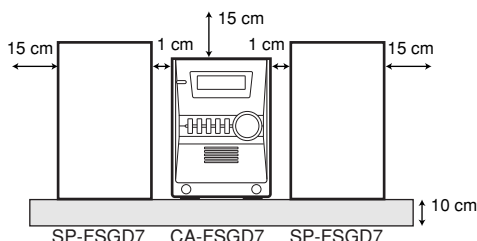

**Side
Côté**

**Cooling fan*
Ventilateur de
refroidissement***

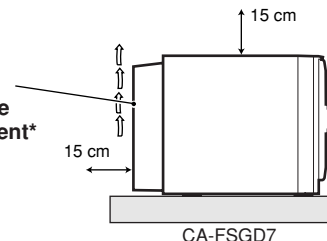

* About the cooling fan

A cooling fan is mounted on the rear panel of the unit to prevent abnormal temperature inside the unit, thus assuring normal operation of the unit. The cooling fan automatically starts rotating to intake external cool air when the volume is increased up to more than a certain level.

* À propos du ventilateur de refroidissement

Un ventilateur de refroidissement se trouve sur le panneau arrière de l'appareil afin d'éviter la création d'une température anormale à l'intérieur de l'appareil et permettre ainsi un fonctionnement normal de l'appareil. Le ventilateur de refroidissement commence à tourner et à aspirer de l'air frais automatiquement quand le volume est augmenté au-dessus d'un certain niveau.

For U.S.A.

This equipment has been tested and found to comply with the limits for a Class B digital device, pursuant to part 15 of the FCC Rules. These limits are designed to provide reasonable protection against harmful interference in a residential installation.

This equipment generates, uses and can radiate radio frequency energy and, if not installed and used in accordance with the instructions, may cause harmful interference to radio communications. However, there is no guarantee that interference will not occur in a particular installation. If this equipment does cause harmful interference to radio or television reception, which can be determined by turning the equipment off and on, the user is encouraged to try to correct the interference by one or more of the following measures:

- Reorient or relocate the receiving antenna.
- Increase the separation between the equipment and receiver.
- Connect the equipment into an outlet on a circuit different from that to which the receiver is connected.
- Consult the dealer or an experienced radio/TV technician for help.

CAUTION

Changes or modifications not approved by JVC could void the user's authority to operate the equipment.

For the main unit:

Declaration of Conformity

Model Number: FS-GD7

Trade Name: JVC

Responsible Party: JVC Americas Corp.

Address: 1700 Valley Road, Wayne
New Jersey 07470

Telephone Number: 973-317-5000

This device complies with Part 15 of FCC Rules. Operation is subject to the following two conditions: (1) This device may not cause harmful interference, and (2) this device must accept any interference received, including interference that may cause undesired operation.

For Canada/pour le Canada

CAUTION: TO PREVENT ELECTRIC SHOCK, MATCH WIDE BLADE OF PLUG TO WIDE SLOT, FULLY INSERT.

ATTENTION: POUR EVITER LES CHOCS ELECTRIQUES, INTRODUIRE LA LAME LA PLUS LARGE DE LA FICHE DANS LA BORNE CORRESPONDANTE DE LA PRISE ET POUSSER JUSQU'AU FOND.

Note to CATV system installer:

This reminder is provided to call the CATV system installer's attention to section 820-40 of the NEC which provides guidelines for proper grounding and, in particular, specifies that the cable ground shall be connected to the grounding system of the building, as close to the point of cable entry as practical.

For Canada/pour le Canada

THIS DIGITAL APPARATUS DOES NOT EXCEED THE CLASS B LIMITS FOR RADIO NOISE EMISSIONS FROM DIGITAL APPARATUS AS SET OUT IN THE INTERFERENCE-CAUSING EQUIPMENT STANDARD ENTITLED "DIGITAL APPARATUS," ICES-003 OF THE DEPARTMENT OF COMMUNICATIONS.

CET APPAREIL NUMERIQUE RESPECTE LES LIMITES DE BRUITS RADIOELECTRIQUES APPLICABLES AUX APPAREILS NUMERIQUE DE CLASSE B PRESCRITES DANS LA NORME SUR LE MATERIEL BROUILLEUR; "APPAREILS NUMERIQUE", NMB-003 EDICTEE PAR LE MINISTRE DES COMMUNICATIONS.

IMPORTANT FOR LASER PRODUCTS

- 1 CLASS 1 LASER PRODUCT
- 2 **CAUTION:** Do not open the top cover. There are no user serviceable parts inside the unit; leave all servicing to qualified service personnel.
- 3 **CAUTION:** Visible and invisible laser radiation when open and interlock failed or defeated. Avoid direct exposure to beam.
- 4 REPRODUCTION OF LABEL: CAUTION LABEL, PLACED INSIDE THE UNIT.

IMPORTANT POUR PRODUITS LASER

- 1 PRODUIT LASER CLASSE 1
- 2 **ATTENTION:** N'ouvrez pas le couvercle superieur. Il n'y a aucune piece reparable par l'utilisateur a l'interieur de l'appareil; confiez toute reparation a un personnel qualifié.
- 3 **ATTENTION:** Risque de radiations laser visible et invisible quand l'appareil est ouvert et que le système de verrouillage ne fonctionne pas ou a été mis hors service. Évitez toute exposition directe au rayon.
- 4 REPRODUCTION DE L'ETIQUETTE: ÉTIQUETTE DE PRÉCAUTION PLACÉE L'INTERIEUR DE L'APPAREIL.

CAUTION : Visible and invisible laser radiation when open and interlock failed or defeated. AVOID DIRECT EXPOSURE TO BEAM. (e)

ADVARSEL : Synlig og usynlig laserstråling når maskinen er åben eller interlocken fejler. Undgå direkte eksponering til stråling. (d)

WARNING : Synlig och osynlig laserstråling när den öppnas och spårren är urkopplad. Betrakta ej strålen. (s)

VARO : Avattaessa ja suojalukitus ohitettuna tai viallisena olet alttiina näkyvälle ja näkymättömälle lasersäteilylle. Vältä säteen kohdistumista suoraan itseesi. (f)

CONTENTS

Introduction	2	On-Screen Disc Operations	25
Precautions	2	On-screen Bar Information	25
How to Read This Manual	2	Operations Using the On-screen Bar	26
Getting Started	3	Operations on the CONTROL Screen	28
Step 1: Unpack	3	Timer Operations	30
Step 2: Prepare the Remote Control	3	Setting the Daily Timer.....	30
Step 3: Hook Up	4	Setup Menu Operations	32
Changing the Scanning Mode	6	Operating Procedure	32
Before Operating the System	7	■ LANGUAGE Setup Menu	33
Playable Disc Types	7	■ PICTURE Setup Menu	33
Display Indicators	8	■ AUDIO Setup Menu	34
Daily Operations—Playback	10	■ OTHERS Setup Menu	35
Listening to the Radio	11	Operating the TV	36
Playing Back a Disc	12	Operating TV	36
Playing Back from the PC.....	14	Additional Information	37
Playing Back from Other Equipment	14	Learning More about This System.....	37
Daily Operations—Sound&Other Adjustments	15	Maintenance	39
Adjusting the Volume	15	Troubleshooting	40
Adjusting the Sound.....	15	Language Code List	41
Making DVD Voice Clear—CLEAR VOICE	16	OPTICAL DIGITAL OUT Signals.....	42
Presetting Automatic DVD Sound Increase Level		Parts Index.....	43
—DVD LEVEL.....	16	Specifications	44
Changing the Display Brightness—DIMMER	16		
Changing the Picture Tone			
—VFP (Video Fine Processor).....	17		
Setting the Clock	18		
Turning Off the Power Automatically	18		
Unique DVD/VCD Operations	19		
Selecting the Sound Track.....	19		
Selecting the Subtitle Language	20		
Selecting the View Angle.....	20		
Playing Back a Bonus Group	20		
Selecting Browsable Still Pictures	21		
Special Effect Playback.....	21		
Advanced Disc Operations	22		
Programming the Playing Order—Program Play.....	22		
Playing at Random—Random Play.....	23		
Playing Repeatedly.....	24		
Prohibiting Disc Ejection—Child Lock	24		

Introduction

Precautions

Installation

- Install in a place which is level, dry and neither too hot nor too cold—between 5°C and 35°C.
- Install the System in a location with adequate ventilation to prevent internal heat buildup inside the System.



DO NOT install the System in a location near heat sources, or in a place subject to direct sunlight, excessive dust or vibration.

- Leave sufficient distance between the System and the TV.
- Keep the speakers away from the TV to avoid interference with TV.

Power sources

- When unplugging the System from the wall outlet, always pull on the plug, not the AC power cord.



DO NOT handle the AC power cord with wet hands.

Moisture condensation

Moisture may condense on the lenses inside the System in the following cases:

- After starting to heat the room
- In a damp room
- If the System is brought directly from a cold to a warm place.

Should this occur, the System may malfunction. In this case, leave the System turned on for a few hours until the moisture evaporates, unplug the AC power cord, then plug it in again.

Internal heat

- A cooling fan is mounted on the rear panel to prevent heat buildup inside the main unit (see page G-1).



For safety, observe the following carefully:

- Make sure there is good ventilation around the main unit. Poor ventilation could overheat and damage the System.
- DO NOT block the cooling fan and the ventilation openings or holes. If they are blocked by a newspaper or cloth, etc., the heat may not be able to get out.

Others

- Should any metallic object or liquid fall into the System, unplug the AC power cord and consult your dealer before operating any further.



DO NOT disassemble the System since there are no user serviceable parts inside.

- If you are not going to operate the System for an extended period of time, unplug the AC power cord from the wall outlet.

If anything goes wrong, unplug the AC power cord and consult your dealer.

How to Read This Manual

To make in this manual as simple and easy-to-understand as possible, we have adapted the following methods:

- Button and control operations are explained as listed in the table below. In this manual, the operations using the remote control is mainly explained; however, you can use the buttons and controls on the main unit if they have the same (or similar) name and marks.
- **Some related tips and notes are explained later in the sections “Learning More about This System” (on pages 37 to 38) and “Troubleshooting” (on page 40), but not in the same section explaining the operations.** If you want to know more about the functions, or if you have a doubt about the functions, go to these sections and you will find the answers.

	Indicates that you press the button briefly .
	Indicates that you press the button briefly and repeatedly until an option you want is selected.
	Indicates that you press one of the buttons.
	Indicates that you press and hold the button for a specified period. <ul style="list-style-type: none"> • The number inside the arrow indicates the period of press (in this example, 2 seconds). • If no number is inside the arrow, press and hold until the entire procedure is complete or until you get a result you want.
	Indicates that you turn the control toward the specified direction(s).
	Indicates that this operation is only possible using the remote control.
	Indicates that this operation is only possible using the buttons and controls on the main unit.

Getting Started

Step 1: Unpack the package and check the accessories.

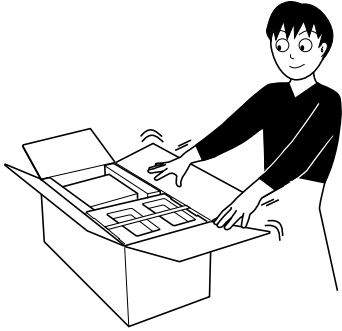

Step 1: Unpack

After unpacking, check to be sure that you have all the following items. The number in parentheses indicates the quantity of each piece supplied.

- FM antenna (1)
- AM loop antenna (1)
- Remote control (1)
- Composite video cord (1)
- Batteries (2)

If any item is missing, consult your dealer immediately.

Step 2: Prepare the Remote Control

Insert the batteries into the remote control by matching the polarity (+ and -) correctly.

Step 2: Prepare the remote control.

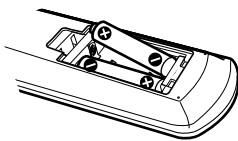

1

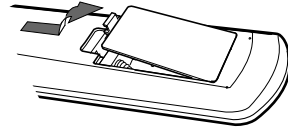

2

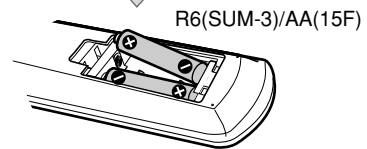

3

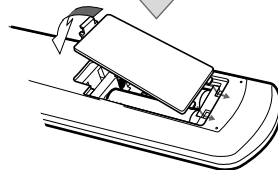

Step 3: Hook up the components such as AM/FM antennas, speakers, etc. (see pages 4 to 6).

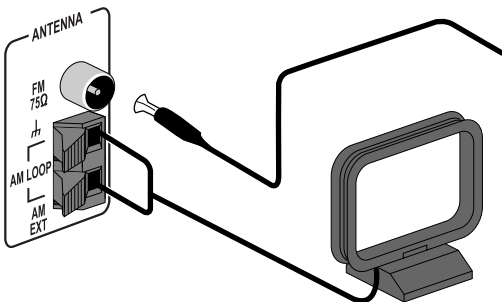

Finally plug the AC power cord.
Now you can operate the System.

- DO NOT use an old battery together with a new one.
- DO NOT use different types of batteries together.
- DO NOT expose batteries to heat or flame.
- DO NOT leave the batteries in the battery compartment when you are not going to use the remote control for an extended period of time. Otherwise, the remote control will be damaged from battery leakage.



Step 3: Hook Up

If you need more detailed information, see page 6.

Illustrations of the input/output terminals below are typical examples. When you connect other components, refer also to their manuals, since the terminal names actually printed on the rear may vary.

Turn the power off to all components before connections.

AM loop antenna (supplied)
Turn it until the best reception is obtained.

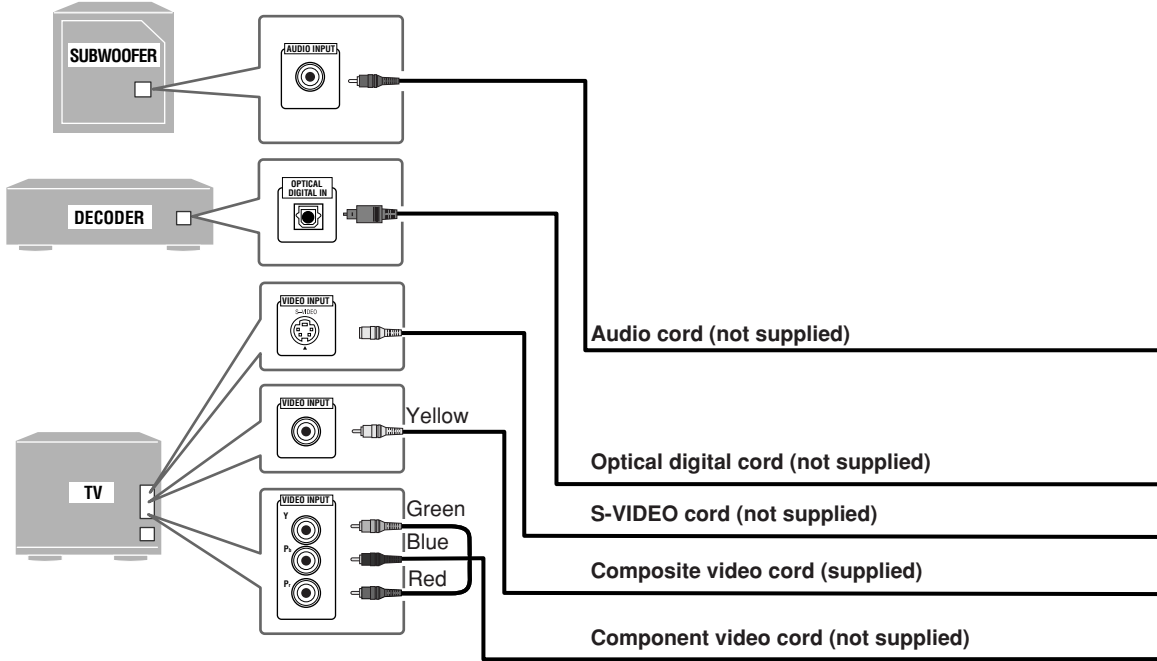
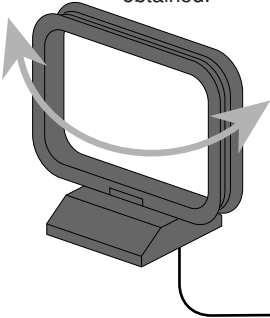

To a wall outlet
Plug the AC power cord only after all connections are complete.

For better FM/AM reception

Vynile-covered wire (not supplied)

Extend it horizontally.

AM loop antenna
Keep it connected.

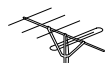
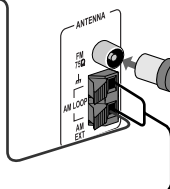

Outdoor FM antenna (not supplied)

Disconnect the supplied FM antenna, and connect to an outdoor FM antenna using a 75 Ω wire with coaxial type connector.

FM antenna (supplied)

Extend it so that you can obtain the best reception.

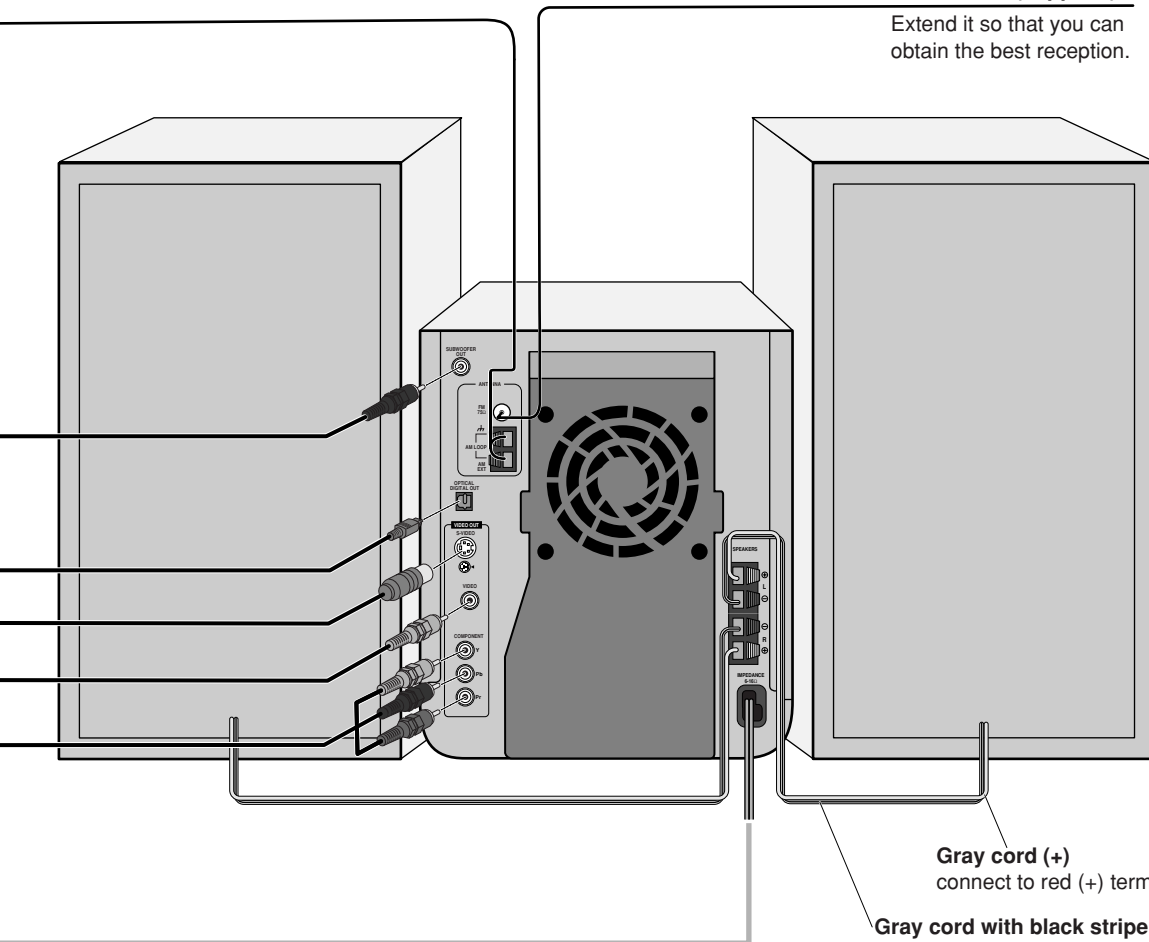

Gray cord (+)
connect to red (+) terminal

Gray cord with black stripe (-)
connect to black (-) terminal

To assemble and connect the AM loop antenna

To assemble the AM loop antenna

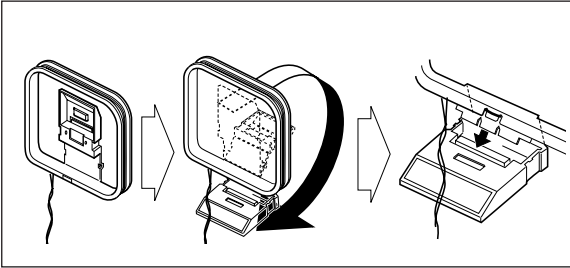

To connect the AM loop antenna

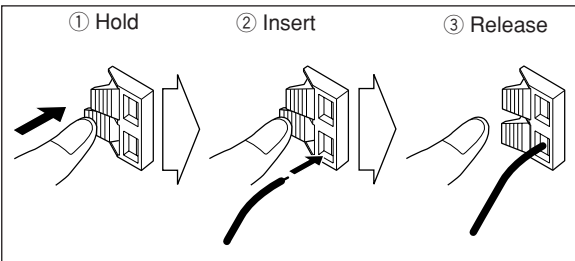

- If the AM loop antenna wire or speaker cords are covered with vinyl, remove the vinyl to expose the tip of the antenna by twisting the vinyl.
- Make sure the antenna conductors do not touch any other terminals, connecting cords and power cord. Also keep the antennas away from metallic parts of the System, connecting cords, and the AC power cord. This could cause poor reception.

To connect the speaker cords

Connect the right speaker to the R terminals, and the left speaker to the L terminals.

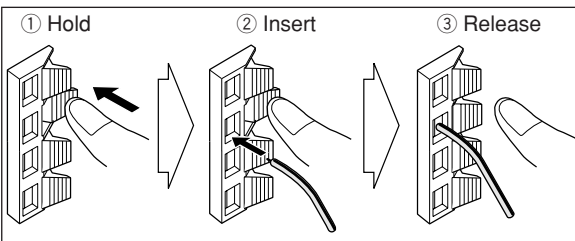

When connecting the speaker cords, match the polarity of the speaker terminals: gray cord (+) to red (+), and gray cord with black stripe (-) to black (-).



- DO NOT connect more than one speaker to each terminal.
- DO NOT allow the conductor of the speaker cords to be in touch with the metallic parts of the System.

Changing the Scanning Mode



This System supports progressive scanning.

If you connect a progressive TV through the COMPONENT jacks, you can enjoy a high quality picture from the built-in DVD player by selecting progressive mode.

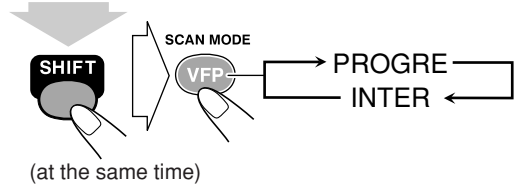

PROGRE
(Progressive)

Progressive scanning.
For a progressive TV. The
PROGRESSIVE indicator lights.









INTER
(Interlaced)

Interlaced scanning.
For a conventional TV.

Before Operating the System

Playable Disc Types

This System has been designed to play back the following discs:

Disc Type	Mark (Logo)	Video Format	Region Code* Number
DVD Video	 	NTSC	1 or ALL
DVD Audio	 		
Video CD (VCD)	 		—
Super Video CD (SVCD)	 		—
Audio CD		—	—
CD-R	The System can play back CD-R or CD-RW recorded in the Audio CD, Video CD, SVCD, MP3, and JPEG formats.		
CD-RW			
DVD-R	The System can play back DVD-R or DVD-RW recorded in the video format.		
DVD-RW			

In addition to the above discs, this System can play back audio data recorded on CD Text, CD-G (CD Graphics), and CD-Extra.

- The following discs cannot be played back:
DVD-ROM, DVD-RAM, DVD+R, DVD+RW, CD-I (CD-I Ready), CD-ROM, Photo CD, SACD, etc.
Playing back these discs will generate noise and damage the speakers.
- In this manual, “file” and “track” are interchangeably used for MP3/JPEG operations.

* Note on Region Code

DVD players and DVDs have their own Region Code numbers. This System can play back only DVDs recorded with the NTSC color system whose Region Code numbers including “1.”

Ex.:



If a DVD with the improper Region Code numbers is loaded, “RGN ERR (REGION CODE ERROR)” appears on the display and playback will not start.

Caution for DualDisc playback:

The Non-DVD side of a “DualDisc” does not comply with the “Compact Disc Digital Audio” standard. Therefore, the use of Non-DVD side of a DualDisc on this product may not be recommended.

DVD Video—digital audio formats

The System can play back the following digital audio formats.

- Linear PCM:** Uncompressed digital audio, the same format used for CDs and most studio masters.
- Dolby Digital:** Compressed digital audio, developed by Dolby Laboratories, which enables multi-channel encode to create the realistic surround sound.
- DTS (Digital Theater Systems):** Compressed digital audio, developed by Digital Theater Systems, Inc., which enables multi-channel like Dolby Digital. As the compression ratio is lower than for Dolby Digital, it provides wider dynamic range and better separation.

When playing a multi-channel encoded DVD, the System properly converts these multi-channel signals into 2 channels, and emits the downmixed sound from the speakers.

- To enjoy the powerful sound of these multi-channel encoded DVDs,** connect a proper decoder or an amplifier with a proper built-in decoder to the digital output terminal on the rear.

IMPORTANT: Before playing a disc, make sure of the following...

- Turn on the TV and select an appropriate input mode on the TV to view the pictures or on-screen displays on the TV screen.
- For disc playback, you can change the initial setting to your preference. See “Setup Menu Operations” on page 32.

If “⊗” appears on the TV screen when you press a button, the disc cannot accept the operation you have tried to do, or data required for that operation is not recorded on the disc.

- Manufactured under license from Dolby Laboratories. “Dolby”, “Pro Logic”, “MLP Lossless”, and the double-D symbol are trademarks of Dolby Laboratories.
- “DTS” and “DTS 2.0 + DIGITAL OUT” are trademarks of Digital Theater Systems, Inc.

“DVD Logo” is a trademark of DVD Format/Logo Licensing Corporation registered in the US, Japan and other countries.





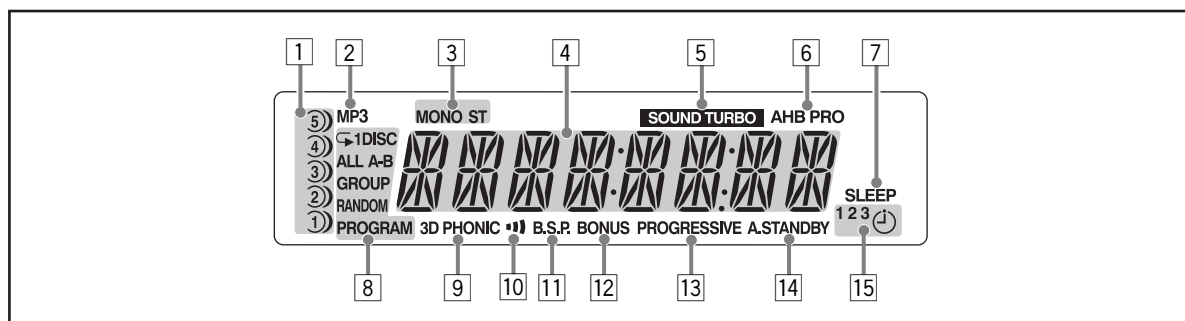

Display Indicators

The indications on the display teach you a lot of things while you are operating the System. Before operating the System, be familiar with when and how the indicator illuminates on the display.

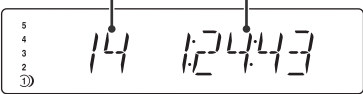
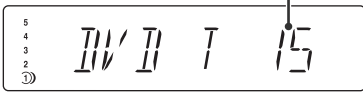

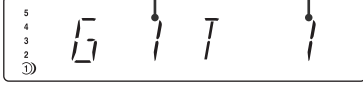
- 1 Disc tray indicators
 - 1–5: Disc tray number indicators.
 - ○ (tray indicator):
 - Lights when the disc is detected.
 - Blinking while playing back a disc.
 - Goes off when there is no disc in the tray.
 - ◐ (disc indicator): Lights below when the tray indicator indicates the current selected disc.
- 2 MP3 indicator
 - Lights when the current track is recorded in MP3 format.
- 3 FM reception indicators
 - MONO: Lights when FM reception mode is monaural.
 - ST (stereo): Lights while an FM stereo station with sufficient signal strength is tuned in.
- 4 Main display
 - While listening to radio; band (or preset number) and station frequency appear.
 - While selecting “AUX”; “AUX” appears.
 - While playing a disc; see “Indications on the main display while operating a disc” on page 9.
- 5 SOUND TURBO indicator
 - Lights when SOUND TURBO II is activated (see page 15).
- 6 AHB (active hyper bass) PRO indicator
 - Lights when AHB PRO is activated (see page 15).
- 7 SLEEP indicator
 - Lights when the Sleep Timer is activated (see page 18).
- 8 Disc operation indicators
 - ↺ : Lights when Repeat mode is activated.
 - 1: Lights when One Track Repeat is activated.
 - 1DISC: Lights when One Disc Repeat is activated.
 - ALL: Lights when All Disc Repeat is activated.
 - A-B: Lights when A-B Repeat is activated.
 - GROUP: Lights when Group Repeat is activated.
 - RANDOM: Lights when Random Play mode is activated.
 - PROGRAM: Lights when Program Play mode is activated.
- 9 3D PHONIC indicator
 - Lights when 3D PHONIC is activated (see page 13).
- 10 Clear Voice indicator
 - Lights when Clear Voice function is activated (see page 16).
- 11 B.S.P. indicator
 - Lights when the current disc is DVD Audio with browsable still picture (see page 21).
- 12 BONUS indicator
 - Lights when a DVD Audio with a bonus group is detected (see page 20).
- 13 PROGRESSIVE indicator
 - Lights when progressive scanning mode is selected (see page 6).
- 14 A. (auto) STANDBY indicator
 - Lights when Auto Standby is activated.
 - Flashes when disc playback stops with Auto Standby activated.
- 15 Timer indicators
 - ⌚ : Lights when Daily Timer stands by; flashes while working.
 - 1/2/3: Lights up when a Daily Timer (1, 2, or 3) stands by; flashes while setting or working.

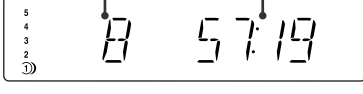
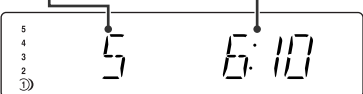
Indications on the main display while operating a disc

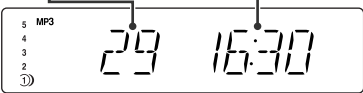
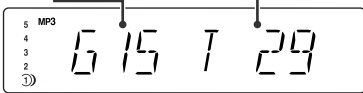
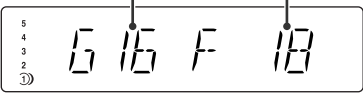
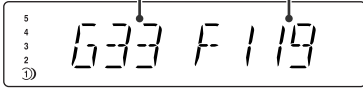
While playing back a disc:	While disc play is stopped:
<ul style="list-style-type: none"> DVD Video: <div style="text-align: center;"> Chapter no. Elapsed playing time  </div> By pressing SHIFT+DISPLAY, you can show the current title and chapter numbers for a few seconds. 	<ul style="list-style-type: none"> DVD Video: <div style="text-align: center;"> Total title no.  </div>
<ul style="list-style-type: none"> DVD Audio: <div style="text-align: center;"> Track no. Elapsed playing time  </div> By pressing SHIFT+DISPLAY, you can show the current group and track numbers for a few seconds. 	<ul style="list-style-type: none"> DVD Audio: <div style="text-align: center;"> Group no. Track no.  </div>
<ul style="list-style-type: none"> Audio CD: <div style="text-align: center;"> Track no. Elapsed playing time  </div> 	<ul style="list-style-type: none"> Audio CD: <div style="text-align: center;"> Total track no. Total playing time  </div>
<ul style="list-style-type: none"> SVCD/VCD: <div style="text-align: center;"> Track no. Elapsed playing time*  </div> * "PBC" appears while playing a disc with PBC. 	<ul style="list-style-type: none"> SVCD/VCD: <div style="text-align: center;"> Total track no.* Total playing time  </div> * Changes to "PBC" when stopping PBC playback.
<ul style="list-style-type: none"> MP3: <div style="text-align: center;"> Track no. Elapsed playing time  </div> By pressing DISPLAY, you can show the current group and track numbers for a few seconds. 	<ul style="list-style-type: none"> MP3: <div style="text-align: center;"> Current group no. Current track no.  </div>
<ul style="list-style-type: none"> JPEG: <div style="text-align: center;"> Group no. File no.  </div> 	<ul style="list-style-type: none"> JPEG: <div style="text-align: center;"> Current group no. Current file no.  </div>

• If "RESUME" is "ON" (see page 35), "RESUME" appears when you stop playback (except for Audio CD and MP3/JPEG discs).

Daily Operations—Playback

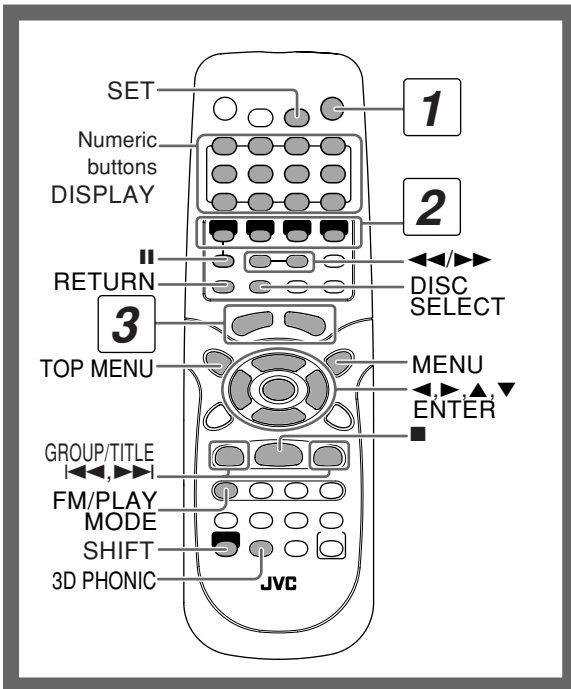

1 Turn on the power.

The STANDBY lamp on the main unit turns off.

- Without pressing AUDIO $\phi/1$, the System turns on by pressing one of the source selecting buttons in the next step.

2 Select the source.

Playback automatically starts if the selected source is ready to start.

- If you press AUX or USB, start playback on the external component.

3 Adjust the volume.

4 Operate the target source as explained later.

To turn off (standby) the System

AUDIO



The STANDBY lamp on the main unit lights up.

- A small amount of power is always consumed even while on standby.

For private listening

Connect a pair of headphones to the PHONES jack on the main unit. The sound will no longer come out of the speakers. Be sure to turn down the volume before connecting or putting on the headphones.

- Disconnecting the headphones will activate the speakers again.



DO NOT turn off (standby) the System with the volume set to an extremely high level; otherwise, the sudden blast of sound can damage your hearing, speakers and/or headphones when you turn on the System or start playback.

To turn off the clock indication to save the power

While the System is turned off...

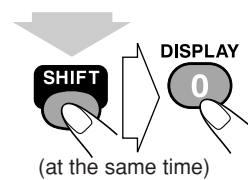

- Press the button again, to display the clock indication.

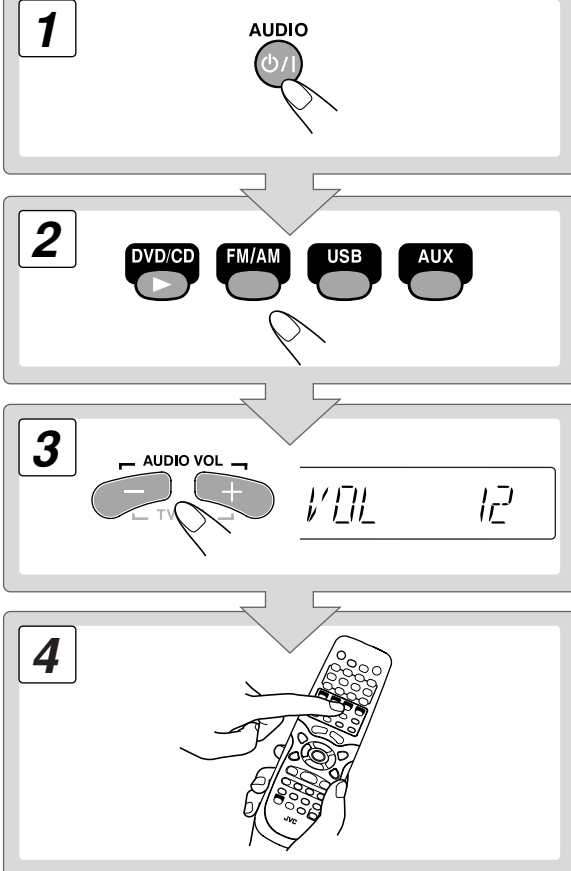

Listening to the Radio

To select the band (FM or AM)

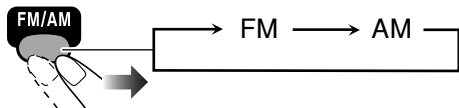

To tune in to a station

While FM or AM is selected...

Remote control:	Main unit:

Frequency starts changing on the display.

When a station (frequency) with sufficient signal strength is tuned in, the frequency stops changing.

- When you repeatedly press the button, the frequency changes step by step.

To stop searching manually, press either button.

If the received FM station is hard to listen



FM/PLAY
MODE



The MONO indicator lights on the display.

Reception will improve though stereo effect is lost—Monaural reception mode.

To restore the stereo effect, press the button again (the MONO indicator goes off).

To preset the stations



You can preset 30 FM and 15 AM stations.

1 Tune in to a station you want to preset.

- You can also store the monaural reception mode for FM preset stations if selected.

2 Activate the preset number entry mode.

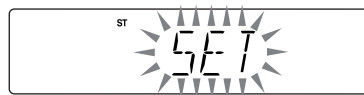

- Finish the following process while the indication on the display is flashing (5 seconds).

3 Select a preset number for the station you store.

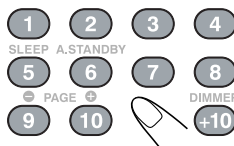

Examples:

To select preset number 5, press 5.

To select preset number 15, press +10, then 5.

To select preset number 30, press +10, +10, then 10.



4 Store the station.



To tune in to a preset station



1 Select a band (FM or AM).

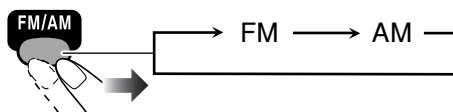

2 Select a preset number you have stored.

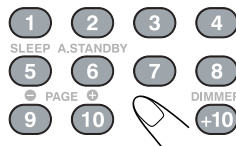

- You can also use the ◀▶ buttons to select a preset station.

Playing Back a Disc ●●●●●●●●

Before operating a disc, be familiar how a disc is recorded.

- DVD Video comprises of “Titles” which includes “Chapters,” DVD Audio/MP3 comprise of “Groups” which includes “Tracks,” and CD/SVCD/VCD comprise of only “Tracks.”
- For MP3/JPEG playback, see “Operations on the CONTROL Screen” on page 28.

To insert a disc

You can insert a disc while playing another source.

Main Unit:

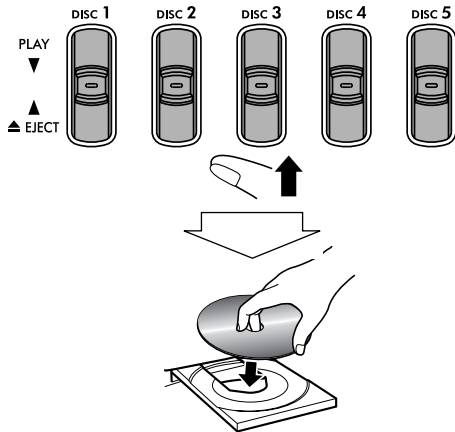

To close the disc tray and start playback, press down the same lever again.

- When current selected disc tray is open, you can use DVD/CD ► to close the disc tray and start playback (depending on how the disc is programmed internally).
- When you press up ▲ EJECT for the next tray you want to place another disc onto, the first disc tray automatically closes and then next tray comes out.

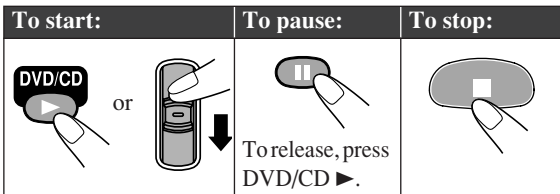

- **While playing DVD/SVCD/VCD:** This System can store the stop point, and when you start playback again by pressing DVD/CD ►, it starts from the position where you have stopped—Resume Play. (“RESUME” appears on the display when you stop playback.)

To stop completely while Resume function is activated, press ■ twice. (To cancel Resume function, see “RESUME” on page 35.)

- When operating the System, the on-screen guide icon (see the following table) appears on the TV screen. To deactivate the on-screen guide icons, see “ON SCREEN GUIDE” on page 35.

On-screen guide icons

- During DVD Video playback, the following icons may appear on the TV screen:

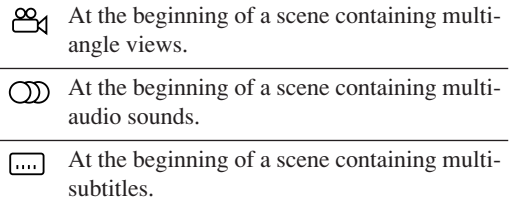

- The following icons will be also shown on the TV screen to indicate your current operation (for more details, see page 25).



To select a disc

Remote Control:

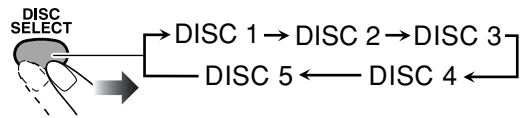

- When current source is not disc, press DVD/CD ► to select disc player as the source while “PLAY” is flashing on the display.

Main Unit:

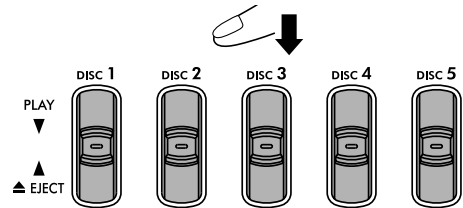

To select a title/group



While playing...

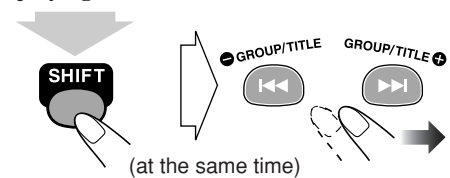

- Group name appears for MP3 discs.

To select a chapter/track

While playing...

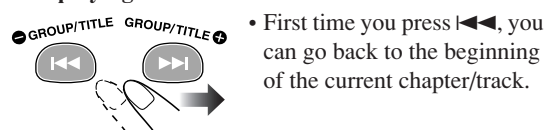

To locate a particular portion



While playing a disc except MP3...



- No sound comes out while searching on DVD Video/SVCD/VCD.

To return to normal playback, press DVD/CD ►.

To locate an item directly



You can select a title/chapter/track directly and start playback.

- For DVD Video, you can select a **title** before starting playback, you can select a **chapter** after starting playback.

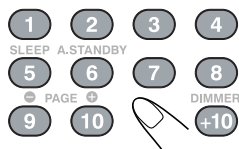

Examples:

- To select number 5, press 5.
- To select number 15, press +10, then 5.
- To select number 30, press +10, +10, then 10.

To use 3D PHONIC

While playing...

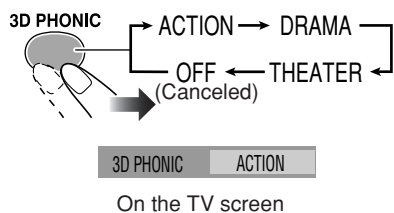

ACTION	Suitable for action movies and sports programs.
DRAMA	Creates natural and warm sound. Enjoy movies in a relaxed mood.
THEATER	Enjoy sound effects like in a major theater.

- 3D PHONIC indicator also lights up.

To play back using the disc menu



You can operate a disc—DVD and SVCD/VCD with Playback Control (PBC)—using the disc menu shown on the TV screen.

■ For DVD Video/DVD Audio:

1 Show the disc menu.

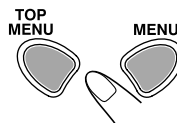

2 Select an item on the disc menu.

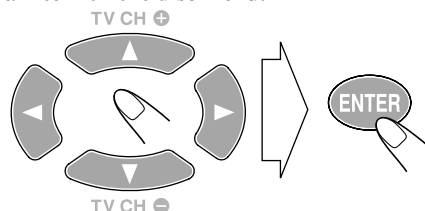

- You cannot use this function while displaying the pull-down menu (see page 26).
- With some discs, you can also select items by entering the number using the numeric buttons.

■ For SVCD/VCD with PBC:

While playing a disc with PBC, “PBC” appears on the display.

When disc menu appears on the TV screen, select an item on the menu. Playback of the selected item starts.

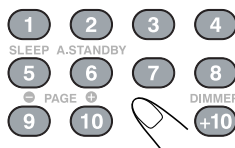

Examples:

- To select number 5, press 5.
- To select number 15, press +10, then 5.
- To select number 30, press +10, +10, then 10.

To move to the next or previous page of the current menu:

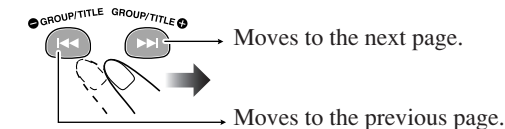

To return to the previous menu:

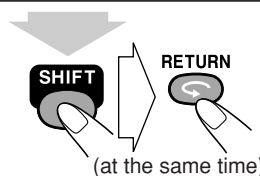

To cancel PBC

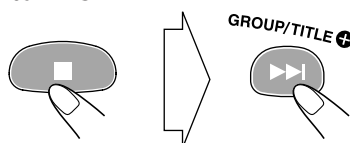

- You can also cancel PBC function by pressing the numeric buttons to select a track.

To reactivate PBC, press ■, then press ◀◀.

Playing Back from the PC

This System is equipped with a USB terminal on the front panel. You can connect your PC to this terminal and enjoy sound reproduced through your PC.

When you connect your PC for the first time, follow the procedure below.

- Remember you cannot send any signal or data to your PC from this System.

IMPORTANT

- Always set volume to “VOL MIN” when connecting or disconnecting the other equipment.

How to install the USB drivers

- 1 Turn on your PC and start running Windows® 98, Windows® 98SE, Windows® Me, Windows® 2000, or Windows® XP.
 - If the PC has been turned on, quit all the applications running.
- 2 Select USB for the source.



- 3 Connect the System to the PC using a USB cable (not supplied).

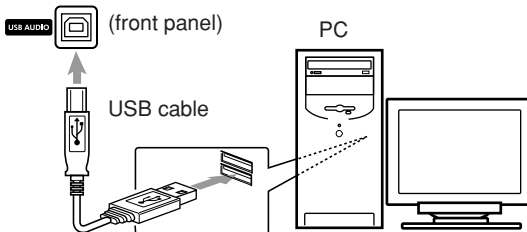

- Use “USB series A plug to B plug” cable when connecting.

- 4 The USB drivers are installed automatically.

To play back sounds on the PC

Refer to the manuals supplied with the sound reproduction application installed in the PC.

* Microsoft®, Windows® 98, Windows® 98SE, Windows® Me, Windows® 2000 and Windows® XP are registered trademarks of Microsoft corporation.

Playing Back from Other Equipment

To connect other equipment

By using a stereo mini plug cord (not supplied), you can connect other equipment with analog audio output jacks, such as an MD player, a TV, etc.

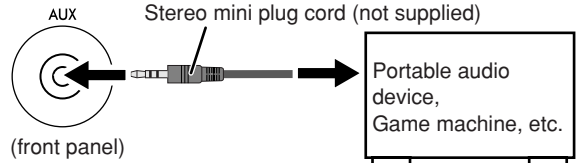

If the audio output on the other equipment is not stereo mini plug type,

Use a plug adapter to convert the stereo mini plug to the corresponding plug of the audio output.

- Refer to the manuals supplied with the other equipment.

IMPORTANT

- Always set volume to “VOL MIN” when connecting or disconnecting the other equipment.

To select other equipment for the source



Daily Operations—Sound&Other Adjustments

Remote control

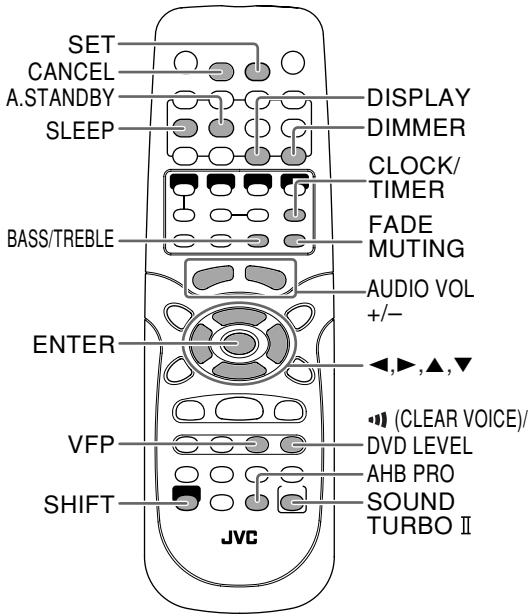

Main unit

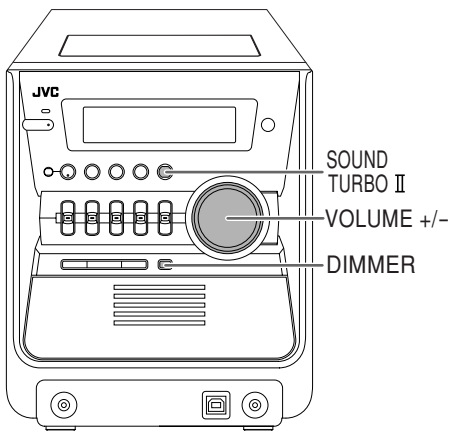

Adjusting the Volume

You can adjust the volume level from level 0 (VOL MIN) to level 31 (VOL MAX).

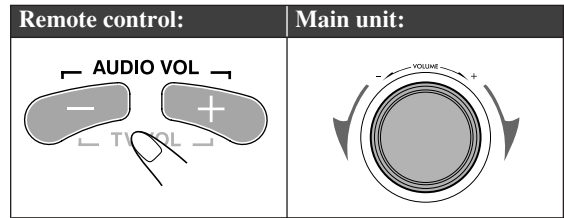

To drop the volume in a moment



To restore the volume, press again, or adjust the volume level.

Adjusting the Sound

To emphasize the sound—SOUND TURBO II

This function emphasizes the sound.

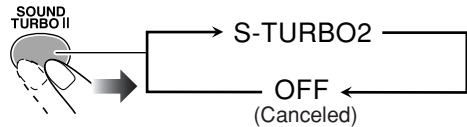

To emphasize heavy bass sound—AHB PRO



This function dynamically enhances bass response.

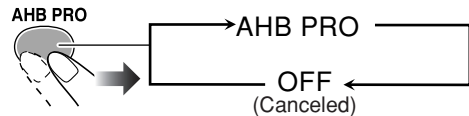

To adjust the tone—BASS/TREBLE



You can adjust the bass and treble level from 0 to +5.

- When you adjust this setting, the SOUND TURBO II is canceled automatically.

To adjust the bass

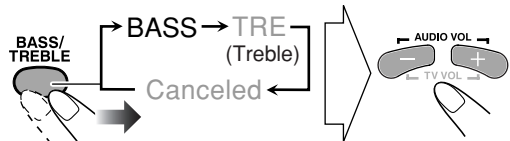

To adjust the treble

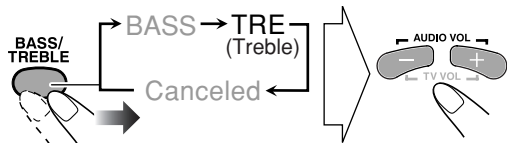

Making DVD Voice Clear—CLEAR VOICE



This function allows you to easily understand the dialog of DVD even with the volume turned down.

- This function only works for center-channel signal encoded multi-channel disc.

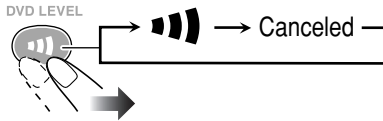

Presetting Automatic DVD Sound Increase

Level—DVD LEVEL



The DVD sound is sometimes recorded at a lower level than for other discs and sources. You can set the increase level for the currently loaded DVD.

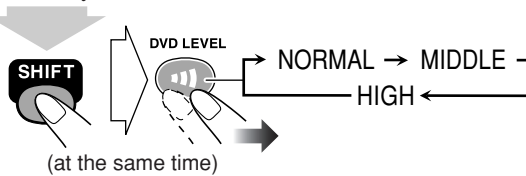

NORMAL	Original recording level.
MIDDLE	Output level is increased (less than “HIGH”).
HIGH	Output level is increased (more than “MIDDLE”).

- Once the current DVD is ejected, this setting is canceled and set automatically to “NORMAL.”

Changing the Display Brightness—DIMMER

You can dim the display window.

Remote Control:

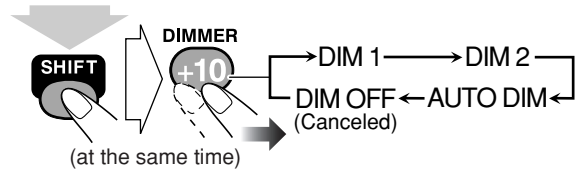

Main Unit:

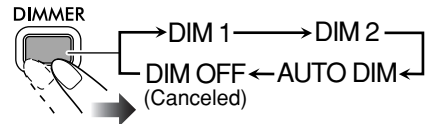

DIM 1	Dims the display.
DIM 2	Erases the display illumination.
AUTO DIM	Erases the display illumination when disc playback starts. <ul style="list-style-type: none"> • This function works only when playing DVD/VCD/SVCD or JPEG files. • The display illuminates when playback stops.

Changing the Picture Tone—VFP (Video Fine Processor)



While showing a playback picture on the TV screen, you can select the preset picture tone, or adjust it and store your own likeness.

To select a preset picture tone

1 Activate VFP.



NORMAL	
GAMMA	0
BRIGHTNESS	0
CONTRAST	0
SATURATION	0
TINT	0
SHARPNESS	0

On the TV screen

2 Select a preset picture tone.

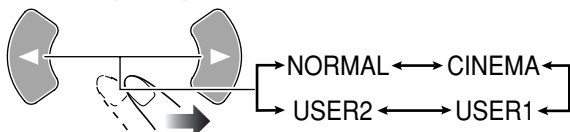

NORMAL	Normally select this.
CINEMA	Suitable for a movie source.
USER1/USER2	You can adjust parameters and can store the settings (see the right column).

To adjust the picture tone

1 Select “USER1” or “USER2.”

- Follow steps 1 and 2 explained on the left column.

2 Select a parameter you want to adjust.

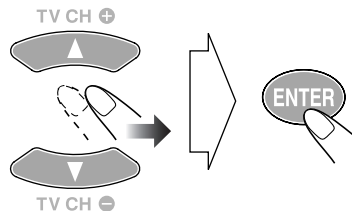

GAMMA	Adjust if the neutral color is bright or dark (–3 to +3).
BRIGHTNESS	Adjust if the entire picture is bright or dark (–8 to +8).
CONTRAST	Adjust if the far and near positions are unnatural (–7 to +7).
SATURATION	Adjust if the picture is whitish or blackish (–7 to +7).
TINT	Adjust if the human skin color is unnatural (–7 to +7).
SHARPNESS	Adjust if the picture is indistinct (–8 to +8).

3 Adjust the parameter.

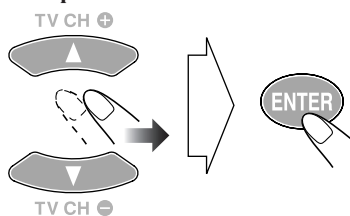

4 Repeat steps 2 to 3 to adjust other parameters.

To erase the screen, press VFP again.

Setting the Clock



Without setting the built-in clock, you cannot use the Daily Timer (see page 30) and Sleep Timer (see page 18).

- To exit from the clock setting, press CLOCK/TIMER as required.
- To go back to the previous step, press CANCEL.

1 Activate the clock setting mode.



- If you have already adjusted the clock before, press the button repeatedly until the clock setting mode is selected (see page 30).

2 Adjust the hour.

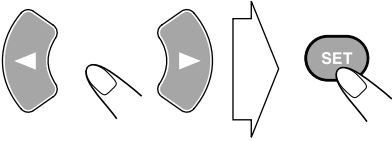

3 Adjust the minute.

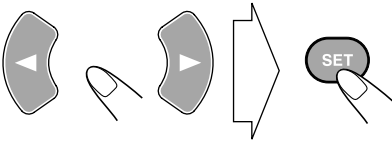

Now the built-in clock starts working.

To check the current clock time during play

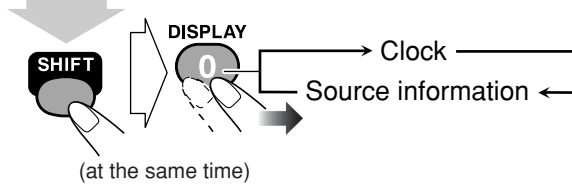

- While playing a DVD or MP3, you cannot check the current clock time (see page 9).

Turning Off the Power

Automatically



To turn off the System after playback is over—Auto Standby

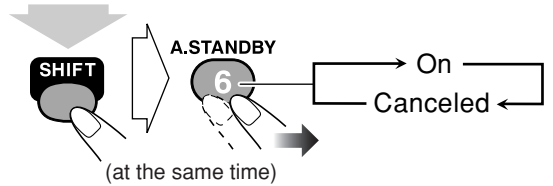

When Auto Standby is in use, the A.STANDBY indicator lights on the display. When the disc play stops, the A.STANDBY indicator starts flashing. If no operation is done for about 3 minutes while the indicator is flashing, the System turns off (in standby) automatically.

- Auto Standby does not work while you are listening to radio (FM/AM) and the external component (AUX and USB).

To turn off the System after a certain period of time—Sleep Timer

1 Specify the time (in minutes).

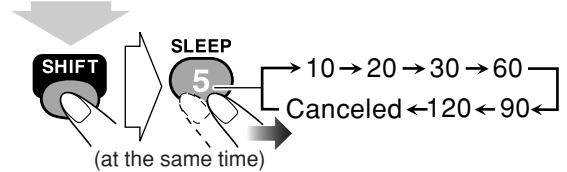

- SLEEP indicator also lights up on the display.

2 Wait until the set time goes off.

To check the time remaining until the shut-off time

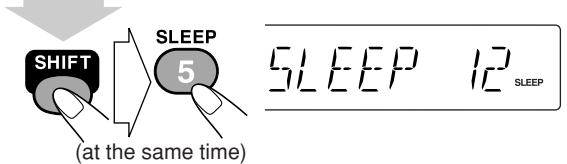

- If you press the button repeatedly, you can change the shut-off time.

Unique DVD/VCD Operations

Remote control

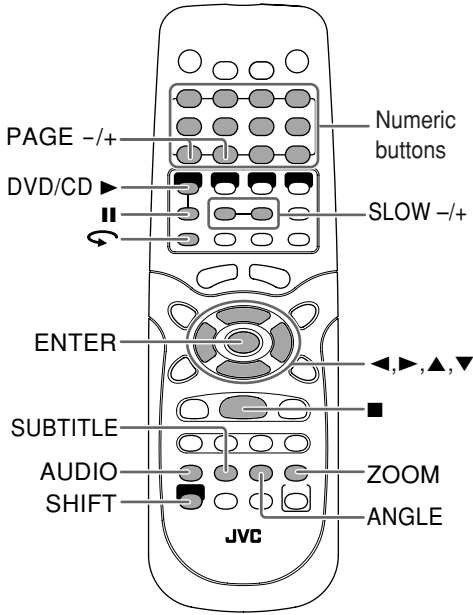

Selecting the Sound Track



For DVD Video: While playing back a chapter containing audio languages, you can select the language to listen to.

For DVD Audio: While playing back a track containing audio channels, you can select the audio channel to listen to.

For SVCD/VCD: While playing back a track, you can select the audio channel to play.

- You can also select the audio track using the on-screen bar (see page 25).



While playing a DVD Video...

Ex.:

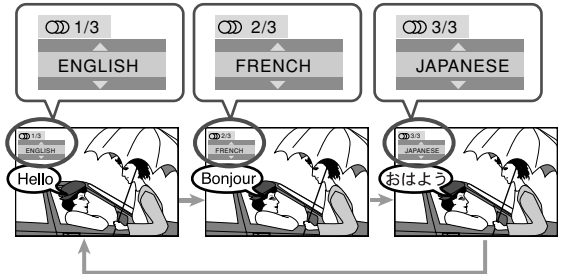

While playing a DVD Audio...

Ex.:

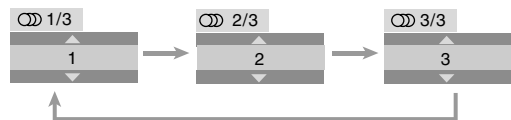

While playing an SVCD or VCD...

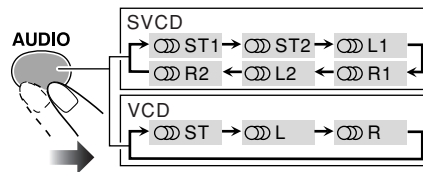

ST1/ST2/ST To listen to normal stereo (2 channel) playback.

L1/L2/L To listen to the left audio channel.

R1/R2/R To listen to the right audio channel.

- SVCD can have 4 audio channels. Karaoke SVCD usually uses these 4 channels to record two 2-channel recordings (ST1/ST2).

Selecting the Subtitle Language

For DVD Video: While playing back a chapter containing subtitles in different languages, you can select the subtitle language to display on the TV screen.

For SVCD: While playing back a track, you can select the subtitles even if no subtitles are recorded on the disc.

- You can also select the subtitle language using the on-screen bar (see page 25).

While playing a DVD Video...

1 Display the subtitle selection window.



2 Select the subtitle language.

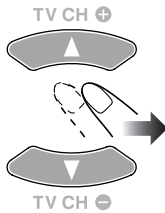

Ex.:

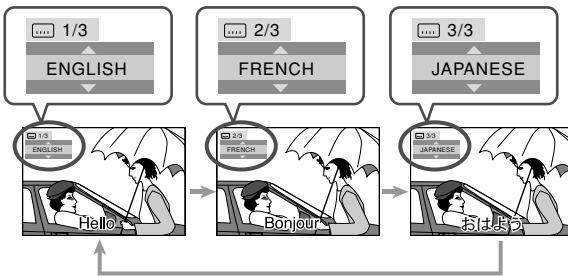

While playing an SVCD...

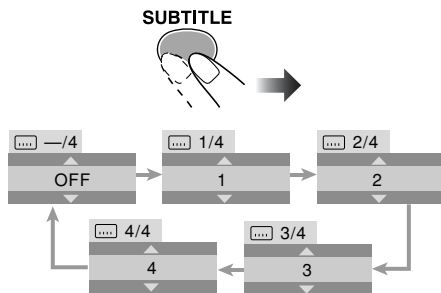

Selecting the View Angle

- This function is only used while playing DVD Video.
- While playing back a chapter containing multi-view angles, you can view the same scene from different angles.
- You can also select the multi-view angles using the on-screen bar (see page 25).

While playing...

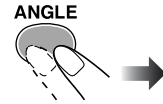

Ex.:

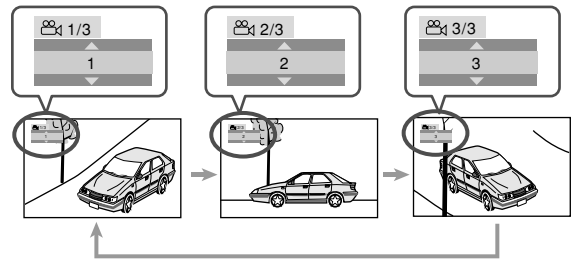

Playing Back a Bonus Group

- This function is only used while playing DVD Audio.
- Some DVD Audios have a special group called “bonus group” whose contents are not open to the public.
- To play back a bonus group, you have to enter the specific “key number” (a kind of password) for the bonus group.
- The way of getting the key number depends on the disc.

1 Select the bonus group.

- The bonus group is usually recorded as the last group (for example, if a disc contains 4 groups including a bonus group, “group 4” is the bonus group).
- When the bonus group is detected, BONUS indicator lights up.
- For how to select the group, see “To select a title/group” on page 12.

2 Enter the key number.

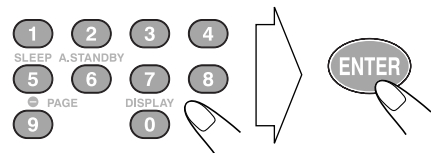

3 Follow the interactive instructions shown on the TV screen.

To cancel the key number entry, press ■.

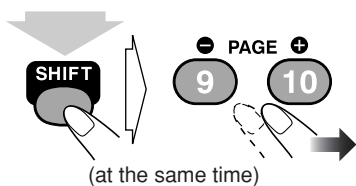

Selecting Browsable Still Pictures

- This function is only used while playing DVD Audio.
- While playing back a track linked to browsable still pictures (B.S.P.), you can select the still picture (turn the page) to be shown on the TV screen.
- When a DVD Audio with a bonus group is detected, B.S.P. indicator lights up.
- If a track is linked to browsable still pictures (B.S.P.), they are usually shown in turn automatically during playback.
- You can also select the page using the on-screen bar (see page 25).



Special Effect Playback

Still picture playback

To start still picture playback:	To resume normal playback:
While playing... 	

Frame-by-frame playback

1 While playing...



Still picture playback starts.

2 Advance the still picture frame by frame.



To resume normal playback, press DVD/CD ►.

Slow-motion playback

1 While playing...



Still picture playback starts.

2 Select slow-motion speed.

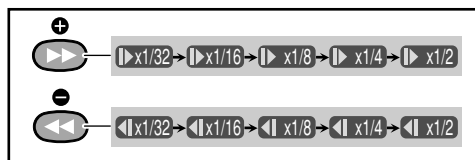
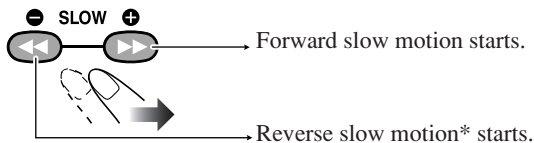

* Not available for SVCD/VCD.

To resume normal playback, press DVD/CD ►.

To replay the previous scenes (One touch replay function)

- This function is only used while playing DVD Video.

RETURN The playback position moves back about 10 seconds before the current position (only within the same title).



Zoom

1 While playing back...

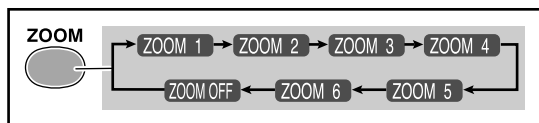
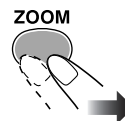

- As the number increases, magnification also increases.

2 Move the zoomed-in position.

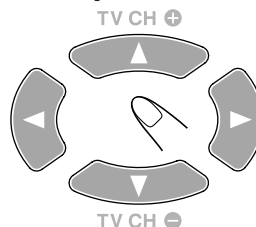

To resume normal playback, press ZOOM repeatedly until "ZOOM OFF" appears on the TV screen.

To use this function for JPEG (still pictures), see "To zoom in the still picture" on page 29.

Advanced Disc Operations

Remote control

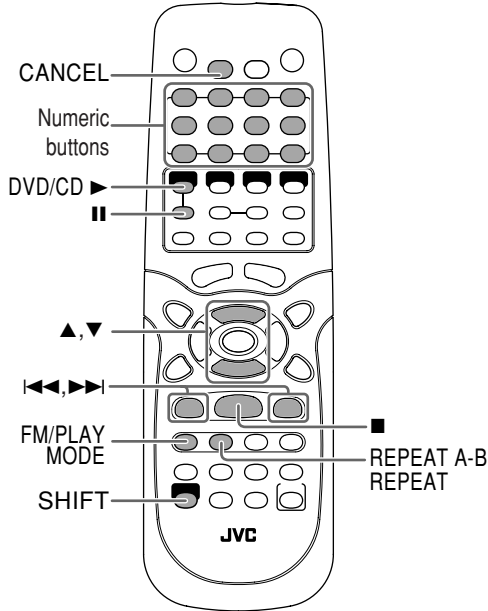

Main unit

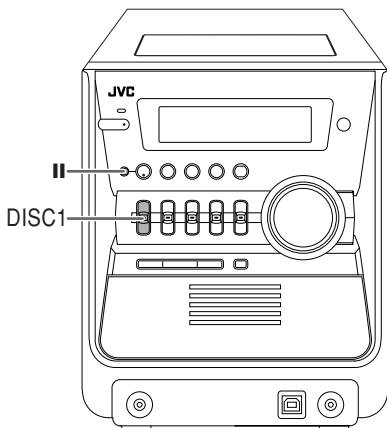

Programming the Playing Order

Program Play



You can arrange the playing order of the chapters or tracks (up to 99) before you start playback.

1 Before starting playback, activate Program Play.

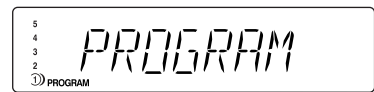
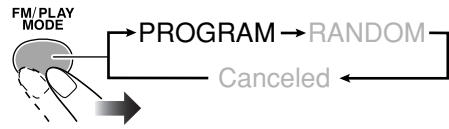

On the display

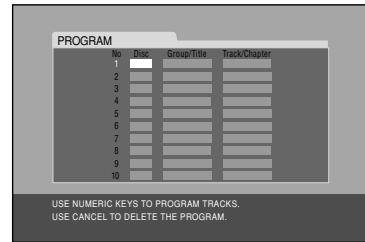

On the TV screen

2 Select chapters or tracks you want to program.

• For DVD/MP3:

- ① Select a disc number.
- ② Select a title or group number.
- ③ Select a chapter or track number.

• For SVCD/VCD/CD:

- ① Select a disc number.
- ② Select tracks.

• If the disc is not in current tray, the System may prompt for the group number entry as well, however, during playback, the System will ignore these entries.

To enter the numbers:

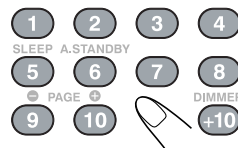

Examples:

To enter number 5, press 5.
To enter number 15, press +10, then 5.
To enter number 30, press +10, +10, then 10.

3 If you want to program the other chapters or tracks, repeat the above step 2.

4 Start playback.



Playback starts in the order you have programmed.

To skip a step:	To pause:	To stop:
	<p>To release, press DVD/CD ►.</p>	

To check the programmed contents

Before or after playback...

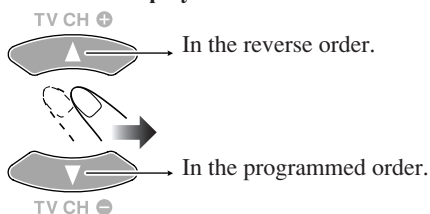

To modify the program

Before or after playback...

To erase the last step:	To erase the entire program:
To add steps in the program: Repeat step 2 on page 22.	

To exit from Program Play

Before or after playback...

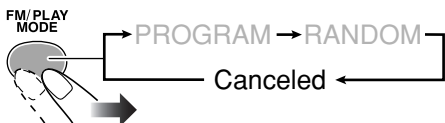

Playing at Random—Random Play

You can play the chapters or tracks of all loaded discs at random.

- Random Play cannot be used for some DVDs.

1 Before starting playback, activate Random Play.

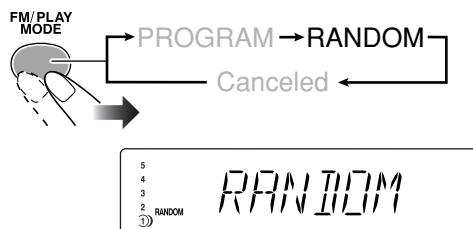

2 Start playback.



Playback starts in random order. Random Play continues to the disc on the next tray when all the chapters or tracks in the current disc are played once (when Repeat Play is not activated).

- Playback ends when all the discs are played once (when Repeat Play is not activated).

To skip a chapter/track:	To pause:	To stop:
<p>To skip to the beginning of the current track, press ◀◀.</p>	<p>To release, press DVD/CD ►.</p>	

- During Random Play, you cannot select disc by using DISC SELECT.

To exit from Random Play

Before or after playback...

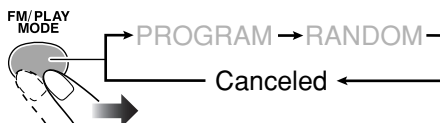

Playing Repeatedly



- You can also select the repeat mode using the on-screen bar (see page 26).

Repeat Play

You can repeat playback.

• For DVD Video:

During playing...

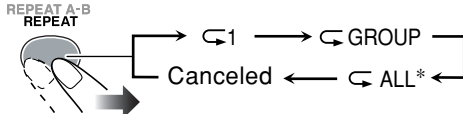

Before playback...

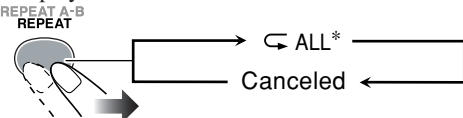

• For DVD Audio:

During or before playback...

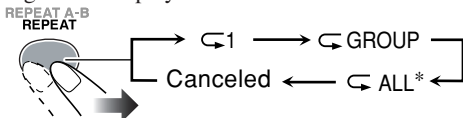

• For MP3:

During or before playback...

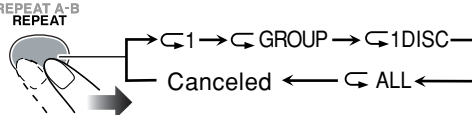

• For CD/SVCD/VCD:

During or before playback without PBC...

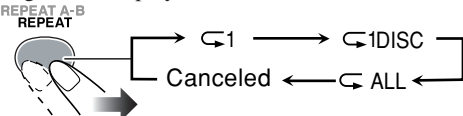

During playback with PBC...

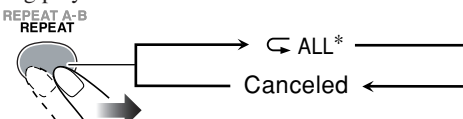

• For Program Play:

During or before playback...

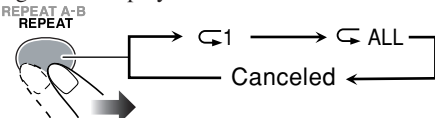

• For Random Play:

During or before playback...

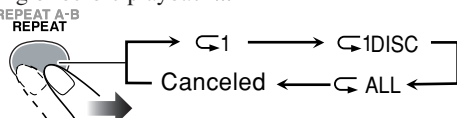

ALL*	Repeats the discs in all trays or all programmed tracks.
1	Repeats the current chapter/track.
GROUP	Repeats the current title/group.
1DISC	Repeats the current disc.
Canceled	Cancels Repeat Play mode.

*When DVD Video, DVD Audio or SVCD/VCD with PBC is loaded in the System, this function may not work correctly.

A-B Repeat

You can repeat playback of a desired portion by specifying the beginning (point A) and the ending (point B).

- A-B Repeat cannot be used for MP3 and for some DVDs.
- A-B Repeat can be used within the same title while playing a DVD Video, and within the same track for the other discs.

1 While playing (without PBC for SVCD/VCD), select the start point (A).

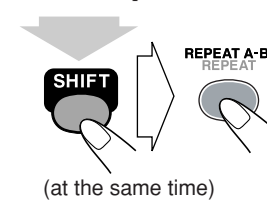

- A- lights on the display.
- A- appears on the TV screen if the TV is turned on.

2 Select the end point (B).

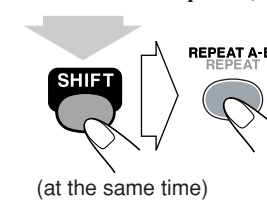

- A- changes to A-B.
- A-B appears on the TV screen and A-B Repeat starts.
- You can search for the end point using .

To cancel A-B Repeat, press REPEAT A-B again while holding SHIFT.

Prohibiting Disc Ejection—Child Lock



You can lock the disc trays so that no one can eject the loaded disc.

- This is possible while the System is on standby and the clock indication is turned on (see page 10).

While the disc trays are closed...

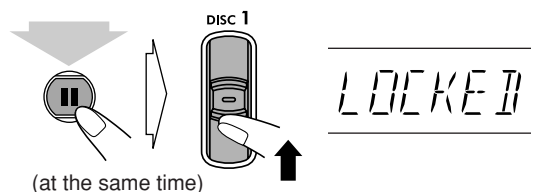

To cancel the prohibition, repeat the same procedure. "UNLOCKED" appears on the display.

On-Screen Disc Operations

Remote control

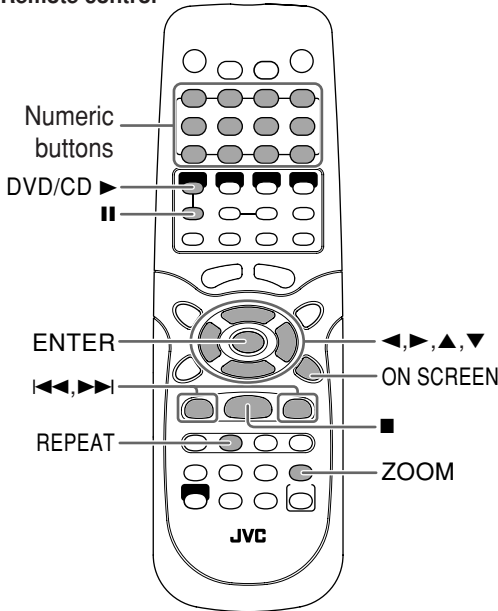

On-screen bars

DVD Video

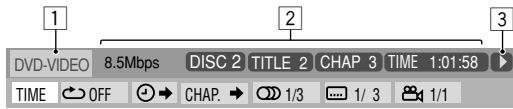

DVD Audio



SVCD



VCD



CD



On-screen Bar Information

You can check the disc information (except for MP3/JPEG) and use some functions through the on-screen bar.

1 Disc type

2 Playback information

Indication	Meanings
Mbps	Current transfer rate (Megabits per second)
DISC 2	Current disc
TITLE 2	Current title
CHAP 3	Current chapter
GROUP 1	Current group
TRACK 14	Current track
TIME 1:25:58	Time indications

3 Operation modes

Indication	Meanings
▶	Playback
▶/◀	Forward/Reverse search
▶/◀	Forward/Reverse slow-motion
⏸	Pause
⏹	Stop

4 Function icons (on the pull-down menu)

Indication	Meanings
TIME	Select to change the time indication.
↺ OFF	Select to repeat playback.
⌚	Select for time search.
CHAP. →	Select for chapter search.
TRACK →	Select for track search.
🔊 1/3	Select to change the audio language or channel (see also page 19).
📄 1/3	Select to change subtitle language (see also page 20).
👁 1/3	Select to change the view angle (see also page 20).
PAGE 1/5	Select to change the page (see also page 21).

- You cannot use ◀, ▶, ▲, and ▼ buttons to select the disc menu while displaying the pull-down menu.

Operations Using the On-screen Bar

Ex.: Selecting a subtitle (French) for DVD Video:
While a disc is selected as the source...

1 Display the on-screen bar with the pull-down menu.

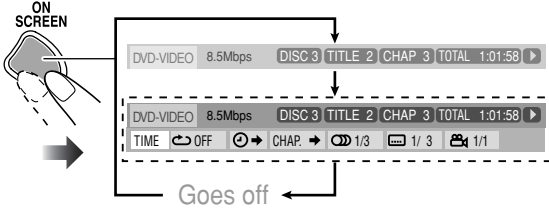

2 Select (highlight) the item you want.



3 Display the pop-up window.

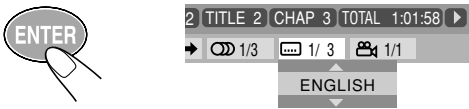

4 Select the desired option in the pop-up window.

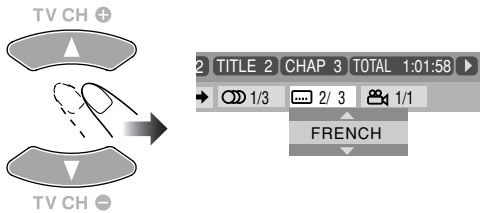

5 Finish the setting.



Pop-up window goes off.

To erase the on-screen bar



For detailed operations of the following functions, see also "Operations Using the On-screen Bar" on the left.

Changing the time information

You can change the time information in the on-screen bar and the display on the System.

1 Display the on-screen bar with the pull-down menu.



2 Make sure **TIME** is selected (highlighted).

3 Change the time indication.

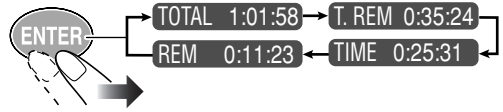

TOTAL	Elapsed disc time.
T. REM	Remaining disc time.
TIME	Elapsed playing time of the current chapter/track.
REM	Remaining time of the current chapter/track.

To erase the on-screen bar



Repeat Play

• See also page 24.

1 While playing (without PBC for SVCD/VCD), display the on-screen bar with the pull-down menu.

2 Select **OFF**.

3 Display the pop-up window.



4 Select the repeat mode you want.

ALL	Repeats all discs or all programmed tracks.
A-B	Repeats a desired portion (see next column).
TITLE	Repeats the current title.
GROUP	Repeats the current group.
DISC	Repeats the current disc (except for DVD).
CHAPTER	Repeats the current chapter.
TRACK*	Repeats the current track.
OFF	Cancels Repeat Play.

*During Program Play and Random Play, “STEP” appears.

5 Finish the setting.



A-B Repeat

• See also page 24.

1 While playing, display the on-screen bar with the pull-down menu.

2 Select [OFF].

3 Display the pop-up window.



4 Select “A-B.”



5 Select the start point (A).



6 Select the end point (B).



A-B Repeat starts. The selected portion plays repeatedly.

- Before pressing ENTER, you can search for the end point using ►►.

Time Search

You can move to a particular point by specifying the elapsed playing time.

For DVD Video/DVD Audio:

You can specify the elapsed time for the current title.

For CD/SVCD/VCD:

- While playing back, you can specify the elapsed time for the current track.
- While stopped, you can specify the elapsed time for the disc. (You cannot use this function for SVCD/VCD with PBC.)

1 Display the on-screen bar with the pull-down menu.

2 Select [TIME].

3 Display the pop-up window.



4 Enter the time.

You can specify the time in hours/minutes/seconds.

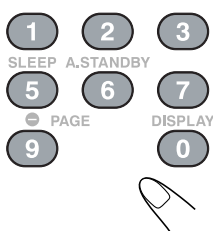

Examples:

To move to a point of 1 (hours): 02 (minutes): 00 (seconds), press 1, 0, 2, 0, then 0.

To move to a point of 54 (minutes): 00 (seconds), press 0, 5, 4, 0, then 0.

- It is always required to enter the hour digit (even “0” hour), but it is not required to enter trailing zeros (the last two digits in the examples above).
- To correct a misentry, press cursor ◀ to erase the last entry.

5 Finish the setting.



The System starts playing the disc from the selected playing time.

Chapter/Track Search

You can search for the chapter (DVD Video) or track (DVD Audio) number to play.

- 1 While playing, display the on-screen bar with the pull-down menu.
- 2 Select [CHAP. →] or [TRACK →].
- 3 Display the pop-up window.

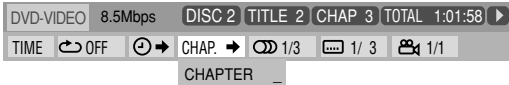

- 4 Enter the desired chapter/track number.

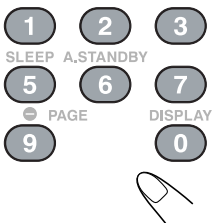

Examples:

To select chapter/track number 5, press 5.

To select chapter/track number 15, press 1, then 5.

To select chapter/track number 30, press 3, then 0.

- To correct a misentry, press the numeric buttons until the desired number shown in the pop-up window.

- 5 Finish the setting.



The System starts playing the searched chapter or track.

Operations on the CONTROL Screen

The CONTROL screen automatically appears on the TV screen when you load an MP3 or JPEG.

You can search for and play the desired tracks through the CONTROL screen.

- If both types of files (MP3 and JPEG) are recorded on a disc, select the file type to play (see page 34).

CONTROL screen
Ex.: When the MP3 disc is loaded.

Group	Track	File Name
2 / 3	5 / 14 (Total 41)	Cloudy.mp3
Blue		Fair.mp3
Red		Fog.mp3
Green		Hail.mp3
		Indian summer.mp3
		Rain.mp3
		Shower.mp3
		Snow.mp3
		Thunder.mp3
		Typhoon.mp3
		Wind.mp3
		Winter sky.mp3

Track Information for Rain:

Title	Shower.mp3
Rain	Snow.mp3
Artist	Thunder.mp3
	Typhoon.mp3
Album	Wind.mp3
	Winter sky.mp3

- 1 Current group number/total group number
- 2 Current group
- 3 Group list
- 4 Current track (in blue)
- 5 Track information (ID3 Tag Version 1.0: only for MP3)
- 6 Repeat Play setting
- 7 Elapsed playing time of the current track (only for MP3)
- 8 Operation mode icon
- 9 Current track number/total number of tracks in the current group (total number of tracks on the disc)
- 10 Highlight (green) bar
- 11 Track list

To move the highlight bar between group list and track list

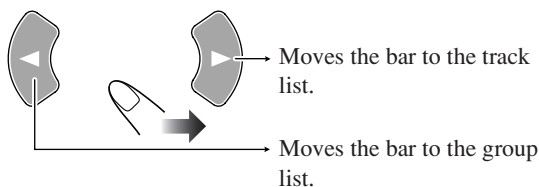

To select a group/track in the list

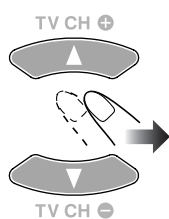

Move the highlight bar to a desired item.

- If you move the highlight bar while playing back an MP3 disc, the selected track starts playback automatically.

To start playback

For MP3:	
	Playback starts with the selected track. • Pressing DVD/CD ► also starts playback.
For JPEG:	
	The selected track (still picture) is displayed until you change it.
	Slide-show playback starts. Each track (still picture) is shown on the screen for few seconds, then changes one after another.

- Once you start playing back a JPEG track, the CONTROL screen goes off.
- To cancel slide-show and display the current still picture, press ENTER.

To skip a track:	To pause:	To stop playback:
	To release, press DVD/CD ►.	

To repeat slide-show for JPEG

While playing or before starting playback...

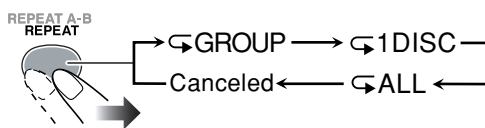

	Repeats the current group.
	Repeats the current disc.
	Repeats all discs.

- For Repeat Play of MP3, see page 24.

To zoom in the still picture

- You cannot zoom in the still picture during slide-show.

1 While playing...

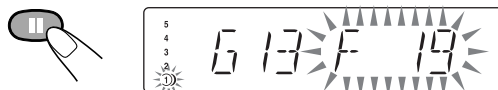

2 Change the magnification.

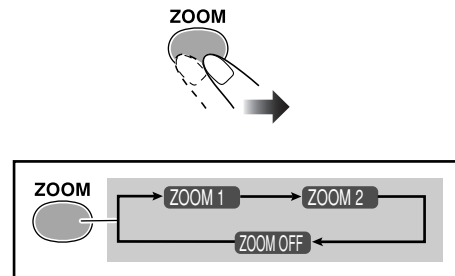

As the number increases, magnification also increases.

3 Move the zoomed-in position.

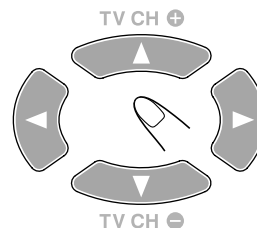

To resume normal playback, press ZOOM repeatedly until "ZOOM OFF" appears on the TV screen.

Timer Operations

Remote control

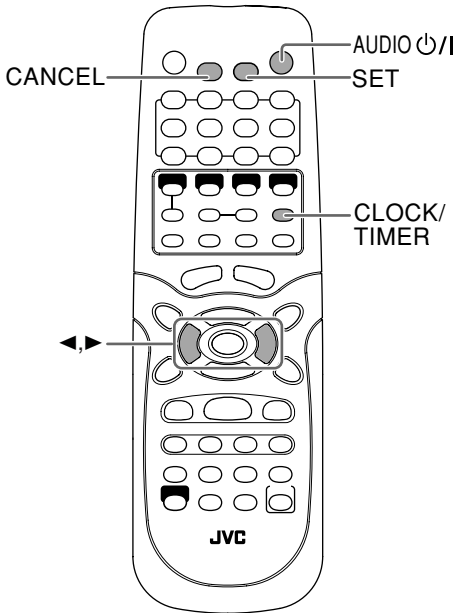

Setting the Daily Timer

Using Daily Timer, you can wake up with your favorite music.

You can store three Daily Timer settings; however, you can activate only one of the timers at a time.

- To exit from the timer setting, press **CLOCK/TIMER** as required.
- To correct a misentry during the process, press **CANCEL**. You can return to the previous step.

1 Select one of the timer setting modes you want to set—**Daily 1 ON time, Daily 2 ON time, or Daily 3 ON time.**

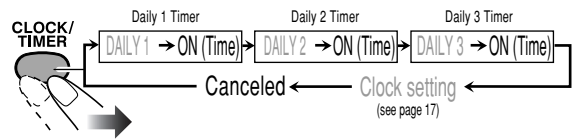

Ex.: When Daily Timer 1 setting mode is selected

- When the clock has not been adjusted, pressing **CLOCK/TIMER** makes the System enter the clock setting mode.

2 Make the timer setting as you want.

Repeat the following operations until you finish setting in the following order—

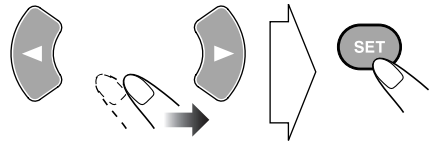

- ① Set the hour then the minute for on-time.
- ② Set the hour then the minute for off-time.
- ③ Select the playback source—"TUNER FM," "TUNER AM," "DISC," or "AUX."

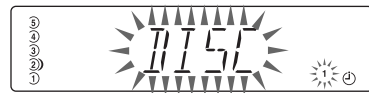

- ④ For "TUNER FM" and "TUNER AM": Select a preset channel (see page 11).

- Select "FM --" or "AM --" for the last selected station.

For "DISC": Select the disc number, group number, then the track number (see page 12).

- Select "DISC -" for the last selected disc tray number.

For "AUX": Connect the other equipment (see page 14).

⑤ **Select the volume level.**

- You can select the volume level (“1” to “MAX” and “VOL --”). If you select “VOL --,” the volume is set to the last level when the System has been turned off.

Once settings are complete, the Timer setting information appears in sequence.

3 Turn off the System (on standby) if you have set the timer with the System turned on.



How Daily Timer actually works

Once the Daily Timer has been set, the timer (⊕) indicator and timer number indicator (1/2/3) are lit on the display. Daily Timer is activated at the same time everyday until the timer is turned off manually (see the next column) or another timer is activated.

When the on-time comes

The System turns on, tunes in to the specified station or start playing the loaded disc with the specified track, and sets the volume level to the preset level.

- You cannot start the specified title/chapter/track of DVD-Video/SVCD/VCD, though you can select it at the timer setting.
- DVD-Video/SVCD/VCD starts playback from the beginning.
- While Daily Timer is working, the timer (⊕) indicator and timer number indicator (1/2/3) flash on the display.

When the off-time comes

The System stops playback, and turns off (on standby) automatically.

- The timer setting remains in memory until you change it.

To turn off the Timer after its setting is done

Since Daily Timer is activated at the same time everyday, you may need to cancel it on some particular days.

1 Select the Timer you want to cancel.

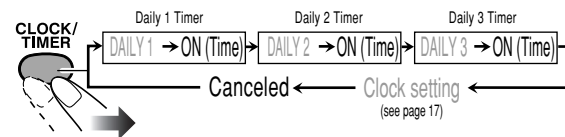

Ex.: To cancel Daily Timer 1

2 Turn off the selected Timer.



To turn on the Timer

1 Select the Timer (DAILY 1, DAILY 2, or DAILY 3) you want to activate.

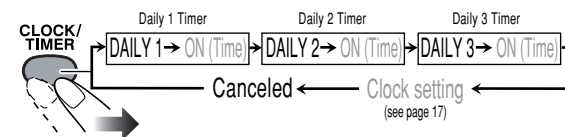

Ex.: When Daily Timer 1 is selected

2 Activate the selected Timer.



Setup Menu Operations

Remote control

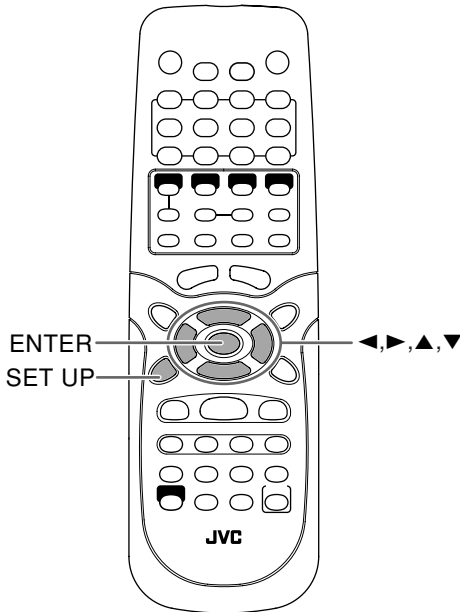

Setup Menu Icons

The icon for the selected Setup Menu will be highlighted.

Ex.: LANGUAGE Setup Menu is selected.

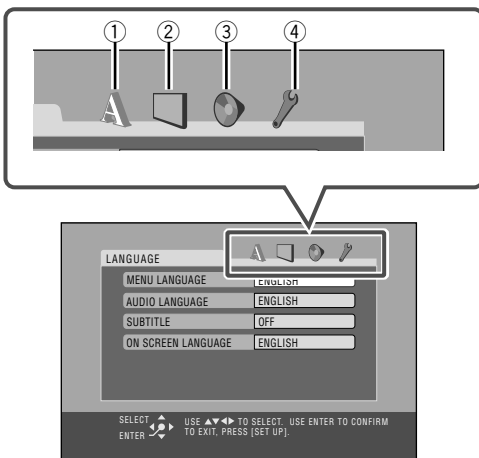

- ① LANGUAGE Setup Menu
- ② PICTURE Setup Menu
- ③ AUDIO Setup Menu
- ④ OTHERS Setup Menu

Operating Procedure

You can use the Setup Menus only when a disc is selected as the source and its playback is not yet started.

Ex.: Selecting "STILL PICTURE" for "FILE TYPE":

1 Display the Setup Menu.

SET UP

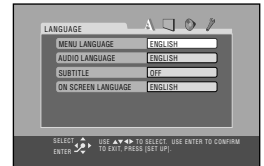

2 Select one of the Setup Menus.

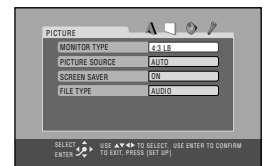

3 Select the item you want to adjust.

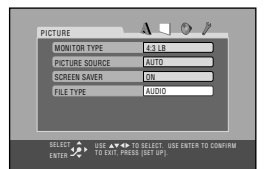
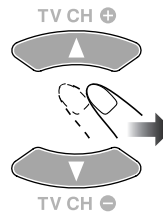

4 Display the pop-up window.

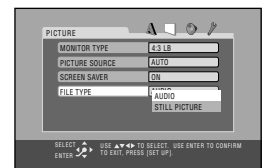

5 Select the desired option in the pop-up window.

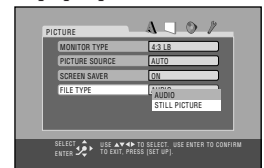
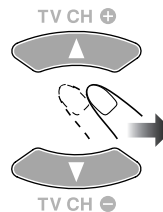

6 Finish the setting.



- 7 Repeat steps 3 to 4 to set other items on the same Setup Menu.**
Repeat steps 2 to 4 to set other items on another Setup Menu.

To exit from the Setup Menu



■ LANGUAGE Setup Menu

You can select the initial languages for disc playback. You can also select the language shown on the TV screen while operating this System.



MENU LANGUAGE

Some discs have multiple menu languages. Select from—ENGLISH, SPANISH, FRENCH, CHINESE, GERMAN, ITALIAN, JAPANESE, AA – ZU (see “Language Code List” on page 41).

AUDIO LANGUAGE

Some discs have multiple audio languages. Select from—ENGLISH, SPANISH, FRENCH, CHINESE, GERMAN, ITALIAN, JAPANESE, AA – ZU (see “Language Code List” on page 41).

SUBTITLE

Some discs have multiple subtitle languages. Select from—ENGLISH, SPANISH, FRENCH, CHINESE, GERMAN, ITALIAN, JAPANESE, AA – ZU (see “Language Code List” on page 41) or “OFF (no subtitle).”

ON SCREEN LANGUAGE

Select one of the languages shown on the TV screen from—ENGLISH, SPANISH or FRENCH.

■ PICTURE Setup Menu

You can select the desired options concerning a picture or monitor screen.



MONITOR TYPE

Select the monitor type of your TV to play DVD Video recorded with aspect ratio of 16:9.

Select one of the following:

16:9:

Select when the aspect ratio of your TV is 16:9 and when the TV has the screen size adjustment function.

4:3 LB (Letter Box):

Select when the aspect ratio of your TV is 4:3 (conventional TV). While viewing a wide screen picture, the black bars appear on the top and the bottom of the screen.

4:3 PS (Pan Scan):

Select when the aspect ratio of your TV is 4:3. While viewing a wide screen picture, the black bars do not appear; however, the left and right edges of the pictures will not be shown on the screen.

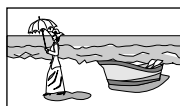

Ex.: 16:9

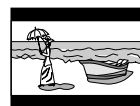

Ex.: 4:3 LB

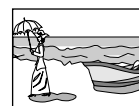

Ex.: 4:3 PS

PICTURE SOURCE

You can obtain optimal picture quality by selecting an appropriate option—picture source type (either video source or film source).

Select one of the following:

AUTO: Normally select this.
When playing back a disc containing both video and film sources, the System automatically changes the processing to match it to the picture type (film or video source) of the current chapter.

FILM: To play a film source disc.

VIDEO: To play a video source disc.

SCREEN SAVER

You can activate or deactivate screen saver while operating the built-in disc player.

Select one of the following:

ON: The picture on the TV screen becomes dark when no operation is done for about 5 minutes.

OFF: To cancel the screen saver.

FILE TYPE

If both audio tracks (MP3 files) and still pictures (JPEG files) are recorded on a disc, you can select which to play.

Select one of the following:

AUDIO: To play MP3 files.

STILL PICTURE: To play JPEG files.

AUDIO Setup Menu

You can adjust the sound settings of the System.

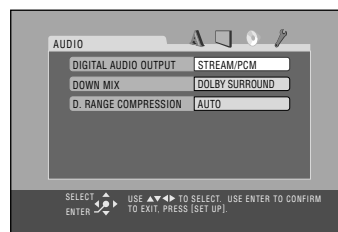

DIGITAL AUDIO OUTPUT

When using the digital output terminal on the rear, set this correctly according to the connected component.

Select one of the following:

PCM ONLY: To connect to a linear PCM digital equipment.

DOLBY DIGITAL /PCM: To connect to a Dolby Digital decoder or an amplifier with a built-in Dolby Digital decoder.

STREAM/PCM: To connect to a DTS decoder or an amplifier with a built-in DTS decoder.

• See also “OPTICAL DIGITAL OUT Signals” on page 42.

DOWN MIX

When using the digital output on the rear, set this correctly according to the connected component.

When playing a multi-channel DVD, the System converts the signals into 2 channels properly.

Select one of the following:

DOLBY SURROUND: To connect an amplifier with the Dolby Pro Logic decoder.

STEREO: To connect a conventional stereo amplifier, receiver, MD recorder, etc.

D. (Dynamic) RANGE COMPRESSION

You can compress the dynamic range (the difference between the loudest sound and the softest sound) to enjoy a powerful sound even at a low volume level when listening to Dolby Digital software. This is useful at night.

- The effectiveness varies depends on the software.

Select one of the following:

AUTO: To apply the compression effect to the downmixed multi-channel sound.

ON: To always apply the compression effect for all Dolby Digital software. Loud sound will become low and vice versa.

■ OTHERS Setup Menu

You can change some other convenient functions.

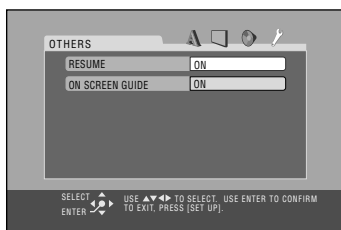

RESUME

You can activate or deactivate Resume for disc playback (see pages 12).

Select one of the following:

ON: To activate Resume.

OFF: To cancel Resume.

ON SCREEN GUIDE

You can activate or deactivate the on-screen guide icons (see pages 12 and 25).

- When recording the picture on a VCR, select "OFF" to avoid recording the guide icons on your video tape.

Select one of the following:

ON: To activate the on-screen guide icons.

OFF: To cancel the on-screen guide icons.

Operating the TV



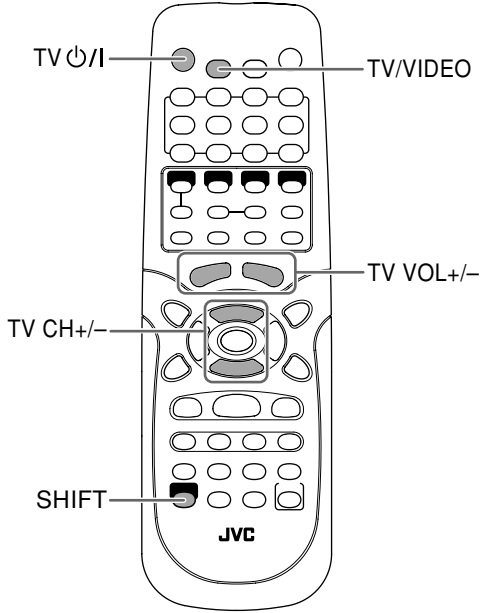

Remote control

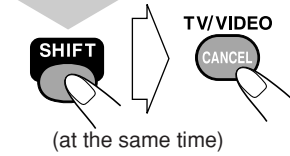

Operating TV

You can operate the JVC's TV using this remote control.

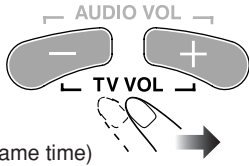
To operate the TV

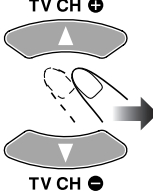
To turn on or off the TV:	To select the input mode (either TV or VIDEO):
	 <p>(at the same time)</p>
To adjust the TV volume:	
	 <p>(at the same time)</p>
To select the TV channel:	
	 <p>(at the same time)</p>

Learning More about This System ● ● ●

Getting Started (see pages 3 to 6)

Changing the Scanning Mode:

- To enjoy the progressive video picture, connect a TV with the progressive video input using component video cord.

Daily Operations—Playback (see pages 10 to 14)

Listening to the Radio:

- If you store a new station into an occupied preset number, the previously stored station in that number will be erased.
- When you unplug the AC power cord or if a power failure occurs, the preset stations will be erased in a few days. If this happens, preset the stations again.

Playing Back a Disc:

- When using an 8 cm disc, place it on the inner circle of the disc tray.
- On some DVD, SVCD, or VCD discs, the actual operations may be different from what is explained in this manual, due to the programming and disc structure; such differences are not malfunction of this System.
- When discs* in more than one tray are loaded on the disc trays, they are played in sequence as follows. (When DVD Video, DVD Audio or SVCD/VCD with PBC is loaded in the System, playback of the disc next to these discs will not start.):

Ex.: When DISC 2 is selected:

DISC 2⇒DISC 3⇒DISC 4⇒DISC 5⇒DISC 1⇒
(then stops)

- * When no disc is loaded on the disc tray, that disc number is skipped.
- You can exchange discs while playing or selecting another disc.
- Some DVD Audio discs prohibit downmixed output. When you play back such a disc, “LR ONLY” appears on the display and the System plays back the left front and right front signals.
- 3D Phonic setting is also applied to the optical digital output signals through the OPTICAL DIGITAL OUT terminal.
- For MP3/JPEG playback...
 - This System cannot play “packet write” discs.
 - MP3/JPEG discs require a longer readout time than regular CDs. (It depends on the complexity of the group/file configuration.)
 - Some MP3/JPEG files cannot be played back and will be skipped. This result from their recording processes and conditions.
 - When making MP3 discs, use ISO 9660 Level 1 or Level 2 for the disc format.
 - This System can play back MP3/JPEG files with the extension code <.mp3> or <.jpg> (regardless of the letter case—upper/lower).
 - It is recommended that you make each MP3 file at a sampling rate of 44.1 kHz and at bit rate of 128 kbps.

- This System can recognize the total of 1000 tracks and of 99 groups (each group can contain up to 150 tracks). Those exceeding the maximum number cannot be recognized.
- This System can show up to 23 characters of the file (track) names (except for extension) and 30 characters of the ID3 tags on the display and the TV screen.
- Some characters or symbols will not be shown (and will be blanked) on the display.
- When using Resume on SVCD or VCD with PBC, the playback might start on a position slightly different from where you have stopped.
- You can use Resume only for the DVD/SVCD/VCD except for some discs—depending how the disc is programmed.

Playing Back from the PC:

- Check if your PC equipped with the CD-ROM drive is running on Windows® 98*, Windows® 98SE*, Windows® Me*, Windows® 2000*, or Windows® XP* and prepare its CD-ROM.
- DO NOT turn off the System or disconnect the USB cable while installing the drivers and for a several seconds each time your PC is recognizing the System.
- Use a full speed USB cable (version 1.1).
- If your PC does not recognize the System, disconnect the USB cable and connect it again. If this does not work, restart Windows.
- The drivers installed can be recognized only when the USB cable is connected between the System and your PC.
- The sound may not be played back correctly—interrupted or degraded—due to your PC settings or PC specifications.

* Microsoft®, Windows® 98, Windows® 98SE, Windows® Me, Windows® 2000 and Windows® XP are registered trademarks of Microsoft corporation.

Daily Operations—Sound&Other Adjustments (see pages 15 to 18)

Adjusting the Volume:

- Be sure to turn down the volume before connecting or putting the headphones.

Adjusting the Sound:

- This function also affects the sound through the headphones.

Setting the clock:

- “AM 12:00” will flash on the display until you set the clock.
- The clock may gain or lose 1 to 2 minutes per month. If this happens, reset the clock.

Unique DVD/VCD Operations (see pages 19 to 21)

- During slow-motion playback, no sound will be reproduced.
- One touch replay function works only within the same title, though it works between chapters.
- While zoomed in, the picture may look coarse.

Advanced Disc Operations (see pages 22 to 24)

Programming the Playing Order—Program Play:

- If you try to program the 100th track, “MEM FULL (memory full)” appears on the display.
- While programming steps...
Your entry will be ignored if you have tried to program an item number that does not exist on the disc (for example, selecting track 14 on a disc that only has 12 tracks).
- You cannot use Program Play and Random Play for JPEG discs.
- You cannot eject trays while in Program Play.

Playing at Random—Random Play:

- The ◀◀ button does not work for skipping chapters or tracks, but only work for going back to the beginning of the current chapter or track.

On-Screen Disc Operations (see pages 25 to 29)

- For JPEG files playback...
 - It is recommended that you record a file at 640 x 480 resolution. (If a file has been recorded at a resolution of more than 640 x 480, it will take a long time to be shown.)
 - This System can play only baseline JPEG files. Progressive JPEG files or lossless JPEG files cannot be played.
 - Baseline JPEG format: Used for digital cameras, web, etc.
 - Progressive JPEG format: Used for web.
 - Lossless JPEG format: An old type and rarely used now.
 - This System may not play back JPEG files properly which are recorded by the devices other than digital still camera.
 - If progressive or lossless JPEG files are played back, a black screen appears. In this case, stop playback and select a baseline JPEG file. Note that it may take a long time to select another file.

Timer Operations (see pages 30 and 31)

- When you unplug the AC power cord or if a power failure occurs, the timer will be canceled. You need to set the clock first, then the timer again.
- If you set the Sleep Timer after a Daily Timer starts playing the selected source, the Daily Timer is canceled.

Setup Menu Operations (see pages 32 to 35)

LANGUAGE Setup Menu:

- When the language you have selected for “MENU LANGUAGE,” “AUDIO LANGUAGE,” or “SUBTITLE” is not recorded on a disc, the original language is used as the initial language.

PICTURE Setup Menu—MONITOR TYPE:

- Even if “4:3 PS” is selected, the screen size may become 4:3 letter box with some DVD Video discs. This depends on how the discs are recorded.
- When you select “16:9” for a picture whose aspect ratio is 4:3, the picture slightly changes due to the process for converting the picture width.

AUDIO Setup Menu—DOWN MIX:

- This setting is not effective when DTS multi-channel software is played back.

OTHERS Setup Menu—ON SCREEN GUIDE:

Setup Menus and on-screen bar will be displayed (and recorded) even though this function is set to “OFF.” Subtitles and the information for zooming in always appear on the display regardless of this setting.

MP3/JPEG groups/tracks configuration

This System plays back the tracks as follows.

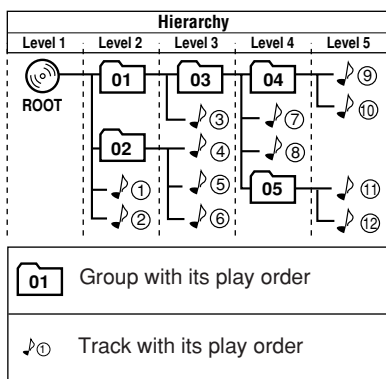

Maintenance

To get the best performance of the System, keep your discs and mechanism clean.

Handling discs

- When removing the disc from its case, hold it at the edge while pressing the center hole lightly.
- Do not touch the shiny surface of the disc, or bend the disc.
- Put the disc back in its case after use to prevent warping.
- Be careful not to scratch the surface of the disc.
- Avoid exposure to direct sunlight, temperature extremes, and moisture.

To clean the disc:

Wipe the disc with a soft cloth in a straight line from center to edge.

Cleaning the System

- Stains should be wiped off with a soft cloth. If the System is heavily stained, wipe it with a cloth soaked in water-diluted neutral detergent and wrung well, then wipe clean with a dry cloth.
- Since the System may deteriorate in quality, become damaged or get its paint peeled off, be careful about the following:
 - DO NOT wipe it with a hard cloth.
 - DO NOT wipe it strongly.
 - DO NOT wipe it with thinner or benzine.
 - DO NOT apply any volatile substance such as insecticides to it.
 - DO NOT allow any rubber or plastic to remain in contact for a long time.

To remove the speaker grilles

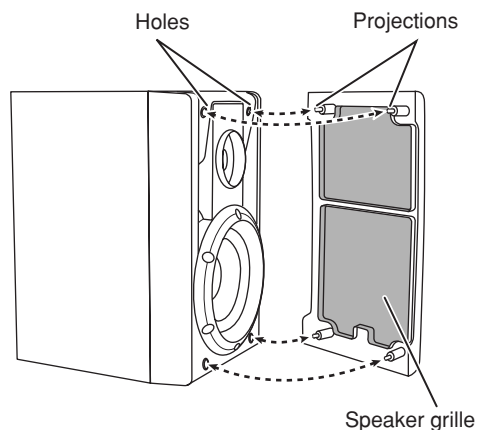

Troubleshooting

If you are having a problem with your System, check this list for a possible solution before calling for service.

General:

Adjustments or settings are suddenly canceled before you finish.

⇒ There is a time limit. Repeat the procedure again.

Operations are disabled.

⇒ The built-in microprocessor may malfunction due to external electrical interference. Unplug the AC power cord and then plug it back in.

Unable to operate the System from the remote control.

- ⇒ The path between the remote control and the remote sensor on the System is blocked.
- ⇒ Point it at the remote sensor on the front panel.
- ⇒ Signals cannot reach the remote sensor. Move closer to the System.
- ⇒ The batteries are exhausted.

No sound is heard from the speakers.

- ⇒ Speaker connections are incorrect or loose.
- ⇒ Headphones are connected.

No picture is displayed on the TV screen, the picture is blurred, or the picture is divided into two parts.

- ⇒ The video cord connections are incorrect or loose.
- ⇒ The System is connected to a TV which does not support progressive scanning.

The left and right edges of the picture are missing on the TV screen.

- ⇒ Select “4:3 LB” for “MONITOR TYPE” (see page 33).

Radio Operations:

Hard to listen to broadcasts because of noise.

- ⇒ Antennas connections are incorrect or loose.
- ⇒ The AM loop antenna is too close to the System.
- ⇒ The FM antenna is not properly extended and positioned.

Disc Operations:

The disc does not play.

- ⇒ The disc is placed upside down. Place the disc with the label side up.

ID3 Tag on an MP3 disc cannot be shown.

- ⇒ There are two types of ID3 Tag—Version 1 and Version 2. This System can show ID3 Tag Version 2.4 or earlier.

MP3/JPEG groups and tracks are not played back as you expect.

- ⇒ The playing order is determined when the disc was recorded. It depends on the writing application.

MP3/JPEG files are not played back.

- ⇒ The inserted disc may include both type of tracks (MP3 files and JPEG files). In this case, you can only play back the files selected by the “FILE TYPE” setting (see page 34).
- ⇒ You have changed the “FILE TYPE” setting after you inserted a disc. In this case, reload the disc.

“NO AUDIO” appears.

- ⇒ This System cannot play back illegally produced DVD Audio discs.

“LR ONLY” appears.

- ⇒ Some DVD Audio discs prohibit downmixed output. When you play back such a disc, this System plays back the left front and right front signals only.

The disc sound is discontinuous.

- ⇒ The disc is scratched or dirty.

The disc tray does not open or close.

- ⇒ The AC power cord is not plugged in.
- ⇒ Child Lock is in use (see page 24).

USB Operations:

Unable to play back through the USB connection.

- ⇒ USB connection and setting is incorrect (see page 14).

Timer Operations:

Daily Timer does not work.

- ⇒ The System has been turned on when the on-time comes. Timer starts working only when the System is turned off.

Setup Menu Operations:

No subtitle appears on the display though you have selected the initial subtitle language.

- ⇒ Some DVDs are programmed to always display no subtitle initially. If this happens, press SUBTITLE after starting play (see page 20).

Audio language is different from the one you have selected as the initial audio language.

- ⇒ Some DVDs are programmed to always use the original language initially. If this happens, press AUDIO after starting play (see page 19).

Language Code List

AA	Afar
AB	Abkhazian
AF	Afrikaans
AM	Ameharic
AR	Arabic
AS	Assamese
AY	Aymara
AZ	Azerbaijani
BA	Bashkir
BE	Byelorussian
BG	Bulgarian
BH	Bihari
BI	Bislama
BN	Bengali, Bangla
BO	Tibetan
BR	Breton
CA	Catalan
CO	Corsican
CS	Czech
CY	Welsh
DA	Danish
DZ	Bhutani
EL	Greek
EO	Esperanto
ET	Estonian
EU	Basque
FA	Persian
FI	Finnish
FJ	Fiji
FO	Faroese
FY	Frisian
GA	Irish
GD	Scots Gaelic
GL	Galician
GN	Guarani
GU	Gujarati
HA	Hausa
HI	Hindi
HR	Croatian
HU	Hungarian
HY	Armenian
IA	Interlingua
IE	Interlingue
IK	Inupiak
IN	Indonesian
IS	Icelandic
IW	Hebrew
JI	Yiddish

JW	Javanese
KA	Georgian
KK	Kazakh
KL	Greenlandic
KM	Cambodian
KN	Kannada
KO	Korean (KOR)
KS	Kashmiri
KU	Kurdish
KY	Kirghiz
LA	Latin
LN	Lingala
LO	Laothian
LT	Lithuanian
LV	Latvian, Lettish
MG	Malagasy
MI	Maori
MK	Macedonian
ML	Malayalam
MN	Mongolian
MO	Moldavian
MR	Marathi
MS	Malay (MAY)
MT	Maltese
MY	Burmese
NA	Nauru
NE	Nepali
NL	Dutch
NO	Norwegian
OC	Occitan
OM	(Afan) Oromo
OR	Oriya
PA	Panjabi
PL	Polish
PS	Pashto, Pushto
PT	Portuguese
QU	Quechua
RM	Rhaeto-Romance
RN	Kirundi
RO	Rumanian
RU	Russian
RW	Kinyarwanda
SA	Sanskrit
SD	Sindhi
SG	Sangho
SH	Serbo-Croatian
SI	Singhalese
SK	Slovak

SL	Slovenian
SM	Samoaian
SN	Shona
SO	Somali
SQ	Albanian
SR	Serbian
SS	Siswati
ST	Sesotho
SU	Sundanese
SV	Swedish
SW	Swahili
TA	Tamil
TE	Telugu
TG	Tajik
TH	Thai
TI	Tigrinya
TK	Turkmen
TL	Tagalog
TN	Setswana
TO	Tonga
TR	Turkish
TS	Tsonga
TT	Tatar
TW	Twi
UK	Ukrainian
UR	Urdu
UZ	Uzbek
VI	Vietnamese
VO	Volapuk
WO	Wolof
XH	Xhosa
YO	Yoruba
ZU	Zulu

OPTICAL DIGITAL OUT Signals

DIGITAL AUDIO OUT Playback disc	Output Signals		
	STREAM/PCM	DOLBY DIGITAL/PCM	PCM ONLY
DVD Video			
with 48 kHz, 16/20/24 bit Linear PCM	48 kHz, 16 bit Linear PCM* ¹		
with 96 kHz, Linear PCM	48 kHz, 16 bit Linear PCM		
with Dolby Digital	Dolby Digital bitstream		48 kHz, 16 bit Linear PCM
with DTS	DTS bitstream	48 kHz, 16 bit Linear PCM	
DVD Audio			
with 48/96/192 kHz, 16/20/24 bit Linear PCM	no output* ²		
with 44.1/88.2/176.4 kHz, 16/20/24 bit Linear PCM	no output* ³		
with Dolby Digital	Dolby Digital bitstream		48 kHz, 16 bit Linear PCM
with DTS	DTS bitstream	48 kHz, 16 bit Linear PCM	
SVCD, VCD, CD	44.1 kHz, 16 bit Linear PCM/48 kHz, 16 bit Linear PCM		
CD with DTS	DTS bitstream	44.1 kHz, 16 bit Linear PCM	
MP3 disc	32/44.1/48 kHz, 16 bit Linear PCM		

*¹ While playing some DVDs, digital signals may be emitted at 20 bits or 24 bits (at their original bit rate) through the DIGITAL AUDIO OUT terminal if the discs are not copy-protected.

*² When the disc is not copyright protected, "48 kHz, 16 bit Linear PCM" signal is output.

*³ When the disc is not copyright protected, "44.1 kHz, 16 bit Linear PCM" signal is output.

Parts Index

Refer to the pages to see how to use the buttons and controls.

Remote control

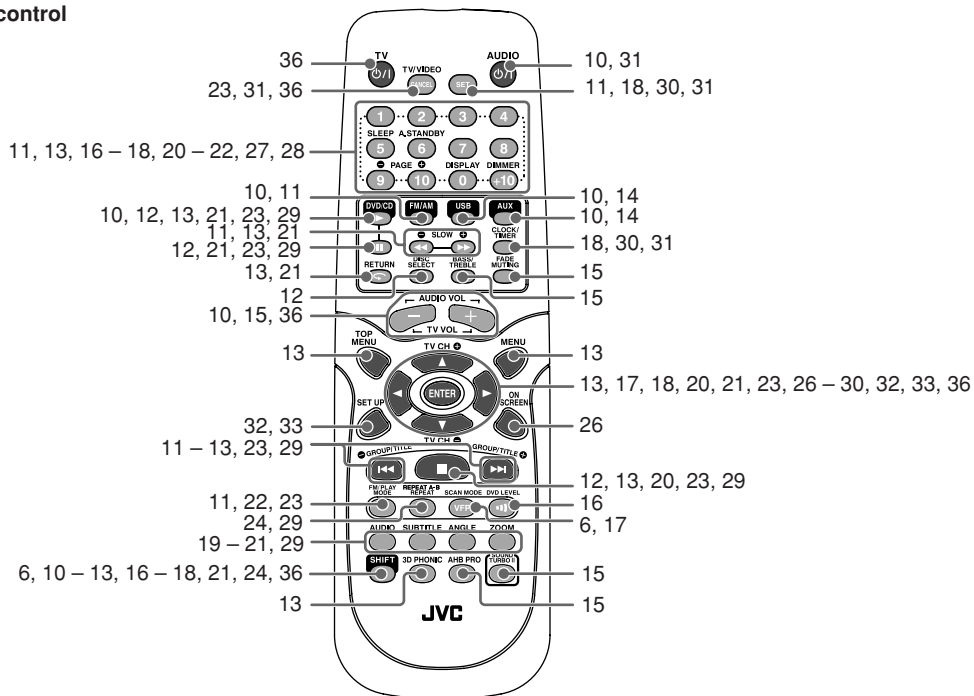

Main unit

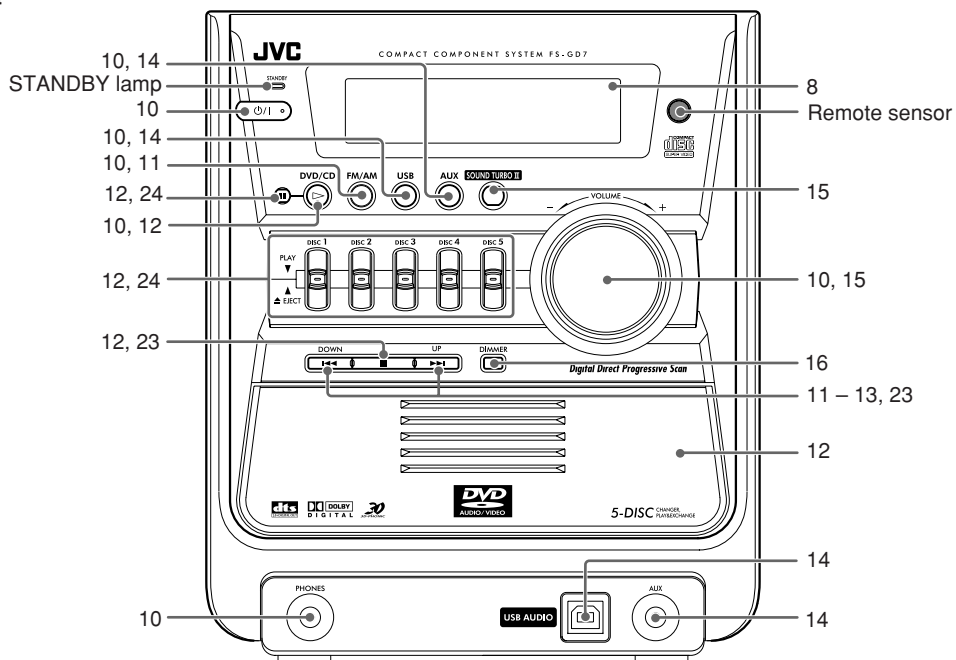

Specifications

Amplifier section

Output Power: 90 W per channel, min. RMS, driven into 6 Ω at 1 kHz with no more than 10% total harmonic distortion.

Analog input:

AUX: Sensitivity/Impedance (at 1 kHz)
400 mV/47 k Ω

USB input: USB Ver.1.1

Digital output:

OPTICAL DIGITAL OUT:
-21 dBm to -15 dBm (660 nm \pm 30 nm)

VIDEO OUT:

Color system: NTSC
VIDEO (composite): 1 V(p-p)/75 Ω
S-VIDEO: Y (luminance) 1 V(p-p)/75 Ω
C (chrominance, burst) 0.286 V(p-p)/75 Ω
COMPONENT:(Y) 1 V(p-p)/75 Ω
(P_B/P_R) 0.7 V(p-p)/75 Ω

Speaker terminals: Impedance 6 Ω – 16 Ω

Tuner section

FM tuning range: 87.5 MHz – 108.0 MHz
AM tuning range: 530 kHz – 1 710 kHz

Disc player section

Playable disc: DVD Video/DVD Audio
CD/VCD/SVCD
CD-R/CD-RW (recorded in Audio CD/
Video CD/Super Video CD/MP3/JPEG
format)
DVD-R/DVD-RW (recorded in video
format)

Horizontal resolution: 500 lines

Wow and flutter: Immeasurable

General

Power requirement: AC 120 V \sim , 60 Hz
Power consumption: 150 W (at operation)
26 W (on standby)
1.3 W (with deactivating the clock
indication)

Dimensions (approx.): 189 mm x 224 mm x 406 mm
(W/H/D)

Mass (approx.): 6.5 kg

Speakers

Type: 2-way Bass-reflex type
Magnetically shielded
Speaker systems: Woofer: 12 cm cone x 1
Tweeter: 4 cm cone x 1

Power handling capacity: 90 W

Impedance: 6 Ω

Frequency range: 45 Hz – 20 000 Hz

Sound pressure level: 84 dB/W•m

Dimensions (approx.): 165 mm x 286 mm x 237 mm
(W/H/D)

Mass (approx.): 2.8 kg each

Supplied Accessories

See page 3.

- This product incorporates copyright protection technology that is protected by U.S. patents and other intellectual property rights. Use of this copyright protection technology must be authorized by Macrovision, and is intended for home and other limited viewing uses only unless otherwise authorized by Macrovision. Reverse engineering or disassembly is prohibited.

“CONSUMERS SHOULD NOTE THAT NOT ALL HIGH DEFINITION TELEVISION SETS ARE FULLY COMPATIBLE WITH THIS PRODUCT AND MAY CAUSE ARTIFACTS TO BE DISPLAYED IN THE PICTURE. IN CASE OF 525 OR 625 PROGRESSIVE SCAN PICTURE PROBLEMS, IT IS RECOMMENDED THAT THE USER SWITCH THE CONNECTION TO THE ‘STANDARD DEFINITION’ OUTPUT. IF THERE ARE QUESTIONS REGARDING OUR TV SET COMPATIBILITY WITH THIS MODEL 525p AND 625p DVD PLAYER, PLEASE CONTACT OUR CUSTOMER SERVICE CENTER.”

Design and specifications are subject to change without notice.

JVC

Free Manuals Download Website

<http://myh66.com>

<http://usermanuals.us>

<http://www.somanuals.com>

<http://www.4manuals.cc>

<http://www.manual-lib.com>

<http://www.404manual.com>

<http://www.luxmanual.com>

<http://aubethermostatmanual.com>

Golf course search by state

<http://golfingnear.com>

Email search by domain

<http://emailbydomain.com>

Auto manuals search

<http://auto.somanuals.com>

TV manuals search

<http://tv.somanuals.com>