



COMPACT COMPONENT SYSTEM

MX-KC68
—Consists of CA-MXKC68, SP-MXKC68F and SP-MXKC68W
MX-KC38
—Consists of CA-MXKC38, SP-MXKC38



Thank you for purchasing a JVC product.

INSTRUCTIONS
GVT0243-0168 [A/U]/UW/US
0510WMMDWJMM
EN
©2008 Victor Company of Japan, Limited

Warnings, Cautions and Others

- IMPORTANT FOR LASER PRODUCTS**
- CLASS 1 LASER PRODUCT
 - CAUTION:** Do not open the top cover or cabinet. There are no user serviceable parts inside the unit; leave all servicing to qualified service personnel.
 - CAUTION:** Visible and/or invisible class 1M laser radiation when open. Do not view directly with optical instruments.
 - REPRODUCTION OF LABEL: CAUTION LABEL, PLACED INSIDE THE UNIT.

CAUTION VISIBLE AND/OR INVISIBLE CLASS 1 LASER RADIATION WHEN OPEN. DO NOT VIEW DIRECTLY WITH OPTICAL INSTRUMENTS.	ATTENTION VISIBLE ET/OU INVISIBLE CLASS 1 LASER RADIATION QUAND LA COUVERTE EST OUVERTE. NE PAS REGARDER DIRECTEMENT AVEC DES INSTRUMENTS OPTIQUES.	AVISO RADIACION LASER VISIBLE Y/O INVISIBLE CUANDO SE ABRE LA CUBIERTA. NO MIRE DIRECTAMENTE CON INSTRUMENTOS OPTICOS.	WARNING VISIBLE AND/OR INVISIBLE CLASS 1 LASER RADIATION WHEN OPEN. DO NOT VIEW DIRECTLY WITH OPTICAL INSTRUMENTS.	注意 VISIBLE AND/OR INVISIBLE CLASS 1 LASER RADIATION WHEN OPEN. DO NOT VIEW DIRECTLY WITH OPTICAL INSTRUMENTS.	CAUTION VISIBLE AND/OR INVISIBLE CLASS 1 LASER RADIATION WHEN OPEN. DO NOT VIEW DIRECTLY WITH OPTICAL INSTRUMENTS.
---	--	---	---	--	---

CAUTION
The ϕ /I button in any position does not disconnect the mains line.
Disconnect the mains plug to shut the power off completely (the STANDBY lamp goes off).
The MAINS plug or an appliance coupler is used as the disconnect device, the disconnect device shall remain readily operable.

- When the system is on standby, the STANDBY lamp lights red (except when the power is supplied using batteries).
- When the system is turned on, the STANDBY lamp goes off.

The power can be remote controlled. However, when the power is supplied using batteries, the system cannot be turned on by remote control.

CAUTION
To reduce the risk of electrical shocks, fire, etc.:

- Do not remove screws, covers or cabinet.
- Do not expose this appliance to rain or moisture.

CAUTION:

- Do not block the ventilation openings or holes. (If the ventilation openings or holes are blocked by a newspaper or cloth, etc., the heat may not be able to get out.)
- Do not place any naked flame sources, such as lighted candles, on the apparatus.
- When discarding batteries, environmental problems must be considered and local rules or laws governing the disposal of these batteries must be followed strictly.
- Do not expose this apparatus to rain, moisture, dripping or splashing and that no objects filled with liquids, such as vases, shall be placed on the apparatus.

CAUTION:
Excessive sound pressure from earphones or headphones can cause hearing loss.

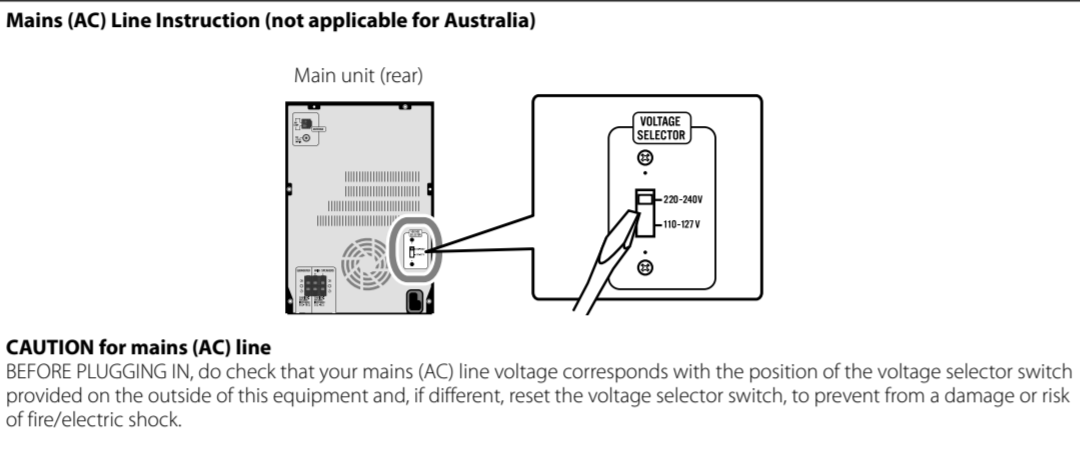
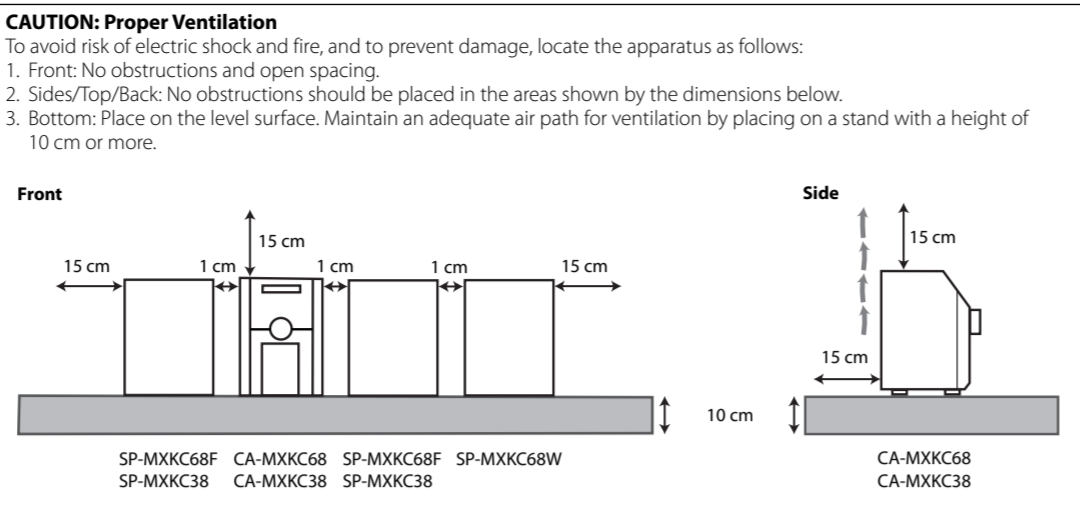

NOTE
The remote control illustrations of MX-KC68 are used in this instruction manual.

Basic and Common Operations

Basic Operations

To	On the System	On the remote	Press
Turn on or off (standby) the power			The STANDBY lamp on the System turns off/on.
Select a source			See "Playing Back a Disc" on page 4.
			See "Listening to iPod" on page 6.
			Press repeatedly to select "FM," "AM," or "AUDIO IN." • For "FM" and "AM," see "Listening to FM and AM Broadcasts" on page 5. • For "AUDIO IN," see "Listening to Digital Audio Player" on page 6.
Adjust the volume			You can adjust the volume level from level 0 ("VOLUME MIN") to level 31 ("VOLUME MAX").
Drop the volume in a moment	—		To restore the volume, press again, or adjust the volume level.

Display Settings

To	On the System	On the remote	Press
Set the Save mode		—	Press when the System is on standby. • Setting the Save mode allows you to reduce power consumption by turning the display off while on standby. To cancel this function, press again.
Changing the display brightness	—		Press repeatedly to select a brightness level. DIMMER 1 → DIMMER 2 DIMMER OFF
Changing the display information (Clock and source)	—		Press briefly. For setting the clock, see "Setting the Clock and Using Timers" on page 7.

NOTE
DO NOT turn off (standby) the System with the volume set to an extremely high level; otherwise, the sudden blast of sound can damage your hearing, speakers and/or headphones when you turn on the System or start playback.

How to cancel the demonstration
Press and hold CANCEL/ DEMO button while on standby. (Refer to the attached sheet "Information about the demonstration function".)

Using Headphones
Be sure to turn down the volume before connecting or putting on the headphones.
• Connecting the headphones will deactivate the speakers.
• Sound adjustments also affect the sound through the headphones.

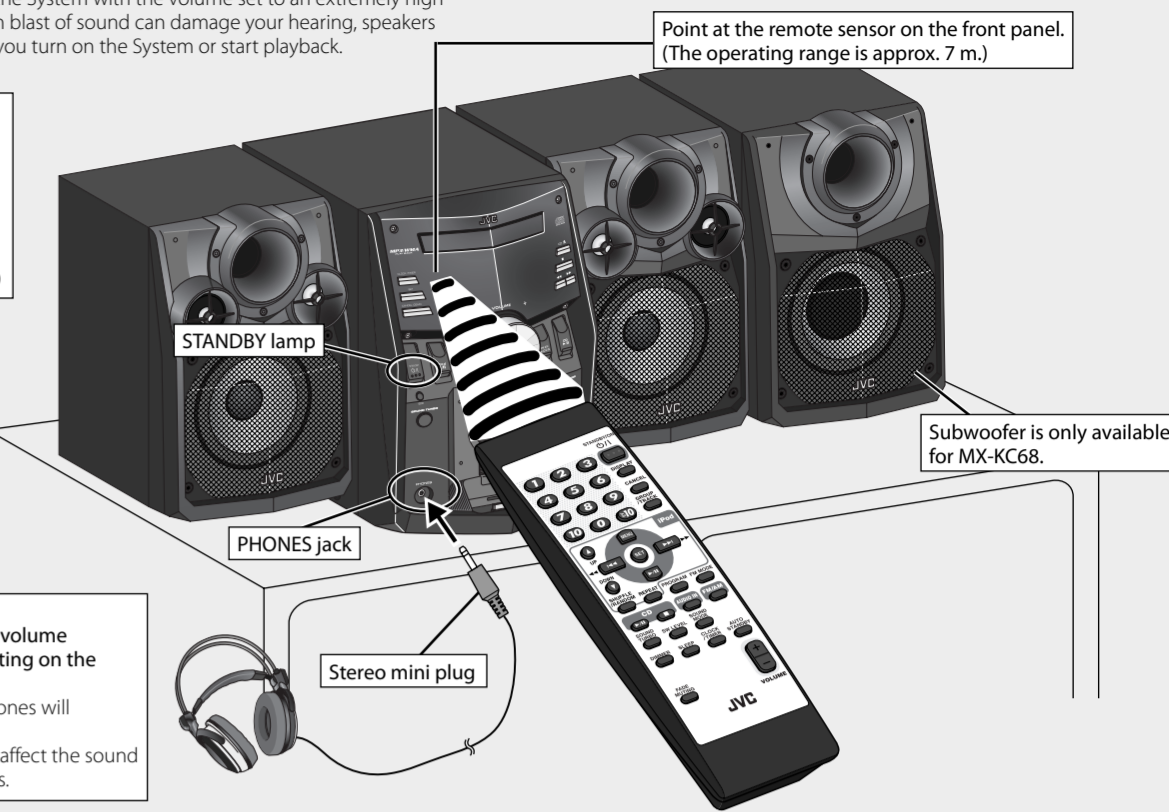

Sound Adjustment

To	On the System	On the remote	Press
Reinforce the heavy sound			• Sound Turbo indicator lights up. To cancel this function, press again.
Select a sound mode			Press repeatedly to select a sound mode you want. DANCE → HALL → STADIUM (Off) ← CLASSIC → POP → ROCK
Change the subwoofer level (only for MX-KC68)	—		Press repeatedly to select a subwoofer level. WOOFER 1 : SUBWOOFER1 WOOFER 2 : SUBWOOFER2 WOOFER 3 : SUBWOOFER3

Display Information

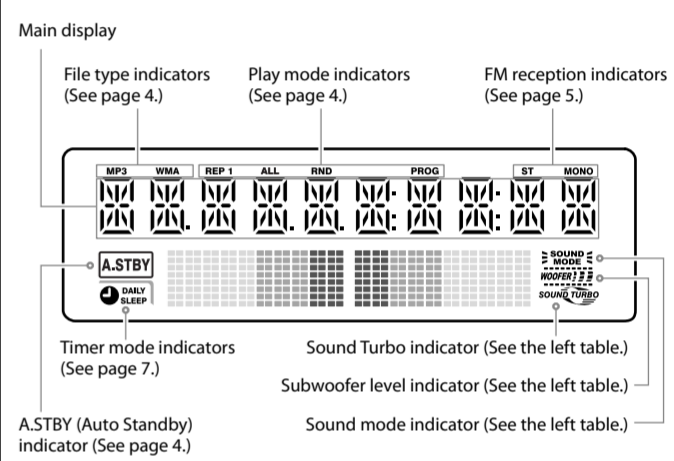

Precautions

- Notes on the power cord**
- When you are away on travel or otherwise for an extended period of time, remove the plug from the wall outlet. A small amount of power (1.00 W or less) is always consumed while the power cord is connected to the wall outlet.
 - When unplugging the System from the wall outlet, always pull the plug, not the power cord.
 - Do not handle the power cord with wet hands.
 - Disconnect the power cord before cleaning the System or moving the System.
 - Do not alter, twist or pull the power cord, or put anything heavy on it, which may cause fire, electric shock, or other accidents.
 - If the cord is damaged, consult a dealer and have the power cord replaced with a new one.
- Avoid moisture, water, dust, and high temperatures**
- Do not place the System in moist or dusty places.
 - If water gets inside the System, turn off the power and remove the plug from the wall outlet, then consult your dealer. Using the System in this state may cause a fire or electrical shock.
 - Do not expose the System to direct sunlight or place it near a heating device.
- Notes on installation**
- Select a place which is level, dry and neither too hot nor too cold between 5°C and 35°C.
 - Do not install the System in a place subject to vibrations.
 - Do not put heavy objects on the System.
- To prevent malfunction or damage of the System**
- Do not insert any metallic objects, such as wires, hairpins, coins, etc. into the System.
 - Do not block the vents.

There are no user-serviceable parts inside. If anything goes wrong, unplug the power cord and consult your dealer.

Getting Started

- Supplied Accessories**
- After unpacking, check to be sure that you have all the following items. The number in parentheses indicates the quantity of each piece supplied.
- Remote control (x 1)
 - Batteries (x 2)
 - AM loop antenna (x 1)
 - FM antenna (x 1)
 - AC plug adapter (x 1) (not supplied for Australia)
- If anything is missing, consult your dealer immediately.

Prepare the Remote Control
Insert the battery into the remote control by matching the polarity (+ and -) correctly.
• If the range or effectiveness of the remote control decreases, replace both batteries.

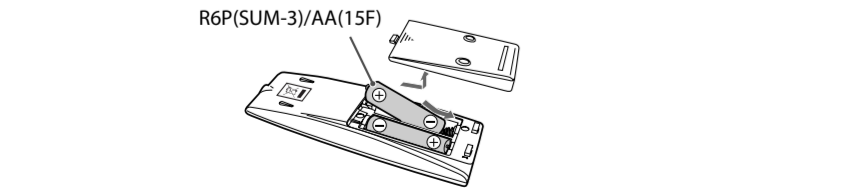

CAUTION:

- Danger of explosion if battery is incorrectly replaced. Replace only with the same or equivalent type.
- Battery shall not be exposed to excessive heat such as sunshine, fire or the like.

Connections

Do not connect the AC power cord until all other connections have been made.

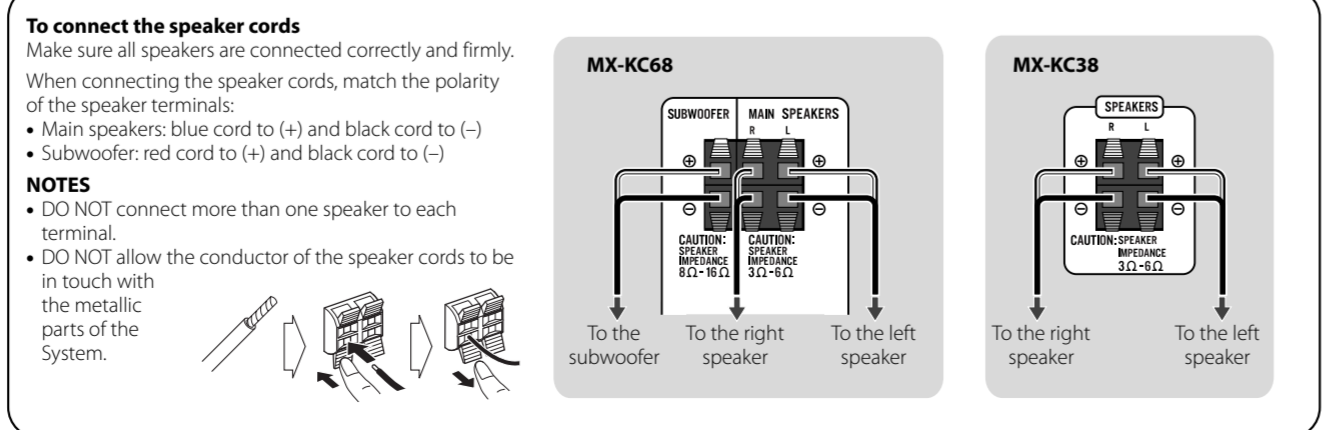
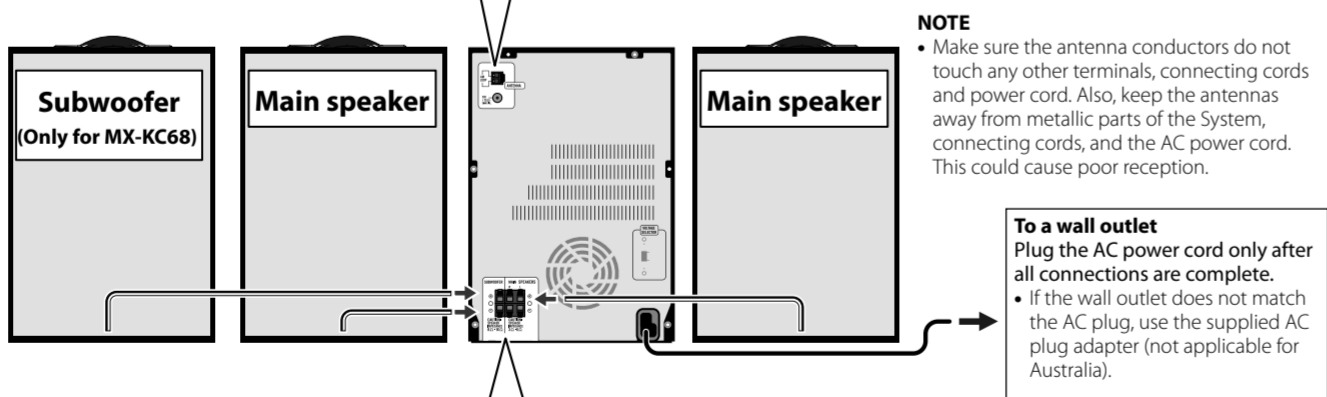
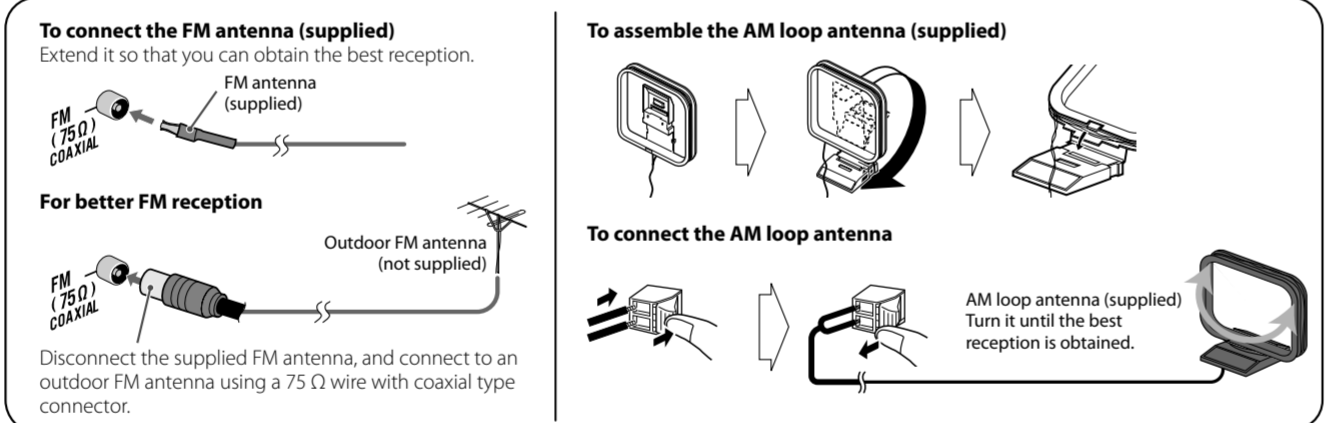

Playing Back a Disc

This System can play back...
- CD.
- CD-R/CD-RW recorded in audio CD format (CD-DA) or recorded MP3/WMA files in ISO 9660 format.
• When playing back an MP3 or WMA track, MP3 or WMA indicator lights on the display.

Loading a Disc

- On the System only
Press to open the disc tray.
- When using an 8 cm disc, place it on the inner circle of the disc tray.
- Press to close the disc tray.

Basic Disc Operations

To	On the System	On the remote	Press
Play back the disc			• Current track number and elapsed playing time appear on the main display. For MP3/WMA files: Before current track number and elapsed playing time appear, the tag information is scrolled if it is recorded. • During playback, press again to pause.
Stop playback			• While playback is stopped, total track number and total playing time (for MP3/WMA files, group number and track number) appear on the main display.
Select a track			Press to select the next tracks.
Select a track number	—		• To select number 5, press 5 . • To select number 25, press ±10, 2 , then 5 .
Forward search/Reverse search			Press and hold to fast-forward the track during playback. Press and hold to fast-reverse the track during playback.

NOTE
• If no disc is inserted, "NO DISC" appears on the main display.

To Select a Group (for MP3/WMA only)

- Press briefly.
- Select a group number.
- Select a track number.
• You can use also \lll or \ggg buttons.

RESUME Play (for MP3/WMA only)

When you stop the playback by one of the following operations, this System stores the beginning of the stopped track on the disc.
- Pressing \blacksquare once
- Changing the source
When you start playback again, playback starts from the stored position.
To clear the stored position, turn off the System.
• Opening the disc tray also clears the stored position.

NOTE
This function does not work in program play and random play.

Programming the Playing Order—Program Play

- Press before you start playback.
• The PROG (program) indicator lights on the display.
- For MP3/WMA files: select a group number, then a track number.
For CD: select a track number.
- Repeat step 2 to program other tracks you want.
• If you try to program a 51st track, "FULL" will appear on the main display.
- The tracks are played back in the programmed order.

To Operate on the Program Play Mode

To	Press
Check the programmed contents	\lll or \ggg Press while playback is stopped.
Add tracks	Repeat step 2 above while playback is stopped. Press while playback is stopped.
Erase the last track	CANCEL • The track number and the program number of the new last track appear on the main display.
Erase the entire program	CANCEL Press and hold for 2 seconds.
Exit from program play	PROGRAM Press while playback is stopped.

Playing at Random—Random Play

- Press before you start playback.
• The RND (random) indicator lights on the display.
- Playback starts in random order.
Random Play ends when all tracks are played back.

To Operate on the Random Play Mode

To	Press
Skip a track	\ggg \lll goes back to the beginning of the current track.
Exit from random play	SHUFFLE/RANDOM Press once while playback is stopped.

Playing Repeatedly—Repeat Play

- Press repeatedly to specify the repeat mode as follows:
REP 1 Repeats the current (or specified) track.
REP Repeats all tracks in the current group (MP3/WMA only).
REP ALL Repeats all tracks.
(Off) Normal playback
-

Turning off the System Automatically—AUTO STANDBY function

Press until the A.STBY indicator lights on the display.
• The A.STBY indicator starts flashing on the display after playback stops. If no operation is done for about 3 minutes, the System turns off.

- The AUTO STANDBY function also works in the following cases:
- "iPOD" is selected as the source and no iPod is connected to the System.
- "AUDIO IN" is selected as the source and no equipment is connected to the AUDIO IN terminal.
• The AUTO STANDBY function does not work when "FM" or "AM" is selected as the source.

To cancel this function, press again.

Prohibiting Disc Ejection

You can lock the disc tray so that no one can eject the loaded disc.
• This is possible while the System is on standby and the disc tray is closed.



To cancel the prohibition, repeat the same procedure.



Listening to FM and AM Broadcasts

Selecting the AM tuner intervals

Some countries and areas use 9 kHz intervals between AM stations, and others use 10 kHz. You can change the AM tuner intervals.

- Turn off the System (on standby).

or

STANDBY ON/OFF
- On the System only

Press and hold

Press STANDBY while holding ◀◀

• *AM9K STEP* appears on the main display.
- On the System only

Press and hold

Press STANDBY while holding ▶▶

• *AM10K STEP* appears on the main display.

Basic Tuner Operations

To	On the System	On the remote	Press
Select FM or AM			Press repeatedly to select "FM" or "AM." • The selected frequency appears on the main display.
Select a frequency	 or 	 or 	Press and hold for more than 2 seconds. The System starts searching for stations and stops when a station of sufficient signal strength is tuned in. • If an FM program is broadcast in stereo, the ST (stereo) indicator lights on the display (only when the reception is good). • Press during searching to stop. • Press repeatedly to change the frequency step by step.
Tune in to a preset station	—		Press to select a preset number for the station you store. • For presetting stations, see right column.
Change the FM reception mode (When an FM stereo broadcast is hard to receive or noisy)	—		Press to improve reception. The MONO indicator lights on the display. Reception will improve though the stereo effect is lost. To restore the stereo effect, press again.
Reduce AM beating noises (When you hear beating noises while listening to an AM station)	—		Press repeatedly to select BEAT CUT ON.

Presetting Stations

You can preset 30 FM and 15 AM stations manually.

- Tune in to a station you want to preset.
 - You can also store the monaural reception mode for FM preset stations if selected.
- Press to activate the preset number entry mode.
 - Finish the following steps while the indication on the display is flashing.
- Press to select a preset number for the station you store.
 - To select number 5, press **5**.
 - To select number 25, press **10**, **2**, then **5**.
- Press to store the station.

Setting the Clock and Using Timers

Setting the Clock

You cannot use Daily Timer until you set the clock.
• "0:00" flashes on the main display until you set the clock.

- Press to activate the clock setting mode.
 - If you have already adjusted the clock before, press the button repeatedly until the clock setting mode is selected.
- Adjust the hour, then the minute.
 - ◀◀ or ▶▶

- To exit from the clock setting, press CLOCK/TIMER as required.
- To go back to the previous step, press CANCEL.
- You can also use the buttons on the System as well.

Setting the Sleep Timer

Press repeatedly to specify the time (in minutes) as follows:

SLEEP

→10 →20 →30 →60 →90 →120 →150 →180

Cancelled

- While the Sleep Timer is working, the SLEEP indicator lights on the display.
- To check the remaining time to turn off after setting the sleep timer, press once.

Setting the Daily Timer

Using Daily Timer, you can wake up with your favorite music.

- Press repeatedly to select "ON".
 - DAILYTIMER ON (Time)
 - Cancelled Clock setting mode (See above.)
- Adjust the hour then the minute for on-time.
 - Adjust the hour then the minute for off-time.
 - Select the playback source—"DISC", "IPOD", "AUDIO IN", "TUNER FM", or "TUNER AM."
 - For FM, AM: Select a preset channel.
 - For "DISC": Select a track. (For MP3/WMA: select a group, then a track number.)
 - For "AUDIO IN": Make the connected device ready for playback.
 - Select the volume level.
 - You can select the volume level ("VOLUME 0" to "VOLUME 31" and "VOLUME --"). If you select "VOLUME --", the volume is set to the last level when the System is turned off.
- Turn off the System (on standby).
 - When the on-time of the daily timer comes, the System sets the volume level gradually to the preset level after about 10 seconds.

* When "IPOD" is selected as the playback source, charge the iPod battery through the iPod terminal (see page 6); otherwise, Daily Timer may not work.

- To exit from the timer setting, press CLOCK/TIMER as required.
- To correct a misentry during the process, press CANCEL. You can return to the previous step.
- You can also use the buttons on the System as well.

To Turn Off the Daily Timer

- Press repeatedly to select "DAILYTIMER".
- CANCEL

To turn on the Daily Timer again, select "DAILYTIMER" by pressing CLOCK/TIMER, then press SET.

Listening to iPod

Listening to iPod

- Compatible iPod types:**
- iPod nano
 - iPod nano (2nd generation)
 - iPod nano (3rd generation)
 - iPod nano (4th generation)
 - iPod nano (5th generation)
 - iPod mini
 - iPod (4th generation)
 - iPod (5th generation)
 - iPod photo
 - iPod classic
 - iPod touch
 - iPod touch (2nd generation)

Connecting the iPod:

Dock adapter (supplied with the iPod or sold separately)

To detach the dock adapter from the dock: Push the slot and pull up to remove the dock adapter.

Direct Dock for iPod Front view

- Set the volume to minimum.
- The iPod is turned on and the last track you had selected is played back.
 - If the track is not played back automatically, press again.
- Adjust the volume to the level you want to listen to.

NOTES

- When "IPOD" is selected as the source...
 - "CONNECT" appears on the main display while an iPod is connected.
 - "NO CONNECT" appears on the main display while no iPod is connected.
- The iPod battery is charged through the iPod terminal in the following cases:
 - When the System is turned on.
 - When the System is turned off and is not in the Save mode.

Disconnecting the iPod: When disconnecting the iPod, make sure this System is turned off.

If an iPod which is not on the compatible iPod types list above is connected, it may not be operated from the System. In this case, deactivate the iPod battery charge function so that the iPod may be operated, but it cannot be charged through the System.

To deactivate the battery charge function, change the source to "IPOD," then press and hold on the System while no iPod is connected.
• "CHARGE OFF" appears on the main display.

To use the battery charge function, change the source to "IPOD," then press and hold on the System until "CHARGE ON" appears on the main display.

Basic iPod Operations

To	On the System	On the remote	Press
Play back			During playback, press again to pause.
Select a track/ Forward search/ Reverse search	 or 	 or 	Press to select the next track. Press and hold to fast-forward the track during playback. Press to go back to the beginning of the current or previous track. Press and hold to fast-reverse the track during playback.
Turn off the iPod	—		Press and hold for more than 2 seconds. • Turning off the System* or changing to another source also turns off the iPod. * Turning off the System may not turn off the iPod depending on the current source.
Turn on the backlight of the iPod	—		Press and hold for more than 2 seconds.
Display the menu/Go back to the previous menu	—		—
Select an item on the menu	—		The UP/DOWN buttons work in the same way as operating the iPod's click wheel counterclockwise/clockwise. (Refer to the iPod's instruction manual for details.)
Play back at random	—		Refer to the iPod's instruction manual for details.
Play back repeatedly	—		Refer to the iPod's instruction manual for details.

Listening to Digital Audio Player

Listening to Digital Audio Player

Digital Audio Player

Front view

To audio output (or headphone out, etc.)

Stereo mini plug cord (not supplied)

- Set the volume to minimum.
- When operating on the main unit, press FM/AM/AUDIO IN repeatedly to select "AUDIO IN".
- Start playing the connected Digital Audio Player.
- Adjust the volume level to the level you want to listen to.

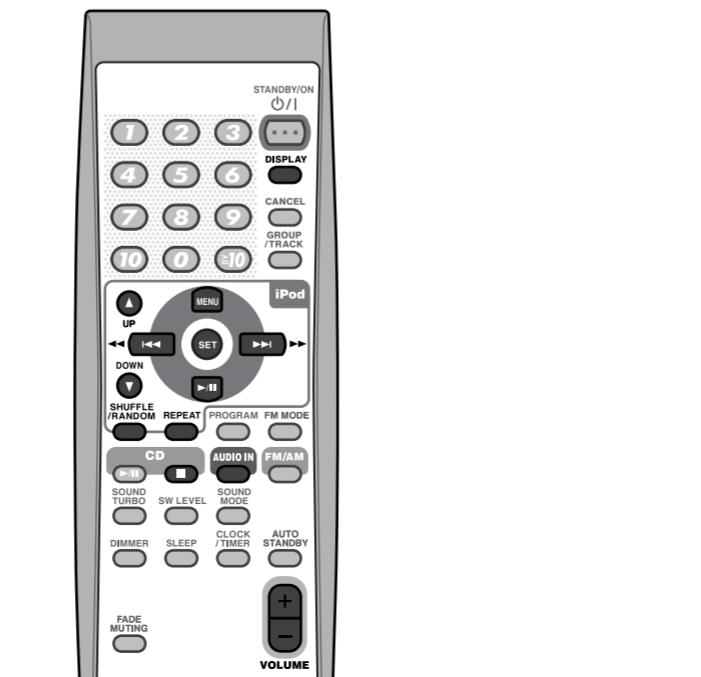

Troubleshooting

If you are having a problem with your System, check this list for a possible solution before calling for service.

General

Power does not come on.
→ Power plug is not inserted securely. Plug in securely.

Demonstration starts automatically.
→ The demonstration function is activated.
Press and hold the CANCEL/DEMO button on the main unit while on standby until "DEMO CLEAR" appears on the display. (Refer to the attached sheet "Information about the demonstration function")

Adjustments or settings are suddenly canceled before you finish.
→ There is a time limit. Repeat the procedure again.

Operations are disabled.
→ The built-in microprocessor may malfunction due to external electrical interference. Unplug the AC power cord and then plug it back in.

Unable to operate the System from the remote control.
→ The path between the remote control and the remote sensor on the System is blocked.
→ The batteries are exhausted.

No sound is heard.
→ Speaker connections are incorrect or loose.
→ Headphones are connected.

The System does not work properly.
→ Many functions of this System are implemented by microcomputers. If pressing any button does not result in the normal action, disconnect the AC power cord from the wall outlet, wait for a while, and connect the cord again.

Disc Operations

The disc does not play.
→ The disc is placed upside down. Place the disc with the label side up.
→ The disc is recorded with the "packet writing (UDF file system)." It cannot be played. Check the files you want to play back.

MP3/WMA groups and tracks are not played back as you expect.
→ The playing order is determined when the groups and tracks were recorded. It depends on the writing application.

The disc sound is discontinuous.

- The disc is scratched or dirty.
- The disc tray does not open or close.
- The AC power cord is not plugged in.
- Disc ejection is prohibited (see page 4).

Radio Operations

Hard to listen to broadcasts because of noise.
→ Antenna connections are incorrect or loose.
→ The AM loop antenna is too close to the System.
→ The FM antenna is not properly extended and positioned.
→ Electrostatic discharge from your body may cause noise. If this happens, turn off and on the System again.

iPod Operations

iPod is not turned on.
→ The iPod is not connected properly.
iPod does not play though "CONNECT" appears on the main display.
→ The battery of the iPod is empty. Leave the iPod connected for more than ten minutes.
iPod is not played back from the System.
→ The iPod battery charge function is deactivated.
→ The iPod is not compatible with the System. Check the compatibility on the list on page 6.

iPod is not charged.
→ The System is in the Save mode (see page 3)
→ The iPod battery charge function is deactivated (see page 6).

Timer Operations

Daily Timer does not work.
→ The System has been turned on when the on-time comes. Timer starts working only when the System is turned off.
→ When "IPOD" is selected as the playback source, charge the battery of the iPod through the iPod terminal; otherwise, Daily Timer may not work.

Learning More about This System

Basic and Common Operations (see page 3)

Pressing one of the source buttons also turns on the System and starts playing back.

Playing Back a Disc (see page 4)

- This System cannot play "packet write" discs.
- For MP3/WMA playback...
 - This System cannot play "packet write" discs.
 - In this manual, "file" and "track" are interchangeably used for MP3/WMA operations.
 - This System can show the Tag data (Version 1).
 - MP3/WMA discs are required a longer record time than regular CDs. (It depends on the complexity of the group/file configuration.)
 - Some MP3/WMA files cannot be played back and will be skipped. This result from their recording processes and conditions.
 - When making MP3/WMA discs, use ISO 9660 Level 1 or Level 2 for the disc format.
 - This System can play back MP3/WMA files with the extension code <.mp3> or <.wma> (regardless of the letter case—upper/lower).
 - It is recommended that you make each MP3/WMA file at a sampling rate of 44.1 kHz and at bit rate of 128 kbps. This System cannot play back files made at bit rate of less than 64 kbps.
 - Playback order of MP3/WMA tracks may be different from the one you have intended while recording. If a folder does not include MP3/WMA tracks, they are ignored.
- This System can recognize up to 99 groups in a disc. The total number of groups and tracks in a disc that can be recognized by the System is 512 (for MP3/WMA).
- Playable files which do not belong to any groups are handled as Group 1.

Listening to iPod (see page 6)

- If the iPod does not play correctly, update your iPod Software to the latest version. For details about updating your iPod, check on the Apple web site <<http://www.apple.com>>.
- The iPod battery cannot be charged while the System is in the Save mode.
- When the iPod is not charged through the System, the iPod may not be turned on from the System.
- You cannot send any data to your iPod from the System.
- Sound distortion may occur when playing back audio sources with high recording levels. When distortion occurs, it is recommended to turn off the equalizer of the iPod. For information on operating the iPod, see the iPod instruction manual.
- Do not touch or hit the iPod terminal pins or connector pins directly. It might cause damages to the connector part.

Setting the Clock and Using Timers (see page 7)

- You can set the clock and Daily Timer even while the Save mode is turned on. While setting the clock or Daily Timer, the display is turning on.
- The clock may gain or lose 1 to 2 minutes per month. If this happens, readjust the clock.
- When you unplug the AC power cord or if a power failure occurs, the clock and the timer will be canceled. You need to set the clock first, then the timer again.

Timer Priority:

- If you set the Sleep Timer after Daily Timer starts playing the selected source, Daily Timer is canceled.

JVC bears no responsibility for any loss of data in iPod while using this System.

Microsoft and Windows Media are either registered trademarks or trademarks of Microsoft Corporation in the United States and/or other countries.

Listening to iPod

Listening to iPod

- Compatible iPod types:**
- iPod nano
 - iPod nano (2nd generation)
 - iPod nano (3rd generation)
 - iPod nano (4th generation)
 - iPod nano (5th generation)
 - iPod mini
 - iPod (4th generation)
 - iPod (5th generation)
 - iPod photo
 - iPod classic
 - iPod touch
 - iPod touch (2nd generation)

Connecting the iPod:

Dock adapter (supplied with the iPod or sold separately)

To detach the dock adapter from the dock: Push the slot and pull up to remove the dock adapter.

Direct Dock for iPod Front view

- Set the volume to minimum.
- The iPod is turned on and the last track you had selected is played back.
 - If the track is not played back automatically, press again.
- Adjust the volume to the level you want to listen to.

NOTES

- When "IPOD" is selected as the source...
 - "CONNECT" appears on the main display while an iPod is connected.
 - "NO CONNECT" appears on the main display while no iPod is connected.
- The iPod battery is charged through the iPod terminal in the following cases:
 - When the System is turned on.
 - When the System is turned off and is not in the Save mode.

Disconnecting the iPod: When disconnecting the iPod, make sure this System is turned off.

If an iPod which is not on the compatible iPod types list above is connected, it may not be operated from the System. In this case, deactivate the iPod battery charge function so that the iPod may be operated, but it cannot be charged through the System.

To deactivate the battery charge function, change the source to "IPOD," then press and hold on the System while no iPod is connected.
• "CHARGE OFF" appears on the main display.

To use the battery charge function, change the source to "IPOD," then press and hold on the System until "CHARGE ON" appears on the main display.

Free Manuals Download Website

<http://myh66.com>

<http://usermanuals.us>

<http://www.somanuals.com>

<http://www.4manuals.cc>

<http://www.manual-lib.com>

<http://www.404manual.com>

<http://www.luxmanual.com>

<http://aubethermostatmanual.com>

Golf course search by state

<http://golfingnear.com>

Email search by domain

<http://emailbydomain.com>

Auto manuals search

<http://auto.somanuals.com>

TV manuals search

<http://tv.somanuals.com>