

COMPACT COMPONENT SYSTEM

组合音响系统

MX-SK3 — Consists of **CA-MXSK3** and **SP-MXSK3**

由**CA-MXSK3**及**SP-MXSK3**组成

MX-SK1 — Consists of **CA-MXSK1** and **SP-MXSK1**

由**CA-MXSK1**及**SP-MXSK1**组成

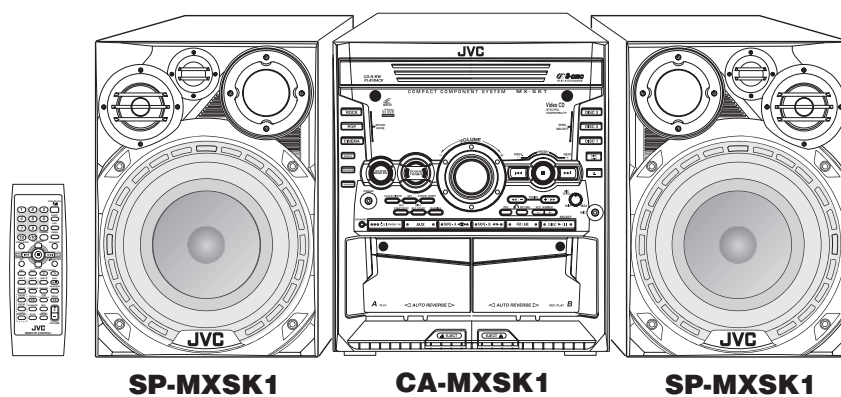
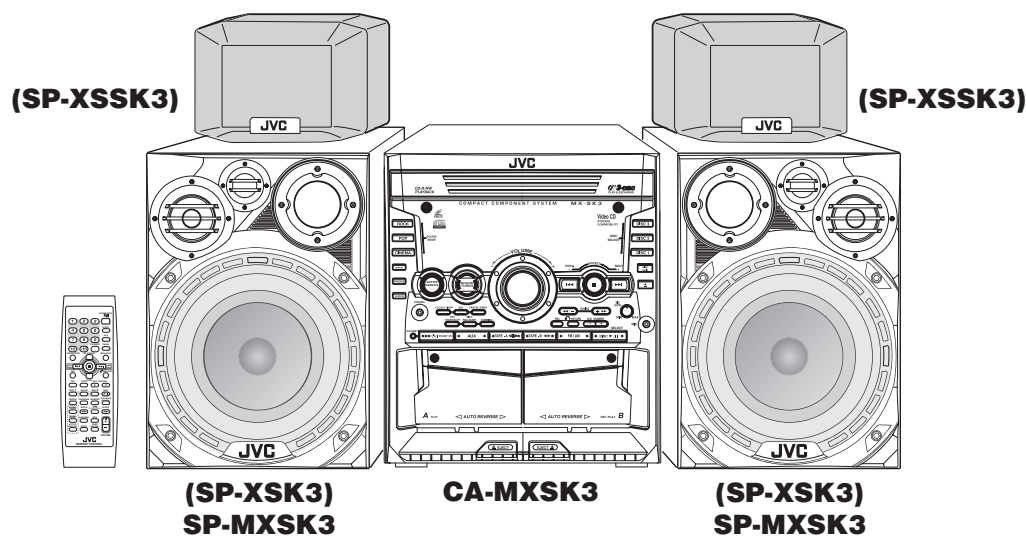

INSTRUCTIONS

使用说明书

Warnings, Cautions and Others

警告，注意及其他须知事项

CAUTION — button!

Disconnect the mains plug to shut the power off completely (the STANDBY/ON lamp goes off). The  button in any position does not disconnect the mains line.

- When the unit is on standby, the STANDBY/ON lamp lights red.

The power can be remote controlled.

注意 — 开关！

无论  开关在任何位置，电源线的电源还是没有被切断，若要将电源完全关闭，应把电源插头拔离插座（STANDBY/ON 灯熄灭）。

- 当主机正处于备用状态，STANDBY/ON 灯为红色。

电源开关可用遥控器控制。

CAUTION

To reduce the risk of electrical shocks, fire, etc.:

1. Do not remove screws, covers or cabinet.
2. Do not expose this appliance to rain or moisture.

注意

为了防止触电，火灾等危险：

1. 请勿擅自卸下螺丝钉，盖子或机壳。
2. 切勿让本机受雨淋或置于潮湿环境中。

CAUTION

- Do not block the ventilation openings or holes. (If the ventilation openings or holes are blocked by a newspaper or cloth, etc., the heat may not be able to get out.)
- Do not place any naked flame sources, such as lighted candles, on the apparatus.
- When discarding batteries, environmental problems must be considered and local rules or laws governing the disposal of these batteries must be followed strictly.
- Do not expose this apparatus to rain, moisture, dripping or splashing and that no objects filled with liquids, such as vases, shall be placed on the apparatus.

注意

- 请勿堵塞通风口或通风孔。
(如果通风口或通风孔被报纸或布等堵塞，热量将无法散出。)
- 请勿在本设备上放置任何裸露的火源，如点燃的蜡烛。
- 处理废弃电池时，必须考虑环境问题，并严格遵守当地关于处理废弃电池的有关法律或规定。
- 切勿将本装置暴露于雨水所及、潮湿、滴水或易于溅起水花的地方，亦不要将任何装满液体的物件（如花瓶）放置在本装置上。



MX-SK1: 18.7 kg

MX-SK3: 20.0 kg

CAUTION!

To avoid personal injury or accidentally dropping the unit, have two persons unpack, carry, and install the unit.

小心!

為避免個人受傷或本機意外掉落，請確保由兩個人卸貨、搬運和安裝本機。

Caution: Proper Ventilation

To avoid risk of electric shock and fire, and to prevent damage, locate the apparatus as follows:

- 1 Front: No obstructions and open spacing.
- 2 Sides/ Top/ Back: No obstructions should be placed in the areas shown by the dimensions below.
- 3 Bottom: Place on the level surface. Maintain an adequate air path for ventilation by placing on a stand with a height of 10 cm or more.

注意：正确通风

为避免发生触电和火警的危险，及防止本机受损，请将本机如下放置：

1. 前面：没有障碍物及地方开阔。
2. 侧面 / 顶面 / 背面：在图中所示范围中，不应放置任何障碍物。
3. 底部：放置在水平面上。放置在一个高 10 厘米或以上的台上，以保持足够的通风道。

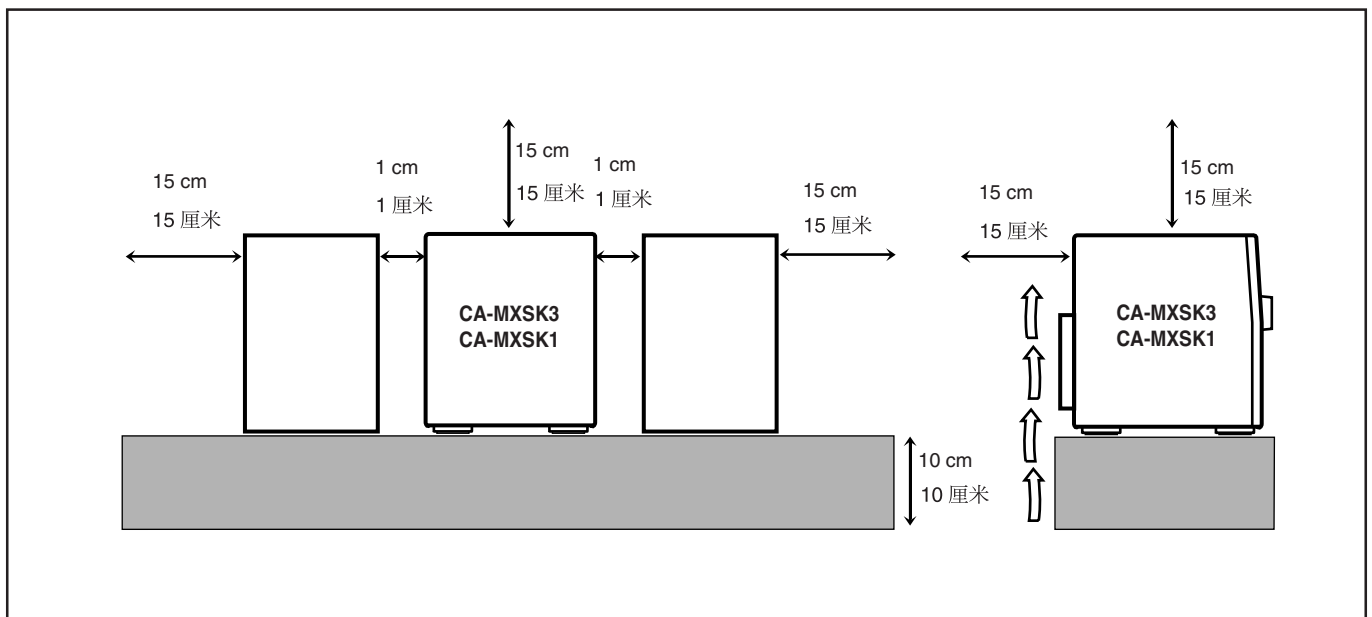

-
1. CLASS 1 LASER PRODUCT
 2. **CAUTION:** Do not open the top cover. There are no user serviceable parts inside the Unit; leave all servicing to qualified service personnel.
 3. **CAUTION:** Visible and invisible laser radiation when open and interlock failed or defeated. Avoid direct exposure to beam.
 4. REPRODUCTION OF LABEL: CAUTION LABEL, PLACED INSIDE THE UNIT.

关于镭射产品之重要说明

1. 本产品属于1级镭射产品。
2. **注意:** 切勿打开机体的顶盖。里面没有用户可能自行修理的部件。一切维修工作请委托有资格的服务人员进行。
3. **注意:** 当拆开主机，或者内部的联锁装置失灵或损坏时，会有不可见镭射光线射出。请勿要受到镭射光线的直接辐射。
4. 标签的复制标示：注意标签放在主机内部。

| | |
|--|--|
| CAUTION: Visible and invisible laser radiation when open and interlock failed or defeated. AVOID DIRECT EXPOSURE TO BEAM. (e) | WARNING : Synlig och osynlig laserstrålning när den öppnas och spärren är urkopplad. Betrakta ej strålen. (s) |
| ADVARSEL : Synlig og usynlig laserstrålning når maskinen er åben eller interlocken fejler. Undgå direkte eksponering til strålning. (d) | VARO : Avattaessa ja suojauslaitus ohitettuna tai viallisena olet alltiina näkyvälle ja näkymättömälle lasersäteilylle. Vältä säteen kohdistumista suoraan itseesi. (f) |

Introduction

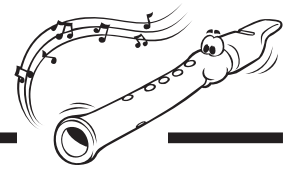

We would like to thank you for purchasing one of our JVC products. Before operating this unit, read this manual carefully and thoroughly to obtain the best possible performance from your unit, and retain this manual for future reference.

About This Manual

This manual is organized as follows:

- The manual mainly explains operations using the buttons and controls on the unit. You can also use the buttons on the remote control if they have the same or similar names (or marks) as those on the unit. If operation using the remote control is different from that using the unit, it is then explained.
- Basic and common information that is the same for many functions is grouped in one place, and is not repeated in each procedure. For instance, we do not repeat the information about turning on/off the unit, setting the volume, changing the sound effects, and others, which are explained in the section “Common Operations” on pages 9 to 11.
- The following marks are used in this manual:



Gives you warnings and cautions to prevent from damage or risk of fire/electric shock. Also gives you information which is not good for obtaining the best possible performance from the unit.



Gives you information and hints you had better know.

Precautions

Installation

- Install in a place which is level, dry and neither too hot nor too cold — between 5°C (41°F) and 35°C (95°F).
- Install the unit in a location with adequate ventilation to prevent internal heat buildup in the unit.
- Leave sufficient distance between the unit and the TV.
- Keep the speakers away from the TV to avoid interference with TV.



DO NOT install the unit in a location near heat sources, or in a place subject to direct sunlight, excessive dust or vibration.

Power sources

- When unplugging from the wall outlet, always pull the plug, not the AC power cord.



DO NOT handle the AC power cord with wet hands.

Moisture condensation

Moisture may condense on the lens inside the unit in the following cases:

- After starting heating in the room
 - In a damp room
 - If the unit is brought directly from a cold to a warm place
- Should this occur, the unit may malfunction. In this case, leave the unit turned on for a few hours until the moisture evaporates, unplug the AC power cord, and then plug it in again.

Others

- Should any metallic object or liquid fall into the unit, unplug the unit and consult your dealer before operating any further.
- If you are not going to operate the unit for an extended period of time, unplug the AC power cord from the wall outlet.



DO NOT disassemble the unit since there are no user serviceable parts inside.

If anything goes wrong, unplug the AC power cord and consult your dealer.

Which compact discs can be used?

Many types of compact discs are sold for a variety of uses. The player can play the following compact discs:

Video CD discs both with and without PBC

Audio CD discs



Discs you cannot playback

Any other discs than listed above (such as CD-ROM, DVD, CD-G or CD-I Discs) cannot be played. Playing back such discs may generate noise and damage your speakers. Even though a logo listed above is printed on the disc, it may not be played if it is a non-standard disc.

Contents

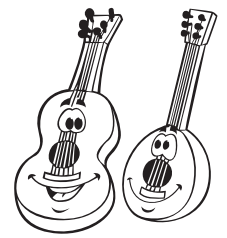

| | | | |
|---|-----------|---|-----------|
| Location of the Buttons and Controls | 3 | MP3 Disc Playback | 21 |
| Remote Control | 3 | Basic operations | 21 |
| Front Panel | 4 | Programming tracks | 21 |
| Getting Started | 6 | Playing Back Tapes | 23 |
| Supplied Accessories | 6 | Playing Back a Tape | 23 |
| Putting the Batteries into the Remote Control | 6 | Recording | 24 |
| Connecting Antennas | 6 | Recording a Tape on Deck B | 24 |
| Connecting Speakers | 7 | Dubbing Tapes | 25 |
| Surround Speakers | 8 | CD Direct Recording | 25 |
| Connecting Other Equipment | 8 | Using the Microphones | 26 |
| Adjusting the Voltage Selector | 8 | Singing along — Karaoke | 26 |
| Cancelling the Display Demonstration | 8 | Singing Along with Multiplex Karaoke Discs (MPX) | 26 |
| Common Operations | 9 | Recording Your Singing | 27 |
| Turning On or Off the Power | 9 | Adjusting the Music Key Control (for CD play only) | 27 |
| Setting the Clock | 9 | Using the Timers | 28 |
| Setting the AM Tuner Interval Spacing | 9 | Using Daily Timer and Recording timer | 28 |
| Selecting the Sources | 10 | Using Sleep Timer | 30 |
| Adjusting the Volume | 10 | Maintenance | 31 |
| Reinforcing the Bass Sound (ACTIVE BASS EX.) | 10 | Troubleshooting | 32 |
| Emphasizing the sound (SOUND TURBO) | 10 | Specifications | 33 |
| Selecting the Sound Modes | 11 | | |
| Listening to FM and AM Broadcasts | 12 | | |
| Tuning in a Station | 12 | | |
| Presetting Stations | 12 | | |
| Tuning in a Preset Station | 12 | | |
| Playing Back CDs (CD/CD-R/CD-RW) | 13 | | |
| Loading CDs | 13 | | |
| Playing Back the Entire Discs — Continuous Play | 14 | | |
| Basic CD Operations | 14 | | |
| Programming the Playing Order of the Tracks — Program Play | 15 | | |
| Playing at Random — Random Play | 16 | | |
| Repeating Tracks or CDs — Repeat Play | 16 | | |
| Prohibiting Disc Ejection — Tray Lock | 16 | | |
| Playing Back Video CDs | 17 | | |
| Selecting Video Output (PAL, PAL AUTO, NTSC) ... | 17 | | |
| Loading Discs | 17 | | |
| Playing a Video CD | 17 | | |
| Playing Video CDs with PBC Function — Menu Play | 18 | | |
| Basic Concept of the PBC function | 18 | | |
| Playing Video CDs without PBC — Continuous Play | 19 | | |
| Resuming Play | 19 | | |
| Special Plays for a Video CD | 19 | | |
| Playing a Multiplex Sound CD | 20 | | |

Location of the Buttons and Controls



Remote Control

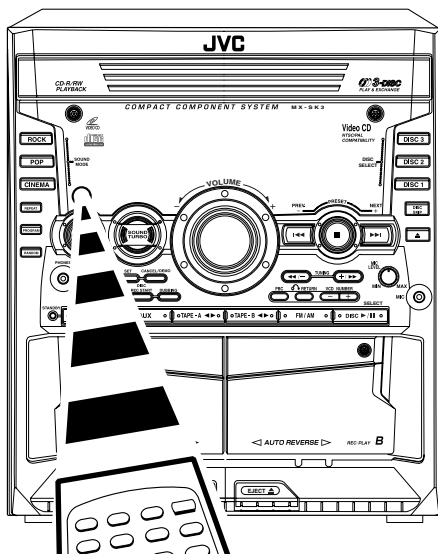
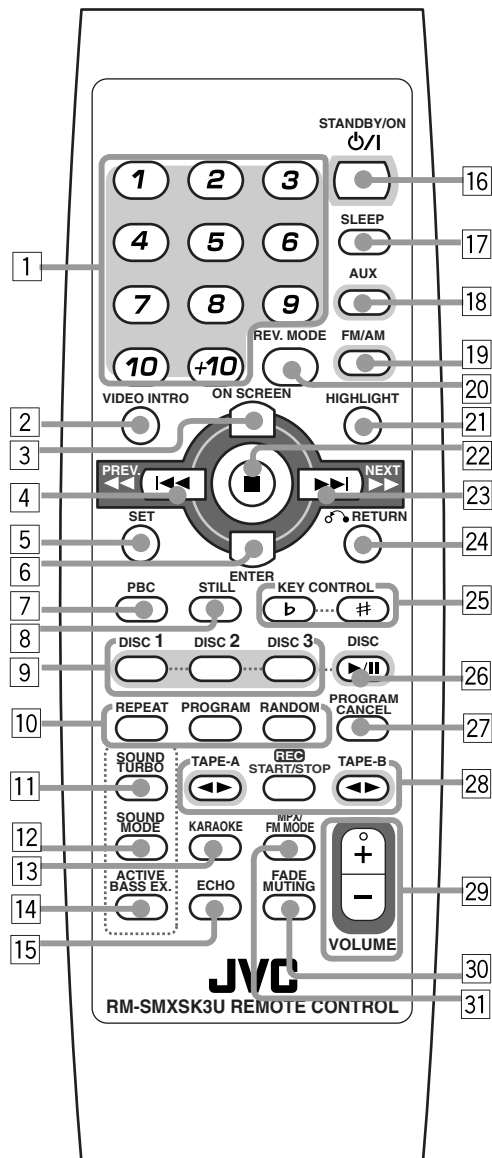

When using the remote control, point it at the remote sensor on the front panel.

Remote Control

See pages in the parentheses for details.

- 1 Number buttons (12, 14 – 15, 18 – 21)
- 2 VIDEO INTRO button (19)
- 3 ON SCREEN button (19)
- 4 PREV. ◀◀ (◀◀) button (12, 14 – 15, 18 – 19, 21 – 23)
- 5 SET button (15)
- 6 ENTER button (21)
- 7 PBC button (18 – 19)
- 8 STILL button (19)
- 9 Disc number buttons (DISC 1, DISC 2, and DISC 3) (14 – 15, 17, 19, 21)
Pressing one of these buttons also turns on the unit.
- 10 CD play mode buttons
 - REPEAT button (16)
 - PROGRAM button (15, 21)
 - RANDOM button (16, 21)
- 11 SOUND TURBO button (10)
- 12 SOUND MODE button (11)
- 13 KARAOKE button (26)
- 14 ACTIVE BASS EX. button (10)
- 15 ECHO button (26)
- 16 STANDBY/ON ⏻/⏻ button (9, 29)
- 17 SLEEP button (30)
- 18 AUX button (10)
Pressing this button also turns on the unit.
- 19 FM/AM button (10, 12)
Pressing this button also turns on the unit.
- 20 REV. MODE button (23, 25)
- 21 HIGHLIGHT button (20)
- 22 ■ (stop) button (14 – 25, 27)
- 23 NEXT ▶▶ (▶▶) button (12, 14 – 16, 18 – 23)
- 24 ⏪ RETURN button (18)
- 25 KEY CONTROL **b** / # buttons (27)
- 26 DISC ▶/|| button (10, 14 – 19, 21)
Pressing this button also turns on the unit.
- 27 PROGRAM CANCEL button (15)
- 28 Tape operation buttons
 - TAPE-A ◀▶ button (10, 23 – 24)
Pressing this button also turns on the unit.
 - REC START/STOP button (24)
 - TAPE-B ◀▶ button (10, 23 – 24)
Pressing this button also turns on the unit.
- 29 VOLUME + and – buttons (10, 26 – 27)
- 30 FADE MUTING buttons (10)
- 31 MPX/FM MODE buttons (12, 20, 26)

Become familiar with the buttons and controls on your unit.

Front Panel

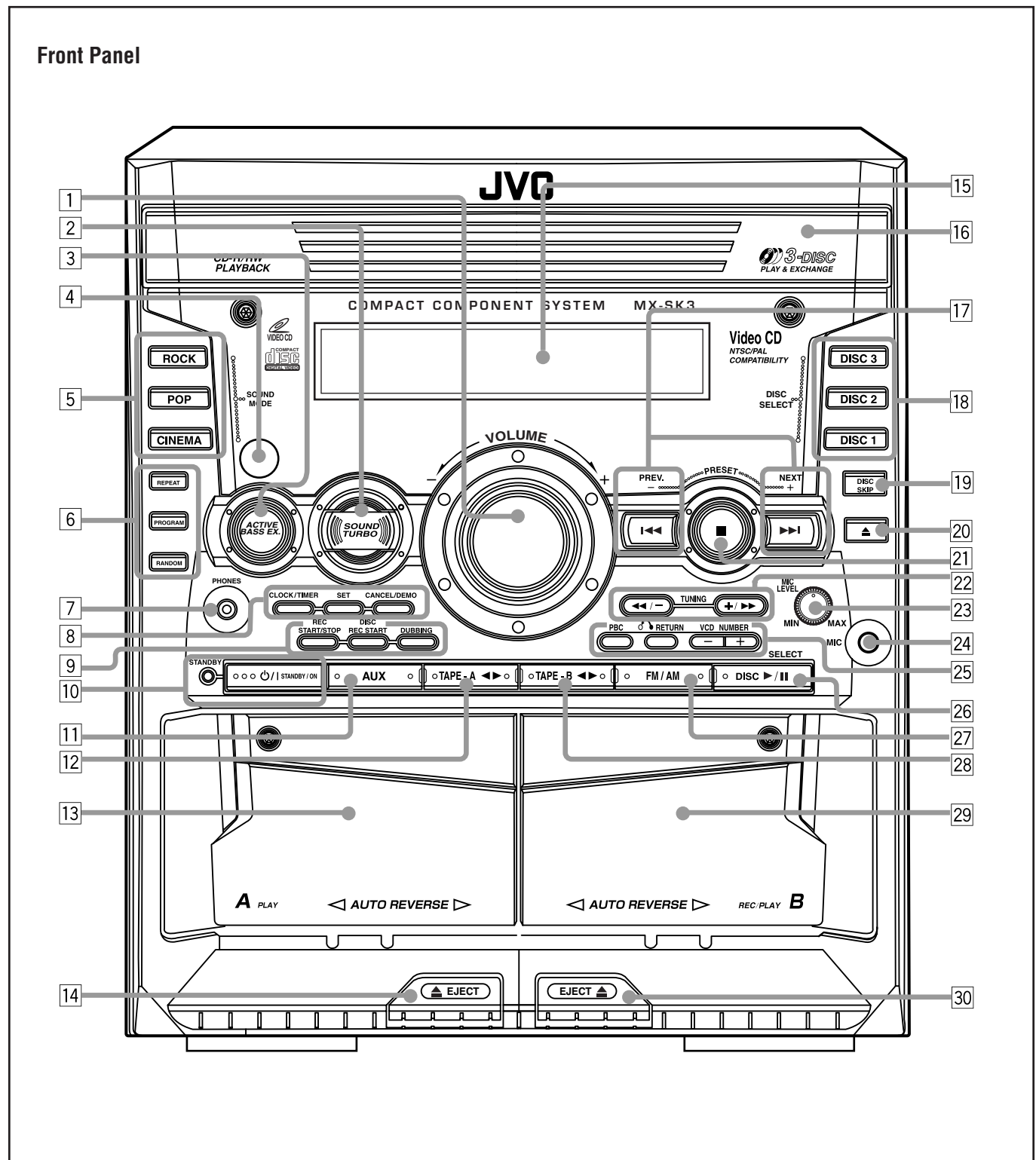

Notes:
 All illustrations in this manual will be based on CA-MXSK3

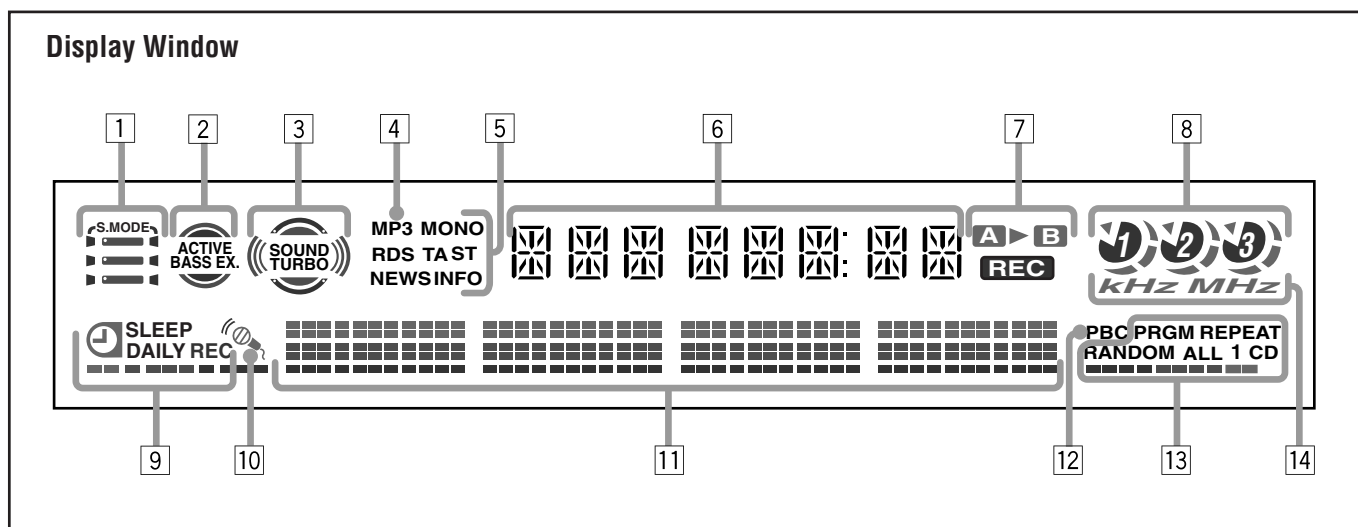

See pages in the parentheses for details.

Front Panel

- 1 VOLUME + / - control (10, 26 – 27)
- 2 SOUND TURBO button (10)
- 3 ACTIVE BASS EX. button (10)
- 4 Remote sensor
- 5 Sound mode buttons (11)
 - ROCK button
 - POP button
 - CINEMA button
- 6 CD play mode buttons
 - REPEAT button (16)
 - PROGRAM button (15, 21)
 - RANDOM button (16, 21)
- 7 PHONES jack (10)
- 8 CLOCK/TIMER button (9, 28 – 29)
SET button (9, 12, 15, 21)
CANCEL/DEMO button (8, 15, 22)
- 9 Recording buttons
 - REC START/STOP button (24)
 - DISC REC START button (25)
 - DUBBING button (25)
- 10 \mathcal{P} /I STANDBY/ON button and STANDBY lamp (9, 16, 29)
- 11 AUX button (10)
Pressing this button also turns on the unit.
- 12 TAPE-A $\blacktriangleleft \blacktriangleright$ button (10, 23 – 24)
Pressing this button also turns on the unit.
- 13 Deck A cassette holder (23)
- 14 \blacktriangle EJECT button for deck A (23)
- 15 Display window
- 16 Disc tray
- 17 PRESET PREV. - and NEXT + buttons
 \blacktriangleleft and \blacktriangleright (reverse search/forward search) buttons (9, 12, 14 – 15, 18, 21 – 22, 28 – 29)
- 18 Disc number buttons (DISC 1, DISC 2, and DISC 3) (14 – 15, 17, 19 – 20, 25)
Pressing one of these buttons also turns on the unit.
- 19 DISC SKIP button (13, 17)
- 20 \blacktriangle (Disc tray open/close) button (13 – 14, 16 – 17)
Pressing one of these buttons also turns on the unit.

- 21 \blacksquare (stop) button (14 – 25, 27)
- 22 TUNING + and - buttons (12)
 \blacktriangleleft and \blacktriangleright (fast left/fast right) buttons (14, 23)
- 23 MIC LEVEL control (26 – 27)
- 24 MIC jack (26)
- 25 Video CD buttons
 - PBC button (18 – 19)
 - RETURN button (18)
 - VCD NUMBER + / - buttons (18)
- 26 DISC \blacktriangleright /|| SELECT (play/pause) button (10, 14 – 19, 21)
Pressing this button also turns on the unit.
- 27 FM/AM button (12)
Pressing this button also turns on the unit.
- 28 TAPE-B $\blacktriangleleft \blacktriangleright$ button (10, 23 – 24)
Pressing this button also turns on the unit.
- 29 Deck B cassette holder (23 – 24)
- 30 EJECT \blacktriangle button for deck B (23 – 24)

Display Window

- 1 S. MODE (SOUND MODE) indicator
- 2 ACTIVE BASS EX. indicator
- 3 SOUND TURBO indicator
- 4 MP3 indicator
- 5 Tuner operation indicators
 - MONO and ST (stereo) indicators
- 6 Main display
 - Shows the source name, frequency, etc.
- 7 Tape operation indicators
 - A/B (operating deck) and **REC** (recording)
- 8 Disc indicators
- 9 Timer indicators
 - \mathcal{P} (Timer), DAILY (Daily Timer), REC (Recording Timer), and SLEEP (Sleep Timer) indicators
- 10 Karaoke (\mathcal{K}) and echo (\mathcal{E}) indicators
- 11 Audio level indicator
- 12 PBC indicator
- 13 CD play mode indicators
 - REPEAT (ALL/1/CD), PRGM (program), and RANDOM indicators
- 14 Radio frequency indicators
 - kHz and MHz indicators

Getting Started



Supplied Accessories

Make sure that you have all the following items. The number in the parentheses indicates the quantity of the pieces supplied.

- AM loop antenna (1)
- FM antenna (1)
- Remote control (1)
- Batteries (2)
- AC plug adaptor (1)
- Video cord (1)

If anything is missing, consult your dealer immediately.

Putting the Batteries into the Remote Control

Insert the batteries — R6(SUM-3)/AA(15F) — into the remote control, by matching the polarity (+ and -) on the batteries with the + and - markings on the battery compartment.

When the remote control can no longer operate the unit, replace both batteries at the same time.

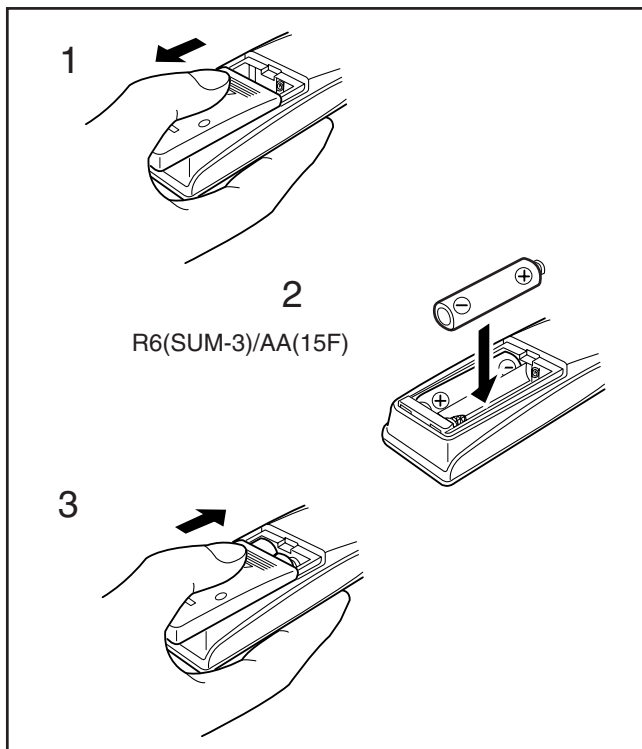

- DO NOT use an old battery together with a new one.
- DO NOT use different types of batteries together.
- DO NOT expose batteries to heat or flame.
- DO NOT leave the batteries in the battery compartment when you are not going to use the remote control for an extended period of time. Otherwise, it will be damaged from battery leakage.

Connecting Antennas

FM antenna

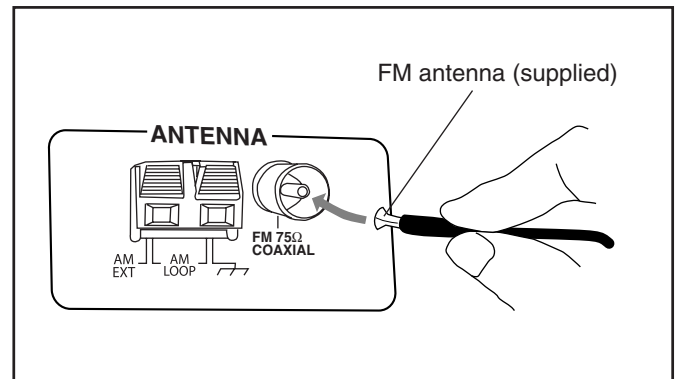

- 1 Attach the FM antenna to the FM 75 Ω COAXIAL terminal.
- 2 Extend the FM antenna.
- 3 Fasten it up in the position which gives you the best reception, then fix it on the wall, etc.



About the supplied FM antenna

The FM antenna supplied with this unit can be used as temporary measure. If reception is poor, you can connect an outdoor FM antenna.

To connect an outdoor FM antenna

Before connecting it, disconnect the supplied FM antenna.

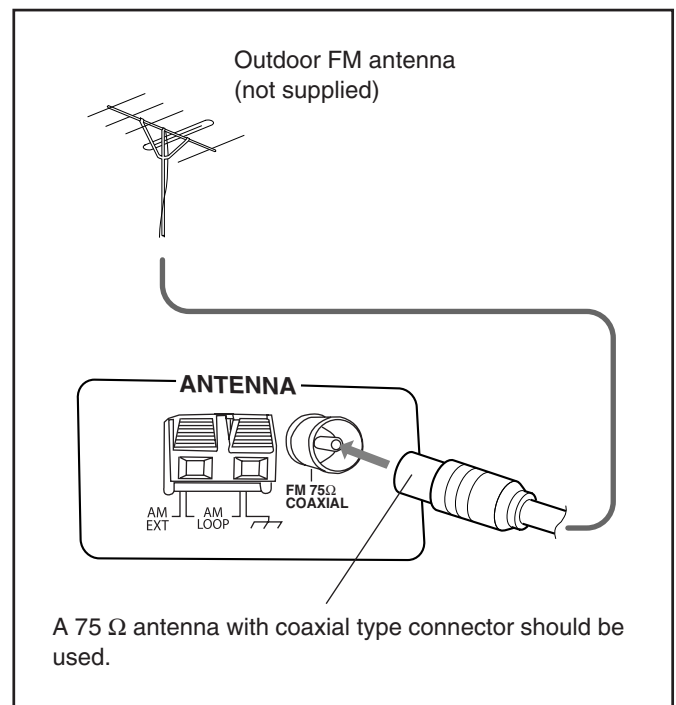

A 75 Ω antenna with coaxial type connector should be used.

AM antenna

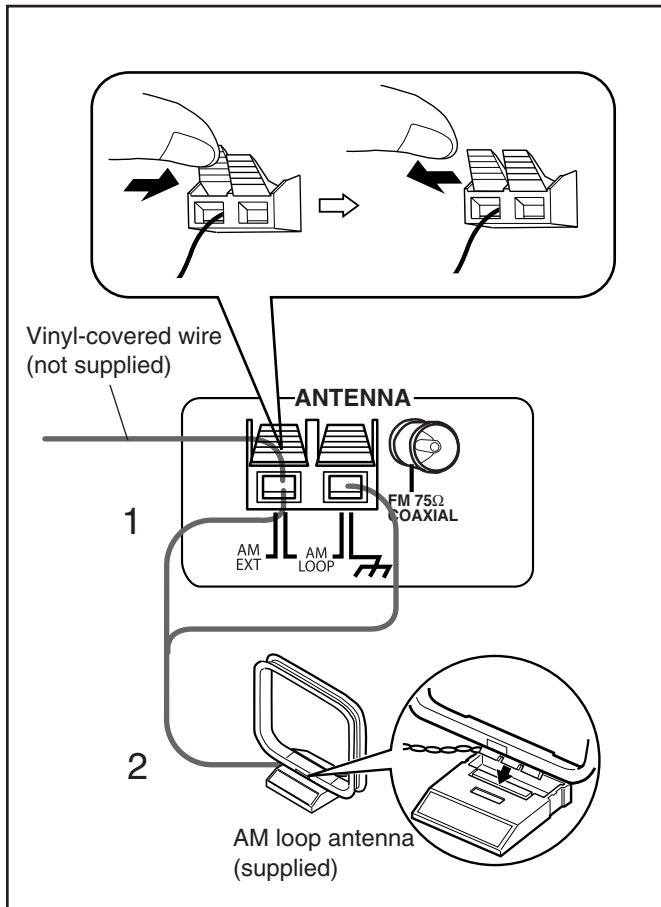

1 Connect the AM loop antenna to the AM LOOP terminals as illustrated.

- If the AM loop antenna wire is covered with vinyl, remove the vinyl by twisting it as shown in the diagram.

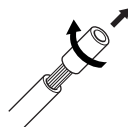

2 Turn the AM loop antenna until you have the best reception.

To connect an outdoor AM antenna

When reception is poor, connect a single vinyl-covered wire to the AM EXT terminal and extend it horizontally. The AM loop antenna must remain connected.



For better reception of both FM and AM

- Make sure the antenna conductors do not touch any other terminals and connecting cords.
- Keep the antennas away from metallic parts of the unit, connecting cords, and the AC power cord.

Connecting Speakers

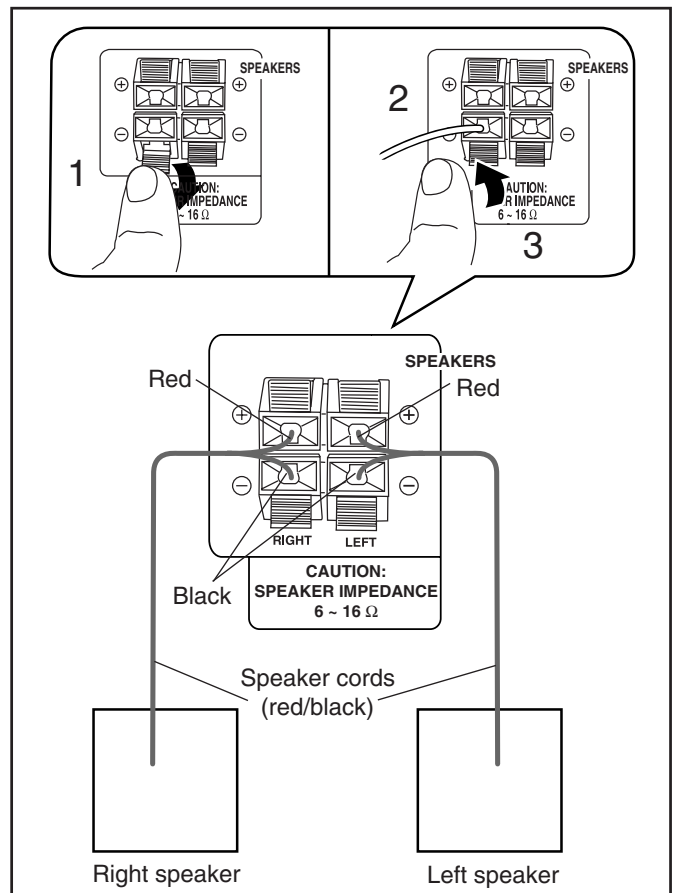

1 Press and hold the clamp of the speaker terminals on the rear of the unit.

2 Insert the end of the speaker cord into the terminal.

Match the polarity (colours) of the speaker terminals: Red (+) to red (+) and black (-) to black (-).

3 Release your finger from the clamp to close the speaker terminals.

Speaker Setting For A/V Combination

SP-MXSK3 and SP-MXSK1 have a magnetically-shielded design for placement adjacent to TV's and monitors without causing color aberrations. However, color may be affected by the way of installing the speaker system. Therefore, please take note of the following:

- When placing these speakers near a TV set, turn off TV's main power switch or unplug it before installing the speakers. Wait at least 30 minutes after the system is installed before turning on the TV's power.
- If another speaker system has been set up near the TV set, that system may cause color unevenness in the TV's picture.
- In spite of the shielded design of these speakers, some of the TV types may be affected by them. If this happens, move the speakers to a short distance away from the TV set.

IMPORTANT: Use only speakers with the same speaker impedance as indicated by the speaker terminals on the rear of the unit.

Surround Speakers

For Model CA-MXSK3

To connect surround speakers.

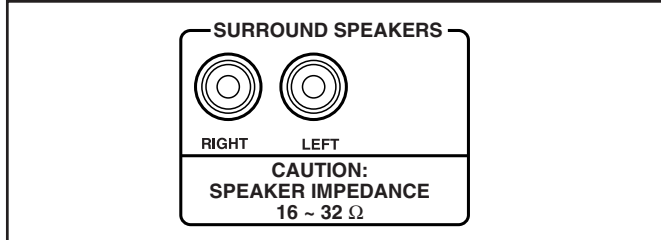

- Connect the right rear speaker to the RIGHT jack.
- Connect the left rear speaker to the LEFT jack.

How to install Surround Speakers

- This equipment is not magnet-proof. If it is placed near a TV set, color on a TV screen may become uneven. Therefore, when installing, locate the speaker at sufficient distance away from the TV set.
- When setting the speaker on a high shelf, be sure to fix them to the shelf by using metal braces: this is a precaution to avoid the speakers from falling off due to shelf trembling.

CAUTION:

The speakers are designed to be attached on the wall. Please have the qualified personnel to attach the speakers on the wall. DO NOT hang the speakers by yourself to avoid the unexpected danger whereby the speakers fall off due to incorrect attachment or unstable wall.

Connecting Other Equipment

You can connect both analog and digital equipment.



- DO NOT connect any equipment while the power is on.
- DO NOT plug in any equipment until all connections are complete.

To connect an analog component

Be sure that the plugs of the audio cords are coloured: White plugs and jacks are for left audio signals, and red ones for right audio signals.

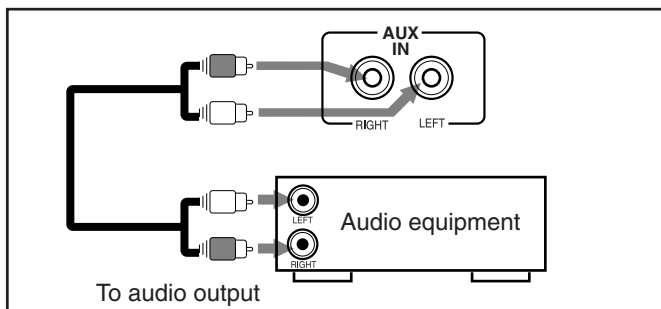

For playing the other equipment through this unit, connect between the audio output jacks on the other equipment and AUX jacks by using audio cords (not supplied).

Adjusting the Voltage Selector

Before plugging in the unit, set the correct voltage for your area with the voltage selector on the rear of the unit.

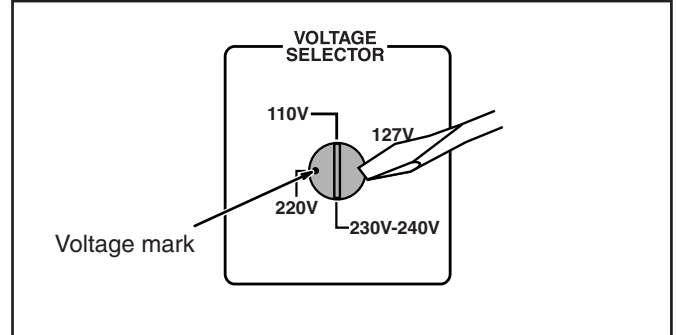

Use a screwdriver to rotate the voltage selector so the voltage number the voltage mark is pointing at is the same as the voltage where you are plugging in the unit. (See the back cover page.)



DO NOT plug in before setting the voltage selector on the rear of the unit and all connection procedures are complete.

Now, you can plug in the AC power cord.

When connecting the AC power cord to a wall outlet, the unit automatically starts display demonstration.

- If the wall outlet does not match the AC plug, use the supplied AC plug adaptor.

IMPORTANT: Be sure to check all connections to be done before plugging the AC power cord into a wall outlet.

Cancelling the Display Demonstration

On the unit ONLY:

To cancel the display demonstration, press CANCEL/DEMO during demonstration, "DEMO OFF" will appear on the display.

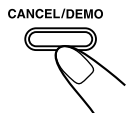

When you press other buttons

The display demonstration stops temporarily. It will start automatically again (if no operation is done for 2 minutes) unless you cancel it by pressing CANCEL/DEMO.

To start the display demonstration manually

Press and hold CANCEL/DEMO again for more than 3 seconds.

Common Operations

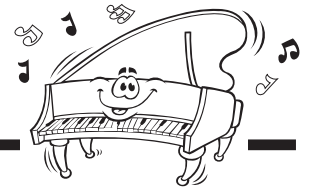

Turning On or Off the Power

To turn on the unit, press STANDBY/ON so that the STANDBY lamp goes off.

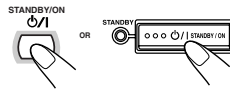

POWER ON

To turn off the unit (on standby), press STANDBY/ON again so that the STANDBY lamp lights up.

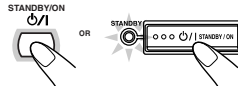

- A little power is always consumed even while the unit is on standby.

To switch off the power supply completely, unplug the AC power cord from the AC outlet.



When you unplug the AC power cord or if a power failure occurs

The clock is reset to "0:00" right away, while the tuner preset stations (see page 12) will be erased in a few days.

Setting the Clock

Before operating the unit any further, first set the built in clock. You can set the clock whether the unit is on or off.

On the unit ONLY:

1 Press CLOCK/TIMER.

The hour digit start flashing on the display.

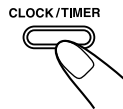

2 Press or to adjust the hour, then press CLOCK/TIMER to set the hour.

SET appear on display.

The minute digits start flashing on the display.

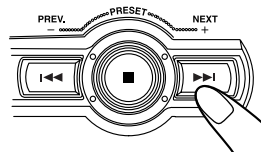

3 Press or to adjust the minute, then press CLOCK/TIMER to set the minute. SET appear on display.

SET

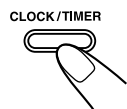

To adjust the clock again

Make sure the (timer) indicator is not lit on the display.

- If it is lit, press and hold CLOCK/TIMER until it goes off. If you have adjusted the clock before, you need to press CLOCK/TIMER repeatedly until the clock setting mode is selected.
- Each time you press the button, the clock/timer setting modes change as follows:

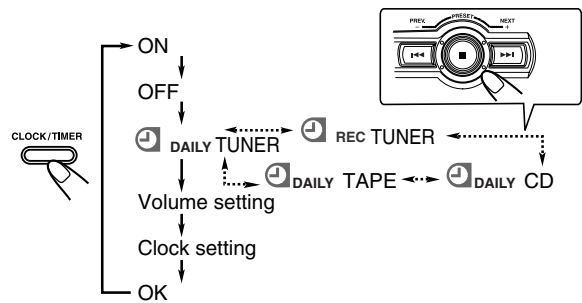

When you unplug the AC power cord or if a power failure occurs

The clock loses the setting and is reset to "0:00." You need to set the clock again. The clock may gain or lose 1 to 2 minutes per month. If this happens, set the clock again.

Setting the AM Tuner Interval Spacing

Some countries space AM stations 9 kHz apart, and some countries use 10 kHz spacing.

On the unit ONLY:

You can only change the AM tuner interval spacing while in STANDBY MODE.

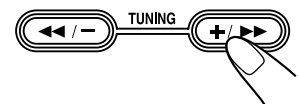

Press STANDBY/ON while holding down for 10 kHz or for 9 kHz interval spacing when you change the setting.



The preset stations are erased. You will need to preset the station again.

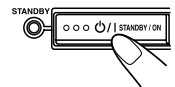

Selecting the Sources

To listen to the FM/AM broadcasts, press FM/AM.

(See page 12.)

To playback CDs, press DISC ►/||. (See pages 13 – 16.)

To playback tapes, press TAPE-A ◀▶ or TAPE-B ◀▶.

(See page 23.)

To select the external equipment as the source, press AUX.

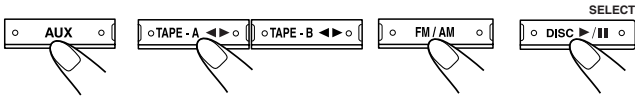

When you press the play button for a particular source (FM/AM, DISC ►/||, TAPE-A ◀▶, TAPE-B ◀▶ and AUX), the unit turns on (and the unit starts playing the source if it is ready — COMPU PLAY CONTROL).



About the audio level indicator

All the audio level indicators light up when no signals come in. The audio level indicators light up when no signal comes in during AUX. The audio level indicators does not represent actual audio level. This is not a spectrum analyzer display.

Adjusting the Volume

You can adjust the volume level only while the unit is turned on. The volume level can be adjusted in 32 steps (VOL MIN, VOLUME 1 — VOLUME 30 and VOL MAX).

Turn VOLUME + / – clockwise (+) to increase the volume or counterclockwise (–) to decrease it.

VOLUME 15

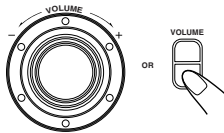

When using the remote control, press VOLUME + to increase the volume or press VOLUME – to decrease it.



For private listening

Connect a pair of headphones to the PHONES jack. No sound comes out of the speakers. Be sure to turn down the volume before connecting or putting on headphones.



DO NOT turn off (on standby) the unit with the volume set to an extremely high level; otherwise, a sudden blast of sound can damage your hearing, speakers and/or headphones when you turn on the unit or start playing any source next time. REMEMBER you cannot adjust the volume level while the unit is on standby.

To turn down the volume level temporarily

Press FADE MUTING on the remote control.

The volume level gradually decreases to “VOL MIN.”



To restore the sound, press the button again.

Reinforcing the Bass Sound (ACTIVE BASS EX.)

The richness and fullness of the bass sound is maintained regardless of how low you set the volume.

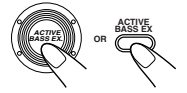

You can use this effect only for playback.

To get the effect, press ACTIVE BASS EX. (Extension) . ACTIVE BASS EX. indicator lights up on the display.

To cancel the effect, press the button again.

ACTIVE BASS EX. indicator lights up.

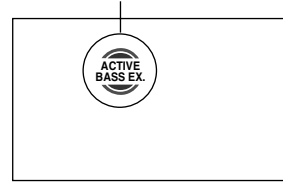

Emphasizing the sound (SOUND TURBO)

High and low frequencies are highly boosted.

To get the effect, press SOUND TURBO.

SOUND TURBO indicator lights up on the display.

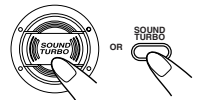

To cancel the effect, press the button again.

SOUND TURBO indicator lights up.

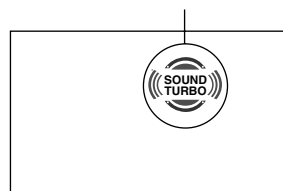

Select Sound Turbo function will turn the Sound Mode off. While the Sound Turbo turns off, the Sound Mode automatically restores to previous setting.

Selecting the Sound Modes

You can select one of the 3 SEA (Sound Effect Amplifier) modes. This function only affects the playback sound, but does not affect your recording.

On the unit:

Press the sound mode button you want to get the effect of ROCK, POP, or CINEMA. The selected Sound Mode name “ROCK”, “POP”, or “CINEMA” appears on the display. Also, the Sound Mode indicator that corresponds to the selected sound mode blinks.

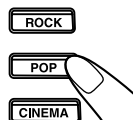

The SOUND MODE indicator also lights up on the display.

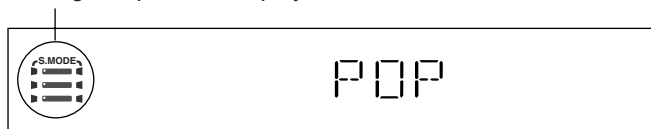

To cancel the effect, press the selected mode button again.

On the remote control:

To select the sound modes, press SOUND MODE until the sound mode you want appears on the display.



- The sound modes change as follows:

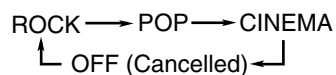

SEA (Sound Effect Amplifier) modes:

- ROCK:** Boosts low and high frequency. Good for acoustic music.
- POP:** Good for vocal music.
- CINEMA:** Good for special effect sound from movie.
- OFF:** The sound mode is cancelled. The SOUND MODE bar indicator goes off.



Select any Sound Modes will turn off Sound Turbo.

Listening to FM and AM Broadcasts



Tuning in a Station

1 Press FM/AM.

The unit automatically turns on and tunes in the previously tuned station (either FM or AM).

- Each time you press the button, the band alternates between FM and AM.

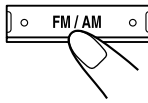

2 Start searching for stations.

On the unit:

Press and hold TUNING +/▶▶ or TUNING ◀◀/- for more than 1 second.

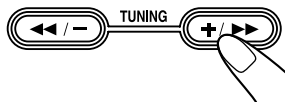

On the remote control:

Press and hold ▶▶ (NEXT ▶▶) or ◀◀ (PREV. ◀◀) for more than 1 second.

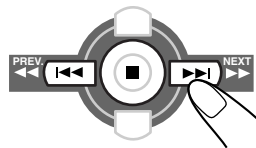

The unit starts searching for stations and stops when a station of sufficient signal strength is tuned in.

- If a program is broadcasted in stereo, the ST (stereo) indicator lights up.

On the unit:

To stop searching, press TUNING +/▶▶ or TUNING ◀◀/-.



When you press TUNING +/▶▶ or TUNING ◀◀/- briefly and repeatedly

The frequency changes step by step.

To change the FM reception mode

When an FM stereo broadcast is hard to receive or noisy, press FM MODE on the remote control so that the MONO indicator lights up on the display. Reception improves.



To restore the stereo effect, press FM MODE again so that the MONO indicator goes off. In this stereo mode, you can hear stereo sounds when a program is broadcasted.

Presetting Stations

You can preset 30 FM and 15 AM stations.

In some cases, test frequencies have been already memorized for the tuner since the factory examined the tuner preset function before shipment. This is not a malfunction. You can preset the stations you want into memory by following the presetting method.

- There is a time limit in performing the following steps. If the setting is cancelled before you finish, start from step 1 again.

On the unit ONLY:

1 Tune in the station you want to preset.

- See "Tuning in a Station."

2 Press SET.

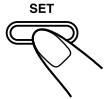

3 Press ◀◀ or ▶▶ to select a preset number.

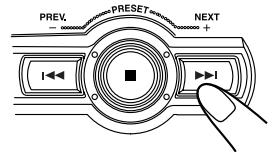
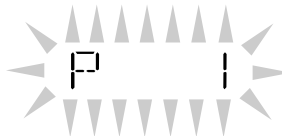

4 Press SET again.

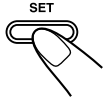

The tuned station in step 1 is stored in the preset number selected in step 3.

- Storing a new station on a used number erases the previously stored one.



When you unplug the AC power cord or if a power failure occurs

The preset stations will be erased in a few days. If this happens, preset the stations again.

Tuning in a Preset Station

1 Press FM/AM.

The unit automatically turns on and tunes in the previously tuned station (either FM or AM).

- Each time you press the button, the band alternates between FM and AM.

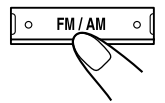

2 Select a preset number.

On the unit:

Press ◀◀ or ▶▶.

On the remote control:

Press the number buttons.

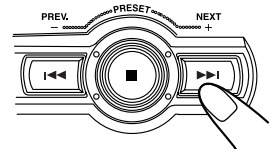

- Ex.: For preset number 5, press 5.
 For preset number 15, press +10, then 5.
 For preset number 20, press +10, then 10.
 For preset number 25, press +10, +10, then 5.
 For preset number 30, press +10, +10, then 10.

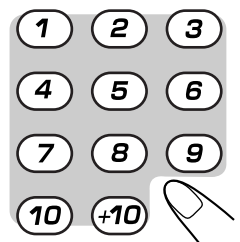



Playing Back CDs (CD/CD-R/CD-RW)

This unit has been designed to playback the following CDs:

- CD (Audio CD)
- CD-R (CD-Recordable)
- CD-RW (CD-ReWritable)

Continuous use of irregular shape CDs (heart-shape, octagonal, etc.) can damage the System.

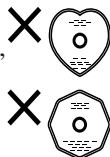

General Notes

In general, you will have the best performance by keeping your CDs and the mechanism clean.

- Store CDs in their cases, and keep them in cabinets or on shelves.
- Keep the system's disc trays closed when not in use.

When playing a CD-R or CD-RW

User-edited CD-Rs (CD-Recordable) and CD-RWs (CD-ReWritable) can be played back only if they are already "finalized."

- You can playback your original CD-Rs or CD-RWs recorded in music CD format. (However, they may not be played back depending on their characteristics or recording conditions.)
- Before playing back CD-Rs or CD-RWs, read their instructions or cautions carefully.
- Some CD-Rs or CD-RWs may not be played back on this unit because of their disc characteristics, damage or stain on them, or the player's lens is dirty.
- CD-RWs may require a longer read-out time. This is caused by the fact that the reflectance of CD-RWs is lower than for regular CDs.

Loading CDs

On the unit ONLY:

1 Press CD Open/Close ▲.

The unit automatically turns on and the disc tray comes out.

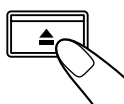

2 Place a disc correctly on the circle of the disc tray, with its label side up.

Label side up

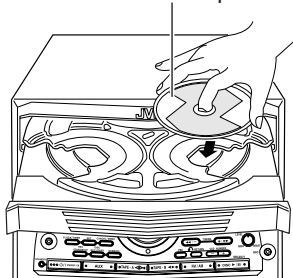

- When using a CD single (8 cm), place it on the inner circle of the disc tray.

3 Press DISC SKIP and place the next CD.

When you press the button, the tray turns for the next CD.



4 Repeat steps 3 for the last CD.

5 Press CD Open/Close ▲.

The tray is closed.



When placing a disc in the tray

Be sure to position the disc inside the recess correctly. Otherwise, the message "NO DISC" will appear in the display, and the disc may be damaged or the unit may be damaged when the tray is opened, or it may be difficult to remove the disc from the unit.



About the disc indicators

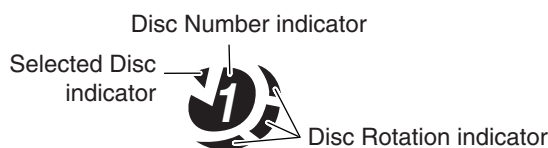

Disc Number Indicator: Lights all the time

Selected Disc indicator: Lights for the currently selected disc number.

Disc Rotation indicator: Runs when the selected CD is played or paused. This indicator goes out if a CD is not loaded for the selected disc number. Once the tray is ejected, the Disc Rotation indicators for all disc numbers are lit. However, when the empty disc number is selected, the Disc Rotation indicator for the disc number goes out.

Example of indication:

When disc tray has ejected once and then DISC 1 is pressed. (DISC 1 is selected)

Shows that this disc number is selected



Shows that the disc is rotating

Playing Back the Entire Discs — Continuous Play

1 Load CDs.

2 Press one of the disc number buttons (DISC 1, DISC 2 and DISC 3) for the disc you want to play.

CD starts playing from the first track of the selected disc.

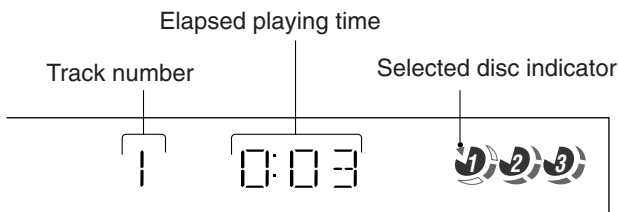

- Pressing DISC ►/|| instead of the disc number buttons starts playing back if a CD is on the tray.
- Playing back the CD using the DISC SKIP button. You can also play the CDs using the DISC SKIP button. During playback, each time you press the button, the next CD is automatically played back.

To stop playing, press ■.

To remove the disc, press ▲. (If the CD is playing, stop the CD before ▲ is pressed.)



CD playback sequence

When 3 CDs* are loaded on the disc tray, they are played in one of the following sequences.

- When DISC 1 is pressed: DISC 1 ⇒ DISC 2 ⇒ DISC 3 (then stops)
- When DISC 2 is pressed: DISC 2 ⇒ DISC 3 ⇒ DISC 1 (then stops)
- When DISC 3 is pressed: DISC 3 ⇒ DISC 1 ⇒ DISC 2 (then stops)

* When only 2 CDs are loaded, they are played in the same order, but the disc tray without a CD is skipped.



Total Number of Contents (TOC) reading

STOP button does not function during CD changing time and TOC reading (about 10-20 seconds). You can press STOP button only after playing time start counting on the display.



If no CD is placed on the disc tray, "NO DISC" appears on the display.

Basic CD Operations

While playing a CD, you can do the following operations.

To remove/change the CDs during playback

While playing back a CD (e.g. DISC 1), you can remove or change the other CDs (e.g. DISC 2 and DISC 3) by pressing ▲. After removing or changing, press the same button to close the tray.

To stop playing for a moment

Press DISC ►/||.

While pausing, the elapsed playing time flashes on the display.



To resume playing, press DISC ►/||.

To go to another track

Press ◀◀◀ or ▶▶▶ before or during playback (or press ▶▶▶ (NEXT ▶▶▶) / ◀◀◀ (PREV. ◀◀◀) on the remote control).

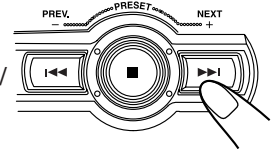

- ◀◀◀: Goes back to the beginning of the current or previous tracks.
- ▶▶▶: Skips to the beginning of the next or succeeding tracks.



If you press and hold (on the unit only) ◀◀◀ or ▶▶▶ before playing

You can change the tracks continuously.

To locate a particular point in a track

On the remote control:

During play, press and hold ▶▶▶ (NEXT ▶▶▶) or ◀◀◀ (PREV. ◀◀◀).

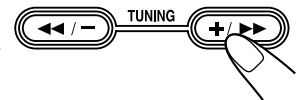

On the unit:

Press TUNING +/▶▶▶ or ◀◀◀/-.

- TUNING ◀◀◀/- (or ◀◀◀ (PREV. ◀◀◀)): Fast reverses the disc.
- TUNING +/▶▶▶ (or ▶▶▶ (NEXT ▶▶▶)): Fast forwards the disc.
- There are 4 searching speed:
 - X1 – 2 seconds search
 - X2 – 5 seconds search
 - X3 – 10 seconds search
 - X4 – 20 seconds search

To go to another track directly using the number buttons

Pressing the number button(s) on the remote control before or during play allows you to start playing the track number you want.

- Ex.: For track number 5, press 5.
For track number 15, press +10, then 5.
For track number 20, press +10, then 10.
For track number 32, press +10, +10, +10, then 2.

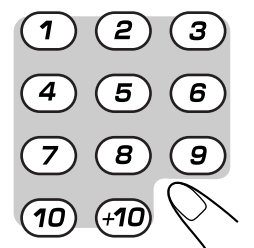

Total time and total number of tracks will only appear on the display at the following condition:

- (1) Power ON in CD mode using standby button.
- (2) New CD inserted into the current tray and the tray closed using the eject button.
 - * The above only apply for audio CD and VCD.
- (3) Search speed might be different for different type of discs.

Programming the Playing Order of the Tracks — Program Play

You can arrange the order in which tracks play before you start playing. **You can program up to 32 tracks.**

- To use Repeat play (see page 16) for Program play, press REPEAT after starting Program play.

1 Load CDs.

- If the current playing source is not the CD player, press DISC ►/||, then ■ before going to the next step.

2 Press PROGRAM so that “PRGM” appears on the display.

The PRGM (program) indicator also lights up on the display.

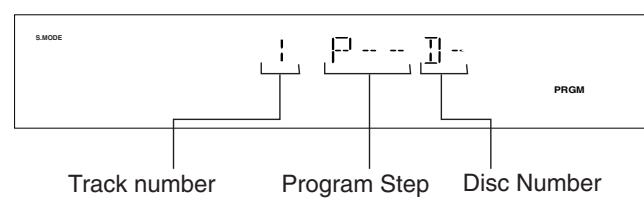

3 Press one of the disc number buttons (DISC 1, DISC 2 and DISC 3) to select the disc number you want to program.

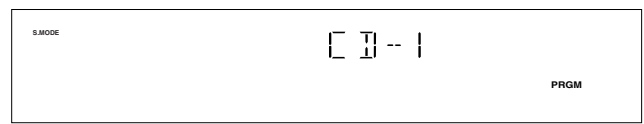
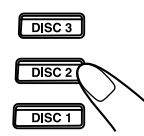

4 Select a track from the CD selected in the above step.

On the unit:

Press ◀◀ or ▶▶ to select the track number and press SET button.

On the remote control:

Press the number buttons.

- For how to use the number buttons, see “To go to another track directly using the number buttons” on page 14.

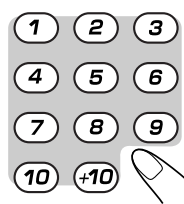
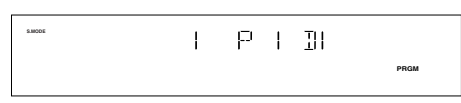
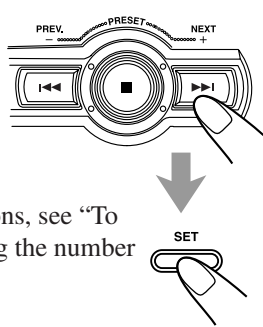

5 Program other tracks you want.

- To program tracks from the same disc, repeat step 4.
- To program tracks from a different disc, repeat steps 3 and 4.

6 Press DISC ►/||.

The tracks are played in the order you have programmed.

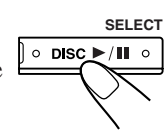

To stop playing, press ■.

To exit from Program play mode, press PROGRAM or STOP again before or after play. The PRGM (program) indicator goes off.



- Memory content of the relevant disc is erased when tray is ejected.
- All memory content is erased when program is turned off.
- If you try to program a 33rd track “FULL” will appear on the display.
- If your entry is ignored
You have tried to program track number that does not exist on the CD (for example, selecting track 14 on a CD that only has 12 tracks). Such entries are ignored.
- If you want to eject current program play disc
Stop the CD and press ▲ to eject. Please note that the program mode is remain eventhough tray is open.

To check the program contents

Before playing, you can check the program contents.

On the remote control:

Press and hold ▶▶ (NEXT ▶▶) or ◀◀ (PREV. ◀◀).

On the Unit:

Press TUNING +/▶▶ or ◀◀/-

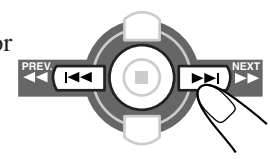

- TUNING +/▶▶ (or ▶▶ (NEXT ▶▶)) :

Shows the programmed tracks in the programmed order.

- TUNING +/◀◀ (or ◀◀ (PREV. ◀◀)) :

Shows them in the reverse order.

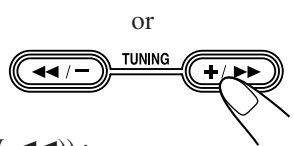

To modify the program on the remote control only

Before or after playing, you can erase the last programmed tracks by pressing PROGRAM CANCEL on the remote control.



- Each time you press the PROGRAM CANCEL on the remote control the programmed track shown on the display is erased from the program.
- Ejecting a CD will also erase the track numbers programmed from the ejected CD.

To add tracks to the program before playing, simply select the track numbers you want to add by following step 4 of the programming procedure.

To erase the entire program before or after playing, press ■.

The program you have made will be erased:

- when you unplug the AC power cord.
- when a power failure occurs.

Playing at Random — Random Play

The tracks of all loaded CDs will play at random.

- To use Repeat play for Random play, press REPEAT after starting Random play.

1 Load CDs.

- If the current playing source is not the CD player, press DISC ►/■, then ■ before going to the next step.

2 Press RANDOM.

The RANDOM indicator also lights up on the display.



3 Press DISC ►/■.

The tracks of the current disc are randomly played until finish before changing to another tray.

Random play ends when all the tracks are played once.



To skip the currently playing track, press ►►| (or press ►►| (NEXT ►►) on the remote control).



Even if you press ◀◀| (or press ◀◀| (PREV. ◀◀) on the remote control)

You cannot go back to previous tracks during Random play.

To stop playing, press ■.

To exit from Random play mode, press RANDOM or STOP again before or after playing.

Repeating Tracks or CDs — Repeat Play

You can have all the CDs, the program or the individual track currently playing repeat as many times as you like.

To repeat playing, press REPEAT during or before playing. To use Repeat play for Program play and Random play, press the button after starting playback.



- Each time you press the button, Repeat play mode changes as indicated by the following indicator lights up on the display:

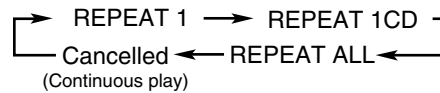

REPEAT ALL: Repeats all the tracks on all the CDs (continuously or at random) or all the tracks in the program.

REPEAT 1 : Repeats one track on one CD.

REPEAT 1CD : Repeats all the tracks on one CD.

To cancel Repeat play, press REPEAT repeatedly until the REPEAT indicators go off from the display.

- Repeat play remains in effect when you select another play mode (NORMAL, PROGRAM or RANDOM)
- In RANDOM and PROGRAM play, “REPEAT 1CD” can’t be selected. If REPEAT 1CD has been selected when you press RANDOM, it is cancelled. Only REPEAT 1 and REPEAT ALL can be selected.

Prohibiting Disc Ejection — Tray Lock

You can prohibit CD ejection from the unit and lock CDs.

- This operation is possible only when the source is the CD player.

On the unit ONLY:

To prohibit disc ejection, press ◻/| STANDBY/ON while holding down ■. (If there is any disc tray opened, close it first.) “LOCKED” appears for a while, and the loaded CDs are locked.

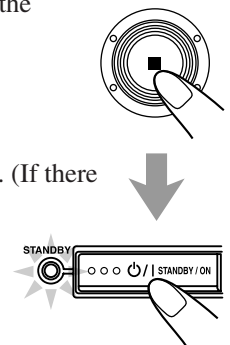

To cancel the prohibition and unlock the CDs, press ◻/| STANDBY/ON while holding down ■. “UNLOCKED” appears for a while, and the loaded CDs are unlocked.



If you try to eject CDs

“LOCKED” appears to inform you that the Tray Lock is in use.

Playing Back Video CDs



Selecting Video Output (PAL, PAL AUTO, NTSC)

You can set this setting in Standby mode.

Before playing a VCD, use the buttons on the unit to select a video output mode to match your TV system.

Video output is preset for PAL.

Relationship among the playable CDs, System's TV output mode and your TV's color system:

| Playable CD | Player's TV output mode | Your TV's color system |
|-------------|-------------------------|------------------------|
| NTSC/PAL | NTSC | NTSC |
| NTSC/PAL | PAL | PAL |
| NTSC/PAL | PAL AUTO | Multisystem |

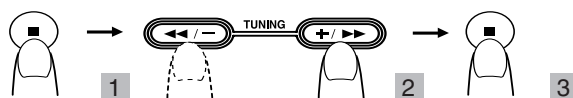

1 Turn off the power to put the System into Standby mode.

2 Press and hold the **■** button on the Unit for more than 2 seconds.

The current TV output mode ("NTSC" for example) appears on the display for five seconds.

3 Within five seconds, press the TUNING **+ / >>** or TUNING **<< / -** button on the Unit to select the System's TV output mode.

Each time you press the button, the TV output mode changes as follows:

NTSC → PAL → PAL AUTO (back to beginning)

NTSC: for NTSC exclusive TV

PAL: for PAL exclusive TV

PAL AUTO: for multisystem TV

4 Press **■** button to confirm selected TV output mode.

Loading Discs

1 Press CD Open/Close **▲**.

The unit automatically turns on and the disc tray comes out.

2 Place a disc correctly within the circle of the disc tray, with its label side up.

Label side up

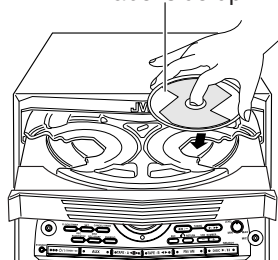

- When using a CD single (8 cm), place it within the inner circle of the disc tray.

3 Press DISC SKIP and place the next CD.

When you press the button, the tray turns for the next CD.

4 Repeat steps 3 for the last CD.

5 Press CD Open/Close **▲**.

The tray is closed.

When you place a CD onto the currently selected tray, whose disc number shown on the CD indicator, reading of the CD starts. After the reading is completed, the total number of tracks and total playing time will appear, then the playing time of the first track.

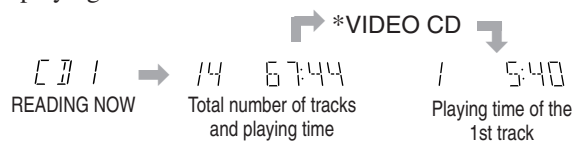

*VIDEO CD or AUDIO CD

If the video CD has the Playback Control function, "VCD PBC" will appear when you press **■** followed by PBC and DISC **▶/||**.

To put an 8 cm CD onto a tray, insert it so that it is aligned with the groove in the trays center.

If a tray is opened when the System switches to the standby mode, the tray will close automatically.

Playing a Video CD

You can play video CDs either with or without the PBC function.

1 Turn on the TV and select the video input so that you can view the pictures from the CD player.

Refer to the manual supplied for your TV.

2 Prepare a CD.

Refer to "Loading Discs" on this page.

3 Start playback of the CD.

Press DISC **▶/||**, to start playback of the currently selected CD, or press DISC 1-3, to select the disc and start playing.

Compu Play

When DISC **▶/||**, or DISC 1-3, is pressed while the system is on standby, the power is automatically turned on.

To stop during play, press **■**.

To stop playing and remove the disc, press **■** and then **▲** for the disc being played.

Playing Video CDs with PBC Function — Menu Play

This System provides Playback Control (PBC) which utilizes a procedure (menu selection) programmed in a video CD. The playback operation procedure may differ depending on the disc you use.

For Menu Play, use the following buttons:
(PBC mode must be turned on before operating Menu Play.)

On the unit:

- NEXT + (▶▶)** for viewing the unshown portion of the menu
- PREV. - (◀◀)** for viewing the previously shown portion of the menu
- DISC ▶/||** for starting playback of the selected item
- ↶ RETURN** for going back to the previous menu
- VCD NUMBER +, -** for selecting an item

On the remote control:

- ▶▶ (NEXT ▶▶)** for viewing the unshown portion of the menu
- ◀◀ (PREV. ◀◀)** for viewing the previously shown portion of the menu
- NUMBER BUTTONS ...** for selecting and starting playback of an item
- ↶ RETURN** for going back to the previous menu

1 Turn on the TV and select the video input so that you can view the pictures from the CD Player.
Refer to the manual supplied for your TV.

2 Prepare a CD.
Refer to “Loading Discs” on page 17.

3 Press PBC on the unit.
Allow several seconds for the table of contents (TOC) to be read before pressing PBC.
PBC indicator lights up on the display

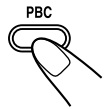

S.MODE 1 56:32 PBC

4 Start playback of the CD.
Press DISC ▶/||, to start playing of the currently selected CD.

S.MODE 1 56:32 PBC

5 Select the item you want to view.

On the unit:

Press VCD NUMBER + to select larger item numbers, or press VCD NUMBER - to select smaller item number. Then press DISC ▶/||, to start the disc. In case VCD number cannot be selected from the unit, please use the remote control.

On the remote control:

Press the number buttons to select and play the item you want.

To stop the track being played and return to the menu, press ↶ RETURN button.

To stop Menu Play, press ■.

NOTE:

You can only select PBC in CD STOP and repeat off position. REPEAT mode is turned off automatically.

Basic Concept of the PBC function

PBC (Playback Control) allows you to enjoy menu-driven operation and high resolution still images having a resolution four times greater than video pictures.

Menu-driven playback

You can interact with the screen using a menu display to select and play an entry.

High-resolution still image display

You can display high-quality images four times clearer than video pictures.

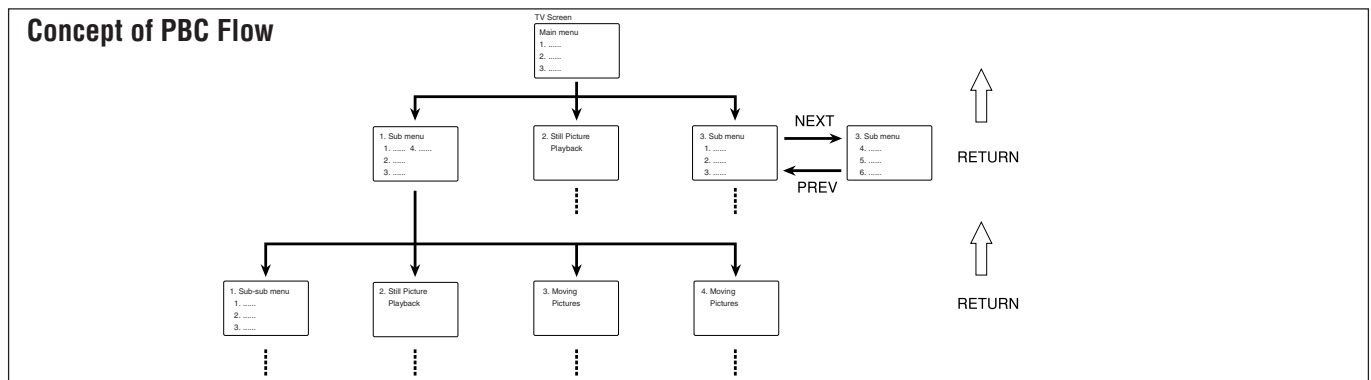

Basic flow of Menu Play Operation

A selection menu is shown when you start playing a video CD with PBC. The menu shows a list of items to select. Some discs may show moving pictures or a divided screen.

- When a list of items appears, you can select the number of the item you want to playback.
- When moving pictures appear, you can select a moving picture by pressing ▶▶ (NEXT ▶▶) / ◀◀ (PREV. ◀◀).

- When the menu appears after the item you have selected finish playing, you can select another item that you want to view next.
- After playback, press ↶ RETURN, to go back to the previous screen. Each time you press the button, you will go back by one screen.
- If you want to stop Menu Play, press ■.



Cancelling PBC

- After cancelling PBC, you can Continuously Play more than one video CD without PBC.
- When PBC is cancelled, some images such as still play pictures may not be played back.
- You cannot change from PBC OFF to PBC ON while CD is playing.

Reminder!

Do not pause Video CD for more than 10 minutes to prevent screen burns.

Playing Video CDs without PBC — Continuous Play

Even if a video CD has PBC, you can cancel PBC and play the disc without using the menu screen.

1 Turn on the TV and select the video input so that you can view the pictures from the CD Player.

Refer to the manual supplied for your TV.

2 Prepare a CD.

Refer to “Loading Discs” on page 17.

3 Start playback of the CD.

On the unit:

Press DISC ►/|| or DISC 1-3 of the tray you want to play from. The selected video CD starts playback from the first track.



On the remote control:

Press the number button of the track you want to start playing. The playback starts from the selected track of the currently selected disc.

To stop during play, press ■.

To restore PBC, press the PBC button again, then press current DISC ►/|| to play VCD with PBC.

Pressing DISC 1, DISC 2 or DISC 3 will cancel PBC automatically.

Resuming Play

If you stop a video CD directly, you can continue viewing from the scene where you last stopped.

1 During playing of a VCD, press ■ button to stop playing (refer to page 17).

2 Press DISC ►/|| button to continue playback from the last scene that you stopped at.



- Resume play will not work when the CD tray has been opened.
- It is advisable to turn off PBC to use resume play otherwise resume feature will be cancelled.
- Resume play will also function when you change source or turn off the unit (on standby) during playing of a VCD.

Special Plays for a Video CD

You can use the following special play modes for video CDs both with and without PBC. The following functions can only be executed with the buttons on the remote control.

Frame-by-Frame Playback

Press the STILL button during playback. Then each time you press the button, still pictures advance by one frame. During frame-by-frame playback, no sound is emitted.



To resume normal playback, press DISC ►/||.

Viewing Operating Status

Usually, the following information of the track being played is shown on the TV screen during playback : the disc number, the track number, and the playing time.

Press ON SCREEN.

This button toggles the display of operation status. When the display of operation status turns on, the following information of the track being played appear on the TV screen: Disc number, track number / total number of tracks and the current tracks elapsed time.

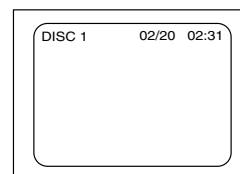

To cancel the display of operation status, press ON SCREEN.

Viewing the Video Intro of the Video CD

You can view the contents of a video CD, watching for about 7 seconds of each track on the video CD. Video intro does not work with PBC. For a video CD with PBC, cancel the PBC function by referring to “Playing Video CDs without PBC” on this page.

1 Press DISC 1-3, to select the disc you want to view the video intro.

Playback starts.

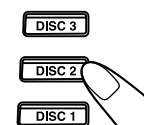

2 Press VIDEO INTRO on the remote control after a picture appears on the TV screen.

The video intro play starts and shows in sequence for about 7 seconds of the first nine tracks on the TV screen. To preview subsequent tracks, press ►► (NEXT ►►) on the remote control. Pressing ◀◀ (PREV. ◀◀) will display the previous 9 track intros.



The TV screen will show the following:

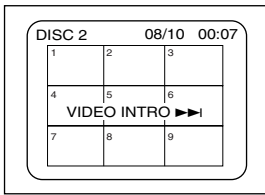

3 Press the number button for the video intro you want to select.

Playback starts from the selected track.

To stop and cancel the video intro play, press ■.

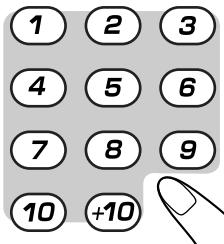

Viewing the Highlights of a Video CD

You can view highlight scenes of the selected track on a video CD only when PBC is off. These highlight scenes are created by dividing the track equally into 9 portions and the beginning scenes (about 7 seconds each) of those 9 portions are shown on the display.

1 Press DISC 1-3, and the number button for the track you want to view the highlights of.

Playback starts.



2 Press HIGHLIGHT on the remote control after a picture appears on the TV screen.

The highlight play starts and shows in sequence, the first 7 seconds of nine track divisions on the TV screen. To preview subsequent tracks, press ►► (NEXT ►►) on the remote control.



TV screen will show the following:

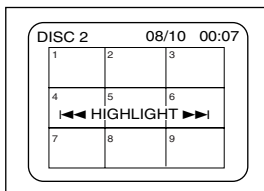

3 Press the number button for the highlight you want to select.

Playback starts from the selected scene.

To stop and cancel the highlight play, press ■.

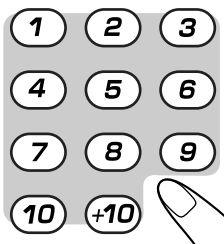

Viewing highlights

- When a highlight scene is selected, playback starts from the beginning of the highlight scene, but not from the still image shown on the display (the part shown is the last part of the highlight scene, not its beginning).
- During the video intro or highlight play, images shown on the display may be partially distorted, resulting from noise or incorrect manufacturing of the disc.
- Highlight also can function in stop position.
- When STILL/PAUSE function is on, HIGHLIGHT and VIDEO INTRO functions are not available.

Playing a Multiplex Sound CD

This function is used for multiplex sound discs. See manuals attached to discs for detailed information.

Operation

By pressing the MPX button on the remote control consecutively, channel multiplexing modes are cycled as shown below.

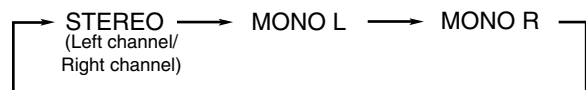

When MONO L or MONO R is selected, display indicates MONO L or MONO R respectively.

- MONO L: Only the left channel is played back through both right and left speakers.
- MONO R: Only the right channel is played back through both right and left speakers.
- STEREO: Used for conventional stereo sources.

MP3 Disc Playback

About MP3 discs

An MP3 disc can have several folders (albums). Tracks are contained within the albums. The player will only recognize up to 76 albums. Total number of tracks recognizable is 999.

Recording your own MP3 discs

- Disc format should be set to “ISO 9660”.
- Multisession recording is not supported.
- The disc must be finalized.
- Files other than MP3 will be ignored.

Basic operations

If your TV set is connected to the unit, you can view the contents of the MP3 disc on-screen.

- 1 Load an MP3 disc.
- 2 Press DISC 1, DISC 2 or DISC 3, and CD starts playing.
- 3 Press  button, Group Title Menu will appear on TV screen.

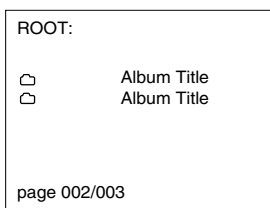

- 4 Press PRESET NEXT + (▶▶) or PREV. - (◀◀) (or press ▶▶ (NEXT ▶▶) / ◀◀ (PREV. ◀◀) on the remote control) to select the album. At the last entry, press PRESET NEXT + (▶▶) will move to the next page (if any). Albums are arranged in alphabetical order.

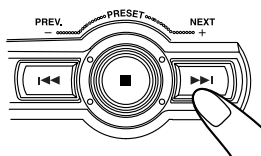

- 5 Press ENTER on the remote control to confirm your album selection.

The following display will appear on the TV screen.

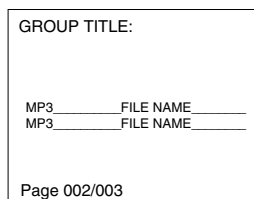

- To exit from the selected album, press  RETURN.

- 6 Press PRESET NEXT + (▶▶) or PREV. - (◀◀) (or press ▶▶ (NEXT ▶▶) / ◀◀ (PREV. ◀◀) on the remote control) to select the track.

- 7 Press DISC ▶/|| to play.

The next track will be automatically played after the current track is finished.

- 8 If you press and hold ▶▶ (NEXT ▶▶) / ◀◀ (PREV. ◀◀) on the remote control, you can fast search (reverse/forward) within a track. The track elapsed time on the unit's display will change.

- 9 Press  to stop playing and return to album menu.



At any time you may select a track from any album by pressing the number keys on the remote control.

Example:

For track number 28, press +10 twice, then 8.

Programming tracks

- 1 Press PROGRAM on the unit or on the remote control.
- 2 Select a MP3 disc using the DISC 1, DISC 2 or DISC 3 button. The following display will appear on your TV screen.

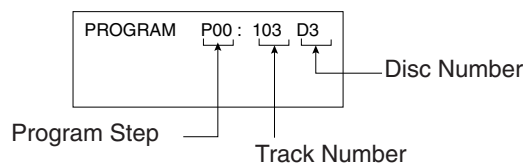

- 3 Select an album using PRESET NEXT + (▶▶) or PREV. - (◀◀).

At the last entry, press PRESET NEXT + (▶▶) or PREV. - (◀◀), it will move to the next page (If any).

- 4 Press SET on the unit or ENTER/SET on the remote control. The following screen will appear on your TV.

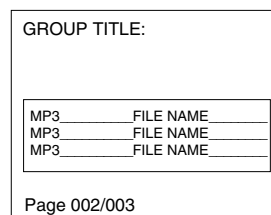

- To exit from the selected album, press  RETURN.

5 Select a track from the CD selected in the above step.

On the unit

Press PRESET NEXT + (▶▶|) or PREV. – (|◀◀), then press SET button.

On the remote control:

Press ▶▶| (NEXT ▶▶) or |◀◀ (PREV. ◀◀), then press ENTER button or SET button.

You can also press the number button.

- To cancel the entry, press CANCEL/DEMO on the unit or PROGRAM CANCEL on the remote control.
- To cancel the whole program, press PROGRAM or press ■ to clear all memory content.
- If you want to return to the Group Title Menu, press ⌂ RETURN button.
- To check program contents and modify the program, see “To check the program contents” and “To modify the program on the remote control only” on page 15.

6 Press DISC ▶/|| to start program playback.

To stop playing press ■.

To skip program,

On the unit

Press PRESET NEXT + (▶▶|) or PREV. – (|◀◀).

On the remote control:

Press ▶▶| (NEXT ▶▶) or |◀◀ (PREV. ◀◀).

To cancel the program, press ■ while the disc not playing.



Playing Back Tapes

You can playback type I, type II and type IV tapes without changing any settings.

Playing Back a Tape

- 1** Press EJECT (▲) for the deck you want to use.

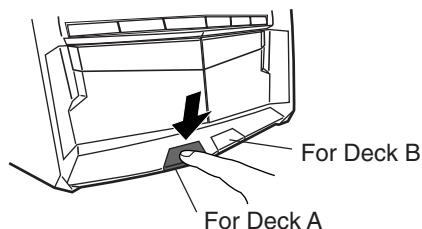

- 2** Put a cassette in with the exposed part of the tape down.

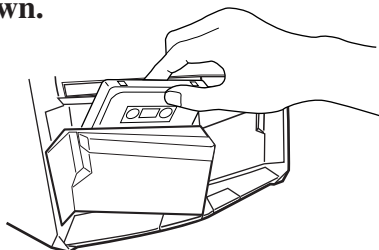

- 3** Close the cassette holder gently.

- 4** Press TAPE-A ◀▶ or TAPE-B ◀▶ for the deck you want to use.

The tape play starts and the tape direction indicator ▶- or -◀ starts flashing slowly to indicate the tape running direction.



- Each time you press the button, the tape direction changes.

▶- : plays the forward side.

-◀ : plays the reverse side.

- If no cassette is inserted in current deck then “DECK A” or “DECK B” and “NO TAPE” will start blinking on the display.

When the tape plays to the end, the deck automatically stops or reverse play depends on the setting of Reverse Mode. (See “To play both sides repeatedly — Reverse Mode.”)

To stop playing, press ■.

To fast forward or fast reverse, press +/▶▶ or ◀◀/- (or ▶▶/(NEXT ▶▶)/◀◀/(PREV. ◀◀) on the remote control).

The tape direction indicator ▶- or -◀ starts flashing quickly on the display.

To remove the cassette, press ▲ EJECT for deck A or EJECT ▲ for deck B.

To play both sides repeatedly — Reverse Mode

Reverse Mode works for both decks at the same time.

When it is in use, the tape automatically reverses at the end of a side and the unit starts playing the other side of the tape, and repeats the same process.

To use Reverse Mode, press REVERSE MODE.

The Reverse Mode indicator on the display lights up — □.

To cancel Reverse Mode, press the button again so that the Reverse Mode indicator on the display lights up — □.

□ : Play one direction only.

□ : Play both sides of current deck.

□ : Play DECK A and DECK B repeatedly.



notes When Reverse Mode is on with cassettes in both decks A and B

After the reverse -◀ side of the tape finishes playing, the tape in the other deck starts playing.

Recording



IMPORTANT:

- It may be unlawful to record or play back copyrighted material without the consent of the copyright owner.
- The recording level is automatically set correctly, so it is not affected by the VOLUME, the ACTIVE BASS EX., the SOUND TURBO, and the SOUND MODE. Thus, during recording you can adjust the sound you are actually listening to without affecting the recording level.
- If recordings you have made have excessive noise or static, the unit may be too close to a TV. Increase the distance between the TV and the unit.
- You can use type I tape for recording.

To protect your recording

Cassettes have two small tabs on the back to protect from accidental erasure or re-recording.

To protect your recording, remove these tabs.

To re-record on a protected tape, cover the holes with adhesive tape.

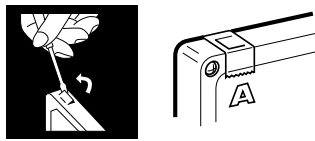

To keep the best recording and playback sound quality

If the heads, capstans, and pinch rollers of the cassette decks become dirty, the following will occur:

- Impaired sound quality
- Discontinuous sound
- Fading
- Incomplete erasure
- Difficulty in recording

To clean the heads, capstans, and pinch rollers

Use a cotton swab moistened with alcohol.

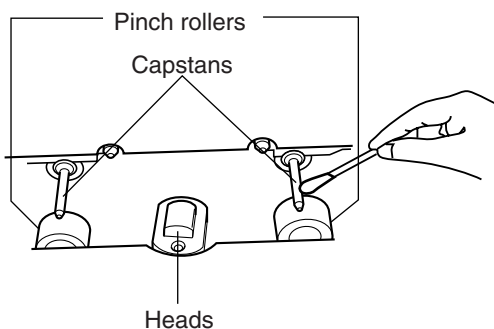

To demagnetize the heads

Turn off the unit, and use a head demagnetizer (available at electronics and audio shops).

Recording a Tape on Deck B

1 Press EJECT ▲ for deck B.

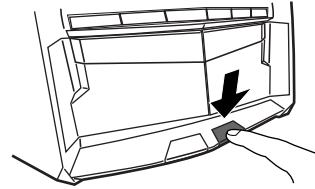

2 Put a recordable cassette into deck B.

3 Close the cassette holder gently.

4 Check the tape direction of deck B.

- If the tape direction is not correct, press TAPE-B ◀▶ twice then ■ to change the tape direction.

5 Start playing the source — FM, AM, CD player, deck A or auxiliary equipment connected to AUX jacks.

- When the source is CD, you can also use CD Direct Recording (see page 25).
- When the source is deck A, you can also use the dubbing method. (See “Dubbing Tapes” on page 25 .)

6 Start recording.

Press REC START/STOP.

The **REC** (recording) indicator lights up on the display and recording starts.

- If no cassette is inserted, “NO TAPE” appears on the display. If a protected tape is inserted, “NO REC” appears on the display.



To stop recording immediately, press ■.

To remove the cassette, press EJECT ▲ for deck B.





REC START/STOP

During CD mode, when recording stop after tape finish, press ■ once to cancel the recording function. Otherwise, the system will remain in recording mode and certain operations will be invalid.

To record on both sides — Reverse Mode

Press REVERSE MODE so that the Reverse Mode indicator lights up – .

- When using Reverse Mode for recording, start recording in the forward - direction first. Otherwise, recording will stop when recording is done only on one side (reverse) of the tape.

To cancel Reverse Mode, press the button again so that the Reverse Mode indicator lights up – .

Dubbing Tapes

You can record from one tape to another.

On the unit ONLY:

- 1 Press either TAPE-A  or TAPE-B , then .

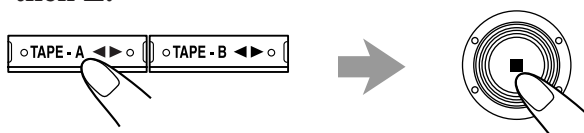

- 2 Put the source cassette into deck A, and a recordable cassette into deck B.

- Put the cassettes in both decks so that the tapes will run in the forward - direction.

- 3 Press DUBBING.

The  (recording) indicator lights up on the display and dubbing starts.



To stop dubbing, press  so that both decks (A and B) stop.

To record on both sides — Reverse Mode

Press REVERSE MODE so that the Reverse Mode indicator lights up – .

To cancel Reverse Mode, press the button again so that the Reverse Mode indicator lights up – .

CD Direct Recording

Everything on the CD goes onto the tape according to the order of the CD.

On the unit ONLY:

- 1 Put a recordable cassette into deck B.

- 2 Load CDs.

- 3 Press one of the disc number buttons (DISC 1, DISC 2 and DISC 3) to select the disc, then .



- 4 Press DISC REC START.

“DISC REC START” appears, and the  (recording) indicator lights up on the display. Deck B starts recording and the CD player starts playing. When the recording is done, “DISC REC FINISHED” appears on the display and deck B stop.







To stop recording, press REC START/STOP or . So that a 4-second blank portion is created on the recording tape.





- Before recording on a tape, wind the tape on past the leader tape (about the first 3 or 4 seconds of each side).

To record on both sides — Reverse Mode

Press REVERSE MODE so that the Reverse Mode indicator lights up like – .

- When using the Reverse Mode for CD Direct Recording, start recording in the forward - direction first. When the tape reaches its end while recording a song in the forward direction , the last song will be re-recorded at the beginning of the reverse side .

If you start recording on the reverse side , recording will stop when recording is done only on one side (reverse) of the tape.

To cancel Reverse Mode, press the button again so that the Reverse Mode indicator lights up – .

Using the Microphones



You can enjoy singing along (Karaoke) and microphone mixing using a microphone.

IMPORTANT:

- Always set **MIC LEVEL** to **MIN** when connecting or disconnecting the microphone.
- When not using the microphone, keep it disconnected.

Singing along — Karaoke

Karaoke

Karaoke reduces the lead vocal of the playing source, and allows you to replace it by singing into the microphone as the music plays.

1 Turn **MIC LEVEL** to **MIN**.

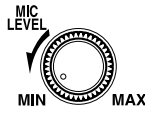

2 Connect the microphone (not supplied) by plugging it into **MIC** jack.

3 Press **KARAOKE** on the remote control.

The karaoke (K) indicator lights up on the display.



4 Start playing the source — CD, tape or other connected component.

5 Turn **MIC LEVEL** and **VOLUME** as you sing into the microphone.

- By pressing **REC START/STOP**, you can record your singing along if you want. (For more details, see page 24.)

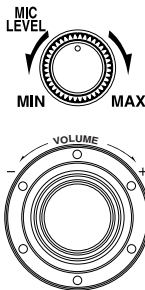

To apply an echo to your voice

Press **ECHO** on the remote control so that the echo (E) indicator lights up on the display.

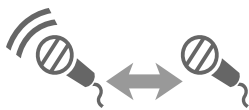

Each time you press the button, the echo level changes as follows:

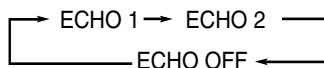

- As the number increases, a stronger echo effect is applied to your voice.

notes If howling or squealing (feedback) occurs while using the microphone

Take the following actions to prevent these noises.

- Adjust **MIC LEVEL** and **VOLUME**.
- Avoid pointing the microphone towards the speakers.

notes When you turn on Karaoke and MPX, you cannot get the satisfactory results if

- Radio programs — a radio signal is not as reliable as the signals coming from a tape or CD.
- Monaural sources.
- Poorly dubbed tapes.
- Sources recorded with duets, strong echo, a chorus or only a few instruments.
- To get the best result, turn off karaoke when MPX is on or turn off MPX when karaoke is on.

Singing Along with Multiplex Karaoke Discs (MPX)

If the source you are going to play is a multiplex karaoke disc, you can use the Multiplex sound function via the buttons on the remote control.

What is Multiplex Sound?

On a multiplex karaoke disc, the instrumental parts are recorded on the left channel. With this system, you can replace the vocal part with your voice through the microphone.

1 Rotate the **MIC LEVEL** and **VOLUME** to **MIN**.

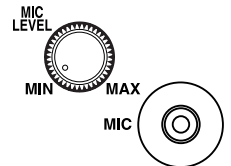

2 Connect the microphone (not supplied) into the **MIC** jack on the front panel.

3 Play the source — CD.

4 Press **MPX** on the remote control to select the output sound.

Please refer to page 20.



5 Turn **MIC LEVEL** and **VOLUME** to adjust the microphone level and the speaker output level.

6 Sing into the microphone.

To apply echo to your voice, see “To apply an echo to your voice” on this page.

To adjust the music key, see “Adjusting the Music Key Control” on page 27.

To record your singing along, see “Microphone mixing” on page 27.

notes When finished singing

Restore the stereo effect by pressing **MPX** until “STEREO” appears on the display. To cancel echo effect, press **ECHO** until “ECHO OFF” appears on the display.

Recording Your Singing

You can adjust the music key using the remote control.

- 1 Follow the steps in “Singing Along with Multiplex Karaoke Discs (MPX)” on page 26.
- 2 Follow the steps in “Recording a Tape on Deck B” on page 24 to record your singing.

Adjusting the Music Key Control (for CD play only)

On the remote control ONLY:

- 1 Press **KEY CONTROL b / #** to adjust the music key.

To lower the key, press **KEY CONTROL b** .
To raise the key, press **KEY CONTROL #**.

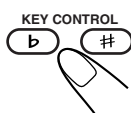

To cancel the key adjustment, press **KEY CONTROL b** or **#** until “KEYCON 0” appears on the display and the TV screen display is as below:

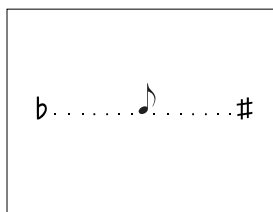

Adjust the music key each time you sing along to a song

Once the music key is adjusted, the key level will not return to the previous level automatically after playing a song.
The music key cannot be changed while recording.
Once the source is changed, the key level returns to 0.

Microphone mixing

When you sing along with multiplex tapes or CDs, follow the procedure below:

- 1 Connect the microphone.
- 2 Start playing the source — CD, tape or other connected component.

- 3 Turn **MIC LEVEL** and **VOLUME** as you sing into the microphone.

- By pressing **REC START/STOP**, you can record your singing along if you want.
(For more details, see page 24.)

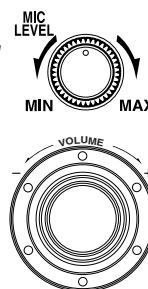

To use microphone only

Without any background sound, you can use your microphone and record it if you want.

- 1 Connect the microphone.
- 2 Press **DISC ►/II**, then **■**.
No background sound will be heard.

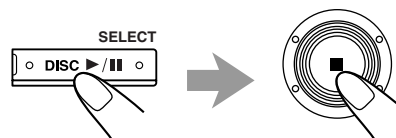

- 3 Turn **MIC LEVEL** and **VOLUME** as you sing into the microphone.

- By pressing **REC START/STOP**, you can record your singing along if you want.
(For more details, see page 24.)

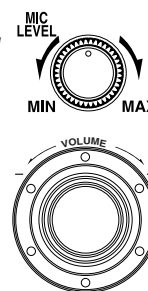

Using the Timers

There are three timers available — Daily Timer, Recording Timer and Sleep Timer.

Before using the timers, you need to set the clock built in the unit. (See page 9.)

Using Daily Timer and Recording Timer

With Daily Timer, you can wake to your favorite music or radio program. You can set the timer whether the unit is on or off.

How Daily Timer works

The unit automatically turns on, sets the volume level to the preset level, and starts playing the specified source when the on-time comes (the  indicator flashes just before the on-time, and continues flashing while the timer is operating). Then, when the off-time comes, the unit automatically turns off (on standby).

The Daily timer works everyday automatically. If you do not want to use the Daily timer, turn off the Daily timer. (See “To deactivate the timer temporary” on page 29.) The timer setting remains in memory until you change it.

- There is a time limit in performing the following steps. If the setting is cancelled before you finish, start from step 1 again.
- To correct a misentry, deactivate the timer and start from step 1 again.

Before you start...

- *When using a CD as the source to play —*
 - Make sure there is a CD on the selected disc number tray.
- *When using a tape as the source to play —*
 - Make sure that a tape is in the deck whose deck indicator (A or B) is lit on the display.
 - Make sure that the tape direction is correct.





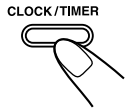

On the unit ONLY:

1 Press CLOCK/TIMER.

 indicator lights up and DAILY (Daily Timer) indicator also starts flashing on the display.





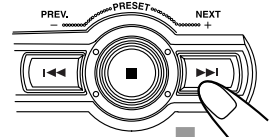

2 Set the on-time you want the unit to turn on at.

- 1) Press  or  to set the hour, then press CLOCK/TIMER.
- 2) Press  or  to set the minute, then press CLOCK/TIMER.



3 Set the off-time you want the unit to turn off (on standby) at.

- 1) Press  or  to set the hour, then press CLOCK/TIMER.
 - 2) Press  or  to set the minute, then press CLOCK/TIMER.
- The unit enters source selecting mode.



4 Select the timer (Daily Timer or Recording Timer) with the source to play.

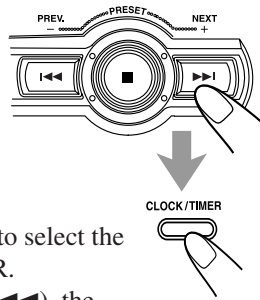

On the unit:

Press **PREV.** or **NEXT** to select the timer, then press **CLOCK/TIMER**.

- Each time you press (**PREV.**) or (**NEXT**), the timer mode and the source change as follows:

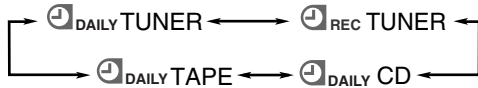

DAILY TUNER: Tunes in to the last station you were listening to. (Daily Timer)

REC TUNER : Records the last station you were listening to. (Recording Timer).

- Put a recordable cassette into the deck.

DAILY CD : Plays a disc. (Daily Timer)

- Load a disc.

DAILY TAPE : Plays a tape. (Daily Timer)

- Make sure that the tape is in the cassette deck.
- Make sure that the tape direction is correct.

The unit enters the volume level setting mode.

5 Select the volume level.

On the unit:

Press **PREV.** or **NEXT** to set the volume level, then press **CLOCK/TIMER**.

- You can select the volume level (“VOLUME --” and “VOLUME 0” to “VOLUME 30”).

If you select “VOLUME--,” the volume is set to the previous level when the unit was turned off.

- To turn off the volume while the Recording Timer (**REC TUNER**) is working, set the volume level “VOLUME 0”.

The unit enters the clock setting mode.

6 Adjust the clock if you need.

- See "Setting the Clock" on page 9.

7 Press **STANDBY/ON** (or **STANDBY/ON** on the unit) to turn off the unit (standby) if you have set the timer with the unit turned on.



- When the timer turns on the unit, the  (timer) indicator starts flashing. (If the Recording Timer is selected in step 4, the REC indicator also starts flashing.)

To deactivate the timer temporarily, press and hold **CLOCK/TIMER** on the unit until the  (timer) indicator on the display goes off.

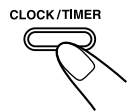

To activate or change the timer (with the previous setting), follow steps 1 to 7 on pages 28 and 29

- If you want to change the timer setting after the Daily Timer has been set, deactivate the timer then set it again.



- **If the unit is turned on when the on-time comes**
Timer does not work.
- **Even if you unplug the power cord or if a power failure occurs**
The timer will be cancelled. You need set the clock first, then the timer again.

Using Sleep Timer

With Sleep Timer, you can fall asleep to music. You can set Sleep Timer only while the unit is turned on.

How Sleep Timer actually works

The unit automatically turns off after the specified time length passes.

On the remote control ONLY:

1 Press SLEEP.

The time length until the shut-off time appears and the SLEEP indicator lights up on the display.

- Each time you press the button, the time length changes as follows:

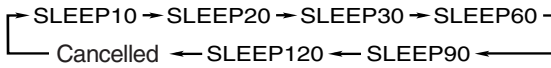

2 Wait for about 5 seconds after specifying the time length.

To check the remaining time until the shut-off time, press SLEEP once so that the remaining time until the shut-off time appears for about 5 seconds.

To change the shut-off time, press SLEEP repeatedly until the desired time length appears on the display.

To cancel the setting, press SLEEP repeatedly so that the SLEEP indicator goes off.

- Sleep Timer is also cancelled when you turn off the unit.



- **If you set the Sleep Timer after the Daily Timer starts playing the selected source**
The Daily Timer is cancelled. When the Sleep Timer shut-off time comes, the unit will turned off.
- **If you set the Sleep Timer after the recording Timer starts recording**
The Recording Timer is cancelled, but recording continues until the Sleep Timer shuts off the power.
- **If the unit is turned on when on-time comes**
Timer does not work.
- **When you unplug the power cord or if a power failure occurs**
The timer will be cancelled. You need to set the clock first, then the timer again.

Maintenance



To get the best performance of the unit, keep your discs, tapes, and mechanism clean.

Handling discs



- Remove the disc from its case by holding it at the edge while pressing the center hole lightly.
- Do not touch the shiny surface of the disc, or bend the disc.
- Put the disc back in its case after use to prevent warping.

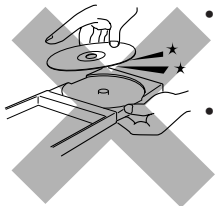

- Be careful not to scratch the surface of the disc when placing it back in its case.
- Avoid exposure to direct sunlight, temperature extremes, and moisture.

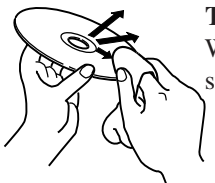

To clean the disc

Wipe the disc with a soft cloth in a straight line from center to edge.



DO NOT use any solvent — such as conventional record cleaner, spray, thinner, or benzine — to clean the disc.

Handling cassette tapes

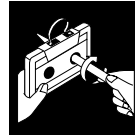

- If the tape is loose in its cassette, take up the slack by inserting a pencil in one of the reels and rotating.
- If the tape is loose, it may get stretched, cut, or caught in the cassette.



- Be careful not to touch the tape surface.



- Avoid the following places to store the tape:
 - In dusty places
 - In direct sunlight or heat
 - In moist areas
 - Near a magnet

Cleaning the unit

• Stains on the unit

Should be wiped off with a soft cloth. If the unit is heavily stained, wipe it with a cloth soaked in water-diluted neutral detergent and wrung well, then wipe clean with a dry cloth.

• Since the unit may deteriorate in quality, become damaged or suffer surface wear, be careful about the following:

- DO NOT wipe it with a hard cloth.
- DO NOT wipe it with excessive force.
- DO NOT wipe it with thinner or benzine.
- DO NOT apply any volatile substance such as insecticides to it.
- DO NOT allow any rubber or plastic to remain in contact with it for a long time.

Troubleshooting

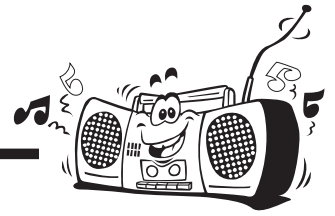

If you have a problem with your unit, check this list for a possible solution before calling for service.

If you cannot solve the problem from the hints given here, or the unit has been physically damaged, call a qualified person, such as your dealer, for service.

| Symptom | Cause | Action |
|---|--|--|
| Unable to cancel the display demonstration. | Other buttons are pressed to cancel the display demonstration. | Press CANCEL/DEMO on the unit. (See page 8.) |
| No sound is heard. | Connections are incorrect or loose. | Check all connections and make corrections. (See pages 6 to 8.) |
| Hard to listen to broadcasts because of noise. | <ul style="list-style-type: none"> Antennas are disconnected. The AM loop antenna is too close to the unit. The FM antenna is not properly extended and positioned. | <ul style="list-style-type: none"> Reconnect the antennas correctly and securely. Change the position and direction of the AM loop antenna. Extend the FM antenna at the best position. |
| The disc sound is discontinuous. | The disc is scratched or dirty. | Clean or replace the disc. (See page 31.) |
| The disc tray does not open or close. | <ul style="list-style-type: none"> The AC power cord is not plugged in. Tray is locked. | <ul style="list-style-type: none"> Plug the AC power cord. Unlock the tray. (See page 16.) |
| The disc does not play. | The disc is placed upside down. | Place the disc with the label side up. |
| The cassette holders cannot be opened. | Power supply from the AC power cord has been cut off while the tape was running. | Turn on the unit. |
| Impossible to record. | Small tabs on the back of the cassette are removed. | Cover the holes with adhesive tape. |
| Stereo effect is lost. | Karaoke is activated. | Cancel the Karaoke. (See page 26.) |
| Operations are disabled. | The built-in microprocessor may have malfunctioned due to external electrical interference. | Unplug the AC power cord and then plug it back in. |
| Unable to operate the unit from the remote control. | <ul style="list-style-type: none"> The path between the remote control and the remote sensor on the unit is blocked. The batteries are exhausted. | <ul style="list-style-type: none"> Remove the obstruction. Replace the batteries. |

Specifications

Design and specifications are subject to change without notice.

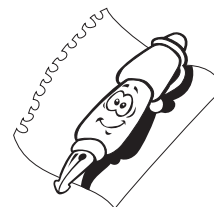

CA-MXSK3

Amplifier section

Output Power

- MAIN SPEAKERS: 80 W per channel, min. RMS, both channels driven into 6 Ω at 1 kHz with no more than 0.9% total harmonic distortion.
- SURROUND SPEAKER: 20 W per channel, min. RMS, both channels driven into 16 Ω at 1 kHz with no more than 0.9% total harmonic distortion.

Audio input sensitivity/Impedance

(Measured at 1 kHz, with tape recording signal 300 mV)

AUX: 400 mV/50 k Ω

MIC: 3 mV/10 k Ω

Tuner

FM tuning range: 87.50 MHz – 108.00 MHz

AM tuning range:

For Saudi Arabia:

At 9 kHz intervals: 531 kHz – 1 602 kHz

At 10 kHz intervals: 530 kHz – 1 600 kHz

For other countries:

At 9 kHz intervals: 531 kHz – 1 710 kHz

At 10 kHz intervals: 530 kHz – 1 710 kHz

CD player

CD capacity: 3 CDs

Dynamic range: 85 dB

Signal-to-noise ratio: 90 dB

Wow and flutter: Immeasurable

Cassette deck

Frequency response

Normal (type I): 50 Hz — 14 000 Hz

Wow and flutter: 0.15% (WRMS)

General

Power requirement: AC 110 V / AC 127 V / AC 220 V /
AC 230 V – AC 240 V \sim
(adjustable with the voltage selector),
50 Hz / 60 Hz

Power consumption: 110 W (at operation)
20 W (on standby)

Dimensions (approx.): 270 mm x 306 mm x 433.5 mm (W/H/D)

Mass (approx.): 9.3 kg

Supplied accessories

See page 6.

Speaker Specifications: SP-XSK3 (Main Speaker)

Type: 3-Way 3 Speaker Bass-Reflex
(Magnetically-Shielded Type)

Speakers

Main woofer : 15cm cone x 1
Mid Range : 5.0cm cone x 1
Tweeter : 2.0cm dome x 1

Power Handling Capacity

Main Speaker : 100 W

Impedance

Main Speaker : 6 Ω

Frequency Range

Main Speaker : 42 Hz – 30 000Hz

Sound Pressure Level

Main Speaker : 84 dB/W.m

Dimensions (W x H x D)

Main Speaker : 215mm x 306 mm x 243 mm

Mass

Main Speaker : 3.4 kg

Design and specifications subject to change without notice.

Speaker Specifications: SP-XSSK3 (Surround Speaker)

Type: Full range bass-reflex type

Speakers

Full range : 8cm cone x 1

Power Handling Capacity

: 30 W

Impedance

: 16 Ω

Frequency Range

: 85 Hz – 20 000Hz

Sound Pressure Level

: 83 dB/W.m

Dimensions (W x H x D)

: 160mm x 110 mm x 136 mm

Mass

: 0.55 kg

Design and specifications subject to change without notice.

CA-MXSK1**Amplifier section**

Output Power

MAIN SPEAKERS: 64 W per channel, min. RMS, both channels driven into 6 Ω at 1 kHz with no more than 0.9% total harmonic distortion.

Audio input sensitivity/Impedance

(Measured at 1 kHz, with tape recording signal 300 mV)

AUX: 400 mV/50 k Ω MIC: 3 mV/10 k Ω **Tuner**

FM tuning range: 87.50 MHz – 108.00 MHz

AM tuning range:

For Saudi Arabia:

At 9 kHz intervals: 531 kHz – 1 602 kHz

At 10 kHz intervals: 530 kHz – 1 600 kHz

For other countries:

At 9 kHz intervals: 531 kHz – 1 710 kHz

At 10 kHz intervals: 530 kHz – 1 710 kHz

CD player

CD capacity: 3 CDs

Dynamic range: 85 dB

Signal-to-noise ratio: 90 dB

Wow and flutter: Immeasurable

Cassette deck

Frequency response

Normal (type I): 50 Hz — 14 000 Hz

Wow and flutter: 0.15% (WRMS)

General

Power requirement: AC 110 V / AC 127 V / AC 220 V / AC 230 V – AC 240 V \sim
(adjustable with the voltage selector),
50 Hz / 60 Hz

Power consumption: 100 W (at operation)
20 W (on standby)

Dimensions (approx.): 270 mm x 306 mm x 433.5 mm (W/H/D)

Mass (approx.): 9.2 kg

Supplied accessories

See page 6.

Speaker Specifications: SP-MXSK1

Type: 3-Way 3 Speaker Bass-Reflex
(Magnetically-Shielded Type)

Speakers

Main woofer : 15cm cone x 1

Mid Range : 5.0cm cone x 1

Tweeter : 2.0cm dome x 1

Power Handling Capacity : 80 W

Impedance : 6 Ω

Frequency Range : 42 Hz – 30 000Hz

Sound Pressure Level : 84 dB/W.m

Dimensions (W x H x D) : 215mm x 306 mm x 243 mm

Mass : 3.4 kg

Design and specifications subject to change without notice.

Mains (AC) Line Instruction (not applicable for Europe, U.S.A., Canada, Australia, and U.K.)

主（AC）电源线路说明（不适用于欧洲、美国、加拿大、澳洲及英国型号）

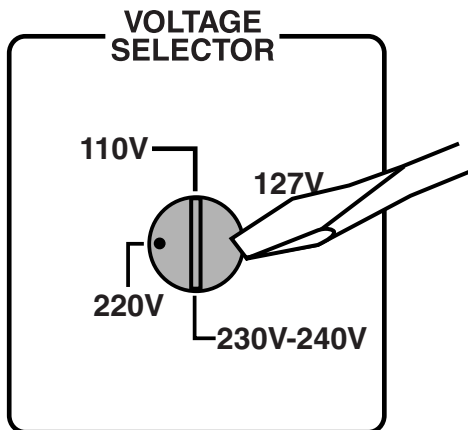

IMPORTANT for mains (AC) line

BEFORE PLUGGING IN, do check that your mains (AC) line voltage corresponds with the position of the voltage selector switch provided on the outside of this equipment and, if different, reset the voltage selector switch, to prevent from damage or risk of fire/electric shock.

有关主（AC）电源线路的重要事项

接插电源以前，务请检查当地的主(AC)电源线路电压是否和位于本机外面的电压选择开关设定的位置一致。如果不一致，即重新设定电压选择开关，以免损坏机器或引起火灾/触电的危险。

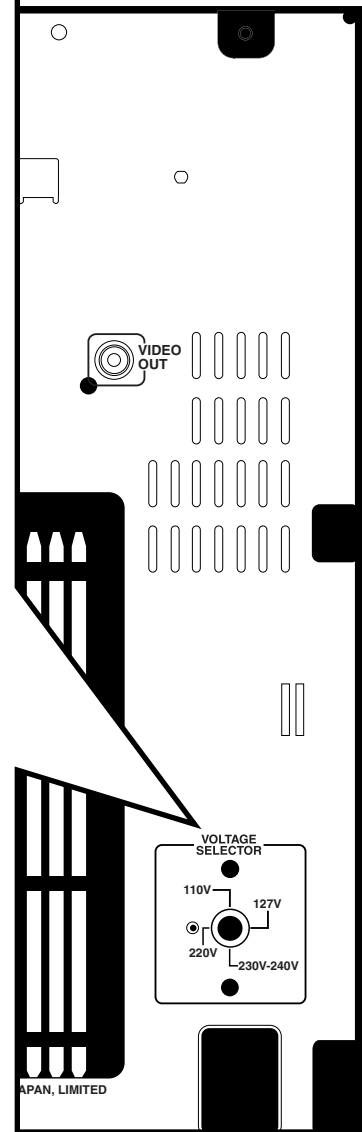

JVC

VICTOR COMPANY OF JAPAN, LIMITED

JVC

English

فارسی

عربي

COMPACT COMPONENT SYSTEM

سیستمی با اجزای فشرده
نظام اجهزة صوتية مركبة

MX-SK3 — Consists of CA-MXSK3 and SP-MXSK3

شامل **CA-MXSK3** و **SP-MXSK3**
يتكون الجهازين **CA-MXSK3** و **SP-MXSK3**

MX-SK1 — Consists of CA-MXSK1 and SP-MXSK1

شامل **CA-MXSK1** و **SP-MXSK1**
يتكون الجهازين **CA-MXSK1** و **SP-MXSK1**

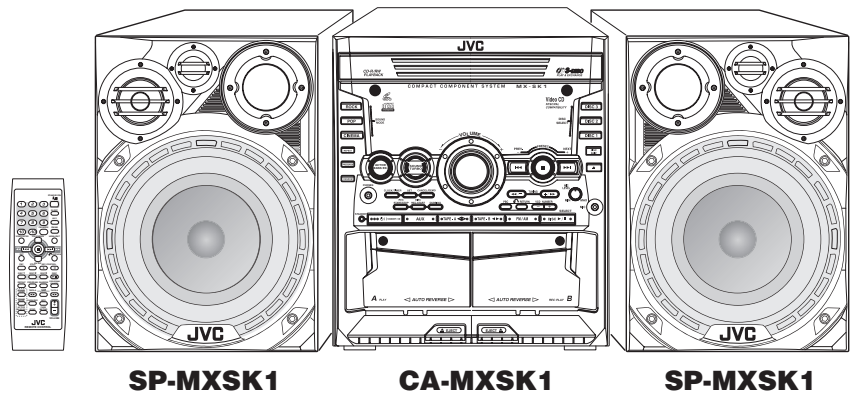
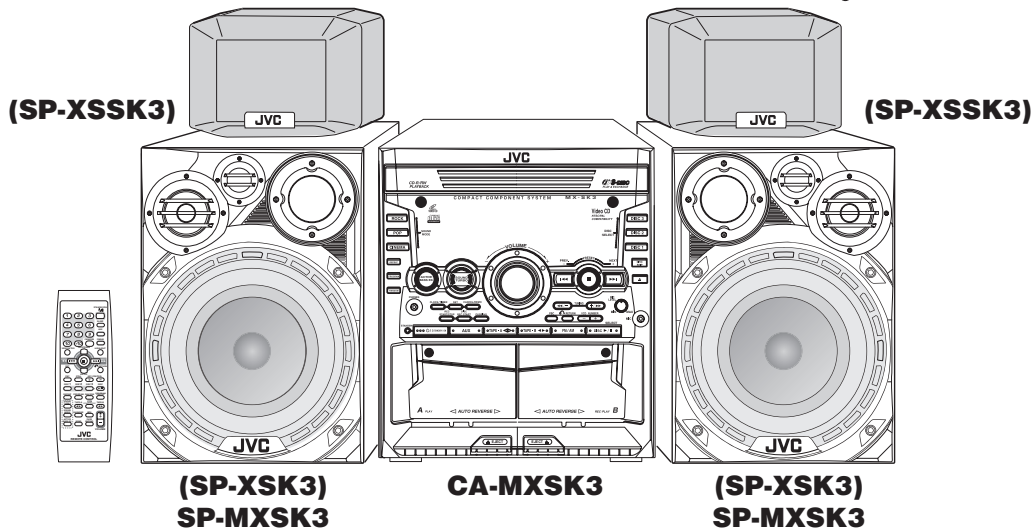

INSTRUCTIONS

دستور العمل استفاده
کتاب تعليمات التشغيل

COMPACT
disc
DIGITAL VIDEO

COMPACT
disc
DIGITAL AUDIO

Warnings, Cautions and Others

هشدارها، احتیاطها و سایر موارد

تحذیرات، تنبیهات و اشیاء أخرى

CAUTION — ϕ /I button!

Disconnect the mains plug to shut the power off completely (the STANDBY/ON lamp goes off). The ϕ /I button in any position does not disconnect the mains line.

- When the unit is on standby, the STANDBY/ON lamp lights red.
- When the unit is turned on, the STANDBY/ON lamp lights green.

The power can be remote controlled.

احتیاط

- برای کاهش خطر برق گرفتگی، آتش سوزی و غیره:
۱. بیج ها، پوشش ها یا اطاقک دستگاه را باز نکنید.
 ۲. این وسیله را در معرض باران یا رطوبت قرار ندهید.

تحذیر

- لتقلیل خطر الصدمات الكهربائية، الحرق، الخ:
۱. لا تفك البراغي او الاغطية او الخزانة.
 ۲. لا تعرض هذا الجهاز للمطر او الرطوبة.

CAUTION

To reduce the risk of electrical shocks, fire, etc.:

1. Do not remove screws, covers or cabinet.
2. Do not expose this appliance to rain or moisture.

احتیاط — دکمه ϕ /I !

- برای خاموش کردن کامل دستگاه، دوشاخه برق اصلی را از پریز خارج کنید. (لامپ حالت انتظار/روشن STANDBY/ON خاموش می شود). دکمه ϕ /I در هیچ شرایطی خط برق اصلی را قطع نمی کند.
- وقتی دستگاه در حالت انتظار است، لامپ حالت انتظار/روشن STANDBY/ON به رنگ قرمز است.
 - وقتی دستگاه روشن است، لامپ حالت انتظار/روشن STANDBY/ON به رنگ سبز است.

برق دستگاه از دور قابل کنترل است.

تحذیر — زر توصیل الطاقة الكهربائية - ϕ /I

- افصل قابس الطاقة الكهربائية الرئيسية لفصل الطاقة الكهربائية كلياً عن الجهاز. (تنظفئ لمبة توصیل الطاقة الكهربائية/الاستعداد للتشغيل STANDBY/ON). لا يفصل زر توصیل الطاقة ϕ /I ولا باي وضع من الاوضاع خط الطاقة الكهربائية عن الجهاز.
- عندما يكون الجهاز في وضع الاستعداد للتشغيل، تضيء لمبة توصیل الطاقة الكهربائية/الاستعداد للتشغيل STANDBY/ON باللون الاحمر.
 - عندما يكون الجهاز في وضع تشغيل، تضيء لمبة توصیل الطاقة الكهربائية/الاستعداد للتشغيل STANDBY/ON باللون الاخضر.

يمكن التحكم عن بعد بالطاقة الكهربائية.

CAUTION

- Do not block the ventilation openings or holes. (If the ventilation openings or holes are blocked by a newspaper or cloth, etc., the heat may not be able to get out.)
- Do not place any naked flame sources, such as lighted candles, on the apparatus.
- When discarding batteries, environmental problems must be considered and local rules or laws governing the disposal of these batteries must be followed strictly.
- Do not expose this apparatus to rain, moisture, dripping or splashing and that no objects filled with liquids, such as vases, shall be placed on the apparatus.

احتیاط

- چشمه ها و سوراخ های تهویه هوا را مسدود نکنید.
- (اگر چشمه ها و سوراخ های تهویه هوا با روزنامه و یا پارچه و غیره مسدود شود، هوای گرم نمی تواند خارج شود.)
- از گذاشتن هرگونه وسیله شعله دار بدون محافظ مانند شمع روشن بر روی دستگاه خودداری کنید.
- در زمان دورانداختن باتری ها مسایل زیست محیطی باید مورد توجه قرار گیرد و مقررات محلی و قوانین حاکم بر دفع این گونه باتری ها باید به طور اکید مراعات شود.
- این دستگاه را در معرض باران، رطوبت، چکه آب یا پاشیدن آب قرار ندهید و هیچ گونه وسیله محتوی آب مانند گلدان را بر روی آن نگذارید.

تحذیر

- لا تغلق فتحات التهوية او الثقوب.
- (في حالة اغلاق فتحات التهوية او الثقوب بواسطة ورق الصحف او القماش، الخ، فانه يمكن ان لا تخرج الحرارة للخارج.)
- لا تضع اية مصادر حرارية مكشوفة، مثل الشموع المضيئة، على الجهاز.
- عند اتلاف البطاريات، يجب اخذ مشاكل البيئية بعين الاعتبار ويجب التقيد بالانظمة المحلية او القوانين التي تحكم اتلاف هذه البطاريات بصورة دقيقة.
- لا تعرض هذا الجهاز للمطر، او الرطوبة، او تنقيط او رشق الماء ولا تضع اي اوعية مملوءة بالسوائل مثل مزهریات الورد فوق هذا الجهاز.

CAUTION

To avoid personal injury or accidentally dropping the unit, have two persons unpack, carry and install the unit.



MX-SK1: 18.7 kg

MX-SK3: 20.0 kg

احتیاط!

برای اجتناب از آسیب شخصی یا افتادن اتفاقی دستگاه، دو نفری بسته بندی این دستگاه را باز کرده، آن را حمل و نصب نمایید.

تحذیر!

لتجنب خطر الجروح الشخصية او اسقاط الجهاز عفوياً، يجب على شخصين اثنين القيام باعمال اخراج الجهاز من التغليف وحمل وتركيب الجهاز.

Caution: Proper Ventilation

To avoid risk of electric shock and fire, and to prevent damage, locate the apparatus as follows:

- 1 Front: No obstructions and open spacing.
- 2 Sides/ Top/ Back: No obstructions should be placed in the areas shown by the dimensions below.
- 3 Bottom: Place on the level surface. Maintain an adequate air path for ventilation by placing on a stand with a height of 10 cm or more.

احتياط: تهويه مناسب

- برای اجتناب از خطر برق گرفتگی و آتش سوزی و برای احتراز از آسیب دیدگی، دستگاه را در وضعیت زیر قرار دهید:
- ۱ جلو: بدون مانع و فضای باز.
 - ۲ دو سمت/ بالا/ پشت: هیچ مانعی نباید در محل هایی به فواصل نشان داده شده در زیراز دستگاه قرار داده شود.
 - ۳ زیر: بر روی سطح تراز قرار داده شود. با گذاشتن دستگاه بر روی یک پایه با ارتفاع ۱۰ سانتیمتر یا بیشتر مسیر هوای مناسبی را برای تهویه به وجود آورید.

تحذیر: التهوية الصحيحة

- لتجنّب حصول صدمات كهربائية و اخطار الحريق ومنع حصول تلف و ضرر للجهاز، ركبّ الجهاز كما يلي:
- ۱ الجهة الامامية: يجب ان لا يكون هنالك عوائق ويجب ان تكون المنطقة مفتوحة امام الجهاز.
 - ۲ الجهات الجانبية/العلوية/الخلفية: يجب عدم وضع عوائق في المناطق المبينة بالابعاد في الاسفل.
 - ۳ القاعدة: يجب وضع الجهاز علي سطح منبسط. اترك مسافة كافية من اجل التهوية بواسطة وضع الجهاز علي حامل بارتفاع ۱۰ سم او اكثر.

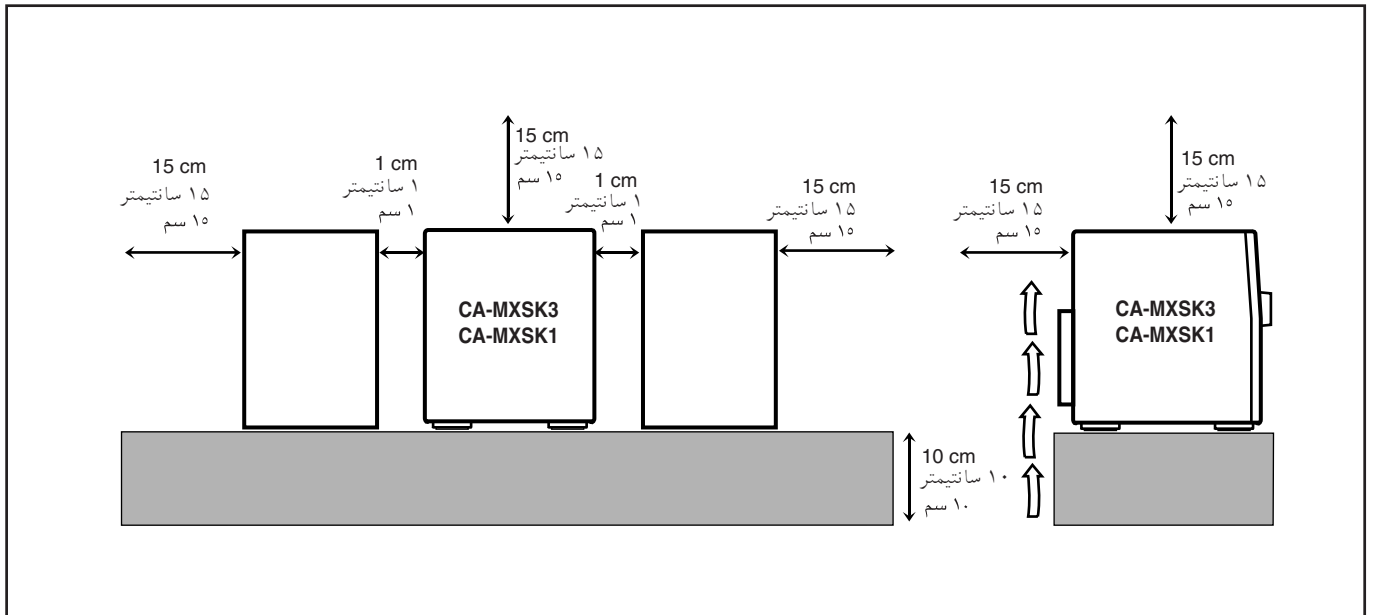

IMPORTANT FOR LASER PRODUCTS

1. CLASS 1 LASER PRODUCT
2. **CAUTION:** Do not open the top cover. There are no user serviceable parts inside the unit; leave all servicing to qualified service personnel.
3. **CAUTION:** Visible and invisible laser radiation when open and interlock failed or defeated. Avoid direct exposure to beam.
4. REPRODUCTION OF LABEL: CAUTION LABEL, PLACED INSIDE THE UNIT.

نکته مهم برای محصولات دارای اشعه لیزر

۱. محصول لیزری کلاس ۱
۲. احتیاط: پوشش فوقانی را باز نکنید. هیچگونه بخش قابل تعمیر توسط کاربر داخل دستگاه وجود ندارد. تمام کارهای تعمیر را به افراد تعمیرکار مجرب واگذار کنید.
۳. احتیاط: اگر دستگاه باز و قفل ایمنی دستگاه از کار افتاده یا خراب شود تشعشع لیزر مرئی و نامرئی را در پی خواهد داشت. از قرار گرفتن در معرض مستقیم تابش اشعه خودداری کنید.
۴. نسخه اصلی برچسب: برچسب احتیاط داخل دستگاه نصب شده است.

هام للمنتجات الليزرية

۱. صنف ۱ منتج ليزري
۲. تحذير: لا تفتح الغطاء العلوي، لا يوجد اقسام يستطيع المستخدم صيانتها او تصليحها داخل هذا الجهاز؛ اترك جميع اعمال الصيانة والتصليح للفنيين المؤهلين والمختصين.
۳. تحذير: هناك اشعة ليزرية مرئية وغير مرئية عند فتح الاغطية او العبث باقفال الامان. تجنب التعرض المباشر للاشعة.
۴. النسخة الاصلية الملصق التحذير: ملصق التحذير، موجود خارج الجهاز.

| | |
|--|--|
| CAUTION : Visible and invisible laser radiation when open and interlock failed or defeated. AVOID DIRECT EXPOSURE TO BEAM. (e) | WARNING : Synlig och osynlig laserstrålning när den öppnas och spärren är urkopplad. Betrakta ej strålen. (s) |
| ADVARSEL : Synlig og usynlig laserstråling når maskinen er åben eller interlocken fejler. Undgå direkte eksponering til stråling. (d) | VARO : Avattaessa ja suojalukitus ohitettuna tai viallisena olet alttiina näkyväle ja näkymättömälle lasersäteilylle. Vältä säteen kohdistumista suoraan itseesi. (f) |

Introduction

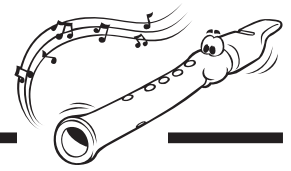

We would like to thank you for purchasing one of our JVC products. Before operating this unit, read this manual carefully and thoroughly to obtain the best possible performance from your unit, and retain this manual for future reference.

About This Manual

This manual is organized as follows:

- The manual mainly explains operations using the buttons and controls on the unit. You can also use the buttons on the remote control if they have the same or similar names (or marks) as those on the unit. If operation using the remote control is different from that using the unit, it is then explained.
- Basic and common information that is the same for many functions is grouped in one place, and is not repeated in each procedure. For instance, we do not repeat the information about turning on/off the unit, setting the volume, changing the sound effects, and others, which are explained in the section “Common Operations” on pages 9 to 11.
- The following marks are used in this manual:



Gives you warnings and cautions to prevent from damage or risk of fire/electric shock. Also gives you information which is not good for obtaining the best possible performance from the unit.



Gives you information and hints you had better know.

Precautions

Installation

- Install in a place which is level, dry and neither too hot nor too cold — between 5°C (41°F) and 35°C (95°F).
- Install the unit in a location with adequate ventilation to prevent internal heat buildup in the unit.
- Leave sufficient distance between the unit and the TV.
- Keep the speakers away from the TV to avoid interference with TV.



DO NOT install the unit in a location near heat sources, or in a place subject to direct sunlight, excessive dust or vibration.

Power sources

- When unplugging from the wall outlet, always pull the plug, not the AC power cord.



DO NOT handle the AC power cord with wet hands.

Moisture condensation

Moisture may condense on the lens inside the unit in the following cases:

- After starting heating in the room
 - In a damp room
 - If the unit is brought directly from a cold to a warm place
- Should this occur, the unit may malfunction. In this case, leave the unit turned on for a few hours until the moisture evaporates, unplug the AC power cord, and then plug it in again.

Others

- Should any metallic object or liquid fall into the unit, unplug the unit and consult your dealer before operating any further.
- If you are not going to operate the unit for an extended period of time, unplug the AC power cord from the wall outlet.



DO NOT disassemble the unit since there are no user serviceable parts inside.

If anything goes wrong, unplug the AC power cord and consult your dealer.

Which compact discs can be used?

Many types of compact discs are sold for a variety of uses. The player can play the following compact discs:

Video CD discs both with and without PBC

Audio CD discs



Discs you cannot playback

Any other discs than listed above (such as CD-ROM, DVD, CD-G or CD-I Discs) cannot be played. Playing back such discs may generate noise and damage your speakers. Even though a logo listed above is printed on the disc, it may not be played if it is a non-standard disc.

Contents

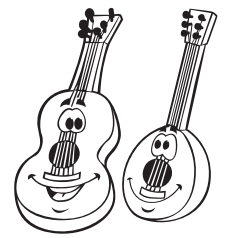

| | | | |
|---|-----------|---|-----------|
| Location of the Buttons and Controls | 3 | MP3 Disc Playback | 21 |
| Remote Control | 3 | Basic operations | 21 |
| Front Panel | 4 | Programming tracks | 21 |
| Getting Started | 6 | Playing Back Tapes | 23 |
| Supplied Accessories | 6 | Playing Back a Tape | 23 |
| Putting the Batteries into the Remote Control | 6 | Recording | 24 |
| Connecting Antennas | 6 | Recording a Tape on Deck B | 24 |
| Connecting Speakers | 7 | Dubbing Tapes | 25 |
| Surround Speakers | 8 | CD Direct Recording | 25 |
| Connecting Other Equipment | 8 | Using the Microphones | 26 |
| Adjusting the Voltage Selector | 8 | Singing along — Karaoke | 26 |
| Cancelling the Display Demonstration | 8 | Singing Along with Multiplex Karaoke Discs (MPX) | 26 |
| Common Operations | 9 | Recording Your Singing | 27 |
| Turning On or Off the Power | 9 | Adjusting the Music Key Control (for CD play only) | 27 |
| Setting the Clock | 9 | Using the Timers | 28 |
| Setting the AM Tuner Interval Spacing | 9 | Using Daily Timer and Recording timer | 28 |
| Selecting the Sources | 10 | Using Sleep Timer | 30 |
| Adjusting the Volume | 10 | Maintenance | 31 |
| Reinforcing the Bass Sound (ACTIVE BASS EX.) | 10 | Troubleshooting | 32 |
| Emphasizing the sound (SOUND TURBO) | 10 | Specifications | 33 |
| Selecting the Sound Modes | 11 | | |
| Listening to FM and AM Broadcasts | 12 | | |
| Tuning in a Station | 12 | | |
| Presetting Stations | 12 | | |
| Tuning in a Preset Station | 12 | | |
| Playing Back CDs (CD/CD-R/CD-RW) | 13 | | |
| Loading CDs | 13 | | |
| Playing Back the Entire Discs — Continuous Play | 14 | | |
| Basic CD Operations | 14 | | |
| Programming the Playing Order of the Tracks — Program Play | 15 | | |
| Playing at Random — Random Play | 16 | | |
| Repeating Tracks or CDs — Repeat Play | 16 | | |
| Prohibiting Disc Ejection — Tray Lock | 16 | | |
| Playing Back Video CDs | 17 | | |
| Selecting Video Output (PAL, PAL AUTO, NTSC) ... | 17 | | |
| Loading Discs | 17 | | |
| Playing a Video CD | 17 | | |
| Playing Video CDs with PBC Function — Menu Play | 18 | | |
| Basic Concept of the PBC function | 18 | | |
| Playing Video CDs without PBC — Continuous Play | 19 | | |
| Resuming Play | 19 | | |
| Special Plays for a Video CD | 19 | | |
| Playing a Multiplex Sound CD | 20 | | |

Location of the Buttons and Controls



Remote Control

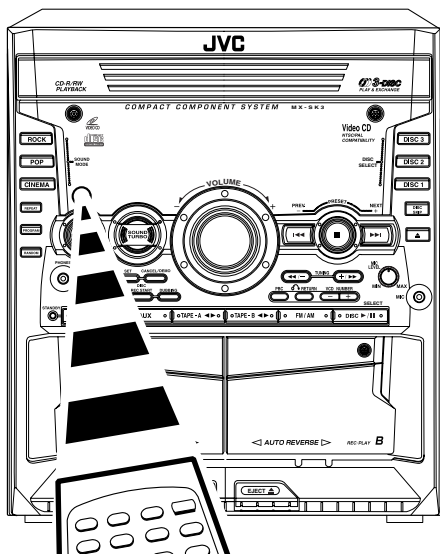
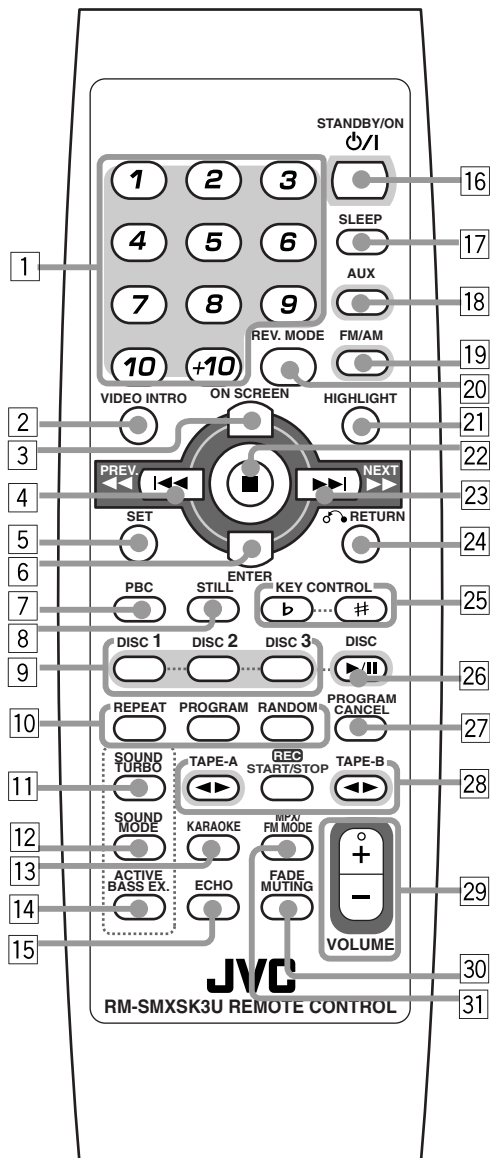

When using the remote control, point it at the remote sensor on the front panel.

Remote Control

See pages in the parentheses for details.

- 1 Number buttons (12, 14 – 15, 18 – 21)
- 2 VIDEO INTRO button (19)
- 3 ON SCREEN button (19)
- 4 PREV. ◀◀ (◀◀) button (12, 14 – 15, 18 – 19, 21 – 23)
- 5 SET button (15)
- 6 ENTER button (21)
- 7 PBC button (18 – 19)
- 8 STILL button (19)
- 9 Disc number buttons (DISC 1, DISC 2, and DISC 3) (14 – 15, 17, 19, 21)
Pressing one of these buttons also turns on the unit.
- 10 CD play mode buttons
 - REPEAT button (16)
 - PROGRAM button (15, 21)
 - RANDOM button (16, 21)
- 11 SOUND TURBO button (10)
- 12 SOUND MODE button (11)
- 13 KARAOKE button (26)
- 14 ACTIVE BASS EX. button (10)
- 15 ECHO button (26)
- 16 STANDBY/ON ⏻/⏻ button (9, 29)
- 17 SLEEP button (30)
- 18 AUX button (10)
Pressing this button also turns on the unit.
- 19 FM/AM button (10, 12)
Pressing this button also turns on the unit.
- 20 REV. MODE button (23, 25)
- 21 HIGHLIGHT button (20)
- 22 ■ (stop) button (14 – 25, 27)
- 23 NEXT ▶▶ (▶▶) button (12, 14 – 16, 18 – 23)
- 24 ⏪ RETURN button (18)
- 25 KEY CONTROL **b** / # buttons (27)
- 26 DISC ▶/|| button (10, 14 – 19, 21)
Pressing this button also turns on the unit.
- 27 PROGRAM CANCEL button (15)
- 28 Tape operation buttons
 - TAPE-A ◀▶ button (10, 23 – 24)
Pressing this button also turns on the unit.
 - REC START/STOP button (24)
 - TAPE-B ◀▶ button (10, 23 – 24)
Pressing this button also turns on the unit.
- 29 VOLUME + and – buttons (10, 26 – 27)
- 30 FADE MUTING buttons (10)
- 31 MPX/FM MODE buttons (12, 20, 26)

Become familiar with the buttons and controls on your unit.

Front Panel

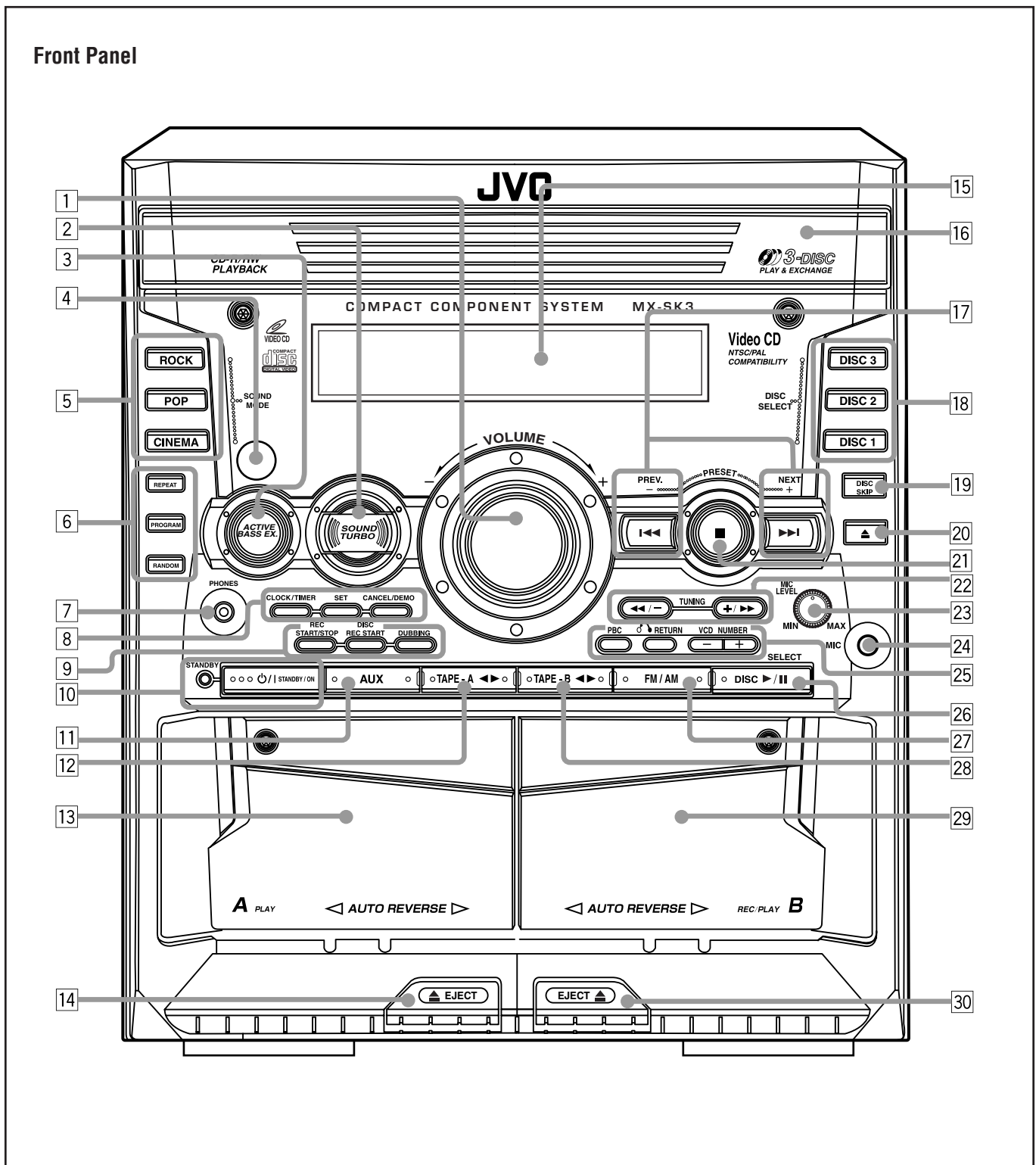

Notes:

All illustrations in this manual will be based on CA-MXSK3

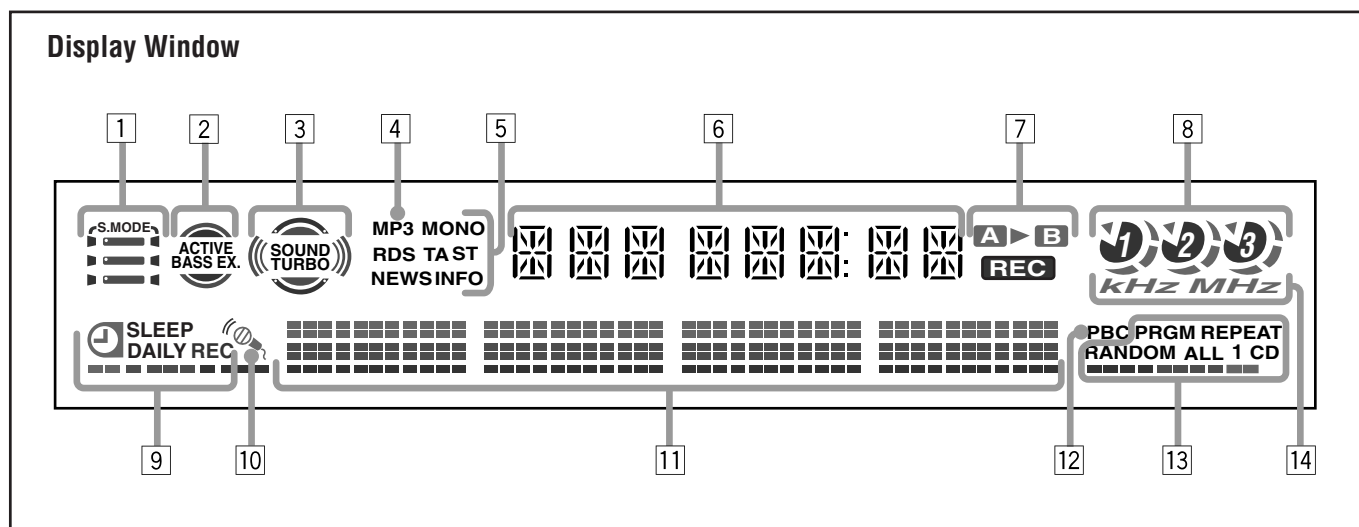

See pages in the parentheses for details.

Front Panel

- 1 VOLUME + / - control (10, 26 – 27)
- 2 SOUND TURBO button (10)
- 3 ACTIVE BASS EX. button (10)
- 4 Remote sensor
- 5 Sound mode buttons (11)
 - ROCK button
 - POP button
 - CINEMA button
- 6 CD play mode buttons
 - REPEAT button (16)
 - PROGRAM button (15, 21)
 - RANDOM button (16, 21)
- 7 PHONES jack (10)
- 8 CLOCK/TIMER button (9, 28 – 29)
SET button (9, 12, 15, 21)
CANCEL/DEMO button (8, 15, 22)
- 9 Recording buttons
 - REC START/STOP button (24)
 - DISC REC START button (25)
 - DUBBING button (25)
- 10 P/I STANDBY/ON button and STANDBY lamp (9, 16, 29)
- 11 AUX button (10)
Pressing this button also turns on the unit.
- 12 TAPE-A $\blacktriangleleft\blacktriangleright$ button (10, 23 – 24)
Pressing this button also turns on the unit.
- 13 Deck A cassette holder (23)
- 14 \blacktriangle EJECT button for deck A (23)
- 15 Display window
- 16 Disc tray
- 17 PRESET PREV. \blacktriangleleft and NEXT \blacktriangleright buttons
 \blacktriangleleft and \blacktriangleright (reverse search/forward search) buttons (9, 12, 14 – 15, 18, 21 – 22, 28 – 29)
- 18 Disc number buttons (DISC 1, DISC 2, and DISC 3) (14 – 15, 17, 19 – 20, 25)
Pressing one of these buttons also turns on the unit.
- 19 DISC SKIP button (13, 17)
- 20 \blacktriangle (Disc tray open/close) button (13 – 14, 16 – 17)
Pressing one of these buttons also turns on the unit.

- 21 \blacksquare (stop) button (14 – 25, 27)
- 22 TUNING + and – buttons (12)
 \blacktriangleleft and \blacktriangleright (fast left/fast right) buttons (14, 23)
- 23 MIC LEVEL control (26 – 27)
- 24 MIC jack (26)
- 25 Video CD buttons
 - PBC button (18 – 19)
 - \curvearrowright RETURN button (18)
 - VCD NUMBER + / - buttons (18)
- 26 DISC $\blacktriangleright/\text{II}$ SELECT (play/pause) button (10, 14 – 19, 21)
Pressing this button also turns on the unit.
- 27 FM/AM button (12)
Pressing this button also turns on the unit.
- 28 TAPE-B $\blacktriangleleft\blacktriangleright$ button (10, 23 – 24)
Pressing this button also turns on the unit.
- 29 Deck B cassette holder (23 – 24)
- 30 EJECT \blacktriangle button for deck B (23 – 24)

Display Window

- 1 S. MODE (SOUND MODE) indicator
- 2 ACTIVE BASS EX. indicator
- 3 SOUND TURBO indicator
- 4 MP3 indicator
- 5 Tuner operation indicators
 - MONO and ST (stereo) indicators
- 6 Main display
 - Shows the source name, frequency, etc.
- 7 Tape operation indicators
 - A/B (operating deck) and **REC** (recording)
- 8 Disc indicators
- 9 Timer indicators
 - ⌚ (Timer), DAILY (Daily Timer), REC (Recording Timer), and SLEEP (Sleep Timer) indicators
- 10 Karaoke (🎤) and echo (🔊) indicators
- 11 Audio level indicator
- 12 PBC indicator
- 13 CD play mode indicators
 - REPEAT (ALL/1/CD), PRGM (program), and RANDOM indicators
- 14 Radio frequency indicators
 - kHz and MHz indicators

Getting Started



Supplied Accessories

Make sure that you have all the following items. The number in the parentheses indicates the quantity of the pieces supplied.

- AM loop antenna (1)
- FM antenna (1)
- Remote control (1)
- Batteries (2)
- AC plug adaptor (1)
- Video cord (1)

If anything is missing, consult your dealer immediately.

Putting the Batteries into the Remote Control

Insert the batteries — R6(SUM-3)/AA(15F) — into the remote control, by matching the polarity (+ and -) on the batteries with the + and - markings on the battery compartment.

When the remote control can no longer operate the unit, replace both batteries at the same time.

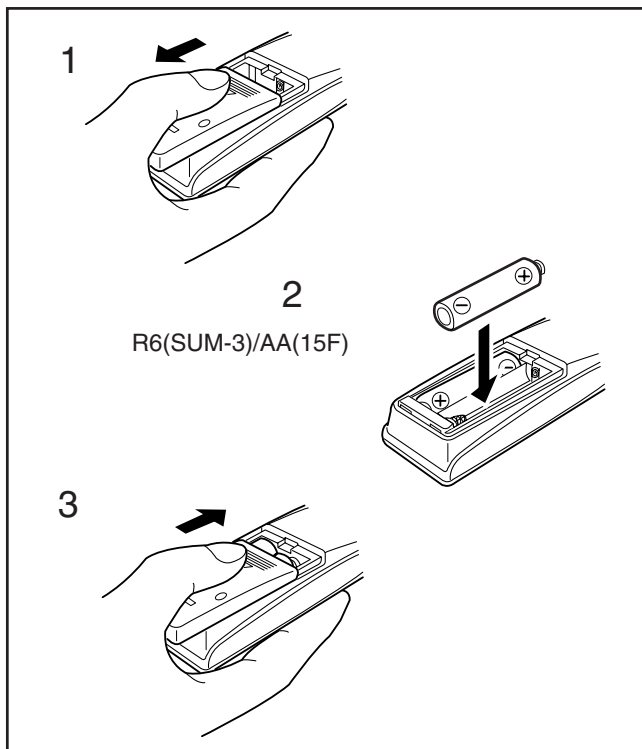

- DO NOT use an old battery together with a new one.
- DO NOT use different types of batteries together.
- DO NOT expose batteries to heat or flame.
- DO NOT leave the batteries in the battery compartment when you are not going to use the remote control for an extended period of time. Otherwise, it will be damaged from battery leakage.

Connecting Antennas

FM antenna

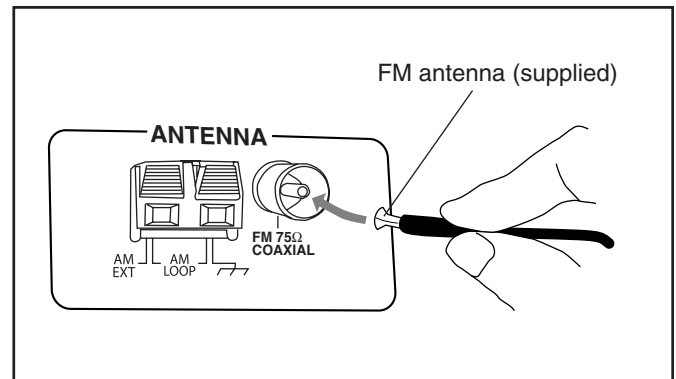

- 1 Attach the FM antenna to the FM 75 Ω COAXIAL terminal.
- 2 Extend the FM antenna.
- 3 Fasten it up in the position which gives you the best reception, then fix it on the wall, etc.



About the supplied FM antenna

The FM antenna supplied with this unit can be used as temporary measure. If reception is poor, you can connect an outdoor FM antenna.

To connect an outdoor FM antenna

Before connecting it, disconnect the supplied FM antenna.

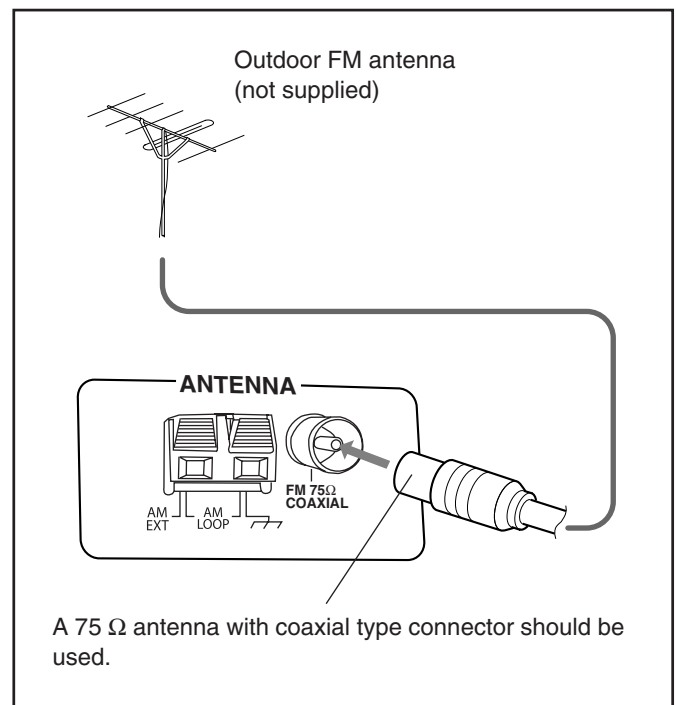

A 75 Ω antenna with coaxial type connector should be used.

AM antenna

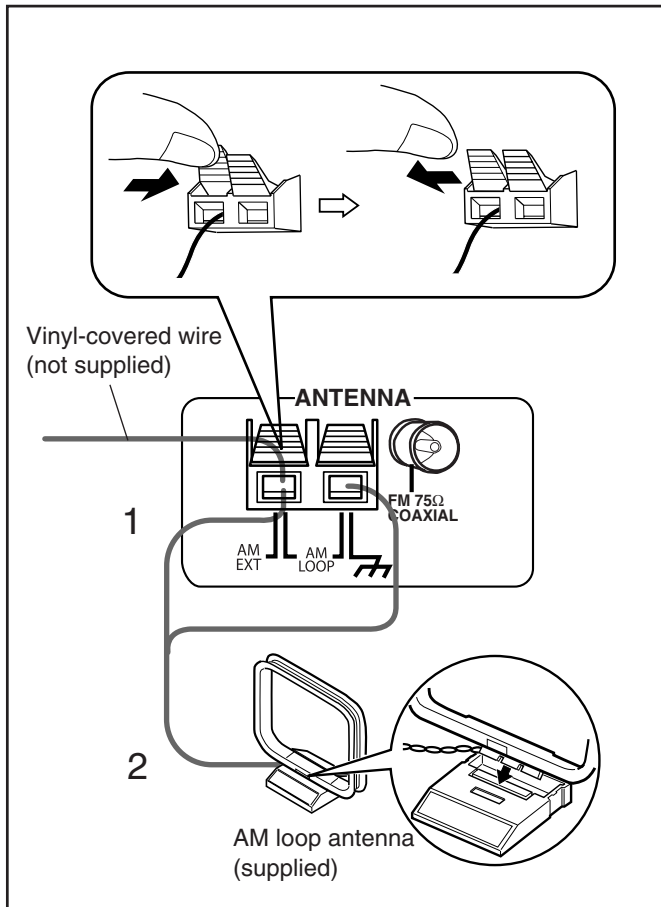

1 Connect the AM loop antenna to the AM LOOP terminals as illustrated.

- If the AM loop antenna wire is covered with vinyl, remove the vinyl by twisting it as shown in the diagram.

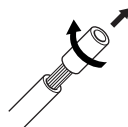

2 Turn the AM loop antenna until you have the best reception.

To connect an outdoor AM antenna

When reception is poor, connect a single vinyl-covered wire to the AM EXT terminal and extend it horizontally. The AM loop antenna must remain connected.



For better reception of both FM and AM

- Make sure the antenna conductors do not touch any other terminals and connecting cords.
- Keep the antennas away from metallic parts of the unit, connecting cords, and the AC power cord.

Connecting Speakers

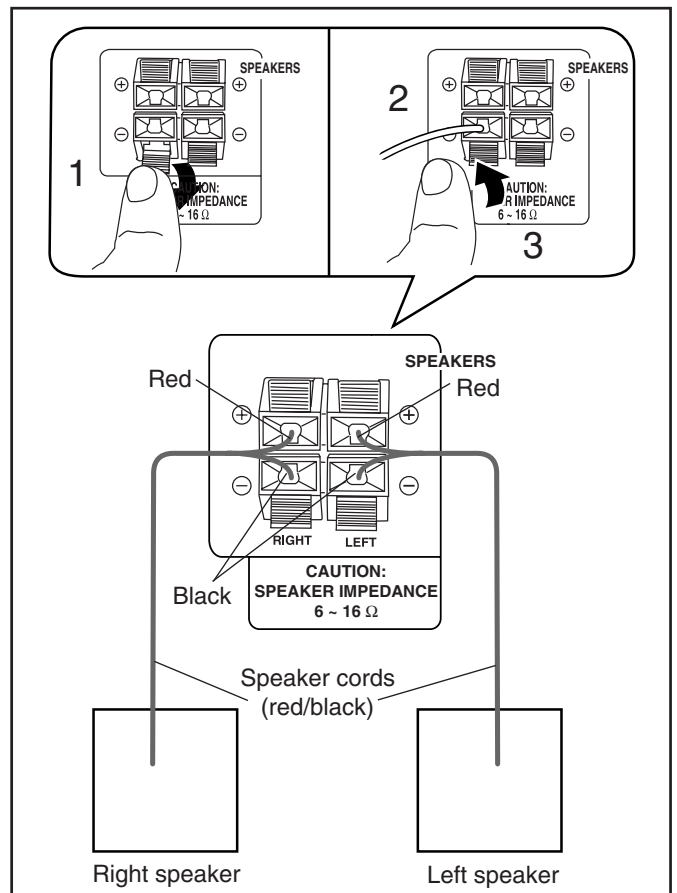

1 Press and hold the clamp of the speaker terminals on the rear of the unit.

2 Insert the end of the speaker cord into the terminal.

Match the polarity (colours) of the speaker terminals: Red (+) to red (+) and black (-) to black (-).

3 Release your finger from the clamp to close the speaker terminals.

Speaker Setting For A/V Combination

SP-MXSK3 and SP-MXSK1 have a magnetically-shielded design for placement adjacent to TV's and monitors without causing color aberrations. However, color may be affected by the way of installing the speaker system. Therefore, please take note of the following:

1. When placing these speakers near a TV set, turn off TV's main power switch or unplug it before installing the speakers. Wait at least 30 minutes after the system is installed before turning on the TV's power.
2. If another speaker system has been set up near the TV set, that system may cause color unevenness in the TV's picture.
3. In spite of the shielded design of these speakers, some of the TV types may be affected by them. If this happens, move the speakers to a short distance away from the TV set.

IMPORTANT: Use only speakers with the same speaker impedance as indicated by the speaker terminals on the rear of the unit.

Surround Speakers

For Model CA-MXSK3

To connect surround speakers.

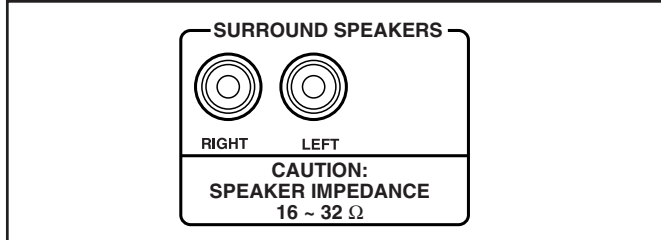

- Connect the right rear speaker to the RIGHT jack.
- Connect the left rear speaker to the LEFT jack.

How to install Surround Speakers

- This equipment is not magnet-proof. If it is placed near a TV set, color on a TV screen may become uneven. Therefore, when installing, locate the speaker at sufficient distance away from the TV set.
- When setting the speaker on a high shelf, be sure to fix them to the shelf by using metal braces: this is a precaution to avoid the speakers from falling off due to shelf trembling.

CAUTION:

The speakers are designed to be attached on the wall. Please have the qualified personnel to attach the speakers on the wall. DO NOT hang the speakers by yourself to avoid the unexpected danger whereby the speakers fall off due to incorrect attachment or unstable wall.

Connecting Other Equipment

You can connect both analog and digital equipment.



- DO NOT connect any equipment while the power is on.
- DO NOT plug in any equipment until all connections are complete.

To connect an analog component

Be sure that the plugs of the audio cords are coloured: White plugs and jacks are for left audio signals, and red ones for right audio signals.

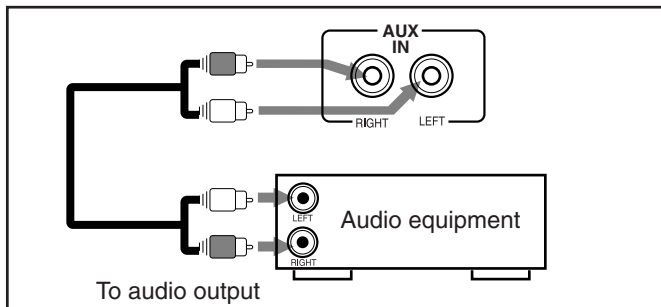

For playing the other equipment through this unit, connect between the audio output jacks on the other equipment and AUX jacks by using audio cords (not supplied).

Adjusting the Voltage Selector

Before plugging in the unit, set the correct voltage for your area with the voltage selector on the rear of the unit.

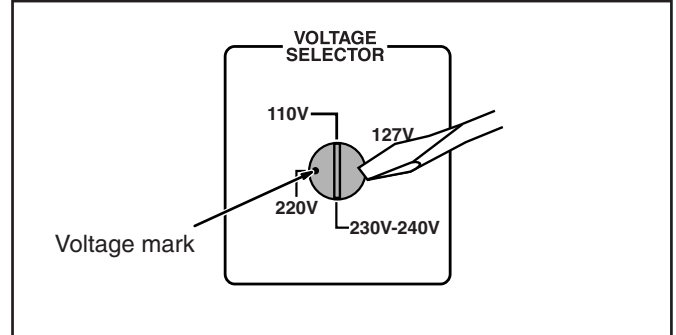

Use a screwdriver to rotate the voltage selector so the voltage number the voltage mark is pointing at is the same as the voltage where you are plugging in the unit. (See the back cover page.)



DO NOT plug in before setting the voltage selector on the rear of the unit and all connection procedures are complete.

Now, you can plug in the AC power cord.

When connecting the AC power cord to a wall outlet, the unit automatically starts display demonstration.

- If the wall outlet does not match the AC plug, use the supplied AC plug adaptor.

IMPORTANT: Be sure to check all connections to be done before plugging the AC power cord into a wall outlet.

Cancelling the Display Demonstration

On the unit ONLY:

To cancel the display demonstration, press CANCEL/DEMO during demonstration, "DEMO OFF" will appear on the display.

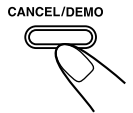

When you press other buttons

The display demonstration stops temporarily. It will start automatically again (if no operation is done for 2 minutes) unless you cancel it by pressing CANCEL/DEMO.

To start the display demonstration manually

Press and hold CANCEL/DEMO again for more than 3 seconds.

Common Operations

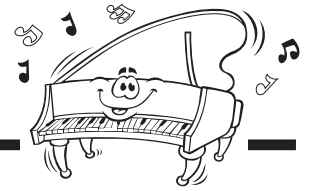

Turning On or Off the Power

To turn on the unit, press STANDBY/ON so that the STANDBY lamp goes off.

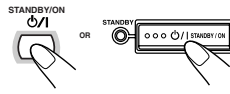

POWER ON

To turn off the unit (on standby), press STANDBY/ON again so that the STANDBY lamp lights up.

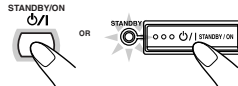

- A little power is always consumed even while the unit is on standby.

To switch off the power supply completely, unplug the AC power cord from the AC outlet.



When you unplug the AC power cord or if a power failure occurs

The clock is reset to "0:00" right away, while the tuner preset stations (see page 12) will be erased in a few days.

Setting the Clock

Before operating the unit any further, first set the built in clock. You can set the clock whether the unit is on or off.

On the unit ONLY:

1 Press CLOCK/TIMER.

The hour digit start flashing on the display.

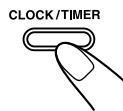

2 Press or to adjust the hour, then press CLOCK/TIMER to set the hour.

SET appear on display.

The minute digits start flashing on the display.

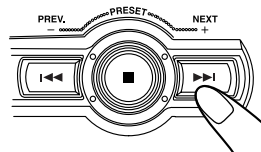

3 Press or to adjust the minute, then press CLOCK/TIMER to set the minute. SET appear on display.

SET

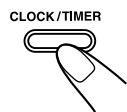

To adjust the clock again

Make sure the (timer) indicator is not lit on the display.

- If it is lit, press and hold CLOCK/TIMER until it goes off. If you have adjusted the clock before, you need to press CLOCK/TIMER repeatedly until the clock setting mode is selected.
- Each time you press the button, the clock/timer setting modes change as follows:

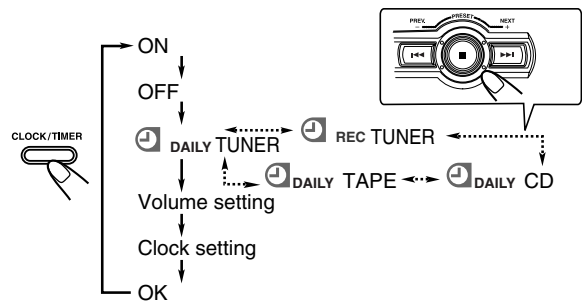

When you unplug the AC power cord or if a power failure occurs

The clock loses the setting and is reset to "0:00." You need to set the clock again. The clock may gain or lose 1 to 2 minutes per month. If this happens, set the clock again.

Setting the AM Tuner Interval Spacing

Some countries space AM stations 9 kHz apart, and some countries use 10 kHz spacing.

On the unit ONLY:

You can only change the AM tuner interval spacing while in STANDBY MODE.

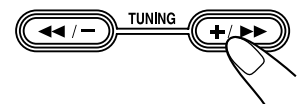

Press STANDBY/ON while holding down for 10 kHz or for 9 kHz interval spacing when you change the setting.



The preset stations are erased. You will need to preset the station again.

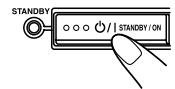

Selecting the Sources

To listen to the FM/AM broadcasts, press FM/AM.

(See page 12.)

To playback CDs, press DISC ►/||. (See pages 13 – 16.)

To playback tapes, press TAPE-A ◀▶ or TAPE-B ◀▶.

(See page 23.)

To select the external equipment as the source, press AUX.

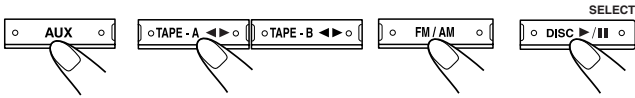

When you press the play button for a particular source (FM/AM, DISC ►/||, TAPE-A ◀▶, TAPE-B ◀▶ and AUX), the unit turns on (and the unit starts playing the source if it is ready — COMPU PLAY CONTROL).



About the audio level indicator

All the audio level indicators light up when no signals come in. The audio level indicators light up when no signal comes in during AUX. The audio level indicators does not represent actual audio level. This is not a spectrum analyzer display.

Adjusting the Volume

You can adjust the volume level only while the unit is turned on. The volume level can be adjusted in 32 steps (VOL MIN, VOLUME 1 — VOLUME 30 and VOL MAX).

Turn VOLUME + / – clockwise (+) to increase the volume or counterclockwise (–) to decrease it.

VOLUME 15

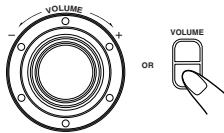

When using the remote control, press VOLUME + to increase the volume or press VOLUME – to decrease it.



For private listening

Connect a pair of headphones to the PHONES jack. No sound comes out of the speakers. Be sure to turn down the volume before connecting or putting on headphones.



DO NOT turn off (on standby) the unit with the volume set to an extremely high level; otherwise, a sudden blast of sound can damage your hearing, speakers and/or headphones when you turn on the unit or start playing any source next time.

REMEMBER you cannot adjust the volume level while the unit is on standby.

To turn down the volume level temporarily

Press FADE MUTING on the remote control.

The volume level gradually decreases to “VOL MIN.”



To restore the sound, press the button again.

Reinforcing the Bass Sound (ACTIVE BASS EX.)

The richness and fullness of the bass sound is maintained regardless of how low you set the volume.

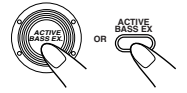

You can use this effect only for playback.

To get the effect, press ACTIVE BASS EX. (Extension) . ACTIVE BASS EX. indicator lights up on the display.

To cancel the effect, press the button again.

ACTIVE BASS EX. indicator lights up.

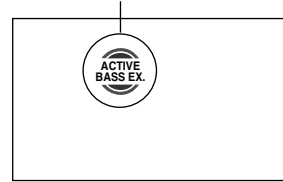

Emphasizing the sound (SOUND TURBO)

High and low frequencies are highly boosted.

To get the effect, press SOUND TURBO.

SOUND TURBO indicator lights up on the display.

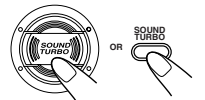

To cancel the effect, press the button again.

SOUND TURBO indicator lights up.

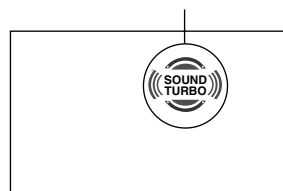

Select Sound Turbo function will turn the Sound Mode off. While the Sound Turbo turns off, the Sound Mode automatically restores to previous setting.

Selecting the Sound Modes

You can select one of the 3 SEA (Sound Effect Amplifier) modes. This function only affects the playback sound, but does not affect your recording.

On the unit:

Press the sound mode button you want to get the effect of ROCK, POP, or CINEMA. The selected Sound Mode name “ROCK”, “POP”, or “CINEMA” appears on the display. Also, the Sound Mode indicator that corresponds to the selected sound mode blinks.



The SOUND MODE indicator also lights up on the display.

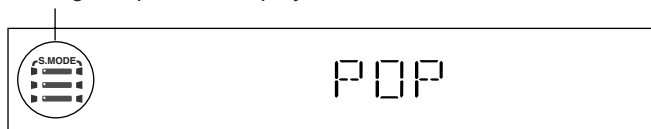

To cancel the effect, press the selected mode button again.

On the remote control:

To select the sound modes, press SOUND MODE until the sound mode you want appears on the display.



- The sound modes change as follows:

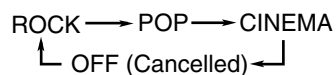

SEA (Sound Effect Amplifier) modes:

- ROCK:** Boosts low and high frequency. Good for acoustic music.
- POP:** Good for vocal music.
- CINEMA:** Good for special effect sound from movie.
- OFF:** The sound mode is cancelled. The SOUND MODE bar indicator goes off.



Select any Sound Modes will turn off Sound Turbo.

Listening to FM and AM Broadcasts



Tuning in a Station

1 Press FM/AM.

The unit automatically turns on and tunes in the previously tuned station (either FM or AM).

- Each time you press the button, the band alternates between FM and AM.

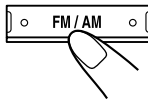

2 Start searching for stations.

On the unit:

Press and hold TUNING +/▶▶ or TUNING ◀◀/- for more than 1 second.

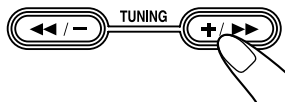

On the remote control:

Press and hold ▶▶ (NEXT ▶▶) or ◀◀ (PREV. ◀◀) for more than 1 second.

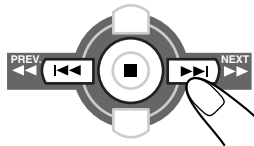

The unit starts searching for stations and stops when a station of sufficient signal strength is tuned in.

- If a program is broadcasted in stereo, the ST (stereo) indicator lights up.

On the unit:

To stop searching, press TUNING +/▶▶ or TUNING ◀◀/-.



When you press TUNING +/▶▶ or TUNING ◀◀/- briefly and repeatedly

The frequency changes step by step.

To change the FM reception mode

When an FM stereo broadcast is hard to receive or noisy, press FM MODE on the remote control so that the MONO indicator lights up on the display. Reception improves.



To restore the stereo effect, press FM MODE again so that the MONO indicator goes off. In this stereo mode, you can hear stereo sounds when a program is broadcasted.

Presetting Stations

You can preset 30 FM and 15 AM stations.

In some cases, test frequencies have been already memorized for the tuner since the factory examined the tuner preset function before shipment. This is not a malfunction. You can preset the stations you want into memory by following the presetting method.

- There is a time limit in performing the following steps. If the setting is cancelled before you finish, start from step 1 again.

On the unit ONLY:

1 Tune in the station you want to preset.

- See "Tuning in a Station."

2 Press SET.

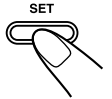

3 Press ◀◀ or ▶▶ to select a preset number.

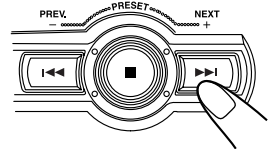
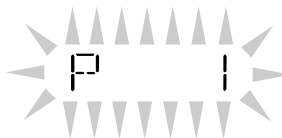

4 Press SET again.

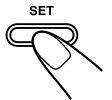

The tuned station in step 1 is stored in the preset number selected in step 3.

- Storing a new station on a used number erases the previously stored one.



When you unplug the AC power cord or if a power failure occurs

The preset stations will be erased in a few days. If this happens, preset the stations again.

Tuning in a Preset Station

1 Press FM/AM.

The unit automatically turns on and tunes in the previously tuned station (either FM or AM).

- Each time you press the button, the band alternates between FM and AM.

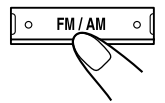

2 Select a preset number.

On the unit:

Press ◀◀ or ▶▶.

On the remote control:

Press the number buttons.

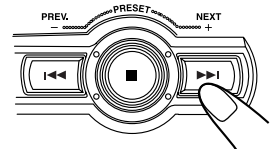

- Ex.: For preset number 5, press 5.
 For preset number 15, press +10, then 5.
 For preset number 20, press +10, then 10.
 For preset number 25, press +10, +10, then 5.
 For preset number 30, press +10, +10, then 10.

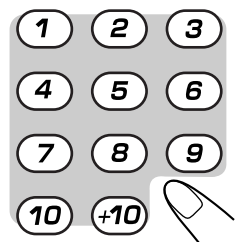



Playing Back CDs (CD/CD-R/CD-RW)

This unit has been designed to playback the following CDs:

- CD (Audio CD)
- CD-R (CD-Recordable)
- CD-RW (CD-ReWritable)

Continuous use of irregular shape CDs (heart-shape, octagonal, etc.) can damage the System.

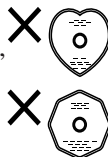

General Notes

In general, you will have the best performance by keeping your CDs and the mechanism clean.

- Store CDs in their cases, and keep them in cabinets or on shelves.
- Keep the system's disc trays closed when not in use.

When playing a CD-R or CD-RW

User-edited CD-Rs (CD-Recordable) and CD-RWs (CD-ReWritable) can be played back only if they are already "finalized."

- You can playback your original CD-Rs or CD-RWs recorded in music CD format. (However, they may not be played back depending on their characteristics or recording conditions.)
- Before playing back CD-Rs or CD-RWs, read their instructions or cautions carefully.
- Some CD-Rs or CD-RWs may not be played back on this unit because of their disc characteristics, damage or stain on them, or the player's lens is dirty.
- CD-RWs may require a longer read-out time. This is caused by the fact that the reflectance of CD-RWs is lower than for regular CDs.

Loading CDs

On the unit ONLY:

1 Press CD Open/Close ▲.

The unit automatically turns on and the disc tray comes out.

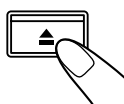

2 Place a disc correctly on the circle of the disc tray, with its label side up.

Label side up

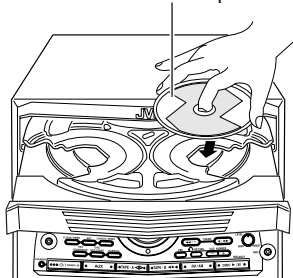

- When using a CD single (8 cm), place it on the inner circle of the disc tray.

3 Press DISC SKIP and place the next CD.

When you press the button, the tray turns for the next CD.



4 Repeat steps 3 for the last CD.

5 Press CD Open/Close ▲.

The tray is closed.



When placing a disc in the tray

Be sure to position the disc inside the recess correctly. Otherwise, the message "NO DISC" will appear in the display, and the disc may be damaged or the unit may be damaged when the tray is opened, or it may be difficult to remove the disc from the unit.



About the disc indicators

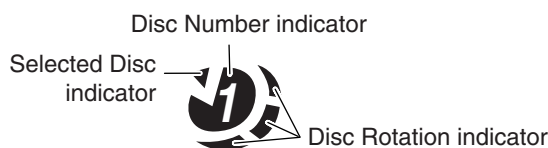

Disc Number Indicator: Lights all the time

Selected Disc indicator: Lights for the currently selected disc number.

Disc Rotation indicator: Runs when the selected CD is played or paused. This indicator goes out if a CD is not loaded for the selected disc number. Once the tray is ejected, the Disc Rotation indicators for all disc numbers are lit. However, when the empty disc number is selected, the Disc Rotation indicator for the disc number goes out.

Example of indication:

When disc tray has ejected once and then DISC 1 is pressed. (DISC 1 is selected)

Shows that this disc number is selected



Shows that the disc is rotating

Playing Back the Entire Discs — Continuous Play

1 Load CDs.

2 Press one of the disc number buttons (DISC 1, DISC 2 and DISC 3) for the disc you want to play.

CD starts playing from the first track of the selected disc.

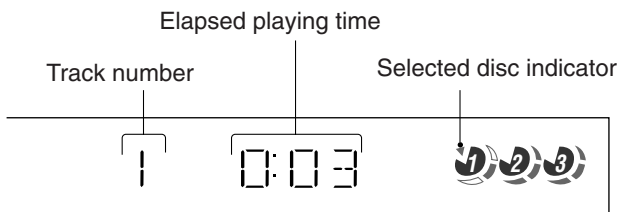

- Pressing DISC ►/|| instead of the disc number buttons starts playing back if a CD is on the tray.
- Playing back the CD using the DISC SKIP button. You can also play the CDs using the DISC SKIP button. During playback, each time you press the button, the next CD is automatically played back.

To stop playing, press ■.

To remove the disc, press ▲. (If the CD is playing, stop the CD before ▲ is pressed.)



CD playback sequence

When 3 CDs* are loaded on the disc tray, they are played in one of the following sequences.

- When DISC 1 is pressed: DISC 1 ⇒ DISC 2 ⇒ DISC 3 (then stops)
- When DISC 2 is pressed: DISC 2 ⇒ DISC 3 ⇒ DISC 1 (then stops)
- When DISC 3 is pressed: DISC 3 ⇒ DISC 1 ⇒ DISC 2 (then stops)

* When only 2 CDs are loaded, they are played in the same order, but the disc tray without a CD is skipped.



Total Number of Contents (TOC) reading

STOP button does not function during CD changing time and TOC reading (about 10-20 seconds). You can press STOP button only after playing time start counting on the display.



If no CD is placed on the disc tray, "NO DISC" appears on the display.

Basic CD Operations

While playing a CD, you can do the following operations.

To remove/change the CDs during playback

While playing back a CD (e.g. DISC 1), you can remove or change the other CDs (e.g. DISC 2 and DISC 3) by pressing ▲. After removing or changing, press the same button to close the tray.

To stop playing for a moment

Press DISC ►/||.

While pausing, the elapsed playing time flashes on the display.



To resume playing, press DISC ►/||.

To go to another track

Press ◀◀◀ or ▶▶▶ before or during playback (or press ▶▶▶| (NEXT ▶▶▶) / ◀◀◀ (PREV. ◀◀◀) on the remote control).

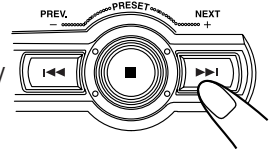

- ◀◀◀: Goes back to the beginning of the current or previous tracks.
- ▶▶▶: Skips to the beginning of the next or succeeding tracks.



If you press and hold (on the unit only) ◀◀◀ or ▶▶▶ before playing

You can change the tracks continuously.

To locate a particular point in a track

On the remote control:

During play, press and hold ▶▶▶| (NEXT ▶▶▶) or ◀◀◀ (PREV. ◀◀◀).

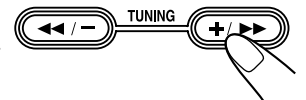

On the unit:

Press TUNING +/▶▶▶ or ◀◀◀/-.

- TUNING ◀◀◀/- (or ◀◀◀ (PREV. ◀◀◀)): Fast reverses the disc.
- TUNING +/▶▶▶ (or ▶▶▶| (NEXT ▶▶▶)): Fast forwards the disc.
- There are 4 searching speed:
 - X1 – 2 seconds search
 - X2 – 5 seconds search
 - X3 – 10 seconds search
 - X4 – 20 seconds search

To go to another track directly using the number buttons

Pressing the number button(s) on the remote control before or during play allows you to start playing the track number you want.

- Ex.: For track number 5, press 5.
For track number 15, press +10, then 5.
For track number 20, press +10, then 10.
For track number 32, press +10, +10, +10, then 2.

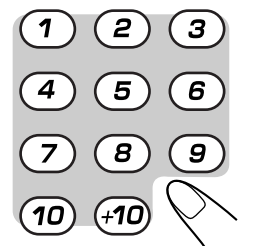

Total time and total number of tracks will only appear on the display at the following condition:

- (1) Power ON in CD mode using standby button.
- (2) New CD inserted into the current tray and the tray closed using the eject button.
 - * The above only apply for audio CD and VCD.
- (3) Search speed might be different for different type of discs.

Programming the Playing Order of the Tracks — Program Play

You can arrange the order in which tracks play before you start playing. **You can program up to 32 tracks.**

- To use Repeat play (see page 16) for Program play, press REPEAT after starting Program play.

1 Load CDs.

- If the current playing source is not the CD player, press DISC ►/||, then ■ before going to the next step.

2 Press PROGRAM so that “PRGM” appears on the display.

The PRGM (program) indicator also lights up on the display.

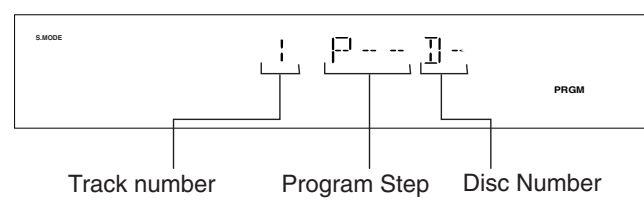

3 Press one of the disc number buttons (DISC 1, DISC 2 and DISC 3) to select the disc number you want to program.

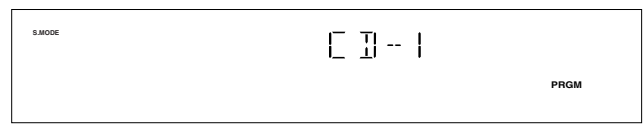
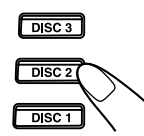

4 Select a track from the CD selected in the above step.

On the unit:

Press ◀◀ or ▶▶ to select the track number and press SET button.

On the remote control:
Press the number buttons.

- For how to use the number buttons, see “To go to another track directly using the number buttons” on page 14.

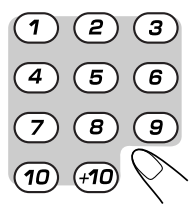
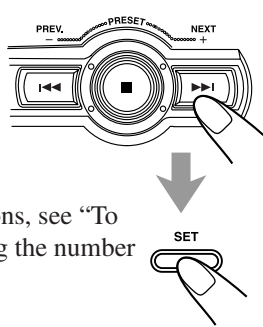

5 Program other tracks you want.

- To program tracks from the same disc, repeat step 4.
- To program tracks from a different disc, repeat steps 3 and 4.

6 Press DISC ►/||.

The tracks are played in the order you have programmed.

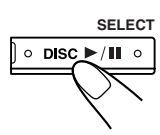

To stop playing, press ■.

To exit from Program play mode, press PROGRAM or STOP again before or after play. The PRGM (program) indicator goes off.



- Memory content of the relevant disc is erased when tray is ejected.
- All memory content is erased when program is turned off.
- If you try to program a 33rd track “FULL” will appear on the display.
- If your entry is ignored
You have tried to program track number that does not exist on the CD (for example, selecting track 14 on a CD that only has 12 tracks). Such entries are ignored.
- If you want to eject current program play disc
Stop the CD and press ▲ to eject. Please note that the program mode is remain eventhough tray is open.

To check the program contents

Before playing, you can check the program contents.

On the remote control:

Press and hold ▶▶▶ (NEXT ▶▶▶) or ◀◀◀ (PREV. ◀◀◀).

On the Unit:

Press TUNING +/▶▶ or ◀◀/-

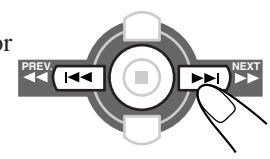

- TUNING +/▶▶ (or ▶▶▶ (NEXT ▶▶▶)) :

Shows the programmed tracks in the programmed order.

- TUNING +/◀◀ (or ◀◀◀ (PREV. ◀◀◀)) :

Shows them in the reverse order.

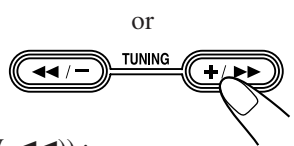

To modify the program on the remote control only

Before or after playing, you can erase the last programmed tracks by pressing PROGRAM CANCEL on the remote control.



- Each time you press the PROGRAM CANCEL on the remote control the programmed track shown on the display is erased from the program.
- Ejecting a CD will also erase the track numbers programmed from the ejected CD.

To add tracks to the program before playing, simply select the track numbers you want to add by following step 4 of the programming procedure.

To erase the entire program before or after playing, press ■.

The program you have made will be erased:

- when you unplug the AC power cord.
- when a power failure occurs.

Playing at Random — Random Play

The tracks of all loaded CDs will play at random.

- To use Repeat play for Random play, press REPEAT after starting Random play.

1 Load CDs.

- If the current playing source is not the CD player, press DISC ►/■, then ■ before going to the next step.

2 Press RANDOM.

The RANDOM indicator also lights up on the display.



3 Press DISC ►/■.

The tracks of the current disc are randomly played until finish before changing to another tray.

Random play ends when all the tracks are played once.



To skip the currently playing track, press ►►| (or press ►►| (NEXT ►►) on the remote control).



Even if you press ◀◀| (or press ◀◀| (PREV. ◀◀) on the remote control)

You cannot go back to previous tracks during Random play.

To stop playing, press ■.

To exit from Random play mode, press RANDOM or STOP again before or after playing.

Repeating Tracks or CDs — Repeat Play

You can have all the CDs, the program or the individual track currently playing repeat as many times as you like.

To repeat playing, press REPEAT during or before playing. To use Repeat play for Program play and Random play, press the button after starting playback.



- Each time you press the button, Repeat play mode changes as indicated by the following indicator lights up on the display:

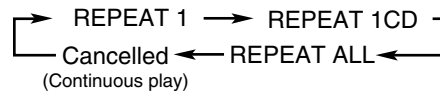

REPEAT ALL: Repeats all the tracks on all the CDs (continuously or at random) or all the tracks in the program.

REPEAT 1 : Repeats one track on one CD.

REPEAT 1CD : Repeats all the tracks on one CD.

To cancel Repeat play, press REPEAT repeatedly until the REPEAT indicators go off from the display.

- Repeat play remains in effect when you select another play mode (NORMAL, PROGRAM or RANDOM)
- In RANDOM and PROGRAM play, “REPEAT 1CD” can’t be selected. If REPEAT 1CD has been selected when you press RANDOM, it is cancelled. Only REPEAT 1 and REPEAT ALL can be selected.

Prohibiting Disc Ejection — Tray Lock

You can prohibit CD ejection from the unit and lock CDs.

- This operation is possible only when the source is the CD player.

On the unit ONLY:

To prohibit disc ejection, press ◻/| STANDBY/ON while holding down ■. (If there is any disc tray opened, close it first.) “LOCKED” appears for a while, and the loaded CDs are locked.

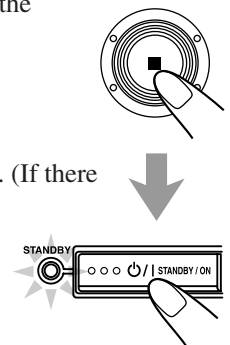

To cancel the prohibition and unlock the CDs, press ◻/| STANDBY/ON while holding down ■. “UNLOCKED” appears for a while, and the loaded CDs are unlocked.



If you try to eject CDs

“LOCKED” appears to inform you that the Tray Lock is in use.



Playing Back Video CDs

Selecting Video Output (PAL, PAL AUTO, NTSC)

You can set this setting in Standby mode.

Before playing a VCD, use the buttons on the unit to select a video output mode to match your TV system.

Video output is preset for PAL.

Relationship among the playable CDs, System's TV output mode and your TV's color system:

| Playable CD | Player's TV output mode | Your TV's color system |
|-------------|-------------------------|------------------------|
| NTSC/PAL | NTSC | NTSC |
| NTSC/PAL | PAL | PAL |
| NTSC/PAL | PAL AUTO | Multisystem |

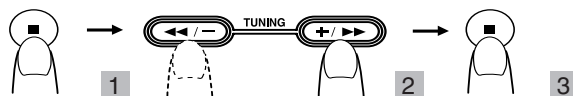

1 Turn off the power to put the System into Standby mode.

2 Press and hold the ■ button on the Unit for more than 2 seconds.

The current TV output mode ("NTSC" for example) appears on the display for five seconds.

3 Within five seconds, press the TUNING +/▶▶ or TUNING ◀◀/- button on the Unit to select the System's TV output mode.

Each time you press the button, the TV output mode changes as follows:

NTSC → PAL → PAL AUTO (back to beginning)

NTSC: for NTSC exclusive TV

PAL: for PAL exclusive TV

PAL AUTO: for multisystem TV

4 Press ■ button to confirm selected TV output mode.

Loading Discs

1 Press CD Open/Close ▲.

The unit automatically turns on and the disc tray comes out.

2 Place a disc correctly within the circle of the disc tray, with its label side up.

Label side up



- When using a CD single (8 cm), place it within the inner circle of the disc tray.

3 Press DISC SKIP and place the next CD.

When you press the button, the tray turns for the next CD.

4 Repeat steps 3 for the last CD.

5 Press CD Open/Close ▲.

The tray is closed.

When you place a CD onto the currently selected tray, whose disc number shown on the CD indicator, reading of the CD starts. After the reading is completed, the total number of tracks and total playing time will appear, then the playing time of the first track.

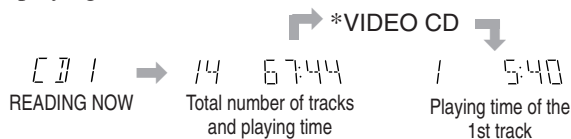

*VIDEO CD or AUDIO CD

If the video CD has the Playback Control function, "VCD PBC" will appear when you press ■ followed by PBC and DISC ▶/■.

To put an 8 cm CD onto a tray, insert it so that it is aligned with the groove in the trays center.

If a tray is opened when the System switches to the standby mode, the tray will close automatically.

Playing a Video CD

You can play video CDs either with or without the PBC function.

1 Turn on the TV and select the video input so that you can view the pictures from the CD player.

Refer to the manual supplied for your TV.

2 Prepare a CD.

Refer to "Loading Discs" on this page.

3 Start playback of the CD.

Press DISC ▶/■, to start playback of the currently selected CD, or press DISC 1-3, to select the disc and start playing.

Compu Play

When DISC ▶/■, or DISC 1-3, is pressed while the system is on standby, the power is automatically turned on.

To stop during play, press ■.

To stop playing and remove the disc, press ■ and then ▲ for the disc being played.

Playing Video CDs with PBC Function — Menu Play

This System provides Playback Control (PBC) which utilizes a procedure (menu selection) programmed in a video CD. The playback operation procedure may differ depending on the disc you use.

For Menu Play, use the following buttons:
(PBC mode must be turned on before operating Menu Play.)

On the unit:

- NEXT + (▶▶)** for viewing the unshown portion of the menu
- PREV. - (◀◀)** for viewing the previously shown portion of the menu
- DISC ▶/||** for starting playback of the selected item
- ↶ RETURN** for going back to the previous menu
- VCD NUMBER +, -** for selecting an item

On the remote control:

- ▶▶ (NEXT ▶▶)** for viewing the unshown portion of the menu
- ◀◀ (PREV. ◀◀)** for viewing the previously shown portion of the menu
- NUMBER BUTTONS ...** for selecting and starting playback of an item
- ↶ RETURN** for going back to the previous menu

1 Turn on the TV and select the video input so that you can view the pictures from the CD Player.
Refer to the manual supplied for your TV.

2 Prepare a CD.
Refer to “Loading Discs” on page 17.

3 Press PBC on the unit.
Allow several seconds for the table of contents (TOC) to be read before pressing PBC.
PBC indicator lights up on the display

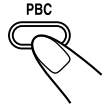

4 Start playback of the CD.
Press DISC ▶/||, to start playing of the currently selected CD.

5 Select the item you want to view.

On the unit:

Press VCD NUMBER + to select larger item numbers, or press VCD NUMBER - to select smaller item number. Then press DISC ▶/||, to start the disc. In case VCD number cannot be selected from the unit, please use the remote control.

On the remote control:

Press the number buttons to select and play the item you want.

To stop the track being played and return to the menu, press ↶ RETURN button.

To stop Menu Play, press ■.

NOTE:

You can only select PBC in CD STOP and repeat off position. REPEAT mode is turned off automatically.

Basic Concept of the PBC function

PBC (Playback Control) allows you to enjoy menu-driven operation and high resolution still images having a resolution four times greater than video pictures.

Menu-driven playback

You can interact with the screen using a menu display to select and play an entry.

High-resolution still image display

You can display high-quality images four times clearer than video pictures.

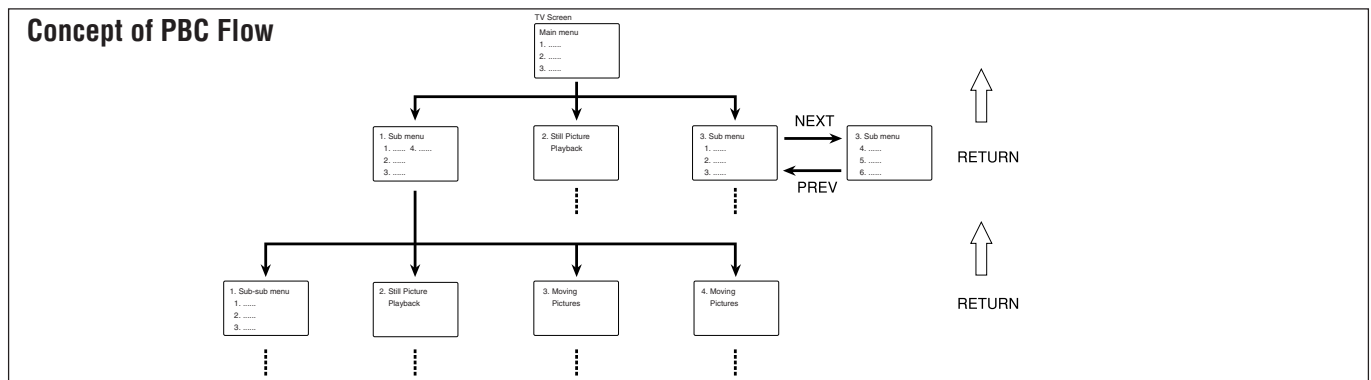

Basic flow of Menu Play Operation

A selection menu is shown when you start playing a video CD with PBC. The menu shows a list of items to select. Some discs may show moving pictures or a divided screen.

- When a list of items appears, you can select the number of the item you want to playback.
- When moving pictures appear, you can select a moving picture by pressing ▶▶ (NEXT ▶▶) / ◀◀ (PREV. ◀◀).

- When the menu appears after the item you have selected finish playing, you can select another item that you want to view next.
- After playback, press ↶ RETURN, to go back to the previous screen. Each time you press the button, you will go back by one screen.
- If you want to stop Menu Play, press ■.



Cancelling PBC

- After cancelling PBC, you can Continuously Play more than one video CD without PBC.
- When PBC is cancelled, some images such as still play pictures may not be played back.
- You cannot change from PBC OFF to PBC ON while CD is playing.

Reminder!

Do not pause Video CD for more than 10 minutes to prevent screen burns.

Playing Video CDs without PBC — Continuous Play

Even if a video CD has PBC, you can cancel PBC and play the disc without using the menu screen.

1 Turn on the TV and select the video input so that you can view the pictures from the CD Player.

Refer to the manual supplied for your TV.

2 Prepare a CD.

Refer to “Loading Discs” on page 17.

3 Start playback of the CD.

On the unit:

Press DISC ►/|| or DISC 1-3 of the tray you want to play from. The selected video CD starts playback from the first track.



On the remote control:

Press the number button of the track you want to start playing. The playback starts from the selected track of the currently selected disc.

To stop during play, press ■.

To restore PBC, press the PBC button again, then press current DISC ►/|| to play VCD with PBC.

Pressing DISC 1, DISC 2 or DISC 3 will cancel PBC automatically.

Resuming Play

If you stop a video CD directly, you can continue viewing from the scene where you last stopped.

1 During playing of a VCD, press ■ button to stop playing (refer to page 17).

2 Press DISC ►/|| button to continue playback from the last scene that you stopped at.



- Resume play will not work when the CD tray has been opened.
- It is advisable to turn off PBC to use resume play otherwise resume feature will be cancelled.
- Resume play will also function when you change source or turn off the unit (on standby) during playing of a VCD.

Special Plays for a Video CD

You can use the following special play modes for video CDs both with and without PBC. The following functions can only be executed with the buttons on the remote control.

Frame-by-Frame Playback

Press the STILL button during playback. Then each time you press the button, still pictures advance by one frame. During frame-by-frame playback, no sound is emitted.



To resume normal playback, press DISC ►/||.

Viewing Operating Status

Usually, the following information of the track being played is shown on the TV screen during playback : the disc number, the track number, and the playing time.

Press ON SCREEN.

This button toggles the display of operation status. When the display of operation status turns on, the following information of the track being played appear on the TV screen: Disc number, track number / total number of tracks and the current tracks elapsed time.

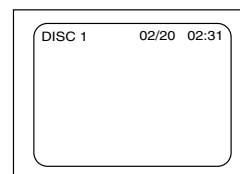

To cancel the display of operation status, press ON SCREEN.

Viewing the Video Intro of the Video CD

You can view the contents of a video CD, watching for about 7 seconds of each track on the video CD. Video intro does not work with PBC. For a video CD with PBC, cancel the PBC function by referring to “Playing Video CDs without PBC” on this page.

1 Press DISC 1-3, to select the disc you want to view the video intro.

Playback starts.



2 Press VIDEO INTRO on the remote control after a picture appears on the TV screen.

The video intro play starts and shows in sequence for about 7 seconds of the first nine tracks on the TV screen. To preview subsequent tracks, press ►► (NEXT ►►) on the remote control. Pressing ◀◀ (PREV. ◀◀) will display the previous 9 track intros.



The TV screen will show the following:

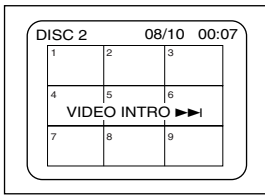

3 Press the number button for the video intro you want to select.

Playback starts from the selected track.

To stop and cancel the video intro play, press ■.

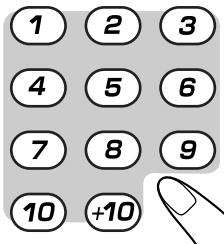

Viewing the Highlights of a Video CD

You can view highlight scenes of the selected track on a video CD only when PBC is off. These highlight scenes are created by dividing the track equally into 9 portions and the beginning scenes (about 7 seconds each) of those 9 portions are shown on the display.

1 Press DISC 1-3, and the number button for the track you want to view the highlights of.

Playback starts.



2 Press HIGHLIGHT on the remote control after a picture appears on the TV screen.

The highlight play starts and shows in sequence, the first 7 seconds of nine track divisions on the TV screen. To preview subsequent tracks, press ►► (NEXT ►►) on the remote control.



TV screen will show the following:

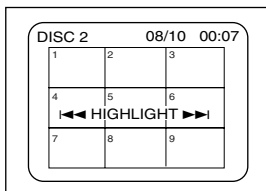

3 Press the number button for the highlight you want to select.

Playback starts from the selected scene.

To stop and cancel the highlight play, press ■.

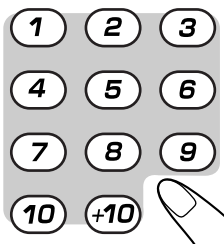

Viewing highlights

- When a highlight scene is selected, playback starts from the beginning of the highlight scene, but not from the still image shown on the display (the part shown is the last part of the highlight scene, not its beginning).
- During the video intro or highlight play, images shown on the display may be partially distorted, resulting from noise or incorrect manufacturing of the disc.
- Highlight also can function in stop position.
- When STILL/PAUSE function is on, HIGHLIGHT and VIDEO INTRO functions are not available.

Playing a Multiplex Sound CD

This function is used for multiplex sound discs. See manuals attached to discs for detailed information.

Operation

By pressing the MPX button on the remote control consecutively, channel multiplexing modes are cycled as shown below.

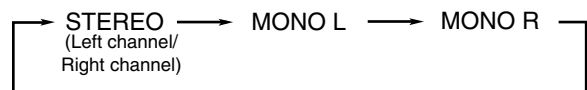

When MONO L or MONO R is selected, display indicates MONO L or MONO R respectively.

- MONO L: Only the left channel is played back through both right and left speakers.
- MONO R: Only the right channel is played back through both right and left speakers.
- STEREO: Used for conventional stereo sources.

MP3 Disc Playback

About MP3 discs

An MP3 disc can have several folders (albums). Tracks are contained within the albums. The player will only recognize up to 76 albums. Total number of tracks recognizable is 999.

Recording your own MP3 discs

- Disc format should be set to “ISO 9660”.
- Multisession recording is not supported.
- The disc must be finalized.
- Files other than MP3 will be ignored.

Basic operations

If your TV set is connected to the unit, you can view the contents of the MP3 disc on-screen.

- 1 Load an MP3 disc.
- 2 Press DISC 1, DISC 2 or DISC 3, and CD starts playing.
- 3 Press  button, Group Title Menu will appear on TV screen.

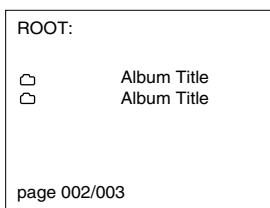

- 4 Press PRESET NEXT + (▶▶) or PREV. - (◀◀) (or press ▶▶ (NEXT ▶▶) / ◀◀ (PREV. ◀◀) on the remote control) to select the album. At the last entry, press PRESET NEXT + (▶▶) will move to the next page (if any). Albums are arranged in alphabetical order.

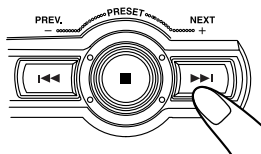

- 5 Press ENTER on the remote control to confirm your album selection.

The following display will appear on the TV screen.

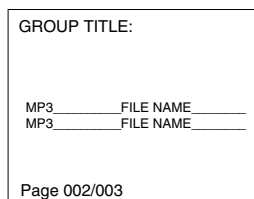

- To exit from the selected album, press  RETURN.

- 6 Press PRESET NEXT + (▶▶) or PREV. - (◀◀) (or press ▶▶ (NEXT ▶▶) / ◀◀ (PREV. ◀◀) on the remote control) to select the track.

- 7 Press DISC ▶/|| to play.

The next track will be automatically played after the current track is finished.

- 8 If you press and hold ▶▶ (NEXT ▶▶) / ◀◀ (PREV. ◀◀) on the remote control, you can fast search (reverse/forward) within a track. The track elapsed time on the unit's display will change.

- 9 Press  to stop playing and return to album menu.



At any time you may select a track from any album by pressing the number keys on the remote control.

Example:

For track number 28, press +10 twice, then 8.

Programming tracks

- 1 Press PROGRAM on the unit or on the remote control.
- 2 Select a MP3 disc using the DISC 1, DISC 2 or DISC 3 button. The following display will appear on your TV screen.

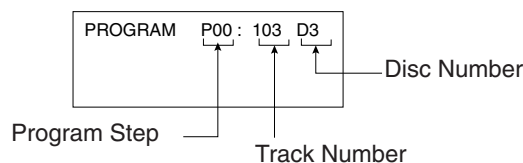

- 3 Select an album using PRESET NEXT + (▶▶) or PREV. - (◀◀).

At the last entry, press PRESET NEXT + (▶▶) or PREV. - (◀◀), it will move to the next page (If any).

- 4 Press SET on the unit or ENTER/SET on the remote control. The following screen will appear on your TV.

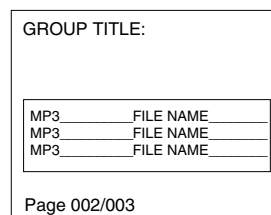

- To exit from the selected album, press  RETURN.

5 Select a track from the CD selected in the above step.

On the unit

Press PRESET NEXT + (▶▶|) or PREV. – (|◀◀), then press SET button.

On the remote control:

Press ▶▶| (NEXT ▶▶) or |◀◀ (PREV. ◀◀), then press ENTER button or SET button.

You can also press the number button.

- To cancel the entry, press CANCEL/DEMO on the unit or PROGRAM CANCEL on the remote control.
- To cancel the whole program, press PROGRAM or press ■ to clear all memory content.
- If you want to return to the Group Title Menu, press ⌂ RETURN button.
- To check program contents and modify the program, see “To check the program contents” and “To modify the program on the remote control only” on page 15.

6 Press DISC ▶/|| to start program playback.

To stop playing press ■.

To skip program,

On the unit

Press PRESET NEXT + (▶▶|) or PREV. – (|◀◀).

On the remote control:

Press ▶▶| (NEXT ▶▶) or |◀◀ (PREV. ◀◀).

To cancel the program, press ■ while the disc not playing.



Playing Back Tapes

You can playback type I, type II and type IV tapes without changing any settings.

Playing Back a Tape

1 Press EJECT (▲) for the deck you want to use.

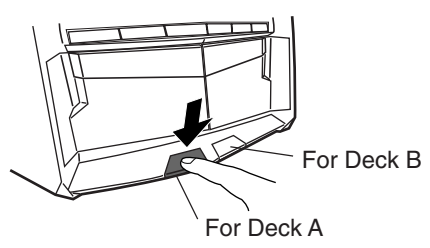

2 Put a cassette in with the exposed part of the tape down.

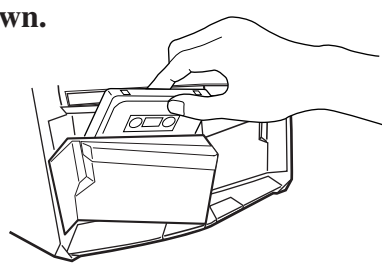

3 Close the cassette holder gently.

4 Press TAPE-A ◀▶ or TAPE-B ◀▶ for the deck you want to use .

The tape play starts and the tape direction indicator ▶- or -◀ starts flashing slowly to indicate the tape running direction.

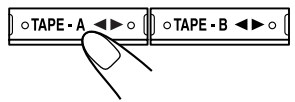

- Each time you press the button, the tape direction changes.
 - ▶- : plays the forward side.
 - ◀ : plays the reverse side.
- If no cassette is inserted in current deck then “DECK A” or “DECK B” and “NO TAPE” will start blinking on the display.

When the tape plays to the end, the deck automatically stops or reverse play depends on the setting of Reverse Mode. (See “To play both sides repeatedly — Reverse Mode.”)

To stop playing, press ■.

To fast forward or fast reverse, press +/▶▶ or ◀◀/- (or ▶▶| (NEXT ▶▶) / |◀◀ (PREV. ◀◀) on the remote control).

The tape direction indicator ▶- or -◀ starts flashing quickly on the display.

To remove the cassette, press ▲ EJECT for deck A or EJECT ▲ for deck B.

To play both sides repeatedly — Reverse Mode

Reverse Mode works for both decks at the same time. When it is in use, the tape automatically reverses at the end of a side and the unit starts playing the other side of the tape, and repeats the same process.

To use Reverse Mode, press REVERSE MODE.

The Reverse Mode indicator on the display lights up — □. **To cancel Reverse Mode**, press the button again so that the Reverse Mode indicator on the display lights up — □.

- : Play one direction only.
- : Play both sides of current deck.
- : Play DECK A and DECK B repeatedly.



notes When Reverse Mode is on with cassettes in both decks A and B

After the reverse -◀ side of the tape finishes playing, the tape in the other deck starts playing.

Recording



IMPORTANT:

- It may be unlawful to record or play back copyrighted material without the consent of the copyright owner.
- The recording level is automatically set correctly, so it is not affected by the VOLUME, the ACTIVE BASS EX., the SOUND TURBO, and the SOUND MODE. Thus, during recording you can adjust the sound you are actually listening to without affecting the recording level.
- If recordings you have made have excessive noise or static, the unit may be too close to a TV. Increase the distance between the TV and the unit.
- You can use type I tape for recording.

To protect your recording

Cassettes have two small tabs on the back to protect from accidental erasure or re-recording.

To protect your recording, remove these tabs.

To re-record on a protected tape, cover the holes with adhesive tape.

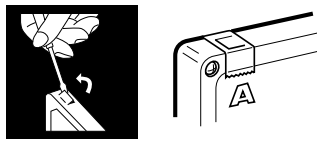

To keep the best recording and playback sound quality

If the heads, capstans, and pinch rollers of the cassette decks become dirty, the following will occur:

- Impaired sound quality
- Discontinuous sound
- Fading
- Incomplete erasure
- Difficulty in recording

To clean the heads, capstans, and pinch rollers

Use a cotton swab moistened with alcohol.

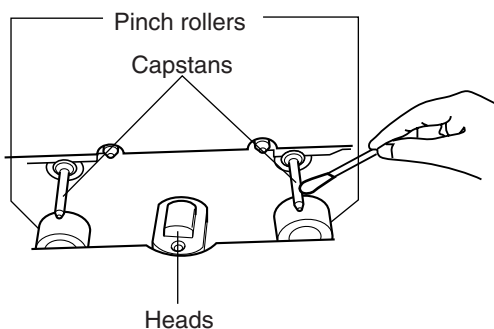

To demagnetize the heads

Turn off the unit, and use a head demagnetizer (available at electronics and audio shops).

Recording a Tape on Deck B

1 Press EJECT ▲ for deck B.

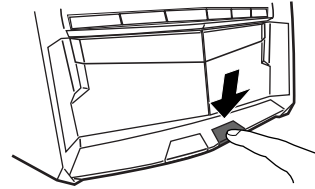

2 Put a recordable cassette into deck B.

3 Close the cassette holder gently.

4 Check the tape direction of deck B.

- If the tape direction is not correct, press TAPE-B ◀▶ twice then ■ to change the tape direction.

5 Start playing the source — FM, AM, CD player, deck A or auxiliary equipment connected to AUX jacks.

- When the source is CD, you can also use CD Direct Recording (see page 25).
- When the source is deck A, you can also use the dubbing method. (See “Dubbing Tapes” on page 25 .)

6 Start recording.

Press REC START/STOP.

The **REC** (recording) indicator lights up on the display and recording starts.

- If no cassette is inserted, “NO TAPE” appears on the display. If a protected tape is inserted, “NO REC” appears on the display.



To stop recording immediately, press ■.

To remove the cassette, press EJECT ▲ for deck B.



REC START/STOP

During CD mode, when recording stop after tape finish, press ■ once to cancel the recording function. Otherwise, the system will remain in recording mode and certain operations will be invalid.

To record on both sides — Reverse Mode

Press REVERSE MODE so that the Reverse Mode indicator lights up – .

- When using Reverse Mode for recording, start recording in the forward \blacktriangleright - direction first. Otherwise, recording will stop when recording is done only on one side (reverse) of the tape.

To cancel Reverse Mode, press the button again so that the Reverse Mode indicator lights up – .

Dubbing Tapes

You can record from one tape to another.

On the unit ONLY:

- 1 Press either TAPE-A $\blacktriangleleft\blacktriangleright$ or TAPE-B $\blacktriangleleft\blacktriangleright$, then .

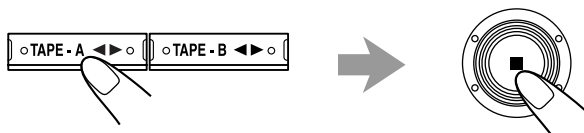

- 2 Put the source cassette into deck A, and a recordable cassette into deck B.

- Put the cassettes in both decks so that the tapes will run in the forward \blacktriangleright - direction.

- 3 Press DUBBING.

The  (recording) indicator lights up on the display and dubbing starts.



To stop dubbing, press  so that both decks (A and B) stop.

To record on both sides — Reverse Mode

Press REVERSE MODE so that the Reverse Mode indicator lights up – .

To cancel Reverse Mode, press the button again so that the Reverse Mode indicator lights up – .

CD Direct Recording

Everything on the CD goes onto the tape according to the order of the CD.

On the unit ONLY:

- 1 Put a recordable cassette into deck B.

- 2 Load CDs.

- 3 Press one of the disc number buttons (DISC 1, DISC 2 and DISC 3) to select the disc, then .



- 4 Press DISC REC START.

“DISC REC START” appears, and the  (recording) indicator lights up on the display. Deck B starts recording and the CD player starts playing. When the recording is done, “DISC REC FINISHED” appears on the display and deck B stop.



To stop recording, press REC START/STOP or . So that a 4-second blank portion is created on the recording tape.



- Before recording on a tape, wind the tape on past the leader tape (about the first 3 or 4 seconds of each side).

To record on both sides — Reverse Mode

Press REVERSE MODE so that the Reverse Mode indicator lights up like – .

- When using the Reverse Mode for CD Direct Recording, start recording in the forward \blacktriangleright - direction first. When the tape reaches its end while recording a song in the forward direction \blacktriangleright -, the last song will be re-recorded at the beginning of the reverse side \blacktriangleleft .

If you start recording on the reverse side \blacktriangleleft -, recording will stop when recording is done only on one side (reverse) of the tape.

To cancel Reverse Mode, press the button again so that the Reverse Mode indicator lights up – .

Using the Microphones



You can enjoy singing along (Karaoke) and microphone mixing using a microphone.

IMPORTANT:

- Always set **MIC LEVEL** to **MIN** when connecting or disconnecting the microphone.
- When not using the microphone, keep it disconnected.

Singing along — Karaoke

Karaoke

Karaoke reduces the lead vocal of the playing source, and allows you to replace it by singing into the microphone as the music plays.

1 Turn **MIC LEVEL** to **MIN**.

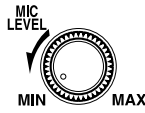

2 Connect the microphone (not supplied) by plugging it into **MIC** jack.

3 Press **KARAOKE** on the remote control.

The karaoke (K) indicator lights up on the display.



4 Start playing the source — CD, tape or other connected component.

5 Turn **MIC LEVEL** and **VOLUME** as you sing into the microphone.

- By pressing **REC START/STOP**, you can record your singing along if you want. (For more details, see page 24.)

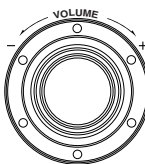
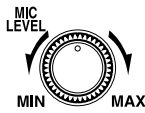

To apply an echo to your voice

Press **ECHO** on the remote control so that the echo (E) indicator lights up on the display.

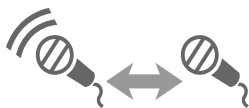

Each time you press the button, the echo level changes as follows:

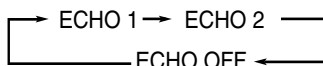

- As the number increases, a stronger echo effect is applied to your voice.

notes If howling or squealing (feedback) occurs while using the microphone

Take the following actions to prevent these noises.

- Adjust **MIC LEVEL** and **VOLUME**.
- Avoid pointing the microphone towards the speakers.

notes When you turn on Karaoke and MPX, you cannot get the satisfactory results if

- Radio programs — a radio signal is not as reliable as the signals coming from a tape or CD.
- Monaural sources.
- Poorly dubbed tapes.
- Sources recorded with duets, strong echo, a chorus or only a few instruments.
- To get the best result, turn off karaoke when MPX is on or turn off MPX when karaoke is on.

Singing Along with Multiplex Karaoke Discs (MPX)

If the source you are going to play is a multiplex karaoke disc, you can use the Multiplex sound function via the buttons on the remote control.

What is Multiplex Sound?

On a multiplex karaoke disc, the instrumental parts are recorded on the left channel. With this system, you can replace the vocal part with your voice through the microphone.

1 Rotate the **MIC LEVEL** and **VOLUME** to **MIN**.



2 Connect the microphone (not supplied) into the **MIC** jack on the front panel.

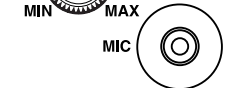

3 Play the source — CD.

4 Press **MPX** on the remote control to select the output sound.

Please refer to page 20.



5 Turn **MIC LEVEL** and **VOLUME** to adjust the microphone level and the speaker output level.

6 Sing into the microphone.

To apply echo to your voice, see “To apply an echo to your voice” on this page.

To adjust the music key, see “Adjusting the Music Key Control” on page 27.

To record your singing along, see “Microphone mixing” on page 27.



When finished singing

Restore the stereo effect by pressing **MPX** until “STEREO” appears on the display. To cancel echo effect, press **ECHO** until “ECHO OFF” appears on the display.

Recording Your Singing

You can adjust the music key using the remote control.

- 1 Follow the steps in “Singing Along with Multiplex Karaoke Discs (MPX)” on page 26.
- 2 Follow the steps in “Recording a Tape on Deck B” on page 24 to record your singing.

Adjusting the Music Key Control (for CD play only)

On the remote control ONLY:

- 1 Press **KEY CONTROL** **b** / **#** to adjust the music key.

To lower the key, press **KEY CONTROL** **b** .
To raise the key, press **KEY CONTROL** **#**.

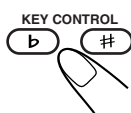

To cancel the key adjustment, press **KEY CONTROL** **b** or **#** until “KEYCON 0” appears on the display and the TV screen display is as below:

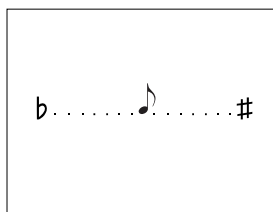

Adjust the music key each time you sing along to a song

Once the music key is adjusted, the key level will not return to the previous level automatically after playing a song.
The music key cannot be changed while recording.
Once the source is changed, the key level returns to 0.

Microphone mixing

When you sing along with multiplex tapes or CDs, follow the procedure below:

- 1 Connect the microphone.
- 2 Start playing the source — CD, tape or other connected component.

- 3 Turn **MIC LEVEL** and **VOLUME** as you sing into the microphone.

- By pressing **REC START/STOP**, you can record your singing along if you want.
(For more details, see page 24.)

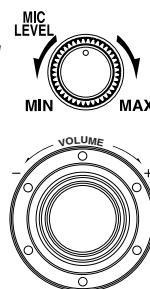

To use microphone only

Without any background sound, you can use your microphone and record it if you want.

- 1 Connect the microphone.
- 2 Press **DISC** **▶/||**, then **■**.
No background sound will be heard.

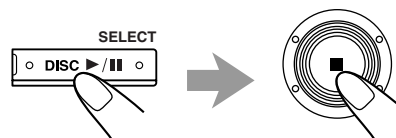

- 3 Turn **MIC LEVEL** and **VOLUME** as you sing into the microphone.

- By pressing **REC START/STOP**, you can record your singing along if you want.
(For more details, see page 24.)

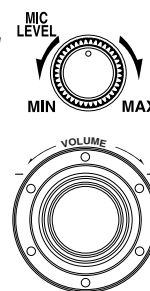

Using the Timers

There are three timers available — Daily Timer, Recording Timer and Sleep Timer.

Before using the timers, you need to set the clock built in the unit. (See page 9.)

Using Daily Timer and Recording Timer

With Daily Timer, you can wake to your favorite music or radio program. You can set the timer whether the unit is on or off.

How Daily Timer works

The unit automatically turns on, sets the volume level to the preset level, and starts playing the specified source when the on-time comes (the  indicator flashes just before the on-time, and continues flashing while the timer is operating). Then, when the off-time comes, the unit automatically turns off (on standby).

The Daily timer works everyday automatically. If you do not want to use the Daily timer, turn off the Daily timer. (See “To deactivate the timer temporary” on page 29.) The timer setting remains in memory until you change it.

- There is a time limit in performing the following steps. If the setting is cancelled before you finish, start from step 1 again.
- To correct a misentry, deactivate the timer and start from step 1 again.

Before you start...

- *When using a CD as the source to play —*
 - Make sure there is a CD on the selected disc number tray.
- *When using a tape as the source to play —*
 - Make sure that a tape is in the deck whose deck indicator (A or B) is lit on the display.
 - Make sure that the tape direction is correct.







On the unit ONLY:

1 Press CLOCK/TIMER.

 indicator lights up and DAILY (Daily Timer) indicator also starts flashing on the display.





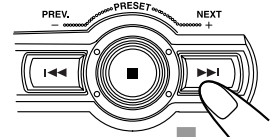

2 Set the on-time you want the unit to turn on at.

- 1) Press  or  to set the hour, then press CLOCK/TIMER.
- 2) Press  or  to set the minute, then press CLOCK/TIMER.



3 Set the off-time you want the unit to turn off (on standby) at.

- 1) Press  or  to set the hour, then press CLOCK/TIMER.
 - 2) Press  or  to set the minute, then press CLOCK/TIMER.
- The unit enters source selecting mode.



4 Select the timer (Daily Timer or Recording Timer) with the source to play.

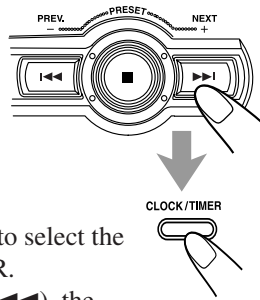

On the unit:

Press **PREV.** or **NEXT** to select the timer, then press **CLOCK/TIMER**.

- Each time you press **PREV.** or **NEXT**, the timer mode and the source change as follows:

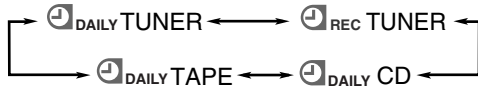

DAILY TUNER: Tunes in to the last station you were listening to. (Daily Timer)

REC TUNER : Records the last station you were listening to. (Recording Timer).

- Put a recordable cassette into the deck.

DAILY CD : Plays a disc. (Daily Timer)

- Load a disc.

DAILY TAPE : Plays a tape. (Daily Timer)

- Make sure that the tape is in the cassette deck.
- Make sure that the tape direction is correct.

The unit enters the volume level setting mode.

5 Select the volume level.

On the unit:

Press **PREV.** or **NEXT** to set the volume level, then press **CLOCK/TIMER**.

- You can select the volume level (“VOLUME --” and “VOLUME 0” to “VOLUME 30”).

If you select “VOLUME--,” the volume is set to the previous level when the unit was turned off.

- To turn off the volume while the Recording Timer (**REC TUNER**) is working, set the volume level “VOLUME 0”.

The unit enters the clock setting mode.

6 Adjust the clock if you need.

- See "Setting the Clock" on page 9.

7 Press **STANDBY/ON** (or **STANDBY/ON** on the unit) to turn off the unit (standby) if you have set the timer with the unit turned on.



- When the timer turns on the unit, the  (timer) indicator starts flashing. (If the Recording Timer is selected in step 4, the REC indicator also starts flashing.)

To deactivate the timer temporarily, press and hold **CLOCK/TIMER** on the unit until the  (timer) indicator on the display goes off.

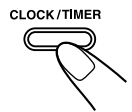

To activate or change the timer (with the previous setting), follow steps 1 to 7 on pages 28 and 29

- If you want to change the timer setting after the Daily Timer has been set, deactivate the timer then set it again.



- **If the unit is turned on when the on-time comes**
Timer does not work.
- **Even if you unplug the power cord or if a power failure occurs**
The timer will be cancelled. You need set the clock first, then the timer again.

Using Sleep Timer

With Sleep Timer, you can fall asleep to music. You can set Sleep Timer only while the unit is turned on.

How Sleep Timer actually works

The unit automatically turns off after the specified time length passes.

On the remote control ONLY:

1 Press SLEEP.

The time length until the shut-off time appears and the SLEEP indicator lights up on the display.

- Each time you press the button, the time length changes as follows:

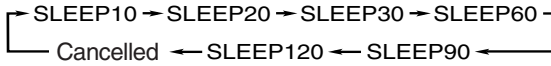

2 Wait for about 5 seconds after specifying the time length.

To check the remaining time until the shut-off time, press SLEEP once so that the remaining time until the shut-off time appears for about 5 seconds.

To change the shut-off time, press SLEEP repeatedly until the desired time length appears on the display.

To cancel the setting, press SLEEP repeatedly so that the SLEEP indicator goes off.

- Sleep Timer is also cancelled when you turn off the unit.



- **If you set the Sleep Timer after the Daily Timer starts playing the selected source**
The Daily Timer is cancelled. When the Sleep Timer shut-off time comes, the unit will be turned off.
- **If you set the Sleep Timer after the recording Timer starts recording**
The Recording Timer is cancelled, but recording continues until the Sleep Timer shuts off the power.
- **If the unit is turned on when on-time comes**
Timer does not work.
- **When you unplug the power cord or if a power failure occurs**
The timer will be cancelled. You need to set the clock first, then the timer again.

Maintenance



To get the best performance of the unit, keep your discs, tapes, and mechanism clean.

Handling discs



- Remove the disc from its case by holding it at the edge while pressing the center hole lightly.
- Do not touch the shiny surface of the disc, or bend the disc.
- Put the disc back in its case after use to prevent warping.

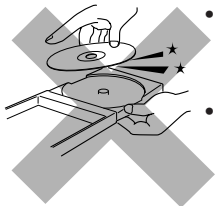

- Be careful not to scratch the surface of the disc when placing it back in its case.
- Avoid exposure to direct sunlight, temperature extremes, and moisture.

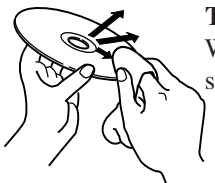

To clean the disc

Wipe the disc with a soft cloth in a straight line from center to edge.



DO NOT use any solvent — such as conventional record cleaner, spray, thinner, or benzine — to clean the disc.

Handling cassette tapes

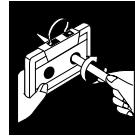

- If the tape is loose in its cassette, take up the slack by inserting a pencil in one of the reels and rotating.
- If the tape is loose, it may get stretched, cut, or caught in the cassette.



- Be careful not to touch the tape surface.



- Avoid the following places to store the tape:
 - In dusty places
 - In direct sunlight or heat
 - In moist areas
 - Near a magnet

Cleaning the unit

• Stains on the unit

Should be wiped off with a soft cloth. If the unit is heavily stained, wipe it with a cloth soaked in water-diluted neutral detergent and wrung well, then wipe clean with a dry cloth.

• Since the unit may deteriorate in quality, become damaged or suffer surface wear, be careful about the following:

- DO NOT wipe it with a hard cloth.
- DO NOT wipe it with excessive force.
- DO NOT wipe it with thinner or benzine.
- DO NOT apply any volatile substance such as insecticides to it.
- DO NOT allow any rubber or plastic to remain in contact with it for a long time.

Troubleshooting

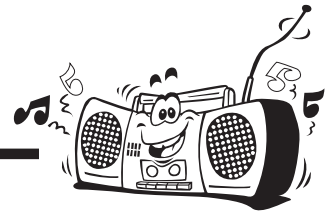

If you have a problem with your unit, check this list for a possible solution before calling for service.

If you cannot solve the problem from the hints given here, or the unit has been physically damaged, call a qualified person, such as your dealer, for service.

| Symptom | Cause | Action |
|---|--|--|
| Unable to cancel the display demonstration. | Other buttons are pressed to cancel the display demonstration. | Press CANCEL/DEMO on the unit. (See page 8.) |
| No sound is heard. | Connections are incorrect or loose. | Check all connections and make corrections. (See pages 6 to 8.) |
| Hard to listen to broadcasts because of noise. | <ul style="list-style-type: none"> Antennas are disconnected. The AM loop antenna is too close to the unit. The FM antenna is not properly extended and positioned. | <ul style="list-style-type: none"> Reconnect the antennas correctly and securely. Change the position and direction of the AM loop antenna. Extend the FM antenna at the best position. |
| The disc sound is discontinuous. | The disc is scratched or dirty. | Clean or replace the disc. (See page 31.) |
| The disc tray does not open or close. | <ul style="list-style-type: none"> The AC power cord is not plugged in. Tray is locked. | <ul style="list-style-type: none"> Plug the AC power cord. Unlock the tray. (See page 16.) |
| The disc does not play. | The disc is placed upside down. | Place the disc with the label side up. |
| The cassette holders cannot be opened. | Power supply from the AC power cord has been cut off while the tape was running. | Turn on the unit. |
| Impossible to record. | Small tabs on the back of the cassette are removed. | Cover the holes with adhesive tape. |
| Stereo effect is lost. | Karaoke is activated. | Cancel the Karaoke. (See page 26.) |
| Operations are disabled. | The built-in microprocessor may have malfunctioned due to external electrical interference. | Unplug the AC power cord and then plug it back in. |
| Unable to operate the unit from the remote control. | <ul style="list-style-type: none"> The path between the remote control and the remote sensor on the unit is blocked. The batteries are exhausted. | <ul style="list-style-type: none"> Remove the obstruction. Replace the batteries. |

Specifications

Design and specifications are subject to change without notice.

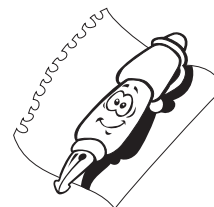

CA-MXSK3

Amplifier section

Output Power

MAIN SPEAKERS: 80 W per channel, min. RMS, both channels driven into 6 Ω at 1 kHz with no more than 0.9% total harmonic distortion.

SURROUND SPEAKER: 20 W per channel, min. RMS, both channels driven into 16 Ω at 1 kHz with no more than 0.9% total harmonic distortion.

Audio input sensitivity/Impedance

(Measured at 1 kHz, with tape recording signal 300 mV)

AUX: 400 mV/50 k Ω

MIC: 3 mV/10 k Ω

Tuner

FM tuning range: 87.50 MHz – 108.00 MHz

AM tuning range:

For Saudi Arabia:

At 9 kHz intervals: 531 kHz – 1 602 kHz

At 10 kHz intervals: 530 kHz – 1 600 kHz

For other countries:

At 9 kHz intervals: 531 kHz – 1 710 kHz

At 10 kHz intervals: 530 kHz – 1 710 kHz

CD player

CD capacity: 3 CDs

Dynamic range: 85 dB

Signal-to-noise ratio: 90 dB

Wow and flutter: Immeasurable

Cassette deck

Frequency response

Normal (type I): 50 Hz — 14 000 Hz

Wow and flutter: 0.15% (WRMS)

General

Power requirement: AC 110 V / AC 127 V / AC 220 V /
AC 230 V – AC 240 V \sim
(adjustable with the voltage selector),
50 Hz / 60 Hz

Power consumption: 110 W (at operation)
20 W (on standby)

Dimensions (approx.): 270 mm x 306 mm x 433.5 mm (W/H/D)

Mass (approx.): 9.3 kg

Supplied accessories

See page 6.

Speaker Specifications: SP-XSK3 (Main Speaker)

Type: 3-Way 3 Speaker Bass-Reflex
(Magnetically-Shielded Type)

Speakers

Main woofer : 15cm cone x 1
Mid Range : 5.0cm cone x 1
Tweeter : 2.0cm dome x 1

Power Handling Capacity

Main Speaker : 100 W

Impedance

Main Speaker : 6 Ω

Frequency Range

Main Speaker : 42 Hz – 30 000Hz

Sound Pressure Level

Main Speaker : 84 dB/W.m

Dimensions (W x H x D)

Main Speaker : 215mm x 306 mm x 243 mm

Mass

Main Speaker : 3.4 kg

Design and specifications subject to change without notice.

Speaker Specifications: SP-XSSK3 (Surround Speaker)

Type: Full range bass-reflex type

Speakers

Full range : 8cm cone x 1

Power Handling Capacity

: 30 W

Impedance

: 16 Ω

Frequency Range

: 85 Hz – 20 000Hz

Sound Pressure Level

: 83 dB/W.m

Dimensions (W x H x D)

: 160mm x 110 mm x 136 mm

Mass

: 0.55 kg

Design and specifications subject to change without notice.

CA-MXSK1**Amplifier section**

Output Power

MAIN SPEAKERS: 64 W per channel, min. RMS, both channels driven into 6 Ω at 1 kHz with no more than 0.9% total harmonic distortion.

Audio input sensitivity/Impedance

(Measured at 1 kHz, with tape recording signal 300 mV)

AUX: 400 mV/50 k Ω MIC: 3 mV/10 k Ω **Tuner**

FM tuning range: 87.50 MHz – 108.00 MHz

AM tuning range:

For Saudi Arabia:

At 9 kHz intervals: 531 kHz – 1 602 kHz

At 10 kHz intervals: 530 kHz – 1 600 kHz

For other countries:

At 9 kHz intervals: 531 kHz – 1 710 kHz

At 10 kHz intervals: 530 kHz – 1 710 kHz

CD player

CD capacity: 3 CDs

Dynamic range: 85 dB

Signal-to-noise ratio: 90 dB

Wow and flutter: Immeasurable

Cassette deck

Frequency response

Normal (type I): 50 Hz — 14 000 Hz

Wow and flutter: 0.15% (WRMS)

General

Power requirement: AC 110 V / AC 127 V / AC 220 V / AC 230 V – AC 240 V \sim
(adjustable with the voltage selector),
50 Hz / 60 Hz

Power consumption: 100 W (at operation)
20 W (on standby)

Dimensions (approx.): 270 mm x 306 mm x 433.5 mm (W/H/D)

Mass (approx.): 9.2 kg

Supplied accessories

See page 6.

Speaker Specifications: SP-MXSK1

Type: 3-Way 3 Speaker Bass-Reflex
(Magnetically-Shielded Type)

Speakers

Main woofer : 15cm cone x 1

Mid Range : 5.0cm cone x 1

Tweeter : 2.0cm dome x 1

Power Handling Capacity : 80 W

Impedance : 6 Ω

Frequency Range : 42 Hz – 30 000Hz

Sound Pressure Level : 84 dB/W.m

Dimensions (W x H xD) : 215mm x 306 mm x 243 mm

Mass : 3.4 kg

Design and specifications subject to change without notice.

Mains (AC) Line Instruction (not applicable for Europe, U.S.A., Canada, Australia, and U.K.)

دستور العمل مربوط به برق اصلی (AC) (غير قابل استفاده برای اروپا، آمریکا، کانادا، استرالیا و انگلیس)

تعليمات خط التيار الكهربائي الرئيسي (المتردد) (لا تنطبق على اورويما والولايات المتحدة الامريكية وكندا واستراليا و المملكة المتحدة)

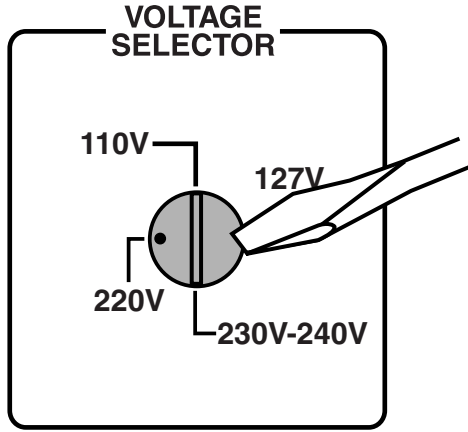

IMPORTANT for mains (AC) line
BEFORE PLUGGING IN, do check that your mains (AC) line voltage corresponds with the position of the voltage selector switch provided on the outside of this equipment and, if different, reset the voltage selector switch, to prevent from damage or risk of fire/electric shock.

نکته مهم برای خط برق اصلی (AC)
قبل از وارد کردن دوشاخه به پریز برق، حتما دقت کنید که ولتاژ برق اصلی (AC) شما با موقعیت سوئیچ انتخابگر ولتاژ که در بیرون این وسیله تعبیه شده همخوانی دارد و اگر متفاوت بود، برای احتراز از آسیب دستگاه یا خطر آتش سوزی / برق گرفتگی انتخابگر ولتاژ را مجدداً تنظیم نمایید.

هام من اجل خط التيار الكهربائي الرئيسي (المتردد)
قبل ادخال قاييس الطاقة الكهربائية، تأكد من تطابق مننتخب فولطية التيار الكهربائي الرئيسي (المتردد) الموجود على خلفية الجهاز مع فولطية التيار الكهربائي في بلدك. في حالة عدم التطابق، اعد ضبط مفتاح مننتخب الفولطية على فولطية التيار الكهربائي المتردد في بلدك. عدم عمل ذلك، يمكن يؤدي الى حصول ضرر او حريق او صدمة كهربائية.

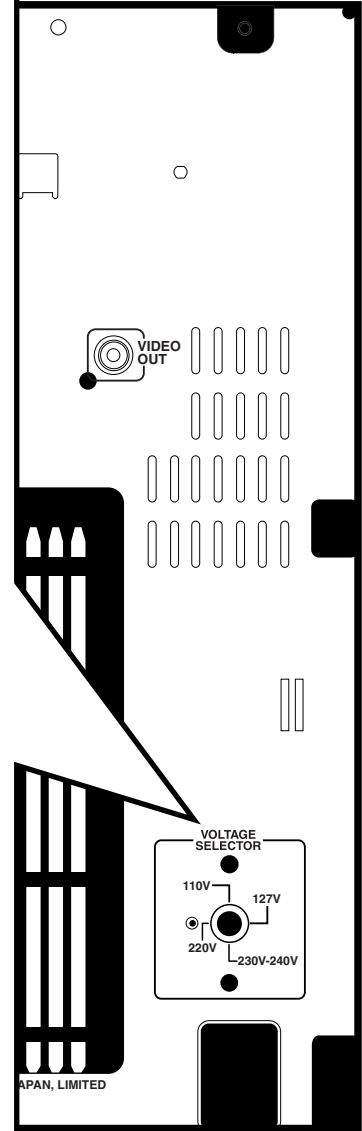

JVC

VICTOR COMPANY OF JAPAN, LIMITED

JVC

English

Türkçe

COMPACT COMPONENT SYSTEM AZ YER KAPLAYAN BİLEŞENLİ SİSTEMİ

MX-SK1 — Consists of **CA-MXSK1** and **SP-MXSK1** **CA-MXSK1 ve SP-MXSK1'den Oluşur**

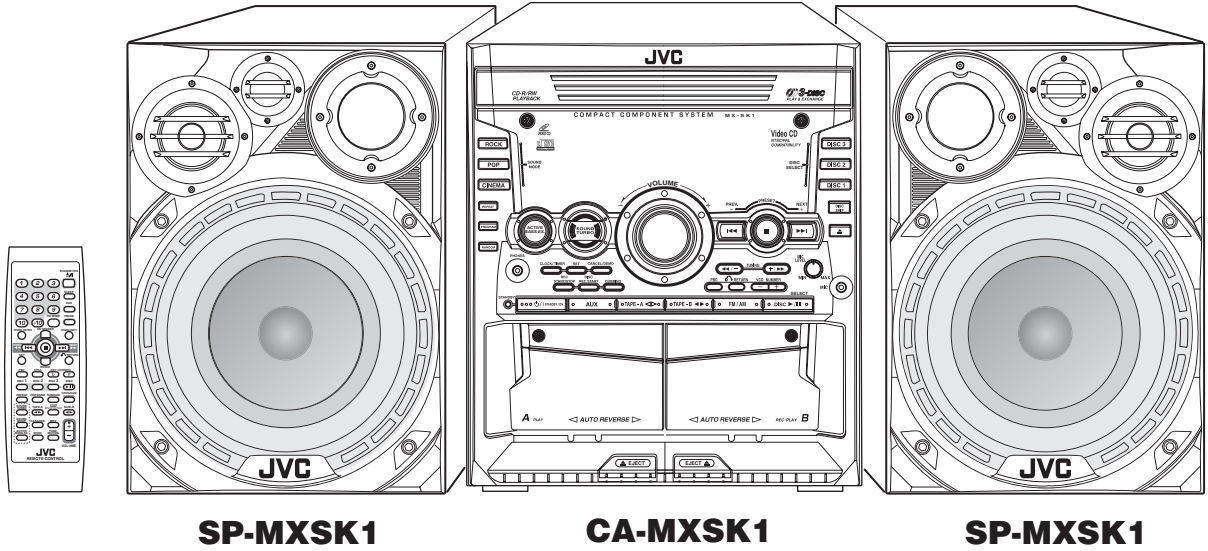

COMPACT
disc
DIGITAL VIDEO

COMPACT
disc
DIGITAL AUDIO

INSTRUCTIONS TALİMATLAR

GVT0120-003A
[UE]

Warnings, Cautions and Others

Uyarılar, Dikkatler ve Diğerleri

CAUTION — button!

Disconnect the mains plug to shut the power off completely (the STANDBY/ON lamp goes off). The  button in any position does not disconnect the mains line.

- When the unit is on standby, the STANDBY/ON lamp lights red.

The power can be remote controlled.

CAUTION

To reduce the risk of electrical shocks, fire, etc.:

1. Do not remove screws, covers or cabinet.
2. Do not expose this appliance to rain or moisture.

Dikkat — düğmesi!

Cihazı tamamen kapatmak için elektrik fişini prizden çıkartın (STANDBY/ON lambası kapanır).  düğmesi, hiçbir konumda ana elektrik beslemesini kesmez.

- Cihaz bekleme durumundayken, STANDBY/ON lambası kırmızı renkte yanar.

Cihazın açılıp kapanması, uzaktan kumanda ile idare edilebilir.

DIKKAT

Elektrik çarpmaları, yangın vs. riskini azaltmak için:

1. Vidaları, kapakları ya da kabini çıkartmayın.
2. Cihazı, yağmura ya da neme maruz bırakmayın.

CAUTION

- Do not block the ventilation openings or holes. (If the ventilation openings or holes are blocked by a newspaper or cloth, etc., the heat may not be able to get out.)
- Do not place any naked flame sources, such as lighted candles, on the apparatus.
- When discarding batteries, environmental problems must be considered and local rules or laws governing the disposal of these batteries must be followed strictly.
- Do not expose this apparatus to rain, moisture, dripping or splashing and that no objects filled with liquids, such as vases, shall be placed on the apparatus.

DIKKAT

- Havalandırma açıklıklarını ve deliklerini tıkamayın. (Havalandırma açıklıkları ya da delikleri gazete ya da bezle vs. kapanırsa, cihazın içindeki ısı dışarı çıkamayabilir).
- Yanan mum gibi açık aleve sahip malzemeleri cihazın üzerine yerleştirmeyin.
- Pilleri atarken çevresel sorunlar dikkate alınmalı ve pillerin atılmasıyla ilgili yerel kurallara ya da yasalara kesinlikle uyulmalıdır.
- Cihazı yağmura, neme, su damalarına ya da sıçramasına maruz bırakmayın. Cihazın üzerine vazolar gibi içi sıvı dolu nesnelere yerleştirmeyin.



MX-SK1: 18.7 kg

CAUTION!

To avoid personal injury or accidentally dropping the unit, have two persons unpack, carry, and install the unit.

DIKKAT!

Kişisel yaralanmayı ya da ünitenin düşürülmesini önlemek için ünitenin koliden çıkarılması, taşınması ve monte edilmesi iki kişi tarafından gerçekleştirilmelidir.

Caution: Proper Ventilation

To avoid risk of electric shock and fire, and to prevent damage, locate the apparatus as follows:

- 1 Front: No obstructions and open spacing.
- 2 Sides/ Top/ Back: No obstructions should be placed in the areas shown by the dimensions below.
- 3 Bottom: Place on the level surface. Maintain an adequate air path for ventilation by placing on a stand with a height of 10 cm or more.

Dikkat: Düzgün Havalandırma

Elektrik çarpması ve yangın riskini ortadan kaldırmak ve olası hasarları önlemek için cihazı aşağıda belirtilen şekilde yerleştirin:

- 1 Ön: Engel yok ve açık aralık.
- 2 Yan/ Üst/ Arka: Aşağıdaki ölçülerle gösterilen alanlarda herhangi bir engel bulunmamalıdır.
- 3 Alt: Düz bir yüzeye yerleştirin. 10 cm ya da daha yüksek bir stand üzerine yerleştirerek havalandırma için yeterli açıklığı sağlayın.

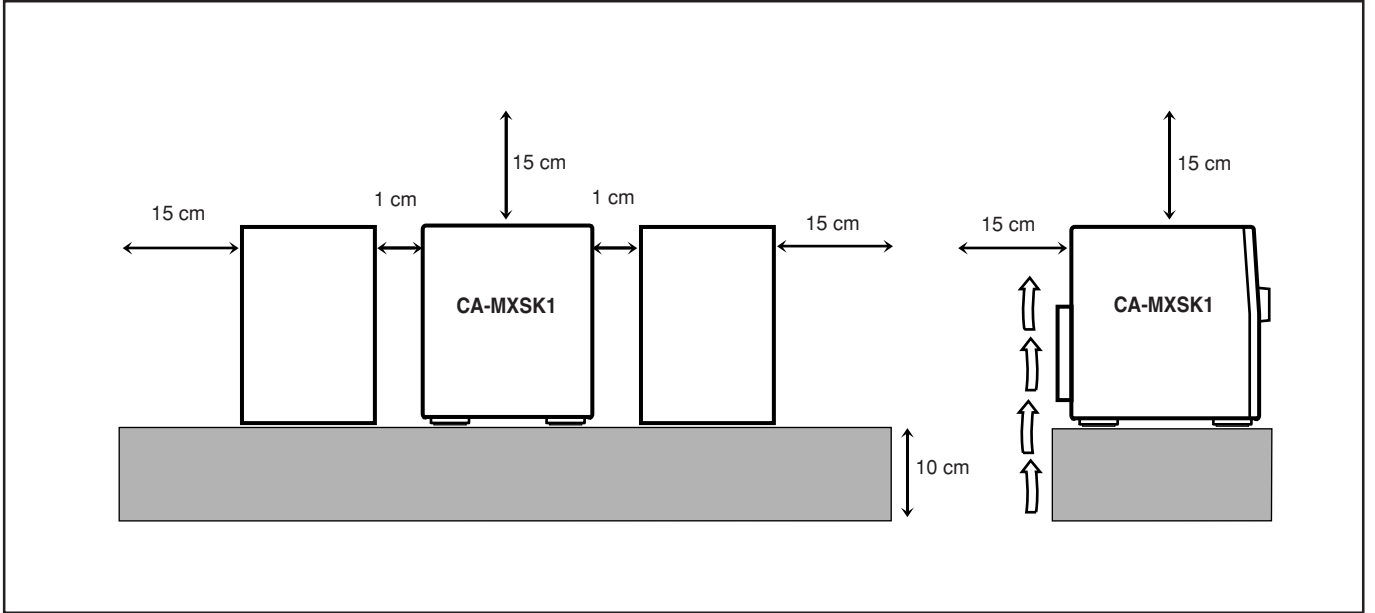

IMPORTANT FOR LASER PRODUCTS

1. CLASS 1 LASER PRODUCT
2. **CAUTION:** Do not open the top cover. There are no user serviceable parts inside the unit; leave all servicing to qualified service personnel.
3. **CAUTION:** Visible and invisible laser radiation when open and interlock failed or defeated. Avoid direct exposure to beam.
4. REPRODUCTION OF LABEL: CAUTION LABEL, PLACED INSIDE THE UNIT.

LAZER ÜRÜNLERİ İÇİN ÖNEMLİ

1. SINIF 1 LAZER ÜRÜNÜ
2. **DİKKAT:** Üst kapağı açmayın. Cihazın içinde kullanıcı tarafından müdahale edilebilecek hiçbir parça yoktur. Tüm servis işlemlerini, uzman servis personelinin yapmasını sağlayın.
3. **DİKKAT:** Görünür ve açıldığında ve güvenlik kilitleri bozulduğunda ya da devre dışı bırakıldığında görünür ve görünmez lazer radyasyonu. Doğrudan hüzmeye maruz kalmayın.
4. ETİKETLERİN KOPYASI: CİHAZIN İÇİNE YERLEŞTİRİLMİŞ DİKKAT ETİKETİ.

CAUTION : Visible and invisible laser radiation when open and interlock failed or defeated. AVOID DIRECT EXPOSURE TO BEAM. (e)

WARNING : Synlig och osynlig laserstrålning när den öppnas och spärren är urkopplad. Betrakta ej strålen. (s)

ADVARSEL : Synlig og usynlig laserstråling når maskinen er åben eller interlocken fejler. Undgå direkte eksponering til stråling. (d)

VARO : Avattaessa ja suojauslaitus ohitettuna tai viallisena olet alttiina näkyvälle ja näkymättömälle lasersäteilylle. Vältä säteen kohdistumista suoraan itseesi. (f)

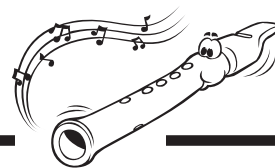

We would like to thank you for purchasing one of our JVC products. Before operating this unit, read this manual carefully and thoroughly to obtain the best possible performance from your unit, and retain this manual for future reference.

About This Manual

This manual is organized as follows:

- The manual mainly explains operations using the buttons and controls on the unit. You can also use the buttons on the remote control if they have the same or similar names (or marks) as those on the unit. If operation using the remote control is different from that using the unit, it is then explained.
- Basic and common information that is the same for many functions is grouped in one place, and is not repeated in each procedure. For instance, we do not repeat the information about turning on/off the unit, setting the volume, changing the sound effects, and others, which are explained in the section “Common Operations” on pages 9 to 11.
- The following marks are used in this manual:



Gives you warnings and cautions to prevent from damage or risk of fire/electric shock. Also gives you information which is not good for obtaining the best possible performance from the unit.



Gives you information and hints you had better know.

Precautions

Installation

- Install in a place which is level, dry and neither too hot nor too cold — between 5°C (41°F) and 35°C (95°F).
- Install the unit in a location with adequate ventilation to prevent internal heat buildup in the unit.
- Leave sufficient distance between the unit and the TV.
- Keep the speakers away from the TV to avoid interference with TV.



DO NOT install the unit in a location near heat sources, or in a place subject to direct sunlight, excessive dust or vibration.

Power sources

- When unplugging from the wall outlet, always pull the plug, not the AC power cord.



DO NOT handle the AC power cord with wet hands.

Moisture condensation

Moisture may condense on the lens inside the unit in the following cases:

- After starting heating in the room
 - In a damp room
 - If the unit is brought directly from a cold to a warm place
- Should this occur, the unit may malfunction. In this case, leave the unit turned on for a few hours until the moisture evaporates, unplug the AC power cord, and then plug it in again.

Others

- Should any metallic object or liquid fall into the unit, unplug the unit and consult your dealer before operating any further.
- If you are not going to operate the unit for an extended period of time, unplug the AC power cord from the wall outlet.



DO NOT disassemble the unit since there are no user serviceable parts inside.

If anything goes wrong, unplug the AC power cord and consult your dealer.

Which compact discs can be used?

Many types of compact discs are sold for a variety of uses. The player can play the following compact discs:

Video CD discs both with and without PBC

Audio CD discs



Discs you cannot playback

Any other discs than listed above (such as CD-ROM, DVD, CD-G or CD-I Discs) cannot be played. Playing back such discs may generate noise and damage your speakers. Even though a logo listed above is printed on the disc, it may not be played if it is a non-standard disc.

Contents

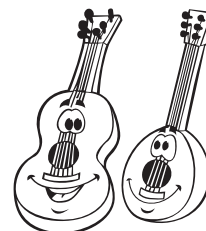

| | | | |
|---|-----------|---|-----------|
| Location of the Buttons and Controls | 3 | MP3 Disc Playback | 21 |
| Remote Control | 3 | Basic operations | 21 |
| Front Panel | 4 | Programming tracks | 21 |
| Getting Started | 6 | Playing Back Tapes | 23 |
| Supplied Accessories | 6 | Playing Back a Tape | 23 |
| Putting the Batteries into the Remote Control | 6 | Recording | 24 |
| Connecting Antennas | 6 | Recording a Tape on Deck B | 24 |
| Connecting Speakers | 7 | Dubbing Tapes | 25 |
| Connecting Other Equipment | 8 | CD Direct Recording | 25 |
| Adjusting the Voltage Selector | 8 | Using the Microphones | 26 |
| Cancelling the Display Demonstration | 8 | Singing along — Karaoke | 26 |
| Common Operations | 9 | Singing Along with Multiplex Karaoke Discs (MPX) | 26 |
| Turning On or Off the Power | 9 | Recording Your Singing | 27 |
| Setting the Clock | 9 | Adjusting the Music Key Control (for CD play only) | 27 |
| Setting the AM Tuner Interval Spacing | 9 | Using the Timers | 28 |
| Selecting the Sources | 10 | Using Daily Timer and Recording timer | 28 |
| Adjusting the Volume | 10 | Using Sleep Timer | 30 |
| Reinforcing the Bass Sound (ACTIVE BASS EX.) .. | 10 | Maintenance | 31 |
| Emphasizing the sound (SOUND TURBO)..... | 10 | Troubleshooting | 32 |
| Selecting the Sound Modes | 11 | Specifications | 33 |
| Listening to FM and AM Broadcasts | 12 | | |
| Tuning in a Station | 12 | | |
| Presetting Stations | 12 | | |
| Tuning in a Preset Station | 12 | | |
| Playing Back CDs (CD/CD-R/CD-RW) | 13 | | |
| Loading CDs | 13 | | |
| Playing Back the Entire Discs | | | |
| — Continuous Play | 14 | | |
| Basic CD Operations | 14 | | |
| Programming the Playing Order of the Tracks | | | |
| — Program Play | 15 | | |
| Playing at Random — Random Play | 16 | | |
| Repeating Tracks or CDs — Repeat Play | 16 | | |
| Prohibiting Disc Ejection — Tray Lock | 16 | | |
| Playing Back Video CDs | 17 | | |
| Selecting Video Output (PAL, PAL AUTO, NTSC) ... | 17 | | |
| Loading Discs | 17 | | |
| Playing a Video CD | 17 | | |
| Playing Video CDs with PBC Function | | | |
| — Menu Play | 18 | | |
| Basic Concept of the PBC function | 18 | | |
| Playing Video CDs without PBC | | | |
| — Continuous Play | 19 | | |
| Resuming Play | 19 | | |
| Special Plays for a Video CD | 19 | | |
| Playing a Multiplex Sound CD | 20 | | |

Location of the Buttons and Controls

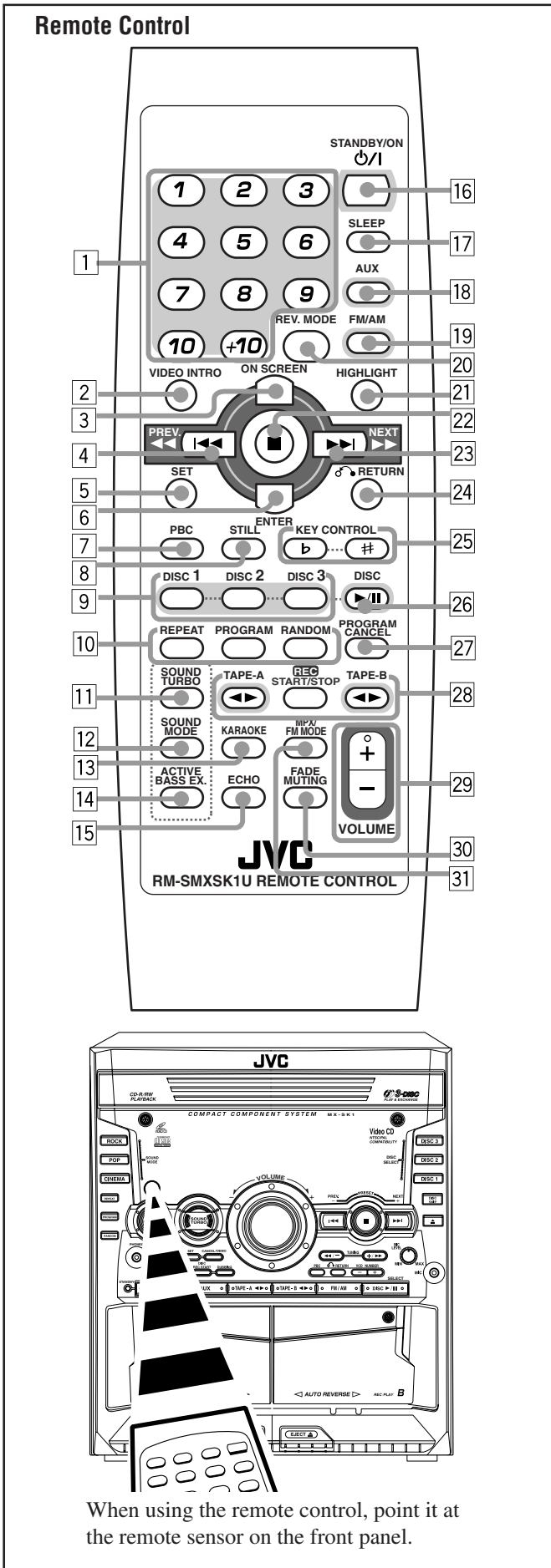

When using the remote control, point it at the remote sensor on the front panel.

Remote Control

See pages in the parentheses for details.

- 1 Number buttons (12, 14 – 15, 18 – 21)
- 2 VIDEO INTRO button (19)
- 3 ON SCREEN button (19)
- 4 PREV. ◀◀ (◀◀) button (12, 14 – 15, 18 – 19, 21 – 23)
- 5 SET button (15)
- 6 ENTER button (21)
- 7 PBC button (18 – 19)
- 8 STILL button (19)
- 9 Disc number buttons (DISC 1, DISC 2, and DISC 3) (14 – 15, 17, 19, 21)
Pressing one of these buttons also turns on the unit.
- 10 CD play mode buttons
 - REPEAT button (16)
 - PROGRAM button (15, 21)
 - RANDOM button (16, 21)
- 11 SOUND TURBO button (10)
- 12 SOUND MODE button (11)
- 13 KARAOKE button (26)
- 14 ACTIVE BASS EX. button (10)
- 15 ECHO button (26)
- 16 STANDBY/ON ⏻/⏻ button (9, 29)
- 17 SLEEP button (30)
- 18 AUX button (10)
Pressing this button also turns on the unit.
- 19 FM/AM button (10, 12)
Pressing this button also turns on the unit.
- 20 REV. MODE button (23, 25)
- 21 HIGHLIGHT button (20)
- 22 ■ (stop) button (14 – 25, 27)
- 23 NEXT ▶▶ (▶▶) button (12, 14 – 16, 18 – 23)
- 24 ⏪ RETURN button (18)
- 25 KEY CONTROL **b** / # buttons (27)
- 26 DISC ▶/|| button (10, 14 – 19, 21)
Pressing this button also turns on the unit.
- 27 PROGRAM CANCEL button (15)
- 28 Tape operation buttons
 - TAPE-A ◀▶ button (10, 23 – 24)
Pressing this button also turns on the unit.
 - REC START/STOP button (24)
 - TAPE-B ◀▶ button (10, 23 – 24)
Pressing this button also turns on the unit.
- 29 VOLUME + and – buttons (10, 26 – 27)
- 30 FADE MUTING buttons (10)
- 31 MPX/FM MODE buttons (12, 20, 26)

Become familiar with the buttons and controls on your unit.

Front Panel

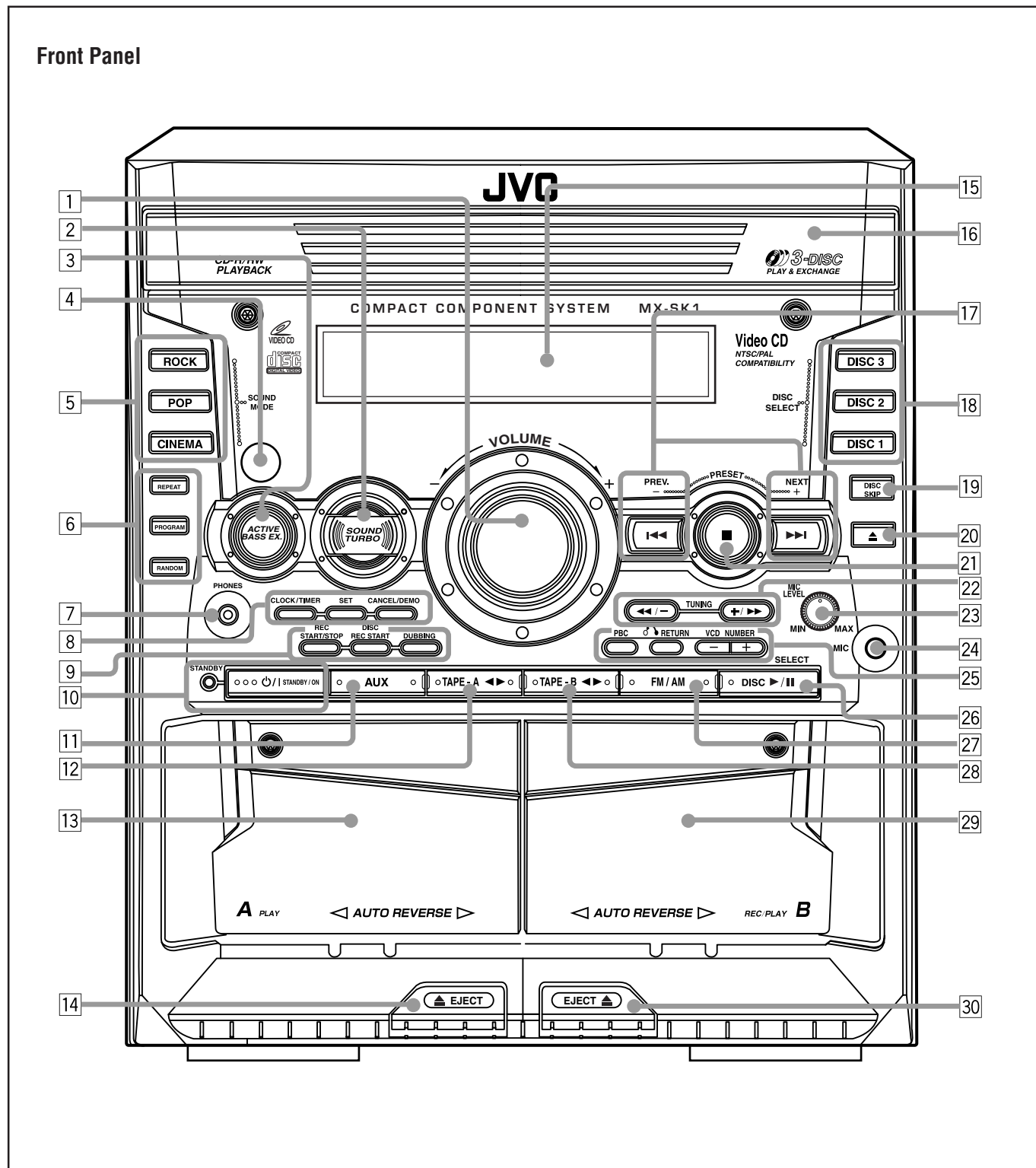

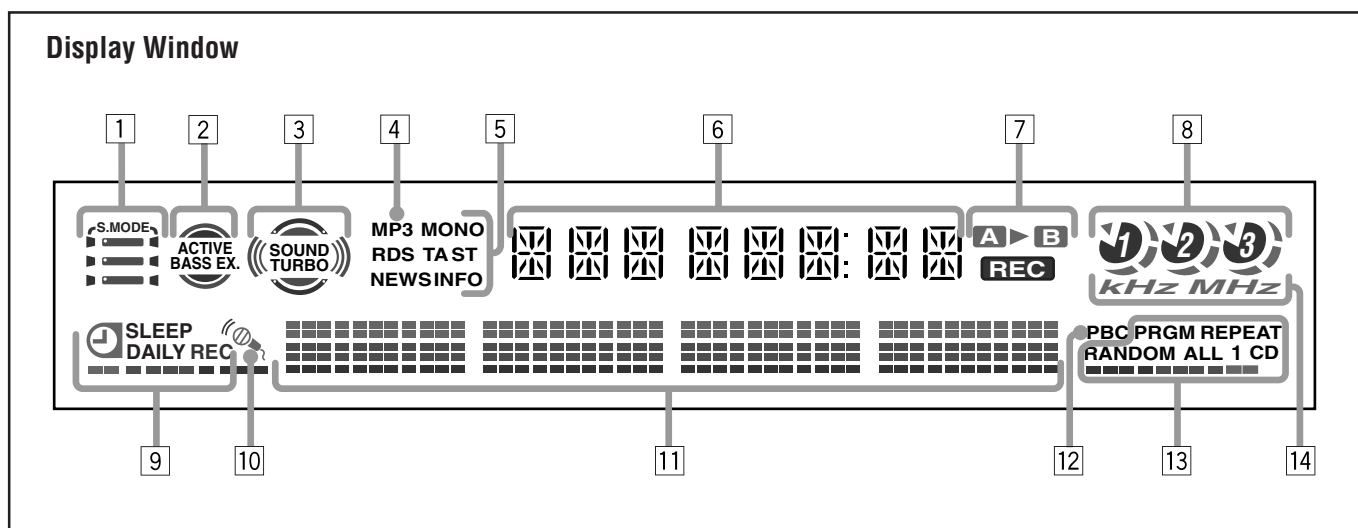

See pages in the parentheses for details.

Front Panel

- 1 VOLUME + / - control (10, 26 – 27)
- 2 SOUND TURBO button (10)
- 3 ACTIVE BASS EX. button (10)
- 4 Remote sensor
- 5 Sound mode buttons (11)
 - ROCK button
 - POP button
 - CINEMA button
- 6 CD play mode buttons
 - REPEAT button (16)
 - PROGRAM button (15, 21)
 - RANDOM button (16, 21)
- 7 PHONES jack (10)
- 8 CLOCK/TIMER button (9, 28 – 29)
SET button (9, 12, 15, 21)
CANCEL/DEMO button (8, 15, 22,)
- 9 Recording buttons
 - REC START/STOP button (24)
 - DISC REC START button (25)
 - DUBBING button (25)
- 10 STANDBY/ON button and STANDBY lamp (9, 16, 29)
- 11 AUX button (10)
Pressing this button also turns on the unit.
- 12 TAPE-A button (10, 23 – 24)
Pressing this button also turns on the unit.
- 13 Deck A cassette holder (23)
- 14 EJECT button for deck A (23)
- 15 Display window
- 16 Disc tray
- 17 PRESET PREV. - and NEXT + buttons
 and (reverse search/forward search) buttons (9, 12, 14 – 15, 18, 21 – 22, 28 – 29)
- 18 Disc number buttons (DISC 1, DISC 2, and DISC 3) (14 – 15, 17, 19 – 20, 25)
Pressing one of these buttons also turns on the unit.
- 19 DISC SKIP button (13, 17)
- 20 (Disc tray open/close) button (13 – 14, 16 – 17)
Pressing one of these buttons also turns on the unit.

- 21 (stop) button (14 – 25, 27)
- 22 TUNING + and - buttons (12)
 and (fast left/fast right) buttons (14, 23)
- 23 MIC LEVEL control (26 – 27)
- 24 MIC jack (26)
- 25 Video CD buttons
 - PBC button (18 – 19)
 - RETURN button (18)
 - VCD NUMBER + / - buttons (18)
- 26 DISC SELECT (play/pause) button (10, 14 – 19, 21)
Pressing this button also turns on the unit.
- 27 FM/AM button (12)
Pressing this button also turns on the unit.
- 28 TAPE-B button (10, 23 – 24)
Pressing this button also turns on the unit.
- 29 Deck B cassette holder (23 – 24)
- 30 EJECT button for deck B (23 – 24)

Display Window

- 1 S. MODE (SOUND MODE) indicator
- 2 ACTIVE BASS EX. indicator
- 3 SOUND TURBO indicator
- 4 MP3 indicator
- 5 Tuner operation indicators
 - MONO and ST (stereo) indicators
- 6 Main display
 - Shows the source name, frequency, etc.
- 7 Tape operation indicators
 - A/B (operating deck) and **REC** (recording)
- 8 Disc indicators
- 9 Timer indicators
 - (Timer), DAILY (Daily Timer), REC (Recording Timer), and SLEEP (Sleep Timer) indicators
- 10 Karaoke () and echo () indicators
- 11 Audio level indicator
- 12 PBC indicator
- 13 CD play mode indicators
 - REPEAT (ALL/1/CD), PRGM (program), and RANDOM indicators
- 14 Radio frequency indicators
 - kHz and MHz indicators

Getting Started



Supplied Accessories

Make sure that you have all the following items. The number in the parentheses indicates the quantity of the pieces supplied.

- AM loop antenna (1)
- FM antenna (1)
- Remote control (1)
- Batteries (2)
- AC plug adaptor (1)
- Video cord (1)

If anything is missing, consult your dealer immediately.

Putting the Batteries into the Remote Control

Insert the batteries — R6(SUM-3)/AA(15F) — into the remote control, by matching the polarity (+ and –) on the batteries with the + and – markings on the battery compartment.

When the remote control can no longer operate the unit, replace both batteries at the same time.

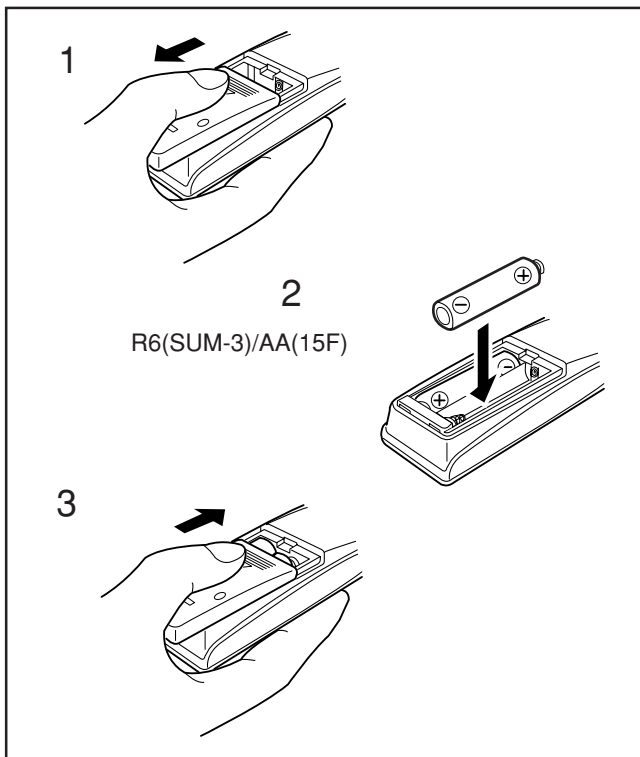

- DO NOT use an old battery together with a new one.
- DO NOT use different types of batteries together.
- DO NOT expose batteries to heat or flame.
- DO NOT leave the batteries in the battery compartment when you are not going to use the remote control for an extended period of time. Otherwise, it will be damaged from battery leakage.

Connecting Antennas

FM antenna

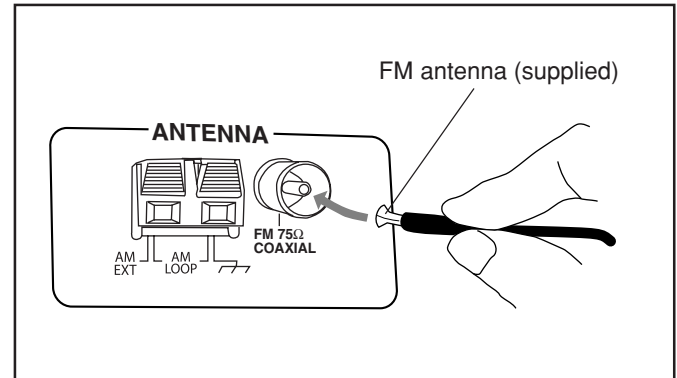

- 1 Attach the FM antenna to the FM 75 Ω COAXIAL terminal.
- 2 Extend the FM antenna.
- 3 Fasten it up in the position which gives you the best reception, then fix it on the wall, etc.



About the supplied FM antenna

The FM antenna supplied with this unit can be used as temporary measure. If reception is poor, you can connect an outdoor FM antenna.

To connect an outdoor FM antenna

Before connecting it, disconnect the supplied FM antenna.

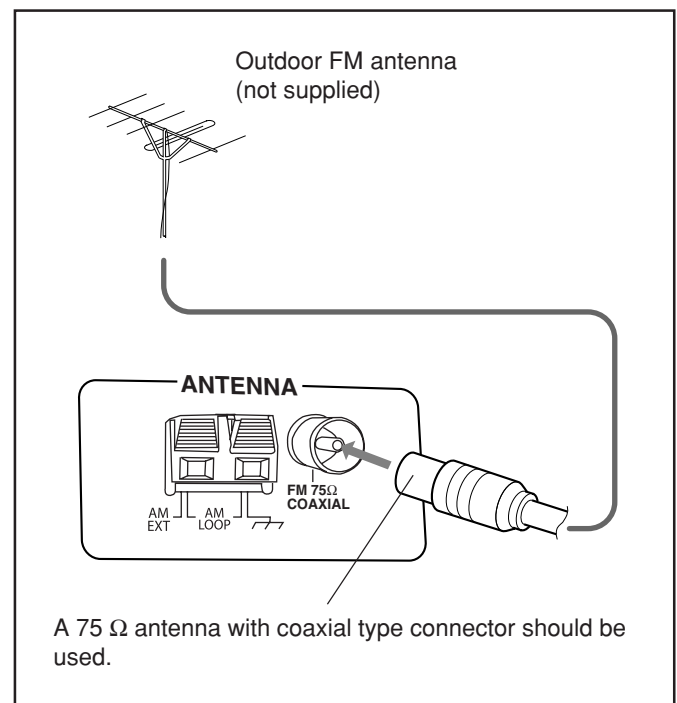

AM antenna

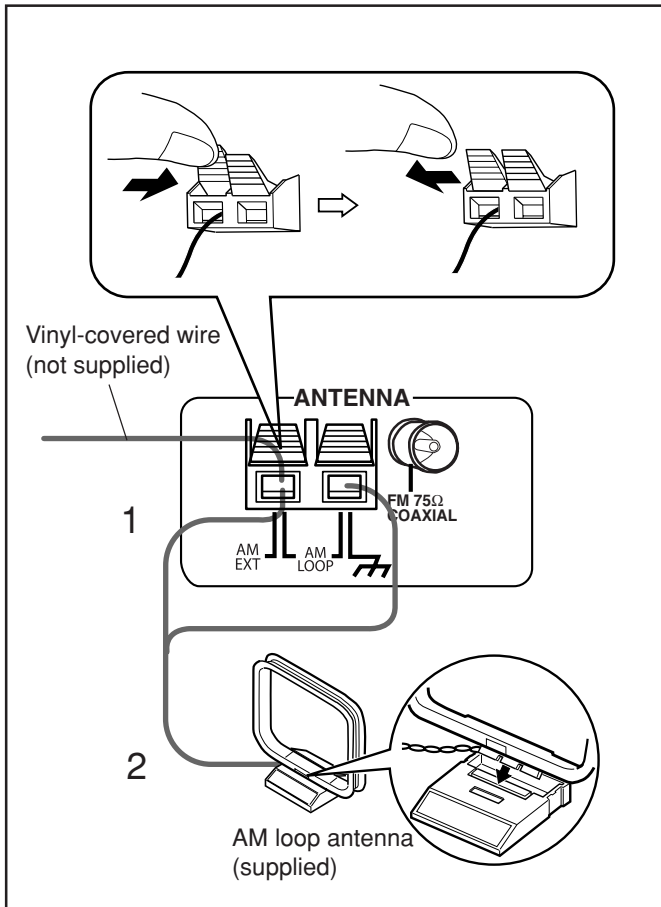

1 Connect the AM loop antenna to the AM LOOP terminals as illustrated.

- If the AM loop antenna wire is covered with vinyl, remove the vinyl by twisting it as shown in the diagram.

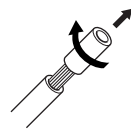

2 Turn the AM loop antenna until you have the best reception.

To connect an outdoor AM antenna

When reception is poor, connect a single vinyl-covered wire to the AM EXT terminal and extend it horizontally. The AM loop antenna must remain connected.



For better reception of both FM and AM

- Make sure the antenna conductors do not touch any other terminals and connecting cords.
- Keep the antennas away from metallic parts of the unit, connecting cords, and the AC power cord.

Connecting Speakers

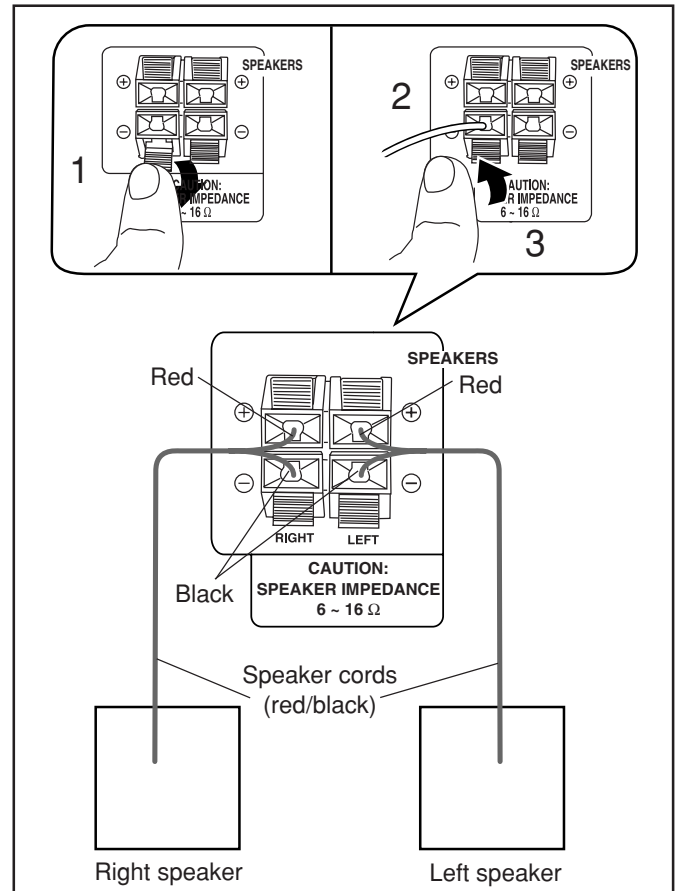

1 Press and hold the clamp of the speaker terminals on the rear of the unit.

2 Insert the end of the speaker cord into the terminal.

Match the polarity (colours) of the speaker terminals: Red (+) to red (+) and black (-) to black (-).

3 Release your finger from the clamp to close the speaker terminals.

Speaker Setting For A/V Combination

SP-MXSK1 have a magnetically-shielded design for placement adjacent to TV's and monitors without causing color aberrations. However, color may be affected by the way of installing the speaker system. Therefore, please take note of the following:

1. When placing these speakers near a TV set, turn off TV's main power switch or unplug it before installing the speakers. Wait at least 30 minutes after the system is installed before turning on the TV's power.
2. If another speaker system has been set up near the TV set, that system may cause color unevenness in the TV's picture.
3. In spite of the shielded design of these speakers, some of the TV types may be affected by them. If this happens, move the speakers to a short distance away from the TV set.

IMPORTANT: Use only speakers with the same speaker impedance as indicated by the speaker terminals on the rear of the unit.

Connecting Other Equipment

You can connect both analog and digital equipment.



- DO NOT connect any equipment while the power is on.
- DO NOT plug in any equipment until all connections are complete.

To connect an analog component

Be sure that the plugs of the audio cords are coloured: White plugs and jacks are for left audio signals, and red ones for right audio signals.

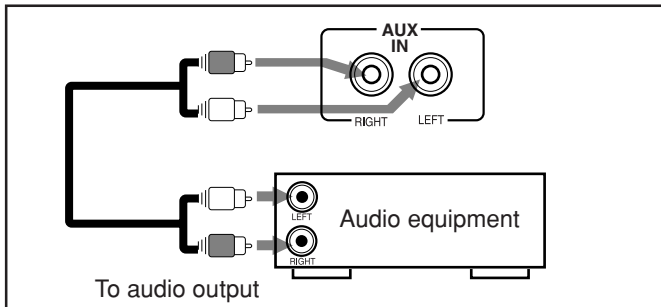

For playing the other equipment through this unit, connect between the audio output jacks on the other equipment and AUX jacks by using audio cords (not supplied).

Adjusting the Voltage Selector

Before plugging in the unit, set the correct voltage for your area with the voltage selector on the rear of the unit.

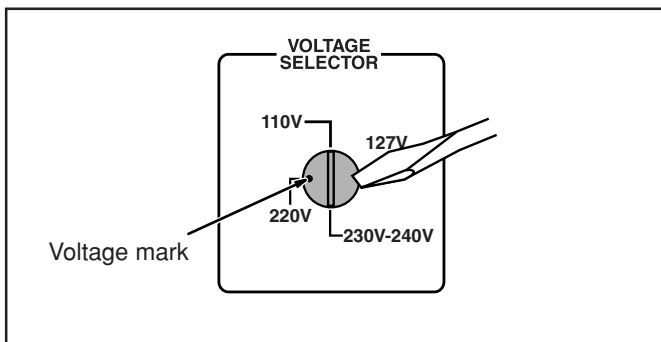

Use a screwdriver to rotate the voltage selector so the voltage number the voltage mark is pointing at is the same as the voltage where you are plugging in the unit. (See the back cover page.)



DO NOT plug in before setting the voltage selector on the rear of the unit and all connection procedures are complete.

Now, you can plug in the AC power cord.

When connecting the AC power cord to a wall outlet, the unit automatically starts display demonstration.

- If the wall outlet does not match the AC plug, use the supplied AC plug adaptor.

IMPORTANT: Be sure to check all connections to be done before plugging the AC power cord into a wall outlet.

Cancelling the Display Demonstration

On the unit ONLY:

To cancel the display demonstration, press CANCEL/DEMO during demonstration, “DEMO OFF” will appear on the display.

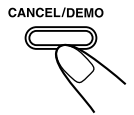

When you press other buttons

The display demonstration stops temporarily. It will start automatically again (if no operation is done for 2 minutes) unless you cancel it by pressing CANCEL/DEMO.

To start the display demonstration manually

Press and hold CANCEL/DEMO again for more than 3 seconds.

Common Operations

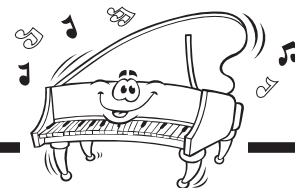

Turning On or Off the Power

To turn on the unit, press STANDBY/ON so that the STANDBY lamp goes off.

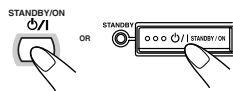

POWER ON

To turn off the unit (on standby), press STANDBY/ON again so that the STANDBY lamp lights up.

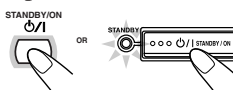

- A little power is always consumed even while the unit is on standby.

To switch off the power supply completely, unplug the AC power cord from the AC outlet.



When you unplug the AC power cord or if a power failure occurs

The clock is reset to "0:00" right away, while the tuner preset stations (see page 12) will be erased in a few days.

Setting the Clock

Before operating the unit any further, first set the built in clock. You can set the clock whether the unit is on or off.

On the unit ONLY:

- 1 Press **CLOCK/TIMER**.
The hour digit start flashing on the display.

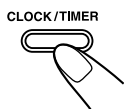

- 2 Press **◀◀** or **▶▶** to adjust the hour, then press **CLOCK/TIMER** to set the hour.

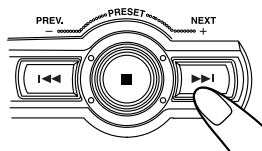

SET appear on display.
The minute digits start flashing on the display.



- 3 Press **◀◀** or **▶▶** to adjust the minute, then press **CLOCK/TIMER** to set the minute. SET appear on display.

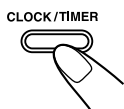

SET

To adjust the clock again

Make sure the (timer) indicator is not lit on the display.

- If it is lit, press and hold **CLOCK/TIMER** until it goes off. If you have adjusted the clock before, you need to press **CLOCK/TIMER** repeatedly until the clock setting mode is selected.
- Each time you press the button, the clock/timer setting modes change as follows:

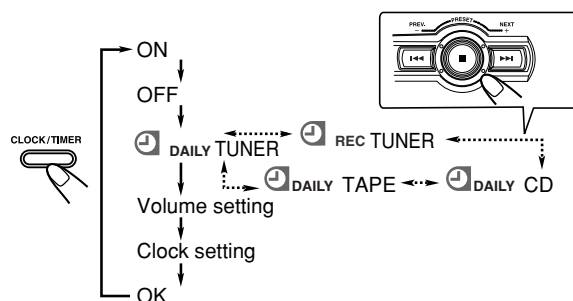

When you unplug the AC power cord or if a power failure occurs

The clock loses the setting and is reset to "0:00." You need to set the clock again. The clock may gain or lose 1 to 2 minutes per month. If this happens, set the clock again.

Setting the AM Tuner Interval Spacing

Some countries space AM stations 9 kHz apart, and some countries use 10 kHz spacing.

On the unit ONLY:

You can only change the AM tuner interval spacing while in **STANDBY MODE**.

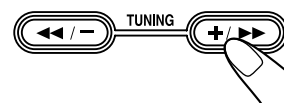

Press STANDBY/ON while holding down **+▶▶** for 10 kHz or **-◀◀** for 9 kHz interval spacing when you change the setting.



The preset stations are erased. You will need to preset the station again.

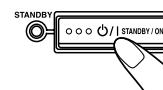

Selecting the Sources

To listen to the FM/AM broadcasts, press FM/AM.

(See page 12.)

To playback CDs, press DISC ►/||. (See pages 13 – 16.)

To playback tapes, press TAPE-A ◀▶ or TAPE-B ◀▶.

(See page 23.)

To select the external equipment as the source, press AUX.



When you press the play button for a particular source (FM/AM, DISC ►/||, TAPE-A ◀▶, TAPE-B ◀▶ and AUX), the unit turns on (and the unit starts playing the source if it is ready — COMPU PLAY CONTROL).



About the audio level indicator

All the audio level indicators light up when no signals come in. The audio level indicators light up when no signal comes in during AUX. The audio level indicators does not represent actual audio level. This is not a spectrum analyzer display.

Adjusting the Volume

You can adjust the volume level only while the unit is turned on. The volume level can be adjusted in 32 steps (VOL MIN, VOLUME 1 — VOLUME 30 and VOL MAX).

Turn VOLUME + / – clockwise (+) to increase the volume or counterclockwise (–) to decrease it.

VOLUME 15

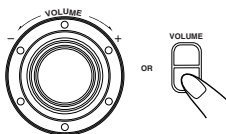

When using the remote control, press VOLUME + to increase the volume or press VOLUME – to decrease it.



For private listening

Connect a pair of headphones to the PHONES jack. No sound comes out of the speakers. Be sure to turn down the volume before connecting or putting on headphones.



DO NOT turn off (on standby) the unit with the volume set to an extremely high level; otherwise, a sudden blast of sound can damage your hearing, speakers and/or headphones when you turn on the unit or start playing any source next time. REMEMBER you cannot adjust the volume level while the unit is on standby.

To turn down the volume level temporarily

Press FADE MUTING on the remote control.

The volume level gradually decreases to “VOL MIN.”



To restore the sound, press the button again.

Reinforcing the Bass Sound (ACTIVE BASS EX.)

The richness and fullness of the bass sound is maintained regardless of how low you set the volume.



You can use this effect only for playback.

To get the effect, press ACTIVE BASS EX. (Extension).

ACTIVE BASS EX. indicator lights up on the display.

To cancel the effect, press the button again.

ACTIVE BASS EX. indicator lights up.

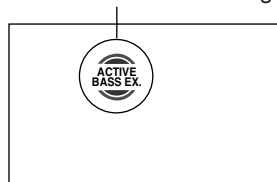

Emphasizing the sound (SOUND TURBO)

High and low frequencies are highly boosted.

To get the effect, press SOUND TURBO.

SOUND TURBO indicator lights up on the display.

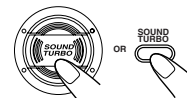

To cancel the effect, press the button again.

SOUND TURBO indicator lights up.

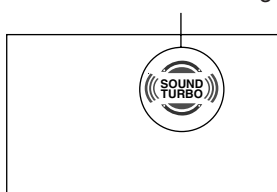

Select Sound Turbo function will turn the Sound Mode off. While the Sound Turbo turns off, the Sound Mode automatically restores to previous setting.

Selecting the Sound Modes

You can select one of the 3 SEA (Sound Effect Amplifier) modes. This function only affects the playback sound, but does not affect your recording.

On the unit:

Press the sound mode button you want to get the effect of ROCK, POP, or CINEMA. The selected Sound Mode name "ROCK", "POP", or "CINEMA" appears on the display. Also, the Sound Mode indicator that corresponds to the selected sound mode blinks.



The SOUND MODE indicator also lights up on the display.

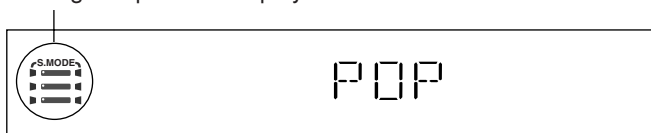

To cancel the effect, press the selected mode button again.

On the remote control:

To select the sound modes, press SOUND MODE until the sound mode you want appears on the display.



- The sound modes change as follows:

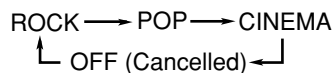

SEA (Sound Effect Amplifier) modes:

ROCK: Boosts low and high frequency. Good for acoustic music.

POP: Good for vocal music.

CINEMA: Good for special effect sound from movie.

OFF: The sound mode is cancelled. The SOUND MODE bar indicator goes off.



Select any Sound Modes will turn off Sound Turbo.

Listening to FM and AM Broadcasts



Tuning in a Station

1 Press FM/AM.

The unit automatically turns on and tunes in the previously tuned station (either FM or AM).

- Each time you press the button, the band alternates between FM and AM.

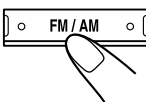

2 Start searching for stations.

On the unit:

Press and hold TUNING +/▶▶ or TUNING ◀◀/- for more than 1 second.

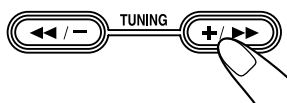

On the remote control:

Press and hold ▶▶ (NEXT ▶▶) or ◀◀ (PREV. ◀◀) for more than 1 second.

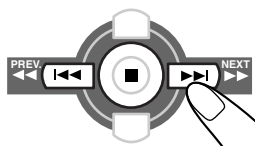

The unit starts searching for stations and stops when a station of sufficient signal strength is tuned in.

- If a program is broadcasted in stereo, the ST (stereo) indicator lights up.

On the unit:

To stop searching, press TUNING +/▶▶ or TUNING ◀◀/-.



When you press TUNING +/▶▶ or TUNING ◀◀/- briefly and repeatedly

The frequency changes step by step.

To change the FM reception mode

When an FM stereo broadcast is hard to receive or noisy, press FM MODE on the remote control so that the MONO indicator lights up on the display. Reception improves.



To restore the stereo effect, press FM MODE again so that the MONO indicator goes off. In this stereo mode, you can hear stereo sounds when a program is broadcasted.

Presetting Stations

You can preset 30 FM and 15 AM stations.

In some cases, test frequencies have been already memorized for the tuner since the factory examined the tuner preset function before shipment. This is not a malfunction. You can preset the stations you want into memory by following the presetting method.

- There is a time limit in performing the following steps. If the setting is cancelled before you finish, start from step 1 again.

On the unit ONLY:

1 Tune in the station you want to preset.

- See “Tuning in a Station.”

2 Press SET.

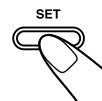

3 Press ◀◀ or ▶▶ to select a preset number.

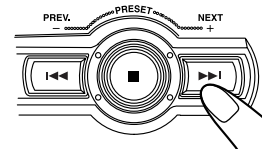

4 Press SET again.

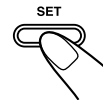

The tuned station in step 1 is stored in the preset number selected in step 3.

- Storing a new station on a used number erases the previously stored one.



When you unplug the AC power cord or if a power failure occurs

The preset stations will be erased in a few days. If this happens, preset the stations again.

Tuning in a Preset Station

1 Press FM/AM.

The unit automatically turns on and tunes in the previously tuned station (either FM or AM).

- Each time you press the button, the band alternates between FM and AM.

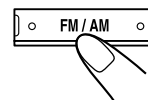

2 Select a preset number.

On the unit:

Press ◀◀ or ▶▶.

On the remote control:

Press the number buttons.

Ex.: For preset number 5, press 5.

For preset number 15, press +10, then 5.

For preset number 20, press +10, then 10.

For preset number 25, press +10, +10, then 5.

For preset number 30, press +10, +10, then 10.

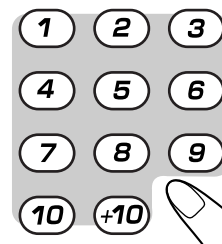
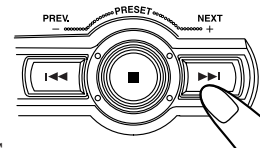



Playing Back CDs (CD/CD-R/CD-RW)

This unit has been designed to playback the following CDs:

- CD (Audio CD)
- CD-R (CD-Recordable)
- CD-RW (CD-ReWritable)

Continuous use of irregular shape CDs (heart-shape, octagonal, etc.) can damage the System.

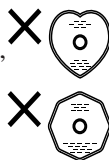

General Notes

In general, you will have the best performance by keeping your CDs and the mechanism clean.

- Store CDs in their cases, and keep them in cabinets or on shelves.
- Keep the system's disc trays closed when not in use.

When playing a CD-R or CD-RW

User-edited CD-Rs (CD-Recordable) and CD-RWs (CD-ReWritable) can be played back only if they are already "finalized."

- You can playback your original CD-Rs or CD-RWs recorded in music CD format. (However, they may not be played back depending on their characteristics or recording conditions.)
- Before playing back CD-Rs or CD-RWs, read their instructions or cautions carefully.
- Some CD-Rs or CD-RWs may not be played back on this unit because of their disc characteristics, damage or stain on them, or the player's lens is dirty.
- CD-RWs may require a longer read-out time. This is caused by the fact that the reflectance of CD-RWs is lower than for regular CDs.

Loading CDs

On the unit ONLY:

1 Press CD Open/Close ▲.

The unit automatically turns on and the disc tray comes out.

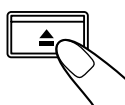

2 Place a disc correctly on the circle of the disc tray, with its label side up.

Label side up

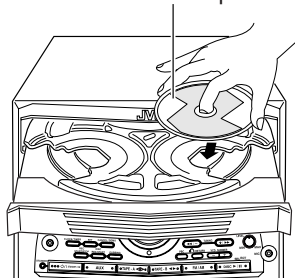

- When using a CD single (8 cm), place it on the inner circle of the disc tray.

3 Press DISC SKIP and place the next CD.

When you press the button, the tray turns for the next CD.



4 Repeat steps 3 for the last CD.

5 Press CD Open/Close ▲.

The tray is closed.



When placing a disc in the tray

Be sure to position the disc inside the recess correctly. Otherwise, the message "NO DISC" will appear in the display, and the disc may be damaged or the unit may be damaged when the tray is opened, or it may be difficult to remove the disc from the unit.



About the disc indicators



Disc Number Indicator: Lights all the time

Selected Disc indicator: Lights for the currently selected disc number.

Disc Rotation indicator: Runs when the selected CD is played or paused. This indicator goes out if a CD is not loaded for the selected disc number. Once the tray is ejected, the Disc Rotation indicators for all disc numbers are lit. However, when the empty disc number is selected, the Disc Rotation indicator for the disc number goes out.

Example of indication:

When disc tray has ejected once and then DISC 1 is pressed. (DISC 1 is selected)

Shows that this disc number is selected



Shows that the disc is rotating

Playing Back the Entire Discs — Continuous Play

1 Load CDs.

2 Press one of the disc number buttons (DISC 1, DISC 2 and DISC 3) for the disc you want to play.

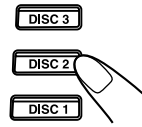

CD starts playing from the first track of the selected disc.

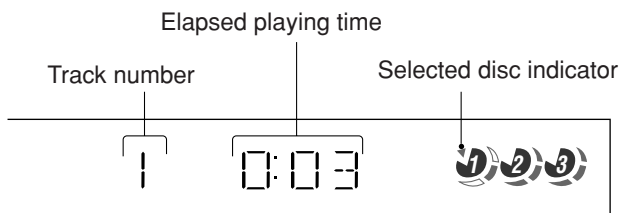

- Pressing DISC ►/|| instead of the disc number buttons starts playing back if a CD is on the tray.
- Playing back the CD using the DISC SKIP button. You can also play the CDs using the DISC SKIP button. During playback, each time you press the button, the next CD is automatically played back.

To stop playing, press ■.

To remove the disc, press ▲. (If the CD is playing, stop the CD before ▲ is pressed.)



CD playback sequence

When 3 CDs* are loaded on the disc tray, they are played in one of the following sequences.

- When DISC 1 is pressed: DISC 1 ⇒ DISC 2 ⇒ DISC 3 (then stops)
- When DISC 2 is pressed: DISC 2 ⇒ DISC 3 ⇒ DISC 1 (then stops)
- When DISC 3 is pressed: DISC 3 ⇒ DISC 1 ⇒ DISC 2 (then stops)

* When only 2 CDs are loaded, they are played in the same order, but the disc tray without a CD is skipped.



Total Number of Contents (TOC) reading

STOP button does not function during CD changing time and TOC reading (about 10-20 seconds). You can press STOP button only after playing time start counting on the display.



If no CD is placed on the disc tray, "NO DISC" appears on the display.

Basic CD Operations

While playing a CD, you can do the following operations.

To remove/change the CDs during playback

While playing back a CD (e.g. DISC 1), you can remove or change the other CDs (e.g. DISC 2 and DISC 3) by pressing ▲. After removing or changing, press the same button to close the tray.

To stop playing for a moment

Press DISC ►/||.

While pausing, the elapsed playing time flashes on the display.



To resume playing, press DISC ►/||.

To go to another track

Press ◀◀◀ or ▶▶▶ before or during playback (or press ▶▶▶ (NEXT ▶▶▶) / ◀◀◀ (PREV. ◀◀◀) on the remote control).

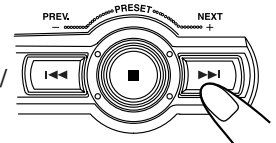

- ◀◀◀: Goes back to the beginning of the current or previous tracks.
- ▶▶▶: Skips to the beginning of the next or succeeding tracks.



If you press and hold (on the unit only) ◀◀◀ or ▶▶▶ before playing

You can change the tracks continuously.

To locate a particular point in a track

On the remote control:

During play, press and hold ▶▶▶ (NEXT ▶▶▶) or ◀◀◀ (PREV. ◀◀◀).

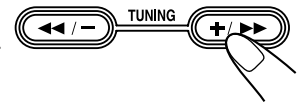

On the unit:

Press TUNING +/-▶▶▶ or ◀◀◀/-.

- Tuning ◀◀◀/- (or ◀◀◀ (PREV. ◀◀◀)): Fast reverses the disc.
- Tuning+ /▶▶▶ (or ▶▶▶ (NEXT ▶▶▶)): Fast forwards the disc.
- There are 4 searching speed:
 - X1 – 2 seconds search
 - X2 – 5 seconds search
 - X3 – 10 seconds search
 - X4 – 20 seconds search

To go to another track directly using the number buttons

Pressing the number button(s) on the remote control before or during play allows you to start playing the track number you want.

Ex.: For track number 5, press 5.

For track number 15, press +10, then 5.

For track number 20, press +10, then 10.

For track number 32, press +10, +10, +10, then 2.

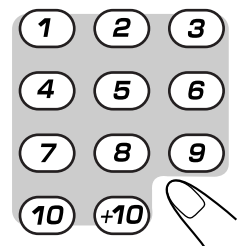

Total time and total number of tracks will only appear on the display at the following condition:

- (1) Power ON in CD mode using standby button.
- (2) New CD inserted into the current tray and the tray closed using the eject button.
 - * The above only apply for audio CD and VCD.
- (3) Search speed might be different for different type of discs.

Programming the Playing Order of the Tracks — Program Play

You can arrange the order in which tracks play before you start playing. **You can program up to 32 tracks.**

- To use Repeat play (see page 16) for Program play, press REPEAT after starting Program play.

1 Load CDs.

- If the current playing source is not the CD player, press DISC ►/||, then ■ before going to the next step.

2 Press PROGRAM so that “PRGM” appears on the display.

The PRGM (program) indicator also lights up on the display.

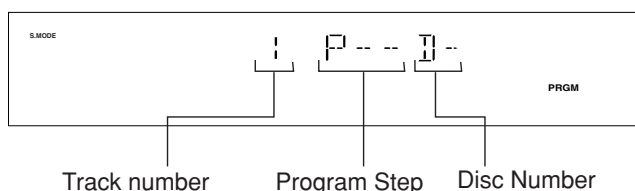

3 Press one of the disc number buttons (DISC 1, DISC 2 and DISC 3) to select the disc number you want to program.

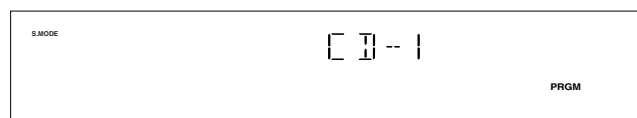

4 Select a track from the CD selected in the above step.

On the unit:

Press ◀◀ or ▶▶ to select the track number and press SET button.

On the remote control:

Press the number buttons.

- For how to use the number buttons, see “To go to another track directly using the number buttons” on page 14.

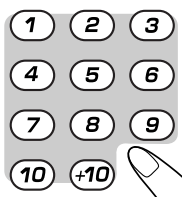
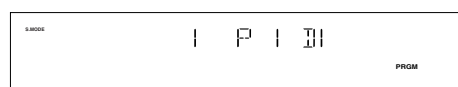
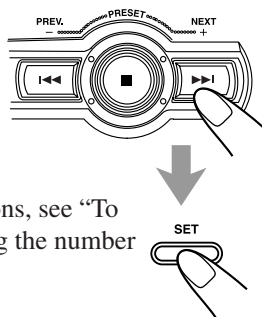

5 Program other tracks you want.

- To program tracks from the same disc, repeat step 4.
- To program tracks from a different disc, repeat steps 3 and 4.

6 Press DISC ►/||.

The tracks are played in the order you have programmed.

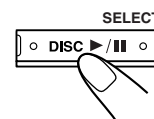

To stop playing, press ■.

To exit from Program play mode, press PROGRAM or STOP again before or after play. The PRGM (program) indicator goes off.



- Memory content of the relevant disc is erased when tray is ejected.
- All memory content is erased when program is turned off.
- If you try to program a 33rd track “FULL” will appear on the display.
- If your entry is ignored

You have tried to program track number that does not exist on the CD (for example, selecting track 14 on a CD that only has 12 tracks). Such entries are ignored.

- If you want to eject current program play disc

Stop the CD and press ▲ to eject. Please note that the program mode is remain eventhough tray is open.

To check the program contents

Before playing, you can check the program contents.

On the remote control:

Press and hold ▶▶ (NEXT ▶▶) or ◀◀ (PREV. ◀◀).

On the Unit:

Press TUNING +/▶▶ or ◀◀/-

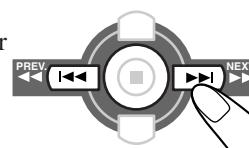

OR

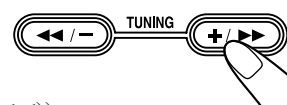

- Tuning +/▶▶ (or ▶▶ (NEXT ▶▶)):

Shows the programmed tracks in the programmed order.

- Tuning +/- ◀◀ (or ◀◀ (PREV. ◀◀)):

Shows them in the reverse order.

To modify the program on the remote control only

Before or after playing, you can erase the last programmed tracks by pressing PROGRAM CANCEL on the remote control.



- Each time you press the PROGRAM CANCEL on the remote control the programmed track shown on the display is erased from the program.
- Ejecting a CD will also erase the track numbers programmed from the ejected CD.

To add tracks to the program before playing, simply select the track numbers you want to add by following step 4 of the programming procedure.

To erase the entire program before or after playing, press ■.

The program you have made will be erased:

- when you unplug the AC power cord.
- when a power failure occurs.

Playing at Random — Random Play

The tracks of all loaded CDs will play at random.

- To use Repeat play for Random play, press REPEAT after starting Random play.

1 Load CDs.

- If the current playing source is not the CD player, press DISC ►/||, then ■ before going to the next step.

2 Press RANDOM.

The RANDOM indicator also lights up on the display.



3 Press DISC ►/||.

The tracks of the current disc are randomly played until finish before changing to another tray.

Random play ends when all the tracks are played once.



To skip the currently playing track, press ►►| (or press ►►| (NEXT ►►) on the remote control).



Even if you press |◀◀ (or press |◀◀ (PREV. ◀◀) on the remote control)

You cannot go back to previous tracks during Random play.

To stop playing, press ■.

To exit from Random play mode, press RANDOM or STOP again before or after playing.

Repeating Tracks or CDs — Repeat Play

You can have all the CDs, the program or the individual track currently playing repeat as many times as you like.

To repeat playing, press REPEAT during or before playing. To use Repeat play for Program play and Random play, press the button after starting playback.



- Each time you press the button, Repeat play mode changes as indicated by the following indicator lights up on the display:

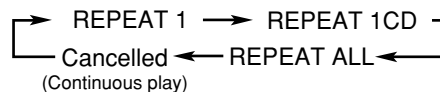

REPEAT ALL: Repeats all the tracks on all the CDs (continuously or at random) or all the tracks in the program.

REPEAT 1 : Repeats one track on one CD.

REPEAT 1CD : Repeats all the tracks on one CD.

To cancel Repeat play, press REPEAT repeatedly until the REPEAT indicators go off from the display.

- Repeat play remains in effect when you select another play mode (NORMAL, PROGRAM or RANDOM)
- In RANDOM and PROGRAM play, “REPEAT 1CD” can’t be selected. If REPEAT 1CD has been selected when you press RANDOM, it is cancelled. Only REPEAT 1 and REPEAT ALL can be selected.

Prohibiting Disc Ejection — Tray Lock

You can prohibit CD ejection from the unit and lock CDs.

- This operation is possible only when the source is the CD player.

On the unit ONLY:

To prohibit disc ejection, press ◻/I STANDBY/ON while holding down ■. (If there is any disc tray opened, close it first.) “LOCKED” appears for a while, and the loaded CDs are locked.

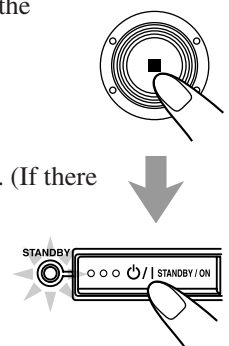

To cancel the prohibition and unlock the CDs, press ◻/I STANDBY/ON while holding down ■. “UNLOCKED” appears for a while, and the loaded CDs are unlocked.



If you try to eject CDs

“LOCKED” appears to inform you that the Tray Lock is in use.



Playing Back Video CDs

Selecting Video Output (PAL, PAL AUTO, NTSC)

You can set this setting in Standby mode.

Before playing a VCD, use the buttons on the unit to select a video output mode to match your TV system.

Video output is preset for PAL.

Relationship among the playable CDs, System's TV output mode and your TV's color system:

| Playable CD | Player's TV output mode | Your TV's color system |
|-------------|-------------------------|------------------------|
| NTSC/PAL | NTSC | NTSC |
| NTSC/PAL | PAL | PAL |
| NTSC/PAL | PAL AUTO | Multisystem |

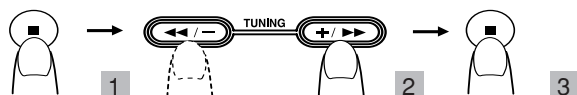

1 Turn off the power to put the System into Standby mode.

2 Press and hold the **■** button on the Unit for more than 2 seconds.

The current TV output mode ("NTSC" for example) appears on the display for five seconds.

3 Within five seconds, press the TUNING **+ / >>** or TUNING **<< / -** button on the Unit to select the System's TV output mode.

Each time you press the button, the TV output mode changes as follows:

NTSC → PAL → PAL AUTO (back to beginning)

NTSC: for NTSC exclusive TV

PAL: for PAL exclusive TV

PAL AUTO: for multisystem TV

4 Press **■** button to confirm selected TV output mode.

Loading Discs

1 Press CD Open/Close **▲**.

The unit automatically turns on and the disc tray comes out.

2 Place a disc correctly within the circle of the disc tray, with its label side up.

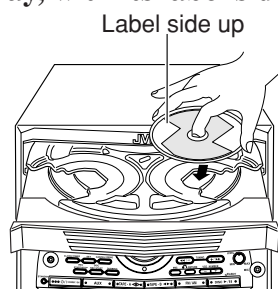

- When using a CD single (8 cm), place it within the inner circle of the disc tray.

3 Press DISC SKIP and place the next CD.

When you press the button, the tray turns for the next CD.

4 Repeat steps 3 for the last CD.

5 Press CD Open/Close **▲**.

The tray is closed.

When you place a CD onto the currently selected tray, whose disc number shown on the CD indicator, reading of the CD starts. After the reading is completed, the total number of tracks and total playing time will appear, then the playing time of the first track.

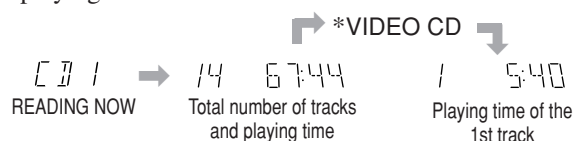

*VIDEO CD or AUDIO CD

If the video CD has the Playback Control function, "VCD PBC" will appear when you press **■** followed by PBC and DISC **▶/||**.

To put an 8 cm CD onto a tray, insert it so that it is aligned with the groove in the trays center.

If a tray is opened when the System switches to the standby mode, the tray will close automatically.

Playing a Video CD

You can play video CDs either with or without the PBC function.

1 Turn on the TV and select the video input so that you can view the pictures from the CD player.

Refer to the manual supplied for your TV.

2 Prepare a CD.

Refer to "Loading Discs" on this page.

3 Start playback of the CD.

Press DISC **▶/||**, to start playback of the currently selected CD, or press DISC 1-3, to select the disc and start playing.

Compu Play

When DISC **▶/||**, or DISC 1-3, is pressed while the system is on standby, the power is automatically turned on.

To stop during play, press **■**.

To stop playing and remove the disc, press **■** and then **▲** for the disc being played.

Playing Video CDs with PBC Function — Menu Play

This System provides Playback Control (PBC) which utilizes a procedure (menu selection) programmed in a video CD. The playback operation procedure may differ depending on the disc you use.

For Menu Play, use the following buttons:
(PBC mode must be turned on before operating Menu Play.)

On the unit:

- NEXT + (▶▶)** for viewing the unshown portion of the menu
- PREV. - (◀◀)** for viewing the previously shown portion of the menu
- DISC ▶/⏸** for starting playback of the selected item
- ↶ RETURN** for going back to the previous menu
- VCD NUMBER +, -** for selecting an item

On the remote control:

- ▶▶ (NEXT ▶▶)** for viewing the unshown portion of the menu
- ◀◀ (PREV. ◀◀)** for viewing the previously shown portion of the menu
- NUMBER BUTTONS ...** for selecting and starting playback of an item
- ↶ RETURN** for going back to the previous menu

1 Turn on the TV and select the video input so that you can view the pictures from the CD Player.

Refer to the manual supplied for your TV.

2 Prepare a CD.

Refer to “Loading Discs” on page 17.

3 Press PBC on the unit.

Allow several seconds for the table of contents (TOC) to be read before pressing PBC.

PBC indicator lights up on the display

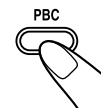

S.MODE 1 56:32 PBC

4 Start playback of the CD.

Press DISC ▶/⏸, to start playing of the currently selected CD.

S.MODE VCD PBC PBC

5 Select the item you want to view.

On the unit:

Press VCD NUMBER + to select larger item numbers, or press VCD NUMBER - to select smaller item number. Then press DISC ▶/⏸, to start the disc. In case VCD number cannot be selected from the unit, please use the remote control.

On the remote control:

Press the number buttons to select and play the item you want.

To stop the track being played and return to the menu, press ↶ RETURN button.

To stop Menu Play, press ■.

NOTE:

You can only select PBC in CD STOP and repeat off position. REPEAT mode is turned off automatically.

Basic Concept of the PBC function

PBC (Playback Control) allows you to enjoy menu-driven operation and high resolution still images having a resolution four times greater than video pictures.

Menu-driven playback

You can interact with the screen using a menu display to select and play an entry.

High-resolution still image display

You can display high-quality images four times clearer than video pictures.

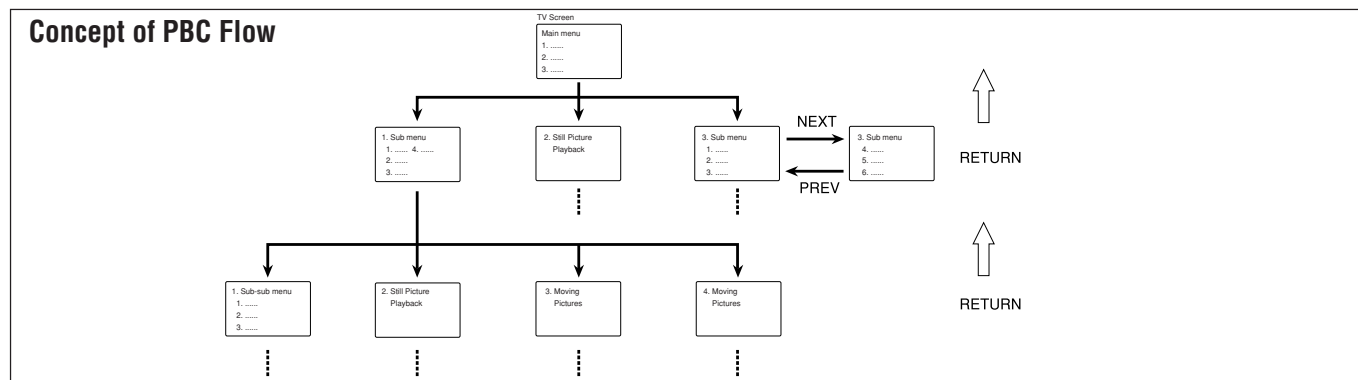

Basic flow of Menu Play Operation

A selection menu is shown when you start playing a video CD with PBC. The menu shows a list of items to select. Some discs may show moving pictures or a divided screen.

- When a list of items appears, you can select the number of the item you want to playback.
- When moving pictures appear, you can select a moving picture by pressing ▶▶ (NEXT ▶▶) / ◀◀ (PREV. ◀◀).

- When the menu appears after the item you have selected finish playing, you can select another item that you want to view next.
- After playback, press ↶ RETURN, to go back to the previous screen. Each time you press the button, you will go back by one screen.
- If you want to stop Menu Play, press ■.



Notes

- After cancelling PBC, you can Continuously Play more than one video CD without PBC.
- When PBC is cancelled, some images such as still play pictures may not be played back.
- You cannot change from PBC OFF to PBC ON while CD is playing.

Reminder!

Do not pause Video CD for more than 10 minutes to prevent screen burns.

Playing Video CDs without PBC — Continuous Play

Even if a video CD has PBC, you can cancel PBC and play the disc without using the menu screen.

1 Turn on the TV and select the video input so that you can view the pictures from the CD Player.

Refer to the manual supplied for your TV.

2 Prepare a CD.

Refer to “Loading Discs” on page 17.

3 Start playback of the CD.

On the unit:

Press DISC ►/|| or DISC 1-3 of the tray you want to play from. The selected video CD starts playback from the first track.



On the remote control:

Press the number button of the track you want to start playing. The playback starts from the selected track of the currently selected disc.

To stop during play, press ■.

To restore PBC, press the PBC button again, then press current DISC ►/|| to play VCD with PBC.

Pressing DISC 1, DISC 2 or DISC 3 will cancel PBC automatically.

Resuming Play

If you stop a video CD directly, you can continue viewing from the scene where you last stopped.

1 During playing of a VCD, press ■ button to stop playing (refer to page 17).

2 Press DISC ►/|| button to continue playback from the last scene that you stopped at.



- Resume play will not work when the CD tray has been opened.
- It is advisable to turn off PBC to use resume play otherwise resume feature will be cancelled.
- Resume play will also function when you change source or turn off the unit (on standby) during playing of a VCD.

Special Plays for a Video CD

You can use the following special play modes for video CDs both with and without PBC. The following functions can only be executed with the buttons on the remote control.

Frame-by-Frame Playback

Press the STILL button during playback. Then each time you press the button, still pictures advance by one frame. During frame-by-frame playback, no sound is emitted.



To resume normal playback, press DISC ►/||.

Viewing Operating Status

Usually, the following information of the track being played is shown on the TV screen during playback : the disc number, the track number, and the playing time.

Press ON SCREEN.

This button toggles the display of operation status. When the display of operation status turns on, the following information of the track being played appear on the TV screen: Disc number, track number / total number of tracks and the current tracks elapsed time.

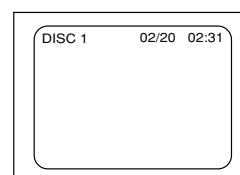

To cancel the display of operation status, press ON SCREEN.

Viewing the Video Intro of the Video CD

You can view the contents of a video CD, watching for about 7 seconds of each track on the video CD. Video intro does not work with PBC. For a video CD with PBC, cancel the PBC function by referring to “Playing Video CDs without PBC” on this page.

1 Press DISC 1-3, to select the disc you want to view the video intro.

Playback starts.

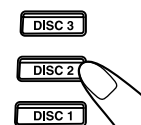

2 Press VIDEO INTRO on the remote control after a picture appears on the TV screen.

The video intro play starts and shows in sequence for about 7 seconds of the first nine tracks on the TV screen. To preview subsequent tracks, press ►► (NEXT ►►) on the remote control. Pressing ◀◀ (PREV. ◀◀) will display the previous 9 track intros.



The TV screen will show the following:

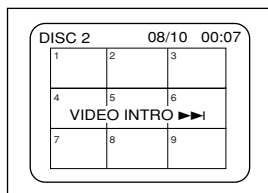

3 Press the number button for the video intro you want to select.

Playback starts from the selected track.

To stop and cancel the video intro play, press ■.

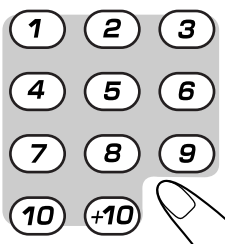

Viewing the Highlights of a Video CD

You can view highlight scenes of the selected track on a video CD only when PBC is off. These highlight scenes are created by dividing the track equally into 9 portions and the beginning scenes (about 7 seconds each) of those 9 portions are shown on the display.

1 Press DISC 1-3, and the number button for the track you want to view the highlights of.

Playback starts.



2 Press HIGHLIGHT on the remote control after a picture appears on the TV screen.

The highlight play starts and shows in sequence, the first 7 seconds of nine track divisions on the TV screen. To preview subsequent tracks, press ►► (NEXT ►►) on the remote control.



TV screen will show the following:

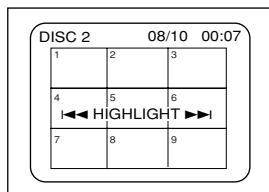

3 Press the number button for the highlight you want to select.

Playback starts from the selected scene.

To stop and cancel the highlight play, press ■.

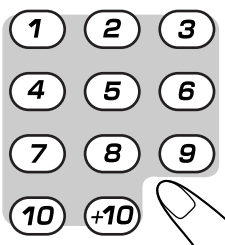

Viewing highlights

- When a highlight scene is selected, playback starts from the beginning of the highlight scene, but not from the still image shown on the display (the part shown is the last part of the highlight scene, not its beginning).
- During the video intro or highlight play, images shown on the display may be partially distorted, resulting from noise or incorrect manufacturing of the disc.
- Highlight also can function in stop position.
- When STILL/PAUSE function is on, HIGHLIGHT and VIDEO INTRO functions are not available.

Playing a Multiplex Sound CD

This function is used for multiplex sound discs. See manuals attached to discs for detailed information.

Operation

By pressing the MPX button on the remote control consecutively, channel multiplexing modes are cycled as shown below.

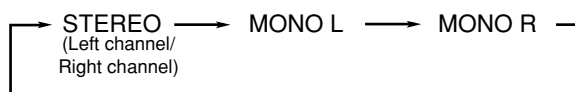

When MONO L or MONO R is selected, display indicates MONO L or MONO R respectively.

- MONO L: Only the left channel is played back through both right and left speakers.
- MONO R: Only the right channel is played back through both right and left speakers.
- STEREO: Used for conventional stereo sources.

MP3 Disc Playback

About MP3 discs

An MP3 disc can have several folders (albums). Tracks are contained within the albums. The player will only recognize up to 76 albums. Total number of tracks recognizable is 999.

Recording your own MP3 discs

- Disc format should be set to “ISO 9660”.
- Multisession recording is not supported.
- The disc must be finalized.
- Files other than MP3 will be ignored.

Basic operations

If your TV set is connected to the unit, you can view the contents of the MP3 disc on-screen.

- 1 Load an MP3 disc.
- 2 Press DISC 1, DISC 2 or DISC 3, and CD starts playing.
- 3 Press  button, Group Title Menu will appear on TV screen.

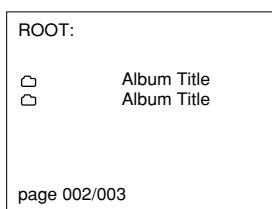

- 4 Press PRESET NEXT + (▶▶) or PREV. - (◀◀) (or press ▶▶ (NEXT ▶▶) / ◀◀ (PREV. ◀◀) on the remote control) to select the album. At the last entry, press PRESET NEXT + (▶▶) will move to the next page (if any). Albums are arranged in alphabetical order.

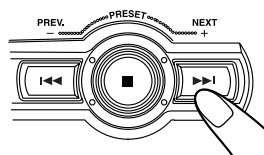

- 5 Press ENTER on the remote control to confirm your album selection.

The following display will appear on the TV screen.

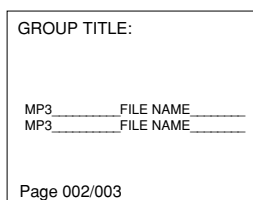

- To exit from the selected album, press  RETURN.

- 6 Press PRESET NEXT + (▶▶) or PREV. - (◀◀) (or press ▶▶ (NEXT ▶▶) / ◀◀ (PREV. ◀◀) on the remote control) to select the track.

- 7 Press DISC ▶/|| to play.

The next track will be automatically played after the current track is finished.

- 8 If you press and hold ▶▶ (NEXT ▶▶) / ◀◀ (PREV. ◀◀) on the remote control, you can fast search (reverse/forward) within a track. The track elapsed time on the unit's display will change.

- 9 Press  to stop playing and return to album menu.



At any time you may select a track from any album by pressing the number keys on the remote control.

Example:

For track number 28, press +10 twice, then 8.

Programming tracks

- 1 Press PROGRAM on the unit or on the remote control.

- 2 Select a MP3 disc using the DISC 1, DISC 2 or DISC 3 button. The following display will appear on your TV screen.

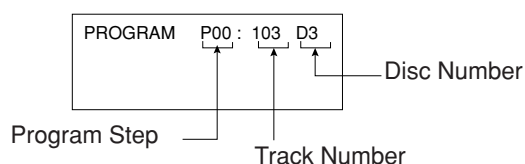

- 3 Select an album using PRESET NEXT + (▶▶) or PREV. - (◀◀). At the last entry, press PRESET NEXT + (▶▶) or PREV. - (◀◀), it will move to the next page (If any).
- 4 Press SET on the unit or ENTER/SET on the remote control. The following screen will appear on your TV.

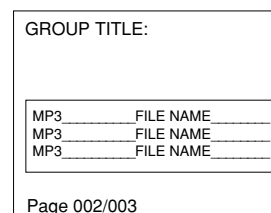

- To exit from the selected album, press  RETURN.

5 Select a track from the CD selected in the above step.

On the unit

Press PRESET NEXT + (▶▶|) or PREV. – (|◀◀), then press SET button.

On the remote control:

Press ▶▶| (NEXT ▶▶) or |◀◀ (PREV. ◀◀), then press ENTER button or SET button.

You can also press the number button.

- To cancel the entry, press CANCEL/DEMO on the unit or PROGRAM CANCEL on the remote control.
- To cancel the whole program, press PROGRAM or press ■ to clear all memory content.
- If you want to return to the Group Title Menu, press ↶ RETURN button.
- To check program contents and modify the program, see “To check the program contents” and “To modify the program on the remote control only” on page 15.

6 Press DISC ▶/|| to start program playback.

To stop playing press ■.

To skip program,

On the unit

Press PRESET NEXT + (▶▶|) or PREV. – (|◀◀).

On the remote control:

Press ▶▶| (NEXT ▶▶) or |◀◀ (PREV. ◀◀).

To cancel the program, press ■ while the disc not playing.



Playing Back Tapes

You can playback type I, type II and type IV tapes without changing any settings.

Playing Back a Tape

- 1** Press EJECT (▲) for the deck you want to use.

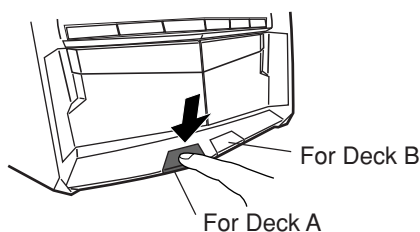

- 2** Put a cassette in with the exposed part of the tape down.

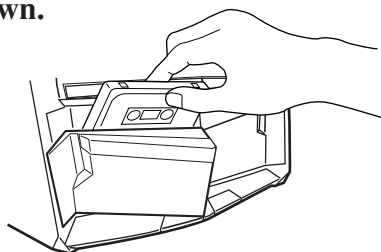

- 3** Close the cassette holder gently.

- 4** Press TAPE-A ◀▶ or TAPE-B ◀▶ for the deck you want to use.

The tape play starts and the tape direction indicator ▶- or -◀ starts flashing slowly to indicate the tape running direction.

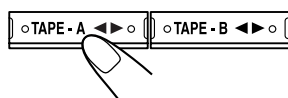

- Each time you press the button, the tape direction changes.

▶- : plays the forward side.

-◀ : plays the reverse side.

- If no cassette is inserted in current deck then “DECK A” or “DECK B” and “NO TAPE” will start blinking on the display.

When the tape plays to the end, the deck automatically stops or reverse play depends on the setting of Reverse Mode. (See “To play both sides repeatedly — Reverse Mode.”)

To stop playing, press ■.

To fast forward or fast reverse, press +/▶▶ or ◀◀/- (or ▶▶| (NEXT ▶▶) / |◀◀ (PREV. ◀◀) on the remote control).

The tape direction indicator ▶- or -◀ starts flashing quickly on the display.

To remove the cassette, press ▲ EJECT for deck A or EJECT ▲ for deck B.

To play both sides repeatedly — Reverse Mode

Reverse Mode works for both decks at the same time.

When it is in use, the tape automatically reverses at the end of a side and the unit starts playing the other side of the tape, and repeats the same process.

To use Reverse Mode, press REVERSE MODE.

The Reverse Mode indicator on the display lights up — ◻◻.

To cancel Reverse Mode, press the button again so that the

Reverse Mode indicator on the display lights up — ◻◻.

◻◻ : Play one direction only.

◻◻ : Play both sides of current deck.

◻◻ : Play DECK A and DECK B repeatedly.



When Reverse Mode is on with cassettes in both decks A and B

After the reverse -◀ side of the tape finishes playing, the tape in the other deck starts playing.

Recording



IMPORTANT:

- It may be unlawful to record or play back copyrighted material without the consent of the copyright owner.
- The recording level is automatically set correctly, so it is not affected by the VOLUME, the ACTIVE BASS EX., the SOUND TURBO, and the SOUND MODE. Thus, during recording you can adjust the sound you are actually listening to without affecting the recording level.
- If recordings you have made have excessive noise or static, the unit may be too close to a TV. Increase the distance between the TV and the unit.
- You can use type I tape for recording.

To protect your recording

Cassettes have two small tabs on the back to protect from accidental erasure or re-recording.

To protect your recording, remove these tabs.

To re-record on a protected tape, cover the holes with adhesive tape.

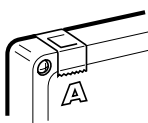

To keep the best recording and playback sound quality

If the heads, capstans, and pinch rollers of the cassette decks become dirty, the following will occur:

- Impaired sound quality
- Discontinuous sound
- Fading
- Incomplete erasure
- Difficulty in recording

To clean the heads, capstans, and pinch rollers

Use a cotton swab moistened with alcohol.

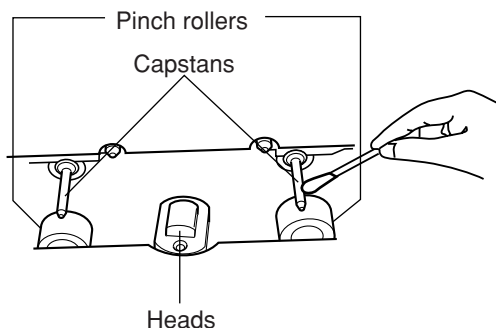

To demagnetize the heads

Turn off the unit, and use a head demagnetizer (available at electronics and audio shops).

Recording a Tape on Deck B

1 Press EJECT ▲ for deck B.

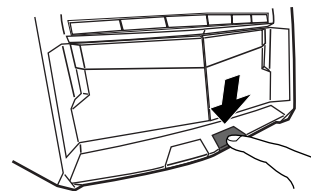

2 Put a recordable cassette into deck B.

3 Close the cassette holder gently.

4 Check the tape direction of deck B.

- If the tape direction is not correct, press TAPE-B ◀▶ twice then ■ to change the tape direction.

5 Start playing the source — FM, AM, CD player, deck A or auxiliary equipment connected to AUX jacks.

- When the source is CD, you can also use CD Direct Recording (see page 25).
- When the source is deck A, you can also use the dubbing method. (See “Dubbing Tapes” on page 25 .)

6 Start recording.

Press REC START/STOP.

The **REC** (recording) indicator lights up on the display and recording starts.

- If no cassette is inserted, “NO TAPE” appears on the display. If a protected tape is inserted, “NO REC” appears on the display.

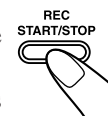

To stop recording immediately, press ■.

To remove the cassette, press EJECT ▲ for deck B.



REC START/STOP

During CD mode, when recording stop after tape finish, press ■ once to cancel the recording function. Otherwise, the system will remain in recording mode and certain operations will be invalid.

To record on both sides — Reverse Mode

Press REVERSE MODE so that the Reverse Mode indicator lights up – .

- When using Reverse Mode for recording, start recording in the forward \blacktriangleright - direction first. Otherwise, recording will stop when recording is done only on one side (reverse) of the tape.

To cancel Reverse Mode, press the button again so that the Reverse Mode indicator lights up – .

Dubbing Tapes

You can record from one tape to another.

On the unit ONLY:

- Press either TAPE-A $\blacktriangleleft\blacktriangleright$ or TAPE-B $\blacktriangleleft\blacktriangleright$, then \blacksquare .

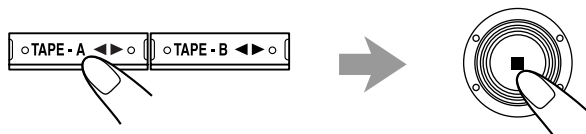

- Put the source cassette into deck A, and a recordable cassette into deck B.

- Put the cassettes in both decks so that the tapes will run in the forward \blacktriangleright - direction.

- Press DUBBING.

The **REC** (recording) indicator lights up on the display and dubbing starts.



To stop dubbing, press \blacksquare so that both decks (A and B) stop.

To record on both sides — Reverse Mode

Press REVERSE MODE so that the Reverse Mode indicator lights up – .

To cancel Reverse Mode, press the button again so that the Reverse Mode indicator lights up – .

CD Direct Recording

Everything on the CD goes onto the tape according to the order of the CD.

On the unit ONLY:

- Put a recordable cassette into deck B.

- Load CDs.

- Press one of the disc number buttons (DISC 1, DISC 2 and DISC 3) to select the disc, then \blacksquare .



- Press DISC REC START.

“DISC REC START” appears, and the **REC** (recording) indicator lights up on the display. Deck B starts recording and the CD player starts playing. When the recording is done, “DISC REC FINISHED” appears on the display and deck B stop.



To stop recording, press REC START/STOP or \blacksquare . So that a 4-second blank portion is created on the recording tape.



- Before recording on a tape, wind the tape on past the leader tape (about the first 3 or 4 seconds of each side).

To record on both sides — Reverse Mode

Press REVERSE MODE so that the Reverse Mode indicator lights up like – .

- When using the Reverse Mode for CD Direct Recording, start recording in the forward \blacktriangleright - direction first. When the tape reaches its end while recording a song in the forward direction \blacktriangleright -, the last song will be re-recorded at the beginning of the reverse side \blacktriangleleft .

If you start recording on the reverse side \blacktriangleleft -, recording will stop when recording is done only on one side (reverse) of the tape.

To cancel Reverse Mode, press the button again so that the Reverse Mode indicator lights up – .

Using the Microphones

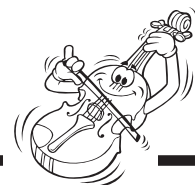

You can enjoy singing along (Karaoke) and microphone mixing using a microphone.

IMPORTANT:

- Always set MIC LEVEL to MIN when connecting or disconnecting the microphone.
- When not using the microphone, keep it disconnected.

Singing along — Karaoke

Karaoke

Karaoke reduces the lead vocal of the playing source, and allows you to replace it by singing into the microphone as the music plays.

1 Turn MIC LEVEL to MIN.

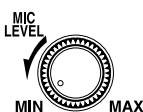

2 Connect the microphone (not supplied) by plugging it into MIC jack.

3 Press KARAOKE on the remote control.

The karaoke (🎤) indicator lights up on the display.



4 Start playing the source — CD, tape or other connected component.

5 Turn MIC LEVEL and VOLUME as you sing into the microphone.

- By pressing REC START/STOP, you can record your singing along if you want. (For more details, see page 24.)

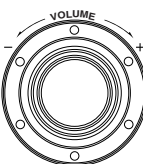

To apply an echo to your voice

Press ECHO on the remote control so that the echo (🔊) indicator lights up on the display.

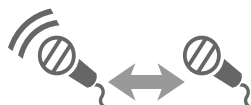

Each time you press the button, the echo level changes as follows:

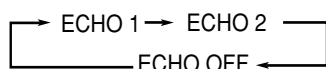

- As the number increases, a stronger echo effect is applied to your voice.



If howling or squealing (feedback) occurs while using the microphone

Take the following actions to prevent these noises.

- Adjust MIC LEVEL and VOLUME.
- Avoid pointing the microphone towards the speakers.



When you turn on Karaoke and MPX, you cannot get the satisfactory results if

- Radio programs — a radio signal is not as reliable as the signals coming from a tape or CD.
- Monaural sources.
- Poorly dubbed tapes.
- Sources recorded with duets, strong echo, a chorus or only a few instruments.
- To get the best result, turn off karaoke when MPX is on or turn off MPX when karaoke is on.

Singing Along with Multiplex Karaoke Discs (MPX)

If the source you are going to play is a multiplex karaoke disc, you can use the Multiplex sound function via the buttons on the remote control.

What is Multiplex Sound?

On a multiplex karaoke disc, the instrumental parts are recorded on the left channel. With this system, you can replace the vocal part with your voice through the microphone.

1 Rotate the MIC LEVEL and VOLUME to MIN.



2 Connect the microphone (not supplied) into the MIC jack on the front panel.

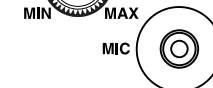

3 Play the source — CD.

4 Press MPX on the remote control to select the output sound.

Please refer to page 20.



5 Turn MIC LEVEL and VOLUME to adjust the microphone level and the speaker output level.

6 Sing into the microphone.

To apply echo to your voice, see “To apply an echo to your voice” on this page.

To adjust the music key, see “Adjusting the Music Key Control” on page 27.

To record your singing along, see “Microphone mixing” on page 27.



When finished singing

Restore the stereo effect by pressing MPX until “STEREO” appears on the display. To cancel echo effect, press ECHO until “ECHO OFF” appears on the display.

Recording Your Singing

You can adjust the music key using the remote control.

- 1 Follow the steps in “Singing Along with Multiplex Karaoke Discs (MPX)” on page 26.
- 2 Follow the steps in “Recording a Tape on Deck B” on page 24 to record your singing.

Adjusting the Music Key Control (for CD play only)

On the remote control ONLY:

- 1 Press **KEY CONTROL** **b** / **#** to adjust the music key.

To lower the key, press **KEY CONTROL** **b** .
To raise the key, press **KEY CONTROL** **#** .

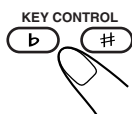

To cancel the key adjustment, press **KEY CONTROL** **b** or **#** until “KEYCON 0” appears on the display and the TV screen display is as below:

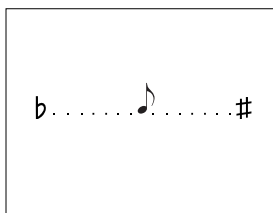

Adjust the music key each time you sing along to a song

Once the music key is adjusted, the key level will not return to the previous level automatically after playing a song.
The music key cannot be changed while recording.
Once the source is changed, the key level returns to 0.

Microphone mixing

When you sing along with multiplex tapes or CDs, follow the procedure below:

- 1 Connect the microphone.
- 2 Start playing the source — CD, tape or other connected component.

- 3 Turn **MIC LEVEL** and **VOLUME** as you sing into the microphone.

- By pressing **REC START/STOP**, you can record your singing along if you want. (For more details, see page 24.)

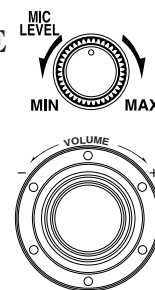

To use microphone only

Without any background sound, you can use your microphone and record it if you want.

- 1 Connect the microphone.

- 2 Press **DISC** **▶/||**, then **■**.

No background sound will be heard.

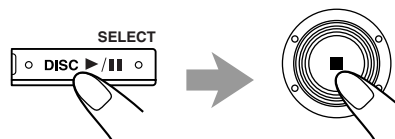

- 3 Turn **MIC LEVEL** and **VOLUME** as you sing into the microphone.

- By pressing **REC START/STOP**, you can record your singing along if you want. (For more details, see page 24.)

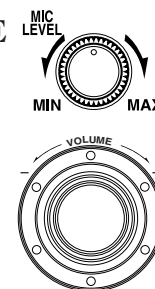

Using the Timers

There are three timers available — Daily Timer, Recording Timer and Sleep Timer.

Before using the timers, you need to set the clock built in the unit. (See page 9.)

Using Daily Timer and Recording Timer

With Daily Timer, you can wake to your favorite music or radio program. You can set the timer whether the unit is on or off.

How Daily Timer works

The unit automatically turns on, sets the volume level to the preset level, and starts playing the specified source when the on-time comes (the  indicator flashes just before the on-time, and continues flashing while the timer is operating). Then, when the off-time comes, the unit automatically turns off (on standby).

The Daily timer works everyday automatically. If you do not want to use the Daily timer, turn off the Daily timer. (See “To deactivate the timer temporary” on page 29.) The timer setting remains in memory until you change it.

- There is a time limit in performing the following steps. If the setting is cancelled before you finish, start from step 1 again.
- To correct a misentry, deactivate the timer and start from step 1 again.

Before you start...

- *When using a CD as the source to play* —
 - Make sure there is a CD on the selected disc number tray.
- *When using a tape as the source to play* —
 - Make sure that a tape is in the deck whose deck indicator (A or B) is lit on the display.
 - Make sure that the tape direction is correct.





On the unit ONLY:

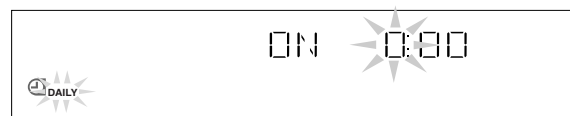

1 Press CLOCK/TIMER.

 indicator lights up and DAILY (Daily Timer) indicator also starts flashing on the display.





2 Set the on-time you want the unit to turn on at.

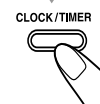
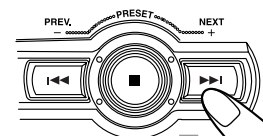

1) Press  or  to set the hour, then press CLOCK/TIMER.

2) Press  or  to set the minute, then press CLOCK/TIMER.



3 Set the off-time you want the unit to turn off (on standby) at.

1) Press  or  to set the hour, then press CLOCK/TIMER.

2) Press  or  to set the minute, then press CLOCK/TIMER.

The unit enters source selecting mode.



4 Select the timer (Daily Timer or Recording Timer) with the source to play.

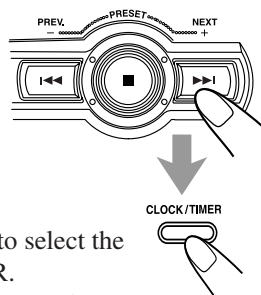

On the unit:

Press **PREV.** or **NEXT** to select the timer, then press **CLOCK/TIMER**.

- Each time you press **PREV.** or **NEXT**, the timer mode and the source change as follows:

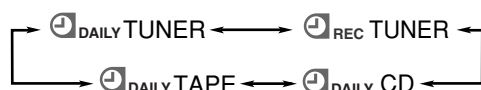

DAILY TUNER: Tunes in to the last station you were listening to. (Daily Timer)

REC TUNER : Records the last station you were listening to. (Recording Timer).

- Put a recordable cassette into the deck.

DAILY CD : Plays a disc. (Daily Timer)

- Load a disc.

DAILY TAPE : Plays a tape. (Daily Timer)

- Make sure that the tape is in the cassette deck.
- Make sure that the tape direction is correct.

The unit enters the volume level setting mode.

5 Select the volume level.

On the unit:

Press **PREV.** or **NEXT** to set the volume level, then press **CLOCK/TIMER**.

- You can select the volume level (“VOLUME --” and “VOLUME 0” to “VOLUME 30”).

If you select “VOLUME--,” the volume is set to the previous level when the unit was turned off.

- To turn off the volume while the Recording Timer (**REC TUNER**) is working, set the volume level “VOLUME 0”.

The unit enters the clock setting mode.

6 Adjust the clock if you need.

- See "Setting the Clock" on page 9.

7 Press **STANDBY/ON** (or **STANDBY/ON** on the unit) to turn off the unit (standby) if you have set the timer with the unit turned on.



- When the timer turns on the unit, the **(timer)** indicator starts flashing. (If the Recording Timer is selected in step 4, the REC indicator also starts flashing.)

To deactivate the timer temporarily, press and hold **CLOCK/TIMER** on the unit until the **(timer)** indicator on the display goes off.



To activate or change the timer (with the previous setting), follow steps 1 to 7 on pages 28 and 29

- If you want to change the timer setting after the Daily Timer has been set, deactivate the timer then set it again.



- **If the unit is turned on when the on-time comes** Timer does not work.
- **Even if you unplug the power cord or if a power failure occurs** The timer will be cancelled. You need set the clock first, then the timer again.

Using Sleep Timer

With Sleep Timer, you can fall asleep to music. You can set Sleep Timer only while the unit is turned on.

How Sleep Timer actually works

The unit automatically turns off after the specified time length passes.

On the remote control ONLY:

1 Press SLEEP.

The time length until the shut-off time appears and the SLEEP indicator lights up on the display.

- Each time you press the button, the time length changes as follows:

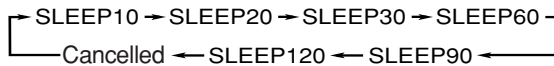

2 Wait for about 5 seconds after specifying the time length.

To check the remaining time until the shut-off time, press SLEEP once so that the remaining time until the shut-off time appears for about 5 seconds.

To change the shut-off time, press SLEEP repeatedly until the desired time length appears on the display.

To cancel the setting, press SLEEP repeatedly so that the SLEEP indicator goes off.

- Sleep Timer is also cancelled when you turn off the unit.



- **If you set the Sleep Timer after the Daily Timer starts playing the selected source**
The Daily Timer is cancelled. When the Sleep Timer shut-off time comes, the unit will be turned off.
- **If you set the Sleep Timer after the recording Timer starts recording**
The Recording Timer is cancelled, but recording continues until the Sleep Timer shuts off the power.
- **If the unit is turned on when on-time comes**
Timer does not work.
- **When you unplug the power cord or if a power failure occurs**
The timer will be cancelled. You need to set the clock first, then the timer again.



To get the best performance of the unit, keep your discs, tapes, and mechanism clean.

Handling discs



- Remove the disc from its case by holding it at the edge while pressing the center hole lightly.
- Do not touch the shiny surface of the disc, or bend the disc.
- Put the disc back in its case after use to prevent warping.

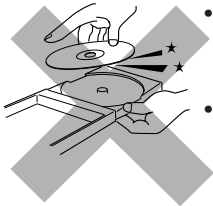

- Be careful not to scratch the surface of the disc when placing it back in its case.
- Avoid exposure to direct sunlight, temperature extremes, and moisture.

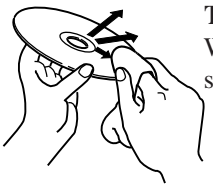

To clean the disc

Wipe the disc with a soft cloth in a straight line from center to edge.



DO NOT use any solvent — such as conventional record cleaner, spray, thinner, or benzine — to clean the disc.

Handling cassette tapes

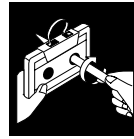

- If the tape is loose in its cassette, take up the slack by inserting a pencil in one of the reels and rotating.
- If the tape is loose, it may get stretched, cut, or caught in the cassette.

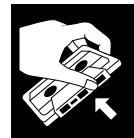

- Be careful not to touch the tape surface.

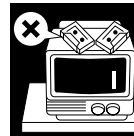

- Avoid the following places to store the tape:
 - In dusty places
 - In direct sunlight or heat
 - In moist areas
 - Near a magnet

Cleaning the unit

• Stains on the unit

Should be wiped off with a soft cloth. If the unit is heavily stained, wipe it with a cloth soaked in water-diluted neutral detergent and wrung well, then wipe clean with a dry cloth.

• Since the unit may deteriorate in quality, become damaged or suffer surface wear, be careful about the following:

- DO NOT wipe it with a hard cloth.
- DO NOT wipe it with excessive force.
- DO NOT wipe it with thinner or benzine.
- DO NOT apply any volatile substance such as insecticides to it.
- DO NOT allow any rubber or plastic to remain in contact with it for a long time.

Troubleshooting



If you have a problem with your unit, check this list for a possible solution before calling for service.

If you cannot solve the problem from the hints given here, or the unit has been physically damaged, call a qualified person, such as your dealer, for service.

| Symptom | Cause | Action |
|---|--|--|
| Unable to cancel the display demonstration. | Other buttons are pressed to cancel the display demonstration. | Press CANCEL/DEMO on the unit. (See page 8.) |
| No sound is heard. | Connections are incorrect or loose. | Check all connections and make corrections. (See pages 6 to 8.) |
| Hard to listen to broadcasts because of noise. | <ul style="list-style-type: none"> Antennas are disconnected. The AM loop antenna is too close to the unit. The FM antenna is not properly extended and positioned. | <ul style="list-style-type: none"> Reconnect the antennas correctly and securely. Change the position and direction of the AM loop antenna. Extend the FM antenna at the best position. |
| The disc sound is discontinuous. | The disc is scratched or dirty. | Clean or replace the disc. (See page 31.) |
| The disc tray does not open or close. | <ul style="list-style-type: none"> The AC power cord is not plugged in. Tray is locked. | <ul style="list-style-type: none"> Plug the AC power cord. Unlock the tray. (See page 16.) |
| The disc does not play. | The disc is placed upside down. | Place the disc with the label side up. |
| The cassette holders cannot be opened. | Power supply from the AC power cord has been cut off while the tape was running. | Turn on the unit. |
| Impossible to record. | Small tabs on the back of the cassette are removed. | Cover the holes with adhesive tape. |
| Stereo effect is lost. | Karaoke is activated. | Cancel the Karaoke. (See page 26.) |
| Operations are disabled. | The built-in microprocessor may have malfunctioned due to external electrical interference. | Unplug the AC power cord and then plug it back in. |
| Unable to operate the unit from the remote control. | <ul style="list-style-type: none"> The path between the remote control and the remote sensor on the unit is blocked. The batteries are exhausted. | <ul style="list-style-type: none"> Remove the obstruction. Replace the batteries. |

Specifications

Design and specifications are subject to change without notice.

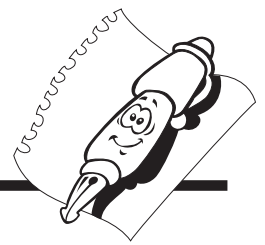

Amplifier section

Output Power
MAIN SPEAKERS: 64 W per channel, min. RMS, both channels driven into 6 Ω at 1 kHz with no more than 0.9% total harmonic distortion.

Audio input sensitivity/Impedance
(Measured at 1 kHz, with tape recording signal 300 mV)
AUX: 400 mV/50 k Ω
MIC: 3 mV/10 k Ω

Tuner

FM tuning range: 87.50 MHz – 108.00 MHz
AM tuning range:
At 9 kHz intervals: 531 kHz – 1 710 kHz
At 10 kHz intervals: 530 kHz – 1 710 kHz

CD player

CD capacity: 3 CDs
Dynamic range: 85 dB
Signal-to-noise ratio: 90 dB
Wow and flutter: Immeasurable

Cassette deck

Frequency response
Normal (type I): 50 Hz — 14 000 Hz
Wow and flutter: 0.15% (WRMS)

General

Power requirement: AC 110 V / AC 127 V / AC 220 V / AC 230 V – AC 240 V \sim
(adjustable with the voltage selector),
50 Hz / 60 Hz
Power consumption: 100 W (at operation)
20 W (on standby)

Dimensions (approx.): 270 mm x 306 mm x 433.5 mm (W/H/D)

Mass (approx.): 9.2 kg

Supplied accessories

See page 6.

Speaker Specifications

Type: 3-Way 3 Speaker Bass-Reflex
(Magnetically-Shielded Type)
Speakers
Main woofer : 15cm cone x 1
Mid Range : 5.0cm cone x 1
Tweeter : 2.0cm dome x 1
Power Handling Capacity : 80 W
Impedance : 6 Ω
Frequency Range : 42 Hz – 30 000Hz
Sound Pressure Level : 84 dB/W.m
Dimensions (W x H x D) : 215mm x 306 mm x 243 mm
Mass : 3.4 kg

Design and specifications subject to change without notice.

Mains (AC) Line Instruction (not applicable for Europe (except Turkey), U.S.A., Canada, Australia, and U.K.)

Elektrik (AC) Besleme Hattı Talimatları (Avrupa (Türkiye hariç), ABD, Kanada, Avustralya ve B.K. için geçerli değildir)

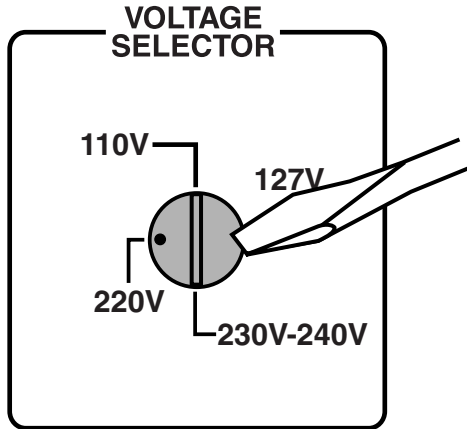

IMPORTANT for mains (AC) line

BEFORE PLUGGING IN, do check that your mains (AC) line voltage corresponds with the position of the voltage selector switch provided on the outside of this equipment and, if different, reset the voltage selector switch, to prevent from damage or risk of fire/electric shock.

Elektrik besleme (AC) hattı için ÖNEMLİ

CİHAZI PRİZE TAKMADAN ÖNCE, elektrik beslemesi (AC) hattı voltajının, cihazın dış tarafında bulunan voltaj seçme anahtarının belirttiği voltaj ile aynı olduğunu kontrol edin. Farklıysa, hasar ya da yangın/elektrik çarpması riskini ortadan kaldırmak için voltaj seçici anahtarını gereken değere ayarlayın.

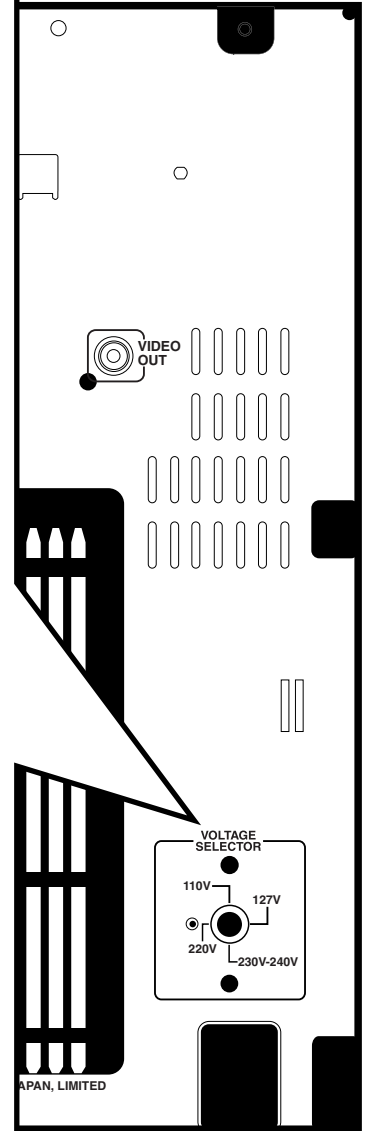

JVC

VICTOR COMPANY OF JAPAN, LIMITED

Free Manuals Download Website

<http://myh66.com>

<http://usermanuals.us>

<http://www.somanuals.com>

<http://www.4manuals.cc>

<http://www.manual-lib.com>

<http://www.404manual.com>

<http://www.luxmanual.com>

<http://aubethermostatmanual.com>

Golf course search by state

<http://golfingnear.com>

Email search by domain

<http://emailbydomain.com>

Auto manuals search

<http://auto.somanuals.com>

TV manuals search

<http://tv.somanuals.com>