

JVC



COMPACT COMPONENT SYSTEM

FS-Y1

Consists of CA-FSY1 and SP-FSY1

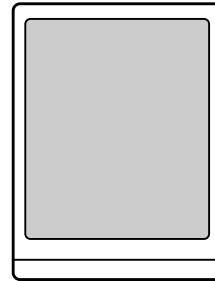
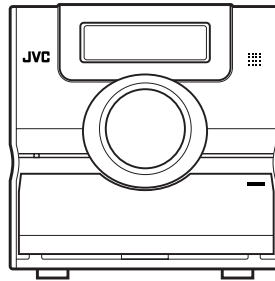
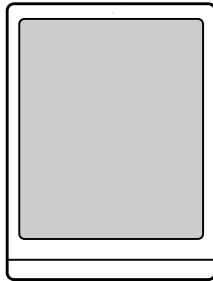
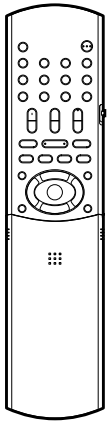

INSTRUCTIONS

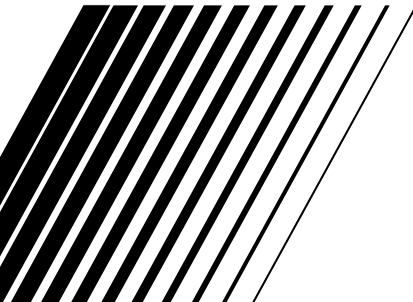

Warnings, cautions and others

IMPORTANT for the U.K.

DO NOT cut off the mains plug from this equipment. If the plug fitted is not suitable for the power points in your home or the cable is too short to reach a power point, then obtain an appropriate safety approved extension lead or consult your dealer.

BE SURE to replace the fuse only with an identical approved type, as originally fitted.

If nonetheless the mains plug is cut off ensure to remove the fuse and dispose of the plug immediately, to avoid a possible shock hazard by inadvertent connection to the mains supply.

If this product is not supplied fitted with a mains plug then follow the instructions given below:

IMPORTANT:

DO NOT make any connection to the terminal which is marked with the letter E or by the safety earth symbol or coloured green or green-and-yellow.

The wires in the mains lead on this product are coloured in accordance with the following code:

Blue: Neutral
Brown: Live

As these colours may not correspond with the coloured markings identifying the terminals in your plug proceed as follows:

The wire which is coloured blue must be connected to the terminal which is marked with the letter N or coloured black.

The wire which is coloured brown must be connected to the terminal which is marked with the letter L or coloured red.

IF IN DOUBT - CONSULT A COMPETENT ELECTRICIAN.

CAUTION

To reduce the risk of electrical shocks, fire, etc.:

1. Do not remove screws, covers or cabinet.
2. Do not expose this appliance to rain or moisture.

CAUTION — STANDBY/ON button!

Disconnect the mains plug to shut the power off completely (the STANDBY lamp goes off).

The STANDBY/ON  button in any position does not disconnect the mains line.

- When the system is on standby, the STANDBY lamp lights red.
- When the system is turned on, the STANDBY lamp lights green.

The power can be remote controlled.

CAUTION

- Do not block the ventilation openings or holes. (If the ventilation openings or holes are blocked by a newspaper or cloth, etc., the heat may not be able to get out.)
- Do not place any naked flame sources, such as lighted candles, on the apparatus.
- When discarding batteries, environmental problems must be considered and local rules or laws governing the disposal of these batteries must be followed strictly.
- Do not expose this apparatus to rain, moisture, dripping or splashing and that no objects filled with liquids, such as vases, shall be placed on the apparatus.

IMPORTANT FOR LASER PRODUCTS

1. CLASS 1 LASER PRODUCT
2. **CAUTION:** Do not open the top cover. There are no user serviceable parts inside the unit; leave all servicing to qualified service personnel.
3. **CAUTION:** Visible and invisible laser radiation when open and interlock failed or defeated. Avoid direct exposure to beam.
4. REPRODUCTION OF LABEL: CAUTION LABEL, PLACED INSIDE THE UNIT.

CAUTION: Visible and invisible laser radiation when open and interlock failed or defeated. AVOID DIRECT EXPOSURE TO BEAM.	ADVARSEL: Synlig og usynlig laserstråling når maskinen er åben eller interlocken fejler. Undgå direkte eksponering til strålingen.	VARNING: Synlig og osynlig laserstråling når den åbnes og spærren er urkopplad. Betrakta ej strålen.	VARO: Avattessa ja suojalukitus ohitettuna tai viallisena olet alitilina näkyvälle ja näkymättömälle lasersäteilylle. Vältä säteien kohdistumista suoraan iäsesi. (f)
--	---	---	--

Caution: Proper Ventilation

To avoid risk of electric shock and fire, and to prevent damage, locate the apparatus as follows:

1. Front: No obstructions and open spacing.
2. Sides/Top/Back: No obstructions should be placed in the areas shown by the dimensions below.
3. Bottom: Place on the level surface. Maintain an adequate air path for ventilation by placing on a stand with a height of 10 cm or more.

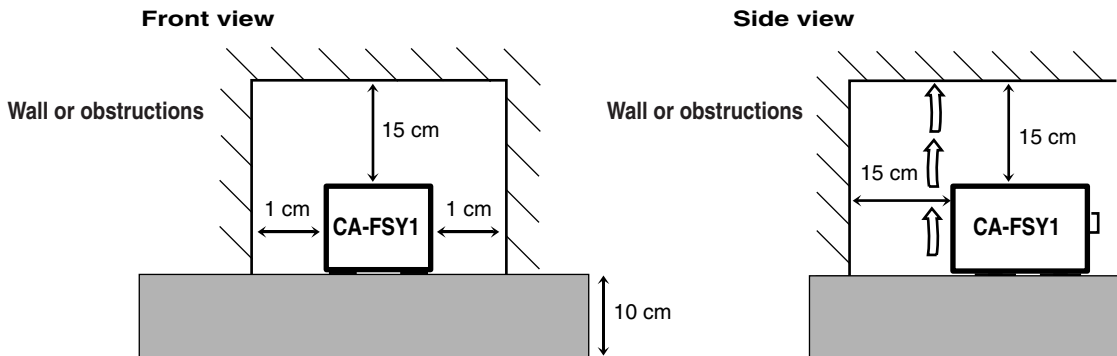

SAFETY INSTRUCTIONS

“SOME DOS AND DON'TS ON THE SAFE USE OF EQUIPMENT”

This equipment has been designed and manufactured to meet international safety standards but, like any electrical equipment, care must be taken if you are to obtain the best results and safety is to be assured.

Do read the operating instructions before you attempt to use the equipment.

Do ensure that all electrical connections (including the mains plug, extension leads and interconnections between pieces of equipment) are properly made and in accordance with the manufacturer's instructions. Switch off and withdraw the mains plug when making or changing connections.

Do consult your dealer if you are ever in doubt about the installation, operation or safety of your equipment.

Do be careful with glass panels or doors on equipment.

DON'T continue to operate the equipment if you are in any doubt about it working normally, or if it is damaged in any way — switch off, withdraw the mains plug and consult your dealer.

DON'T remove any fixed cover as this may expose dangerous voltages.

DON'T leave equipment switched on when it is unattended unless it is specifically stated that it is designed for unattended operation or has a standby mode.

Switch off using the switch on the equipment and make sure that your family know how to do this. Special arrangements may need to be made for infirm or handicapped people.

DON'T use equipment such as personal stereos or radios so that you are distracted from the requirements of traffic safety. It is illegal to watch television whilst driving.

DON'T listen to headphones at high volume as such use can permanently damage your hearing.

DON'T obstruct the ventilation of the equipment, for example with curtains or soft furnishings. Overheating will cause damage and shorten the life of the equipment.

DON'T use makeshift stands and NEVER fix legs with wood screws — to ensure complete safety always fit the manufacturer's approved stand or legs with the fixings provided according to the instructions.

DON'T allow electrical equipment to be exposed to rain or moisture.

ABOVE ALL

—NEVER let anyone, especially children, push anything into holes, slots or any other opening in the case — this could result in a fatal electrical shock.;

—NEVER guess or take chances with electrical equipment of any kind — it is better to be safe than sorry!

E43486-340B

IMPORTANT FOR LASER PRODUCTS

1. CLASS 1 LASER PRODUCT
2. **CAUTION:** Do not open the top cover. There are no user serviceable parts inside the unit; leave all servicing to qualified service personnel.
3. **CAUTION:** Visible and invisible laser radiation when open and interlock failed or defeated. Avoid direct exposure to beam.
4. REPRODUCTION OF LABEL: CAUTION LABEL, PLACED INSIDE THE UNIT.

CAUTION: Visible and invisible laser radiation when open and interlock failed or defeated. AVOID DIRECT EXPOSURE TO BEAM.	ADVARSEL: Synlig og usynlig laserstråling når maskinen er åben eller interlocken fejler. Undgå direkte eksponering til strålingen.	VARNING: Synlig og osynlig laserstråling når den åbnes og spærren er urkopplad. Betrakta ej strålen.	VARO: Avattessa ja suojalukitus ohitettuna tai viallisena olet alitaina näkyvälle ja näkymättömälle lasersäteilylle. Vältä säteiden kohdistumista suoraan iäsesi. (f)
--	---	---	--

Caution: Proper Ventilation

To avoid risk of electric shock and fire, and to prevent damage, locate the apparatus as follows:

1. Front: No obstructions and open spacing.
2. Sides/Top/Back: No obstructions should be placed in the areas shown by the dimensions below.
3. Bottom: Place on the level surface. Maintain an adequate air path for ventilation by placing on a stand with a height of 10 cm or more.

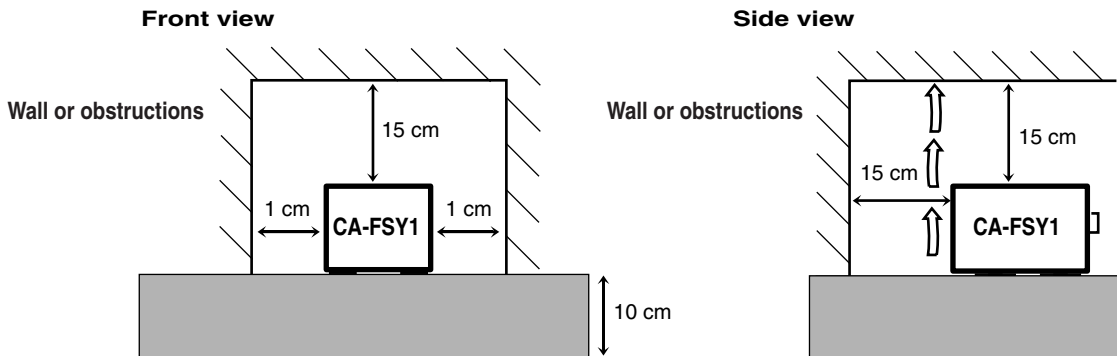

SAFETY INSTRUCTIONS

“SOME DOS AND DON'TS ON THE SAFE USE OF EQUIPMENT”

This equipment has been designed and manufactured to meet international safety standards but, like any electrical equipment, care must be taken if you are to obtain the best results and safety is to be assured.

Do read the operating instructions before you attempt to use the equipment.

Do ensure that all electrical connections (including the mains plug, extension leads and interconnections between pieces of equipment) are properly made and in accordance with the manufacturer's instructions. Switch off and withdraw the mains plug when making or changing connections.

Do consult your dealer if you are ever in doubt about the installation, operation or safety of your equipment.

Do be careful with glass panels or doors on equipment.

DON'T continue to operate the equipment if you are in any doubt about it working normally, or if it is damaged in any way — switch off, withdraw the mains plug and consult your dealer.

DON'T remove any fixed cover as this may expose dangerous voltages.

DON'T leave equipment switched on when it is unattended unless it is specifically stated that it is designed for unattended operation or has a standby mode.

Switch off using the switch on the equipment and make sure that your family know how to do this. Special arrangements may need to be made for infirm or handicapped people.

DON'T use equipment such as personal stereos or radios so that you are distracted from the requirements of traffic safety. It is illegal to watch television whilst driving.

DON'T listen to headphones at high volume as such use can permanently damage your hearing.

DON'T obstruct the ventilation of the equipment, for example with curtains or soft furnishings. Overheating will cause damage and shorten the life of the equipment.

DON'T use makeshift stands and NEVER fix legs with wood screws — to ensure complete safety always fit the manufacturer's approved stand or legs with the fixings provided according to the instructions.

DON'T allow electrical equipment to be exposed to rain or moisture.

ABOVE ALL

—NEVER let anyone, especially children, push anything into holes, slots or any other opening in the case — this could result in a fatal electrical shock.;

—NEVER guess or take chances with electrical equipment of any kind — it is better to be safe than sorry!

E43486-340B

Table of contents

Introduction

About discs	3
Description of parts	5

Getting started

Using the remote control	6
Putting the batteries in the remote control	6
Operating the TV using the remote control	7
Connecting up	8

Basic operations

Playing discs	12
Playback	12
To switch the display	13
Select what you want to play by using the number buttons	14
To stop playback	14
To pause playback	14
To advance picture frame-by-frame	14
Fast reverse/Fast forward search	14
Playing back from a position 10 seconds before (One Touch Replay)	15
Slow Motion Playback	15
Skip to the beginning of the selection	15
To change the brightness of the display window (DIMMER)	16
Adjusting the volume	16
Adjusting sound quality	16
Turning off the sound temporarily (MUTING) ...	16

Advanced operations

Playing audio/video files	16
Resume Playback	18
Select the scene to be played	19
Program Playback/Random Playback	20
Repeat Playback	22
Other convenient functions	24
Selecting the subtitles	24
Selecting the audio language	24
Selecting a view angle	24
Enlarging the picture (ZOOM)	25
Adjusting the picture quality (VFP)	25
Creating realistic sound (3D PHONIC)	26
Adjusting playback level (DVD LEVEL)	26
Enjoying better pictures (SCAN MODE)	26

Functions specific to DVD AUDIO	27
Playing the Bonus Group	27
Browsable Still Pictures (B.S.P.)	27
Using the menu bar	28
Preferences	29
Country/Area codes	31

Listening to radio

Listening to a radio broadcast	32
Tuning in to a preset station	33
Using the RDS	34
Using the RDS (Radio Data System) when receiving FM stations	34

Convenient functions

Listening to the sound of other audio device	38
Setting the various timer	38
Setting the built-in clock	38
Setting the daily timer	38
Auto Standby	39
Sleep Timer	40
Tray Lock	40

Reference

Troubleshooting	41
Language codes	42
Specifications	43

How to read this manual

- Operations are described by mainly using the remote control buttons. If there are the same marks on the main unit, the buttons on the main unit can also be used.
- The following marks tell you for which type of the discs the operation can be made.



- The illustrations and TV screens may be different between the actual case and the description.
- "VCD" is an abbreviation of "Video CD".
- "SVCD" is an abbreviation of "Super Video CD".

Special cautions

Notes on handling

■ Important cautions

Installation of the system

- Select a place which is level, dry and neither too hot nor too cold; between 5°C and 35°C.
- Leave sufficient distance between the system and the TV.
- Do not use the system in a place subject to vibration.

Power cord

- Do not handle the power cord with wet hands.
- A small amount of power is always consumed while the power cord is connected to the wall outlet.
- When unplugging the power cord from the wall outlet, always pull on the plug, not the power cord.

To prevent malfunctions of the system

- There are no user-serviceable parts inside. If anything goes wrong, unplug the power cord and consult your dealer.
- Do not insert any metallic object into the system.
- Do not use any non-standard shape disc (like a heart, flower or credit card, etc.) available on the market, because it may damage the system.
- Do not use a disc with tape, stickers, or paste on it, because it may damage the system.

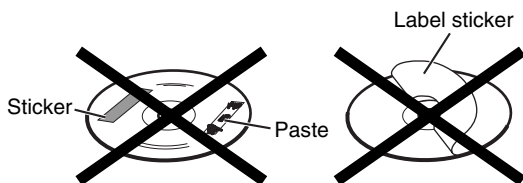

Note about copyright laws

Check the copyright laws in your country before recording from DVDs, VCDs, SVCDs, and CDs. Recording of copyrighted material may infringe copyright laws.

Note about copy guard system

DVDs are protected by copy guard system. When you connect the system to your VCR directly, the copy guard system activates and the picture may not be played back correctly.

■ Safety precautions

Avoid moisture, water and dust

Do not place the system in moist or dusty places.

Avoid high temperatures

Do not expose the system to direct sunlight and do not place it near a heating device.

When you are away

When away on travel or for other reasons for an extended period of time, disconnect the power cord plug from the wall outlet.

Do not block the vents

Blocking the vents may damage the system.

Care of the cabinet

When cleaning the system, use a soft cloth and follow the relevant instructions on the use of chemically-coated cloths. Do not use benzene, thinner or other organic solvents including disinfectants. These may cause deformation or discoloring.

If water gets inside the system

Turn the system off and disconnect the power cord plug from the wall outlet, then call the store where you made your purchase. Using the system in this condition may cause fire or electrical shock.

■ When condensation or water drops adhere to the lens

In any of the following cases, condensation or water drops may adhere to the lens to prevent the system from working properly:

- Immediately after starting to heat the room
- When the system is installed in a steamy or damp space
- When the system is suddenly moved from a cold place to a warm space

In any of these cases, leave the system turned on for 1 or 2 hours before use.

Supplied accessories

Check to be sure you have all of the supplied accessories.

The number in parentheses is the quantity of the pieces supplied. If anything is missing, contact your dealer immediately.

- Remote control (1)
- Batteries (2)
- FM antenna (1)
- AM loop antenna (1)
- Power cord (1)
- Composite video cord (1)
- Speaker cords (2)

-
- *Manufactured under license from Dolby Laboratories. "Dolby", "Pro Logic", "MLP Lossless", and the double-D symbol are trademarks of Dolby Laboratories.*
 - *"DTS" and "DTS 2.0+DIGITAL OUT" are registered trademarks of Digital Theater Systems, Inc.*
 - *This product incorporates copyright protection technology that is protected by method claims of certain U.S. patents and other intellectual property rights owned by Macrovision Corporation and other rights owners. Use of this copyright protection technology must be authorized by Macrovision Corporation, and is intended for home and other limited viewing uses only unless otherwise authorized by Macrovision Corporation. Reverse engineering or disassembly is prohibited.*

Playable disc types

This system has been designed to play back the following discs:

DVD VIDEO, DVD AUDIO, VCD, SVCD, CD

This system can also play back the following discs:

- Finalized DVD-R/-RW discs recorded in the DVD VIDEO format.
- CD-R/RW discs recorded in the following formats
 - Music CDs (finalized discs)
 - VCDs
 - SVCDs
 - MP3/WMA/JPEG discs recorded in ISO 9660 (for details, refer to “Notes on CD-R and CD-RW ”)

However, some discs may not be played back because of their disc characteristics, recording conditions, or damage or stain on them.

Only sounds can be played back from the following discs:

MIX-MODE CD CD-G
 CD-EXTRA CD TEXT

Discs you can play:

Disc Type	Mark (Logo)	Video Format
DVD VIDEO		PAL
DVD AUDIO		—
VCD		PAL
SVCD		PAL
CD		—
CD-R		—
CD-RW		—



is a trademark of DVD Format/Logo Licensing Corporation.

* Note on Region Code

DVD players and DVD VIDEOS have their own Region Code numbers. This system can only play back a DVD VIDEO recorded with the Region Code number and video format mentioned below.

For your available Region Code, check the rear panel of your main unit.

This system can play back only DVD VIDEOS whose Region Code numbers include “2”.

Examples:



If a DVD VIDEO with an improper Region Code number is loaded, “REGION CODE ERROR!” appears on the TV screen and playback cannot start.

- On some DVD VIDEOS, DVD AUDIOS, VCDs or SVCDs, their actual operation may be different from what is explained in this manual. This is due to the disc programming and disc structure, not a malfunction of this system.

Notes on DVD-R and DVD-RW

- This system can also play finalized DVD-Rs or DVD-RWs recorded in DVD-Video format.

Notes on CD-R and CD-RW

- This system can also play CD-Rs or CD-RWs if MP3, WMA, and JPEG files are recorded on them with ISO 9660 format.
- This system supports “multi-session” discs (up to 20 sessions).
- This system cannot play “packet write” (UDF format) discs. Some discs may not be played back because of their disc characteristics, recording conditions, or damage or stain on them.

Discs that cannot be played back

- The following discs cannot be played back: DVD-ROM, DVD-RAM, DVD-R/-RW (recorded in VR format), CD-ROM, CD-I (CD-I Ready), Photo CD, SACD, etc.

Playing back these discs will generate noise and damage the speakers.

Damaged discs and discs in an extraordinary shape (other than a disc of 12 cm or 8 cm) cannot be played back.

Caution for DualDisc playback

The non-DVD side of a “DualDisc” does not comply with the “Compact Disc Digital Audio” standard. Therefore, the use of Non-DVD side of a DualDisc on this product may not be recommended.

Notes on all files

- The system can only recognize and play files with one of the following extensions, which can be in any combination of upper and lower case;
 - MP3: “.MP3”, “.mp3”
 - WMA: “.WMA”, “.wma”
 - JPEG: “.JPG”, “.JPEG”, “.jpg”, “.jpeg”
- If a character other than single byte English characters is used in the file name of an MP3/WMA/JPEG file, the track/file name will not be displayed correctly.
- The system recognizes up to 150 tracks (files) per group, 99 groups per disc, and the total number of the tracks (files) that the system can play is 1 000.
- Some files may not be played back normally because of their disc characteristics or recording conditions.

For MP3/WMA files

- An off-the-shelf MP3 disc may be played in an order different from that indicated on the label attached to the disc.
- The system supports MP3/WMA files recorded with a bit rate of 32 – 320 kbps and a sampling frequency of 16 kHz, 22.05 kHz, 24 kHz (WMA only), 32 kHz, 44.1 kHz, or 48 kHz.
- If the tag information (album name, artist, and track title, etc.) is recorded on a disc, it appears in the file control display on the TV screen.
- We recommend to record each piece of material (song) at a sample rate of 44.1 kHz and at a data transfer rate of 128 (96 for WMA only) kbps.
- This system cannot play back files encoded with Multiple Bit Rate (MBR). (MBR is a format to encode a file content at several different bit rates.)

For JPEG files

- We recommend to record a file at 640 x 480 resolution.
- This system can play a baseline JPEG file, excluding monochromatic JPEG files.
- This system can play JPEG data taken with a digital camera conforming to the DCF (Design Rule for Camera File System) standard (when a function is applied such as the automatic rotation function of a digital camera, data goes beyond the DCF standard, so the image may not be displayed).
- If data has been processed, edited and restored with PC image editing software, the data may not be displayed.
- This system cannot play animations such as MOTION JPEG, or still images (TIFF etc.) other than JPEG, and image data with sound.
- An image with a resolution of more than 8 192 x 7 680 pixels cannot be displayed.

Disc structure

DVD VIDEO

A DVD VIDEO consists of “titles” and each title may be divided into “chapters”.

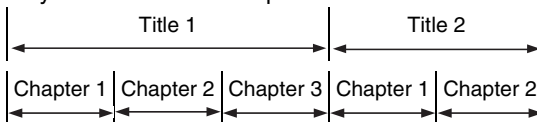

DVD AUDIO

A DVD AUDIO consists of “groups” and each group may be divided into “tracks”.

Some discs include a “bonus group” that requires a password for playing (page 27).

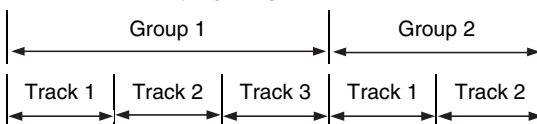

VCD/SVCD/CD

VCD, SVCD and CD consist of “tracks”.

In general, each track has its own track number. (On some discs, each track may also be further divided by indexes.)

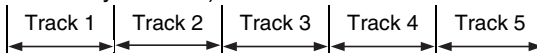

MP3/WMA [JPEG] discs

On an MP3/WMA [JPEG] disc, each still picture (material) is recorded as a track [file]. Tracks [Files] are usually grouped into a folder. Folders can also include other folders, creating hierarchical folder layers.

This unit simplifies the hierarchical construction of a disc and manages folders by “groups”.

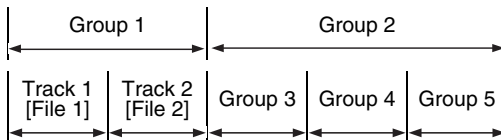

This product can recognize up to 1 000 tracks [files] in a disc. Also, the product can recognize up to 150 tracks [files] per group and up to 99 groups in a disc. Since the unit ignores the tracks [files] whose numbers are exceeding 150 and the groups whose numbers are exceeding 99, they cannot be played back.

- If there is any type of files other than MP3/WMA [JPEG] files in a folder, those files are also counted in the total file number.

The numbers represent the page numbers.

Front panel

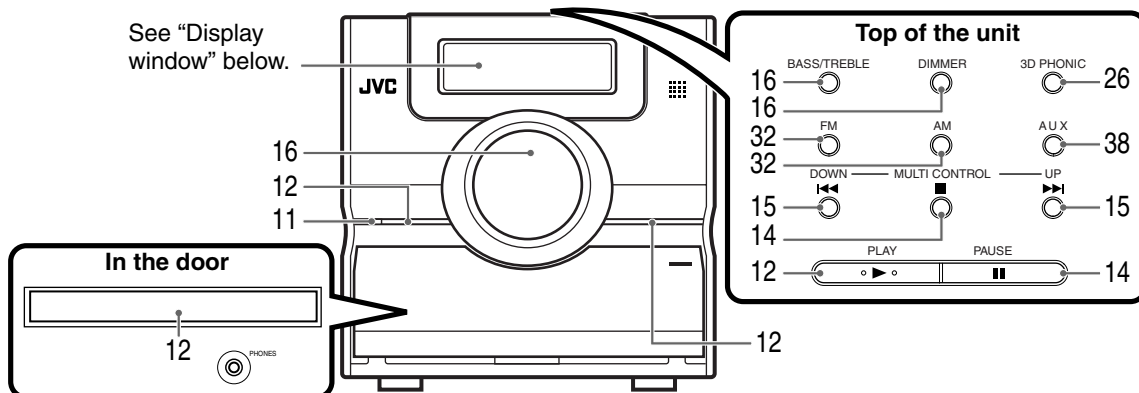

* Connect headphones (not supplied) with a stereo mini plug. If the headphones are connected, the speakers and subwoofer will not produce any sound.

Display window

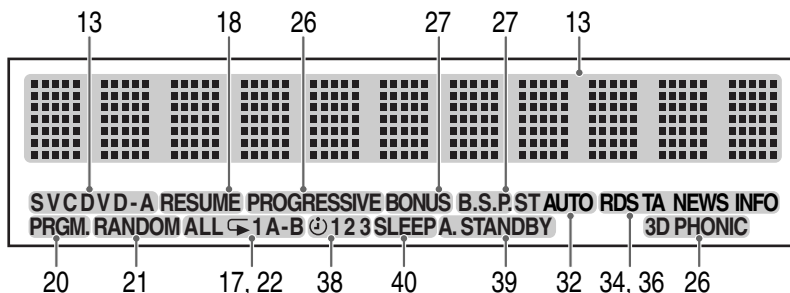

Rear panel

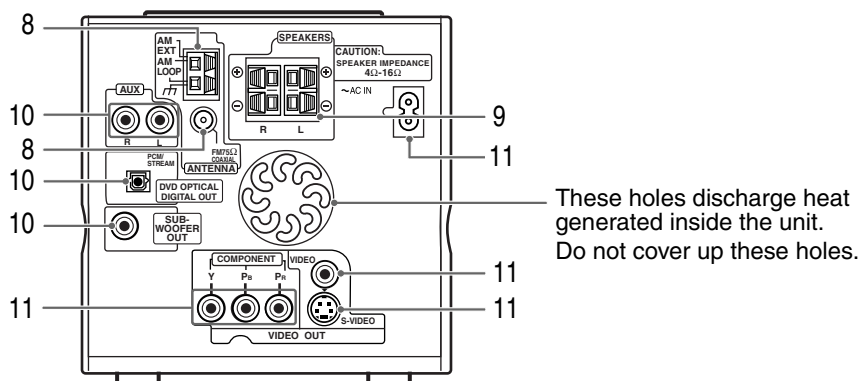

Using the remote control

The numbers represent the page numbers.

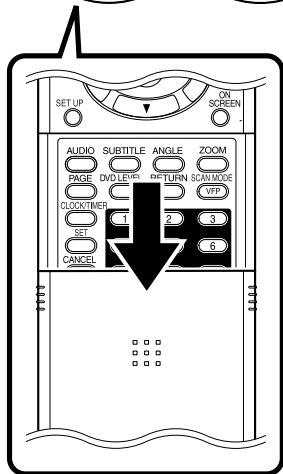
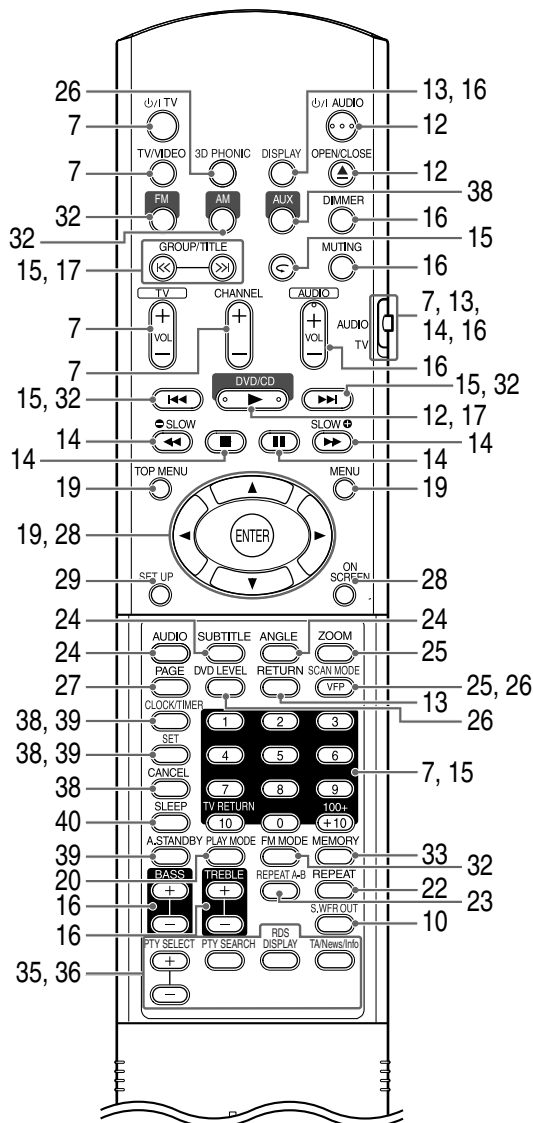

Putting the batteries in the remote control

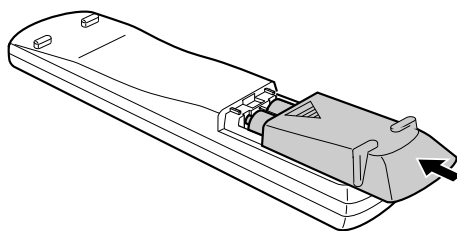
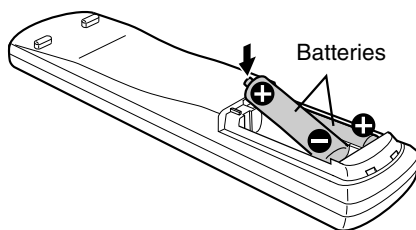
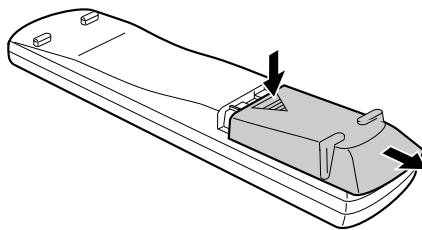

If the range or effectiveness of the remote control decreases, replace the batteries. Use two R6 (SUM-3)/AA(15F) type dry-cell batteries.

CAUTION

- Do not use a used battery and a new battery together.
- Do not use different types of batteries at the same time.
- Take out the batteries if the remote control is not to be used for a long time. Otherwise it may cause a leakage.

Remote control operation

When operating the remote control, point it towards the front panel of the main unit. If the remote control is operated from a direction that is extremely oblique or when there is an obstacle in the way, signals may not be transmitted.

If the remote control sensor is exposed to a strong light such as direct sunlight, correct operation may not be carried out.

This page is for when operating your TV using the remote control of this product.

Operating the TV using the remote control

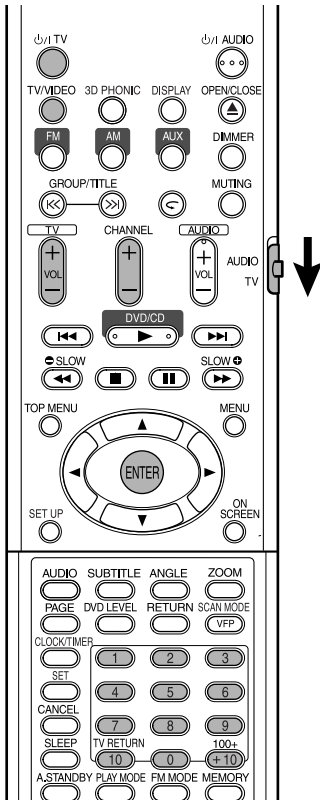

Setting the manufacturer's code

- Slide the remote control mode selector to the TV side.



- Keep pressing down \odot /I TV.

NOTE

Keep pressing down \odot /I TV until Step 4 is complete.

- Press ENTER.

- Press number buttons (1-9, 0).

Ex.:

For a Hitachi TV: Press 0, then 7.
For a Toshiba TV: Press 2, then 9.

If there are more than one manufacturer's codes, try them in turn and select the one that causes the product to work properly.

Manufacturer	Code	Manufacturer	Code
JVC	01	Nordmende	13, 14, 18, 26 – 28
Akai	02, 05	Okano	09
Blaupunkt	03	Orion	15
Daewoo	10, 31, 32	Panasonic	16, 17
Fenner	04, 31, 32	Philips	10
Fisher	05	Saba	13, 14, 18, 26 – 28
Grundig	06	Sanyo	05
Hitachi	07, 08	Schneider	02, 05
Inno-Hit	09	Sharp	20
Irradio	02, 05	Sony	21 – 25
Magnavox	10	Telefunken	13, 14, 18, 26 – 28
Mitsubishi	11, 33	Thomson	13, 14, 18, 26 – 28, 30
Miver	03	Toshiba	29
Nokia	12, 34		

NOTE

Manufacturer's codes may be changed without notice. You may not be able to operate a TV produced by the manufacturer shown above.

5 Release \odot /I TV.

For TV operation

Operate the remote control by pointing it towards the TV.

\odot /I TV	Turn ON/OFF the power.
CHANNEL	Change channels.
TV VOL	Adjust volume.
1 ~ 9 / 0 / 100+ / +10	Select channels. *1
TV RETURN 10	Alternates between the previously selected channel and the current channel.
TV/VIDEO	Switch TV and video input.

*1 Make sure to slide the remote control mode selector to the TV side in advance.

NOTE

When the batteries are replaced, perform the manufacturer's code setting again.

Connecting antennas

Connecting AM loop antenna (supplied)

1 Set up the AM loop antenna.

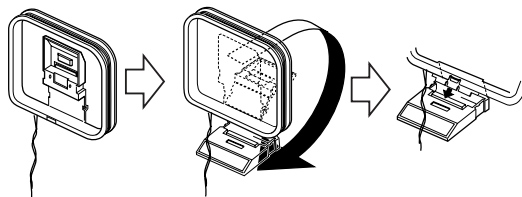

2 Connect antenna cords.

Main unit
(rear panel)

AM
EXT
AM
LOOP

How to insert antenna cords

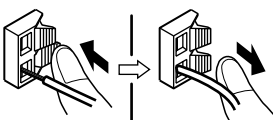

Connect two antenna cords as described above.

If the antenna cord is covered with vinyl on the tip, twist and pull the vinyl off and remove.

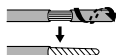

3 Turn the AM loop antenna to the direction of the best radio reception.

Locate the AM loop antenna as far away from the main unit as possible.

- Do not locate the AM loop antenna on a metallic table or close to a TV, personal computer, etc. Otherwise it may result in bad radio reception.

■ When good radio reception cannot be obtained with the supplied AM loop antenna

Electric wire: 3 - 5 m (commercially available)

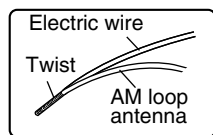

Put up an electric wire extending horizontally, preferably at a high place such as above a window or outdoors.

AM
EXT
AM
LOOP

Main unit
(rear panel)

Connect the AM loop antenna cords together.

Connecting FM antenna (supplied)

Main unit
(rear panel)

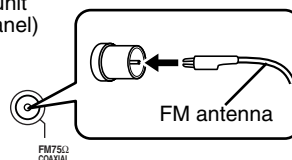

Put the antenna up straight in the direction where the best radio reception can be obtained, and fix by using tape.

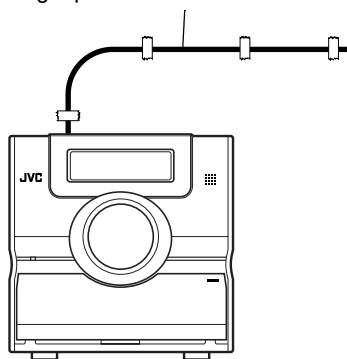

■ When good radio reception cannot be obtained with the supplied antenna or when using a communal antenna

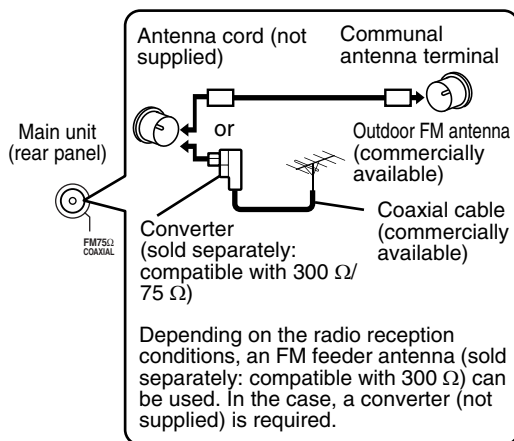

For details of connecting a separately sold antenna, refer to the user guide for the antenna or converter.

When positioning the antenna, listen to an actual radio program (refer to "Listening to a radio broadcast" on page 32).

Connecting speakers

There is no difference between the left and right speakers.

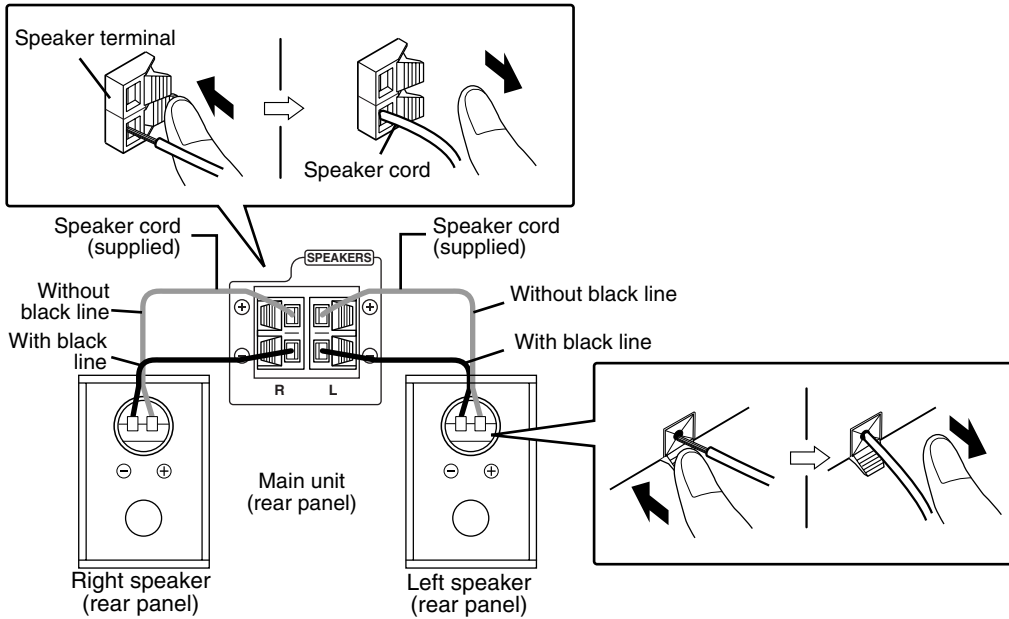

CAUTION

- **DO NOT** connect more than one speaker to one speaker terminal.
- The speakers of this product are magnetically shielded, but color irregularities may occur on the TV depending on how the speakers are installed. Keep in mind the following.
 1. Turn off the main power of your TV before installing the speakers. Wait for about 30 minutes before turning on the TV again.
 2. If color irregularity occurs in pictures, keep a distance of more than 10 cm between the TV and the speakers.

Speaker grille can be detached.

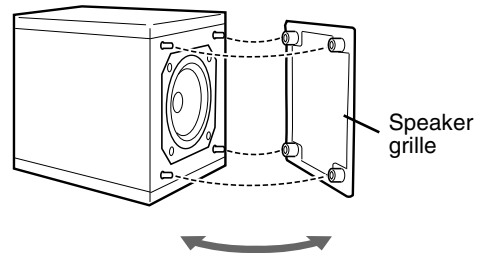

NOTE

- Impedance of speaker that can be connected to the main unit is within a range of 4Ω to 16Ω .
- In order to have a sufficient cooling effect, leave a space of more than 1 cm between the main unit and the speakers or other objects.

Connecting other devices

This page is for when connecting the main unit with other devices.

Connecting subwoofer

With an amplifier-built-in subwoofer (not supplied), you can enjoy a more dynamic bass sound. Refer to the manual of the subwoofer for details.

Amplifier-built-in subwoofer (not supplied)

Audio cord (not supplied)
(If an audio cord comes with the amplifier-built-in subwoofer, you can use the cord.)

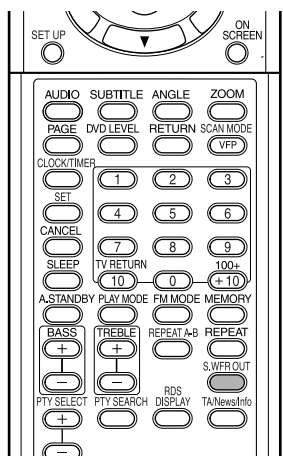
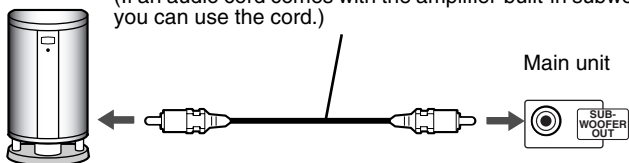

When you want to hear sound from the subwoofer, press **S.WFR OUT** on the remote control to display “SUBWOOFER” on the display window on the main unit. Each time you press the button, the display toggles between “SUBWOOFER” and “OFF”.

NOTE

When “SUBWOOFER” is selected, bass sound from the left and right speakers will be automatically lowered and the bass sound will be emitted mainly from the subwoofer.

Connecting with other audio device

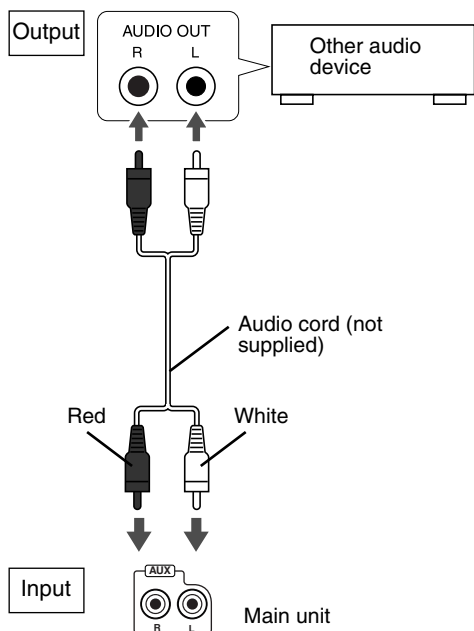

Connecting with a digital device

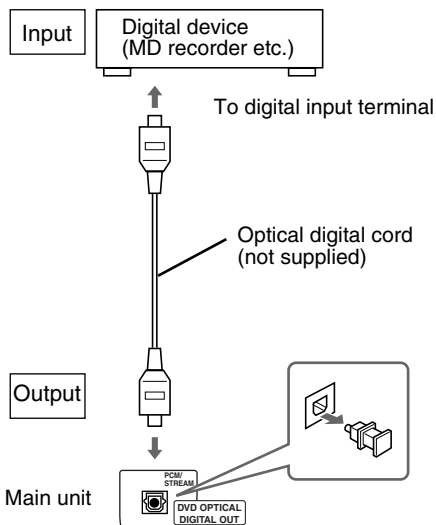

CAUTION

- For details of signals to be output, refer to page 30.
- If connecting the main unit with equipment with the function of a Dolby Digital decoder, the setting in “D. RANGE COMPRESSION” of “AUDIO” (page 30) will be invalid regarding sound from the digital audio output of the main unit.

Connecting with TV

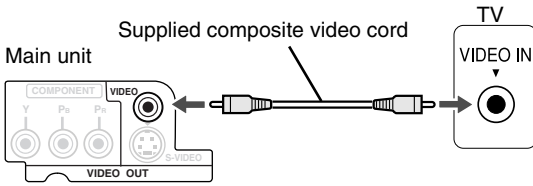

CAUTION

Connect the main unit directly with a TV (or a monitor) without routing through a VCR. Otherwise it may cause picture distortion while playing.

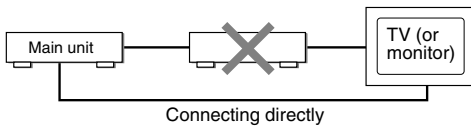

Also, when connecting the main unit to a TV with a VCR built in, there may be picture distortion while playing.

You can enjoy pictures of better quality using the following cord instead of the supplied video cord.

Connecting by using the S-Video cord

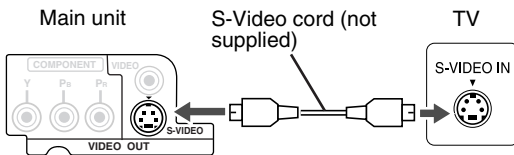

Connecting by using the component video cord

You can enjoy better quality pictures than when using the S-Video cord.

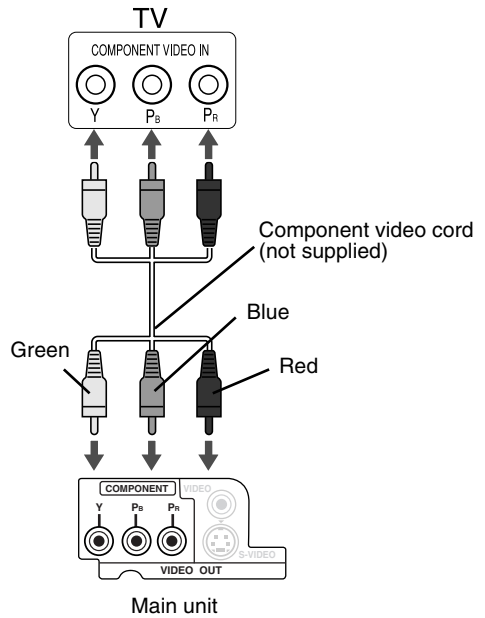

CAUTION

Use one of either the S-Video cord or the component video cord. If both cords are used, pictures may not be played properly.

NOTE

- In order to enjoy pictures with Progressive mode (page 26), the TV is required to have Progressive video input.
- If the component video input jacks of your TV are BNC type, use a plug adapter (not supplied) to convert the plugs.

Connecting the power cord

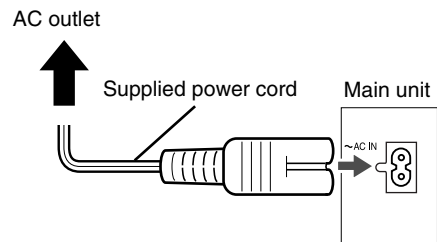

- Connect the power cord after all other connections are complete.
- The standby lamp (on the front panel) will be lit.

Playing discs

Playback

DVD VIDEO **DVD AUDIO** **VCD** **SVCD** **CD** (Refer to page 17 for playing MP3/WMA and JPEG.)

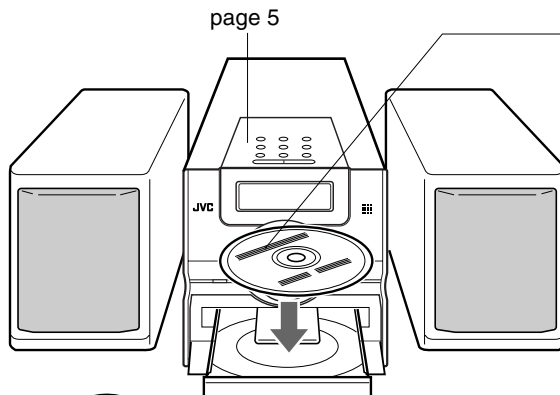

Place a disc with the label side facing up.

- Place an 8 cm disc in to the hollow part in the center.

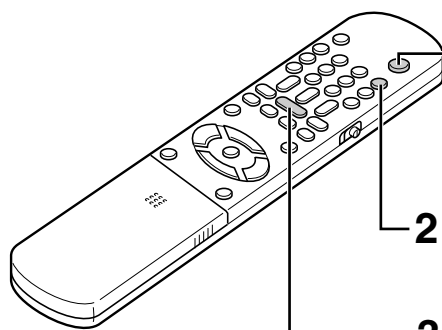

1 Press **⏻/AUDIO**.

- The power will be turned on and the standby lamp will go off.
- Press **⏻/AUDIO** again to turn off the power.

2 Press **⬆️/OPEN/CLOSE** to open the disc tray to load a disc.

3 Press **DVD/CD ▶️**.

The disc tray will close and playback will start.

- The power will be turned on when any of **PLAY ▶️**, **FM**, **AM**, **AUX**, or **⬆️** on the main unit and **DVD/CD ▶️**, **FM**, **AM**, **AUX**, or **⬆️/OPEN/CLOSE** on the remote control is pressed while the power is off.
- If any button other than **⬆️** or **⬆️/OPEN/CLOSE** is pressed, the source will also be changed (if there is a disc loaded, playback will start).

NOTE

- A menu screen may be displayed on the TV after starting playback of a DVD/VCD/SVCD. In this case, select a desired item to playback by using the following buttons on the remote control.
 - Select a desired item using cursor **⬆️/⬆️/⬅️/➡️** and press **ENTER**.
 - Select a desired item using the number buttons.
 - Depending on the disc, actual operation may be different from the description.

JVC

Screens displayed on the TV when the power is turned ON.

The following messages appear depending on the status of the system. (When FM, AM, or AUX is selected as a source, the messages do not appear.)

NOW READING	Appears when the system is reading the disc information. Wait for a while.
REGION CODE ERROR!	Appears when the Region Code of the DVD VIDEO does not match the code the system supports. (page 3)
NO DISC	Appears when no disc is loaded.
OPEN	Appears when opening the disc tray.
CLOSE	Appears when closing the disc tray.
CANNOT PLAY THIS DISC	Appears when trying to play back an unplayable disc.

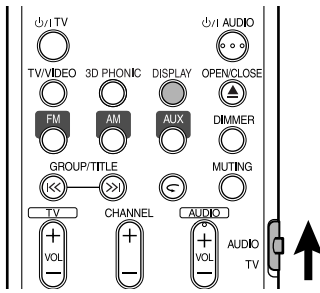

Display window during disc playback

Ex.: When a DVD VIDEO is played

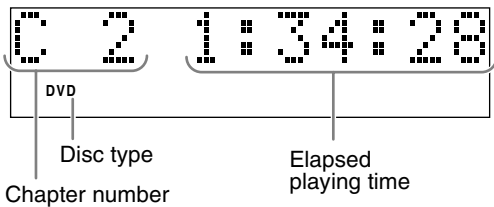

Ex.: When a DVD AUDIO is played

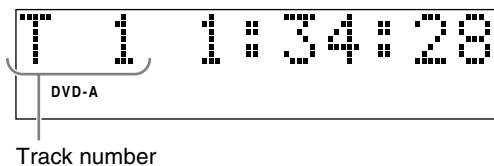

If "BONUS" or "B.S.P." is displayed during a DVD AUDIO playback, refer to page 27.

Ex.: When an SVCD or VCD is played

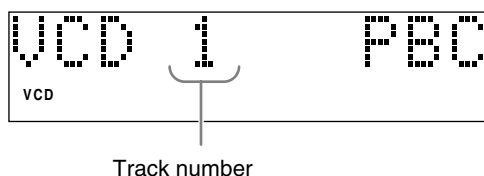

- When playing an SVCD, the SVCD indicator lights instead of the VCD indicator.
- PBC (Play Back Control): A signal recorded in a VCD (version 2.0) for controlling playback. It is possible to enjoy interactive software or software with a search function using a menu screen recorded in a PBC compatible VCD. To play a disc with the PBC function OFF, carry out the following operations.
 - Designate the track number using the number buttons while the disc is stopped.
 - Designate the track number using **▶▶▶** while the disc is stopped, and then press **DVD/CD ▶**.
- Press **RETURN** to go back to the upper layer during the PBC playback of a VCD or SVCD.

Ex.: When a CD is played

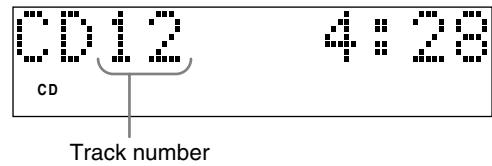

Ex.: When an MP3/WMA file is played

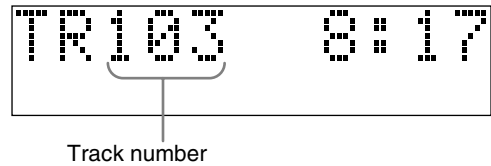

To switch the display

Press **DISPLAY**.

Each time you press the button, the display indication changes temporarily as follows:

- **For DVD VIDEO**

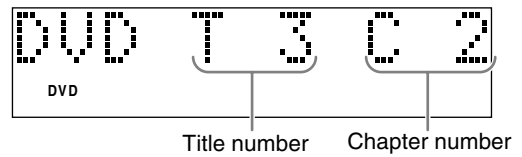

- **For DVD AUDIO**

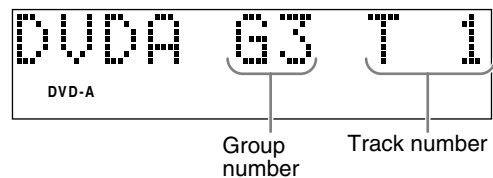

- **For MP3/WMA**

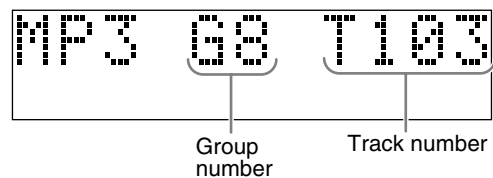

- **For SVCD/VCD/CD**

The clock time indication appears on the display window.

- Before setting the clock (page 38), "0:00" appears.
- When the unit is turned off, pressing **DISPLAY** turns off the clock indication to save the power consumption.

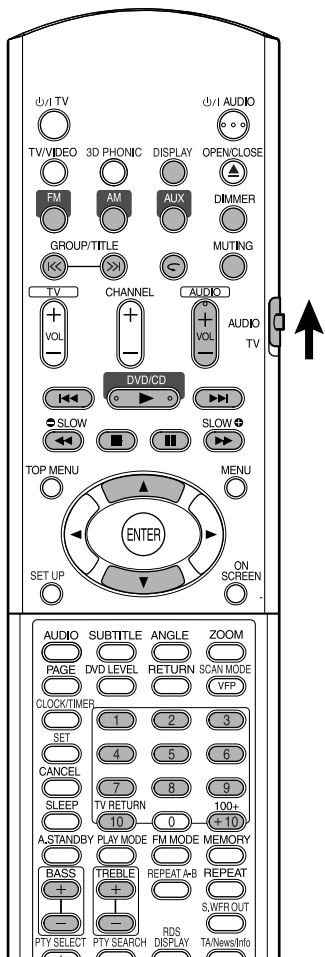

Select what you want to play by using the number buttons



NOTE

- Set the remote control mode selector to **AUDIO** before using the number buttons. 
- For a VCD or SVCD, this operation can be carried out when the disc is stopped, or during playback without the PBC function.
- For a DVD AUDIO, CD, MP3/WMA or JPEG, this operation can also be carried out when the disc is stopped.
- This operation may not be carried out for some discs.

Designate the chapter number or track number to play during playback.

- Refer to “How to use the number buttons” on page 15.

To stop playback



Press **■** during playback.

To pause playback



Press **⏸** during playback.

To start normal playback again, press DVD/CD **▶**.

- For JPEG slide-show, pressing DVD/CD **▶** starts playback from the next file.

To advance picture frame-by-frame



Press **⏮** during pause.

- Each time you press the button, picture will be advanced frame-by-frame.

Fast reverse/Fast forward search



Press **⏮** or **⏭** during playback.

- Each time you press the button, the speed increases (×2, ×5, ×10, ×20, ×60). To restore the normal speed, press DVD/CD **▶**.

NOTE

- Fast reverse/Fast forward search cannot be carried out for MP3, WMA, and JPEG.
- For a DVD VIDEO, VCD or SVCD, no sound comes out during Fast reverse/Fast forward search.
- For a CD or DVD AUDIO, sound is intermittent during Fast reverse/Fast forward search.

Playing back from a position 10 seconds before (One Touch Replay)

DVD VIDEO

Press ◀ during playback.

NOTE

- This operation may not be carried out for some discs.
- It is not possible to go back to the previous title.

Slow Motion Playback

DVD VIDEO VCD SVCD

Press SLOW ◯ or SLOW ⊕ during pause.

- Each time you press the button, the playback speed increases (×1/32, ×1/16, ×1/8, ×1/4, ×1/2).
- Press DVD/CD ▶ to start normal playback again.

NOTE

- No sound will be produced.
- The picture motion in the reverse direction may not be smooth.
- For a VCD or SVCD, Slow Motion Playback can be carried out in the forward direction only.

Skip to the beginning of the selection

DVD VIDEO DVD AUDIO VCD SVCD CD MP3 WMA JPEG

Press ◀◀ or ▶▶ during playback*.

- Press ▶▶ to skip the next chapter or track.
- Press ◀◀ once to skip back to the beginning of the chapter or track currently being played (except for JPEG).
- Press GROUP/TITLE ◀◀ or ▶▶ to select the title or group.
- During playback of a JPEG disc, press ▶▶ or cursor ▼ to play the next file, or press ◀◀ or cursor ▲ to play the previous file.

NOTE

- * For a VCD or SVCD, this operation can be carried out during playback without the PBC function.
- Except for a DVD VIDEO, this operation can also be carried out while the disc is stopped.
- This operation may not be carried out for some discs.

How to use the number buttons

Ex.:

5: 5
20: +10 → -10
15: +10 → 5
25: +10 → +10 → 5

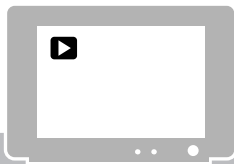

Guide icons displayed on the TV screen (On-screen guide)



: Play



: Pause



: Fast reverse/Fast forward search



: Slow Motion Playback (reverse/forward directions)



: Containing multi-angle views (page 24)



: Containing multi-audio languages (page 24)



: Containing multi-subtitle languages (page 24)



: The disc cannot accept the operation you have attempted.

To change the brightness of the display window (DIMMER)

Press DIMMER repeatedly.

- Each time you press the button, the dimmer mode changes as follows:

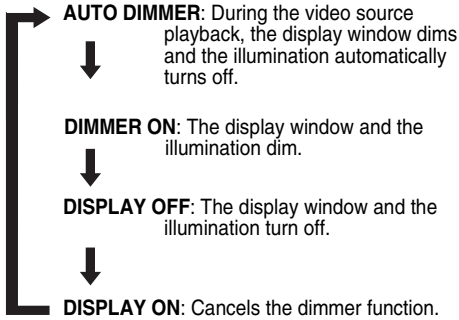

- When the unit is turned off, pressing **DISPLAY** turns off the clock indication to save the power consumption.
- The items above can be carried out for all sources.

Adjusting the volume

Press **AUDIO VOL +/-**.

NOTE

The volume can be also adjusted by turning the **VOLUME** control on the main unit.

Adjusting sound quality

Bass: Press **BASS +/-**.

Treble: Press **TREBLE +/-**.

- Adjustable range: -5 to +5

Turning off the sound temporarily (MUTING)

Press **MUTING**.

- No sound will come out from the speakers, headphones and the subwoofer.
- Press **MUTING** again to restore the sound. When the power is turned off once and turned on again, the sound will be restored.

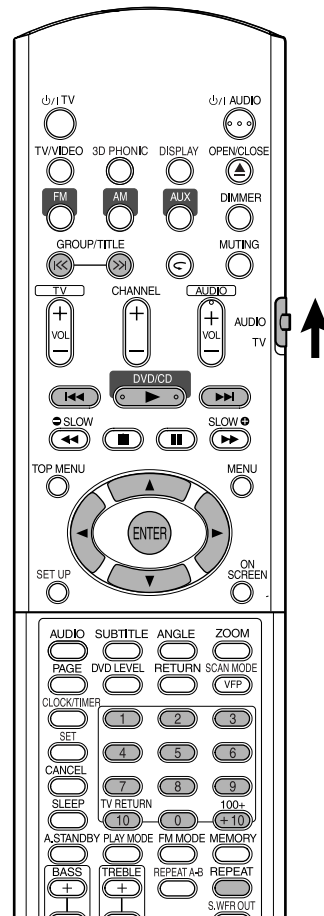

NOTE

Set the remote control mode selector to **AUDIO** before using the number buttons.



Playback

MP3 WMA JPEG

Display of an MP3/WMA disc is described here as an example.
For a JPEG disc, read "track" as "file".

NOTE

When playing a disc containing both MP3/WMA and JPEG files, set one of them to be played, then turn on the system again (page 29).

1 Load a disc.

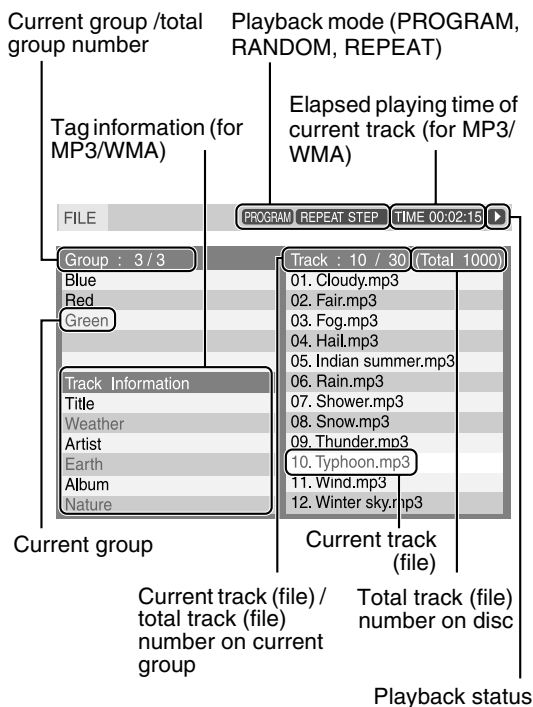

2 Press cursor ▲/▼ to select a group.

3 Press cursor ► to move to the track list.

- Press cursor ◀ to go back to the group list.

4 Press cursor ▲/▼ to select a track.

5 Press DVD/CD ► or ENTER.

NOTE

- **GROUP/TITLE** ◀◀, ▶▶ can also be used in Step 2.
- The number buttons can also be used in Step 4. In this case, Step 5 is not needed. (For how to use the number buttons, refer to page 15.)
- ◀◀ or ▶▶ can also be used in Step 4. In this case, Step 5 is not needed.

Repeat playback

MP3 WMA JPEG

1 Press REPEAT.

- Each time you press the button, the Repeat mode and its indication change as follows:

Repeat items	On the TV	On the display window
Current track (MP3/WMA only)	REPEAT TRACK	REP TRK ↺ 1
Current group	REPEAT GROUP	REP GRP ↺
Entire disc	REPEAT ALL	REP ALL ALL ↺
Cancel	No indication	REP OFF
Current track during Program/Random play (MP3/WMA only)	REPEAT STEP	REP STEP ↺ 1
All tracks during Program/Random play (MP3/WMA only)	REPEAT ALL	REP ALL ALL ↺

2 Press DVD/CD ►.

NOTE

- The Repeat types can be changed during playback.
- The Repeat mode will be automatically canceled if there is a file that cannot be played (page 3).

Slide-Show Playback **JPEG**

- In Step 5, for a JPEG disc, when **DVD/CD ►** is pressed, files will be continuously played from the selected file (Slide-Show Playback), and when **ENTER** is pressed, only a selected file will be played.
- Display time for a file in Slide-Show Playback is about 3 seconds.
- When all files are played through, the playback will be automatically stopped.

Resume Playback

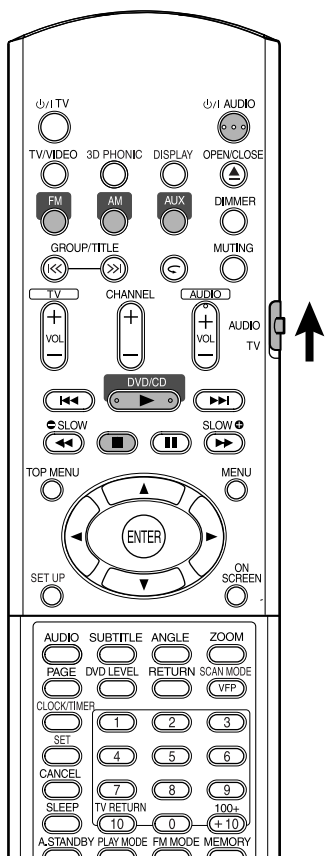

NOTE
Set the remote control mode selector to **AUDIO** before using the number buttons.



This system can store the stop point, and when you start playback again by pressing DVD/CD ► (even while on standby), it starts from the position where you have stopped—Resume Play. The RESUME indicator lights on the display window when you stop playback.

How to suspend playback

Perform any of the following operations during playback.

Press ■ once.*
Press �/I AUDIO to turn off the power.
Change the source to FM, AM or AUX.*

* Even if the power is turned off by pressing  /I AUDIO after this, the position where playback has been stopped will be stored.



To start playback from the stored position

Press DVD/CD ►.

NOTE

- This function does not work in Program Playback or Random Playback.
- The position where playback starts again may be a little different from the stopped position.
- When a disc menu is displayed, the Resume function may not work.
- The audio language, the subtitle language and the angle at that time are stored as well as the stopped position.
- The stored position will be cleared if the disc tray is opened. Further, if ■ is pressed during playback, "RESUME" will be displayed. If ■ is pressed again, the stored information will be cleared.
- At the time of purchase, Resume is set to ON. Resume can be set to OFF (page 30).

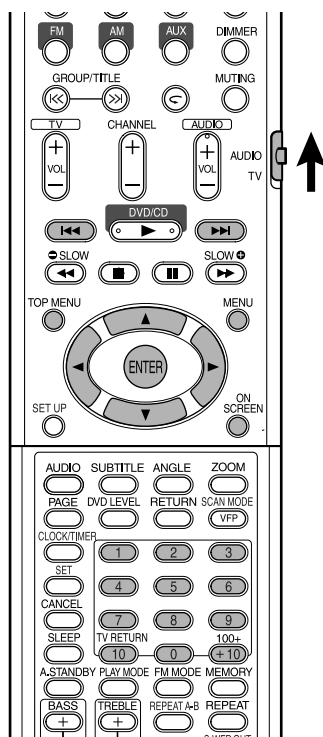

NOTE

Set the remote control mode selector to **AUDIO** before using the number buttons.



Select the scene from the menu

DVD VIDEO **DVD AUDIO** **VCD** **SVCD**

1 Press MENU or TOP MENU while the disc is stopped or during playback*¹.

- The disc menu screen will be displayed.
- Only **TOP MENU** can be used for DVD AUDIOS.

2 Press cursor ▲/▼/◀/▶ (only for a DVD VIDEO or DVD AUDIO) or the number buttons to select the scene to be played.

- Refer to "How to use the number buttons" (page 15).
- When the menu screen has a couple of pages, press ◀◀ or ▶▶ to change the page (only for a VCD and SVCD).

3 Press ENTER.

NOTE

*¹ For a VCD and SVCD, this operation can be carried out only when the PBC function is off.

- This operation cannot be carried out for a disc without a menu screen.
- Playback may start for some discs without pressing ENTER.

Designate the time (Time search)

DVD VIDEO **DVD AUDIO** **VCD** **SVCD** **C D**

1 Press ON SCREEN twice during playback*².

The menu bar will be displayed (page 28).

2 Press cursor ◀/▶ to select



3 Press ENTER.

4 Input the time*³ using the number buttons (1-9, 0).

Ex.: When you want to play a DVD VIDEO from the position of (0 hour) 23 minutes 45 seconds, press the buttons in the order:

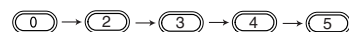

- If you input wrong numbers, press cursor ◀ to delete the numbers and re-input.

5 Press ENTER.

To delete the menu bar, press **ON SCREEN**.

NOTE

- This function does not work for a DVD VIDEO with no time information recorded.
- This function does not work during Program or Random Playback.

*² For a VCD and an SVCD, the operation can be carried out when the disc is stopped or during playback without the PBC function.

*³ Time search for a DVD VIDEO is from the beginning of the title, for a DVD AUDIO from the beginning of the track being played. Time search for a VCD, an SVCD and a CD is as follows:

- When the disc is stopped, time search is from the beginning of the disc.
- When the disc is being played, time search is within the track currently being played.

Program Playback/Random Playback

DVD VIDEO DVD AUDIO VCD SVCD C D MP3 WMA

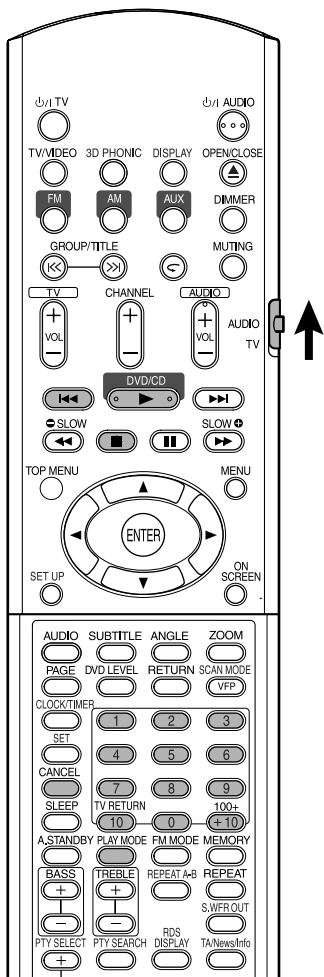

NOTE

Set the remote control mode selector to **AUDIO** before using the number buttons.



Play the disc in the desired order (Program Playback)

It is possible to program a maximum of 99 chapters or tracks. The same chapter or track can be programmed more than once.

- 1 While the disc is stopped, press **PLAY MODE** repeatedly to display “PROGRAM” on the display window on the main unit.

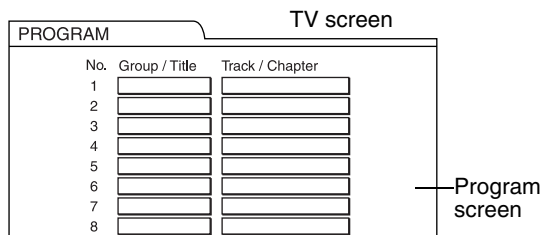

- 2 Create a program following the description on the TV screen.

Refer to “How to use the number buttons” (page 15).

- The input content varies depending on the disc type.
 - DVD VIDEO: Titles and chapters
 - VCD, SVCD, CD: Tracks
 - DVD AUDIO, MP3/WMA: Groups and tracks
- To select a DVD AUDIO bonus group, carry out the operations of “Playing the Bonus Group” on page 27 in advance to erase the display “BONUS”.
- If the input number of chapters or tracks is greater than 99, “MEM FULL” will be displayed.
- In the case of a VCD, SVCD or CD, when the total playback time reaches 9 hours 59 minutes 59 seconds, “--:--” will be displayed on the display window (it is possible to continue programming).

To program on the display window on the main unit, operate as follows:

- (1) Select a title/group using the number buttons.
- (2) Designate a chapter/track number using the number buttons.
 - Refer to “How to use the number buttons” (page 15).
 - The program number will be displayed on the lower display window (Ex.: “P2”).
- (3) Repeat the above operations (1) and (2) to complete the program. Then, advance to Step **3**.

NOTE

- The group/title number flashes on the display window after making each program step.
- Only for a DVD VIDEO, DVD AUDIO, VCD, or an MP3/WMA: If you press **ENTER** instead of designating a track/chapter number, “ALL” is displayed and all of the tracks/chapters in the selected group/title are programmed.

3 Press DVD/CD ►.

- To resume normal playback, press **PLAY MODE** repeatedly to show the playback indication on the display window on the main unit while the disc is stopped. The program content will not be erased.
- The following operations erase the program content:
 - Press **CANCEL** repeatedly (Programs will be erased one by one)
 - Press **■** while the disc is stopped
 - Open the disc tray
 - Turn off the power

Playing the disc in a random order (Random Playback)

1 Press PLAY MODE repeatedly to display “RANDOM” on the display window on the main unit while the disc is stopped.

- “RANDOM” will also be displayed on the TV screen.

2 Press DVD/CD ►.

- The same chapter or track will not be played twice.
- To resume normal playback, press **PLAY MODE** repeatedly to show the playback indication on the display window on the main unit while the disc is stopped.
- Random Playback will also be canceled by carrying out the following operations:
 - Open the disc tray
 - Turn off the power
- The previous track will not be returned to even if **◀◀** is pressed repeatedly during Random Playback (the beginning of the current chapter or track will be returned to).

Repeat Playback

Refer to page 17 for Repeat Playback of MP3 and JPEG files.

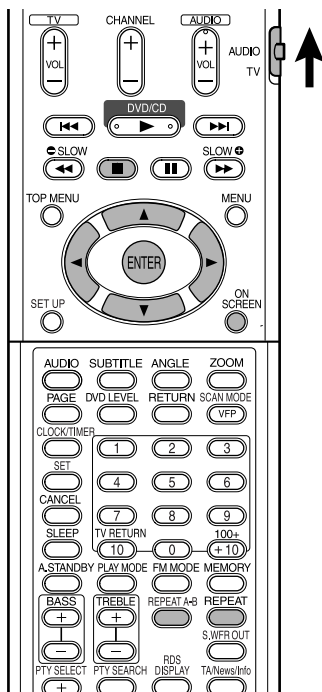

Playing the title/chapter/group/track/all tracks repeatedly (REPEAT)

DVD VIDEO DVD AUDIO VCD SVCD CD

Press REPEAT during playback.

- Each time you press the button, the Repeat mode and its indication change as follows:

For DVD VIDEO

Repeat items	On the TV	On the display window
Current chapter	CHAP	REP CHAP ↺ 1
Current title	TITLE	REP TTL ↺
Cancel	OFF	REP OFF

For DVD AUDIO

Repeat items	On the TV	On the display window
Current track	TRACK	REP TRK ↺ 1
Current group	GROUP	REP GRP ↺
Cancel	OFF	REP OFF

For CD/VCD/SVCD

Repeat items	On the TV	On the display window
Current track	TRACK	REP TRK ↺ 1
All tracks	ALL	REP ALL ALL ↺
Cancel	OFF	REP OFF

NOTE

- For a VCD and SVCD, the operation can be carried out only when the disc is stopped or during playback without the PBC function.
- It is possible to set Repeat mode on the menu bar. For how to operate, refer to "Playing the designated part repeatedly (A-B Repeat Playback)" (page 23).
- For a DVD VIDEO and DVD AUDIO, if the source is switched to FM, AM, or AUX, the Repeat mode will be canceled.

Repeat Playback during Program or Random Playback

Repeat items	On the TV	On the display window
Current chapter/track	STEP or REPEAT STEP	REP STEP ↺ 1
All tracks during Program/Random play	ALL or REPEAT ALL	REP ALL ALL ↺
Cancel	OFF or no indication	REP OFF

Playing the designated part repeatedly (A-B Repeat Playback)

DVD VIDEO DVD AUDIO VCD SVCD CD

1 Press ON SCREEN twice during playback.

The menu bar (page 28) will be displayed.

2 Press cursor ◀/▶ to select

 OFF.

3 Press ENTER.

4 Press cursor ▲/▼ to display

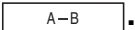

.

Other Repeat modes can be selected here. For other Repeat modes, refer to “Playing the title/chapter/group/track/all tracks repeatedly (REPEAT)” (page 22).

5 Press ENTER at the start point of the part to be repeated (designating A point).

- The icon on the menu bar will be .

6 Press ENTER at the end point of the part to be repeated (designating B point).

- The icon on the menu bar will be  and the part between A and B points will be played repeatedly.
- A-B Repeat Playback will be canceled by carrying out the following operations:
 - Press ■.
 - Select  and press **ENTER** twice.

NOTE

- A-B Repeat Playback is possible only within the same title or track. A-B Repeat Playback cannot be carried out during PBC playback, Program Playback, Random Playback and Repeat Playback.
- You can do the A-B Repeat Playback using the **REPEAT A-B** button on the remote control.

Other convenient functions

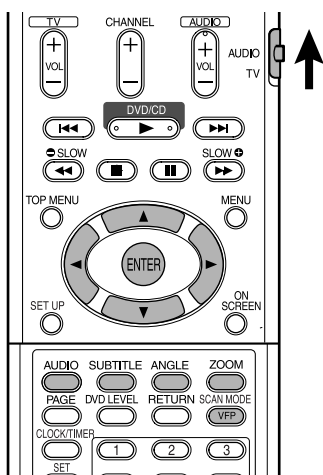

Selecting the audio language

DVD VIDEO DVD AUDIO VCD SVCD

- 1 Press **AUDIO** during playback of a disc containing several audio languages.

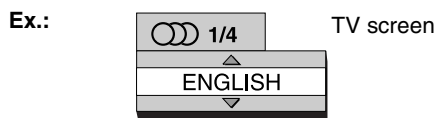

- Each time you press the button, the audio language will be alternated. Also, the audio language can be changed by pressing cursor **▲/▼**.
- For a language code such as "AA", refer to "Language codes" (page 42).
- "ST", "L" and "R" displayed when playing a VCD or SVCD respectively represent "Stereo", "Left sound" and "Right sound".

- 2 Wait for a few seconds or press **ENTER** to go off the window.

NOTE

It is also possible to operate by using the menu bar (page 28).

Selecting the subtitles

DVD VIDEO SVCD DVD AUDIO

(only for moving image)

- 1 Press **SUBTITLE** during playback of a disc containing subtitles in several languages.

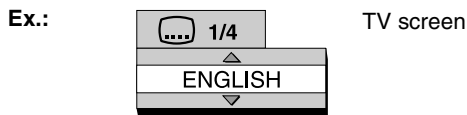

- Each time you press the button, the subtitle will be alternated between ON and OFF.

- 2 Press cursor **▲/▼** to select a subtitle language.

- For a language code such as "AA", refer to "Language codes" (page 42).
- The manner of displaying subtitle languages may be different depending on the disc.

- 3 Wait for a few seconds or press **ENTER** to go off the window.

NOTE

- It is also possible to operate by using the menu bar (page 28).
- For an SVCD, each time you press **SUBTITLE** in Step 1, the subtitle type and OFF will be alternated.

Selecting a view angle

DVD VIDEO DVD AUDIO

(only for moving image)

- 1 Press **ANGLE** during playback of a scene containing multi-view angles.

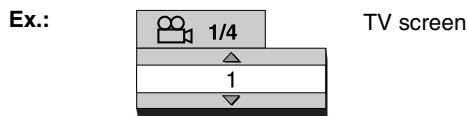

- Each time you press the button, the angle will be alternated. Also, the angle can be changed by pressing cursor **▲/▼**.

- 2 Wait for a few seconds or press **ENTER** to go off the window.

NOTE

It is also possible to operate by using the menu bar (page 28).

Enlarging the picture (ZOOM)

DVD VIDEO VCD SVCD DVD AUDIO JPEG

(only for moving image)

1 Press ZOOM during playback or while paused.

- Each time you press the button, the picture magnification will be changed.
- (For a JPEG) You cannot change the picture magnification during slide-show playback.

2 Select the portion you want to see by using cursor ▲/▼/◀/▶.

- To resume normal playback, select "ZOOM OFF" in Step 1.

Adjusting the picture quality (VFP)

DVD VIDEO DVD AUDIO VCD SVCD JPEG

1 Press VFP during playback or while paused.

The current setting will be displayed on the TV screen.

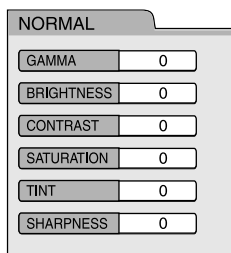

- **GAMMA:** Adjust this if the neutral color is bright or dark. The brightness of dark and bright portion is maintained.
- **BRIGHTNESS:** Adjust this if the picture is bright or dark on the whole.
- **CONTRAST:** Adjust this if the far and near position is unnatural.
- **SATURATION:** Adjust this if the picture is whitish or blackish.
- **TINT:** Adjust this if the appearance of flesh tone is unnatural.
- **SHARPNESS:** Adjust this if the picture is indistinct.

2 Press cursor ◀/▶ to select VFP mode.

- It is recommended to select "NORMAL" usually, or "CINEMA" in a dark room. When either "NORMAL" or "CINEMA" is selected, go to Step 7.
- When either "USER 1" or "USER 2" is selected, the adjustment can be carried out in detail in the operations after Step 3.

3 Press cursor ▲/▼ to select an item to be adjusted.

4 Press ENTER.

Ex.: TV screen



5 Press cursor ▲/▼ to change the value.

6 Press ENTER.

To adjust other items, go back to Step 3.

7 Press VFP to go off the window.

NOTE

- If no operation is made for several seconds during the procedure, the settings made so far will be automatically stored.
- "VFP" is an abbreviation of "Video Fine Processor".

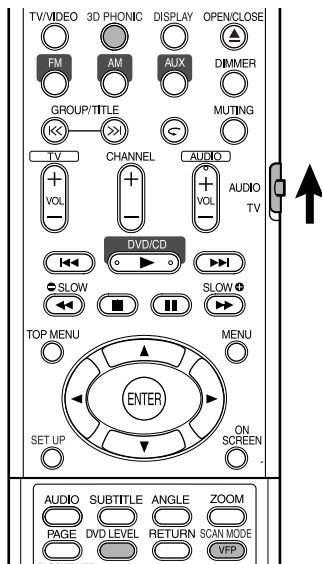

Adjusting playback level (DVD LEVEL)

DVD VIDEO

The audio of a DVD VIDEO may be recorded at a lower level (volume) than for other types of disc. If the difference is not to your liking, adjust the DVD Level.

1 Press DVD LEVEL during playback.

- Each time you press the button, the level will be alternated among "NORMAL", "MIDDLE" and "HIGH".
- Select the level while listening to the sound played.

NOTE

- DVD Level is effective only for playback of a DVD VIDEO.
- Even if the DVD Level is changed, the output level from the digital audio output terminal will not be changed.

Creating realistic sound (3D PHONIC)

DVD VIDEO DVD AUDIO VCD SVCD CD MP3 WMA

The two speakers produce an effect resembling surround-sound.

1 Press 3D PHONIC during playback.

Ex.: TV screen

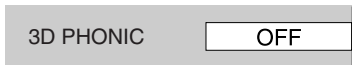

- Each time you press the button, the 3D PHONIC will be alternated as follows:
 - ACTION** : Suitable for action movies, sport programs or other lively programs.
 - DRAMA** : You can relax with a natural atmosphere.
 - THEATER** : You can enjoy the sound effect as if you were watching the movie in a theater.
 - OFF** : Cancels 3D PHONIC (initial setting).
- While 3D PHONIC is activated, "3D PHONIC" appears and the 3D PHONIC indicator lights on the display window.

NOTE

- 3D PHONIC is effective for the speakers and headphones.
- When noise is produced or sound is distorted, set 3D PHONIC to "OFF".
- You cannot operate some DVD AUDIO discs.

Enjoying better pictures (SCAN MODE)

In the Progressive mode, better pictures can be enjoyed.

CAUTION

- In order to enjoy pictures in the Progressive mode, the following requirements should be met:
 - There must be a component video input terminal on the TV set connected to the main unit.
 - The main unit and the TV set must be connected using a component video cord (page 11).

When the above requirements are not satisfied, leave the main unit in the Interlace mode. If the Progressive mode is set, pictures may be distorted.

Press and hold SCAN MODE for 4 seconds when there is no disc loaded or while the disc is stopped.

- Each time you press and hold the button, the scan mode alternates between the "PROGRESSIVE" mode and the "INTERLACE" mode.

NOTE

Progressive mode:

All scanned lines will be displayed at once. Pictures of higher resolution than those in the Interlace mode can be realized.

Interlace mode:

This is a conventional image method. Half of the scanned lines displayed in the Progressive mode will appear, alternating with the other half.

**DVD
AUDIO**

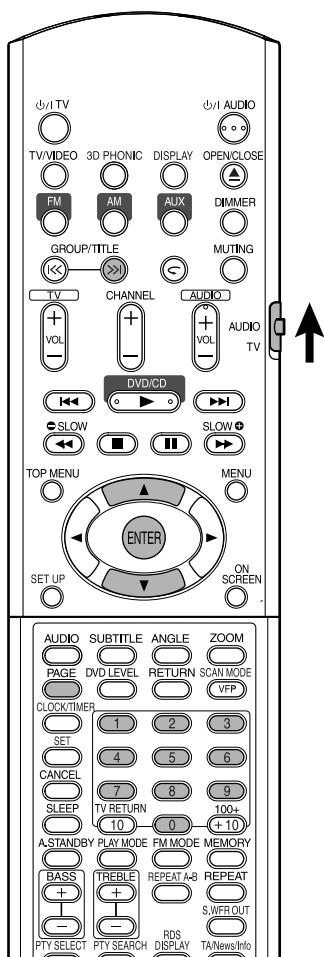

NOTE

Set the remote control mode selector to **AUDIO** before using the number buttons.



Playing the Bonus Group

There are some DVD AUDIO discs with a special group, called "Bonus Group", recorded.

NOTE

This operation can be carried out when "BONUS" is lit on the display window on the main unit.

- 1 Press GROUP/TITLE >> repeatedly during playback to select a bonus group.**

"KEY_ _ _ _" appears on the TV screen, and on the display window on the main unit.

- The bonus group is usually recorded as the last group.

- 2 Press the number buttons to enter a pin code (4 digits).**

The method of getting a pin code may be different depending on the disc.

- 3 Press ENTER.**

- When a correct pin code is entered, "BONUS" disappears and the playback of the bonus group starts.
- If an incorrect pin code is entered, try entering a correct pin code again.

Browsable Still Pictures (B.S.P.)

There are some DVD AUDIO discs with still pictures recorded. Among the still pictures, there are pictures called B.S.P. (Browsable Still Pictures). With these pictures, it is possible to switch a picture as if turning over pages.

NOTE

This operation can be carried out when "B.S.P." is lit on the display window on the main unit.

- 1 Press PAGE during playback.**

Each time you press the button, the still picture will be switched over. It is also possible to switch the picture using cursor ▲/▼.

Ex.: TV screen

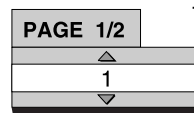

- 2 Wait for a few seconds or press ENTER to go off the window.**

Using the menu bar

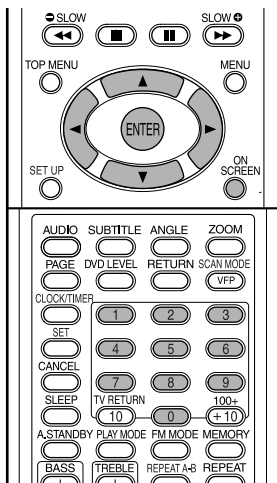

NOTE

- Set the remote control mode selector to **AUDIO** before using the number buttons.
- This operation can be carried out when there is a disc loaded. There are some functions that may not work while the disc is stopped.



1 Press ON SCREEN twice.

The status bar and the menu bar will appear on the TV screen.



The above is an example for a DVD VIDEO.

2 Press cursor </> to select an item to be operated.

3 Press ENTER.

- The selected function can be set. For the setting content, refer to the following "Functions list".
- The currently active function shows.
- To delete the menu bar, press **ON SCREEN**.

Functions list

For the functions with no special description for the operations, press cursor **▲/▼** to select, and press **ENTER** to determine.

<p>TIME</p> <p>Time display selection</p>	<p>Select this to change time information displayed on the display window on the main unit and the status bar. Each time ENTER is pressed, the display will be alternated.</p> <p>DVD VIDEO/DVD AUDIO (operating during playback)</p> <p>TOTAL : Elapsed playing time of current title/group.</p> <p>T.REM : Remaining time of current title/group.</p> <p>TIME : Elapsed playing time of current chapter/track.</p> <p>REM : Remaining time of current chapter/track.</p> <p>CD (operating during playback)/VCD/SVCD</p> <p>TIME : Elapsed playing time of current track.</p> <p>REM : Remaining time of current track.</p> <p>TOTAL: Elapsed playing time of disc.</p> <p>T.REM: Remaining time of disc.</p>
<p>Repeat mode</p>	<p>See page 22.</p>
<p>Time search</p>	<p>See page 19.</p>
<p>CHAP / TRACK</p> <p>Chapter search (DVD VIDEO)/Track search (DVD AUDIO)</p>	<p>Select a chapter/track. Press the number buttons to input the chapter/track number and press ENTER.</p> <p>Ex.:</p> <p>5: (5) 24: (2) → (4)</p>
<p>Audio language/ Audio (DVD VIDEO/DVD AUDIO/VCD/SVCD)</p>	<p>See page 24.</p>
<p>Subtitle language (DVD VIDEO/SVCD)</p>	<p>See page 24.</p>
<p>View angle (DVD VIDEO/DVD AUDIO)</p>	<p>See page 24.</p>
<p>PAGE</p> <p>Page switch (DVD AUDIO)</p>	<p>Switch the still pictures (B.S.P) recorded on a DVD AUDIO disc (page 27).</p>

Information displayed on the status bar

DVD VIDEO/DVD AUDIO (the example below is for a DVD VIDEO)

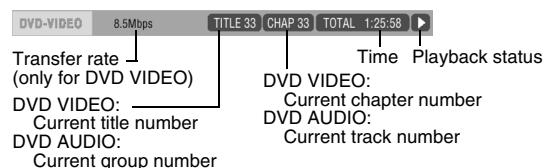

VCD/SVCD/CD (the example below is for a CD)

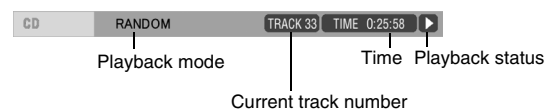

NOTE

The playback status mark has the same meaning of the mark on the On-screen guide (page 15).

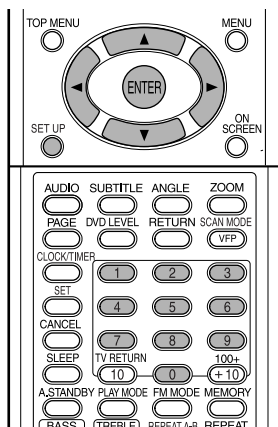

The initial settings of the system can be changed according to the environment the system is used in.

NOTE

- Set the remote control mode selector to **AUDIO** before using the number buttons.
- The top and bottom of the preference screen may not be displayed on a wide TV. Adjust the picture size on the TV.



Basic operations

Press **SET UP** while the disc is stopped or no disc is loaded (“**NO DISC**” is displayed).

- The following screen will be displayed on the TV.

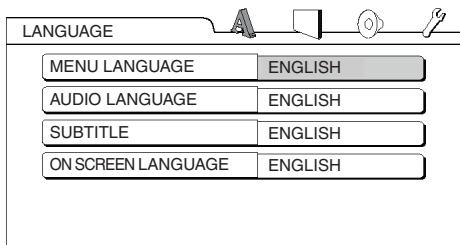

- Proceed with operations by following the description on the TV screen.



LANGUAGE

NOTE



- If the selected language is not recorded on the disc, the optimum language set for the disc will be displayed.

- For a language code such as “AA”, refer to the “Language codes” (page 42).

Items	Contents
MENU LANGUAGE	Select the language for the DVD VIDEO menu.
AUDIO LANGUAGE	Select the audio language for the DVD VIDEO.
SUBTITLE	Select the subtitle language for the DVD VIDEO.
ON SCREEN LANGUAGE	Select the language displayed on the preference screens.



PICTURE

Items	Contents (: initial setting)
MONITOR TYPE	<p>Select a display method suitable for your TV.</p> <p>16 : 9 : Select this when the aspect ratio of your wide TV is fixed to 16:9 (when playing a DVD VIDEO recorded at 4:3, the system automatically adjusts the screen width of the output signal).</p>  <p>4 : 3 LB (Letter Box) : Select this when the aspect ratio of your TV is conventional 4:3. While viewing a wide screen picture, the black bars appear on the top and bottom of the screen.</p>  <p>4 : 3 PS (Pan Scan): Select this when the aspect ratio of your TV is conventional 4:3. While viewing a wide screen picture, the left and right edges of the picture will not be shown on the screen. (If the disc is not compatible with Pan Scan, the picture will be displayed at the Letter Box ratio.)</p> 
PICTURE SOURCE	<p>Select an item suitable to the video source.</p> <p>AUTO: The video source type (a video or film) is automatically selected.</p> <p>FILM: Select this item when you want to view a film or video recorded with the progressive scan method.</p> <p>VIDEO: Select this item when you want to view a normal video.</p>
SCREEN SAVER	<p>Select the Screen Saver mode between ON / OFF (Screen Saver activates when there is no operation made for about 5 minutes since a still picture was last displayed).</p>
FILE TYPE	<p>If there are both MP3/WMA and JPEG files on a disc, you can select which files to play.</p> <p>AUDIO : Select this item when you want to play back MP3/WMA files.</p> <p>STILL PICTURE: Select this item when you want to play back JPEG files.</p>



AUDIO

Items	Contents (<input type="checkbox"/> : initial setting)
DIGITAL AUDIO OUTPUT	<p>Select an output signal type from the following in accordance with the device connected to the digital audio output terminal (AV amplifier, etc.). (See the list below for the preference items and output signal.)</p> <p>PCM ONLY: Device corresponding only to linear PCM.</p> <p>DOLBY DIGITAL/PCM: Dolby digital decoder or a device having the same function.</p> <p>STREAM/PCM : DTS/Dolby digital decoder or a device having the same function.</p>
DOWN MIX	<p>Switch signal from the digital output terminal of the DVD VIDEO according to the connected device. Select this when Digital Audio Output is set to "PCM ONLY".</p> <p>DOLBY SURROUND: A Dolby Pro Logic decoder-built-in device.</p> <p>STEREO : An ordinary device.</p> <ul style="list-style-type: none"> When 3D PHONIC is activated, Down Mix does not work.
D (Dynamic) RANGE COMPRESSION	<p>To make adjustments for the difference between a high volume and a low volume when playing back with low volume (only for a DVD recorded with Dolby digital).</p> <p>AUTO : D. Range Compression automatically works.</p> <p>ON: D. Range Compression always works.</p>



OTHERS

Items	Contents (<input type="checkbox"/> : initial setting)
RESUME	Select ON /OFF. (page 18)
ON SCREEN GUIDE	Select ON /OFF. (page 15)
PARENTAL LOCK	<p>Set the Parental Lock function to cut off violent scenes or replace the scenes with others. (This is effective only for discs equipped with the Parental Lock function.)</p> <p>COUNTRY CODE (page 31): Select your country.</p> <p>SET LEVEL: The restriction is stricter as the number becomes smaller. "NONE" is no restriction.</p> <p>PASSWORD (essential): Enter four-digit number as your password using the number buttons (1-9, 0) every time. (Enter "8888" if you forget your password.) The password is required at the time of playback.</p> <ul style="list-style-type: none"> If you enter a wrong password three times, "EXIT" will be automatically selected.

List of relationships of DIGITAL AUDIO OUTPUT preference items and output signal

Playback disc	DIGITAL AUDIO OUTPUT		
	STREAM/PCM	DOLBY DIGITAL/PCM	PCM ONLY
48 kHz, 16/20/24 bits Linear PCM DVD VIDEO 96 kHz linear PCM DVD VIDEO	48 kHz, 16 bits stereo linear PCM		
48/96/192 kHz, 16/20/24 bits linear PCM DVD AUDIO	48 kHz, 16 bits stereo linear PCM		
44.1/88.2/176.4 kHz, 16/20/24 bits linear PCM DVD AUDIO	44.1 kHz, 16 bits stereo linear PCM		
DTS DVD VIDEO	DTS bit stream	48 kHz, 16 bits stereo linear PCM	
DOLBY DIGITAL DVD VIDEO/ DVD AUDIO	DOLBY DIGITAL bit stream		48 kHz, 16 bits stereo linear PCM
CD/VCD/SVCD	44.1 kHz, 16 bits stereo linear PCM/48kHz, 16 bits linear PCM		
DTS CD	DTS bit stream	44.1 kHz, 16 bits linear PCM	
MP3/WMA disc	32/44.1/48 kHz, 16 bits stereo linear PCM		

NOTE

- For a DVD VIDEO: There is a 20 bit or 24 bit output for DVD VIDEO without content protection set.
- For a DVD AUDIO: There is no output for DVD AUDIO with content protection set.

AD	Andorra
AE	United Arab Emirates
AF	Afghanistan
AG	Antigua and Barbuda
AI	Anguilla
AL	Albania
AM	Armenia
AN	Netherlands Antilles
AO	Angola
AQ	Antarctica
AR	Argentina
AS	American Samoa
AT	Austria
AU	Australia
AW	Aruba
AZ	Azerbaijan
BA	Bosnia and Herzegovina
BB	Barbados
BD	Bangladesh
BE	Belgium
BF	Burkina Faso
BG	Bulgaria
BH	Bahrain
BI	Burundi
BJ	Benin
BM	Bermuda
BN	Brunei Darussalam
BO	Bolivia
BR	Brazil
BS	Bahamas
BT	Bhutan
BV	Bouvet Island
BW	Botswana
BY	Belarus
BZ	Belize
CA	Canada
CC	Cocos (Keeling) Islands
CF	Central African Republic
CG	Congo
CH	Switzerland
CI	Côte d'Ivoire
CK	Cook Islands
CL	Chile
CM	Cameroon
CN	China
CO	Colombia
CR	Costa Rica
CU	Cuba
CV	Cape Verde
CX	Christmas Island
CY	Cyprus
CZ	Czech Republic
DE	Germany
DJ	Djibouti
DK	Denmark
DM	Dominica
DO	Dominican Republic
DZ	Algeria
EC	Ecuador
EE	Estonia
EG	Egypt
EH	Western Sahara
ER	Eritrea

ES	Spain
ET	Ethiopia
FI	Finland
FJ	Fiji
FK	Falkland Islands (Malvinas)
FM	Micronesia (Federated States of)
FO	Faroe Islands
FR	France
FX	France, Metropolitan
GA	Gabon
GB	United Kingdom
GD	Grenada
GE	Georgia
GF	French Guiana
GH	Ghana
GI	Gibraltar
GL	Greenland
GM	Gambia
GN	Guinea
GP	Guadeloupe
GQ	Equatorial Guinea
GR	Greece
GS	South Georgia and the South Sandwich Islands
GT	Guatemala
GU	Guam
GW	Guinea-Bissau
GY	Guyana
HK	Hong Kong
HM	Heard Island and McDonald Islands
HN	Honduras
HR	Croatia
HT	Haiti
HU	Hungary
ID	Indonesia
IE	Ireland
IL	Israel
IN	India
IO	British Indian Ocean Territory
IQ	Iraq
IR	Iran (Islamic Republic of)
IS	Iceland
IT	Italy
JM	Jamaica
JO	Jordan
JP	Japan
KE	Kenya
KG	Kyrgyzstan
KH	Cambodia
KI	Kiribati
KM	Comoros
KN	Saint Kitts and Nevis
KP	Korea, Democratic People's Republic of
KR	Korea, Republic of
KW	Kuwait
KY	Cayman Islands
KZ	Kazakhstan
LA	Lao People's Democratic Republic
LB	Lebanon

LC	Saint Lucia
LI	Liechtenstein
LK	Sri Lanka
LR	Liberia
LS	Lesotho
LT	Lithuania
LU	Luxembourg
LV	Latvia
LY	Libyan Arab Jamahiriya
MA	Morocco
MC	Monaco
MD	Moldova, Republic of
MG	Madagascar
MH	Marshall Islands
ML	Mali
MM	Myanmar
MN	Mongolia
MO	Macau
MP	Northern Mariana Islands
MQ	Martinique
MR	Mauritania
MS	Montserrat
MT	Malta
MU	Mauritius
MV	Maldives
MW	Malawi
MX	Mexico
MY	Malaysia
MZ	Mozambique
NA	Namibia
NC	New Caledonia
NE	Niger
NF	Norfolk Island
NG	Nigeria
NI	Nicaragua
NL	Netherlands
NO	Norway
NP	Nepal
NR	Nauru
NU	Niue
NZ	New Zealand
OM	Oman
PA	Panama
PE	Peru
PF	French Polynesia
PG	Papua New Guinea
PH	Philippines
PK	Pakistan
PL	Poland
PM	Saint Pierre and Miquelon
PN	Pitcairn
PR	Puerto Rico
PT	Portugal
PW	Palau
PY	Paraguay
QA	Qatar
RE	Réunion
RO	Romania
RU	Russian Federation
RW	Rwanda
SA	Saudi Arabia
SB	Solomon Islands
SC	Seychelles

SD	Sudan
SE	Sweden
SG	Singapore
SH	Saint Helena
SI	Slovenia
SJ	Svalbard and Jan Mayen
SK	Slovakia
SL	Sierra Leone
SM	San Marino
SN	Senegal
SO	Somalia
SR	Suriname
ST	Sao Tome and Principe
SV	El Salvador
SY	Syrian Arab Republic
SZ	Swaziland
TC	Turks and Caicos Islands
TD	Chad
TF	French Southern Territories
TG	Togo
TH	Thailand
TJ	Tajikistan
TK	Tokelau
TM	Turkmenistan
TN	Tunisia
TO	Tonga
TP	East Timor
TR	Turkey
TT	Trinidad and Tobago
TV	Tuvalu
TW	Taiwan
TZ	Tanzania, United Republic of
UA	Ukraine
UG	Uganda
UM	United States Minor Outlying Islands
US	United States
UY	Uruguay
UZ	Uzbekistan
VA	Vatican City State (Holy See)
VC	Saint Vincent and the Grenadines
VE	Venezuela
VG	Virgin Islands (British)
VI	Virgin Islands (U.S.)
VN	Viet Nam
VU	Vanuatu
WF	Wallis and Futuna Islands
WS	Samoa
YE	Yemen
YT	Mayotte
YU	Yugoslavia
ZA	South Africa
ZM	Zambia
ZR	Zaire
ZW	Zimbabwe

Listening to a radio broadcast

Selecting a station

- 1 Press FM or AM.
- 2 Press **◀◀/▶▶** to select the station (frequency).

Automatic tuning:

Hold down **◀◀/▶▶** until the system starts searching, and then release the button. (The AUTO indicator lights while searching.) When a station of sufficient signal strength is tuned in to, the system stops searching automatically. To stop searching manually, press **◀◀/▶▶**.

Manual tuning:

Each time you press **◀◀/▶▶**, the frequency changes.

- When an FM stereo program is received, the ST (Stereo) indicator lights.

NOTE

*If the stereo FM program currently tuned in to is noisy, you can improve the reception by pressing **FM MODE** to switch to the monaural mode. If you press **FM MODE** again, or tune in to another station, the receiving mode returns automatically to the stereo mode.*

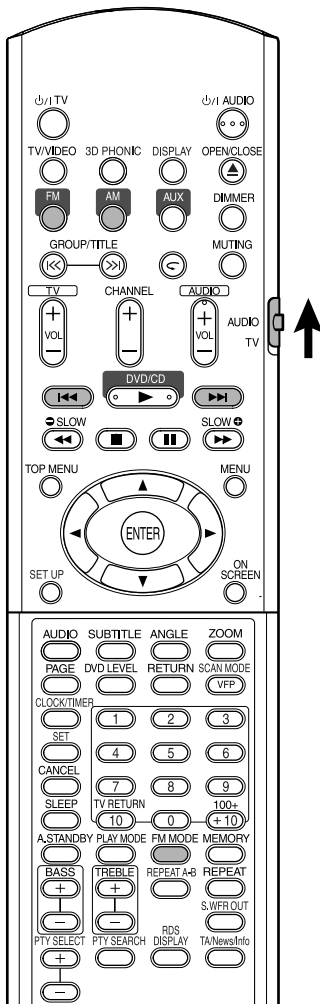

NOTE

Set the remote control mode selector to **AUDIO** before using the number buttons.



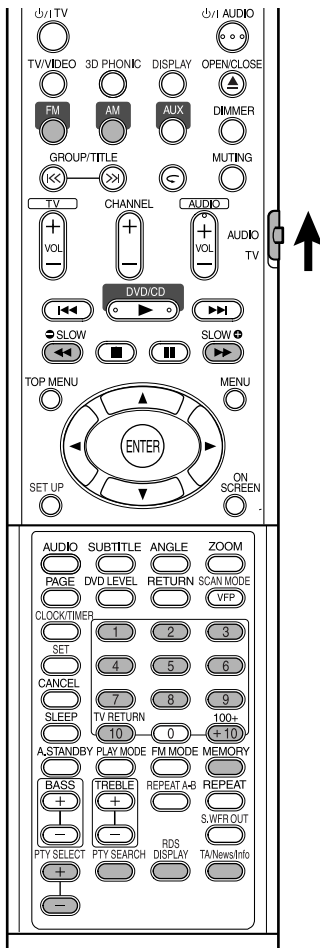

Presetting stations in the system allows you to easily tune in to a station.

NOTE

Set the remote control mode selector to **AUDIO** before using the number buttons.



Presetting stations

The system stores up to 30 FM stations and up to 15 AM (MW) stations.

1 Select a station you want to store (page 32 for how to select).

2 Press **MEMORY**.

“MEMORY” is flashing on the display window for a while.

3 Select the number you want to store by pressing number buttons while “MEMORY” is flashing.

- You can also select the number by using the number buttons.
- Refer to “How to use the number buttons” (page 15).

4 Press **MEMORY** while the selected number is flashing.

“STORED” appears on the display window and the selected station is stored.

NOTE

- Storing a new station to a used number erases the previously stored station.
- After storing new stations, do not unplug the AC power cord to turn off the system. If you do so, the new preset stations will be cleared.

Tuning in to a preset station

1 Press **FM** or **AM** to select either FM or AM (MW).

2 Press the number buttons to select the memory number of a station you want to tune in to.

Refer to “How to use the number buttons” (page 15).

You can also select by pressing ◀◀▶▶.

Using the RDS (Radio Data System) when receiving FM stations

RDS allows FM stations to send an additional signal along with their regular program signals. For example, the stations send their station names, as well as information about what type of program they broadcast, such as sports or music, etc.

When tuned in to an FM station which provides the RDS service, the RDS indicator lights up on the display window.

With the system, you can receive the following types of RDS signals:

PS (Program Service)	Shows commonly known station names.
PTY (Program Type)	Shows types of broadcast programs.
RT (Radio Text)	Shows text messages the station sends.
Enhanced Other Network	See page 36.

NOTE

- RDS is not available for AM (MW) broadcasts.
- RDS may not operate correctly if the station tuned is not transmitting RDS signal properly or if the signal strength is weak.

To show the RDS signals information

Press RDS DISPLAY while listening to an FM station.

Each time you press the button, the indication on the display window changes.

PS

While searching, "PS" appears and then the station names will be displayed. "NO PS" appears if no signal is sent.

PTY

While searching, "PTY" appears and then the type of the broadcast program will be displayed. "NO PTY" appears if no signal is sent.

RT

While searching, "RT" appears and then text messages the station sends will be displayed. "NO RT" appears if no signal is sent.

Frequency

Station frequency (non-RDS service).

About characters shown on the display window

When PS, PTY, or RT signals appear on the display window, some special characters and marks may not be displayed correctly.

NOTE

If searching finishes at once, "PS", "PTY", and "RT" will not appear on the display window.

Searching for a program by PTY codes

One of the advantages of the RDS service is that you can locate a particular kind of program from the preset channels (page 33) by specifying the PTY codes.

To search for a program using the PTY codes

NOTE

Before you start operation;

- The PTY Search is only applicable to preset stations.
- To stop searching any time during the process, press **PTY SEARCH** while searching.
- There is a time limit in doing the following steps. If the setting is canceled before you finish, start from step **1** again.

1 Press PTY SEARCH while listening to an FM station.

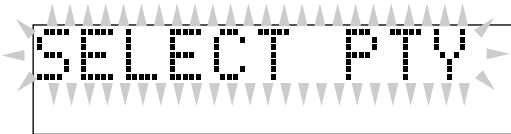

“SELECT PTY” flashes on the display window.

- While “SELECT PTY” is flashing:

2 Press PTY SELECT + or PTY SELECT – until the PTY code you want appears on the display window.

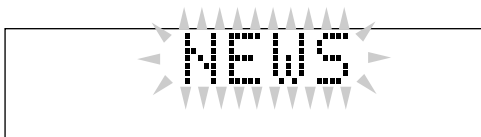

- For details, see “Description of the PTY codes” (page 36).

- While the PTY code selected in Step **2** is still on the display window:

3 Press PTY SEARCH again.

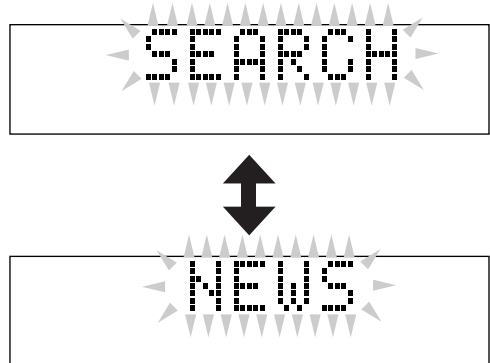

While searching, “SEARCH” and the selected PTY code alternate on the display window.

The system searches 30 preset FM stations, stops when it finds the one you have selected, and tunes in that station.

To continue searching after the first stop

Press **PTY SEARCH** again while the indications on the display window are flashing.

If no program is found, “NOT FOUND” appears on the display window.

Using the RDS (continued)

Description of the PTY codes

NEWS:	News.
AFFAIRS:	Topical program expanding or enlarging upon the news — debate, or analysis.
INFO:	Programs the purpose of which is to impart advice in the widest sense.
SPORT:	Programs concerned with any aspect of sports.
EDUCATE:	Educational programs.
DRAMA:	All radio plays and serials.
CULTURE:	Programs concerning any aspect of national or regional culture, including language, theater, etc.
SCIENCE:	Programs about natural sciences and technology.
VARIED:	Used for mainly speech-based programs such as quizzes, panel games and personality interviews.
POP M:	Commercial music of current popular appeal.
ROCK M:	Rock music.
EASY M:	Current contemporary music considered to be “easy-listening”.
LIGHT M:	Instrumental music, and vocal or choral works.
CLASSICS:	Performances of major orchestral works, symphonies, chamber music, etc.
OTHER M:	Music not fitting into any of the other categories.
WEATHER:	Weather reports and forecasts.
FINANCE:	Stock Market reports, commerce, trading etc.
CHILDREN:	Programs targeted at a young audience.
SOCIAL:	Programs about sociology, history, geography, psychology and society.
RELIGION:	Religious programs.
PHONE IN:	Involving members of the public expressing their views either by phone or at a public forum.
TRAVEL:	Travel information.
LEISURE:	Programs about recreational activities.
JAZZ:	Jazz music.
COUNTRY:	Songs which originate from, or continue the musical tradition of the American Southern States.
NATION M:	Current popular music of the nation or region in that country's language.
OLDIES:	Music from the so-called “golden age” of popular music.

FOLK M:	Music which has its roots in the musical culture of a particular nation.
DOCUMENT:	Programs concerning factual matters, presented in an investigative style.
TEST:	Broadcasts for testing emergency broadcast equipment or unit.
ALARM:	Emergency announcement.
NONE:	No program type, undefined program, or difficult to categorize into particular types.

NOTE

Classification of the PTY codes for some FM stations may be different from the above list.

Switching to broadcast program of your choice temporarily

Another convenient RDS service is called “Enhanced Other Network”.

This allows the system to switch temporarily to a broadcast program of your choice (TA, NEWS, and/or INFO) from a different station except in the following cases;

- When you are listening to non-RDS stations (all AM – MW stations, some FM stations and other sources).
- When the system is in standby mode.

NOTE

Before you start operations;

The Enhanced Other Network function is only applicable to preset stations.

Press TA/News/Info repeatedly until the program type indicator (TA/NEWS/INFO) you want appears on the display window.

Each time you press the button, the indicator on the display window changes.

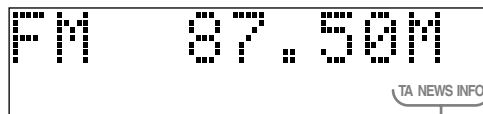

TA/NEWS/
INFO indicators

TA	Traffic Announcement in your area.
NEWS	News.
INFO	Program the purpose of which is to impart advice in the widest sense.

To stop listening to the program selected by Enhanced Other Network

Press **TA/News/Info** repeatedly again so that the program type indicator (TA/NEWS/INFO) goes off from the display window. The system exits from Enhanced Other Network standby mode and goes back to the previously selected station.

How the Enhanced Other Network function actually works

Case 1

If there is no station broadcasting the program you have selected

The system continues tuning in to the current station.

When a station starts broadcasting the program you have selected, the system automatically switches to the station. The indicator of received PTY code starts flashing.

When the program is over, the system goes back to the previously tuned station, but the Enhanced Other Network function still remains activated.

Case 2

If the FM station you are listening to is broadcasting the program you have selected

The system continues to receive the station but the indicator of received PTY code starts flashing.

When the program is over, the indicator of received PTY code stops flashing and remains lit, but the Enhanced Other Network function still remains activated.

NOTE

- In Enhanced Other Network standby mode, if you change the source to play, Enhanced Other Network standby mode is canceled temporarily.
- If you change the source to FM again, the system returns to Enhanced Other Network standby mode.
- Enhanced Other Network data sent from some stations may not be compatible with this system.
- Enhanced Other Network does not function for some FM stations with RDS service.
- While listening to a program tuned in by the Enhanced Other Network function, the station does not change even if another network station starts broadcasting a program of the same Enhanced Other Network data.
- While listening to a program tuned in by the Enhanced Other Network function, you can only use **TA/News/Info** and **RDS DISPLAY** as the tuner operation buttons.

Listening to the sound of other audio device

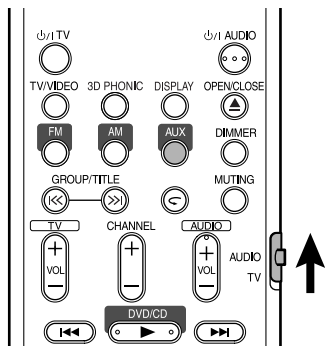

Connect the other audio device to this system in advance (page 10).

1 Press AUX.

The source changes to AUX.

2 Play the other audio device.

For details, refer to the manual of the device connected.

3 Adjust the volume and the sound quality of the system (page 16).

Setting the various timer

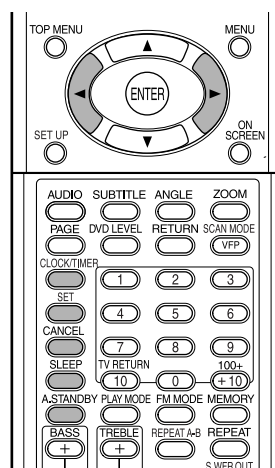

Setting the built-in clock

Without setting the built-in clock, you cannot use any timers.

- To exit from the clock setting, press **CLOCK/TIMER** as required.
- To correct a misentry during the procedure below, pressing **CANCEL** can return to the previous step.

1 Press CLOCK/TIMER.

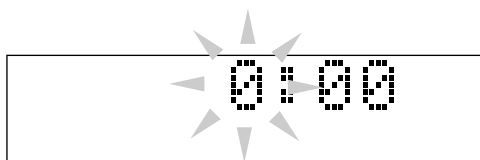

- If you have already adjusted the clock before, press the button repeatedly until the clock time starts flashing.

2 Press cursor **◀/▶** to adjust the hour, then press SET.

3 Press cursor **◀/▶** to adjust the minute, then press SET.

Now the built-in clock starts to work.

Setting the daily timer

Using the daily timer, you can wake up with your favorite song.

- You can store the three daily timer settings; however, you can activate only one of the daily timer.
- To correct a misentry during the procedure below, pressing **CANCEL** can return to the previous step.

How the daily timer works:

Once the daily timer has been set, the timer indicator and timer number indicator (1/2/3) are lit on the display window. Daily timer turns on the system at the same time everyday until the timer setting is canceled manually or another daily timer is activated.

When the on-time comes:

The system turns on, tunes in to the specified station or start playback the loaded disc with the volume level set to the preset level.

- The timer setting remains in memory until you can change it.
- Without canceling the daily timer, you can change the source or adjust the volume after the daily timer starts playback.

1 Press CLOCK/TIMER repeatedly to show “DAILY 1.”

- Each time you press the button, the clock setting changes as follows:

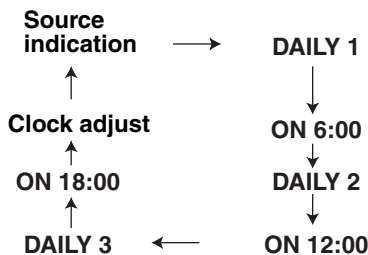

2 Press cursor ◀▶ to adjust the hour of the timer-on time, then press SET.

3 Press cursor ◀▶ to adjust the minute of the timer-on time, then press SET.

4 Repeat Step 2 and 3 to set the timer-off time.

5 Press cursor ◀▶ to select the playback source, then SET.

- Each time you press the button, the clock setting changes as follows:

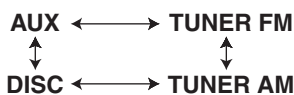

- When selecting the tuner, press cursor ◀▶ to select a preset channel.
- When selecting “DISC”, you can specify the group and track. For the discs other than MP3/WMA, the group selection does not take effect.

6 Press cursor ◀▶ to adjust the volume level, then SET.

7 Turn off the system.

To turn off the timer setting

1 Press CLOCK/TIMER repeatedly to select the timer setting.

2 Press CANCEL to turn off the selected setting.

- Pressing SET activates the timer setting again.

Auto Standby

If there is no operation for 3 minutes while the disc is stopped, the power will be automatically turned off.

Press A.STANDBY during playback or while the disc is stopped, or no disc is loaded (“NO DISC” appears).

The A.STANDBY indicator lights on the display window on the main unit.

When a stopped state is entered (after playback is finished, for example), the A.STANDBY indicator starts blinking.

This means that the power will be turned off automatically if there is no operation for 3 minutes. And 10 seconds before the power is turned off, “A.STANDBY” starts flashing.

Releasing Auto Standby

Press A.STANDBY.

“A.STANDBY” will be turned off on the display window on the main unit.

NOTE

When the source is FM, AM, or AUX, Auto Standby does not work.

Setting the various timer (continued)

Sleep Timer

When the time you specify elapses, the system will be turned off by itself.

Press SLEEP.

Each time you press the button, the time indicated on the display window on the main unit changes (in minutes).

Changing the time

Reselect the time by pressing **SLEEP** repeatedly.

Confirming the time

Press **SLEEP** once while Sleep Timer is set.

Releasing

Press **SLEEP** repeatedly until "SLEEP OFF" appears.

NOTE

Sleep Timer will also be released when the power is turned off.

Tray Lock

You can lock the disc tray to prevent the disc from being ejected.

Setting

While the system is turned off, press ▲ (Open/Close) with ■ (Stop) on the main unit held. "LOCKED" appears on the display window on the main unit.

Releasing

Carry out the same operations as those for setting. "UNLOCKED" appears on the display window on the main unit.

When you encounter a problem that seems to be a fault, check the following points before contacting your JVC service center.

Power source

- **Power does not come on.**
 - The power cord is not connected to the main unit or an AC outlet.
 - Connect the power cord correctly (page 11).

Operation

- **You cannot operate any button.**
 - Some specific operations may be inhibited for some discs.
- **The remote control does not work.**
 - The dry-cell batteries have run out.
 - Replace the batteries (page 6).
- **A disc cannot be played back.**
 - In the case of DVD VIDEO discs
 - Check the Region Code number of the discs (page 3).
 - “NO PLAY” is displayed on the display window.
It is not a disc that can be played on this system.
 - Check the disc type (page 3).
 - Parental Lock is set (page 30).

About images

- **No picture appears.**
 - The video cord is not connected correctly.
 - Page 11
 - Both of the component video jack and S-video jack are connected.
 - Connect either (page 11).
- **The picture is distorted.**
 - A VCR is connected between the main unit and the TV set.
 - Connect the main unit directly to the TV set (page 11).
 - Although this system is connected to a non-Progressive TV set, DVD's scan mode is set to “PROGRESSIVE”.
 - Set the scan mode to “INTERLACE” (page 26).
- **The screen size is abnormal.**
 - The screen size is set improperly.
 - Set “MONITOR TYPE” according to the TV set you are using (page 29).

- **The TV screen darkens.**
 - “SCREEN SAVER” is set.
 - If set, press any button (page 29).
- **The screen cannot be switched.**
 - The Progressive mode is applied only to component video output.

About sound

- **There is no sound.**
 - Speakers are not connected correctly.
 - Page 9
 - The sound is muted.
 - Page 16
 - “NO AUDIO” is displayed on the display window.
The disc may have been produced through illegal copying.
 - Confirm at the store where you bought the disc.
- **The sound is weak compared with TV or Video.**
 - “DVD LEVEL” is set to “NORMAL”.
 - Set to other than “NORMAL” (page 26).
- **The sound is distorted.**
 - The volume is turned up too high.
 - Turn down the volume (page 16).
- **No sound comes out of the subwoofer.**
 - “SUBWOOFER” is turned off.
 - Press **S.WFR OUT** to turn on (page 10).

About radio

- **The sound is noisy while receiving/Receiving is disabled.**
 - The antenna is not connected correctly.
 - Connect the antenna correctly (page 8).

Others

- **It is not possible to switch audio or subtitles between languages.**
 - The disc does not contain 2 or more languages.
 - If only a single language is recorded on the disc, switching to another language is impossible (page 24).
- **No subtitle is displayed.**
 - The disc does not contain any subtitles.
 - A DVD VIDEO without subtitles cannot display any subtitles.
 - The subtitle language is set to “OFF”.
 - Specify a language (page 29).
 - Before or after A point or B point in A-B Repeat Playback, no subtitle may be displayed.
- **The disc cannot be ejected.**
 - Tray Lock is set.
 - page 40
- **“LR ONLY” is displayed on the display window (for a DVD AUDIO).**
 - Because, for the track being played back, down mix is inhibited for multi-channel sound, the sound of L and R is output directly (a normal action).

If the system does not work properly despite correction measures above

Many functions of this system are implemented by microcomputers. If pressing any button does not result in the normal action, disconnect the power plug from the outlet, wait for a while, and reconnect the system.

Language codes

Code	Language	Code	Language
AA	Afar	MK	Macedonian
AB	Abkhazian	ML	Malayalam
AF	Afrikaans	MN	Mongolian
AM	Ameharic	MO	Moldavian
AR	Arabic	MR	Marathi
AS	Assamese	MS	Malay (MAY)
AY	Aymara	MT	Maltese
AZ	Azerbaijani	MY	Burmese
BA	Bashkir	NA	Nauru
BE	Byelorussian	NE	Nepali
BG	Bulgarian	NL	Dutch
BH	Bihari	NO	Norwegian
BI	Bislama	OC	Occitan
BN	Bengali, Bangla	OM	(Afan) Oromo
BO	Tibetan	OR	Oriya
BR	Breton	PA	Panjabi
CA	Catalan	PL	Polish
CO	Corsican	PS	Pashto, Pushto
CS	Czech	PT	Portuguese
CY	Welsh	QU	Quechua
DA	Danish	RM	Rhaeto-Romance
DZ	Bhutani	RN	Kirundi
EL	Greek	RO	Rumanian
EO	Esperanto	RU	Russian
ET	Estonian	RW	Kinyarwanda
EU	Basque	SA	Sanskrit
FA	Persian	SD	Sindhi
FI	Finnish	SG	Sangho
FJ	Fiji	SH	Serbo-Croatian
FO	Faroese	SI	Singhalese
FY	Frisian	SK	Slovak
GA	Irish	SL	Slovenian
GD	Scots Gaelic	SM	Samoan
GL	Galician	SN	Shona
GN	Guarani	SO	Somali
GU	Gujarati	SQ	Albanian
HA	Hausa	SR	Serbian
HI	Hindi	SS	Siswati
HR	Croatian	ST	Sesotho
HU	Hungarian	SU	Sundanese
HY	Armenian	SV	Swedish
IA	Interlingua	SW	Swahili
IE	Interlingue	TA	Tamil
IK	Inupiak	TE	Telugu
IN	Indonesian	TG	Tajik
IS	Icelandic	TH	Thai
IW	Hebrew	TI	Tigrinya
JI	Yiddish	TK	Turkmen
JW	Javanese	TL	Tagalog
KA	Georgian	TN	Setswana
KK	Kazakh	TO	Tonga
KL	Greenlandic	TR	Turkish
KM	Cambodian	TS	Tsonga
KN	Kannada	TT	Tatar
KO	Korean (KOR)	TW	Twi
KS	Kashmiri	UK	Ukrainian
KU	Kurdish	UR	Urdu
KY	Kirghiz	UZ	Uzbek
LA	Latin	VI	Vietnamese
LN	Lingala	VO	Volapuk
LO	Laothian	WO	Wolof
LT	Lithuanian	XH	Xhosa
LV	Latvian, Lettish	YO	Yoruba
MG	Malagasy	ZU	Zulu
MI	Maori		

General

Power source: AC 230 V ~ , 50 Hz
Power consumption: 25 W (in operation)
1.0 W (on standby)
Weight: 2.7 kg
External dimensions
(W x H x D): 150 mm x 152 mm x 246 mm

DVD player

Playable discs: DVD VIDEO, DVD AUDIO, VCD, SVCD, CD, CD-R/RW (CD, VCD, MP3, WMA, JPEG format), DVD-R/-RW (video format)

Video output

Color system: PAL
Horizontal resolution: 500 lines
Composite x1: 1.0 V (p-p)/75 Ω ,
synchronization negative
S-video x1: Y output: 1.0 V (p-p)/75 Ω ,
synchronization negative
C output: 0.3 V (p-p)/75 Ω
Component x1: Y output: 1.0 V (p-p)/75 Ω
P_B/P_R output: 0.7 V (p-p)/75 Ω

Audio output

Analog sound output:
Speakers x2
Output power: 36 W (18 W+18 W)
(IEC 268-3) at 4 Ω (10% THD)
Fitting impedance: 4 Ω to 16 Ω
Headphones x1: 11 mW/32 Ω
Fitting impedance: 16 Ω to 1 k Ω
Subwoofer x1: 500 mVrms/10 k Ω
Digital sound output:
Optical x1: -21 dBm to -15 dBm

Audio input

Sound input: AUX x1
400 mV/50 k Ω

Tuner

FM tuner:
Receiving frequency: 87.50 MHz to 108.00 MHz
Antenna: 75 Ω - Unbalanced type
AM (MW) tuner:
Receiving frequency: 522 kHz to 1 629 kHz
Antenna: External antenna jack (loop antenna)

Speaker

Type: Full range
1-way bass-reflex type
Magnetically shielded type
Speaker: 8 cm cone x1
Frequency response: 60 to 20 000 Hz
Power handling capacity: 20 W
Impedance: 4 Ω
Sound pressure level: 81 dB/W·m
Dimension (W x H x D): 120 mm x 150 mm x 188 mm
Weight: 1.5 kg each

Designs and Specifications are subject to change without notice.

JVC

Free Manuals Download Website

<http://myh66.com>

<http://usermanuals.us>

<http://www.somanuals.com>

<http://www.4manuals.cc>

<http://www.manual-lib.com>

<http://www.404manual.com>

<http://www.luxmanual.com>

<http://aubethermostatmanual.com>

Golf course search by state

<http://golfingnear.com>

Email search by domain

<http://emailbydomain.com>

Auto manuals search

<http://auto.somanuals.com>

TV manuals search

<http://tv.somanuals.com>