

# JVC



## COMPACT COMPONENT SYSTEM

# MX-GC5

—Consists of CA-MXGC5 and SP-MXGC5

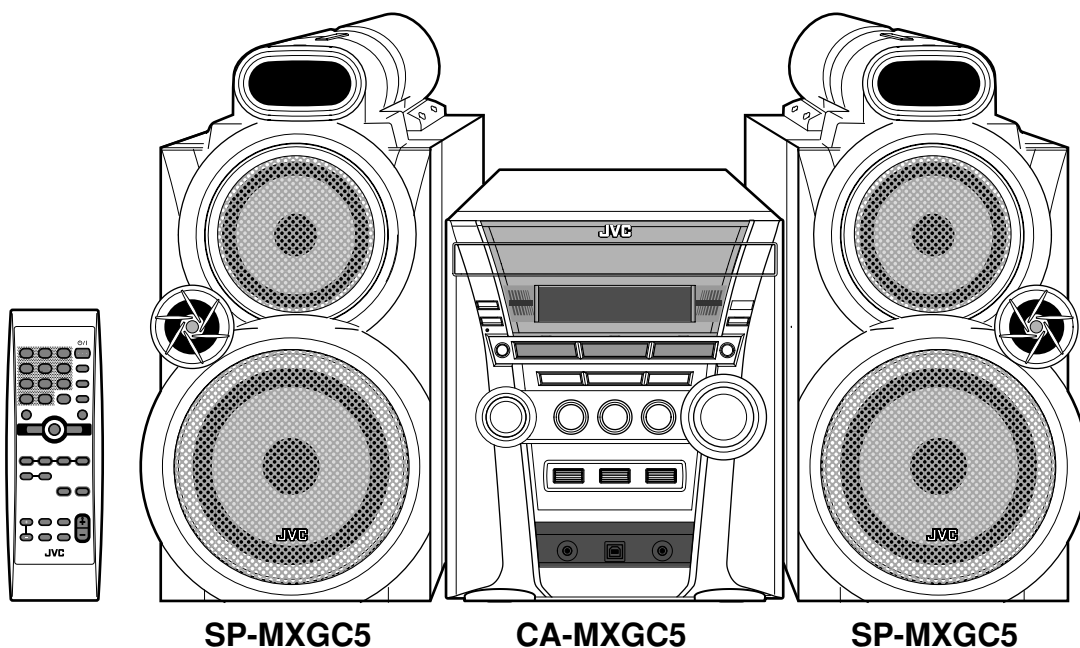

COMPACT  
**disc**  
DIGITAL AUDIO

**MP3**  
PLAYBACK

SP-MXGC5

CA-MXGC5

SP-MXGC5

# INSTRUCTIONS

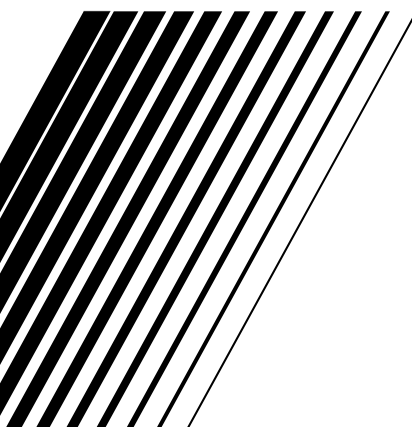

# Warnings, Cautions and Others

---

## CAUTION

To reduce the risk of electrical shocks, fire, etc.:

1. Do not remove screws, covers or cabinet.
2. Do not expose this appliance to rain or moisture.

## CAUTION— $\odot$ /I (standby/on) button!

Disconnect the mains plug to shut the power off completely (all lamps and indications go off). The  $\odot$ /I button in any position does not disconnect the mains line.

- When the unit is on standby, the STANDBY lamp lights in red.
- When the unit is turned on, the STANDBY lamp goes off.

The power can be remote controlled.

## CAUTION

- Do not block the ventilation openings or holes. (If the ventilation openings or holes are blocked by a newspaper or cloth, etc., the heat may not be able to get out.)
- Do not place any naked flame sources, such as lighted candles, on the apparatus.
- When discarding batteries, environmental problems must be considered and local rules or laws governing the disposal of these batteries must be followed strictly.
- Do not expose this apparatus to rain, moisture, dripping or splashing and that no objects filled with liquids, such as vases, shall be placed on the apparatus.



24.0 kg

## CAUTION!

To avoid personal injury or accidentally dropping the unit, have two persons unpack, carry, and install the unit.

## IMPORTANT FOR LASER PRODUCTS

1. CLASS 1 LASER PRODUCT
2. **CAUTION:** Do not open the top cover. There are no user serviceable parts inside the unit; leave all servicing to qualified service personnel.
3. **CAUTION:** Visible and invisible laser radiation when open and interlock failed or defeated. Avoid direct exposure to beam.
4. REPRODUCTION OF LABEL: CAUTION LABEL, PLACED INSIDE THE UNIT.

<b>CAUTION :</b> Visible and invisible laser radiation when open and interlock failed or defeated. AVOID DIRECT EXPOSURE TO BEAM.	<b>ADVARSEL :</b> Synlig og usynlig laserstråling når maskinen er åben eller interlocken fejler. Undgå direkte eksponering til stråling. (e)	<b>VARNING :</b> Synlig och osynlig laserstråling när den öppnas och spärren är urkopplad. Betrakta ej strålen. (d)	<b>VARO :</b> Avattaessa ja suojaelukitus ohjeltuna tai viallisena olet alittina näkyvälle ja näkymättömälle lasersäteilylle. Vältä säteen kohdistumista suoraan itseesi. (f)
---	--	---	---

### Caution: Proper Ventilation

To avoid risk of electric shock and fire, and to prevent damage, locate the apparatus as follows:

#### 1 Front:

No obstructions and open spacing.

#### 2 Sides/ Top/ Back:

No obstructions should be placed in the areas shown by the dimensions below.

#### 3 Bottom:

Place on the level surface. Maintain an adequate air path for ventilation by placing on a stand with a height of 10 cm or more.

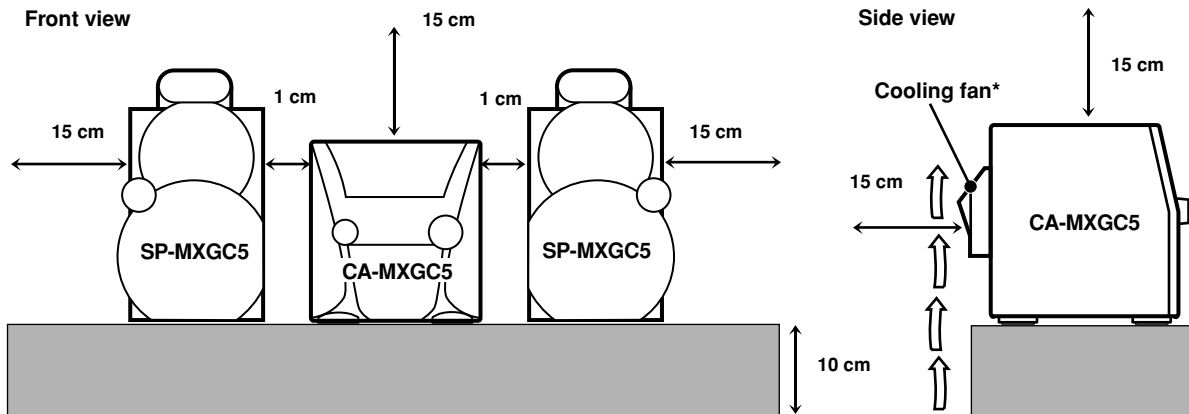

#### \* About the cooling fan

A cooling fan is mounted on the rear panel of the unit to prevent abnormal temperature inside the unit, thus assuring normal operation of the unit. The cooling fan automatically starts rotating to intake external cool air when the volume is increased up to more than a certain level.

# Introduction

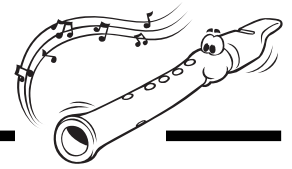

We would like to thank you for purchasing one of our JVC products. Before operating this unit, read this manual carefully and thoroughly to obtain the best possible performance from your unit, and retain this manual for future reference.

## About This Manual

This manual is organized as follows:

- The manual mainly explains operations using the buttons and controls on the remote control. You can also use the buttons on the unit if they have the same or similar names (or marks) as those on the remote control.

If operation using the unit is different from that using the remote control, it is then explained.

- Basic and common information that is the same for many functions is grouped in one place, and is not repeated in each procedure. For instance, we do not repeat the information about turning on/off the unit, setting the volume, changing the sound effects, and others, which are explained in the section “Common Operations” on pages 10 to 12.
- The following marks are used in this manual:



Gives you warnings and cautions to prevent damage or risk of fire/electric shock. Also gives you information which is not good for obtaining the best possible performance from the unit.



Gives you information and hints you had better know.

## Precautions

### Installation

- Do not grasp the control knobs when moving or carrying the unit.
- Install in a place which is level, dry and neither too hot nor too cold—between 5°C and 35°C.
- Install the unit in a location with adequate ventilation to prevent internal heat built-up in the unit.
- Leave sufficient distance between the unit and the TV.
- Keep the speakers away from the TV to avoid interference with TV.



DO NOT install the unit in a location near heat sources, or in a place subject to direct sunlight, excessive dust or vibration.

### Power sources

- When unplugging from the wall outlet, always pull the plug, not the AC power cord.



DO NOT handle the AC power cord with wet hands.

### Moisture condensation

Moisture may condense on the lens inside the unit in the following cases:

- After starting heating in the room
  - In a damp room
  - If the unit is brought directly from a cold to a warm place
- Should this occur, the unit may malfunction. In this case, leave the unit turned on for a few hours until the moisture evaporates, unplug the AC power cord, and then plug it in again.

### Others

- Should any metallic object or liquid fall into the unit, unplug the unit and consult your dealer before operating any further.
- If you are not going to operate the unit for an extended period of time, unplug the AC power cord from the wall outlet.



DO NOT disassemble the unit since there are no user serviceable parts inside.

If anything goes wrong, unplug the AC power cord and consult your dealer.

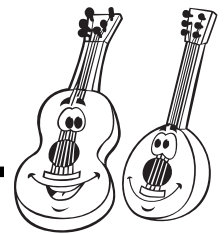

<b>Location of the Buttons and Controls .....</b>	<b>3</b>
<b>Getting Started .....</b>	<b>6</b>
Unpacking .....	6
Putting the Batteries into the Remote Control .....	6
Connecting Antennas .....	6
Connecting Speakers .....	7
Connecting Other Equipment .....	8
Canceling the Display Demonstration .....	8
Saving the Power Consumption while on Standby— ECO mode .....	8
Connecting a Computer .....	9
<b>Common Operations .....</b>	<b>10</b>
Turning On or Off the Power .....	10
Setting the Clock .....	10
Selecting the Sources .....	10
Adjusting the Volume .....	11
Reinforcing the Bass Sound .....	11
Enjoying the Powerful Sound—RHYTHM AX .....	11
Selecting the Sound Modes .....	12
Turning On or Off the Key-touch Tone .....	12
<b>Listening to the Radio .....</b>	<b>13</b>
Tuning in to a Station—Auto Search .....	13
Presetting Stations .....	13
Tuning in to a Preset Station .....	13
<b>Playing Back CDs .....</b>	<b>14</b>
Loading discs .....	14
Continuous Playback .....	14
Basic CD Operations .....	16
Changing the MP3 Playback Mode .....	17
Turning On or Off the Resume Play for MP3 Disc ...	17
Programming the Playing Order of the Tracks— Program Play .....	18
Playing at Random—Random Play .....	19
Repeating Tracks or CDs—Repeat Play .....	19
Prohibiting Disc Ejection—Carrousel Lock .....	19
<b>Using the Timers .....</b>	<b>20</b>
Using Daily Timer .....	20
Using Sleep Timer .....	21
<b>Troubleshooting .....</b>	<b>22</b>
<b>Maintenance .....</b>	<b>23</b>
<b>Specifications .....</b>	<b>24</b>

# Location of the Buttons and Controls

Become familiar with the buttons and controls on your unit.

## Front Panel

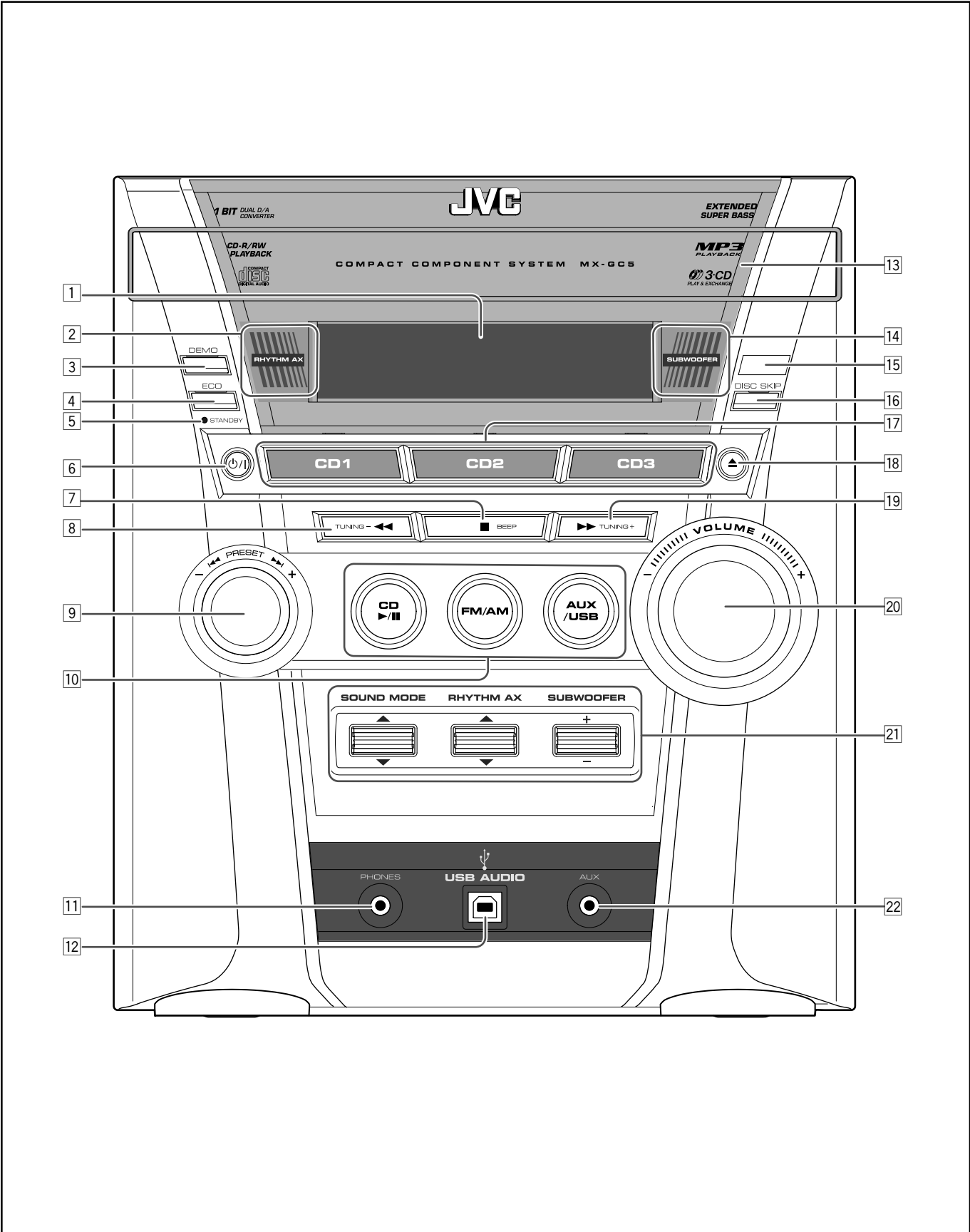

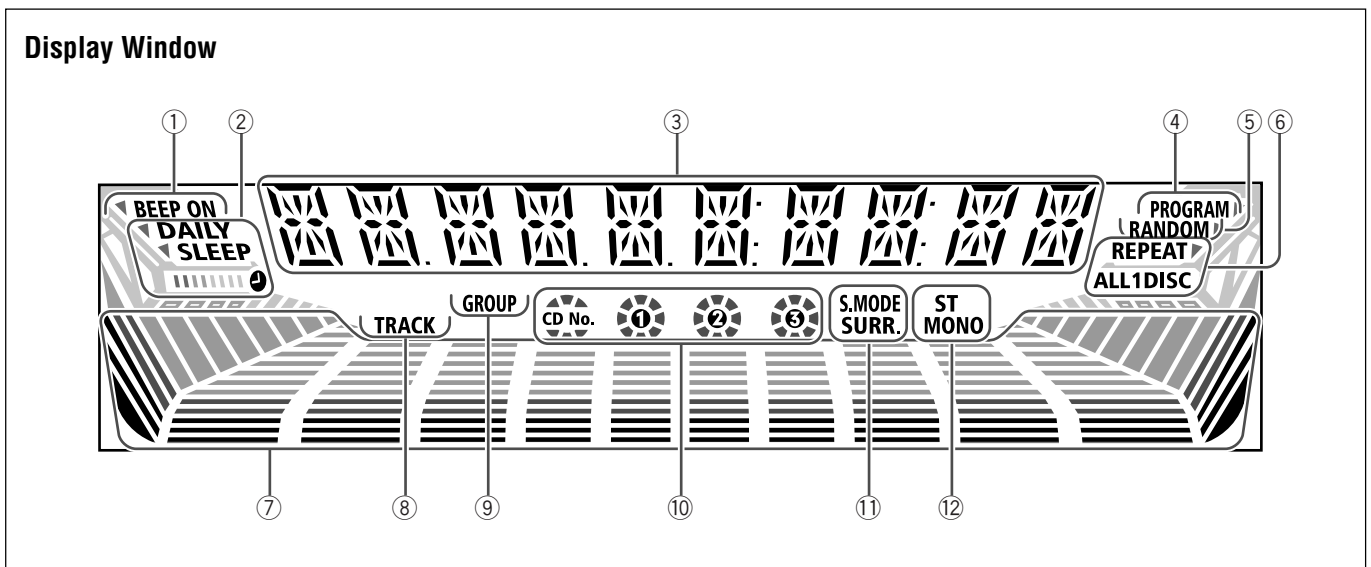

See pages in the parentheses for details.

### Front Panel

- 1 Display window
- 2 RHYTHM AX lamp (11)
- 3 DEMO button (8)
- 4 ECO button (8)
- 5 STANDBY lamp (10)
- 6  $\text{O}/\text{I}$  (standby/on) button (10)
- 7
  - ■ (stop) button (15, 19)
  - BEEP button (12)
- 8
  - TUNING – button (13)
  - ◀◀ (fast reverse) button (16)
- 9
  - PRESET +/- control (13)
  - ▶▶/|◀◀ (forward search/reverse search) control (16, 17)
- 10 Source selecting buttons
  - CD ▶/|| (play/pause) button (10, 14 – 19)
  - FM/AM button (10, 13)
  - AUX/USB button (8 – 10)

*Pressing one of these buttons also turns on the unit.*
- 11 PHONES jack (11)
- 12 USB AUDIO terminal (9)
- 13 Carrousel
- 14 SUBWOOFER lamp (11)
- 15 Remote sensor (5)
- 16 DISC SKIP button (14, 16)
- 17 Disc tray selecting buttons and lamps (10, 14 – 16, 18, 19)
  - CD1, CD2, and CD3 buttons

*Pressing one of these buttons also turns on the unit.*
- 18 ▲ (carrousel open/close) button (14 – 17, 19)
 

*Pressing this button also turns on the unit.*
- 19
  - TUNING + button (13)
  - ▶▶ (fast forward) button (16)
- 20 VOLUME +/- control (11)

- 21 Sound effect controls
  - SOUND MODE control (12)
  - RHYTHM AX control (11)
  - SUBWOOFER +/- control (11)
- 22 AUX jack (8)

### Display Window

- 1 BEEP ON indicator
- 2 Timer indicators
  - DAILY (daily timer), SLEEP (sleep timer), and  $\text{O}$  (timer) indicators
- 3 Main display
  - Shows the source name, frequency, etc.
- 4 PROGRAM indicator
- 5 RANDOM indicator
- 6 REPEAT mode indicators
  - REPEAT ALL, 1, DISC indicators
- 7 Volume level, Subwoofer level and Sound mode pattern indicators
- 8 TRACK indicator
- 9 GROUP indicator
- 10 Disc tray number (CD No., 1, 2, and 3) indicators
  - Shows tray and playback conditions.
- 11 Sound effect indicators
  - S.MODE (sound mode) and SURR. (surround) indicators
- 12 Tuner operation indicators
  - ST (stereo) and MONO indicators



## Remote Control

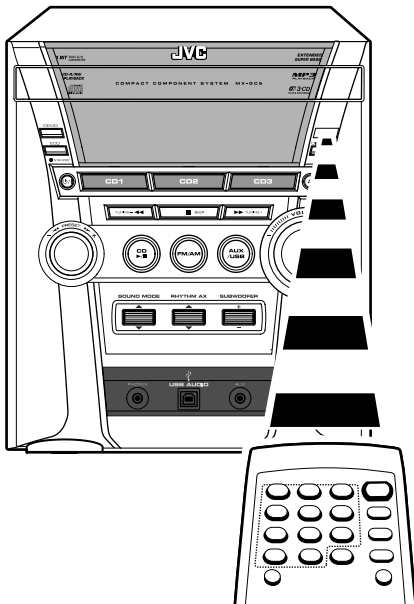
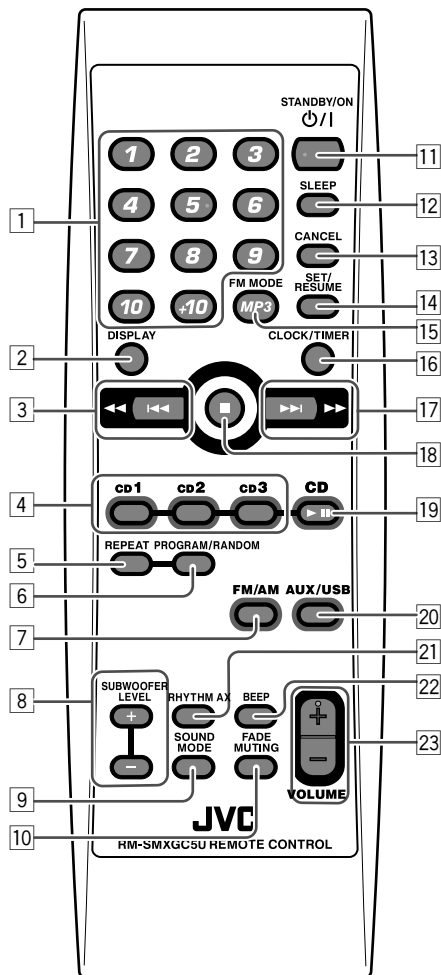

When using the remote control, point it at the remote sensor on the front panel.

## Remote Control

- 1 Number buttons (13, 17, 18)
- 2 DISPLAY button (10)
- 3 ◀◀/▶▶ (reverse search/fast reverse) button (10, 13, 16 – 18, 20, 21)
- 4 Disc tray selecting buttons (10, 14 – 16, 18, 19)
  - CD1, CD2, and CD3 buttons
- 5 REPEAT button (19)
- 6 PROGRAM/RANDOM button (18, 19)
- 7 FM/AM button (10, 13)
 

*Pressing this button also turns on the unit.*
- 8 SUBWOOFER LEVEL +/- buttons (11)
- 9 SOUND MODE button (12)
- 10 FADE MUTING button (11)
- 11 STANDBY/ON ⏻ button (10, 21)
- 12 SLEEP button (21)
- 13 CANCEL button (10, 18, 20, 21)
- 14 SET/RESUME button (10, 13, 17, 20, 21)
  - FM MODE button (13)
  - MP3 button (17)
- 16 CLOCK/TIMER button (10, 20, 21)
- 17 ▶▶/▶▶ (forward search/fast forward) button (10, 13, 16 – 18, 20, 21)
- 18 ■ (stop) button (15, 18, 19)
- 19 CD ▶/⏸ (play/pause) button (10, 14 – 19)
 

*Pressing this button also turns on the unit.*
- 20 AUX/USB button (8 – 10)
 

*Pressing this button also turns on the unit.*
- 21 RHYTHM AX button (11)
- 22 BEEP button (12)
- 23 VOLUME +/- button (11)



## Unpacking

After unpacking, check to be sure that you have all the following items.

The number in the parentheses indicates the quantity of each piece supplied.

- FM antenna (1)
- AM loop antenna (1)
- Remote control (1)
- Batteries (2)

If any is missing, consult your dealer immediately.

## Putting the Batteries into the Remote Control

Insert the batteries—R6P(SUM-3)/AA(15F)—into the remote control, by matching the polarity (+ and –) on the batteries with the + and – markings on the battery compartment. When the remote control can no longer operate the unit, replace both batteries at the same time.

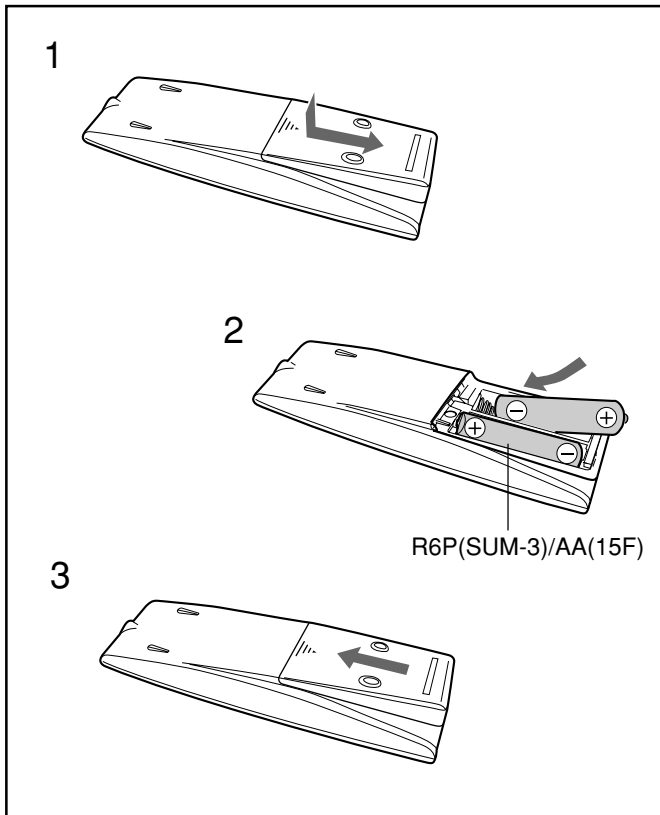

- DO NOT use an old battery together with a new one.
- DO NOT use different types of batteries together.
- DO NOT expose batteries to heat or flame.
- DO NOT leave the batteries in the battery compartment when you are not going to use the remote control for an extended period of time. Otherwise, the remote control will be damaged from battery leakage.

## Connecting Antennas

### FM antenna

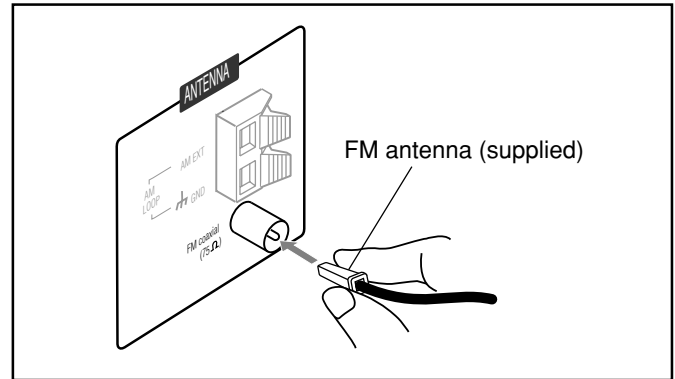

- 1 Attach the FM antenna to the FM [75 Ω] coaxial terminal.**
- 2 Extend the FM antenna.**
- 3 Fasten it up in the position which gives you the best reception, then fix it on the wall, etc.**



#### About the supplied FM antenna

The FM antenna supplied with this unit can be used as temporary measure. If reception is poor, you can connect an outdoor FM antenna (not supplied).

#### To connect an outdoor FM antenna

Before connecting it, disconnect the supplied FM antenna.

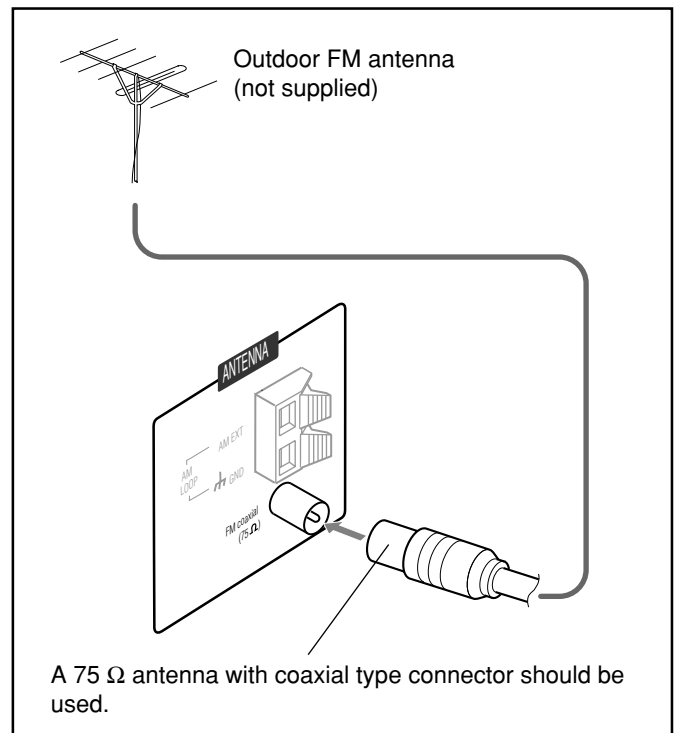

## AM antenna

Make sure to connect the wire correctly: The white end to AM EXT, the black end to GND.

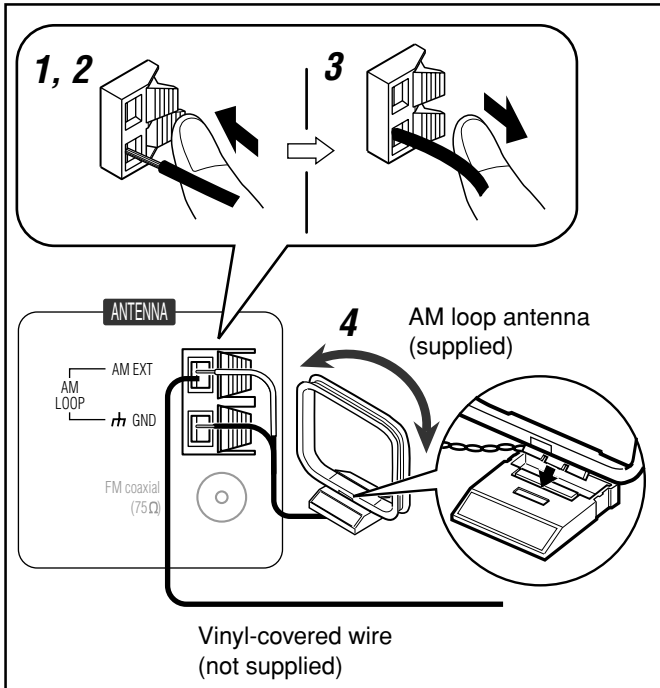

**1** Press and hold the clamp of the AM terminal on the rear of the unit.

**2** Insert the end of the AM loop antenna cord into the terminal.

- If the AM loop antenna wire is covered with vinyl, remove the vinyl by twisting it as shown in the diagram.

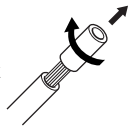

**3** Release the finger from the clamp.

**4** Turn the AM loop antenna until you have the best reception.

### To connect an outdoor AM antenna

When reception is poor, connect a single vinyl-covered wire to the AM terminal and extend it horizontally. (The AM loop antenna must remain connected.)



#### For better reception of both FM and AM

- Make sure the antenna conductors do not touch any other terminals and connecting cords.
- Keep the antennas away from metallic parts of the unit, connecting cords, and the AC power cord.

## Connecting Speakers



DO NOT carry the speaker by holding the tube duct (on the top of the speaker).

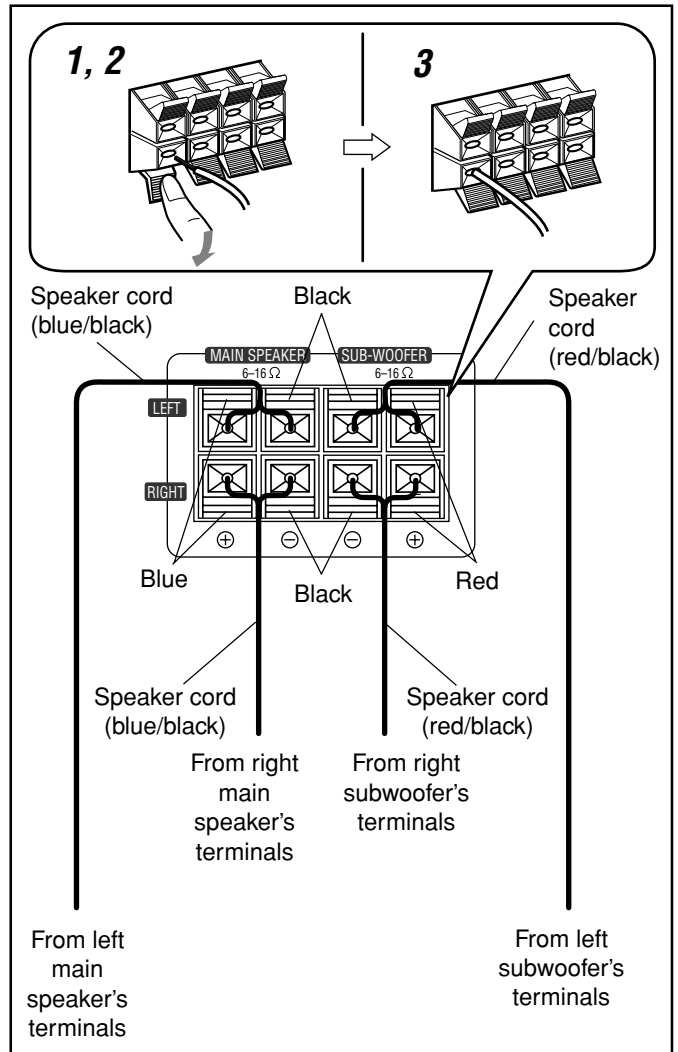

**1** Press and hold the clamp of the speaker terminal on the rear of the unit.

**2** Insert the end of the speaker cord into the terminal.

Match the colors (polarity): Blue (+) to blue (+) and black (-) to black (-); red (+) to red (+) and black (-) to black (-).

- If the wire is covered with vinyl, remove the vinyl by twisting it as shown in the diagram.

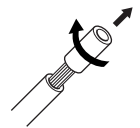

**3** Release the finger from the clamp.

### IMPORTANT:

- Use only speakers with the same speaker impedance as indicated by the speaker terminals on the rear of the unit.
- DO NOT connect more than one speaker to one speaker terminal.

## Connecting Other Equipment

You can connect audio equipment—used only as a playback device.



- DO NOT connect any equipment while the power is on.
- DO NOT plug in any equipment until all connections are complete.

### To connect audio equipment

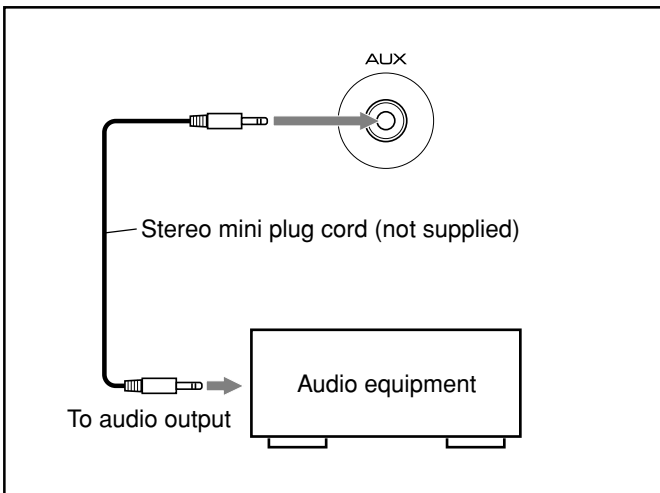

For playing the other equipment through this unit, connect between the audio output jack on the other equipment and AUX jack on the front of the unit by using a stereo mini plug cord (not supplied).



#### If the audio output on the other equipment is not stereo mini plug type

Use a plug adapter to convert the stereo mini plug to the corresponding plug of the audio output.

**NOW you are ready to plug in the unit and other connected equipment.**

## Canceling the Display Demonstration

When connecting the AC power cord into a wall outlet, the unit automatically starts the display demonstration.

### On the unit ONLY:

**To cancel the display demonstration,** press DEMO while the display demonstration is shown on the display.



#### When you press other buttons

The display demonstration stops temporarily. It will start automatically again (if no operation is done for 2 minutes) until you cancel it.

### To start the display demonstration manually

Press and hold DEMO again for more than 2 seconds.



## Saving the Power Consumption while on Standby—ECO mode

You can save the power consumption while the unit is turned off (on standby).

### On the unit ONLY:

**To activate the ECO mode,** press ECO while the unit is turned off (on standby). “ECO MODE” appears on the display illumination (including the display demonstration) disappears.



**To deactivate the ECO mode,** press ECO again. The display illumination appears.



#### About ECO mode

While ECO mode is activated, the display demonstration is canceled temporarily.



## Connecting a Computer

This unit is equipped with a USB AUDIO terminal on the front panel.

You can connect your PC to this terminal and enjoy sound reproduced through your PC.

When you connect your PC for the first time, follow the procedure below.

- Remember you cannot send any signal or data to your PC from this unit.

### IMPORTANT:

- Check if your PC equipped with the CD-ROM drive is running on Windows® 98\*, Windows® Me\* or Windows® XP\* and prepare its CD-ROM.

### How to install the USB drivers

The following procedure is described using the English version of Windows® XP. If your PC is running on a different version of operation system or language, the screens shown on your PC's monitor will differ from the ones used in the following procedure.

#### 1 Turn on your PC and start running Windows® 98, Windows® 98 SE, Windows® Me, Windows® 2000, or Windows® XP.

- If the PC has been turned on, quit all the applications now running.

#### 2 Select "USB IN" as the source.

#### 3 Set the volume to minimum.

### IMPORTANT:

- Always set volume to "VOL MIN" when connecting or disconnecting the other equipment.

#### 4 Connect the unit to the PC using a USB cable (not supplied).

Your PC automatically recognizes this connection.

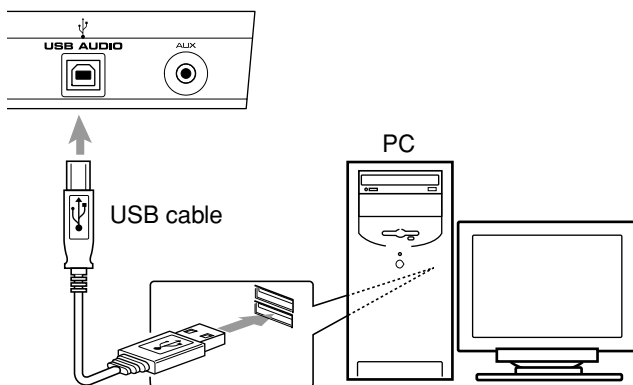

- Use "USB series A plug to B plug" cable when connecting.

#### 5 The USB drivers are installed automatically.

### Now PC is ready for playback through the USB connection.

After installation is completed, you can use your PC as the playback source. The PC automatically recognizes the unit whenever a USB cable is connected between the PC and the unit while the unit is turned on.

- When not using the PC as the playback source, disconnect the USB cable.



To play back sounds on the PC, refer to the manuals supplied with the sound reproduction application installed in the PC.



- DO NOT turn off the unit or disconnect the USB cable while installing the drivers and for several seconds while your PC is recognizing the receiver.
- Use a full speed USB cable (version 1.1). Recommended cord length is 1.5 m.
- If your PC does not recognize the unit, disconnect the USB cable and connect it again. If it does not work yet, restart Windows.
- The installed drivers can be recognized only when the USB cable is connected between the unit and your PC.
- The sound may not be played back correctly—interrupted or degraded—due to your PC settings and PC specifications.



\* Microsoft®, Windows® 98, Windows® SE, Windows® Me, Windows® 2000, and Windows® XP are registered trademarks of Microsoft corporation.

## Turning On or Off the Power

To turn on the unit, press STANDBY/ON  (or  on the unit) so that the STANDBY lamp goes off.

POWER ON



To turn off the unit (on standby), press STANDBY/ON  (or  on the unit) again so that the STANDBY lamp lights up.

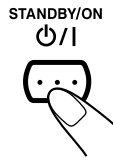

A little power is always consumed even while the unit is on standby.

To switch off the power supply completely, unplug the AC power cord from the AC outlet.

**notes** When you unplug the AC power cord or if a power failure occurs  
The clock is reset to "0:00" right away, while the tuner preset stations (see page 13) will be erased in a few days.

## Setting the Clock



Before operating the unit any further, first set the clock built in this unit. You can set the clock whether the unit is on or off.

### On the remote control ONLY:

**1** Press CLOCK/TIMER.



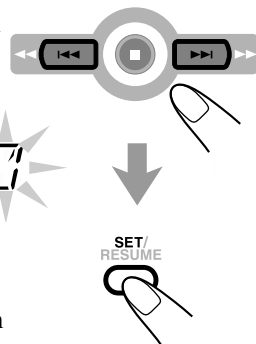

The hour digits start flashing on the display.

**2** Press  or  to adjust the hour, then press SET/RESUME.



The minute digits start flashing on the display.

- If you want to correct the hour after pressing SET/RESUME, press CANCEL. The hour digits start flashing again.

**3** Press  or  to adjust the minute, then press SET/RESUME.

CLOCK OK

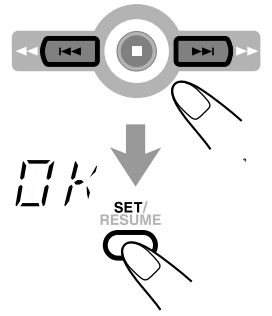

### To check the clock time

Press DISPLAY while playing any source.

- To return to the source indication, press DISPLAY again.



**notes** While the time indication appears on the display  
If you press a button or turn a control, the time indication returns to the source indication.

### To adjust the clock again

**1** Press CLOCK/TIMER repeatedly until "CLOCK" is selected.

- Each time you press the button, the clock/timer setting modes change as follows:

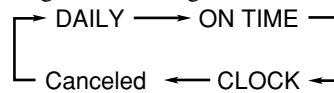

**2** Press SET/RESUME.

**3** Perform steps **2** and **3** of "Setting the Clock."



**notes** When you unplug the AC power cord or if a power failure occurs

The clock loses the setting and is reset to "0:00." You need to set the clock again.

## Selecting the Sources

To listen to the radio, press FM/AM. (See page 13.)

To play back CDs, press CD  or CD1, CD2, CD3. (See pages 14 – 19.)

To select the external equipment as the source, press AUX/USB. (See pages 8 and 9.)

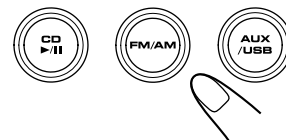

When you press the play button for a particular source (FM/AM, CD , and AUX/USB), the unit turns on and the unit starts playing the source if it is ready.

- The selected source lamp lights up.

## Adjusting the Volume

You can adjust the volume level only while the unit is turned on.

Press **VOLUME +** to increase the volume or press **VOLUME -** to decrease it.

- The volume level can be adjusted in 33 steps (VOL MIN, VOL 1 — VOL 31, and VOL MAX).



VOL 14

When using the unit, turn the **VOLUME** control clockwise to increase the volume or counterclockwise to decrease it.



### For private listening

Connect a pair of headphones to the **PHONES** jack. No sound comes out of the speakers. Be sure to turn down the volume before connecting or putting on headphones.



Always set the volume to the minimum before starting any source. If the volume is set to extremely high level, a sudden blast of sound can damage your hearing, speakers and/or headphones.

- If you have turned off (on standby) the unit with the volume level set at more than level “15,” the volume level will be automatically set at level “15” next time you turn on the unit.

### To turn down the volume level temporarily

Press **FADE MUTING** on the remote control. The volume level gradually decreases to “VOL MIN.”

To restore the sound, press the button again.



## Reinforcing the Bass Sound

Press **SUBWOOFER LEVEL +** or **-** (or **SUBWOOFER +/-** control on the unit) to increase or decrease the subwoofer sound.

- The subwoofer level can be adjusted in 3 steps (OFF, S.WOOFER1, S.WOOFER2). The **SUBWOOFER** lamp also lights up.



S.WOOFER2



## Enjoying the Powerful Sound—RHYTHM AX

Using **RHYTHM AX**, harder-hitting beats intensify your listening experience even at low sound levels.

**RHYTHM AX** also works even when the song has no “beat,” such as classical music, so that you can listen to the rich sound even at low sound levels.

### On the remote control:

Press **RHYTHM AX**.

“**RHYTHM AX**” scrolls on the display.

- Each time you press the button, **RHYTHM AX** turns on and off alternately. The **RHYTHM AX** lamp also lights up.



RHYTHM AX

### On the unit:

Press up the **RHYTHM AX** control to turn on or press down the **RHYTHM AX** control to turn off.

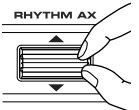



## Selecting the Sound Modes

You can select one of the 6 preset sound modes (3 surround modes and 3 SEA—Sound Effect Amplifier—modes).

### On the remote control:

Press **SOUND MODE** repeatedly until the sound mode you want appears on the display.

- First time you press the button, the current sound mode appears on the display.



The S.MODE and SURR. indicators also light up on the display

Each time you press the button while a sound mode appears on the display, the sound modes change as follows:

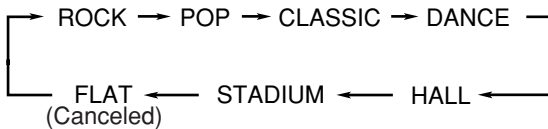

### On the unit:

Press up or down the **SOUND MODE** control until the sound mode you want appears on the display.

- First time you press up or down the control, the current sound mode appears on the display. Each time you press up or down the control while a sound mode appears on the display, the sound modes change as follows:

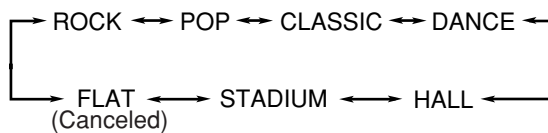
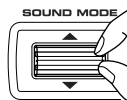

### SEA (Sound Effect Amplifier) modes\*<sup>1</sup>:

- ROCK** : Boosts low and high frequency. Good for acoustic music.
- POP** : Good for vocal music.
- CLASSIC** : Good for classical music.
- FLAT** : Cancels the sound mode.

### Surround modes\*<sup>2</sup>:

- DANCE** : Increases resonance and bass.
- HALL** : Adds depth and brilliance to the sound.
- STADIUM**: Adds clarity and spreads the sound, like in an outdoor stadium.

\*<sup>1</sup> While one of the SEA modes (SEA elements without surround elements) is selected, the S.MODE indicator lights up.

\*<sup>2</sup> Surround elements are added to the SEA elements to create being-there feeling in your room.

When one of these modes is selected, the S.MODE and SURR. indicators light up.

## Turning On or Off the Key-touch Tone

If you do not want the key-touch tone to beep each time you press a button or turn a control, you can deactivate it.

- You can turn on or off the key-touch tone whether the unit is on or off.

### On the remote control:

Press **BEEP**.

- Each time you press the button, the key-touch tone turns on and off alternately.



The BEEP ON indicator also lights up on the display



### On the unit:

Press and hold **BEEP** for more than 2 seconds.

- Each time you press and hold the button, the key-touch tone turns on and off alternately.

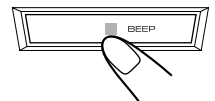

# Listening to the Radio



## Tuning in to a Station—Auto Search

### 1 Press FM/AM.

The unit automatically turns on and tunes in to the previously tuned station (either FM or AM).

- Each time you press the button, the band alternates between FM and AM.



### 2 Start searching for stations.

**On the remote control:**

Press and hold **▶▶/▶▶** or **◀◀/◀◀** for more than 1 second.



**On the unit:**

Press and hold **TUNING +** or **TUNING -** for more than 1 second.



The unit starts searching for stations and stops when a station of sufficient signal strength is tuned in.

If a program is broadcast in stereo, the ST (stereo) indicator lights up.

To stop while searching, press **▶▶/▶▶** or **◀◀/◀◀** (or **TUNING +** or **TUNING -** on the unit).

**notes** When you press **▶▶/▶▶** or **◀◀/◀◀** (or **TUNING +** or **TUNING -** on the unit) briefly and repeatedly

The frequency changes step by step.

### To change the FM reception mode

When an FM stereo broadcast is hard to receive or noisy, press **FM MODE** on the remote control so that “MONO” appears and the MONO indicator also lights up on the display. Reception improves.

To restore the stereo effect, press **FM MODE** again so that “STEREO” appears on the display.



### 2 Press SET/RESUME on the remote control.



### 3 Press the number button(s) to select a preset number.

Ex.: For preset number 5, press 5.

For preset number 15, press +10 then 5.

For preset number 20, press +10, then 10.

For preset number 25, press +10, +10, then 5.

For preset number 30, press +10, +10, then 10.

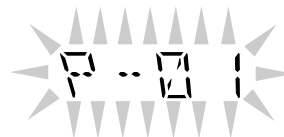

### 4 Press SET/RESUME on the remote control again.



The tuned station in step 1 is stored in the preset number selected in step 3.

- Storing a new station on a used number erases the previously stored one.

**notes** When you unplug the AC power cord or if a power failure occurs

The preset stations will be erased in a few days. If this happens, preset the stations again.

## Presetting Stations

You can preset 30 FM and 15 AM stations.

In some cases, test frequencies have been already memorized for the tuner since the factory examined the tuner preset function before shipment. This is not a malfunction. You can preset the stations you want into memory by following the presetting method.

- There is a time limit in doing the following steps. If the setting is canceled before you finish, start from step 2 again.

**On the remote control ONLY:**

### 1 Tune in to the station you want to preset (in this example, of FM 87.50).

- See “Tuning in to a Station—Auto Search.”



## Tuning in to a Preset Station

### 1 Press FM/AM.

The unit automatically turns on and tunes in to the previously tuned station (either FM or AM).

- Each time you press the button, the band alternates between FM and AM.



### 2 Select a preset number.

**On the remote control:**

Press the number buttons.

Ex.: For preset number 5, press 5.

For preset number 15, press +10 then 5.

For preset number 20, press +10, then 10.

For preset number 25, press +10, +10, then 5.

For preset number 30, press +10, +10, then 10.

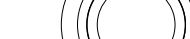

**On the unit:**

Turn **PRESET +/-** control to select a preset number.

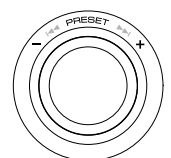



# Playing Back CDs

This unit has been designed to playback the following CDs:



- Audio CD
- CD-R (CD-Recordable)
- CD-RW (CD-ReWritable)
- MP3 disc (MP3 files recorded on a CD-R or CD-RW)\*

### When playing a CD-R or CD-RW

- User-edited CD-Rs (CD-Recordable) and CD-RWs (CD-ReWritable) can be played back when they are already “finalized.”
- Before playing back CD-Rs or CD-RWs, read their instructions or cautions carefully.
- Some CD-Rs or CD-RWs may not be played back on this unit because of their disc characteristics, damage or stain on them, or if the player’s lens is dirty.

### Important notices:

- In general, you will have the best performance by keeping your CDs and the mechanism clean.
  - Store CDs in their cases, and keep them in cabinets or on shelves.
  - Keep the unit’s carousel closed when not in use.
- Continuous use of irregular shaped discs (heart-shape, octagonal, etc.) can damage the disc rotating mechanism.



- CD-RWs may require a longer readout time since the reflectance of CD-RWs is lower than for regular CDs.

### \* For MP3 discs

- This unit manages files and folders on MP3 discs as “tracks” and “albums.”
- The player can only recognize files with “.MP3” or “.mp3” as the extensions, which can be in any combination of upper and lower case. The file name needs to be up to 32 characters.
- This unit recognizes files and folders on a disc in the following conditions:
  - up to 500 MP3 files.
  - up to 200 folders (including the root folder).
- Playback order of the MP3 files (tracks) recorded on a disc are determined by the writing (or encoding) application; therefore, playback order may be different from the one you have intended while recording the files and the folders.
- This unit shows up to 30 characters of the file (track) names and the ID3v1/1.1 tags (only “Title,” “Artist,” and “Album”) on the display after the file starts play; however, there is a limitation on available characters and some file names and ID3v1/1.1 tags are not shown correctly.



### More about MP3 discs

- MP3 discs (either CD-R or CD-RW) require a longer readout time. (It varies due to the complexity of the recording configuration.)
- When making an MP3 disc, select ISO 9660 Level 1 or Level 2 as the disc format.
- This unit does not support multisession recording.
- This unit can play MP3 files only with the following file extensions— “.MP3”, “.Mp3”, “.mp3”, and “.mp3”.
- Non-MP3 files are ignored. If non-MP3 files are recorded together with MP3 files, this unit will take a longer time to scan the disc. It may also cause the unit to malfunction.
- Some MP3 discs may not be played back because of their disc characteristics or recording conditions.

### Caution for DualDisc playback

The Non-DVD side of a “DualDisc” does not comply with the “Compact Disc Digital Audio” standard. Therefore, the use of Non-DVD side of a DualDisc on this product may not be recommended.

## Loading discs

### On the unit ONLY:

#### 1 Press .

The unit automatically turns on and the carousel comes out.

- Pressing the button changes the playing source to “CD.”

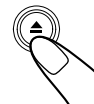

#### 2 Place one or two discs correctly on the front recesses of the disc tray, with its label side up.

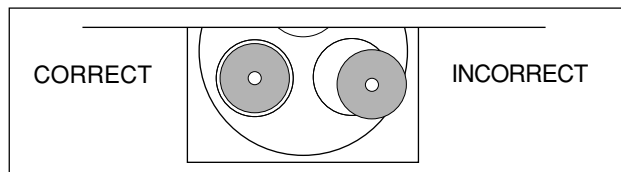

- When using a CD single (8 cm), place it on the inner recess of the disc tray.

#### 3 If you wish to load a third disc, press DISC SKIP.

The disc tray rotates by 120°.



#### 4 Press again.

The carousel closes.



To remove the disc, press 

## Continuous Playback

You can play discs continuously.

#### 1 Load discs.

#### 2 Press the corresponding disc number button (CD1 – CD3) to select the disc to start playing back.

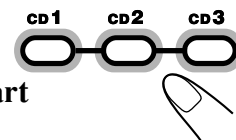

CD play starts from the first track of the selected disc.

- Pressing CD  instead of the disc number buttons starts playing back if a disc is on the tray.

### For Audio CD:

Current track number      Elapsed playing time



TRACK

**For MP3 disc:**

• **When the MP3 playback mode is the TRACK mode**

(See also page 17.)

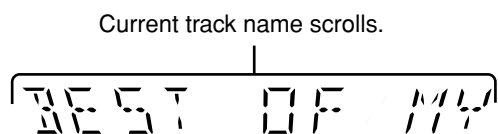

When the track includes the ID3v1/1.1 tags, "Title," "Artist," and "Album" will scroll after the track name.

- "TITLE" appears before the content of "Title" scrolls,
- "ARTIST" appears before the content of "Artist" scrolls, and
- "ALBUM" appears before the content of "Album" scrolls.

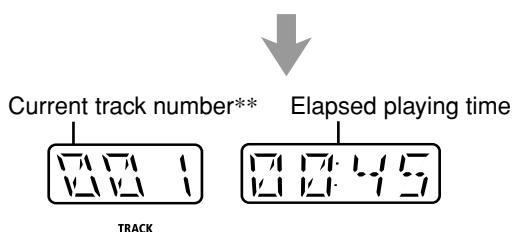

\*\* In the TRACK mode, the unit manage only files (tracks) on the MP3 disc. Folders (groups) are not recognized.

• **When the MP3 playback mode is the GROUP mode**

(See also page 17.)

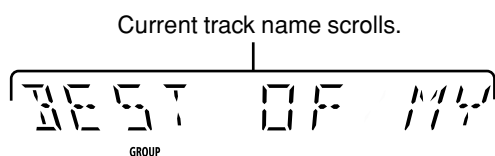
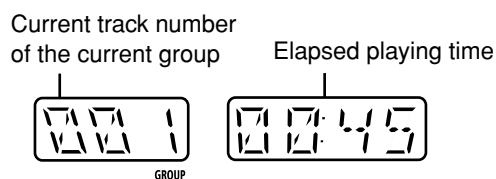
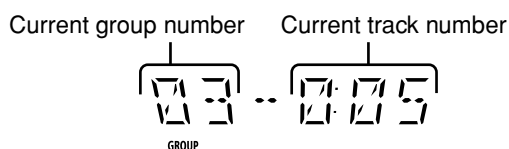

When the track includes the ID3v1/1.1 tags, "Title," "Artist," and "Album" will scroll after the track name.

- "TITLE," "ARTIST," and "ALBUM" appears before each of their content scrolls.

To stop during play, press ■.

**For Audio CD:**

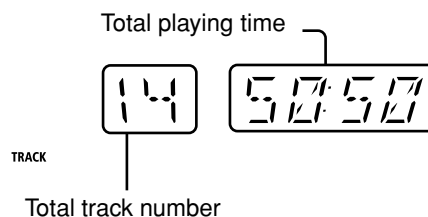

**For MP3 disc:**

(in TRACK mode)

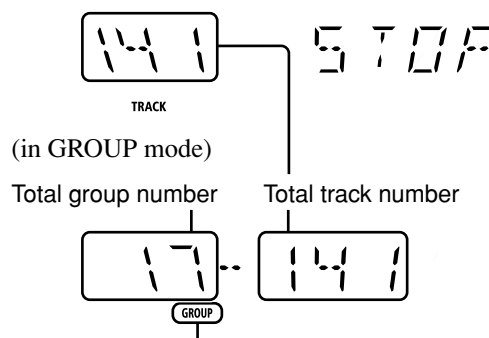

The GROUP indicator appears when the MP3 playback mode is the GROUP mode. See also page 17.

- For MP3 disc, this unit can memorize the position on a disc where you interrupt playback, and resume playback from that position later. By pressing CD ►/■, you can start playback again from the interrupted position—Resume play (see also page 17).

To remove the disc, press ▲ when the playback is stopped.



**CD playback sequence**

When 3 discs are loaded on the disc trays, they are played in one of the following sequences.

- When CD1 is pressed : CD1 ⇒ CD2 ⇒ CD3 (then selects CD1, and stops)
- When CD2 is pressed : CD2 ⇒ CD3 ⇒ CD1 (then selects CD2, and stops)
- When CD3 is pressed : CD3 ⇒ CD1 ⇒ CD2 (then selects CD3, and stops)

\* When only 2 discs are loaded, they are played in the same order, but the disc tray without a disc is skipped.

## Basic CD Operations

While playing a disc, you can do the following operations.

### To exchange CDs during playback of another

Press  on the unit.

The carrousel comes out.

If you change discs during play, the current play will not stop until all discs you have changed are played.



To close the carrousel, press  again.

### To skip to the another CD in the carrousel

During play, press one of the disc tray selecting buttons (CD1, CD2, or CD3) or DISC SKIP on the unit.

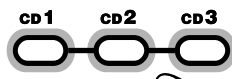

**During playback with the carrousel open**  
DISC SKIP does not work.

### To stop play for a moment

Press CD .





While pausing, elapsed playing time flashes on the display.





To resume play, press CD  again.

### To go to another track

#### For Audio CD:



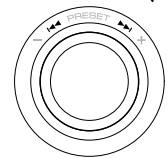
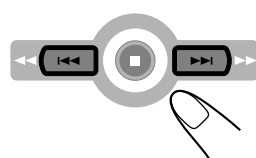

Press  or  (or turn the  /  control on the unit).



- : Skips to the beginning of the next or succeeding tracks.
- : Goes back to the beginning of the current or previous tracks.



#### For MP3 disc:





When the MP3 playback mode is the TRACK mode (see also page 17):



Press  or  (or turn the  /  control on the unit).

- : Skips to the beginning of the next or succeeding tracks.
- : Goes back to the beginning of the current or previous tracks.

### To go to another group on an MP3 disc





When MP3 playback mode is the GROUP mode (see also page 17):

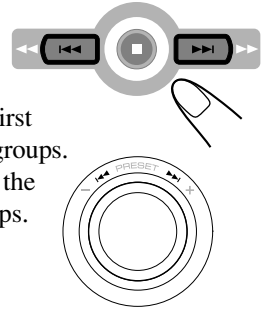

Press  or  (or turn the  /  control on the unit) before or during playback.

- : Skips to the beginning of the first track in the next or succeeding groups.
- : Goes back to the beginning of the first track in the previous groups.



### To locate a particular point in a track

During play, press and hold  or  (or press  or  on the unit).

- : Fast forwards the disc.
- : Fast reverses the disc.

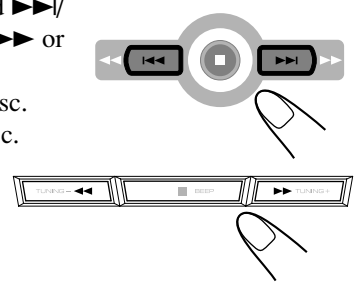

## To go to another track directly using the number buttons

Ex.: For track number 5, press 5.

For track number 15, press +10, then 5.

For track number 20, press +10, then 10.

For track number 32, press +10, +10, +10, then 2.

For track number 123, press +10 twelve times, then 3.

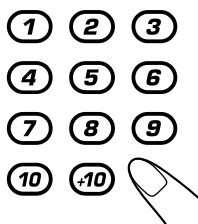

### For Audio CD:

Pressing the number button(s) before or during play allows you to start playing the selected track.

### For MP3 disc:

#### • When the MP3 playback mode is the TRACK mode

(See the right column.)

Pressing the number button(s) before or during play allows you to start playing the selected track on the disc.

#### • When the MP3 playback mode is the GROUP mode

(See the right column.)

Pressing the number button(s) before or during play allows you to start playing the selected track in the current album.



#### If your entry is ignored

You have tried to enter a track number that does not exist on the disc or in the album (for example, selecting track 14 in the album that only has 12 tracks). Such entries are ignored.

## Changing the MP3 Playback Mode

When playing an MP3 disc, you can choose the playback mode of the MP3 disc as follows:

#### • TRACK mode:

The unit recognizes only tracks (files). You can play an MP3 disc like an Audio CD.

#### • GROUP mode:

The unit recognizes tracks (files) and groups (folders) on an MP3 disc. You can play an MP3 disc according to the way how they are grouped.

In this mode, you can do the following operations:

- Pressing ►►/►► or ◀◀/◀◀ (or turning the ►►/◀◀ control on the unit) allows you to skip to the first track of the previous or next groups. (See page 16.)
- Pressing the number button(s) allows you to start playing the selected track in the current group. (See the left column.)

### On the remote control ONLY:

Press MP3.

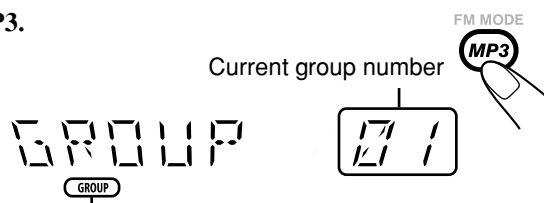

The GROUP indicator appears when the MP3 playback mode is the GROUP mode.

- Each time you press the button, the MP3 playback mode changes between “TRACK” and “GROUP” alternately.

## Turning On or Off the Resume Play for MP3 Disc

For MP3 disc, this unit can memorize the position on a disc where you interrupt playback. By pressing CD ►/||, you can start playback again from the interrupted position—Resume play.

You can turning on and off Resume play for MP3 discs.

### On the remote control ONLY:

Press SET/RESUME before or during playing an MP3 disc.



- Each time you press the button, Resume play turns on and off alternately.



The following operations will erase the memory of the interrupted position when—

- Pressing ▲ to eject the disc.
- Pressing one of the disc number buttons (or DISC SKIP on the unit) to change the disc to play.

## Programming the Playing Order of the Tracks —Program Play

You can arrange the order in which the tracks play before you start playing. **You can program up to 32 tracks.**



**Program play is not available to MP3 discs on this unit**

There may be a malfunction in case that you try to do such playback.

If a malfunction occurs, unplug the AC power cord and then plug it back in.

### On the remote control ONLY:

#### 1 Load discs.

- If the current playing source is not the CD player, press CD ►/II, then ■ before going to the next step.

#### 2 Press PROGRAM/RANDOM repeatedly until “PROGRAM” appears on the display.

The PROGRAM indicator also lights up on the display.

PROGRAM

TRACK

- If a program has been stored in memory, the program is called up.

#### 3 Press one of the disc number buttons (CD1, CD2, and CD3) to select the disc number you want to play.

- When the selected disc number is an MP3 disc, “MP3 DISC” appears on the display.

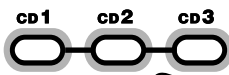

Disc number      Program step number

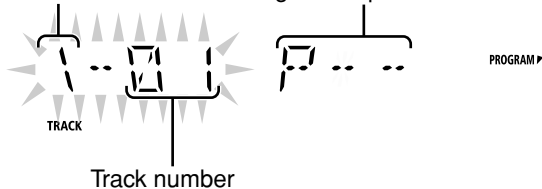

#### 4 Press the number button(s) to select the track number.

Ex.: For track number 5, press 5.

For track number 20, press +10, then 10.

For track number 32, press +10, +10, +10, then 2.

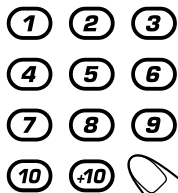

Each time you select a track, the selected track number is added to the track number indicator.

- You can select up to the 99th track on each disc.

1 - 14 P 1 1

TRACK

#### 5 Program other tracks you want.

- To program tracks from the same disc, repeat step 4.
- To program tracks from a different disc, repeat steps 3 and 4.

#### 6 Press CD ►/II.

The tracks are played in the order you have programmed.



To stop during play, press ■.

To exit from Program play, press ■ during play or PROGRAM/RANDOM again before or after play.

The unit enters continuous playback. (The program you have made is stored in memory until you turn off the unit, open the carousel, or erase the program.)

#### To modify the program

Before playing, you can erase the last programmed track shown on the display by pressing CANCEL.

- Each time you press the button, the last programmed track is erased from the program.



To add tracks in the program before play, simply select the disc numbers and/or track numbers you want to add by following steps 3 and 4 of the programming procedure.

To check the program before play, perform the following procedure:

1 Press PROGRAM/RANDOM while Program play is stopped.

2 Press ►► or ◀◀◀.

The programmed tracks appear on the display in the programmed (or reverse) order.

- Pressing CD ►/II starts Program play from the first track of the program.



**If you want to add tracks in the program after checking the program**

Press PROGRAM/RANDOM repeatedly until the PROGRAM indicator appears on the display, then add tracks by following steps 3 and 4 of the programming procedure.

To erase the entire program, press ■ while Program play is stopped.

- Turning the power off or ejecting the carousel will also erase the stored memory.



**If you try to add another track when 32 tracks are already programmed**

“FULL” appears on the display.



**If you have programmed a track from an empty tray, or a track number that does not exist on the disc**

Such program steps will be skipped and erased.



## Playing at Random—Random Play

The tracks of the selected CD will play at random.

- To use Random play, you have to cancel Program play.

### On the remote control ONLY:

**1** Load a CD.

**2** Press one of the disc number buttons (CD1, CD2, or CD3) for the disc you want to play, then press ■.

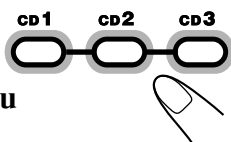

**3** Press PROGRAM/RANDOM repeatedly until “RANDOM” appears on the display.

The RANDOM indicator also lights up on the display.

- Activating Random play cancels Repeat play.
- For MP3 discs, activating Random play changes the GROUP mode to the TRACK mode. (See page 17.)



**4** Press CD ►/■.

The tracks are played automatically at random. Random play ends when all tracks are played once.

To stop and cancel Random play, press ■.

- Random play is also canceled when you press ▲.



If you press ►►/|/►► (or turn the ►►/|/◄◄ control on the unit to the right direction)

Playback skips to the next track selected randomly.

## Repeating Tracks or CDs—Repeat Play

You can have all the CDs, the program or the individual track currently playing repeat as many times as you like.

### On the remote control ONLY:

To repeat play, press REPEAT during or before playing.



- Each time you press the button, Repeat play mode changes as follows, and the following indicator lights up on the display:

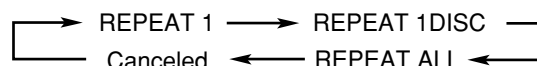

**REPEAT 1:** Repeats one track on one CD.

**REPEAT 1 DISC:** Repeats all the tracks on one CD.

**REPEAT ALL:** Repeats all the tracks on all the CDs.

To repeat play with Program Play or Random Play, press REPEAT when the PROGRAM or RANDOM indicator lights up on the display.

- For Program Play, programmed tracks are repeated.
- For Random Play, you can select only REPEAT 1 DISC.

To cancel Repeat play, press REPEAT repeatedly until the REPEAT indicator (REPEAT 1, REPEAT 1 DISC or REPEAT ALL) goes off from the display.

- Repeat play is also canceled in the following cases:
  - When you press ■ during playback or ▲.
  - When you turn off the unit.

## Prohibiting Disc Ejection—Carrousel Lock

You can prohibit disc ejection from the unit and lock the carrousel.

- This operation is possible only while the unit is on with “CD” selected as the source.

### On the unit ONLY:

To prohibit disc ejection, press ▲ for the carrousel while holding ■.

“LOCKED” appears for a while, and the carrousel is locked.



If you try to eject discs

“LOCKED” appears to inform you that the Carrousel Lock is in use.

To cancel the prohibition and unlock the carrousel, press ▲ for the carrousel while holding ■.

“UNLOCKED” appears for a while, and the carrousel is unlocked.



When you unplug the AC power cord or if a power failure occurs

The setting of the Carrousel Lock will return to the initial setting (not to prohibit disc ejection) in a few days.

There are two timers available—Daily Timer and Sleep Timer.  
Before using the timers, you need to set the clock built in the unit. (See “Setting the Clock” on page 10.)

## Using Daily Timer

With Daily Timer, you can wake to your favorite music or radio program. You can set the timer whether the unit is on or off.

### How Daily Timer actually works

The unit automatically turns on, set the volume level to the preset level, and starts playing the specified source when the on-time comes (the  indicator flashes while the timer is operating). Then, when the off-time comes, the unit automatically turns off (on standby).

Daily Timer works everyday unless you cancel it.

- There is a time limit in doing the following steps. If the setting is canceled before you finish, start from step 1 again.
- If you have made a mistake while setting timer, press CANCEL. (However, this does not always work. If CANCEL does not work, press CLOCK/TIMER repeatedly and start from step 1 again.)

#### Before you start...

- When using the tuner as the source to play:
  - Make sure to preset a station you want to play. (See page 13.)
- When using a disc as the source to play:
  - Make sure there is a disc you want to play on the currently selected disc number tray.
- When using the external component as the source to play:
  - Set the timer equipped with the external component at the same time.

### On the remote control ONLY:

#### 1 Press CLOCK/TIMER repeatedly until “DAILY” appears on the display.

The  indicator lights up and the DAILY (daily timer) indicator starts flashing on the display.



- Each time you press the button, the clock/timer setting modes change as follows:

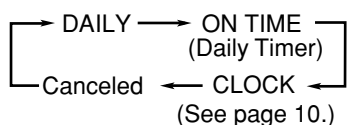

#### 2 Press CLOCK/TIMER again.

“ON TIME” appears for 1 second, then the unit enters on-time setting mode.



#### 3 Set the on-time you want the unit to turn on.

- 1) Press / or / to set the hour, then SET/RESUME.
- 2) Press / or / to set the minute, then SET/RESUME.  
“OFF TIME” appears for 1 second, then the unit enters off-time setting mode.

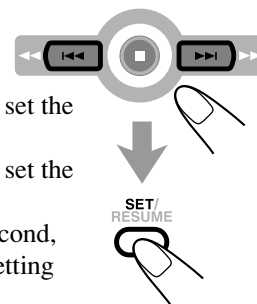

#### 4 Set the off-time you want the unit to turn off (on standby).

- 1) Press / or / to set the hour, then SET/RESUME.
- 2) Press / or / to set the minute, then SET/RESUME.  
The unit enters source selecting mode.

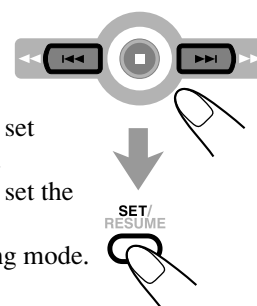

#### 5 Press / or / to select the source to play, then SET/RESUME.

- Each time you press / or /, the source changes as follows:

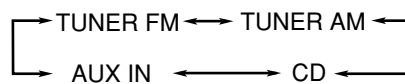

**TUNER FM** : tunes in to a specified preset FM station.  
→ go to step 6.

**TUNER AM** : tunes in to a specified preset AM station.  
→ go to step 6.

**CD\*** : plays a disc on a specified disc tray from the first track.  
→ go to step 6.

**AUX IN** : plays an external source.  
→ go to step 7.

\* If the selected disc tray is empty, the next disc tray is selected. If all the disc trays are empty, the last tuned FM or AM station is selected.



**6** Press **▶▶/▶▶** or **◀◀/◀◀** to select the preset station number or disc tray number, then **SET/RESUME**.

- Select “P- -” or “DISC -” for the last selected station or disc tray number. The unit enters volume setting mode.

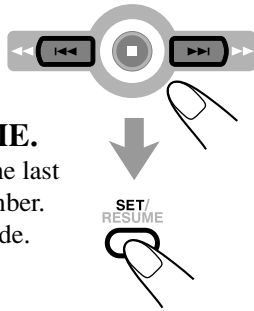

**7** Press **▶▶/▶▶** or **◀◀/◀◀** to set the volume level.

- You can select the volume level from VOL 00 to VOL 31, and VOL MAX.

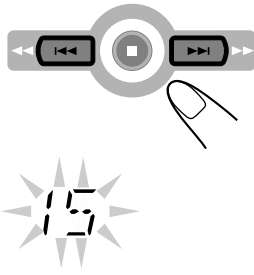

**8** Press **SET/RESUME** to complete the Daily Timer setting.

The DAILY (daily timer) indicator stops flashing and remains lit.



**9** Press **STANDBY/ON** to turn off the unit (on standby) if you have set the Daily Timer with the unit turned on.

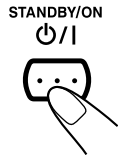

If the unit is turned on when the timer-on time comes Daily Timer does not work.

### To turn on or off Daily Timer after its setting is done

**1** Press **CLOCK/TIMER** repeatedly until “DAILY” appears on the display.



**2** To turn off the Daily Timer, press **CANCEL**.

The DAILY (daily timer) indicator goes off from the display (“OFF” appears for a while). The Daily Timer is canceled, but the setting for the Daily Timer remains in memory until you change it.



To turn on the Daily Timer, press **SET/RESUME**.

“ON” appears on the display and the DAILY (daily timer) indicator lights up on the display.



## Using Sleep Timer

With Sleep Timer, you can fall asleep to music. You can set Sleep Timer when the unit is turned on.

### How Sleep Timer actually works

The unit automatically turns off after the specified time length passes.

### On the remote control ONLY:

**1** Press **SLEEP**.

The time length until the shut-off time appears and the SLEEP indicator starts flashing on the display.

- Each time you press the button, the time length changes as follows:

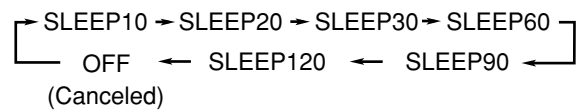

**2** Wait for about 3 seconds after specifying the time length.

The SLEEP indicator stops flashing and remains lit.

To check the remaining time until the shut-off time, press SLEEP once so that the remaining time until the shut-off time appears for about 3 seconds.

To change the shut-off time, press SLEEP repeatedly until the desired time length appears on the display.

To cancel the setting, press SLEEP repeatedly until “OFF” appears on the display so that the SLEEP indicator goes off from the display.

- Sleep Timer is also canceled when you turn off the unit.



While Daily Timer is working Sleep Timer does not work.



# Troubleshooting



If you are having a problem with your unit, check this list for a possible solution before calling for service.

If you cannot solve the problem from the hints given here, or the unit has been physically damaged, call a qualified person, such as your dealer, for service.

Symptom	Cause	Action
Unable to cancel the display demonstration.	Other buttons are pressed to cancel the display demonstration.	Press DEMO on the unit. (See page 8.)
No sound is heard.	Connections are incorrect or loose.	Check all connections and make corrections. (See pages 6 to 9.)
No sound from PC connected with a USB cable.	An electrical shock is applied to the unit, PC, or USB cable. "Mute" is selected on the PC.	Turn off the receiver once, then turn it on again and restart application installed in the PC. Check if the volume is set at low level. Refer to the manuals supplied with your PC.
Noise while reproducing PC sound connected with a USB cable.	Strong electromagnetic wave is emitted from a nearby device such as TV.	Move the PC away from the device such as TV emitting strong electromagnetic wave.
Sound from PC connected with a USB cable is intermittent.	PC is subjected to excessive load due to using other applications.	Close the applications you do not use.
Hard to listen to broadcasts because of noise.	<ul style="list-style-type: none"> <li>Antennas are disconnected.</li> <li>The AM loop antenna is too close to the unit.</li> <li>The FM antenna is not properly extended and positioned.</li> </ul>	<ul style="list-style-type: none"> <li>Reconnect the antennas correctly and securely.</li> <li>Change the position and direction of the AM loop antenna.</li> <li>Extend the FM antenna at the best position.</li> </ul>
The disc sound is discontinuous.	The disc is scratched or dirty.	Clean or replace the disc. (See page 23.)
The carrousel does not open or close.	<ul style="list-style-type: none"> <li>The AC power cord is not plugged in.</li> <li>The carrousel is locked.</li> </ul>	<ul style="list-style-type: none"> <li>Plug the AC power cord.</li> <li>Unlock the carrousel. (See page 19.)</li> </ul>
The disc does not play.	The disc is placed upside down.	Place the disc with the label side up.
The MP3 disc does not play.	<ul style="list-style-type: none"> <li>No MP3 files are recorded on the disc.</li> <li>MP3 files do not have the file extension—.MP3, .Mp3, .mP3, or .mp3 in their file names.</li> <li>MP3 files are not recorded in the format compliant with ISO 9660 Level 1 or Level 2.</li> </ul>	Replace the disc.
The readout time of the MP3 disc is too long.	The readout time varies with the complexity of the recording configuration.	Do not use too many hierarchies and folders when recording. Also, do not record any other types of audio tracks together with MP3 files. (See page 14.)
Operations are disabled.	The built-in microprocessor may malfunction due to external electrical interference.	Unplug the AC power cord and then plug it back in.
Unable to operate the unit from the remote control.	<ul style="list-style-type: none"> <li>The path between the remote control and the remote sensor on the unit is blocked.</li> <li>The batteries are exhausted.</li> </ul>	<ul style="list-style-type: none"> <li>Remove the obstruction.</li> <li>Replace the batteries.</li> </ul>

# Maintenance



To get the best performance of the unit, keep your discs, tapes, and mechanism clean.

## Cleaning the unit

### • Stains on the unit

Should be wiped off with a soft cloth. If the unit is heavily stained, wipe it with a cloth soaked in water-diluted neutral detergent and wrung well, then wipe clean with a dry cloth.

### • Avoid the following since they may cause damage to the unit.

- DO NOT wipe it with a hard cloth.
- DO NOT wipe it strong.
- DO NOT wipe it with thinner or benzine.
- DO NOT apply any volatile substance such as insecticides to it.
- DO NOT allow any rubber or plastic to remain in contact with it for a long time.

## Handling discs

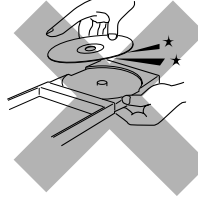

- Remove the disc from its case by holding it at the edge while pressing the center hole lightly.
- Do not touch the shiny surface of the disc, or bend the disc.
- Put the disc back in its case after use to prevent warping.

- Be careful not to scratch the surface of the disc when placing it back in its case.
- Avoid exposure to direct sunlight, temperature extremes, and moisture.

### To clean the disc

Wipe the disc with a soft cloth in a straight line from center to edge.



**DO NOT** use any solvent—such as conventional record cleaner, spray, thinner, or benzine—to clean the disc.

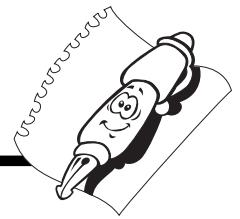

## Amplifier section—CA-MXGC5

Output Power (IEC268-3)

SUBWOOFERS : 95 W per channel, min. RMS, driven into 6  $\Omega$  at 63 Hz with no more than 10% total harmonic distortion.

MAIN SPEAKERS : 42 W per channel, min. RMS, driven into 6  $\Omega$  at 1 kHz with no more than 10% total harmonic distortion.

Audio input sensitivity/Impedance

(at 1 kHz, measured at MAIN SPEAKERS)

AUX : 400 mV/50 k $\Omega$

USB : USB Ver. 1.1

Speakers/Impedance:

Subwoofers : 6  $\Omega$  – 16  $\Omega$

Main speakers : 6  $\Omega$  – 16  $\Omega$

## Tuner

FM tuning range : 87.50 MHz – 108.00 MHz

AM tuning range : 522 kHz – 1 710 kHz

## CD player

CD Capacity : 3 CDs

Dynamic range : 85 dB

Signal-to-noise ratio : 85 dB

Dimensions (approx.) : 270 mm x 305 mm x 490 mm (W/H/D)

Mass (approx.) : 8.3 kg

## Speaker section—SP-MXGC5

Type : 3-way bass-reflex type

Speaker units : Subwoofer: 16 cm cone x 1

Main Woofer: 12 cm cone x 1

Tweeter: 5 cm cone x1

Power handling capacity : Subwoofer: 160 W

Main speaker: 70 W

Impedance : Subwoofer: 6  $\Omega$

Main speaker: 6  $\Omega$

Frequency range : Subwoofer: 25 Hz — 150 Hz

Main speaker: 150 Hz — 20 000 Hz

Sound pressure level : Subwoofer: 78 dB/W•m

Main speaker : 87 dB/W•m

Dimensions (approx.) : 242 mm x 454 mm x 315 mm (W/H/D)

Mass (approx.) : 6.2 kg each

## General

Power requirement : AC 240 V $\sim$ , 50 Hz

Power consumption : 200 W (at operation)

20 W (on standby)

1.2 W (in ECO mode)

## Supplied accessories

See page 6.

**JVC**



## Free Manuals Download Website

<http://myh66.com>

<http://usermanuals.us>

<http://www.somanuals.com>

<http://www.4manuals.cc>

<http://www.manual-lib.com>

<http://www.404manual.com>

<http://www.luxmanual.com>

<http://aubethermostatmanual.com>

Golf course search by state

<http://golfingnear.com>

Email search by domain

<http://emailbydomain.com>

Auto manuals search

<http://auto.somanuals.com>

TV manuals search

<http://tv.somanuals.com>