

# KENWOOD

MULTIPLE COMPACT DISC PLAYER

**DPF-J3030**  
**CD-423M**

---

## INSTRUCTION MANUAL

KENWOOD CORPORATION

**This unit is designed for home use only. If the unit is used in a location other than at home, such as in a shop (for commercial use), in a car or in a ship, etc., and is damaged, a service fee may be charged even during the warranty period.**

**This instruction manual is used to describe multiple models listed above.  
Model availability and features (functions) may differ depending on the country and sales area.**



B60-4446-08 (EN)

# Before applying power

 **Caution : Read this page carefully to ensure safe operation.**





2

Units are designed for operation as follows.

- U.S.A. and Canada ..... **AC 120 V only**
- Europe and U.K. .... **AC 230 V only**

## Safety precautions

**WARNING :** TO PREVENT FIRE OR ELECTRIC SHOCK, DO NOT EXPOSE THIS APPLIANCE TO RAIN OR MOISTURE.

	<b>CAUTION</b> RISK OF ELECTRIC SHOCK DO NOT OPEN		CAUTION: TO REDUCE THE RISK OF ELECTRIC SHOCK, DO NOT REMOVE COVER (OR BACK). NO USER-SERVICEABLE PARTS INSIDE. REFER SERVICING TO QUALIFIED SERVICE PERSONNEL.
	THE LIGHTNING FLASH WITH ARROWHEAD SYMBOL, WITHIN AN EQUILATERAL TRIANGLE, IS INTENDED TO ALERT THE USER TO THE PRESENCE OF UNINSULATED "DANGEROUS VOLTAGE" WITHIN THE PRODUCT'S ENCLOSURE THAT MAY BE OF SUFFICIENT MAGNITUDE TO CONSTITUTE A RISK OF ELECTRIC SHOCK TO PERSONS.		
	THE EXCLAMATION POINT WITHIN AN EQUILATERAL TRIANGLE IS INTENDED TO ALERT THE USER TO THE PRESENCE OF IMPORTANT OPERATING AND MAINTENANCE (SERVICING) INSTRUCTIONS IN THE LITERATURE ACCOMPANYING THE APPLIANCE.		

### The marking of products using lasers (Except for some areas)



The marking is located on the rear panel and says that the component uses laser beams that have been classified as Class 1. It means that the unit is utilizing laser beams that are of a weaker class. There is no danger of hazardous radiation outside the unit.

## Special features

### CD player with 200-disc changer

#### Title registerable

#### Filing functions suitable for a 200-disc changer

#### Low standby power consumption

This unit can accommodate up to 200 discs and can be used like a home jukebox.

In case of a disc not corresponding to CD-TEXT, you can register a disc title or other information. → 20

Disc search is possible by specifying the initial letter of the desired disc title. → 29

An enhanced filing function is provided to handle the large disc capacity.

Music type: Discs are filed by 26 music genres. → 23



8 user files: Discs can be registered in up to 8 user files. User files can be named as desired. → 27

Best selection: Only favorite tracks can be registered and played. → 32

The power consumption during standby is no more than 2 W.

## Contents

Caution : Read the pages marked  carefully to ensure safe operation.

 <b>Before applying power</b> .....	<b>2</b>	<b>Listening to music by genre (MUSIC TYPE mode)</b> .....	<b>23</b>
 Safety precautions .....	2	Registration of music type (MUSICTYPE SET mode) ...	23
Special features .....	3	Playing the music type (MUSIC TYPE PLAY mode) .....	24
<b>Quick-Start Guide</b> .....	<b>5</b>	<b>Reorganizing discs to desired groups</b>	
<b>System connections</b> .....	<b>6</b>	(USER FILE mode) .....	<b>25</b>
<b>Controls and indicators</b> .....	<b>8</b>	Registration of user file (USER FILE SET mode) .....	25
<b>Operation of remote control unit</b> .....	<b>9</b>	Playing the user file (USER FILE PLAY mode) .....	26
Loading batteries .....	9	Assigning user file names (FILE NAME INPUT mode) ...	27
Operation .....	9	To clear the user file (USER FILE CLEAR mode) .....	28
<b>Preparation</b> .....	<b>10</b>	<b>Disc search (DISC SEARCH mode)</b> .....	<b>29</b>
Loading discs in the carousel .....	10	Searching a disc by the disc title	
<b>Normal play (TRACK mode)</b> .....	<b>12</b>	(Charac.SEARCH mode) .....	29
Playing tracks in order from track No.1 .....	12	Searching the music type (M.TYPE SEARCH mode) ....	30
Playback from desired track .....	14	Searching the user file (U.FILE SEARCH mode) .....	31
<b>Displays</b> .....	<b>15</b>	<b>Listening to your favorite titles</b>	
<b>Programming tracks in desired order (PGM mode)</b> ...	<b>16</b>	(BEST SELECTION mode) .....	<b>32</b>
<b>Repeated playback (REPEAT mode)</b> .....	<b>18</b>	Registration of best selection file .....	32
<b>Playback in a random order (RANDOM mode)</b> .....	<b>19</b>	Playing the best selection file .....	32
<b>Registration of Title</b> .....	<b>20</b>	<b>Timer operation</b> .....	<b>33</b>
Assigning Title (TITLE INPUT mode) .....	20	<b>Important items</b> .....	<b>34</b>
To change or delete a title .....	22	<b>In case of difficulty</b> .....	<b>35</b>
		<b>Specifications</b> .....	<b>36</b>

4

**Unpacking**

Unpack the unit carefully and make sure that all accessories are put aside so they will not be lost. Examine the unit for any possibility of shipping damage. If your unit is damaged or fails to operate, notify your dealer immediately. If your unit was shipped to you directly, notify the shipping company without delay. Only the consignee (the person or company receiving the unit) can file a claim against the carrier for shipping damage. We recommend that you retain the original carton and packing materials for use should you transport or ship the unit in the future.

**Keep this manual handy for future reference.**

**Accessories**

Audio cord ..... (1)

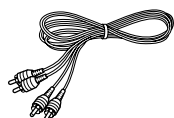

System control cord ..... (1)

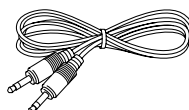

Remote control unit ..... (1)

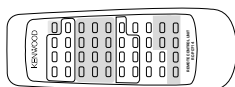

Batteries (R6/AA) ..... (2)



## Naming Discs

Discs can be given disc names up to 25 characters.

Although the most convenient time to enter disc names is when you insert the discs into the player for the first time, (that way the player keeps track of the disc names for you as you insert the discs), you can use this procedure to enter or change disc names any time you want.

*These instructions explain how to enter disc names when you insert the discs into the player for the first time.*

**1** Open the loading door and leave it open for this entire operation.

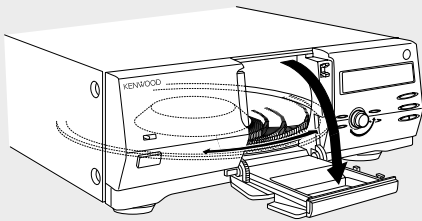

**2** Select an empty disc slot.

Enter the disc number directly on the numeric keys,

then press **SET**.

**OR:**

Use the **DISC SKIP(DOWN/UP)** keys to select the disc.

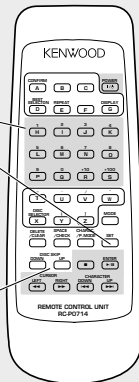

The disc tray will rotate so that the slot is in the loading position, and the display will show the disc number:

DISCXX

**3** Insert a CD in the empty slot. Make sure the label faces towards your right.

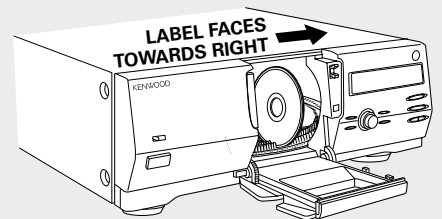

**4** Enter the disc name.

**1.** Press **MODE**.

Use the **DISC SKIP(DOWN/UP)** to select title input mode.

The display flashes:  
TITLE INPUT

**2.** Press **SET**.

The display reads:

D— SELECT

then the disc number you selected will flash:  
DXXX

**3.** Press **SET** again. The display will stop flashing and will change to the alpha-numeric character display:

+ZABC

**4.** Use the character keys to select characters.

**5.** If you make a mistake, use **DELETE/CLEAR** to erase your last entry.

**6.** Use **SPACE/CHECK** to enter spaces.

**7.** Use **CHARAC./P.MODE** to shift between capital letters, lowercase letters and numbers/symbols.

**8.** The selected character flashes on the display. (You can also use the **CHARACTER(DOWN/UP)** to select characters. After selecting each character, press **SET** to enter it.)

**9.** Press **ENTER**.

The display reads:  
TITLE STORE!!

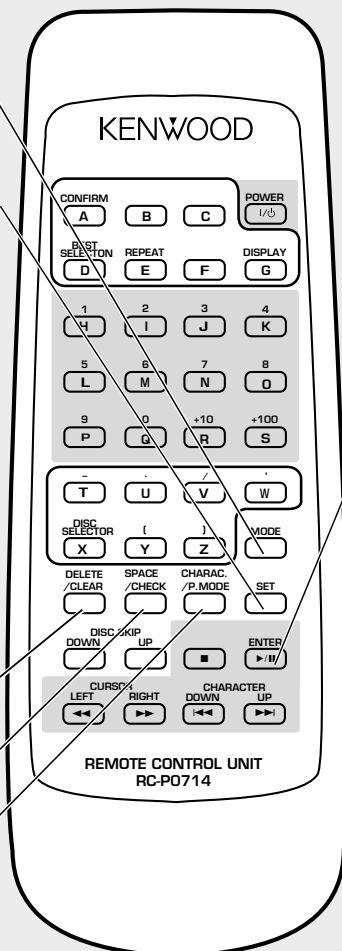

# System connections

6

Make connections as shown below. When connecting the related system components, refer also to the instruction manuals of the related components. Do not plug in the power lead until all connections are completed.

## Malfunction of microcomputer

If operation is not possible or erroneous display appears even though all connections have been made properly, reset the microcomputer referring to "In case of difficulty". → 35

Be sure to use this unit placed on a level surface.

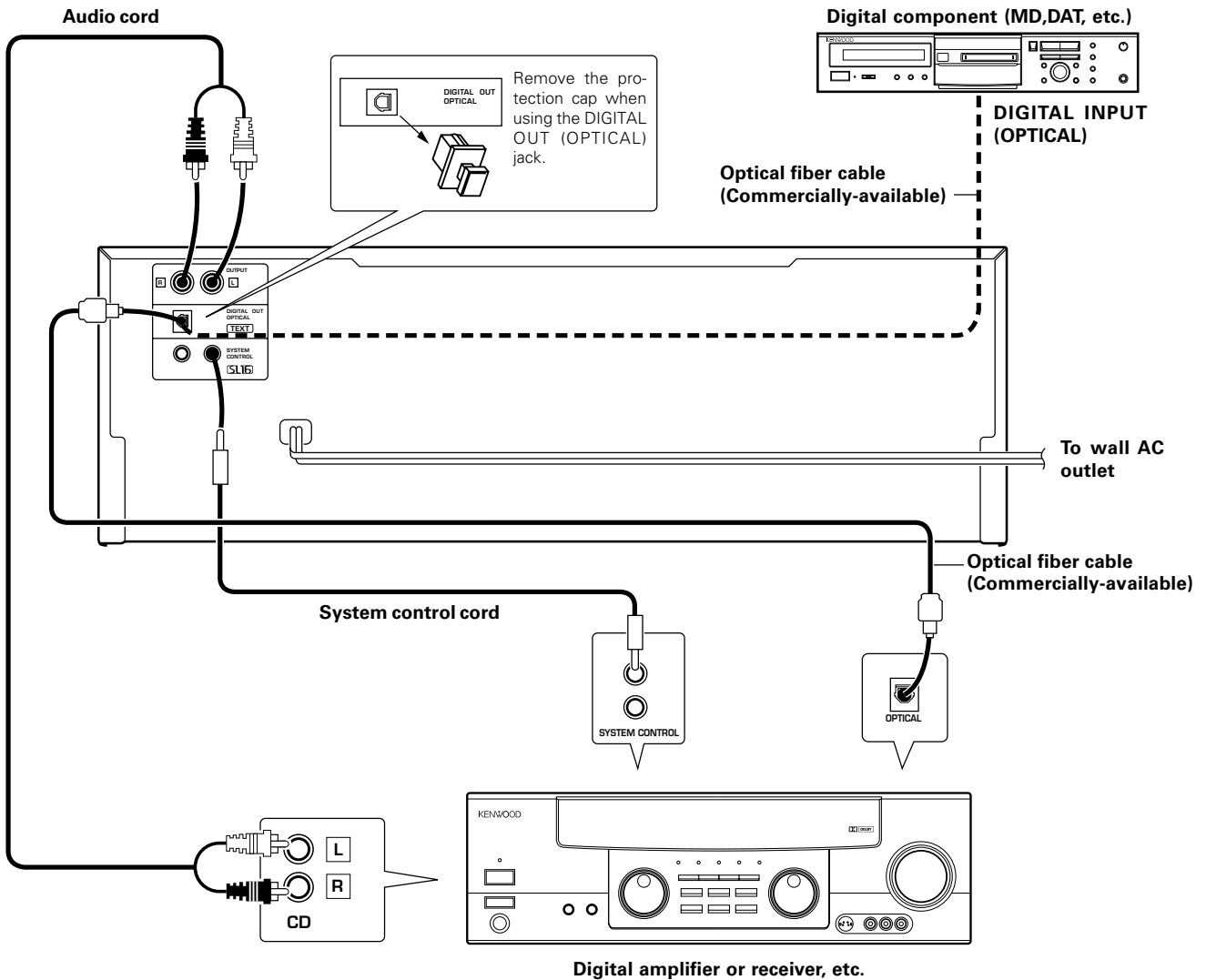

## DTS Disclaimer clause

When playing DTS-encoded CDs, excessive noise will be exhibited from the analog stereo outputs. To avoid possible damage to the audio system, the consumer should take proper pre-cautions when the analog stereo outputs of the CD player is connected to an amplification system. To enjoy DTS Digital Surround™ playback, an external 5.1 channel DTS Digital Surround™ decoder system must be connected to the digital output (S/PDIF, AES/EBU, or TosLink) of the CD player.



1. Connect all cords firmly. If connections are loose, there could be loss of sound or noise produced.
2. When plugging and unplugging connection cords, be sure to first remove the power cord from the AC outlet. Plugging/unplugging connection cords without removal of the power cord can cause malfunctions or damage to the unit.

### Connection to digital amplifier or MD

Connect the **DIGITAL OUT (OPTICAL)** jack to the digital input jack of the amplifier, DAT recorder, MD recorder, etc., using an optical fiber cable which is commercially available in audio stores.

- When using an optical fiber cable to connect this unit to a digital amplifier, insert the plug straight into the jack until a snap sound is heard.
- Be careful not to bend, coil, or bundle the optical fiber cable.
- Optical fiber cables available on the market may not always be able to be used with this player. If your cord cannot be used with this unit, consult the store from which you purchased the cord or your nearest dealer.

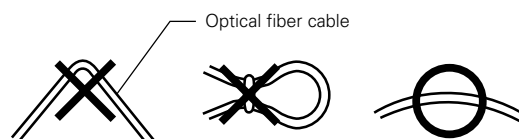

### Connection to a general-use amplifier

Use the provided audio cords to connect the **OUTPUT** jacks of this unit to the **CD input jacks (or AUX jacks)** of the amplifier.

#### System control connections

Connecting system control cords after connecting a **KENWOOD** audio component system lets you take advantage of convenient system control operations.

This unit is compatible only with the **[SL16]** mode. The system control operation is not available if the unit is connected in the **[XS8]** connection mode.

If your component has the mode select switch, set the connected components to the **[SL16]** mode.

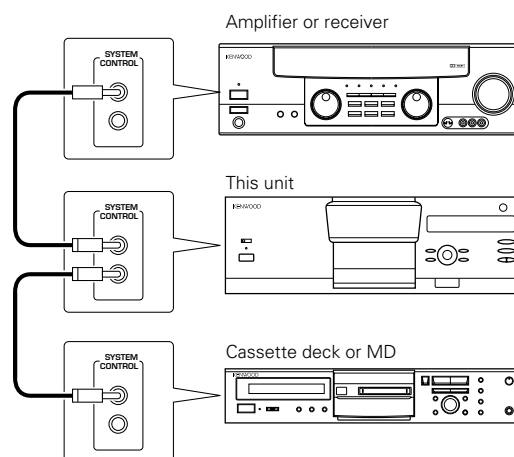

- You can connect the system control cord to either system control jack of the unit.
- Do this operation after completing all connections. (Ensure that the power plug is not connected.)



1. If your amplifier or receiver does not have a system control terminal, do not connect any system control cords to the system control terminals on the other components.
2. Do not connect system control cords to any components other than those specified by KENWOOD. It may cause a malfunction and damage your unit.
3. Be sure the system control plugs are inserted all the way in to the system control terminals.

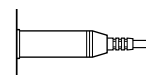

#### System control operations

##### Remote Control

Lets you operate this unit with the system remote control unit supplied with the amplifier or receiver.

##### Automatic Operation

Automatically switches the input selector on the amplifier or receiver when you start playback from this unit.

##### Synchronized Recording

Lets you synchronize recording with the start of playback when recording from a CD. Also, the simple CCRS operation enables great recordings from CDs.

See the operating instructions supplied with your cassette deck for details.

# Controls and indicators

8

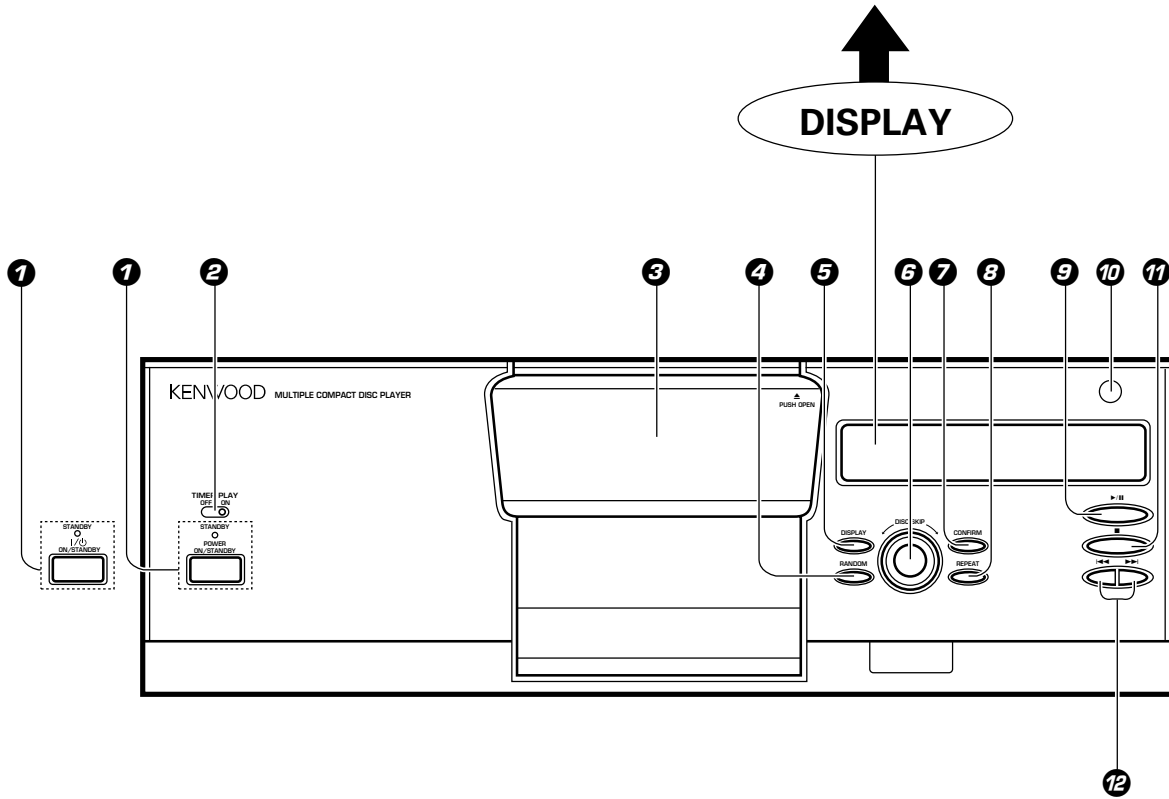
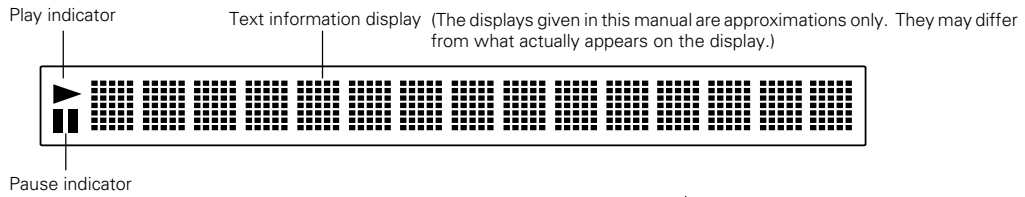

**1 POWER key/STANDBY indicator (For the U.S.A. and Canada)**  
**1 | / ⏻ key/STANDBY indicator (For other countries)**

**2 TIMER PLAY switch**  
 Used for timer play ON/OFF.

**3 Door panel**

**4 RANDOM key**  
 Press to start random playback.

**5 DISPLAY key**  
 Switching between title display and time display.

**6 DISC SKIP knob**  
 Used for disc selection. Characters are selected at the time of character input.

**7 CONFIRM key**  
 The present playback mode is displayed.

**8 REPEAT key**  
 Press to start repeated playback.

**9 Play/Pause key (▶/⏸)**

**10 Remote control light sensor**

**11 Stop key (■)**

**12 Skip keys (◀◀ ▶▶)**  
 Press to skip to the beginning of another track. Characters are selected at the time of character input.

## Standby mode

While the standby indicator of the unit is lit, a small amount of current is flowing into the unit's internal circuitry to back up the memory. This condition is referred to as the standby mode of the unit. While the unit is in the standby mode, it can be turned ON from the remote control unit.



# Operation of remote control unit

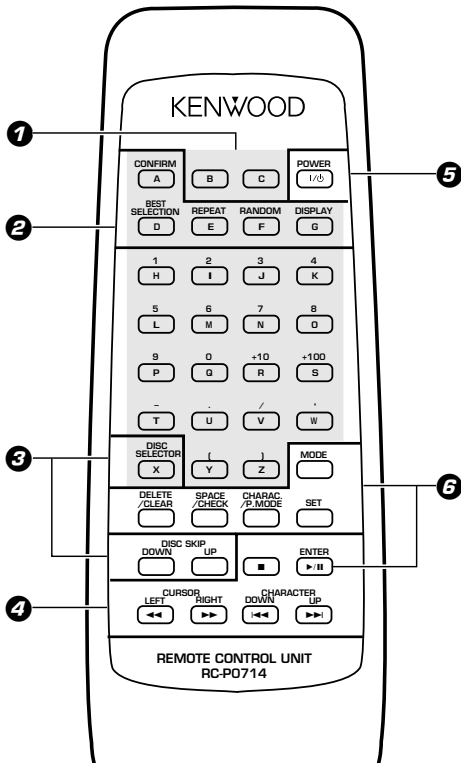

Model: RC-P0714  
Infrared ray system

The keys with the same name as those on the main unit operate the same way as on the main unit. The keys marked \* are provided only on the remote control unit.

<p><b>1 Input keys for numbers and letters *</b> Used for selection of disc numbers and track numbers, as well as for character input.</p>	<p><b>5 POWER (I/⏻) key</b></p>
<p><b>2 Keys related to playback mode and display</b> <b>CONFIRM key</b> * <b>BEST SELECTION key</b> Used for best selection registration and playback. <b>REPEAT key</b> <b>RANDOM key</b> <b>DISPLAY key</b></p>	<p><b>6 Keys related to program and file registration</b></p>
<p><b>3 Disc selection keys</b> * <b>DISC SELECTOR key</b> Press to select a disc number. <b>DISC SKIP(DOWN/UP) keys</b></p>	<p>* <b>MODE key</b> Press to switch the mode. * <b>SET key</b> Used for confirmation of mode settings. At the time of character input, one character is confirmed and the cursor goes to the next digit. * <b>ENTER key</b> Used for title confirmation. * <b>CHARAC./P.MODE key</b> Used for playback mode switching. At the time of character input, this key switches between capital letters/small letters/numbers and special characters.</p>
<p><b>4 Keys for basic operation and character input</b> <b>Stop(■) key</b> <b>ENTER; Play/pause(▶/⏸) key</b> <b>CHARACTER (DOWN/UP); Skip (◀◀/▶▶) keys</b> * <b>CURSOR(LEFT/RIGHT); Search(◀◀/▶▶) keys</b> Press to move the played position of disc at high speed. Used as cursor keys at the time of character input.</p>	<p>* <b>SPACE/CHECK key</b> Used to confirm the entered contents. Inserts a space at the time of character input. * <b>DELETE/CLEAR key</b> Used to delete the entered contents. At the time of character input, characters are deleted.</p>

## Loading batteries

**1 Remove the cover.**

**2 Insert batteries.**

**3 Close the cover.**

● Insert two AA-size (R6) batteries as indicated by the polarity marking.

## Operation

**After plugging in the power cord, press the POWER (I/⏻) key of the main unit to turn the power ON. When the power is turned ON, press the key of the function to be operated.**

● When pressing more than one remote control key successively, press the keys securely by leaving an interval of 1 second or more between keys.

Remote control light sensor  
6m

**Operating range (approx.)**



1. The supplied batteries are intended for use in operation checks. Therefore, their lives may be shorter than ordinary batteries.
2. When the remote-controllable distance gets shorter than before, replace both batteries with new ones.
3. Malfunction may occur if direct sunlight or the light of a high-frequency lighting fluorescent lamp enters the remote control light sensor. In such a case, change the system installation position to prevent the malfunction.

# Preparation

10

Up to 200 CDs can be loaded in the carousel. Disc exchange also is possible during playback.

Never let your hand or any object enter inside the unit.

## Loading discs in the carousel

### 1 Switch power ON.

Press the POWER (I/⏻) key.

Main unit

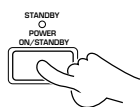

### 2 Open the door panel toward the front.

Press PUSH OPEN at the right top of the door panel.

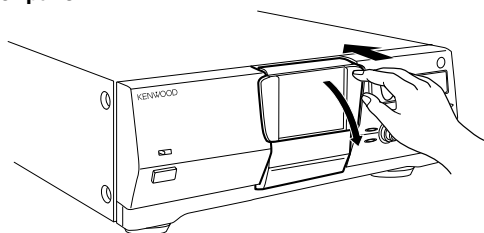

### 3 Load discs.

1 Turn the DISC SKIP knob and bring the slot with the disc to be placed to the front.

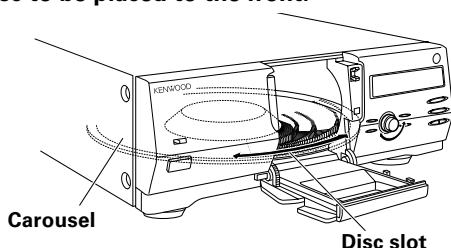

2 Insert the disc vertically.

Insert CDs with the label side facing toward your right.

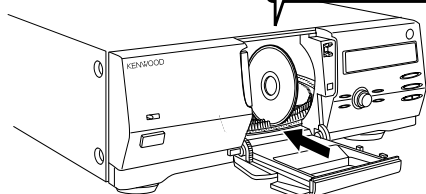

Insert one CD per slot all the way.

3 Repeat 1 and 2 to insert discs.

- Do not place any object on the open door panel.

DISC001

The slot No. is displayed when the DISC SKIP knob is turned.



Insert discs with the label on the right side. Playback is not possible when a disc is inserted the other way round.

- Do not insert more than one disc in a slot.
- When a disc not corresponding to CD-TEXT is inserted, searching for this disc will be facilitated when the title is registered at the time of disc insertion.

"Registration of Title "

### Disc replacement

Discs can be replaced with the same procedure as "Loading discs in the carousel". In stopped condition, all discs can be exchanged. However, when the door panel is opened while "DISC DETECTION" is being displayed, it may not be possible to remove the disc which had been played. Accordingly, wait for the "DISC DETECTION" indication to go out before opening the door panel. When the disc information has been read in at the time of registration of disc information like title, music type, etc., the disc information can be recalled even when the disc insertion place is changed.



### 4 Close the door panel.

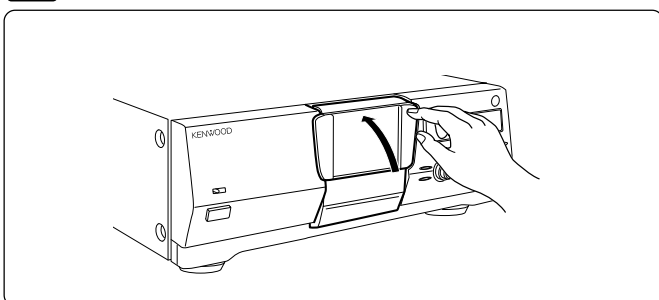

- When a title has been registered and the door panel is closed, reading operation is performed automatically.

The display flashes.

DISC DETECTION

### In regard to ALL DATA READ mode

The disc information for all discs will be read. We recommend to execute this mode before playback after discs have been exchanged. Close the door panel before operation.

- 1 Press the MODE key.



- 2 Select "ALL DATA READ".

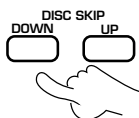

- 3 Set the input.



Each press switches the modes as follows:

- 1 MUSIC TYPE
- 2 USER FILE
- 3 DISC SEARCH
- 4 TITLE INPUT
- 5 ALL DATA READ
- 6 ALL INFORMATION

ALL DATA READ

Search in progress or reading information The display flashes.

DISC READING

When the disc is CD-TEXT

D001 : CD TEXT

- Repeat the above procedure so that the complete disc information is read into the CD player.
- In the case of a non-CD-TEXT disc, the "D001:NO CD TEXT" display will appear for approx. 3 seconds.

**To quit ALL DATA READ mode**

Press the ■ key.



1. Please remove all CDs from the carousel before moving the unit.
2. If blinking "PLEASE WAIT" is displayed when the door panel is opened, do not attempt to change the disc.

## Playing tracks in order from track No.1

Use the following procedure to play a CD in the original order of tracks from track No.1.

### 1 Select the disc.

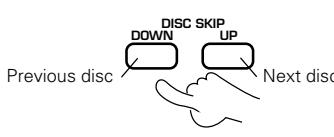

Go to step 2 within 8 sec.

- Each press of a key increases (or decreases) the disc number. Holding the key depressed varies the disc numbers successively.
- When the disc corresponds to CD-TEXT, or when the disc title has been registered, the disc title will be displayed with scrolling. Discs can be selected by the disc title.  
"Registration of Title" → 

Display when disc No. 123 is selected

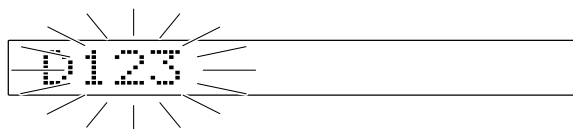

### 2 Start playback.



### To pause playback



### To stop playback



- Each press pauses and plays the CD alternately.

### Direct disc selection

1 Press the DISC SELECTOR key.



Within 8 seconds!

2 Input the disc number.

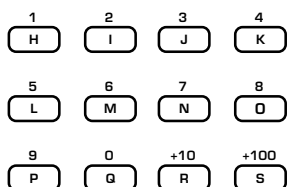

Within 8 seconds!

3 Start playback.



Press the numeric keys in the following order...

Disc No. 63 : 6, 3  
Disc No. 100 : 1, 0, 0

#### How to input numeric values

The input method for this product is of two different types. One can either use the traditional KENWOOD +10 key approach, or direct numeric input.

#### Special input method for CD player with 200-disc changer

To input 42 : 4, 2  
To input 115 : 1, 1, 5  
To input 200 : 2, 0, 0

#### Same input method as other KENWOOD products

To input 42 : +10, +10, +10, +10, 2  
To input 115 : +100, +10, 5  
To input 200 : +100, +100

### What is the "normal play TRACK mode"?

Playback is made from the first track. The normal playback mode is called TRACK mode. Press the CONFIRM key to confirm the present mode.



TRACK mode



PGM mode



BEST SELECTION mode

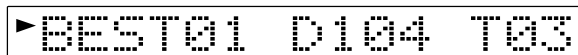

MUSIC TYPE mode



USER FILE mode

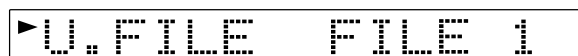

RANDOM mode

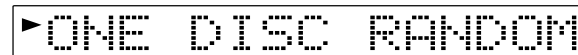

REPEAT mode



### To set the unit to the TRACK mode:

At the time of PGM mode :

Press the PMODE key.



At the time of BEST SELECTION mode :

Press the ■ key during playback.



At the time of MUSIC TYPE mode or USER FILE mode :

Press the MODE key.



At the time of RANDOM mode :

Select "RANDOM OFF".



At the time of REPEAT mode :

Select "REPEAT OFF".



## Playback from desired track

### 1 Select the disc.

**1 Select the disc number.**

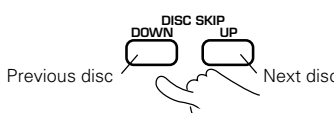

Previous disc      Next disc

Within 8 seconds!

**2 Set the input.**

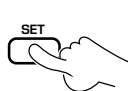

Go to step 2 within 8 sec.

#### Display when disc No. 123 is selected

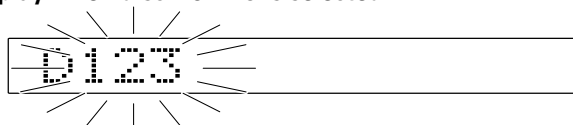

- The disc number can be selected directly by using the **DISC SELECTOR** key and numeric keys in place of the **DISC SKIP (DOWN/UP)** keys.
- When the disc corresponds to CD-TEXT, or when the disc title has been registered, the disc title will be displayed with scrolling. Discs can be selected by the disc title.
- Repeat step 1 when it is required to change the disc number. 

### 2 Select the track number.

**1 Input the track number.**

1 H	2 I	3 J	4 K
5 L	6 M	7 N	8 O
9 P	0 Q	+10 R	+100 S



Within 8 seconds!

**2 Set the input.**



#### Press the numeric keys in the following order...

- Track No.8 : 8
- Track No.14 : 1, 4
- Track No.20 : 2, 0

#### Display when track No. 8 is selected

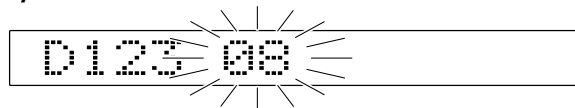

- Playback starts.
- When the disc corresponds to CD-TEXT, the track title is displayed. Tracks can be selected by the track title.
- Repeat step 2 when it is required to change the track number.

## Skipping tracks

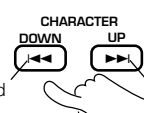

To skip backward      To skip forward

- When the  key is pressed once during playback, the track being played will be played from the beginning.

## Searching

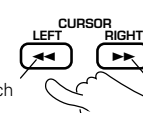

Backward search      Forward search

- Playback starts from the position where the key is released.

## Displays scrolling

Some track titles contain so much text information that the full titles will not fit on the display. In cases like this, the letters on the display move from right to left so that the non-visible part of the title is revealed. This type of display movement is known as "scrolling of display."

Display example

← Scroll display

D123 GOOD OLD FASHION...  
D123 FASHIONED



In the case of a CD-TEXT disc, the disc/track titles are displayed in up 25 characters even when more than characters are stored.

## Time display

Each press of the DISPLAY key changes the displayed contents.



- ① ▶SAIL AWAY SWEET Track title display (only CD-TEXT)
- ② ▶DISC123 TRACK10 Disc No., Track No. display
- ③ ▶LOVE LOVE LOVE Disc title
- ④ ▶D123 10 1:23 Elapsed time of track being played
- ⑤ ▶D123 10 -2:37 Remaining time of track being played
- ⑥ ▶D123 10 23:45T Elapsed time of entire disc (T lights up.)
- ⑦ ▶D123 10 -36:25T Remaining time of entire disc (T lights up.)

<b>During Stop</b>	<ul style="list-style-type: none"> <li>● In the TRACK mode, MUSIC TYPE mode and USER FILE mode, information is displayed in order of ③, ② then ④.</li> <li>● In the PGM mode, information is displayed in order of ①*, ②, ③ then ④.</li> <li>*Only when a track in a CD-TEXT disc is programmed as the first track.</li> </ul>
<b>During Play</b>	<ul style="list-style-type: none"> <li>● In the TRACK mode, information is displayed in order of ①, ②, ③, ④, ⑤, ⑥ then ⑦.</li> <li>● In the PGM mode, RANDOM mode, MUSIC TYPE mode, USER FILE mode and BEST SELECTION mode, information is displayed in order of ①, ②, ③, ④ then ⑤.</li> </ul>

## Displaying all the text information

In the case of a CD-TEXT disc, the text information shown below is displayed automatically during normal play (TRACK mode).

① Press the MODE key.



② Select "ALL INFORMATION".

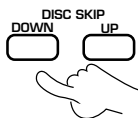

③ Set the input.



The display flashes.

ALL INFORMATION

**To jump to the next track or to return to the previous track during display:**

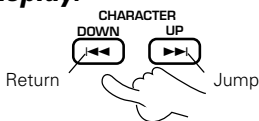

**To jump to the next item or to return to the previous item during display:**

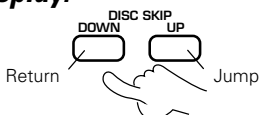

- ① **Disc/Track Title** : Disc and track titles
- ② **Disc/Track Artist** : Artist
- ③ **Disc/Track Songwriter** : Songwriter
- ④ **Disc/Track Composer** : Composer
- ⑤ **Disc/Track Arranger** : Arranger
- ⑥ **Disc/Track Message** : Message from sponsor or artist
- ⑦ **ID INFO.** : Record company, release date, etc.
- ⑧ **Genre INFO.** : Genre information

- Items from ① to ⑥ are displayed in the sequence of disc and track.
- When there is no text information to be displayed "-----" is scrolled on the display.
- In the case of a non-CD-TEXT disc, the "NO CD TEXT" display will appear for approx. 3 seconds.

**To end ALL INFORMATION during display**  
Press the MODE key.

# Programming tracks in desired order (PGM mode)

Use the following procedure to select desired tracks (up to 32 tracks) from different discs and program them in the desired order.

## Preparation

- Set the CD player to stop mode.

### 1 Press so that the "PGM" indicator lights.



PGM SELECT DISC

### 2 Select the disc.

#### 1 Select the disc number.

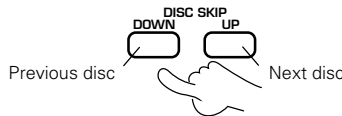

Within 8 seconds!

#### 2 Set the input.



Go to step 3 within 8 sec.

PGM01 D200

- The disc number can be selected directly by using the **DISC SELECTOR** key and numeric keys in place of the **DISC SKIP(DOWN/UP)** keys.
- When the disc corresponds to CD-TEXT, or when the disc title has been registered, the disc title will be displayed with scrolling. Discs can be selected by the disc title.
- "Registration of Title" → 20
- If you make a mistake, press the **CLEAR** key and enter the disc No. from the beginning.

### 3 Select the track number.

#### 1 Input the track number.

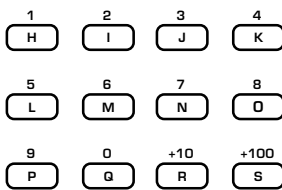

Within 8 seconds!

#### 2 Set the input.



#### Press the numeric keys in the following order...

Track No.8 : 8

Track No.14 : 1, 4

Track No.20 : 2, 0

PGM01 D200 T-----

- To program the entire disc, press the **SET** key without inputting the track number. "ALL" will be displayed.
- Program other tracks in the desired order by repeating steps 2 and 3.
- Up to 32 tracks can be programmed. "FULL" is displayed when no more tracks can be programmed.
- If you make a mistake, press the **CLEAR** key and restart from step 2.

### 4 Start playback.





### To check the programmed tracks

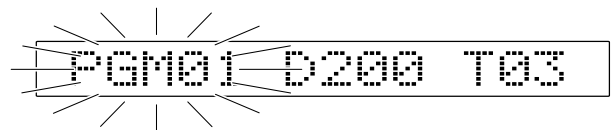
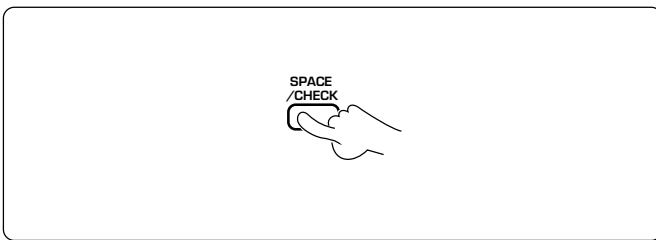

- Each time the key is pressed, the program No. and the disc No. are displayed.
- The previous display resumes in a few seconds.

### To add a track to the program



- When a track No. is entered, the track will be added to the end of the existing program.

### To change a track in the program

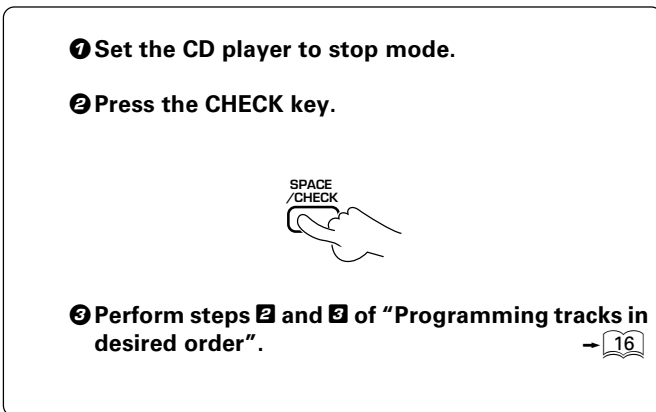

- Press the **CHECK** key repeatedly until the program No, to be changed is displayed.

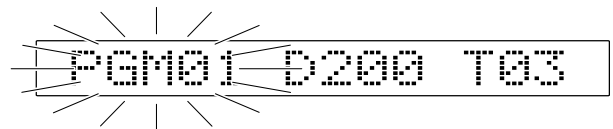

Example

- Press it while the "PGM01" indicator blinks.
- The track being played cannot be changed.

### To clear tracks from the program

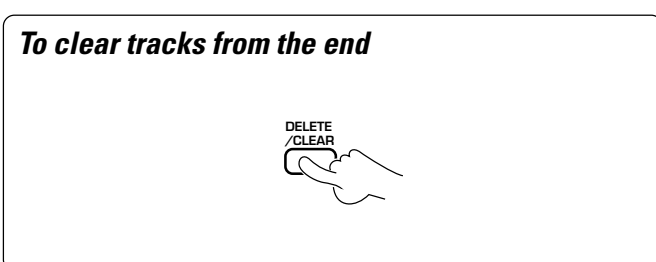

- Each time the key is pressed, the last track in the program is cleared.
- The tracks which are programmed earlier than the track being played cannot be cleared.

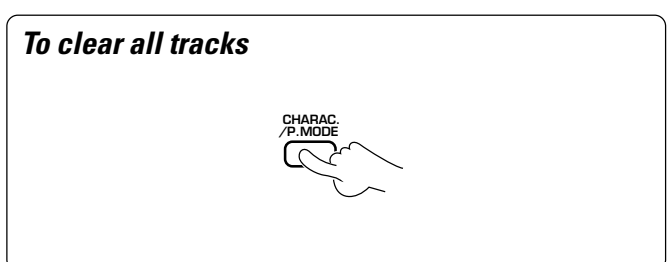

- When the **P.MODE** key is pressed during playback, playback in order of tracks starts from the track being played.

# Repeated playback (REPEAT mode)

## To repeat only the desired tracks

**❶ Program the desired tracks by performing steps ❶ to ❸ of "Programming tracks in desired order".** → 16

**❷ Switch REPEAT ON.**



**❸ Start playback.**



- Up to 32 tracks can be programmed by repeating steps ❶.



- The current status is displayed when the key is pressed once. When it is pressed while the status is displayed, the repeat ON status can be set to OFF (or vice versa).
- All of the programmed tracks will be repeated.
- In case only one track is programmed, only that track will be repeated.

### To cancel repeated playback

Press the REPEAT key twice. (REPEAT ON → OFF)

## To repeat one selected disc

**❶ Check that the unit is in the normal play TRACK mode.** → 13

**❷ Select the disc number.**

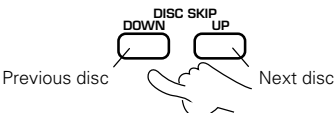

Previous disc      Next disc

Within 8 seconds!

**❸ Start playback.**



**❹ Switch REPEAT ON.**



- The disc number can be selected directly by using the DISC SELECTOR key and numeric keys in place of the DISC SKIP (DOWN/UP) keys.



- The current status is displayed when the key is pressed once. When it is pressed while the status is displayed, the repeat ON status can be set to OFF (or vice versa).

### To cancel repeated playback

Press the REPEAT key twice. (REPEAT ON → OFF)

For random repetition



For music type repetition



For user file repetition



For best selection repetition



# Playback in a random order (RANDOM mode)

Use the following procedure to activate random playback which selects a track at random after every track. This feature may allow you to play CDs for long hours without getting tired of.

**1** Check that the unit is in the normal play **TRACK** mode. → 13

**2** Select discs.

### To select one disc

① Select the disc number.

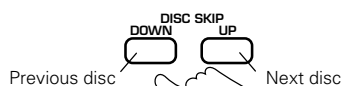

Within 8 seconds!

② Start playback.



③ Select "ONE DISC RANDOM".



### To select all discs

Select "ALL DISC RANDOM".



- The disc number can be selected directly by using the **DISC SELECTOR** key and numeric keys in place of the **DISC SKIP (DOWN/UP)** keys.

Each press switches the modes as follows:

- ① ONE DISC RANDOM
- ② ALL DISC RANDOM
- ③ RANDOM OFF

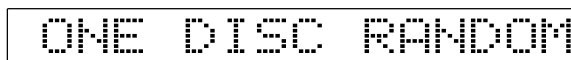

The number here changes.

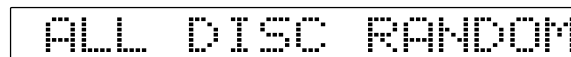

- Each time a track ends, the same operation as above is repeated, and the track selected next is played.
- Random play stops after all of the tracks have been played once.

### For repeated playback

Press the **REPEAT** key to select "REPEAT ON".

### To select another track in the middle of playing one

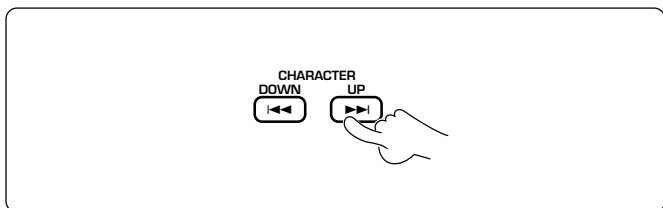

### To cancel random playback

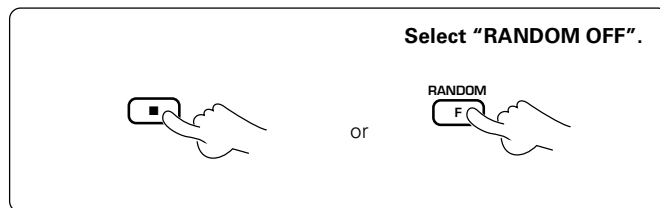

- Press the **■** key to stop playback.
- Normal playback will be performed when **RANDOM OFF** is selected.

For random music type

→ 24

For random user file

→ 26

# Registration of Title

20

For discs not corresponding to CD-TEXT, a title can be given to the disc (max. 25 characters). Operation is possible also when the door panel is open. We recommend to register titles while discs are being inserted.

## Preparation

- Set the CD player to stop mode.
- Check that the unit is in the normal play TRACK mode. → 13

## Assigning Title (TITLE INPUT mode)

### 1 Switch to title input mode.

- 1 Press the **MODE** key.



- 2 Select "TITLE INPUT".

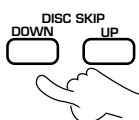

- 3 Set the input.



- When the **MODE** key is pressed during TITLE INPUT mode, the TITLE INPUT mode is cancelled.

Each press switches the modes as follows:

- 1 MUSIC TYPE
- 2 USER FILE
- 3 DISC SEARCH
- 4 TITLE INPUT
- 5 ALL DATA READ
- 6 ALL INFORMATION

The display flashes.

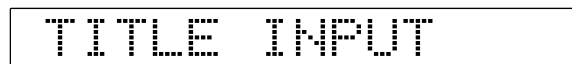

### 2 Select the desired disc.

- 1 Select the disc number.

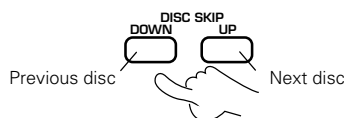

- 2 Set the input.



- The disc number can be selected directly by using the numeric keys in place of the **DISC SKIP(DOWN/UP)** keys.
- During playback, the disc only being played can be selected.



1. For discs corresponding to CD-TEXT, a new title can not be registered.

2. As the entered title and the CD-TEXT title information are memorized, the information may be displayed even when a disc has been removed.

**In regard to disc information reading**

The entered title is read in to the disc with the following timing.

- When the door panel is closed.
- When the title input mode is exited while the door panel is closed.

The display flashes.



When there are discs for which the disc information already has been read in, there may be no display.

**Do not move or exchange discs until the disc information has been read in.**

**3 Enter the disc title.**

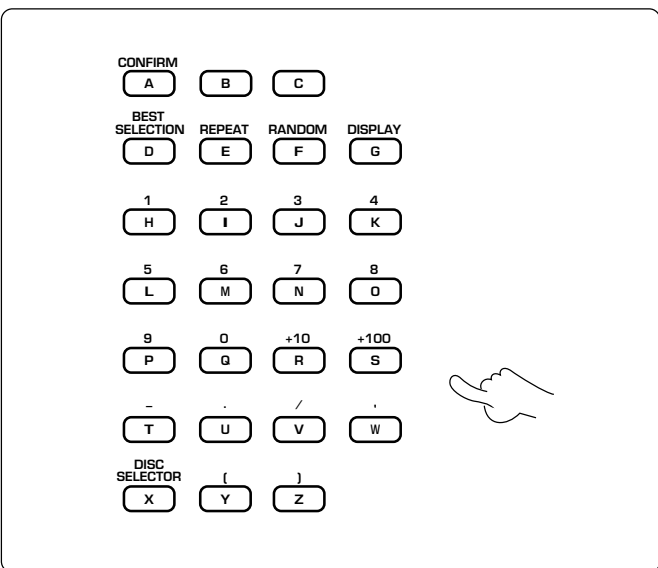

- One character is set and the cursor goes to the next digit.
- Repeat this to enter the disc name.
- If a desired character is not provided on the remote control keys, input the character as follows. Press the **CHARACTER (DOWN/UP)** keys or rotating the **DISC SKIP** knob until the desired character is displayed in the flashing cursor position. Then, press the **SET** key.

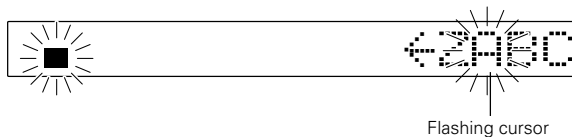

Flashing cursor

**4 Store the disc title.**

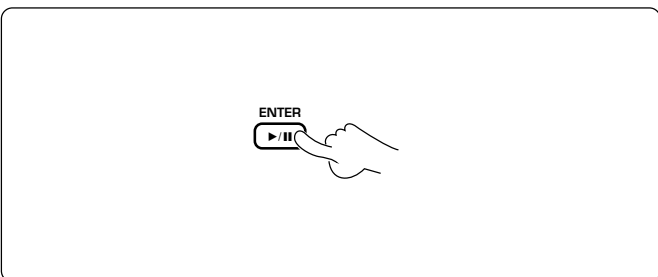

- To register the disc name of another disc, repeat the entire procedure from step 2 for it.

**To quit TITLE INPUT mode**

Press the **MODE** key.

**To change the character type**

The type of characters which can be entered is switched each time the CHARAC. key is pressed.

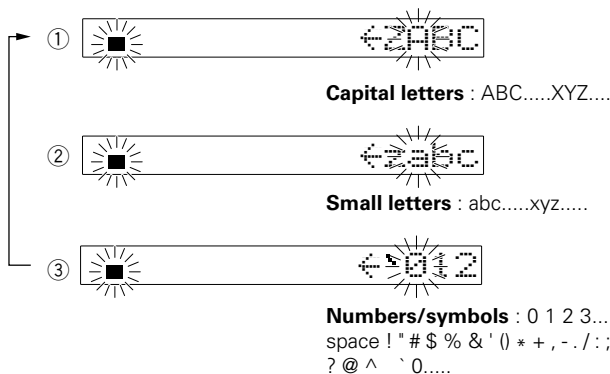
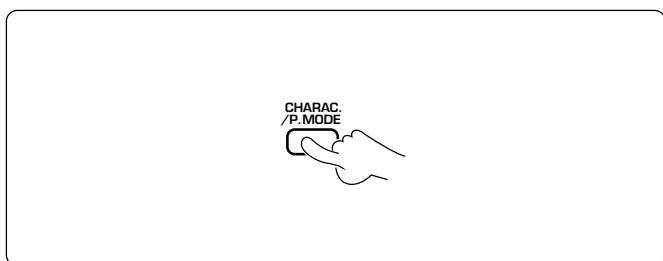

### Preparation

- Close the door panel.



## To change or delete a title

### 1 Perform steps 1 and 2 of "Assigning Title".



### 2 Change or delete characters one by one.

#### Change

- 1 Move the cursor to the desired character (to be changed).

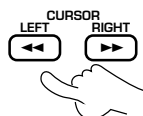

- 2 Select a character.

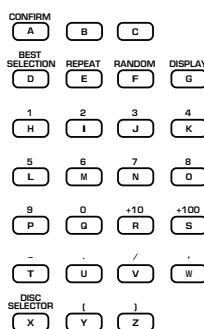

- 3 Delete the unnecessary character. (See "Deletion".)

#### Deletion

- 1 Move the cursor to the desired character (to be deleted).

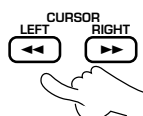

- 2 Press the DELETE key.



### 3 Execute title change or deletion.



- Call the disc to be changed.
- Deletion mode is cancelled when the **MODE** key is pressed.



← Move with the **CURSOR(LEFT/RIGHT)** keys →

- If the title to be changed is too long to be displayed on the display section, press the **CURSOR(LEFT/RIGHT)** keys to scroll the display so that the characters hidden until then appear.



Flashing cursor

- If a desired character is not provided on the remote control keys, input the character as follows. Press the **CHARACTER (DOWN/UP)** keys or rotating the **DISC SKIP** knob until the desired character is displayed in the flashing cursor position. Then, press the **SET** key.

#### To enter a space

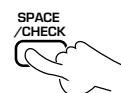

- When a title is to be deleted, delete all characters one by one.

#### To quit TITLE INPUT mode

Press the **MODE** key.

# Listening to music by genre (MUSIC TYPE mode)

Discs can be registered separately by 26 types of music genres.

## Preparation

- Close the door panel. → 11
- Check that the unit is in the normal play TRACK mode. → 13



## Registration of music type (MUSIC TYPE SET mode)

### 1 Activate the music type set mode.



① Press the **MODE** key.

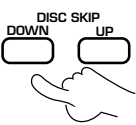

② Select "MUSIC TYPE".

③ Select "MUSIC TYPE SET".

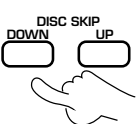



- When the **MODE** key is pressed during MUSIC TYPE SET mode, the MUSIC TYPE SET mode is cancelled.

Each press switches the modes as follows:

- ① MUSIC TYPE
- ② USER FILE
- ③ DISC SEARCH
- ④ TITLE INPUT
- ⑤ ALL DATA READ
- ⑥ ALL INFORMATION

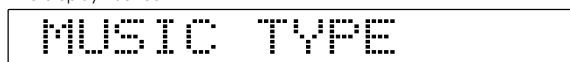

The display flashes.



The display flashes.

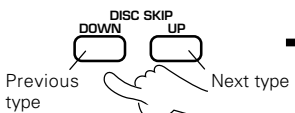

### 2 Select the music type.

Each press switches the modes as follows:

Adult Contemporary → Alternative Rock → Children's Music → Classical → Contemporary Christian → Country → Dance → Easy Listening → Folk → Gospel → Hip Hop → Jazz → Latin → Musical → New Age → Opera → Operetta → Pop Music → RAP → Reggae → Rock Music → Rhythm & Blues → Sound Effects → Sound Track → Spoken Word → World Music.....

When "Rock Music" is selected





- When the selected disc corresponds to CD-TEXT and contains a genre code, that genre code is registered as the music type.

To confirm the genre code ...

"Displaying all the text information" → 15

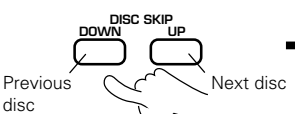
### 3 Select the desired disc.

- The disc number can be selected directly by using the numeric keys in place of the **DISC SKIP(DOWN/UP)** keys.
- Repeat step 3 if it is required to register another disc in the music type selected above.
- To register another music type, exit the MUSIC TYPE SET mode once and restart from the beginning.

### To quit MUSIC TYPE SET mode

Press the **MODE** key.

By registering one of music types to each disc, it is possible to enjoy playback of discs of a selected music type. Random playback of only the discs belonging to a selected music type is also available.

### Preparation

- Close the door panel.
- Register music type.
- Check that the unit is in the normal play TRACK mode.

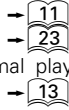

## Playing the music type (MUSIC TYPE PLAY mode)

### 1 Activate the music type play mode.

① Press the MODE key.



② Select "MUSIC TYPE".

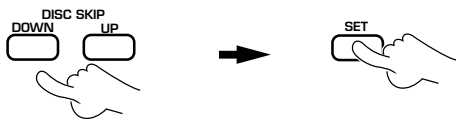

③ Select "MUSIC TYPE PLAY".

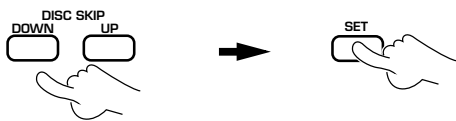

- When the **MODE** key is pressed during MUSIC TYPE PLAY mode, the MUSIC TYPE PLAY mode is cancelled.

Each press switches the modes as follows:

- ① MUSIC TYPE
- ② USER FILE
- ③ DISC SEARCH
- ④ TITLE INPUT
- ⑤ ALL DATA READ
- ⑥ ALL INFORMATION

The display flashes.



The display flashes.



### 2 Select the music type.

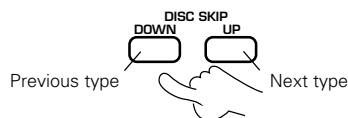

When "Adult Contemporary" is selected



### 3 Start playback.



- Playback is performed in increasing order of the disc numbers to which the selected music type has been registered. Skipping to the next disc is possible by pressing the ►► key.
- Each time the **CHECK** key is pressed, the registered disc numbers are displayed in increasing order of the disc numbers.

#### For repeated playback

Press the **REPEAT** key to select "REPEAT ON".

#### For random playback

Press the **RANDOM** key.

- Select "RANDOM OFF" or press the ■ key to quit random playback.

#### To clear the music type registered for a disc

Press the **CLEAR** key during playback of the disc to be deleted.



#### To quit MUSIC TYPE PLAY mode

Press the **MODE** key.





# Reorganizing discs to desired groups (USER FILE mode)

Eight user files are available for registering desired discs. This makes the user possible to create files registering the discs of a favorite artist(s) or the user's favorite discs. The user files can be named as desired.

## Preparation

- Close the door panel. → 11
- Check that the unit is in the normal play TRACK mode. → 13

## Registration of user file (USER FILE SET mode)

### 1 Activate the user file set mode.

① Press the **MODE** key.



② Select "USER FILE".

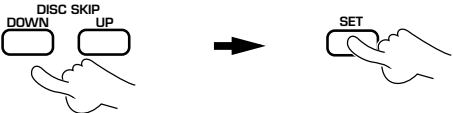

③ Select "USER FILE SET".

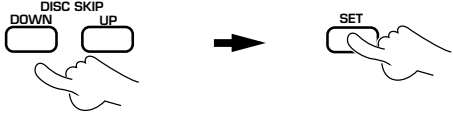

- When the **MODE** key is pressed during USER FILE SET mode, the USER FILE SET mode is cancelled.

Each press switches the modes as follows:

- ① MUSIC TYPE
- ② USER FILE
- ③ DISC SEARCH
- ④ TITLE INPUT
- ⑤ ALL DATA READ
- ⑥ ALL INFORMATION

The display flashes.

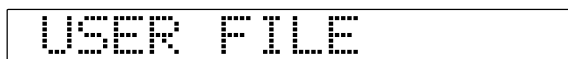

The display flashes.

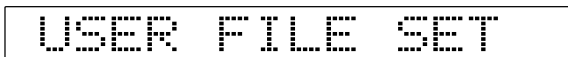

### 2 Select the desired user file.

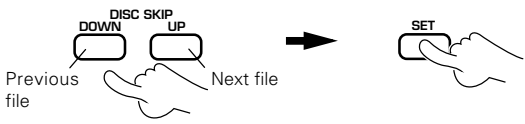

Each press switches the modes as follows:

**USER FILE 1** → **USER FILE 2** → **USER FILE 3** → **USER FILE 4** → **USER FILE 5** → **USER FILE 6** → **USER FILE 7** → **USER FILE 8**....

- If user file names have already been registered, their names are displayed in place of the above.  
"Assigning user file names" → 27

### 3 Select the desired disc.

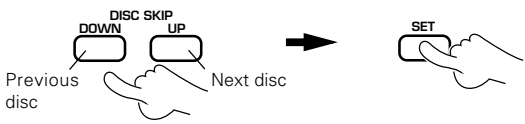

- The disc number can be selected directly by using the numeric keys in place of the **DISC SKIP(DOWN/UP)** keys.
- Repeat step 2 if it is required to register another disc in the user file selected above.
- To register another user file, exit the USER FILE SET mode once and restart from the beginning.
- The same disc can be registered in more than one user files.
- If the **CHECK** key is pressed while the disc number is blinking, the music type of the disc is displayed provided that its music type has been registered.

**To quit USER FILE SET mode**  
Press the **MODE** key.

When user files have been registered for the discs, it is possible to enjoy playback of discs of the selected user file. Random playback for a selected user file is also possible.

**Preparation**

- Close the door panel. → 11
- Register user file. → 25
- Check that the unit is in the normal play TRACK mode. → 13

## Playing the user file (USER FILE PLAY mode)

### 1 Activate the user file play mode.

① Press the **MODE** key.



② Select "USER FILE".

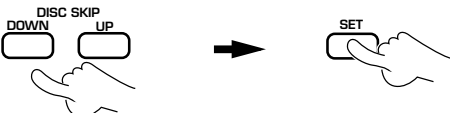

③ Select "USER FILE PLAY".



- When the **MODE** key is pressed during USER FILE PLAY mode, the USER FILE PLAY mode is cancelled.

Each press switches the modes as follows:

- ① MUSIC TYPE
- ② USER FILE
- ③ DISC SEARCH
- ④ TITLE INPUT
- ⑤ ALL DATA READ
- ⑥ ALL INFORMATION

The display flashes.

USER FILE

The display flashes.

USER FILE PLAY

### 2 Select the user file.

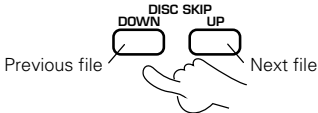

Previous file      Next file

When "USER FILE 1" is selected

USER FILE 1

Each press switches the modes as follows:

USER FILE 1 → USER FILE 2 → USER FILE 3 → USER FILE 4 →  
USER FILE 5 → USER FILE 6 → USER FILE 7 → USER FILE 8.....

- If user file names have already been registered, their names are displayed in place of the above.

"Assigning user file names"



### 3 Start playback.



- Playback is performed in increasing order of the disc numbers they were registered for the respective user file. Skipping to the next disc is done when the ►| key is pressed.

- Each time the **CHECK** key is pressed, the registered disc numbers are displayed in increasing order of the disc numbers.

#### For repeated playback

Press the **REPEAT** key to select "REPEAT ON".

#### For random playback

Press the **RANDOM** key.

- Select "RANDOM OFF" or press the ■ key to quit random playback.

#### To clear the user file registered for a disc

Press the **CLEAR** key during playback of the disc to be deleted.

D122 DISC CLEAR

#### To quit USER FILE PLAY mode

Press the **MODE** key.

U. FILE MODE OFF

**Preparation**

- Close the door panel. → 11
- Register user file. → 25
- Check that the unit is in the normal play TRACK mode. → 13

## Assigning user file names (FILE NAME INPUT mode)

### 1 Activate the file name input mode.

① Press the **MODE** key.

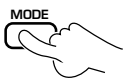

② Select "USER FILE".

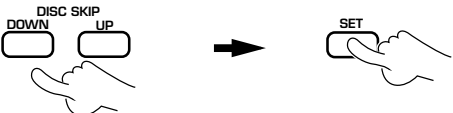

③ Select "FILE NAME INPUT".



● When the **MODE** key is pressed during FILE NAME INPUT mode, the FILE NAME INPUT mode is cancelled.

Each press switches the modes as follows:

- ① MUSIC TYPE
- ② USER FILE
- ③ DISC SEARCH
- ④ TITLE INPUT
- ⑤ ALL DATA READ
- ⑥ ALL INFORMATION

The display flashes.

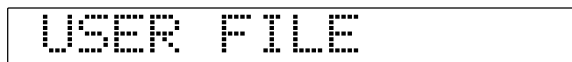

The display flashes.



### 2 Select the desired user file.

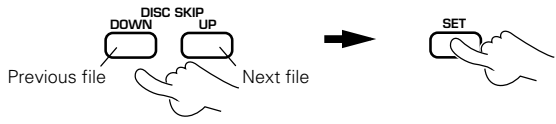

Each press switches the modes as follows:

**USER FILE 1** → **USER FILE 2** → **USER FILE 3** → **USER FILE 4** → **USER FILE 5** → **USER FILE 6** → **USER FILE 7** → **USER FILE 8**....

● If user file names have already been registered, their names are displayed in place of the above.

### 3 Enter the file name.

### 4 Store the file name.



● For the character input procedure, see step 5 in "Assigning Title". → 21



**To quit FILE NAME INPUT mode**  
Press the **MODE** key.

## To change or delete a file name

① Perform steps 1 and 2 above.

② For the character correction and deletion procedure, see "To change or delete a title". → 22

③ Press the **ENTER** key.



**Preparation**

- Close the door panel.
- Register user file.
- Check that the unit is in the normal play TRACK mode.

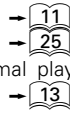

## To clear the user file (USER FILE CLEAR mode)

The following procedure clears the registration of all discs in the user files and the user file names. The user file names return the default names after clear.

### 1 Activate the user file clear mode.

① Press the MODE key.

② Select "USER FILE".

③ Select "USER FILE CLEAR".

- When the **MODE** key is pressed during USER FILE CLEAR mode, the USER FILE CLEAR mode is cancelled.

Each press switches the modes as follows:

- ① MUSIC TYPE
- ② USER FILE
- ③ DISC SEARCH
- ④ TITLE INPUT
- ⑤ ALL DATA READ
- ⑥ ALL INFORMATION

The display flashes.

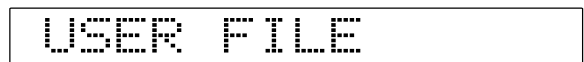

The display flashes.



### 2 Select the user file to be deleted.

① Select the user file to be deleted.

② Set the input.

Each press switches the modes as follows:

USER FILE 1 → USER FILE 2 → USER FILE 3 → USER FILE 4 →  
 USER FILE 5 → USER FILE 6 → USER FILE 7 → USER FILE 8.....

- If user file names have already been registered, their names are displayed in place of the above.

The display flashes.

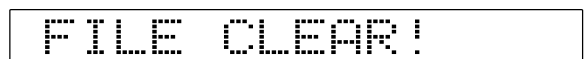
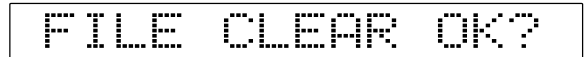

### To quit USER FILE CLEAR mode

Press the **MODE** key.

# Disc search (DISC SEARCH mode)

## Preparation

- Input the title. → 20
- Check that the unit is in the normal play TRACK mode. → 13

## Searching a disc by the disc title (CHARAC. SEARCH mode)

By inputting the initial letter of the desired disc title, discs which have the disc titles beginning with that character can be searched in sequence.

### 1 Activate the character search mode.

① Press the **MODE** key.

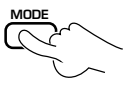

② Select "DISC SEARCH".

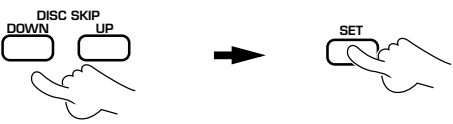

③ Select "CHARAC. SEARCH".

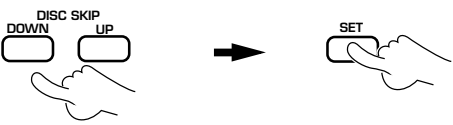

- When the **MODE** key is pressed during CHARAC.SEARCH mode, the CHARAC.SEARCH mode is cancelled.

Each press switches the modes as follows:

- ① MUSIC TYPE
- ② USER FILE
- ③ DISC SEARCH
- ④ TITLE INPUT
- ⑤ ALL DATA READ
- ⑥ ALL INFORMATION

The display flashes.

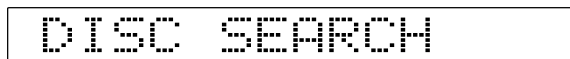

The display flashes.



### 2 Input the initial letter of the disc title to be searched.

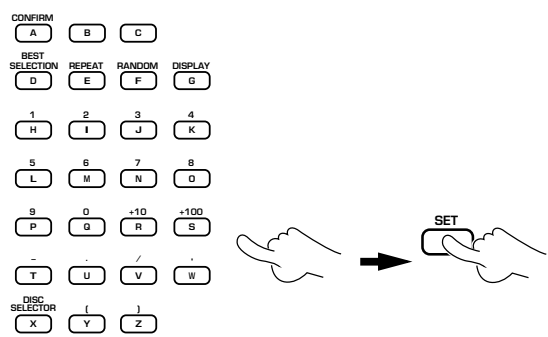

CONFIRM: A, B, C

BEST SELECTION: D, REPEAT: E, RANDOM: F, DISPLAY: G

1: H, 2: I, 3: J, 4: K

5: L, 6: M, 7: N, 8: O

9: P, 0: Q, +10: R, +100: S

-: T, /: U, \: V, .: W

DISC SELECTOR: X, Y, Z

When initial letter "A" is selected.

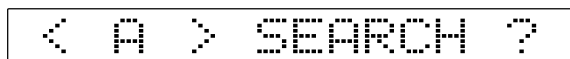

- The initial letters of disc titles are searched insensitively to the uppercase and lowercase.
- Lowercase characters cannot be input in the CHARAC. SEARCH mode.
- If a desired character is not provided on the remote control keys, input the character as follows. Press the **CHARACTER (DOWN/UP)** keys or rotating the **DISC SKIP** knob until the desired character is displayed in the flashing cursor position. Then, press the **SET** key.
- The type of characters which can be entered is switched each time the **CHARAC.** key is pressed.

- The disc titles beginning the specified character will be scrolled in the display.
- If there is no disc title beginning with the specified character, "**NO ENTRY**" will be displayed.

### To quit CHARAC.SEARCH mode

Press the **MODE** key.

### To search the next disc

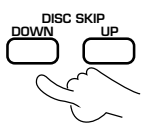

### To play the searched disc

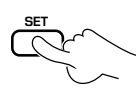

If disc is searched while the door panel is left open, the carousel rotates to move the search target disc on the front. If the search target disc is being played, "**DXXX BUSY!**" is displayed.

**Preparation**

- Register music type. → 23
- Check that the unit is in the normal play TRACK mode. → 13

# Searching the music type (M.TYPE SEARCH mode)

The discs registered in the specified music type can be searched in sequence.

## 1 Activate the music type search mode.

① Press the MODE key.



② Select "DISC SEARCH".

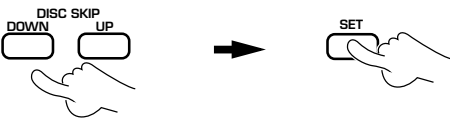

③ Select "M. TYPE SEARCH".

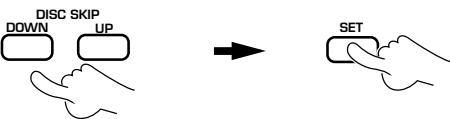

- When the **MODE** key is pressed during M.TYPE SEARCH mode, the M.TYPE SEARCH mode is cancelled.

Each press switches the modes as follows:

- ① MUSIC TYPE
- ② USER FILE
- ③ DISC SEARCH
- ④ TITLE INPUT
- ⑤ ALL DATA READ
- ⑥ ALL INFORMATION

The display flashes.



The display flashes.



## 2 Select the music type to be searched.

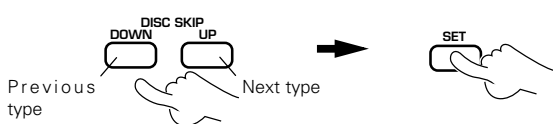

Each press switches the modes as follows:

Adult Contemporary → Alternative Rock → Children's Music → Classical → Contemporary Christian → Country → Dance → Easy Listening → Folk → Gospel → Hip Hop → Jazz → Latin → Musical → New Age → Opera → Operetta → Pop Music → RAP → Reggae → Rock Music → Rhythm & Blues → Sound Effects → Sound Track → Spoken Word → World Music....

- If there is no disc registered in the specified music type, "NO ENTRY" will be displayed.

**To quit M.TYPE SEARCH mode**

Press the **MODE** key.

**To search the next disc**

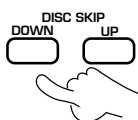



**To play the searched disc**



If disc is searched while the door panel is left open, the carousel rotates to move the search target disc on the front. If the search target disc is being played, "DXXX BUSY!" is displayed.

**Preparation**

- Register user file.  25
- Check that the unit is in the normal play TRACK mode.  13

## Searching the user file (U. FILE SEARCH mode)

The discs registered in the specified user file can be searched in sequence.

### 1 Activate the user file search mode.

- ① Press the **MODE** key.

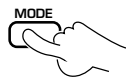

- ② Select "DISC SEARCH".

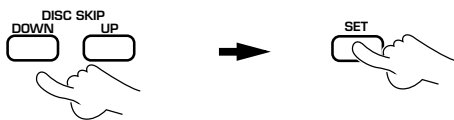

- ③ Select "U. FILE SEARCH".



- When the **MODE** key is pressed during U. FILE SEARCH mode, the U. FILE SEARCH mode is cancelled.

Each press switches the modes as follows:

- ① MUSIC TYPE
- ② USER FILE
- ③ DISC SEARCH
- ④ TITLE INPUT
- ⑤ ALL DATA READ
- ⑥ ALL INFORMATION

The display flashes.

DISC SEARCH

The display flashes.

U. FILE SEARCH

### 2 Select the user file to be searched.

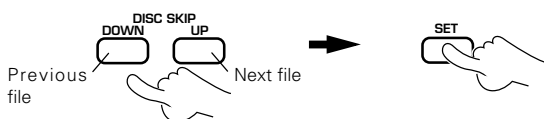

Each press switches the modes as follows:

USER FILE 1 → USER FILE 2 → USER FILE 3 → USER FILE 4 →  
USER FILE 5 → USER FILE 6 → USER FILE 7 → USER FILE 8....

- If user file names have already been registered, their names are displayed in place of the above.  27  
"Assigning user file names"

- If there is no disc registered in the specified user file, "NO ENTRY" will be displayed.

#### To quit U. FILE SEARCH mode

Press the **MODE** key.

#### To search the next disc

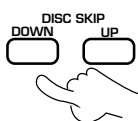

#### To play the searched disc



If disc is searched while the door panel is left open, the carousel rotates to move the search target disc on the front. If the search target disc is being played, "DXXX BUSY!" is displayed.

# Listening to your favorite titles (BEST SELECTION mode)

32

You can select only your favorite titles and register them as the best selection. Use the following procedure to register favorite tracks in the best selection file while playing a CD.

## Registration of best selection file

### 1 Play the track to be registered.

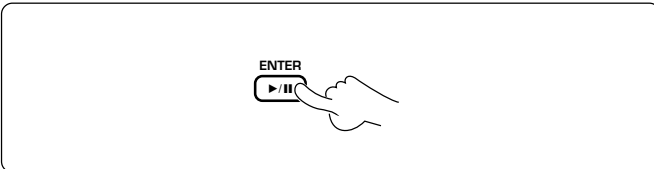

- Only the track being played can be registered.

### 2 Register it in the best selection file.

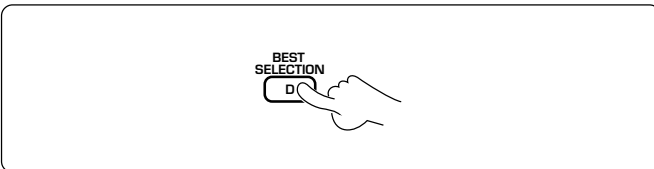

BEST01 D104 T03

### 3 Register other favorite tracks by performing steps 1 and 2 for each of them.

- Up to 32 tracks can be registered. "FULL" is displayed when no more disc is acceptable.

## Playing the best selection file

### Preparation

- Set the CD player to stop mode.
- Check that the unit is in the normal play TRACK mode. → 13

Press the BEST SELECTION key.



BEST SELECTION

- The tracks are played in the order they are registered.
- Each time the CHECK key is pressed, the disc numbers and track numbers are displayed in the order they are registered.

### For repeated playback

Press the REPEAT key to select "REPEAT ON".

### To quit BEST SELECTION mode

Press the ■ key during playback.

- The recorded contents remain stored even when BEST SELECTION mode is quit.

## To delete the registered best selection file

- 1 Play the track to be cleared.
- 2 Press the CLEAR key.



- This is done during BEST SELECTION mode.

BEST02 CLEAR



# Timer operation

As this unit incorporate the timer standby function, playback can be started at desired moment if a commercially available audio timer is combined with this unit.

## Preparation

- Close the door panel. 
- Connect the system components so that their power can be switched on by the timer.
- Read the instruction manual of the timer carefully.

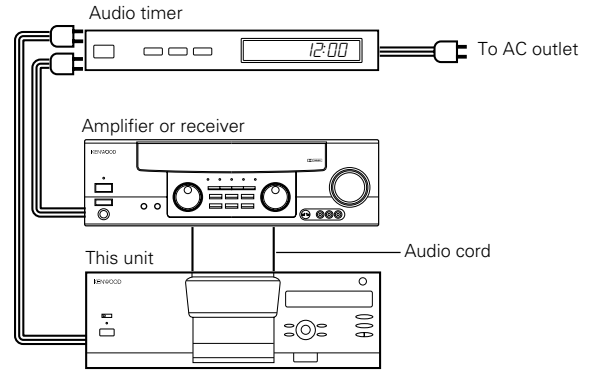

**1** Set the power switches of the system components to the ON positions.

**2** Select the disc to be played.

**1** Select the disc number.

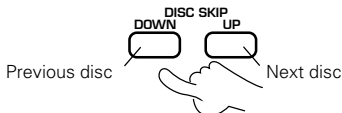

Previous disc      Next disc

Within 8 seconds!

**2** Play the disc.



ENTER

**3** Set the listening volume.

**1** Adjust the volume on the amplifier or receiver.

**2** Stop playback.

**4** Set the timer for the desired ON time.

**5** Set the **TIMER PLAY** switch to ON.



Main unit

TIMER PLAY  
OFF ON

- The disc number can be selected directly by using the **DISC SELECTOR** key and numeric keys in place of the **DISC SKIP(DOWN/UP)** keys.

- Read the instruction manual of the timer carefully.

- When the set time comes, playback will start automatically.
- The playback mode will be TRACK mode.

## Disc handling precautions

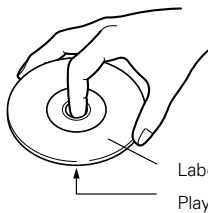

### Handling

Hold the discs so that you do not touch the playing surface.

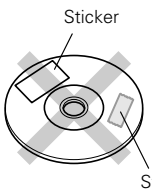

Do not attach paper or tape to either the playing side or the label side of the discs.

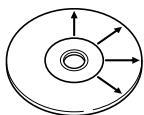

### Cleaning

If fingerprints or foreign matter become attached to the disc, lightly wipe the disc with a soft cotton cloth (or similar) from the center of the disc outwards in a radial manner.

### Storage

When a disc is not to be played for a long period of time, remove it from the player and store it in its case.

## Discs which can be played with this unit

CD (12 cm), and the audio part of CDV, CD-G, CD-EG and CD-EXTRA. Use discs that comply with the IEC standard, for example a disc carrying the  marking on the label surface.

- An 8 cm CD cannot be played back.

## Never play a cracked or warped disc

During playback, the disc rotates at high speed in the player. Therefore, to avoid danger, never use a cracked or deformed disc or a disc repaired with tape or adhesive agent. Please do not use discs which are not round because they may cause a malfunction.

## Disc accessories

The disc accessories (stabilizer, protection sheet, protection ring, etc.) which are marketed for improving the sound quality or protecting discs as well as the disc cleaner should not be used with this system because they may cause malfunction.

## Maintenance of the unit

When the front panel or case becomes dirty, wipe with a soft, dry cloth. Do not use thinner, benzine, alcohol, etc. for these agents may cause discoloration.

## Caution on condensation

Condensation (of dew) may occur inside the unit when there is a great difference in temperature between this unit and the outside. This unit may not function properly if condensation occurs. In this case, leave the unit for a few hours with the power left ON, and restart the operation after the condensation has dried up.

Be specially cautious against condensation in a following circumstance:

When this unit is carried from a place to another across a large difference in temperature, when the humidity in the room where this unit is installed increases, etc.

## Memory backup function

**Stored contents for at least 3 weeks after power plug is unplugged from the AC outlet.**

Power status (ON or OFF),  
Title registration contents  
Music type registration contents  
User file registration contents  
Best selection registration contents

## In regard to contact cleaner

Do not use contact cleaners because it could cause a malfunction. Be specially careful not to use contact cleaners containing oil, for they may deform the plastic component.

## Note related to transportation and movement

Before transporting or moving this unit, carry out the following operation:

1. Remove all discs from the carousel and close the door panel.
2. Confirm that the flashing "NO DISC" display has changed to steady lighting, and then switch off the power.



3. Wait a few seconds, then disconnect the power plug.



As an ENERGY STAR® Partner, Kenwood Corporation has determined that this products meets the ENERGY STAR® guidelines for energy efficiency. This product can save energy. Saving energy reduces air pollution and lowers utility bills.

## Operation to reset

The microcomputer may malfunction (impossibility to operate, erroneous display, etc.) when the connection cords are unplugged while power is ON or due to an external factor. In this case, execute the following method to reset the microcomputer and return it to normal condition.



Unplug the power cord from the power socket and plug the power cord into the socket again.

## To reset the registered contents











The registered contents for title, music type, user file and best selection can be reset by the following procedure.

Unplug the power cord from the power socket, and while holding the **■** key depressed, plug the power cord into the socket again.

## Remote control unit

Symptom	Cause	Remedy
Remote control operation is not possible.	<ul style="list-style-type: none"> <li>● Batteries are exhausted.</li> <li>● The remote control unit is too far away from the main system, controlling angle is too large, or there is an obstacle in between.</li> </ul>	<ul style="list-style-type: none"> <li>● Replace with new batteries. →  9</li> <li>● Operate the remote control unit within the controllable range. →  9</li> </ul>

## CD Player

Symptom	Cause	Remedy
No power is applied with the POWER(I/⏻) key ON.	<ul style="list-style-type: none"> <li>● Power plug is loosely connected.</li> <li>● With the power plug connected to the switched AC outlet of an amplifier, the power of the amplifier is turned off.</li> </ul>	<ul style="list-style-type: none"> <li>● Insert the power plug firmly to the AC outlet.</li> <li>● Insert the power plug to the wall AC outlet.</li> </ul>
Sound is not heard with the ▶/   key on.	<ul style="list-style-type: none"> <li>● Disc is loose.</li> <li>● Condensation occurred on the optical lens unit.</li> <li>● Disc is too dirty.</li> <li>● Disc is cracked.</li> <li>● The connection cords are inserted loosely.</li> </ul>	<ul style="list-style-type: none"> <li>● Insert disc properly. →  10</li> <li>● Leave the player for about 1 hour so that the condensation is removed. →  34</li> <li>● Wipe off the dust on the disc surface referring to "Disc handling precautions". →  34</li> <li>● Replace the disc with a new one.</li> <li>● Connect all connection cords firmly. →  6</li> </ul>
Music is interrupted. (Sound is skipped.)	<ul style="list-style-type: none"> <li>● Disc is too dirty.</li> <li>● Disc is cracked.</li> <li>● Oscillation is applied to this unit.</li> </ul>	<ul style="list-style-type: none"> <li>● Wipe off the dust on the disc surface referring to "Disc handling precautions". →  34</li> <li>● Replace the disc with a new one.</li> <li>● Try selecting a place where no strong vibrations occur by changing the installation place, etc.</li> </ul>
Disc selection is not possible.	<ul style="list-style-type: none"> <li>● RANDOM mode or BEST SELECTION mode is selected.</li> <li>● MUSIC TYPE PLAY mode or USER FILE PLAY mode is selected.</li> </ul>	<ul style="list-style-type: none"> <li>● Press the <b>■</b> key to quit RANDOM mode or BEST SELECTION mode. →  19 →  32</li> <li>● Press the <b>MODE</b> key to quit MUSIC TYPE PLAY mode or USER FILE PLAY mode. →  24 →  26</li> </ul>
Disc begins to play when power is switched ON.	<ul style="list-style-type: none"> <li>● The <b>TIMER PLAY</b> switch is set to ON.</li> </ul>	<ul style="list-style-type: none"> <li>● Set the <b>TIMER PLAY</b> switch to OFF unless timer playback is required. →  33</li> </ul>

# Specifications

36

[Format]  
System ..... Compact disc digital audio system  
Laser ..... Semiconductor laser

[D/A Convertors]  
D/A Conversion ..... 1 Bit  
Oversampling ..... 8 fs (352.8 kHz)

[Audio]  
Frequency response ..... 4 Hz ~ 20 kHz,  $\pm$  0.5 dB  
Signal to noise ratio ..... More than 103 dB  
Dynamic range ..... More than 95 dB  
Total harmonic distortion + noise  
..... Less than 0.005% (at 1 kHz)  
Channel separation ..... More than 95 dB (at 1 kHz)  
Wow & flutter ..... Unmeasurable Limit  
Output level/impedance  
Fixed ..... 2.0 V/1 k $\Omega$   
Digital output  
Optical ..... -15 dBm ~ -21 dBm (Wave length 660 nm)

[Laser]  
Wave length ..... 760 nm - 800 nm  
Laser power class ..... Class 1 (IEC)

[General]  
Power consumption ..... 10 W  
Dimensions  
W : 440 mm (17-5/16")  
H : 163 mm (6-7/16")  
D : 479 mm (18-7/8")  
Weight (Net) ..... 7 kg (15.4 lb)



1. KENWOOD follows a policy of continuous advancements in development. For this reason specifications may be changed without notice.
2. The full performance may not be exhibited in an extremely cold location (under a water-freezing temperature).

## For the U.S.A.

### FCC WARNING

This equipment may generate or use radio frequency energy. Changes or modifications to this equipment may cause harmful interference unless the modifications are expressly approved in the instruction manual. The user could lose the authority to operate this equipment if an unauthorized change or modification is made.

### NOTE:

This equipment has been tested and found to comply with the limits for a Class B digital device, pursuant to Part 15 of the FCC Rules. These limits are designed to provide reasonable protection against harmful interference in a residential installation. This equipment may cause harmful interference to radio communications, if it is not installed and used in accordance with the instructions. However, there is no guarantee that interference will not occur in a particular installation. If this equipment does cause harmful interference to radio or television reception, which can be determined by turning the equipment off and on, the user is encouraged to try to correct the interference by one or more of the following measures:

- Reorient or relocate the receiving antenna.
- Increase the separation between the equipment and receiver.
- Connect the equipment into an outlet on a circuit different from that to which the receiver is connected.
- Consult the dealer or an experienced radio / TV technician for help.

## For the U.S.A.

### CAUTION:

Use of controls or adjustments or performance of procedures other than those specified herein may result in hazardous radiation exposure.

In compliance with Federal Regulations, following are reproductions of labels on, or inside the product relating to laser product safety.

KENWOOD CORPORATION  
2967-3, ISHIKAWA-CHO, HACHIOJI-SHI,  
TOKYO, JAPAN

KENWOOD CORP. CERTIFIES THIS EQUIPMENT CON-  
FORMS TO DHHS REGULATIONS NO. 21 CFR 1040.10,  
CHAPTER 1, SUBCHAPTER J.

Location: Back Panel

# KENWOOD

## For your records

Record the serial number, found on the back of the unit, in the spaces designated on the warranty card, and in the space provided below. Refer to the model and serial numbers whenever you call upon your dealer for information or service on this product.

Model \_\_\_\_\_ Serial Number \_\_\_\_\_

## Free Manuals Download Website

<http://myh66.com>

<http://usermanuals.us>

<http://www.somanuals.com>

<http://www.4manuals.cc>

<http://www.manual-lib.com>

<http://www.404manual.com>

<http://www.luxmanual.com>

<http://aubethermostatmanual.com>

Golf course search by state

<http://golfingnear.com>

Email search by domain

<http://emailbydomain.com>

Auto manuals search

<http://auto.somanuals.com>

TV manuals search

<http://tv.somanuals.com>