

# KENWOOD

MULTIPLE COMPACT DISC PLAYER

DPF-J6030

CD-4700M

CD-4260M

CD-425M

---

## INSTRUCTION MANUAL

KENWOOD CORPORATION

**This unit is designed for home use only. If the unit is used in a location other than at home, such as in a shop (for commercial use), in a car or in a ship, etc., and is damaged, a service fee may be charged even during the warranty period.**

**This instruction manual is used to describe multiple models listed above.  
Model availability and features (functions) may differ depending on the country and sales area.**



# Before applying power

 **Caution : Read this page carefully to ensure safe operation.**

## 2 Units are designed for operation as follows.

**U.S.A. and Canada** ..... **AC 120 V only**  
**Europe and U.K.** ..... **AC 230 V only**

### For the United Kingdom

#### Factory fitted moulded mains plug

- 1.The mains plug contains a fuse. For replacement, use only a 13-Amp ASTA-approved (BS1362) fuse.
- 2.The fuse cover must be refitted when replacing the fuse in the moulded plug.
- 3.Do not cut off the mains plug from this equipment. If the plug fitted is not suitable for the power points in your home or the cable is too short to reach a power point, then obtain an appropriate safety approved extension lead or adapter, or consult your dealer. If nonetheless the mains plug is cut off, remove the fuse and dispose of the plug immediately, to avoid a possible shock hazard by inadvertent connection to the mains supply.





**IMPORTANT:** The wires in the mains lead are coloured in accordance with the following code:

Blue : Neutral  
Brown : Live

Do not connect those leads to the earth terminal of a three-pin plug.

## Safety precautions

**WARNING :** TO PREVENT FIRE OR ELECTRIC SHOCK, DO NOT EXPOSE THIS APPLIANCE TO RAIN OR MOISTURE.

	<b>CAUTION</b> RISK OF ELECTRIC SHOCK DO NOT OPEN		CAUTION: TO REDUCE THE RISK OF ELECTRIC SHOCK, DO NOT REMOVE COVER (OR BACK). NO USER-SERVICEABLE PARTS INSIDE. REFER SERVICING TO QUALIFIED SERVICE PERSONNEL.
	THE LIGHTNING FLASH WITH ARROWHEAD SYMBOL, WITHIN AN EQUILATERAL TRIANGLE, IS INTENDED TO ALERT THE USER TO THE PRESENCE OF UNINSULATED "DANGEROUS VOLTAGE" WITHIN THE PRODUCT'S ENCLOSURE THAT MAY BE OF SUFFICIENT MAGNITUDE TO CONSTITUTE A RISK OF ELECTRIC SHOCK TO PERSONS.		
	THE EXCLAMATION POINT WITHIN AN EQUILATERAL TRIANGLE IS INTENDED TO ALERT THE USER TO THE PRESENCE OF IMPORTANT OPERATING AND MAINTENANCE (SERVICING) INSTRUCTIONS IN THE LITERATURE ACCOMPANYING THE APPLIANCE.		

### The marking of products using lasers (Except for some areas)

**CLASS 1  
LASER PRODUCT**

The marking is located on the rear panel and says that the component uses laser beams that have been classified as Class 1. It means that the unit is utilizing laser beams that are of a weaker class. There is no danger of hazardous radiation outside the unit.

# Your New Kenwood 200-Disc CD Changer

## Welcome to your new Kenwood 200-Disc CD Changer.

CD-4700M is sold in USA. CD-4260M and CD-425M are sold in USA and Canada. DPF-J6030 is sold in other countries.

### This CD changer offers the following exciting features :

- 200-disc capacity
- PC LINK function, which allows you to connect your PC to the CD player and download disc titles and track data from an Internet site and register them in the CD player. This function can also be used to input title data directly from the PC to the CD player or control it from the PC.
- 10-key remote and infrared remote keyboard
- Digital audio output
- CD Text, which displays text from encoded CDs on the unit's display
- Disc and Track Naming, which allows you to program your own names for discs and tracks
- Music Type File, which lets you organize your discs into specific musical types (such as Classical, Jazz, Rock), and then play them by type
- User File, which lets you organize your discs into user file name (such as father, mother, children), and then play them by name

### Your new changer can play the following disc types :

- Standard 12 cm CDs
  - CDV (Video) and CDG (Graphics), although it will not display the video portion
- You may not play 8 cm CD "singles."

## Unpacking

Unpack your new CD changer carefully and make sure that all the accessories are present:

If any accessories are missing, or if the changer is damaged or fails to operate, notify your dealer immediately. If your changer was shipped to you directly, notify your shipper immediately. Kenwood recommends that you retain the original carton and packing materials in case you need to move or ship the changer in the future.

Keep this manual handy for future reference.

### Accessories

Audio cable ..... (1)



System control cable ..... (1)



Communication cable ..... (1)



10-key Remote ..... (1)

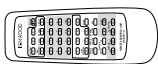

Infrared Remote Keyboard ..... (1)



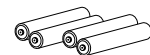

Batteries (R6/AA) ..... (4)



# Table of Contents

Caution : Read the pages marked  carefully to ensure safe operation.

4

 Before applying power .....	2
 Safty precautions .....	2
<b>Your New Kenwood 200-Disc CD Changer .....</b>	<b>3</b>
<b>Chapter 1 : Setting Up Your New CD Changer .....</b>	<b>5</b>
Connecting to Other Devices .....	6
System Control Chaining .....	8
Setting Up the 10-Key Remote and Keyboard .....	9
10-Key Remote .....	9
Keyboard .....	9
<b>Chapter 2 : Getting to know Your New CD Changer .....</b>	<b>10</b>
Front Panel .....	11
Front Panel Displays .....	12
10-Key Remote and Keyboard .....	13
10-Key Remote .....	13
Keyboard .....	14
<b>Chapter 3 : Loading and Playing Discs .....</b>	<b>16</b>
Preparation .....	17
Loading discs in the carousel .....	17
Normal play (TRACK mode) .....	19
Playing tracks in order from track No.1 .....	19
Playback from desired track .....	21
Repeated playback (REPEAT mode).....	22
Playback in a random order (RANDOM mode).....	23
Programming tracks in desired order (PGM mode).....	24
Timer operation .....	26
<b>Chapter 4 : Specifying and Using Disc or Track Data ...</b>	<b>27</b>
Registration of Title .....	28
Assigning Title (TITLE INPUT mode) .....	28
To change or delete a title .....	30
Listening to music by genre (MUSIC TYPE mode) .....	31
Registration of music type (MUSIC TYPE SET mode) .....	31
Playing the music type (MUSICTYPE PLAY mode) ....	32
Reorganizing discs to desired groups (USER FILE mode) ..	33
Registration of user file (USER FILE SET mode) ....	33
Playing the user file (USER FILE PLAY mode) ....	34
Assigning user file names (FILE NAME INPUT mode) .....	35
To clear the user file (USER FILE CLEAR mode) .....	36
Disc search (DISC SEARCH mode) .....	37
Searching a disc by the disc title (CHARAC. SEARCH mode) .....	37
Searching the music type (M.TYPE SEARCH mode) ..	38
Searching the user file (U.FILE SEARCH mode) ..	39
Listening to your favorite titles (BEST SELECTION mode) .....	40
Registration of best selection file .....	40
Playing the best selection file .....	40
<b>Chapter 5 : In case of difficulty .....</b>	<b>41</b>
In case of difficulty .....	41
Important items .....	42
<b>Chapter 6 : Warnings and Specifications .....</b>	<b>43</b>
Warnings .....	43
Specifications .....	44



# Chapter 1 : Setting Up Your New CD Changer

## Welcome to the Kenwood CD-4700M/CD-4260M/CD-425M/DPF-J6030 Instruction manual.

The Instruction manual contains all the information you need to know to set up and operate your new CD changer safely and enjoyably.

This chapter guides you through the connection and setup of your new CD changer and its remote.

### Refer to the following pages for details on these issues :

- Connecting to a Other Devices  6
- System Control Chaining  8
- Setting Up the 10-Key Remote and Keyboard  9

Your CD changer includes a standard remote and a remote keyboard (for easier text entry). You can use either device to control the changer. For the sake of simplicity, this manual provides standard remote instructions for all functions except text entry.

## Before You Begin

Be sure to read the notes on this page before you begin setting up the changer.



1. All cables (except the digital optical cable and RS-232C cord) should have been supplied with your new CD changer. See "Unpacking".  3

If you need to purchase additional or replacement cables, visit any home electronics store or the Kenwood USA Web site at <http://www.kenwoodusa.com>. You can also call 1-800-KENWOOD. (For U.S.A. and Canada only)

2. Do not plug in the CD changer's power cord until you have finished making connections to your receiver or amplifier.
3. If you exposed your changer to a great difference in temperature (for example, if you purchased it in winter from a store with an unheated warehouse) or if the humidity in the room changes, condensation may form inside the unit. If this occurs, connect the unit, turn it on, and leave it on but unused for a few hours. This will evaporate the condensation and return your changer to working order. Restart the changer before using it again.
4. Clean your CD changer with a soft, dry cloth. Avoid solvents of any kind, as they may damage the cabinet components.
5. Do not use CD accessories such as protection sheets or disc cleaners with your new CD changer.
6. Kenwood recommends having your CD changer's precision optical pickup inspected periodically. Depending on the operation environment (humidity, dust, smoke, etc.), this pickup should operate approximately 1,000 hours before requiring inspection. To schedule inspection, consult the store where you purchased the changer or visit the Kenwood USA Web site's Support area.
7. Be sure to locate your changer on a level and stationary surface, or it will not be able to play discs properly.
8. Your CD changer continues to store the following information for at least 3 weeks after you unplug its power cord:
  - Power status (on or off)
  - Disc and track names
  - Music Type assignments
  - User File assignments
  - Best Selection assignmentsAfter that you must reset this information according to the instructions in this manual.  41
9. Once you have set up the changer and loaded discs, you should not move it without doing the following:
  - (1) Remove all the discs from the unit and close the disc door.
  - (2) Look at the display. "NO DISC" should appear steadily (i.e., it should not be flashing).
  - (3) Turn off the CD changer.
  - (4) A few seconds after the display appears, disconnect the CD changer from the receiver and unplug the CD changer from the wall outlet or power strip.

# Connecting to Other Devices

Make connections as shown below.

When connecting the related system components, refer also to the instruction manuals of the related components. Do not plug in the power lead until all connections are completed.

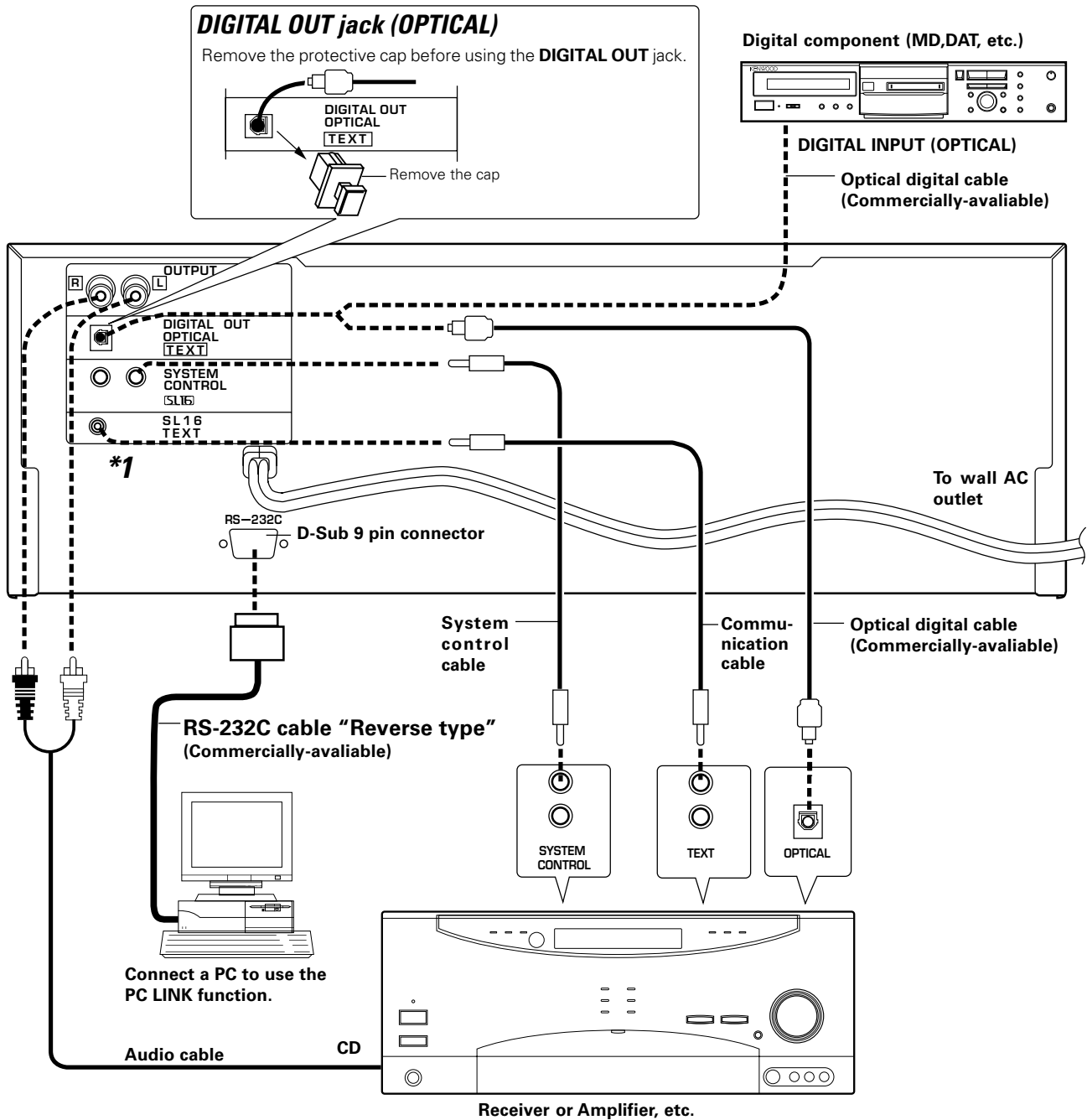

**\* 1**  
**Note on the SL16 TEXT jack**  
 When using a KENWOOD Receiver equipped with the SL16 TEXT jack, connect it to the Receiver using the communication cable provided with this unit. This makes it possible to display the disc and track titles on the LCD remote control unit (provided with the Receiver).

**Note** If your receiver has the SL16/XS8 mode select switch, set the connected receiver to the [SL16] mode.

**DTS Disclaimer clause**  
 When playing DTS-encoded CDs, excessive noise will be exhibited from the analog stereo outputs. To avoid possible damage to the audio system, the consumer should take proper precautions when the analog stereo outputs of the CD player is connected to an amplification system. To enjoy DTS Digital Surround™ playback, an external 5.1 channel DTS Digital Surround™ decoder system must be connected to the digital output (S/P DIF, AES/EBU, or TosLink) of the CD player.

- Notes**
1. Connect all cables firmly. If connections are loose, there could be loss of sound or noise produced.
  2. When plugging and unplugging connection cables, be sure to first remove the power cord from the AC outlet. Plugging/unplugging connection cables without removal of the power cable can cause malfunctions or damage to the unit.

### To Connect the Changer to a Kenwood Receiver

1. Unplug the receiver from the wall outlet or power strip.
2. Connect the audio cable from output on the CD changer to the receiver as shown to the left. If you are connecting the CD changer to a receiver that supports listening (such as the VR-4900/KRF-V9993D shown in the illustration), connect audio cable for output to the appropriate jacks on the receiver.
3. Connect an optional optical digital cable from the changer to the receiver as shown to the left. If your receiver does not support digital output, skip this step.  
If you do not connect a digital cable or if your receiver does not support digital output and DTS decoding, DTS discs do not play on your changer.
4. Connect the system control cable from the changer to the receiver jack as shown to the left. If your receiver has the SL16/XS8 mode select switch, set the connected receiver to the [SL16] mode. If you are connecting more than one Kenwood device with a system control cable, see "What If I Have Several Kenwood Devices?" for more information. 
5. Connect the SL16 text cable (communication cable) from the changer to the receiver's jack as shown to the left.
6. Plug the changer's power cable into a wall outlet or power strip.
7. Plug the receiver's power cord back into a wall outlet or power strip.

### To Connect the Changer to a Non-Kenwood Receiver or Preamp

1. Unplug the receiver or preamp from the wall outlet or power strip.
2. Connect the audio cable(s) from output on the CD changer to the receiver or preamp as shown to the left.
3. Connect an optional optical digital cable from the changer to the receiver as shown to the left. If your receiver does not support digital output and DTS decoding, skip this step. If you do not connect a digital cable or if your receiver does not support digital output, DTS discs do not play on your changer.
4. Plug the changer's power cable into a wall outlet or power strip.
5. Plug the receiver's power cable back into a wall outlet or power strip.

### To Connect the Digital Output Directly to a Digital Recorder (MD, DAT, etc.)

If your receiver does not support digital output, but you want to record discs to a digital format, you can connect the CD changer directly to a digital recording device, such as an MD or DAT recorder.

1. Unplug the digital recorder from the wall outlet or power strip.
2. Connect the digital cable from the changer to the recorder.
3. Plug the changer's power cable into a wall outlet or power strip.
4. Plug the recorder's power cable back into a wall outlet or power strip.

#### Malfunction of microcomputer

If operation is not possible or erroneous display appears even though all connections have been made properly, reset the microcomputer referring to "In case of difficulty". 

### In regard to PC LINK function

By connecting a PC to the CD player, disc and track title data can be downloaded from an on-line CD database site of Internet and registered in the CD player. The PC can also be used for direct title inputs or control of the CD player.

#### Software

To use this function, download its software from the following WWW site: <http://www.kenwoodusa.com>

#### Connection cable

Connect the CD changer to the PC using an RS-232C connection cable (**Reverse type**) which is available in computer stores.

- |                           |   |
|---------------------------|---|
| CD changer side connector | – D-sub 9-pin connector ( <b>Female</b> )                             |
| PC side connector         | – Use a cable equipped with a connector matching the computer in use. |

**RS-232C cables include the Reverse type cable for use in communications between PCs and the Straight type cable for use in connection between a PC and modem.**

**Use a Reverse type cable in the connection between the CD changer and PC.**

**The PC LINK function is not available if a Straight type cable is used.**

#### PC operating environment

This program has been designed to run on a PC which runs the Microsoft Windows® 95 or Windows® 98, uses a Pentium or newer CPU and has a free memory space of 32 MB or more.

Windows® 95 and Windows® 98 are either registered trademarks or trademarks of Microsoft Corporation in the United States and/or other countries.

# System Control Chaining

## 8 What if I Have Several Kenwood Devices?

System control allows you to :

- control connected devices via the receiver's remote control
- switch the receiver's input automatically to a connected device when you start playback from that device
- synchronize recording a CD or MD automatically when you start playback from those connected devices

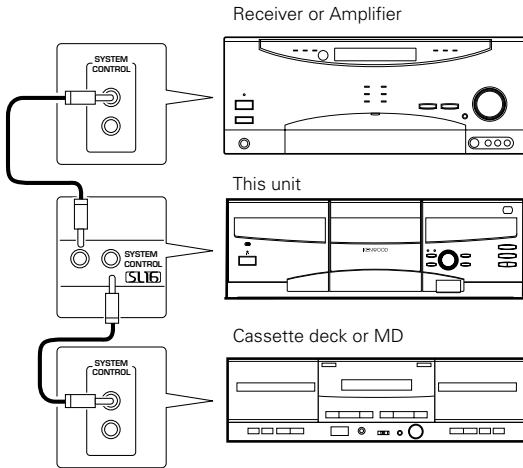

**This unit is compatible only with the [SL16] mode. The system control operation is not available if the unit is connected in the [XS8] connection mode.**

- You can connect the system control cord to either system control jack of the unit.
- If your component has the mode select switch, set the connected components to the [SL16] mode.  
(Ensure that the power plug is not connected.)



1. If your amplifier or receiver does not support system control, do not connect the system control cable to any device.
2. Some CD players and cassette decks do not support the SL16 system control mode. Do not include these devices in a set of SL16 chained connections.
3. Do not connect system control cables to any device not specified by Kenwood. Using system control functions with a device that does not support them can damage the device.
4. Make sure system control plugs are firmly seated in the appropriate jacks.



# Setting Up the 10-key Remote and Keyboard

## 10-key Remote

### To load Batteries

❶ Remove the cover.

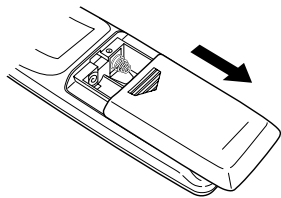

❷ Insert two AA batteries.

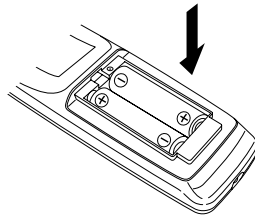

❸ Close the cover.

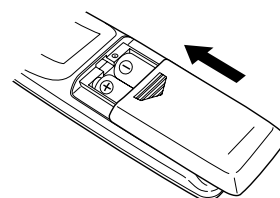

● Insert two AA-size (R6) batteries as indicated by the polarity marking.

The 10-key remote operates in the following range:

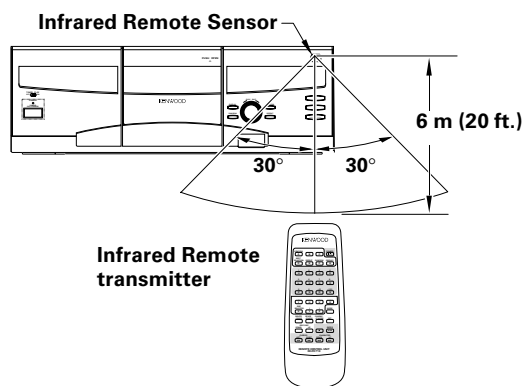

### Remote Operating Range

If you use the remote outside of this range, the remote will not operate correctly. As you use the remote, be aware of the following:

- The batteries that came with your new CD changer are intended to be used for operation checks and setup. Therefore, they may not last as long as ordinary batteries. Consider replacing them as soon as you have verified that the remote operates correctly.
- When the remote's operating range gets shorter, replace both batteries.
- Do not install the CD changer where direct sunlight or high-frequency fluorescent lighting can shine directly into the remote sensor. This can decrease the operating range of your remote.
- When pressing more than one remote control button successively, press the buttons securely by leaving an interval of 1 second or more between buttons.

## Keyboard

### To load Batteries

❶ Remove the cover.

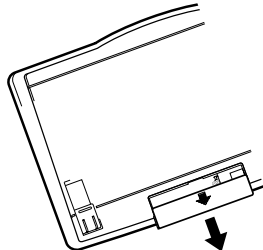

❷ Insert two AA batteries.

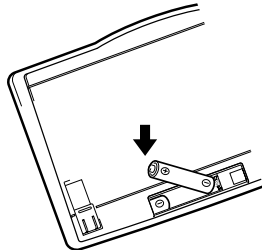

❸ Close the cover.

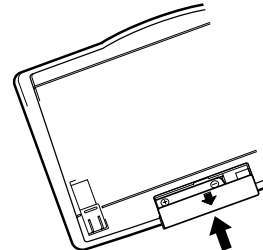

● Insert two AA-size (R6) batteries as indicated by the polarity marking.

The keyboard operates in the following range:

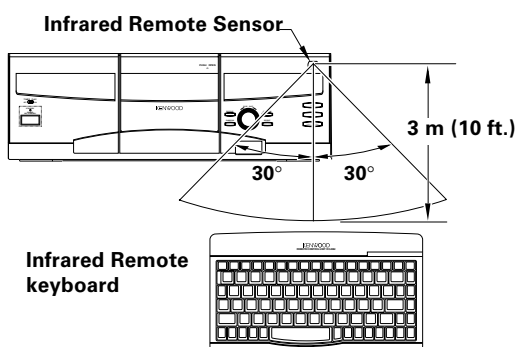

### Keyboard Operating Range

If you use the remote outside of this range, the remote will not operate correctly.

As you use the remote, be aware of the following:

- The batteries that came with your new CD changer are intended to be used for operation checks and setup. Therefore, they may not last as long as ordinary batteries. Consider replacing them as soon as you have verified that the keyboard operates correctly.
- When the remote's operating range gets shorter, replace both batteries.
- Do not install the CD changer where direct sunlight or high-frequency fluorescent lighting can shine directly into the remote sensor. This can decrease the operating range of your keyboard.
- When pressing more than one remote control button successively, press the buttons securely by leaving an interval of 1 second or more between buttons.

## Chapter 2 : Getting to know Your New CD Changer

### 10 Your new CD changer contains the following sophisticated features :

- **An easy-to-use front panel, remote and keyboard**
  - See "Front Panel" →  11
  - See "10-key Remote" →  13
  - See "Keyboard" →  14
- **Multiple front panel display format that allow you to view detailed information about the disc currently playing**
  - See "Front Panel Displays" →  12

Your CD changer includes a standard remote and a remote keyboard (for easier text entry). You can use either device to control the changer. For the sake of simplicity, this manual provides standard remote instructions for all functions except text entry.

# Front Panel

## DISPLAY

Play indicator      Text information display (The displays given in this manual are approximations only. They may differ from what actually appears on the display.)

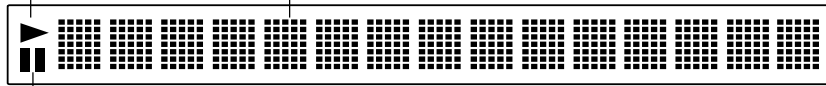

Pause indicator

### CD-4700M/CD-4260M

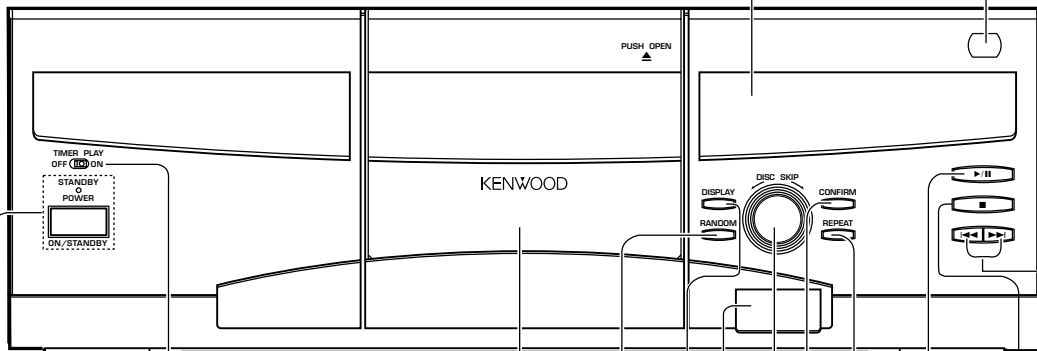

### CD-425M/DPF-J6030

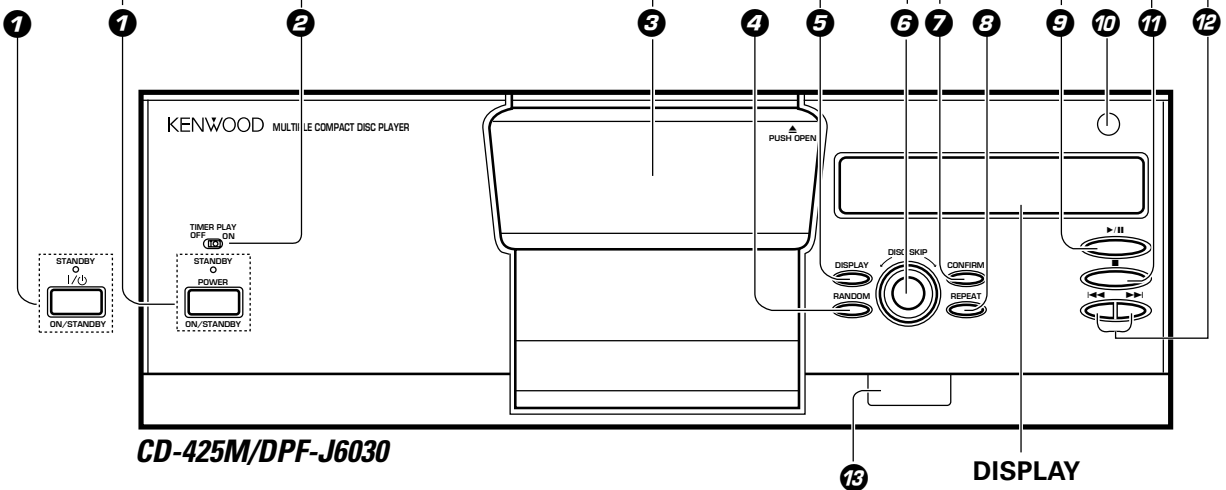

**1** POWER button/Standby indicator (For U.S.A. and Canada)

I/O button/STANDBY indicator (For other countries)

**2** TIMER PLAY switch

**3** Disc door

**4** RANDOM button

**5** DISPLAY button

**6** DISC SKIP knob

Used for disc selection. Characters are selected at the time of character input.

**7** CONFIRM button

**8** REPEAT button

**9** Play/pause (▶/II) button

**10** Remote sensor

**11** Stop (■) button

**12** Track skip button (◀◀, ▶▶)

Press to skip to the beginning of another track.  
Characters are selected at the time of title registration.

**13** LCD remote transmitter

The disc and track title data are output to the LCD remote control unit (provided with a KENWOOD Receiver or optional) through this window.

## Standby mode

While the standby indicator of the unit is lit, a small amount of current is flowing into the unit's internal circuitry to back up the memory. This condition is referred to as the standby mode of the unit. While the unit is in the standby mode, it can be turned ON from the remote control unit.

## 12 Front Panel Displays

This display shows information about the disc or track currently being played. Since some of the text information may be longer than can be displayed on one line, the text information scrolls, if necessary.

### Basic Info/Time Info

This display shows basic information like disc and track numbers as well as disc and track-specific time information (elapsed and remaining).

#### To change the display :

Press the DISPLAY button on the front panel, remote, or the keyboard until the information you want appears.

The panel display shows the following :

- ① Track title display (if the CD contains encoded title data or if you have entered title data)

▶ CONCERTO IN D

- ② Disc number/Track number display (the default if there is no title information)

▶ DISC123 TRACK01

- ③ Disc title display (if the CD contains encoded title data or if you have entered title data)

▶ LOVE LOVE LOVE

- ④ Elapsed time of current track

Disc #	Track #	Time
▶ D123	10	2:37

- ⑤ Remaining time of current track

Disc #	Track #	Time
▶ D123	10	-1:23

- ⑥ Elapsed time of current disc

Disc #	Track #	Time
▶ D123	10	36:25T

- ⑦ Remaining time of current disc

Disc #	Track #	Time
▶ D123	10	-23:45T

During Stop	During Play
<ul style="list-style-type: none"> <li>● In the <b>TRACK</b> mode, <b>MUSIC TYPE</b> mode, <b>USER FILE</b> mode, information is displayed in order of ③, ② then ④.</li> <li>● In the <b>PGM</b> mode, information is displayed in order of ①, ②, ③ then ④.</li> </ul>	<ul style="list-style-type: none"> <li>● In the <b>TRACK</b> mode, information is displayed in order of ①, ②, ③, ④, ⑤, ⑥ then ⑦.</li> <li>● In the <b>PGM</b> mode, <b>RANDOM</b> mode, <b>MUSIC TYPE</b>, <b>USER FILE</b> mode and <b>BEST SELECTION</b> mode, information is displayed in order of ①, ②, ③, ④ then ⑤.</li> </ul>

### Complete CD-Text Info

In the case of a CD-TEXT disc, the text information shown below is displayed automatically during normal play (TRACK mode).

#### To view complete text information :

1. Press MODE button on the remote or keyboard.
2. Use DISC SKIP (DOWN/UP) button on the remote or keyboard to select "ALL INFORMATION".
3. Press SET button on the remote or keyboard.

The display cycles through the following:

- ① Disc/Track Title
- ② Disc/Track Artist
- ③ Disc/Track Songwriter
- ④ Disc/Track Composer
- ⑤ Disc/Track Arranger
- ⑥ Disc/Track Message (such as a message from a sponsor or artist)
- ⑦ ID INFO. (such as record company, release date, etc.)
- ⑧ Genre INFO.

● Items from ① to ⑥ are displayed in the sequence of disc and track.

● If there is no information for any given area, the panel display "----". If the disc does not have factory-encoded CD Text disc or track information, "NO CD TEXT" appears for 3 seconds.

To view the next or previous information item, use DISC SKIP (DOWN/UP) button on the remote or keyboard.

To skip tracks, use Skip (|◀▶|)(DOWN/UP) button on the remote or keyboard.

To stop viewing text information, press MODE button on the remote or keyboard.



With a CD-TEXT disc, disc and track titles can be displayed without the limit on the number of characters when "ALL INFORMATION" is set. The disc and track titles are also displayed without the limit on the number of characters during playback or loading of a CD-TEXT disc.

# 10-key Remote and Keyboard

All operations can be controlled from both the 10-Key Remote and Keyboard remote control units.

## 10-key Remote

The buttons with the same name as those on the main unit operate the same way as on the main unit.  
The buttons marked \* are provided only on the remote control unit.

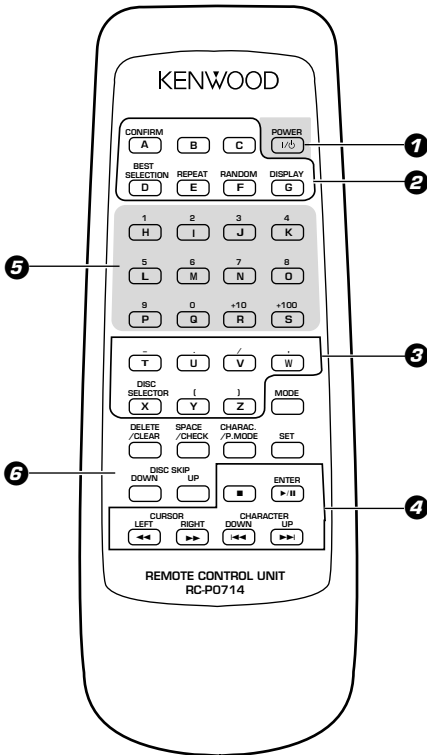

Model : RC-P0714  
Infrared ray system

### ① POWER(I / ⏻)

### ② Buttons for modes, display control and letters

- CONFIRM
- BEST SELECTION \*
- Used for best selection registration and playback.
- REPEAT
- RANDOM
- DISPLAY

### ③ Buttons for selecting discs and entering special characters

- DISC SELECTOR \*
- Press to select a disc number.
- Letter/special character buttons \*
- Used for selection of disc numbers, as well as for character input.

### ④ Buttons for basic operation

- Stop (■)
- ENTER/Play/Pause (▶/⏸)
- Search (◀◀, ▶▶), CURSOR (LEFT/RIGHT) \*
- Press to move the played position of disc at high speed. Used as cursor buttons at the time of character input.
- Skip (◀◀, ▶▶), CHARACTER (DOWN/UP)

### ⑤ Buttons for entering numbers and letters \*

- Used for selection of disc numbers and track numbers, as well as for character input.

### ⑥ Buttons for programming and data entry

- MODE \*
- Press to switch the mode.
- DELETE/CLEAR \*
- Used to delete the entered contents. At the time of character input, characters are deleted.
- SPACE/CHECK \*
- Used to confirm the entered contents. Inserts a space at the time of character input.
- CHARAC./P. MODE \*
- Used for playback mode switching. At the time of character input, this button switches between capital letters/small letters/numbers and special characters.
- SET \*
- Used for confirmation of mode settings. At the time of character input, one character is confirmed and the cursor goes to the next digit.
- DISC SKIP (DOWN/UP)

# 14 Keyboard

The buttons with the same name as those on the main unit operate the same way as on the main unit.  
The buttons marked \* are provided only on the remote control unit.  
Buttons masked with  are not used with this unit.

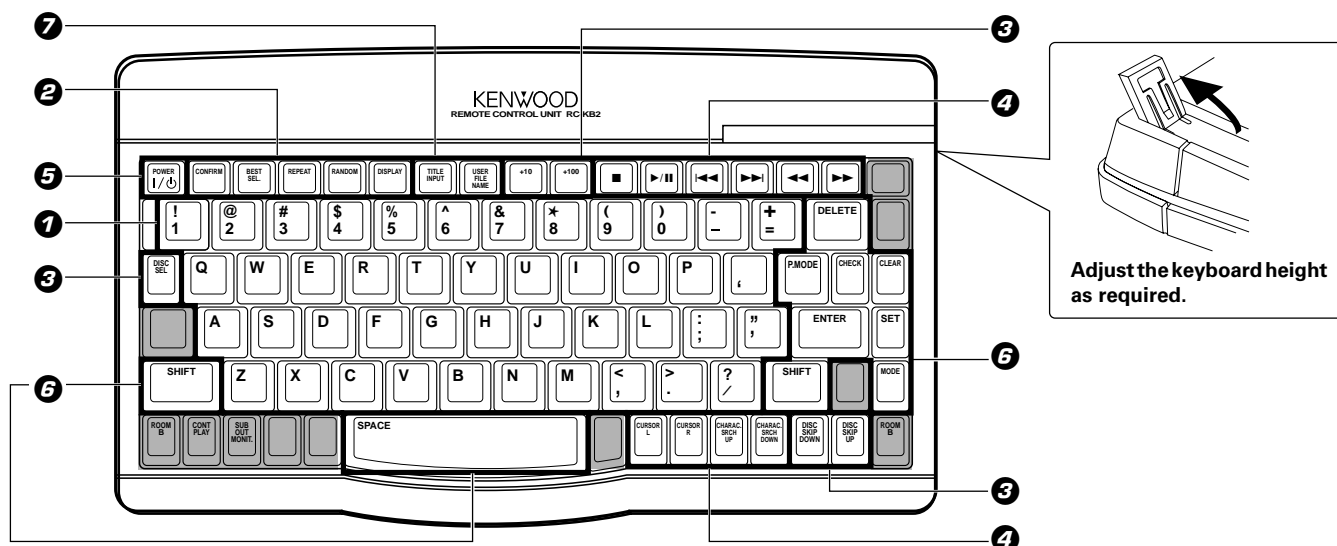

**Model : RC-KB2**  
Infrared ray system

## ① Input buttons for numbers and letters \*

Used for selection of disc numbers and track numbers, as well as for character input.

- 0~9 \*

## ② Buttons related to playback mode and display

- CONFIRM
- BEST SEL. \*
- Used for best selection registration and playback.
- REPEAT
- RANDOM
- DISPLAY

## ③ Disc selection buttons

- +10 \*
- +100 \*
- DISC SEL. \*
- Press to select a disc number.
- DISC SKIP (DOWN/UP)

## ④ Buttons for basic operation and character input

- Stop (■)
- Play/Pause (▶/⏸)
- Skip (⏮, ⏭)
- Search (⏪, ⏩) \*
- Press to move the played position of disc at high speed.
- CHARAC. SRCH UP/DOWN \*
- Characters are selected at the time of character input.
- CURSOR (L/R) \*
- Used as cursor buttons at the time of character input.

## ⑤ POWER (I/⏻)

## ⑥ Buttons related to program and file registration

- MODE \*
- Press to switch the mode.
- SET \*
- Used for confirmation of mode settings. At the time of character input, one character is confirmed and the cursor goes to the next digit.
- ENTER \*
- Used for title confirmation.
- SHIFT \*
- (These buttons are provided only on the Keyboard.)
- At the time of character input, this button switches between capital letters/small letters/numbers and special characters.
- P.MODE \*
- Used for playback mode switching.
- CHECK \*
- Used to confirm the entered contents.
- SPACE \*
- Inserts a space at the time of character input.
- DELETE \*
- At the time of character input, characters are deleted.
- CLEAR \*
- Used to delete the entered contents.

## ⑦ Shortcut buttons to the TITLE INPUT mode and FILE NAME INPUT mode.

- (These buttons are provided only on the Keyboard.)
- TITLE INPUT \*
  - USER FILE NAME \*

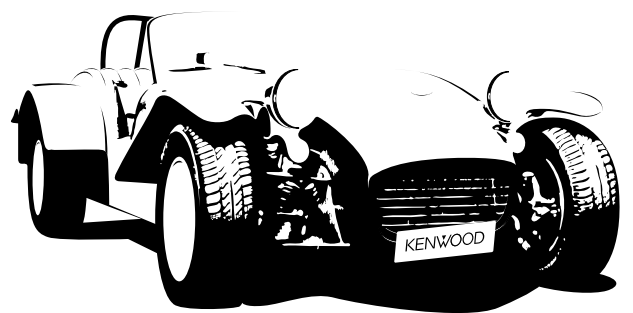

# Chapter 3 : Loading and Playing Discs

**16** *Your new CD changer contains a disc carousel that can store and play up to 200 discs using any of the following methods :*

- **Normal Play, where you play each disc in the order loaded**

Normal play (TRACK mode), where the CD changer acts like a regular CD player, playing the next disc in the queue from start to finish, then stopping.

See "Normal play (TRACK mode)" →  19

- **Repeat Play, which plays the tracks or discs over and over**

Repeat mode where the CD changer plays a particular disc or set of tracks over and over.

See "Repeated playback (REPEAT mode)" →  22

- **Random Play, which plays the tracks on the loaded CDs in random order**

Random mode where the CD changer plays all tracks on all discs loaded in the carousel in random order, without repeating any tracks.

See "Playback in a random order (RANDOM mode)" →  23

- **Programmed play order**

See "Programming tracks in desired order (PGM mode)" →  24

- **Timed Play, where you use an optional audio timer to automatically begin playing all CDs or only specified CDs**

See "Timer operation" →  26

Your CD changer includes a standard remote and a remote keyboard (for easier text entry). You can use either device to control the changer. For the sake of simplicity, this manual provides standard remote instructions for all functions except text entry.



# Preparation

Up to 200 CDs can be loaded in the carousel. Disc exchange also is possible during playback.

Never let your hand or any object enter inside the unit.

## Loading discs in the carousel

### 1 Switch power ON.

Press the POWER (I / ⏻) button.

Main unit

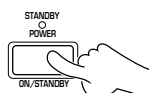

### 2 Open the disc door toward the front.

Press PUSH OPEN at the right top of the disc door.

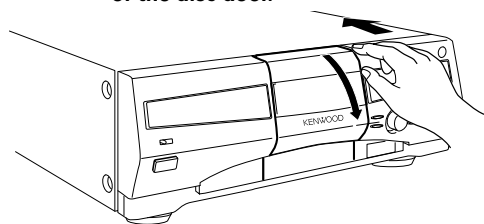

- Do not place any object on the open disc door.

### 3 Load discs.

1 Turn the DISC SKIP knob and bring the slot with the disc to be placed to the front.

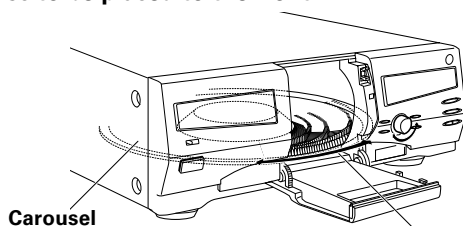

2 Insert the disc vertically.

Insert CDs with the label side facing toward your right.

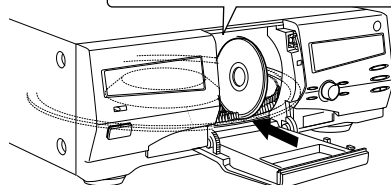

Insert one CD per slot all the way.

3 Repeat 1 and 2 to insert discs.

DISC001

The slot No. is displayed when the DISC SKIP knob is turned.



Insert discs with the label on the right side. Playback is not possible when a disc is inserted the other way round.

- Do not insert more than one disc in a slot.
- When a disc not corresponding to CD-TEXT is inserted, searching for this disc will be facilitated when the title is registered at the time of disc insertion.  
"Registration of Title "

Continued to next page

### Disc replacement

Discs can be replaced with the same procedure as "Loading discs in the carousel". In stopped condition, all discs can be exchanged. However, when the disc door is opened while "DISC DETECTION" is being displayed, it may not be possible to remove the disc which had been played. Accordingly, wait for the "DISC DETECTION" indication to go out before opening the disc door. When the disc information has been read in at the time of registration of disc information like title, music type, etc., the disc information can be recalled even when the disc insertion place is changed.

→ 29

### 4 Close the disc door.

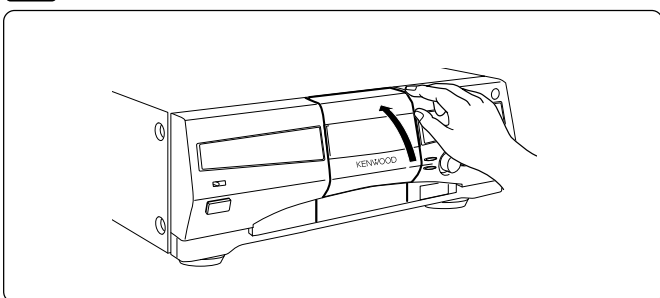

- When a title has been registered and the disc door is closed, reading operation is performed automatically.

The display flashes.

DISC DETECTION

### In regard to ALL DATA READ mode

The disc information for all discs will be read. We recommend to execute this mode before playback after discs have been exchanged. Close the disc door before operation.

#### 1 Press the MODE button.



#### 2 Select "ALL DATA READ".

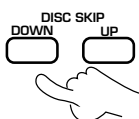

#### 3 Set the input.



To display the title on a LCD remote control unit (provided with a KENWOOD Receiver or optional), perform the all data read operation first, and operate the LCD remote control unit with the door left closed. For the operation of the LCD remote control unit, refer to the instruction manual provided with your receiver or LCD remote control unit.

#### Each press switches the modes as follows:

- ① MUSIC TYPE
- ② USER FILE
- ③ DISC SEARCH
- ④ TITLE INPUT
- ⑤ ALL DATA READ
- ⑥ ALL INFORMATION

ALL DATA READ

Search in progress or reading information

The display flashes.

DISC READING

When the disc is CD-TEXT

D001 : CD TEXT

- Repeat the above procedure so that the complete disc information is read into the CD player.
- In the case of a non-CD-TEXT disc, the "D001:NO CD TEXT" display will appear for approx. 3 seconds.

#### To quit ALL DATA READ mode

Press the ■ button.



1. Please remove all CDs from the carousel before moving the unit.
2. If blinking "PLEASE WAIT" is displayed when the disc door is opened, do not attempt to change the disc.

## Playing tracks in order from track No.1

Use the following procedure to play a CD in the original order of tracks from track No.1.

### 1 Select the disc.

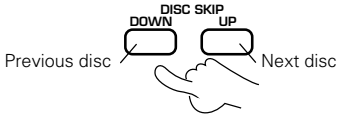

Go to step 2 within 8 sec.

- Each press of a button increases (or decreases) the disc number. Holding the button depressed varies the disc numbers successively.
- When the disc corresponds to CD-TEXT, or when the disc title has been registered, the disc title will be displayed with scrolling. Discs can be selected by the disc title.

"Registration of Title"



Display when disc No. 123 is selected

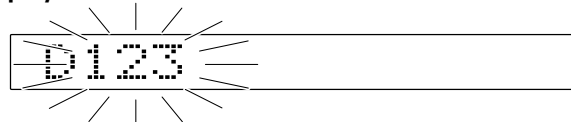

### 2 Start playback.



- When the disc corresponds to CD-TEXT, or when the track titles have been registered, the track title is displayed.

### To pause playback



- Each press pauses and plays the CD alternately.

### To stop playback



## Direct disc selection

1 Press the DISC SELECTOR button.



Within 8 seconds!

2 Input the disc number.

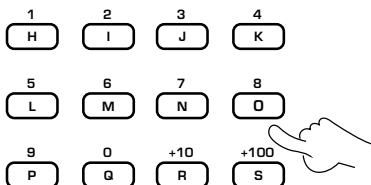

Within 8 seconds!

3 Start playback.



Press the numeric buttons in the following order...

Disc No. 63 : 6, 3

Disc No. 100 : 1, 0, 0

### How to input numeric values

The input method for this product is of two different types. One can either use the traditional KENWOOD +10 button approach, or direct numeric input.

#### Special input method for CD player with 200-disc changer

To input 42 : 4, 2

To input 115 : 1, 1, 5

To input 200 : 2, 0, 0

#### Same input method as other KENWOOD products

To input 42 : +10, +10, +10, +10, 2

To input 115 : +100, +10, 5

To input 200 : +100, +100

### What is the "normal play TRACK mode"?

Playback is made from the first track. The normal playback mode is called TRACK mode. Press the CONFIRM button to confirm the present mode.



TRACK mode

▶ TRACK D120 T02

PGM mode

▶ PGM01 D131 T02

BEST SELECTION mode

▶ BEST01 D104 T03

MUSIC TYPE mode

▶ M. TYPE Rhythm

USER FILE mode

▶ U. FILE USER FI

RANDOM mode

▶ ONE DISC RANDOM

REPEAT mode

▶ REPEAT ON

### To set the unit to the TRACK mode:

At the time of PGM mode:  
Press the PMODE button.



At the time of BEST SELECTION mode:  
Press the ■ button during playback.



At the time of MUSIC TYPE or USER FILE mode:  
Press the MODE button.

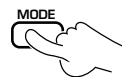

At the time of RANDOM mode:  
Select "RANDOM OFF".



At the time of REPEAT mode:  
Select "REPEAT OFF".



## Playback from desired track

### 1 Select the disc.

#### 1 Select the disc number.

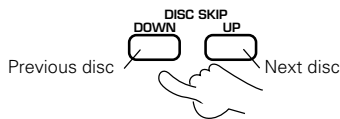

Within 8 seconds!

#### 2 Set the input.



Go to step 2 within 8 sec.

#### Display when disc No. 123 is selected

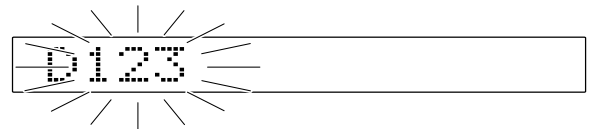

- The disc number can be selected directly by using the **DISC SELECTOR** button and numeric buttons in place of the **DISC SKIP(DOWN/UP)** buttons.
- When the disc corresponds to CD-TEXT, or when the disc title has been registered, the disc title will be displayed with scrolling. Discs can be selected by the disc title.
- "Registration of Title" 
- Repeat step 1 when it is required to change the disc number.

### 2 Select the track number.

#### 1 Input the track number.

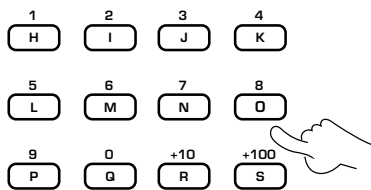

Within 8 seconds!

#### 2 Set the input.



#### Press the numeric buttons in the following order...

- Track No.8 : 8
- Track No.14 : 1, 4
- Track No.20 : 2, 0

#### Display when track No. 8 is selected

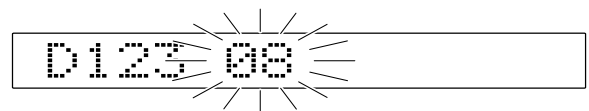

- Playback starts.
- When the disc corresponds to CD-TEXT, or when the disc title has been registered, the track title is displayed. Tracks can be selected by the track title.
- Repeat step 2 when it is required to change the track number.

## Skipping tracks

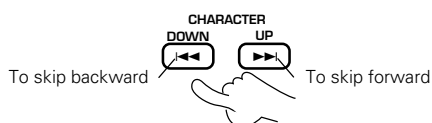

- When the  button is pressed once during playback, the track being played will be played from the beginning.

## Searching

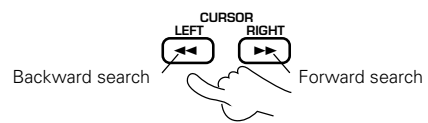

- Playback starts from the position where the button is released.

# Repeated playback (REPEAT mode)

## To repeat only the desired tracks

❶ Program the desired tracks by performing steps ❶ to ❸ of "Programming tracks in desired order". → 24

❷ Switch REPEAT ON.



❸ Start playback.



- Up to 32 tracks can be programmed by repeating steps ❶.



- The current status is displayed when the button is pressed once. When it is pressed while the status is displayed, the repeat ON status can be set to OFF (or vice versa).
- All of the programmed tracks will be repeated.
- In case only one track is programmed, only that track will be repeated.

### To cancel repeated playback

Press the REPEAT button twice. (REPEAT ON → OFF)

## To repeat one selected disc

❶ Check that the unit is in the normal play TRACK mode. → 20

❷ Select the disc number.

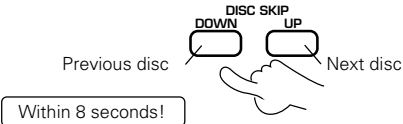

❸ Start playback.



❹ Switch REPEAT ON.



- The disc number can be selected directly by using the DISC SELECTOR button and numeric buttons in place of the DISC SKIP(DOWN/UP) buttons.

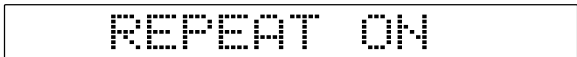

- The current status is displayed when the button is pressed once. When it is pressed while the status is displayed, the repeat ON status can be set to OFF (or vice versa).

### To cancel repeated playback

Press the REPEAT button twice. (REPEAT ON → OFF)

For random repetition



For music type repetition



For user file repetition



For best selection repetition



# Playback in a random order (RANDOM mode)

Use the following procedure to activate random playback which selects a track at random after every track. This feature may allow you to play CDs for long hours without getting tired of.

**1** Check that the unit is in the normal play TRACK mode. → 20

**2** Select discs.

### To select one disc

① Select the disc number.

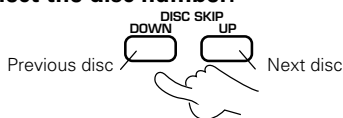

Within 8 seconds!

② Start playback.



③ Select "ONE DISC RANDOM".



• The disc number can be selected directly by using the **DISC SELECTOR** button and numeric buttons in place of the **DISC SKIP(DOWN/UP)** buttons.

Each press switches the modes as follows:

- ① ONE DISC RANDOM
- ② ALL DISC RANDOM
- ③ RANDOM OFF

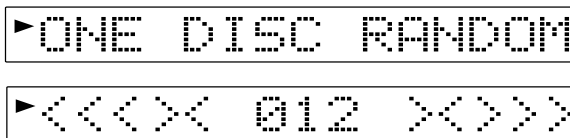

The number here changes.

- Each time a track ends, the same operation as above is repeated, and the track selected next is played.
- Random play stops after all of the tracks have been played once.

### To select all discs

Select "ALL DISC RANDOM".



### For repeated playback

Press the REPEAT button to select "REPEAT ON".

### To select another track in the middle of playing one

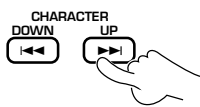

- Pressing the **CHARACTER DOWN** button once returns to the beginning of the track being played.

### To cancel random playback

Select "RANDOM OFF".

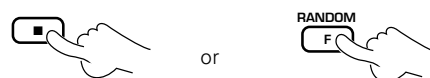

- Press the **STOP** button to stop playback.
- Normal playback will be performed when **RANDOM OFF** is selected.

For random music type

→ 32

For random user file

→ 34

# Programming tracks in desired order (PGM mode)

Use the following procedure to select desired tracks (up to 32 tracks) from different discs and program them in the desired order.

## Preparation

- Set the CD player to stop mode.

### 1 Press so that the "PGM" indicator lights.



PGM SELECT DISC

### 2 Select the disc.

#### 1 Select the disc number.

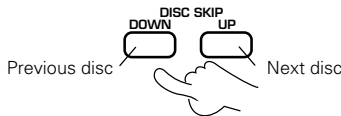

Within 8 seconds!

#### 2 Set the input.



Go to step 3 within 8 sec.

PGM01 D200

- The disc number can be selected directly by using the **DISC SELECTOR** button and numeric buttons in place of the **DISC SKIP (DOWN/UP)** buttons.
- When the disc corresponds to CD-TEXT, or when the disc title has been registered, the disc title will be displayed with scrolling. Discs can be selected by the disc title.  
"Registration of Title"
- If you make a mistake, press the **CLEAR** button and enter the disc No. from the beginning.

### 3 Select the track number.

#### 1 Input the track number.

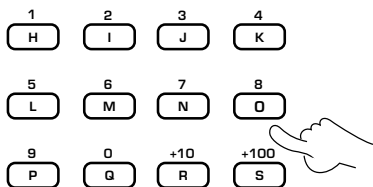

Within 8 seconds!

#### 2 Set the input.



#### Press the numeric buttons in the following order...

Track No.8 : 8

Track No.14 : 1, 4

Track No.20 : 2, 0

PGM01 D200 T-----

- To program the entire disc, press the **SET** button without inputting the track number. "ALL" will be displayed.
- Program other tracks in the desired order by repeating steps 2 and 3.
- Up to 32 tracks can be programmed. "FULL" is displayed when no more tracks can be programmed.
- If you make a mistake, press the **CLEAR** button and restart from step 2.
- When the disc corresponds to CD-TEXT, or when the disc title has been registered, the track title is displayed. Tracks can be selected by the track title.

### 4 Start playback.



- Tracks will be played in the order they are programmed.
- When the **◀◀** or **▶▶** button is pressed during playback, the track will be skipped in the direction of the pressed button.



### To check the programmed tracks

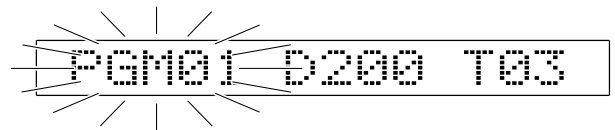
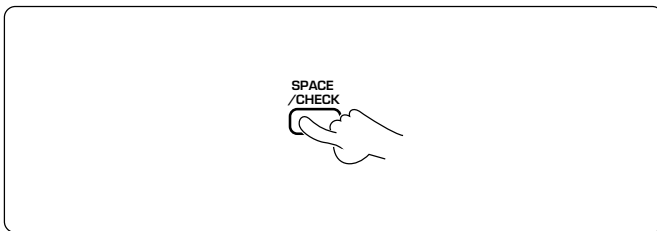

- Each time the button is pressed, the program No. and the disc No. are displayed.
- The previous display resumes in a few seconds.

### To add a track to the program

- 1 Set the CD player to stop mode.
- 2 Perform steps 2 and 3 of "Programming tracks in desired order". → 24

- When a track No. is entered, the track will be added to the end of the existing program.

### To change a track in the program

- 1 Set the CD player to stop mode.
- 2 Press the CHECK button.
- 3 Perform steps 2 and 3 of "Programming tracks in desired order". → 24



- Press the CHECK button repeatedly until the program No, to be changed is displayed.

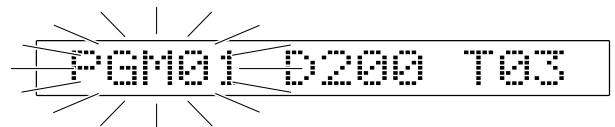

Example

- Press it while the "PGM01" indicator blinks.
- The track being played cannot be changed.

### To clear tracks from the program

#### To clear tracks from the end



- Each time the button is pressed, the last track in the program is cleared.
- The tracks which are programmed earlier than the track being played cannot be cleared.

#### To clear all tracks



- When the P.MODE button is pressed during playback, playback in order of tracks starts from the track being played.

# Timer operation

26

As this unit incorporate the timer standby function, playback can be started at desired moment if a commercially available audio timer is combined with this unit.

## Preparation

- Close the disc door. 
- Connect the system components so that their power can be switched on by the timer.
- Read the instruction manual of the timer carefully.

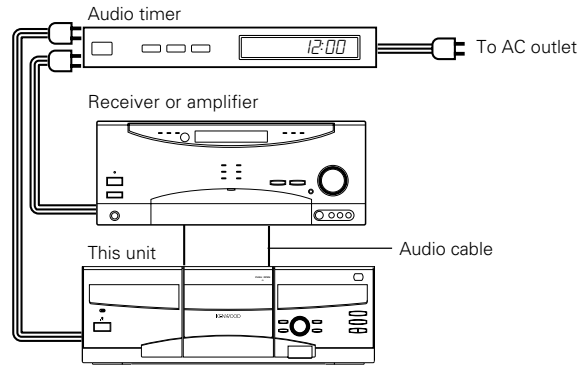

**1** Set the power switches of the system components to the ON positions.

**2** Select the disc to be played.

① Select the disc number.

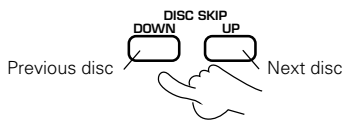

Within 8 seconds!

② Play the disc.



**3** Set the listening volume.

① Adjust the volume on the amplifier or receiver.

② Stop playback.

**4** Set the timer for the desired ON time.

**5** Set the **TIMER PLAY** switch to ON.

TIMER PLAY  
OFF ON

Main unit



- The disc number can be selected directly by using the **DISC SELECTOR** button and numeric buttons in place of the **DISC SKIP(DOWN/UP)** buttons.

- Read the instruction manual of the timer carefully.

- When the set time comes, playback will start automatically.
- The playback mode will be TRACK mode.

# Chapter 4 : Specifying and Using Disc or Track Data

Thanks to sophisticated design and onboard memory storage, your CD changer can read and store additional information about the discs you load, enabling you to choose discs by title information rather than just disc position.

This memory feature means you don't have to remember what disc is stored in which slot or spend time creating a list of what you've loaded.

Here's how it works: every CD has an unique ID code embedded in it. The changer reads this code and associates with it any other information that it reads or that you enter for the disc. It stores the information internally so that when you load or play the disc, the changer still contains the disc and track titles (among other things).



1. Your CD changer will recall information read in at the time of registration even when the disc insertion place is changed.
2. Your changer stores this information for up to 210 discs, which allows you to rotate discs between the changer and another CD player (for example, in your car) without losing any information read.

## The CD changer can :

- read data from discs containing encoded CD Text information
- store disc and title information you enter using the 10-key remote, keyboard or LCD remote\*
- allow you to, when a PC is connected to the CD player, download disc and track titles of a CD from an on-line CD database site of the Internet and register them in the CD player. The PC can also be used for direct title inputs or control of the CD player.
- allow you to use the read or entered data to select discs
- allow you to program disc play for custom listening order

\* VR-4900, KRF-V9993D and VR-4700 (Model available may differ depending on the country and sales area.)

The remote control unit of these receiver models can also be used to input titles or display information such as the titles.

The changer reads any data you specify when you play the disc or when you instruct the changer to read all data.

Your CD changer includes a standard remote and a remote keyboard.

You can use either device to control the changer. For the sake of simplicity, this manual provides standard remote instructions for all functions except text entry

## You can use this internal processing to control various features, such as :

- Playing discs of a predefined or user-specified Music Type that you can assign to each CD  
See "Listening to music by genre (MUSIC TYPE mode)" → 31
- Playing discs of a predefined or user-specified User-File that you can assign to each CD  
See "Reorganizing discs to desired groups (USER FILE mode)" → 33
- Playing discs by selecting disc titles, either read from CD Text encoding on the CD or entered using the remote or keyboard  
See "Disc search (DISC SEARCH mode)" → 37
- Assigning Best Selection status to your favorite tracks, then playing them at any time.  
See "Listening to your favorite titles (BEST SELECTION mode)" → 40

# Registration of Title

For discs not corresponding to CD-TEXT, a title can be given to the disc (max. 25 characters). Up to 20 tracks titles can be registered per disc. Operation is possible also when the disc door is open. We recommend to register titles while discs are being inserted.

## Preparation

- Set the CD player to stop mode.
- Check that the unit is in the normal play TRACK mode. → 20

Although all operations can be controlled from both the 10-Key Remote and Keyboard remote control units, do not change the remote control unit in the middle of operation such as character input. Otherwise, characters may not be input correctly.

Allow you to, when a PC is connected to the CD player, download disc and track titles of a CD from an on-line CD database site of the Internet and register them in the CD player. The PC can also be used for direct title inputs or control of the CD player.

## Assigning Title (TITLE INPUT mode)

### 1 Switch to title input mode.

**10-Key Remote**

① Select "TITLE INPUT".

② Set the input.

**Keyboard**

Press the TITLE INPUT button.

### 10-Key Remote

- When the **MODE** button is pressed during TITLE INPUT mode, the title input mode is cancelled.

### Keyboard

- When the **TITLE INPUT** button is pressed during TITLE INPUT mode, the title input mode is cancelled.

The display flashes.

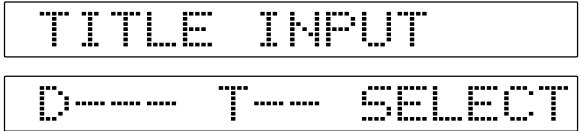

- To enter track titles without assigning the disc title, go to "To enter the track title" → 29

### 2 Enter the title.

**To enter the disc title**

**10-Key Remote**

① Select the disc number.

② Set the input.

③ Enter the disc title.

④ Store the disc title.

**Keyboard**

① Select the disc number.

② Set the input.

③ Enter the disc title.

④ Store the disc title.

- The disc number can be selected directly by using the numeric buttons in place of the **DISC SKIP(DOWN/UP)** buttons.
- During playback, the disc only being played can be selected.

### 10-Key Remote

### Main unit

- If a desired character is not provided on the remote control buttons, input the character as follows. Press the **CHARACTER (DOWN/UP)** buttons or rotating the **DISC SKIP** knob until the desired character is displayed in the flashing cursor position. Then, press the **SET** button.

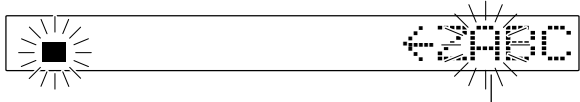

Flashing cursor

- One character is set and the cursor goes to the next digit.
- Repeat this to enter the disc title.



1. For discs corresponding to CD-TEXT, a new title can not be registered.
2. As the entered title and the CD-TEXT title information are memorized, the information may be displayed even when a disc has been removed.



- To register the disc title of another disc, repeat the entire procedure of "To enter the disc title".

**In regard to disc information reading**

The entered title is read in to the disc with the following timing.

- When the disc door is closed.
- With closed disc door, when title input mode is finished.

The display flashes.



When there are discs for which the disc information already has been read in, there may be no display.

**Do not move or exchange discs until the disc information has been read in.**

**To enter the track title**

**10-Key Remote**

**Keyboard**

① Select the track number.

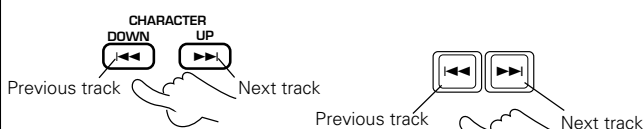

② Press the SET button.



③ Enter the track title.

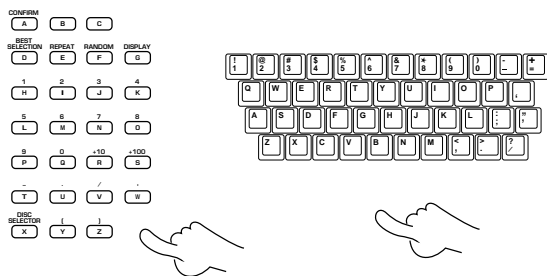

④ Store the track title.



**10-Key Remote**   **Main unit**

- If a desired character is not provided on the remote control buttons, input the character as follows. Press the **CHARACTER (DOWN/UP)** buttons or rotating the **DISC SKIP** knob until the desired character is displayed in the flashing cursor position. Then, press the **SET** button.

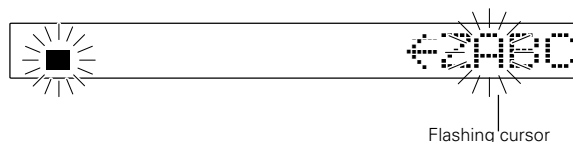

- One character is set and the cursor goes to the next digit.
- Repeat this to enter the track title.



- To register another track titles in the same disc, repeat the entire procedure of "To enter the track title".
- Up to 20 track titles can be registered per disc by repeating steps from ① to ④ for each.

**To quit TITLE INPUT mode**

Press the **MODE** button.

**10-Key Remote**

- The type of characters which can be entered is switched each time the **CHARAC.** button is pressed.

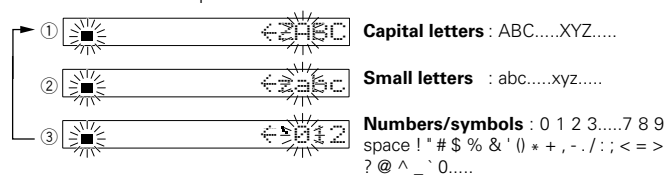

**Keyboard**

- To input a small (lowercase) letter or a symbol, press and hold **SHIFT** while press the desired character or numeric/symbol button.

**To change the character type**

**10-Key Remote**

**Keyboard**



Holding this button down, press a character or numeric button.

**Preparation**

- Close the disc door.



## To change or delete a title

**1** Perform steps **1** and **2-1,2** of "Assigning Title".

- Call the disc or track to be changed.
- Deletion mode is cancelled when the **MODE** button is pressed.

**2** Change or delete characters one by one.



### Change

10-Key Remote

Keyboard

**1** Move the cursor to the desired character (to be changed).

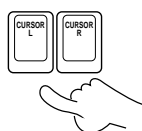
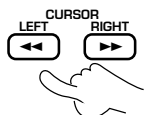

**2** Select a character.

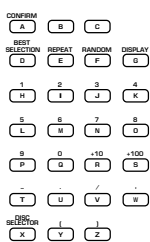

**3** Delete the unnecessary character.  
(See "Deletion".)



← Move with the **CURSOR** button →

- If the title to be changed is too long to be displayed on the display section, press the **CURSOR** button to scroll the display so that the characters hidden until then appear.
- No character can be changed if 25 characters have already been input. In this case, delete unnecessary characters then enter the desired correction characters.



Flashing cursor

10-Key Remote

Main unit

- If a desired character is not provided on the remote control buttons, input the character as follows. Press the **CHARACTER (DOWN/UP)** buttons or rotating the **DISC SKIP** knob until the desired character is displayed in the flashing cursor position. Then, press the **SET** button.

### Deletion

10-Key Remote

Keyboard

**1** Move the cursor to the desired character (to be deleted).

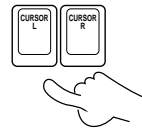
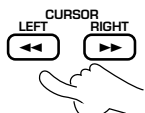

**2** Press the **DELETE** button.



### To enter a space

10-Key Remote

Keyboard

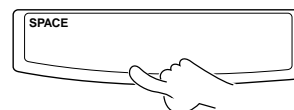

- When a title is to be deleted, delete all characters one by one.

**3** Execute title change or deletion.

10-Key Remote

Keyboard



**To quit TITLE INPUT mode**  
Press the **MODE** button.

# Listening to music by genre (MUSIC TYPE mode)

Discs can be registered separately by 26 types of music genres.

## Preparation

- Close the disc door. → 18
- Check that the unit is in the normal play TRACK mode. → 20

## Registration of music type (MUSIC TYPE SET mode)

### 1 Activate the music type set mode.

① Press the **MODE** button.

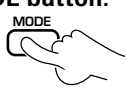

② Select "MUSIC TYPE".

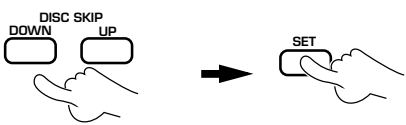

③ Select "MUSIC TYPE SET".

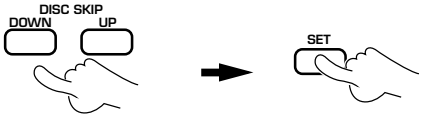

- When the **MODE** button is pressed during MUSIC TYPE SET mode, the MUSIC TYPE SET mode is cancelled.

Each press switches the modes as follows:

- ① MUSIC TYPE
- ② USER FILE
- ③ DISC SEARCH
- ④ TITLE INPUT
- ⑤ ALL DATA READ
- ⑥ ALL INFORMATION

The display flashes.



The display flashes.



### 2 Select the music type.

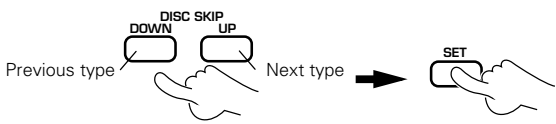

Each press switches the modes as follows:

- Adult Contemporary → Alternative Rock → Children's Music → Classical → Contemporary Christian → Country → Dance → Easy Listening → Folk → Gospel → Hip Hop → Jazz → Latin → Musical → New Age → Opera → Operetta → Pop Music → RAP → Reggae → Rock Music → Rhythm & Blues → Sound Effects → Sound Track → Spoken Word → World Music → Adult Contemporary → .....

When "Rock Music" is selected



- When the selected disc corresponds to CD-TEXT and contains a genre code, that genre code is registered as the music type.

To confirm the genre code ...  
"Complete CD-Text Info"



### 3 Select the desired disc.

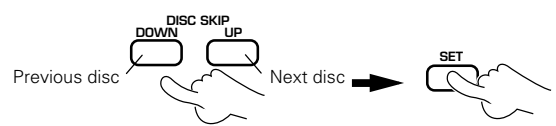



- The disc number can be selected directly by using the numeric buttons in place of the **DISC SKIP(DOWN/UP)** buttons.
- Repeat step 2 if it is required to register another disc in the music type selected above.
- To register another music type, exit the MUSIC TYPE SET mode once and restart from the beginning.

To quit **MUSIC TYPE SET mode**  
Press the **MODE** button.

When music types have been registered for the discs, it is possible to enjoy playback of discs of the selected music type. Random playback for a selected music type is also possible.

**Preparation**

- Close the disc door.  18
- Register music type.  31
- Check that the unit is in the normal play TRACK mode.  20

**Playing the music type (MUSIC TYPE PLAY mode)****1 Activate the music type play mode.**

**1 Press the MODE button.**



**2 Select "MUSIC TYPE".**

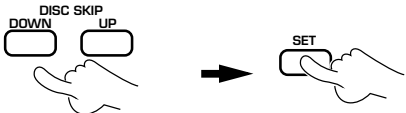

**3 Select "MUSIC TYPE PLAY".**

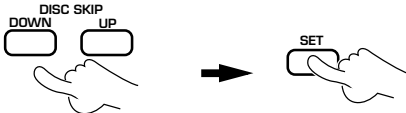

- When the **MODE** button is pressed during MUSIC TYPE PLAY mode, the MUSIC TYPE PLAY mode is cancelled.

Each press switches the modes as follows:

- ① MUSIC TYPE
- ② USER FILE
- ③ DISC SEARCH
- ④ TITLE INPUT
- ⑤ ALL DATA READ
- ⑥ ALL INFORMATION

The display flashes.

MUSIC TYPE

The display flashes.

MUSIC TYPE PLAY

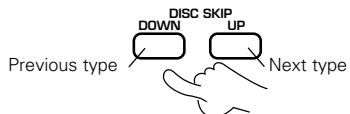
**2 Select the music type.**

Previous type      Next type

When "Adult Contemporary" is selected

Adult Contemporar

← Scroll display

**3 Start playback.**

- Playback is performed in increasing order of the disc numbers they were registered for the respective music type. Skipping to the next disc is done when the ►| button is pressed.
- Each time the **CHECK** button is pressed, the registered disc numbers are displayed in increasing order of the disc numbers.

**For repeated playback**

Press the **REPEAT** button to select "REPEAT ON".

**For random playback**

Press the **RANDOM** button.

- Select "RANDOM OFF" or press ■ button to quit random playback.

**To clear the music type registered for a disc**

Press the **CLEAR** button during playback of the disc to be deleted.

D122 TYPE CLEAR

**To quit MUSIC TYPE PLAY mode**

Press the **MODE** button.

M. TYPE MODE OFF



# Reorganizing discs to desired groups (USER FILE mode)

Eight user files are available for registering desired discs. This makes the user possible to create files registering the discs of a favorite artist(s) or the user's favorite discs. The user files can be named as desired.

## Preparation

- Close the disc door. → 18
- Check that the unit is in the normal play TRACK mode. → 20

## Registration of user file (USER FILE SET mode)

### 1 Activate the user file set mode.

- 1 Press the **MODE** button.



- 2 Select "USER FILE".



- 3 Select "USER FILE SET".

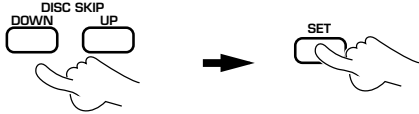

- When the **MODE** button is pressed during USER FILE SET mode, the USER FILE SET mode is cancelled.

Each press switches the modes as follows:

- 1 MUSIC TYPE
- 2 USER FILE
- 3 DISC SEARCH
- 4 TITLE INPUT
- 5 ALL DATA READ
- 6 ALL INFORMATION

The display flashes.

USER FILE

The display flashes.

USER FILE SET

### 2 Select the desired user file.

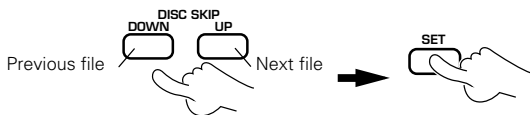

Each press switches the modes as follows:

USER FILE 1 → USER FILE 2 → USER FILE 3 → USER FILE 4 →  
USER FILE 5 → USER FILE 6 → USER FILE 7 → USER FILE 8 →  
USER FILE 1 → .....

- If user file names have already been registered, their names are displayed in place of the above.

"Assigning user file names"

→ 35

### 3 Select the desired disc.

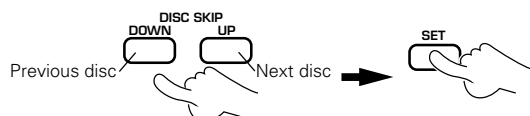

- The disc number can be selected directly by using the numeric buttons in place of the **DISC SKIP(DOWN/UP)** buttons.
- Repeat step 2 if it is required to register another disc in the user file selected above.
- To register another user file, exit the USER FILE SET mode once and restart from the beginning.
- The same disc can be registered in more than one user files.
- If the **CHECK** button is pressed while the disc number is blinking, the music type of the disc is displayed provided that its music type has been registered.

**To quit USER FILE SET mode**  
Press the **MODE** button.

When user files have been registered for the discs, it is possible to enjoy playback of discs of the selected user file. Random playback for a selected user file is also possible.

**Preparation**

- Close the disc door. → 18
- Register user file. → 33
- Check that the unit is in the normal play TRACK mode. → 20

## Playing the user file (USER FILE PLAY mode)

### 1 Activate the user file play mode.

① Press the **MODE** button.

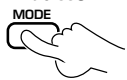

② Select "USER FILE".

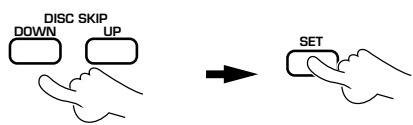

③ Select "USER FILE PLAY".

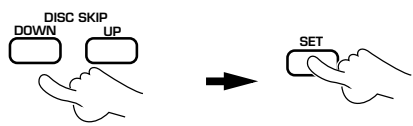

- When the **MODE** button is pressed during USER FILE PLAY mode, the USER FILE PLAY mode is cancelled.

Each press switches the modes as follows:

- ① MUSIC TYPE
- ② USER FILE
- ③ DISC SEARCH
- ④ TITLE INPUT
- ⑤ ALL DATA READ
- ⑥ ALL INFORMATION

The display flashes.

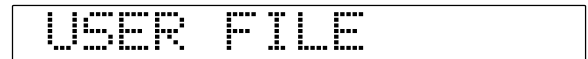

The display flashes.

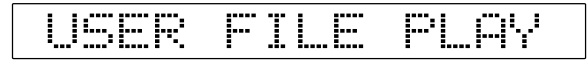

### 2 Select the user file.

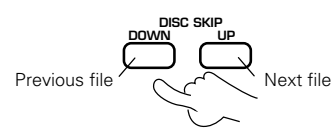

When "USER FILE 1" is selected

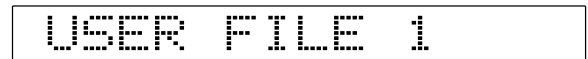

- If user file names have already been registered, their names are displayed in place of the above.

"Assigning user file names"

→ 35

### 3 Start playback.



- Playback is performed in increasing order of the disc numbers they were registered for the respective user file. Skipping to the next disc is done when the ► button is pressed.
- Each time the **CHECK** button is pressed, the registered disc numbers are displayed in increasing order of the disc numbers.

#### For repeated playback

Press the **REPEAT** button to select "REPEAT ON".

#### For random playback

Press the **RANDOM** button.

- Select "RANDOM OFF" or press ■ button to quit random playback.

#### To clear the user file registered for a disc

Press the **CLEAR** button during playback of the disc to be deleted.

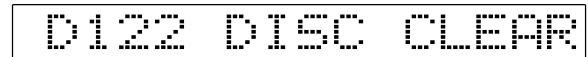

#### To quit USER FILE PLAY mode

Press the **MODE** button.



**Preparation**

- Close the disc door.
- Register user file.
- Check that the unit is in the normal play TRACK mode.

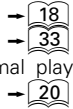

Although all operations can be controlled from both the 10-Key Remote and Keyboard remote control units, do not change the remote control unit in the middle of operation such as character input. Otherwise, characters may not be input correctly.

## Assigning user file names (FILE NAME INPUT mode)

### 1 Activate the file name input mode.

10-Key Remote	Keyboard
<p>① Press the MODE button.</p>	
<p>② Select "USER FILE".</p>	<p>Press the USER FILE NAME button.</p>
<p>③ Select "FILE NAME INPUT".</p>	

**10-Key Remote**

- When the MODE button is pressed during FILE NAME INPUT mode, the FILE NAME INPUT mode is cancelled.

**Keyboard**

- When the USER FILE NAME button is pressed during FILE NAME INPUT mode, the FILE NAME INPUT mode is cancelled.

Each press switches the modes as follows:

- ① MUSIC TYPE
- ② USER FILE
- ③ DISC SEARCH
- ④ TITLE INPUT
- ⑤ ALL DATA READ
- ⑥ ALL INFORMATION

The display flashes.

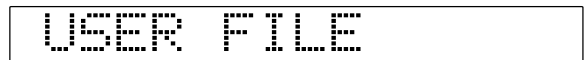

The display flashes.

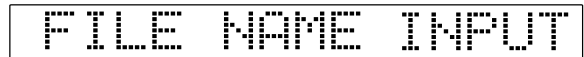

### 2 Select the desired user file.

10-Key Remote	Keyboard
<p>① Select the desired user file.</p>	
<p>② Set the input.</p>	

Each press switches the modes as follows:

USER FILE 1 → USER FILE 2 → USER FILE 3 → USER FILE 4 → USER FILE 5 → USER FILE 6 → USER FILE 7 → USER FILE 8 → USER FILE 1 →.....

- If user file names have already been registered, their names are displayed in place of the above.

### 3 Enter the file name.

### 4 Store the file name.

10-Key Remote	Keyboard

- For the character input procedure, see step 2-3 in "Assigning Titles".

- A file name can be registered using up to 25 characters.



**To quit FILE NAME INPUT mode**  
Press the MODE button.

### To change or delete a file name

10-Key Remote	Keyboard
<p>① Perform steps 1 and 2 above.</p> <p>② For the character correction and deletion procedure, see "To change or delete a title".</p> <p>③ Press the ENTER button.</p>	

**Preparation**

- Close the disc door. → 18
- Register user file. → 33
- Check that the unit is in the normal play TRACK mode. → 20

## To clear the user file (USER FILE CLEAR mode)

The following procedure clears the registration of all discs in the user files and the user file names. The user file names return the default names after clear.

### 1 Activate the user file clear mode.

**1 Press the MODE button.**

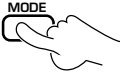

**2 Select "USER FILE".**

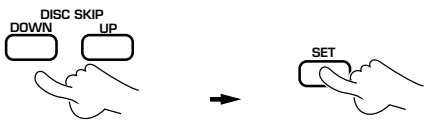

**3 Select "USER FILE CLEAR".**



- When the **MODE** button is pressed during USER FILE CLEAR mode, the USER FILE CLEAR mode is cancelled.

Each press switches the modes as follows:

- ① MUSIC TYPE
- ② USER FILE
- ③ DISC SEARCH
- ④ TITLE INPUT
- ⑤ ALL DATA READ
- ⑥ ALL INFORMATION

The display flashes.

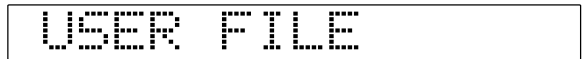

The display flashes.



### 2 Select the user file to be deleted.

**1 Select the user file to be deleted.**

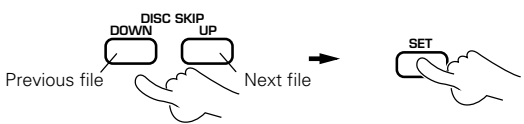

**2 Set the input.**



Each press switches the modes as follows:

USER FILE 1 → USER FILE 2 → USER FILE 3 → USER FILE 4 →  
 USER FILE 5 → USER FILE 6 → USER FILE 7 → USER FILE 8 →  
 USER FILE 1 →.....

- If user file names have already been registered, their names are displayed in place of the above.

The display flashes.

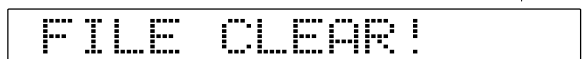

### To quit USER FILE CLEAR mode

Press the **MODE** button.

# Disc search (DISC SEARCH mode)

## Preparation

- Close the disc door.
- Input the title.
- Check that the unit is in the normal play TRACK mode.

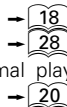

Although all operations can be controlled from both the 10-Key Remote and keyboard remote control units, do not change the remote control unit in the middle of operation such as character input. Otherwise, characters may not be input correctly.

## Searching a disc by the disc title (CHARAC. SEARCH mode)

By inputting the initial letter of the desired disc title, discs which have the disc titles beginning with that character can be searched in sequence.

### 1 Activate the character search mode.

**10-Key Remote**

① Press the MODE button.

② Select "DISC SEARCH".

③ Select "CHARAC. SEARCH".

**Keyboard**

① Press the MODE button.

② Select "DISC SEARCH".

③ Select "CHARAC. SEARCH".

- When the **MODE** button is pressed during CHARAC. SEARCH mode, the CHARAC. SEARCH mode is cancelled.

Each press switches the modes as follows:

- ① MUSIC TYPE
- ② USER FILE
- ③ DISC SEARCH
- ④ TITLE INPUT
- ⑤ ALL DATA READ
- ⑥ ALL INFORMATION

The display flashes.



The display flashes.



### 2 Input the initial letter of the disc title to be searched.

**10-Key Remote**

① Input the initial letter of the disc title to be searched.

② Set the input.

**Keyboard**

② Set the input.

When initial letter "A" is selected.



- The initial letters of disc titles are searched insensitively to the upper-case and lowercase.
- Lowercase characters cannot be input in the CHARAC. SEARCH mode.

#### Keyboard

- To input a symbol, press and hold **SHIFT** while press the desired numeric/symbol button.

#### 10-Key Remote

#### Main unit

- If a desired character is not provided on the remote control buttons, input the character as follows. Press the **CHARACTER (DOWN/UP)** buttons or rotating the **DISC SKIP** knob until the desired character is displayed in the flashing cursor position. Then, press the **SET** button.
- The type of characters (capital letters or numbers/symbols) is switched each time the **CHARAC.** button is pressed.
- The disc titles beginning the specified character will be scrolled in the display.
- If there is no disc title beginning with the specified character, "**NO ENTRY**" will be displayed.

### To quit CHARAC. SEARCH mode

Press the **MODE** button.

### To search the next disc

**10-Key Remote**

**Keyboard**

### To play the searched disc

**10-Key Remote**

**Keyboard**

- Close the disc door



If disc is searched while the disc door is left open, the carousel rotates to move the search target disc on the front. If the search target disc is being played, "**DXXX BUSY!**" is displayed.

**Preparation**

- Close the disc door.
- Register music type.
- Check that the unit is in the normal play TRACK mode.

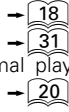

## Searching the music type (M.TYPE SEARCH mode)

The discs registered in the specified music type can be searched in sequence.

### 1 Activate the music type search mode.

- ① Press the MODE button.

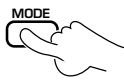

- ② Select "DISC SEARCH".

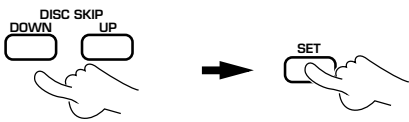

- ③ Select "M.TYPE SEARCH".

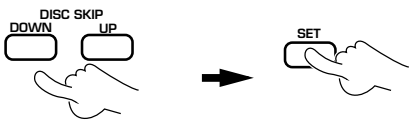

- When the **MODE** button is pressed during M.TYPE SEARCH mode, the M.TYPE SEARCH mode is cancelled.

Each press switches the modes as follows:

- ① MUSIC TYPE
- ② USER FILE
- ③ DISC SEARCH
- ④ TITLE INPUT
- ⑤ ALL DATA READ
- ⑥ ALL INFORMATION

The display flashes.

DISC SEARCH

The display flashes.

M.TYPE SEARCH

### 2 Select the music type to be searched.

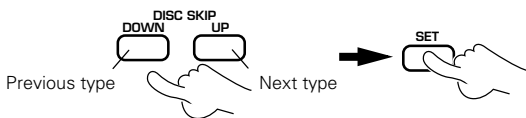

Each press switches the modes as follows:

Adult Contemporary → Alternative Rock → Children's Music → Classical → Contemporary Christian → Country → Dance → Easy Listening → Folk → Gospel → Hip Hop → Jazz → Latin → Musical → New Age → Opera → Operetta → Pop Music → RAP → Reggae → Rock Music → Rhythm & Blues → Sound Effects → Sound Track → Spoken Word → World Music → Adult Contemporary → .....

- If there is no disc registered in the specified music type, "NO ENTRY" will be displayed.

#### To quit M.TYPE SEARCH mode

Press the MODE button.

#### To search the next disc

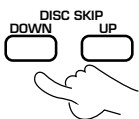

#### To play the searched disc



If disc is searched while the disc door is left open, the carousel rotates to move the search target disc on the front. If the search target disc is being played, "DXXX BUSY!" is displayed.

**Preparation**

- Close the disc door. → 18
- Register user file. → 33
- Check that the unit is in the normal play TRACK mode. → 20

## Searching the user file (U.FILE SEARCH mode)

The discs registered in the or specified user file can be searched in sequence.

### 1 Activate the user file search mode.

- ① Press the **MODE** button.



- ② Select "DISC SEARCH".

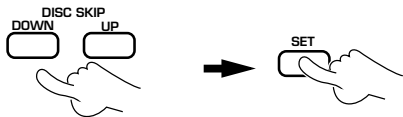

- ③ Select "U.FILE SEARCH".

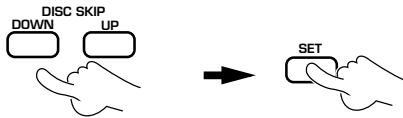

- When the **MODE** button is pressed during U.FILE SEARCH mode, the U.FILE SEARCH mode is cancelled.

Each press switches the modes as follows:

- ① MUSIC TYPE
- ② USER FILE
- ③ DISC SEARCH
- ④ TITLE INPUT
- ⑤ ALL DATA READ
- ⑥ ALL INFORMATION

The display flashes.



The display flashes.



### 2 Select the user file to be searched.

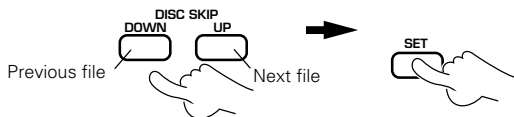

Each press switches the modes as follows:

**USER FILE 1** → **USER FILE 2** → **USER FILE 3** → **USER FILE 4** → **USER FILE 5** → **USER FILE 6** → **USER FILE 7** → **USER FILE 8** → **USER FILE 1** → .....

- If user file names have already been registered, their names are displayed in place of the above.

"Assigning user file names" → 35

- If there is no disc registered in the specified user file, "NO ENTRY" will be displayed.

**To quit U.FILE SEARCH mode**

Press the **MODE** button.

### To search the next disc

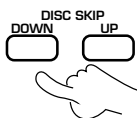

### To play the searched disc



If disc is searched while the disc door is left open, the carousel rotates to move the search target disc on the front. If the search target disc is being played, "DXXX BUSY!" is displayed.

# Listening to your favorite titles (BEST SELECTION mode)

You can select only your favorite titles and register them as the best selection. Use the following procedure to register favorite tracks in the best selection file while playing a CD.

## Registration of best selection file

**1** Play the track to be registered.

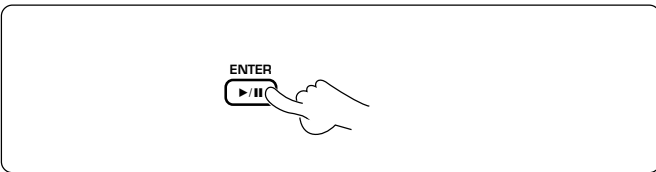

- Only the track being played can be registered.

**2** Register it in the best selection file.

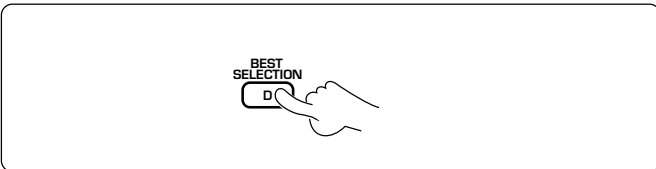

▶ BEST01 D104 T03

**3** Register other favorite tracks by performing steps 1 and 2 for each of them.

- Up to 32 tracks can be registered. "FULL" is displayed when no more disc is acceptable.

## Playing the best selection file

### Preparation

- Close the disc door. → 18
- Set the CD player to stop mode.
- Check that the unit is in the normal play TRACK mode. → 20

Press the BEST SELECTION button.

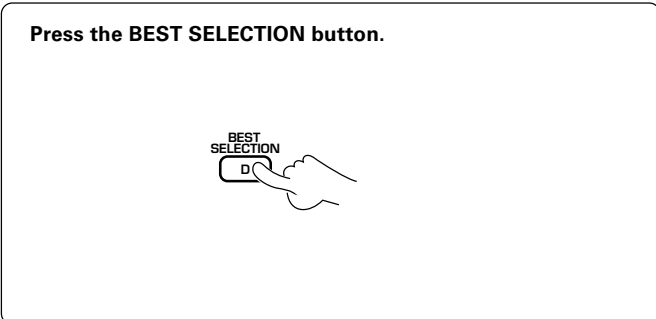

▶ BEST SELECTION

- The tracks are played in the order they are registered.
- Each time the CHECK button is pressed, the disc numbers and track numbers are displayed in the order they are registered.

### For repeated playback

Press the REPEAT button to select "REPEAT ON".

### To quit BEST SELECTION mode

Press the ■ button during playback.

- The recorded contents remain stored even when best selection mode is quit.

## To delete the registered best selection file

- 1 Play the track to be cleared.
- 2 Press the CLEAR button.



- This is done during BEST SELECTION mode.

▶ BEST02 CLEAR



## In case of difficulty

### Operation to reset

The microcomputer may malfunction (impossibility to operate, erroneous display, etc.) when the connection cords are unplugged while power is ON or due to an external factor. In this case, execute the following method to reset the microcomputer and return it to normal condition.



Unplug the power cord from the power socket and plug the power cord into the socket again.

### To reset the registered contents











The registered contents for title, music type, user file and best selection can be reset by the following procedure.

Unplug the power cord from the power socket, and while holding the **■** button depressed, plug the power cord into the socket again.

### Remote control unit

Symptom	Cause	Remedy
Remote control operation is not possible.	<ul style="list-style-type: none"> <li>● Batteries are exhausted.</li> <li>● The remote control unit is too far away from the main system, controlling angle is too large, or there is an obstacle in between.</li> </ul>	<ul style="list-style-type: none"> <li>● Replace with new batteries. →  9</li> <li>● Operate the remote control unit within the controllable range. →  9</li> </ul>

### CD Player

Symptom	Cause	Remedy
No power is applied with the POWER(I / ⏻) key ON.	<ul style="list-style-type: none"> <li>● Power plug is loosely connected.</li> <li>● With the power plug connected to the switched AC outlet of an amplifier, the power of the amplifier is turned off.</li> </ul>	<ul style="list-style-type: none"> <li>● Insert the power plug firmly to the AC outlet.</li> <li>● Insert the power plug to the wall AC outlet.</li> </ul>
Sound is not heard with the ▶/   key on.	<ul style="list-style-type: none"> <li>● Disc is loose.</li> <li>● Condensation occurred on the optical lens unit.</li> <li>● Disc is too dirty.</li> <li>● Disc is cracked.</li> <li>● The connection cords are inserted loosely.</li> </ul>	<ul style="list-style-type: none"> <li>● Insert disc properly. →  17</li> <li>● Leave the player for about 1 hour so that the condensation is removed. →  42</li> <li>● Wipe off the dust on the disc surface referring to "Disc handling precautions". →  42</li> <li>● Replace the disc with a new one.</li> <li>● Connect all connection cords firmly. →  6</li> </ul>
Music is interrupted. (Sound is skipped.)	<ul style="list-style-type: none"> <li>● Disc is too dirty.</li> <li>● Disc is cracked.</li> <li>● Oscillation is applied to this unit.</li> </ul>	<ul style="list-style-type: none"> <li>● Wipe off the dust on the disc surface referring to "Disc handling precautions". →  42</li> <li>● Replace the disc with a new one.</li> <li>● Try selecting a place where no strong vibrations occur by changing the installation place, etc.</li> </ul>
Disc selection is not possible.	<ul style="list-style-type: none"> <li>● RANDOM or BEST SELECTION mode is selected.</li> <li>● MUSIC TYPE PLAY mode or USER FILE PLAY mode is selected.</li> </ul>	<ul style="list-style-type: none"> <li>● Press the <b>■</b> key to quit RANDOM, BEST SELECTION mode. →  23 →  40</li> <li>● Press the <b>MODE</b> button to quit MUSIC TYPE PLAY mode or USER FILE PLAY mode. →  32 →  34</li> </ul>
Disc begins to play when power is switched ON.	<ul style="list-style-type: none"> <li>● The <b>TIMER PLAY</b> switch is set to ON.</li> </ul>	<ul style="list-style-type: none"> <li>● Set the <b>TIMER PLAY</b> switch to OFF unless timer playback is required. →  26</li> </ul>

### When "REMOVE DISC XXX" is displayed :

A CD is inserted in the slot with the same disc number as the CD being loaded. It is not permitted to insert another disc in a slot from which the CD has been loaded. Remove the inserted disc and insert it in an idle slot.

## Disc handling precautions

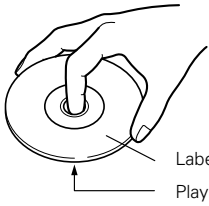

### Handling

Hold the discs so that you do not touch the playing surface.

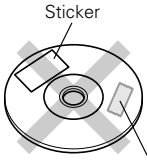

Do not attach paper or tape to either the playing side or the label side of the discs.

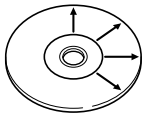

### Cleaning

If fingerprints or foreign matter become attached to the disc, lightly wipe the disc with a soft cotton cloth (or similar) from the center of the disc outwards in a radial manner.

### Storage

When a disc is not to be played for a long period of time, remove it from the player and store it in its case.

## Discs which can be played with this unit

CD (12 cm), and the audio part of CDV, CD-G, CD-EG and CD-EXTRA.

Use discs that comply with the IEC standard, for example a disc carrying the  marking on the label surface.

- An 8 cm CD cannot be played back.

## Never play a cracked or warped disc

During playback, the disc rotates at high speed in the player.

Therefore, to avoid danger, never use a cracked or deformed disc or a disc repaired with tape or adhesive agent.

Please do not use discs which are not round because they may cause a malfunction.

## Disc accessories

The disc accessories (stabilizer, protection sheet, protection ring, etc.) which are marketed for improving the sound quality or protecting discs as well as the disc cleaner should not be used with this system because they may cause malfunction.

## Maintenance of the unit

When the front panel or case becomes dirty, wipe with a soft, dry cloth. Do not use thinner, benzine, alcohol, etc. for these agents may cause discoloration.

## Caution on condensation

Condensation (of dew) may occur inside the unit when there is a great difference in temperature between this unit and the outside. This unit may not function properly if condensation occurs. In this case, leave the unit for a few hours with the power left ON, and restart the operation after the condensation has dried up.

Be specially cautious against condensatin in a following circumsatance:

When this unit is carried from a place to another across a large difference in temperature, when the humidity in the room where this unit is installed increases, etc.

## Memory backup function

**Stored contents for at least 3 weeks after power plug is unplugged from the AC outlet.**

Power status (ON or OFF),  
Title registration contents  
Music type registration contents  
User file registration contents  
Best selection registration contents

## In regard to contact cleaner

Do not use contact cleaners because it could cause a malfunction. Be specially careful not to use contact cleaners containing oil, for they may deform the plastic component.

## Note related to transportation and movement

Before transporting or moving this unit, carry out the following operation:

1. Remove all discs from the carousel and close the door panel.
2. Confirm that the flashing "NO DISC" display has changed to steady lighting, and then switch off the power.



3. Wait a few seconds, then disconnect the power plug.



As an ENERGY STAR® Partner, Kenwood Corporation has determined that this products meets the ENERGY STAR® guidelines for energy efficiency.

This product can save energy. Saving energy reduces air pollution and lowers utility bills.

# Chapter 6 : Warnings and Specifications

## Warnings

### For the U.S.A.

#### **FCC WARNING**

This equipment may generate or use radio frequency energy. Changes or modifications to this equipment may cause harmful interference unless the modifications are expressly approved in the instruction manual. The user could lose the authority to operate this equipment if an unauthorized change or modification is made.

#### **NOTE:**

This equipment has been tested and found to comply with the limits for a Class B digital device, pursuant to Part 15 of the FCC Rules. These limits are designed to provide reasonable protection against harmful interference in a residential installation. This equipment may cause harmful interference to radio communications, if it is not installed and used in accordance with the instructions. However, there is no guarantee that interference will not occur in a particular installation. If this equipment does cause harmful interference to radio or television reception, which can be determined by turning the equipment off and on, the user is encouraged to try to correct the interference by one or more of the following measures:

- Reorient or relocate the receiving antenna.
- Increase the separation between the equipment and receiver.
- Connect the equipment into an outlet on a circuit different from that to which the receiver is connected.
- Consult the dealer or an experienced radio / TV technician for help.

### For the U.S.A.

#### **FCC Compliance Notice**

Compact Disc Player, CD-4700M, CD-4260M, CD-425M

Those devices complies with Part 15 of FCC Rules. Operation is subject to the following two conditions: (1) This device may not cause harmful interference, and (2) this device must accept any interference received, including interference that may cause undesired operation.

**KENWOOD U.S.A. CORPORATION**  
**2201 East Dominguez St., Long Beach, CA 90801-5745**  
**Telephone: 310-639-9000**

### For the U.S.A.

#### **CAUTION:**

Use of controls or adjustments or performance of procedures other than those specified herein may result in hazardous radiation exposure.

In compliance with Federal Regulations, following are reproductions of labels on, or inside the product relating to laser product safety.

KENWOOD CORPORATION  
2967-3, ISHIKAWA-CHO, HACHIOJI-SHI,  
TOKYO, JAPAN

KENWOOD CORP. CERTIFIES THIS EQUIPMENT CONFORMS TO DHHS REGULATIONS NO. 21 CFR 1040.10, CHAPTER 1, SUBCHAPTER J.

Location: Back Panel

## [Format]

System ..... Compact disc digital audio system  
Laser ..... Semiconductor laser

## [D/A Convertors]

D/A Conversion ..... 1 Bit  
Oversampling ..... 8 fs (352.8 kHz)

## [Audio]

Frequency response ..... 4 Hz ~ 20 kHz,  $\pm 0.5$  dB  
Signal to noise ratio ..... More than 105 dB  
Dynamic range ..... More than 95 dB  
Total harmonic distortion + noise  
..... Less than 0.005% (at 1 kHz)  
Channel separation ..... More than 95 dB (at 1 kHz)  
Wow & flutter ..... Unmeasurable Limit  
Output level/impedance  
Fixed ..... 2.0 V/1 k $\Omega$   
Digital output  
Optical ..... -15 dBm ~ -21 dBm (Wave length 660 nm)

## [Laser]

Wave length ..... 760 ~ 800 nm  
Laser power class ..... Class 1 (IEC)

## [General]

CD-4700M  
Power consumption ..... 10 W  
Dimensions  
W : 481 mm (18-15/16")  
H : 163 mm (6-7/16")  
D : 484 mm (19-1/16")  
Weight (Net) ..... 9.0 kg (19.8 lb)

## CD-4260M

Power consumption ..... 10 W  
Dimensions  
W : 440 mm (17-5/16")  
H : 163 mm (6-7/16")  
D : 484 mm (19-1/16")  
Weight (Net) ..... 7.2 kg (15.9 lb)

## CD-425M/DPF-J6030

Power consumption ..... 10 W  
Dimensions  
W : 440 mm (17-5/16")  
H : 163 mm (6-7/16")  
D : 479 mm (18-7/8")  
Weight (Net) ..... 7 kg (15.4 lb)



1. KENWOOD follows a policy of continuous advancements in development. For this reason specifications may be changed without notice.
2. The full performance may not be exhibited in an extremely cold location (under a water-freezing temperature).

# KENWOOD

## For your records

Record the serial number, found on the back of the unit, in the spaces designated on the warranty card, and in the space provided below. Refer to the model and serial numbers whenever you call upon your dealer for information or service on this product.

Model \_\_\_\_\_ Serial Number \_\_\_\_\_

## Free Manuals Download Website

<http://myh66.com>

<http://usermanuals.us>

<http://www.somanuals.com>

<http://www.4manuals.cc>

<http://www.manual-lib.com>

<http://www.404manual.com>

<http://www.luxmanual.com>

<http://aubethermostatmanual.com>

Golf course search by state

<http://golfingnear.com>

Email search by domain

<http://emailbydomain.com>

Auto manuals search

<http://auto.somanuals.com>

TV manuals search

<http://tv.somanuals.com>