

KENWOOD

STEREO MINIDISC RECORDER

DMF-5020

DMF-3020

MD-203

INSTRUCTION MANUAL

KENWOOD CORPORATION

**This instruction manual is used to describe multiple models listed above.
Model availability and features (functions) may differ depending on the country and sales
area.**



Before applying power

Units are designed for operation as follows.

U.S.A. and Canada **AC 120 V only**
U.K. **AC 230 V only**

For the United Kingdom

Factory fitted moulded mains plug

1. The mains plug contains a fuse. For replacement, use only a 13- Amp ASTA-approved (BS1362) fuse.
2. The fuse cover must be refitted when replacing the fuse in the moulded plug.
3. Do not cut off the mains plug from this equipment. If the plug fitted is not suitable for the power points in your home or the cable is too short to reach a power point, then obtain an appropriate safety approved extension lead or adapter, or consult your dealer. If nonetheless the mains plug is cut off, remove the fuse and dispose of the plug immediately, to avoid a possible shock hazard by inadvertent connection to the mains supply.

IMPORTANT :

The wires in the mains lead are coloured in accordance with the following code :





Blue: Neutral

Brown: Live

Do not connect those leads to the earth terminal of a three - pin plug.

Safety precautions

WARNING : TO PREVENT FIRE OR ELECTRIC SHOCK, DO NOT EXPOSE THIS APPLIANCE TO RAIN OR MOISTURE.

	CAUTION RISK OF ELECTRIC SHOCK DO NOT OPEN		CAUTION: TO REDUCE THE RISK OF ELECTRIC SHOCK, DO NOT REMOVE COVER (OR BACK). NO USER-SERVICEABLE PARTS INSIDE, REFER SERVICING TO QUALIFIED SERVICE PERSONNEL.
	THE LIGHTNING FLASH WITH ARROWHEAD SYMBOL, WITHIN AN EQUILATERAL TRIANGLE, IS INTENDED TO ALERT THE USER TO THE PRESENCE OF UNINSULATED "DANGEROUS VOLTAGE" WITHIN THE PRODUCT'S ENCLOSURE THAT MAY BE OF SUFFICIENT MAGNITUDE TO CONSTITUTE A RISK OF ELECTRIC SHOCK TO PERSONS.		
	THE EXCLAMATION POINT WITHIN AN EQUILATERAL TRIANGLE IS INTENDED TO ALERT THE USER TO THE PRESENCE OF IMPORTANT OPERATING AND MAINTENANCE (SERVICING) INSTRUCTIONS IN THE LITERATURE ACCOMPANYING THE APPLIANCE.		

The marking of products using lasers (Except for some areas)

**CLASS 1
LASER PRODUCT**

The marking is located on the rear panel and says that the component uses laser beams that have been classified as Class 1. It means that the unit is utilizing laser beams that are of a weaker class. There is no danger of hazardous radiation outside the unit.

REQUIREMENT BY NEDERLAND GAZETTE

Batteries are supplied with this product. When they empty, you should not throw away. Instead, hand them in as small chemical waste.

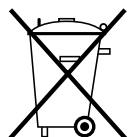

Contents

Caution : Read the pages marked  carefully to ensure safe operation.

Introduction	2
⚠ Before applying power	2
⚠ Safety precautions	2
⚠ Contents	3
Accessories	4
Special feature	5
⚠ IMPORTANT SAFEGUARDS	6
Information that you should know	8
Safety Precautions	8
Maintenance	9
System connections	10
Names and functions of parts	12
Display/Main unit	12
Remote control unit (DMF-5020)	14
Remote control unit (DMF-3020/MD-203)	15
Operation of remote control unit	16
Playback of Mini Disc	17
Playing tracks in order from track No. 1	17
Searching a desired track by its title (TITLE SEARCH)	18
Playback from desired track	19
Random playback	19
Programming	21
Programming tracks in a desired order	21
Repeated playback	23
Recording-related keys	24
AUTO/MANU. key	24
MONITOR key	24
REC MODE key	24
Automatically starting recording when the track starts (SOUND SYNCHRO REC)	26
Automatically pausing recording when the track ends (REC AUTO PAUSE)	26
Starting recording from the sound before the current sound (MEMORY REC)	26
Recording (ANALOG input)	27
ANALOG recording	27
Recording (DIGITAL input)	29
DIGITAL recording	29
Synchro recording with CD playback	31
DIGITAL recording and SCMS	31
Editing	32
Selecting the editing function type	32
Moving the track being played (TRACK MOVE)	33
Moving several tracks at a time (QUICK MOVE)	35
Dividing the track being played (TRACK DIVIDE)	37
Combining the track being played (TRACK COMBINE)	39
Erasing the track being played (TRACK ERASE)	41
Erasing one or more track at a time (QUICK ERASE)	43
Editing titles	45
Changing the displayed contents	49
TIME DISPLAY key	49
METER key	49
Timer operations	50
Timer playback, timer recording	50
In case of difficulty	51
Specifications	54

4 Unpacking

Unpack the unit carefully and make sure that all accessories are put aside so they will not be lost.

Examine the unit for any possibility of shipping damage. If your unit is damaged or fails to operate, notify your dealer immediately. If your unit was shipped to you directly, notify the shipping company without delay. Only the consignee (the person or company receiving the unit) can file a claim against the carrier for shipping damage.

We recommend that you retain the original carton and packing materials for use should you transport or ship the unit in the future.

Keep this manual handy for future reference.

Accessories

Check that the following accessories are present.

Audio cord (2)

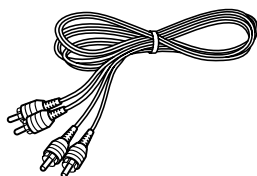

Remote control unit (1)
RC-M0705 (For DMF-5020)

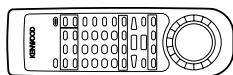

System control cord (1)

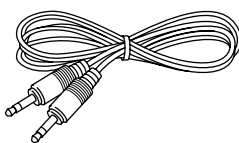

Remote control unit (1)
RC-M0302 (For DMF-3020/MD-203)

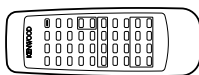

Optical fiber cable (1)

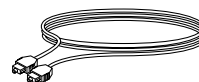

Batteries (2)
R03 ("AAA"-size) batteries (For RC-M0705)
R6 ("AA"-size) batteries (For RC-M0302)

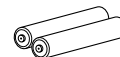

Special feature

This unit is audio equipment based on the Mini Disc format. The Mini Disc (MD) is an application of the optical and magneto-optical technology and has the capability to record signals on discs. The operability of the MD is equivalent to the Compact Disc (CD). The MD uses optional non-contact system so the recordings are not degraded by external factors and the discs are never scratched or damaged in playback.

"D.R.I.V.E." for high-quality playback (For DMF-5020 only)

The DMF-5020 is equipped with KENWOOD-original "24-bit D/A D.R.I.V.E.II", providing high quality playback.

(D.R.I.V.E.:Dynamic Resolution Intensive Vector Enhancement)

Sampling rate converter

The sampling rate converter incorporated in this unit is compatible with all digital sources (32 kHz, 44.1 kHz, 48 kHz).

- 48 kHz : Standard mode of DAT. For recording of B mode broadcasting of BS tuner, etc.
- 44.1 kHz: Standard mode of DAT. For recording of CD, MD, etc.
- 32 kHz : Standard mode and long-hour mode of DAT. For recording of A mode broadcasting of BS tuner.

Versatile editing functions

In addition to the conventional editing functions (MOVE, DIVIDE, COMBINE and ERASE), this unit provides more versatile editing functions such as the QUICK MOVE function for moving desired tracks at once or the QUICK ERASE function for erasing desired tracks at once.

SOUND SYNCHRO REC functions

This unit is equipped with the "SOUND SYNCHRO REC" and "AUTO CUT" functions for automatically starting and pausing recording simultaneously with the sound input, the "REC AUTO PAUSE" function for automatically stopping recording when the end of one track on the CD is reached, and the "MEMORY REC" function for starting recording from approximately 6 seconds before the current sound.

Title input, title search

In addition to the "Title input function" which allows to assign disc and track titles simply using the multi-jog dial and the "Title search function" which allows to find the desired track title, the "Preset title function" provides a selection of frequently used titles.

IMPORTANT SAFEGUARDS

DMF-5020/DMF3020/MD-203 (En)

⚠ Caution :Read this page carefully to ensure safe operation.

6 Please read all of the safety and operating instructions before operating this appliance. Adhere to all warnings on the appliance and in the instruction manual. Follow all the safety and operating instructions. These safety and operating instructions should be retained for future reference.

1. Power sources – The appliance should be connected to a power supply only of the type described in the instruction manual or as marked on the appliance. If you are not sure of the type of power supply to your home, consult your appliance dealer or local power company. For appliances intended to operate from battery power, or other sources, refer to the instruction manual.

2. Power-cord protection – Power-supply cords should be routed so that they are not likely to be walked on or pinched by items placed upon or against them, pay particular attention to cords at plugs, convenience receptacles, and the point where they exit from the appliance.

Never pull or stretch the cord.

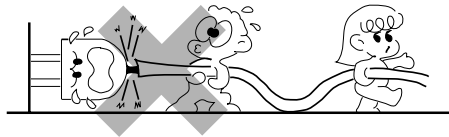

3. CAUTION – Polarization – This appliance may be equipped with a polarized alternating-current line plug (a plug having one blade wider than the other). This plug will fit into the power outlet only one way. This is a safety feature. If you are unable to insert the plug fully into the outlet, try reversing the plug. If the plug should still fail to fit, contact your electrician to replace your obsolete outlet. Do not defeat the safety purpose of the polarized plug.

4. Ventilation – Slots and openings in the cabinet are provided for ventilation and to ensure reliable operation of the appliance and to protect it from overheating, and these openings must not be blocked or covered. The appliance should be situated so that its location or position does not interfere with its proper ventilation.

To maintain good ventilation, do not put records or a table-cloth on the appliance. Place the appliance at least 10 cm away from the walls.

Do not use the appliance on a bed, sofa, rug or similar surface that may block the ventilation openings. This appliance should not be placed in a built-in installation such as a bookcase or rack unless proper ventilation is provided or the manufacturer's instructions have been adhered to.

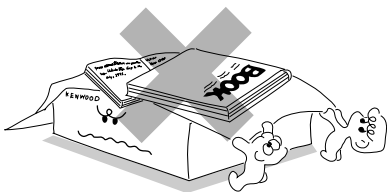

5. Water and moisture – The appliance should not be used near water - for example, near a bathtub, washbowl, kitchen sink, laundry tub, in a wet basement, or near a swimming pool, etc.

6. Temperature – The appliance may not function properly if used at extremely low, or freezing temperatures. The ideal ambient temperature is above +5°C (41°F).

7. Heat – The appliance should be situated away from heat sources such as radiators, heat registers, stoves, or other appliances (including amplifiers) that produce heat.

8. Electric shock – Care should be taken so that objects do not fall and liquid is not spilled into the enclosure through openings. If a metal objects, such as a hair pin or a needle, comes into contact with the inside of this appliance, a dangerous electric shock may result. For families with children, never permit children to put anything, especially metal, inside this appliance.

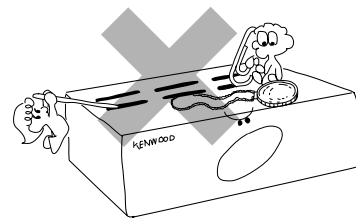

9. Enclosure removal – Never remove the enclosure. If the internal parts are touched accidentally, a serious electric shock might occur.

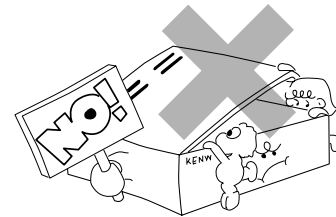

10. Magnetic fields – Keep the appliance away from sources of magnetic fields such as TV sets, speaker systems, radios, motorized toys or magnetized objects.

11. Cleaning – Unplug this appliance from the wall outlet before cleaning. Do not use volatile solvents such as alcohol, paint thinner, gasoline, or benzine, etc. to clean the cabinet. Use a clean dry cloth.

12. Accessories – Do not place this appliance on an unstable cart, stand, tripod, bracket, or table. The appliance may fall, causing serious injury to a child or adult, and serious damage to the appliance. Use only with a cart, stand, tripod, bracket, or table recommended by the manufacturer, or sold with the appliance. Any mounting of the appliance should follow the manufacturer's instructions, and should use a mounting accessory recommended by the manufacturer. An appliance and cart combination should be moved with care. Quick stops, excessive force, and uneven surfaces may cause the appliance and cart combination to overturn.



13. Lightning – For added protection for this appliance during a lightning storm, or when it is left unattended and unused for long periods of time, unplug it from the wall outlet and disconnect the antenna or cable system. This will prevent damage to the appliance due to lightning and power-line surges.

14. Abnormal smell – If an abnormal smell or smoke is detected, immediately turn the power OFF and unplug the appliance from the wall outlet. Contact your dealer or nearest service center.

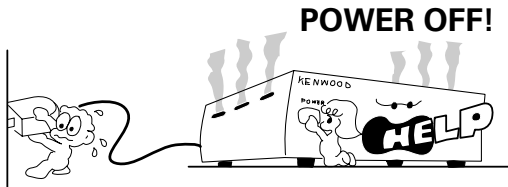

15. Damage requiring service – The appliance should be serviced by qualified service personnel when:

- A. The power-supply cord or the plug has been damaged.
- B. Objects have fallen, or liquid has been spilled into the appliance.
- C. The appliance has been exposed to rain or water.
- D. The appliance does not appear to operate normally by following the instruction manual. Adjust only those controls that are covered by the instruction manual as an improper adjustment of other controls may result in damage and will often require extensive work by a qualified technician to restore the appliance to its normal operation.
- E. The appliance has been dropped, or the enclosure damaged.
- F. The appliance exhibits a marked change in performance.

16. Servicing – The user should not attempt to service the appliance beyond that described in the instruction manual. All other servicing should be referred to qualified service personnel.

17. Outdoor antenna grounding – If an outside antenna is connected to the appliance, be sure the antenna system is grounded so as to provide some protection against voltage surges and built up static charges. Article 810 of the National Electrical Code ANSI/NFPA 70, provides information with respect to proper grounding of the mast and supporting structure, grounding of the lead-in wire to an antenna discharge unit, size of grounding conductors, location of antenna discharge unit, connection to grounding electrodes, and requirements for the grounding electrode. See Figure.

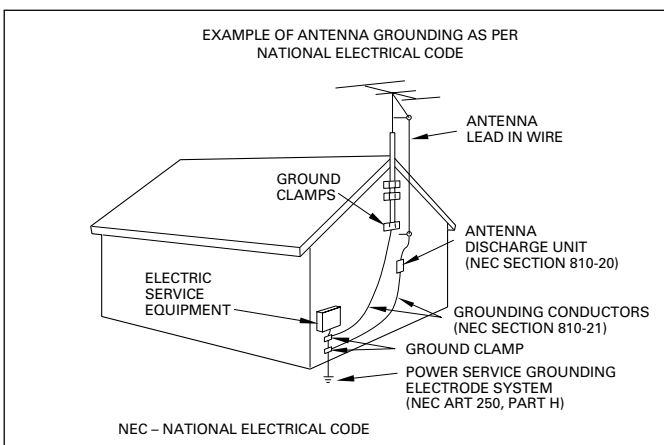

18. Power lines – An outside antenna system should not be located in the vicinity of overhead power lines or other electric light or power circuits, or where it can fall into such power lines or circuits. When installing an outside antenna system, extreme care should be taken to keep from touching such power lines or circuits as contact with them might be fatal.

19. AC outlets – Do not connect other audio equipment with a power consumption larger than that specified to the AC outlet on the rear panel. Never connect other electrical appliances, such as an iron or toaster, to it to prevent fire or electric shock.

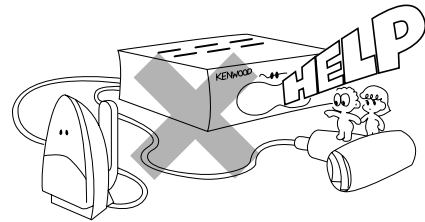

20. Overloading – Do not overload wall outlets, extension cords, or integral convenience receptacles as this can result in a risk of fire or electric shock.

21. Attachment – Do not use attachments not recommended by the appliance manufacturer as they may cause hazards.

22. Replacement parts – When replacement parts are required, be sure the service technician has used replacement parts specified by the manufacturer or have the same characteristics as the original parts. Unauthorized substitutions may result in fire, electric shock, or other hazards.

23. Safety check – Upon completion of any service or repairs to this appliance, ask the service technician to perform safety checks to determine that the appliance is in proper operating condition.



1. Item 3 is not required except for grounded or polarized equipment.
2. Item 17 and 18 are not required except for units provided with antenna terminals.
3. Item 17 complies with UL in the U.S.A.

Safety Precautions

Handling of Mini Disc

As the Mini Disc is accommodated inside a cartridge, it can be handled without caring about dust or fingerprint. However, stained or soiled cartridge may cause malfunction. To enjoy beautiful sound for extended period of time, take care on the following points.

Do not touch the disc directly.

Do not touch the disc by opening the shutter with your hand. The cartridge will be damaged if it is forced open.

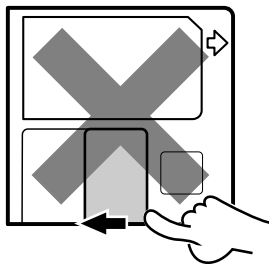

Storage position

Do not leave Mini Discs in place where the temperature and/or humidity are extremely high (for example, in a place subject to direct sunlight).

Care

Wipe periodically dust and dirt attached on the cartridge with a dry cloth.

Write protect tab

To protect recorded contents against accidental erasure, set the write protect tab of the disc open. Return the tab to the original position when you want to record signals on the disc.

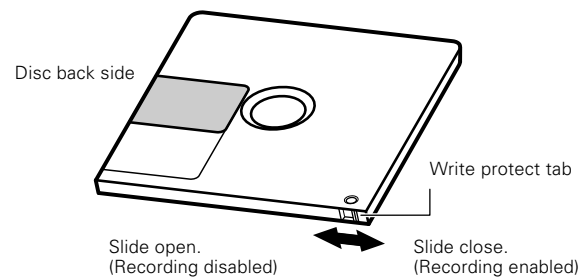

Note related to transportation and movement

Before transporting or moving this unit, carry out the following operations.

1. Set the POWER key to ON without loading a Mini Disc.
 - Check that no disc is present in the unit.
2. Wait a few seconds and verify that the display shown appears.
3. Set the POWER key to OFF.



NO DISC

Installation position

The MD recorder is very sensitive to vibrations. It should be installed in a position subject to as small vibration as possible.

Dust countermeasure

The shutter of the disc cartridge is permanently open while the disc is loaded in the set. Therefore, to prevent dust from penetrating inside the disc, take the disc out of the unit immediately after completion of recording or playback.

Maintenance

Maintenance of the set

When the front panel or case becomes dirty, wipe with a soft, dry cloth. Do not use thinner, benzene, alcohol, etc. for these agents may cause discoloration.

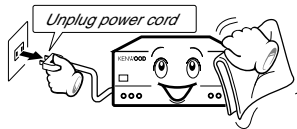

In regard to contact cleaner

Do not use contact cleaners because it could cause a malfunction. Be specially careful not to use contact cleaners containing oil, for they may deform the plastic component.

Reference notes

Caution on condensation

Condensation (of dew) may occur inside the unit when there is a great difference in temperature between this unit and the outside. This unit may not function properly if condensation occurs. In this case, leave the unit for a few hours with the power left ON, and restart the operation after the condensation has dried up.

Be specially cautious against condensation in a following circumstance:

When this unit is carried from a place to another across a large difference in temperature, when the humidity in the room where this unit is installed increases, etc.

Memory backup

The typical period for which the memory can be backed up while the power cord is unplugged or the **POWER** key is set to the **OFF** position is about 3 weeks, though this may be variable depending on the surrounding environment.

In case of long hours of power failure or slipping out of the power cord, the data related to recording and editing (that is usually recorded at the moment the Mini Disc is ejected) may be cleared or destroyed before it is written in the Mini Disc. Remember that the data lost cannot be recovered.

After recording or editing, be sure to eject the Mini Disc so that the recording or editing data can be written in the disc.

US and foreign patents licensed from Dolby Laboratories Licensing Corporation.

System connections

10

Make connection as shown below. When connecting the related system components, refer also to the instruction manuals of the related components.
Caution: Do not plug in the power lead until all connections are completed.

Malfuction of microprocessor



If operation is not possible or erroneous display appears even though all connections have been made properly, reset the microprocessor referring to "In case of difficulty".

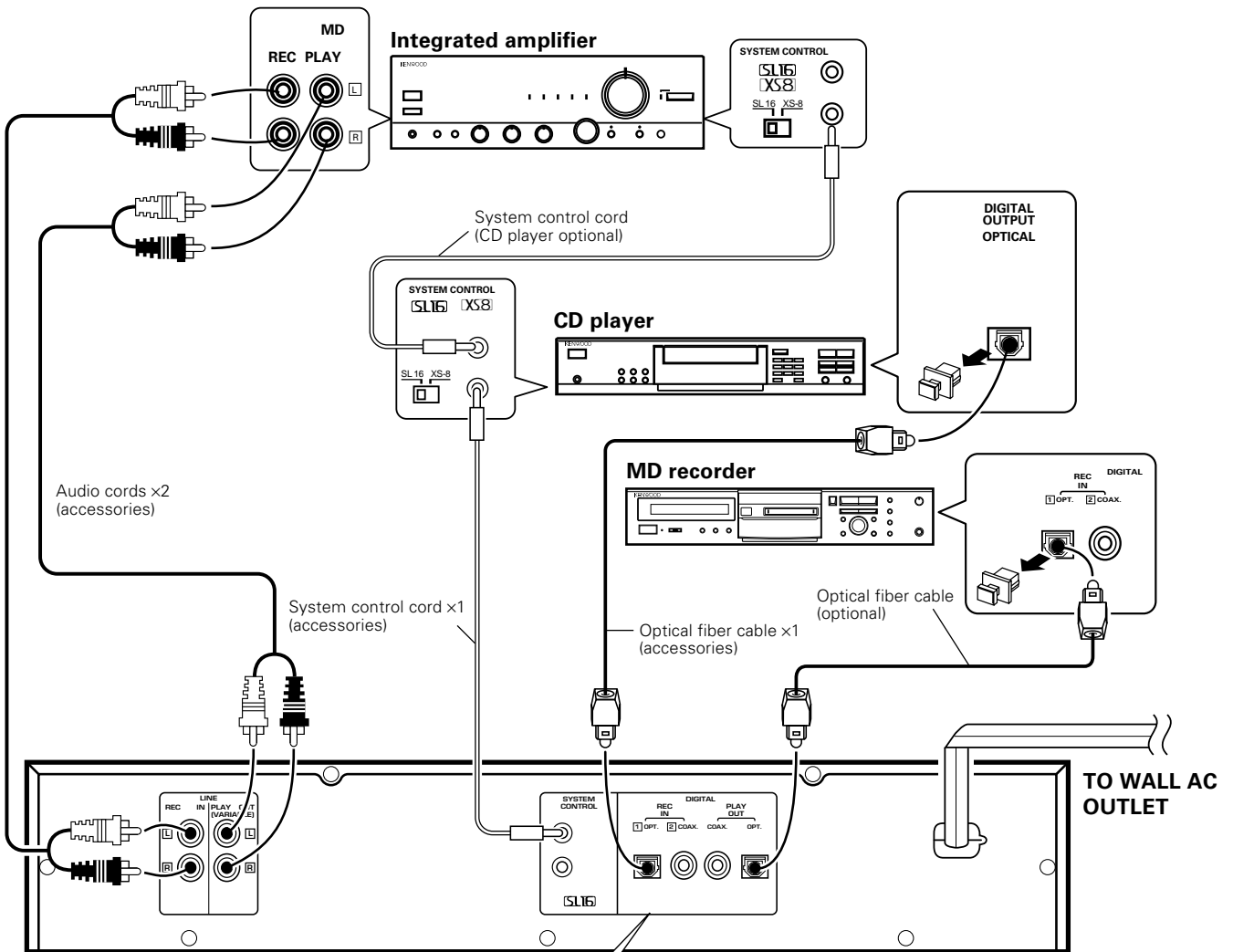

DIGITAL input / output jacks (OPTICAL)

Remove protective caps from digital input/output jacks before use.

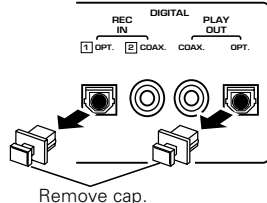

- Be careful not to lose the protective caps.

- When connecting the audio cords (cords with pin plugs on each end), insert the white plugs into the **L** (Left) jacks and red plugs into the **R** (Right) jacks.
- If the system components are equipped with more than one system control cord connectors, any one of the connectors can be used.



1. Connect all cords firmly. If connections are loose, there could be loss of sound or noise produced.
2. When plugging and unplugging connection cords, be sure to first remove the power cord from the AC outlet. Plugging/unplugging connection cords without removal of the power cord can cause malfunctions or damage to the unit.

About the system control connections

About the system control connections

Connecting system control cords after connecting a Kenwood audio component system lets you take advantage of convenient system control operations.

There are two Kenwood system control modes. Make connections according to the groups of terminal symbols shown below.

[XS8] Mode : lets you combine [XR], [XS], and [XS8] terminals

[SL16] Mode : for [SL16] terminals only

This unit is [SL16] compatible.

You can connect this unit via system control if all other equipment using system control connections are set to the [SL16] mode.



- [SL16] equipment cannot be combined with [XR], [XS], and [XS8] equipment for system operations. If your equipment consists of this kind of combination, please do not connect any system control cords. Even without system control cords, normal operations can be carried out without affecting performance.
- Even if your amplifier or receiver does not have a system control terminal, the system control functions between other components can be implemented partially by connecting system control cords to the system control terminals of other components.
- Do not connect system control cords to any components other than those specified by Kenwood. It may cause a malfunction and damage your equipment.
- Be sure the system control plugs are inserted all the way in to the system control terminals. (See the figure at right.)

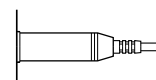

About the system control operations

Remote Control

Lets you operate this unit with the system remote supplied with the amplifier or receiver.

Automatic Operation

Automatically switches the input selector on the amplifier or receiver when you start playback from this unit.

Synchronized Recording

When recording a CD after setting the amplifier's input selector to CD, starting playback on the CD player allows to start recording automatically in an interlocked operation.

- Do not operate the CD player during recording of a digital source other than CD; otherwise malfunction may occur.
- Synchronized recording is not possible while the SOUND SYNCHRO REC, AUTO CUT and REC AUTO PAUSE function is operating.

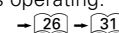

Note on connection of optical-fiber cable

The optical-fiber cable is designed for use in the connection of the CD player (optional). The digital signal transmission makes it possible to record the high-quality sound of CDs without degradation.

- Insert the optical-fiber cable straight into the connector until it clicks.
- Be sure to attach the protection cap when the connector is not used.
- Never bend or bundle the optical-fiber cable.
- All of the commercially-available optical fiber cables cannot be used with these units. If there is an optical fiber cable which cannot be connected to your component, please consult your dealer or nearest KENWOOD agent.

D.R.I.V.E.II (Dynamic Resolution Intensive Vector Enhancement) system (For DMF-5020 only)

This unit incorporates the KENWOOD-original "D.R.I.V.E.II" circuit which makes high quality sound reproduction possible.

- The reproducibility of small signals is improved drastically for an excellent reproduction of fine reverberations of music. The excellence is also remarkable in the feeling of stability, presence, attack sound and bass reproduction.
- The D.R.I.V.E.II system maintains the correlation between the musical components of the input and output signals and does not cause any sound degradation from the principle.

Display / Main unit

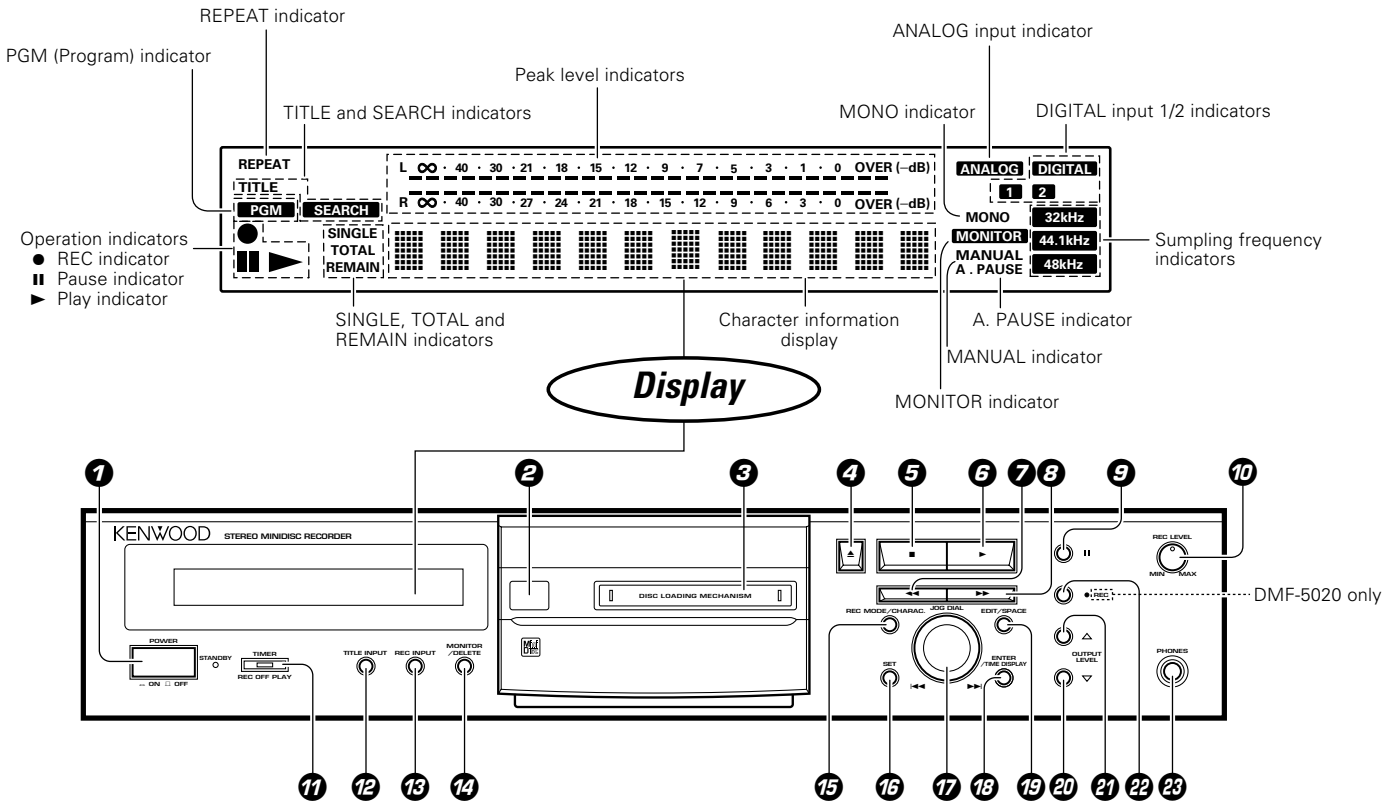

Listening through headphones

Plug the stereo headphones (with standard-plug) available in audio stores into the **PHONES** jack and adjust the listening volume with the **OUTPUT LEVEL** control on the front panel. The default value is 0 dB (maximum volume).

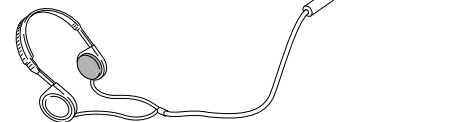
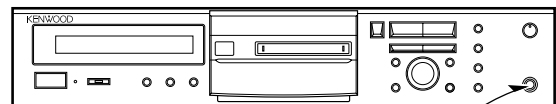
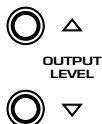

Standby mode

While the standby indicator of the unit is lit, a small amount of current is flowing into the unit's internal circuitry to back up the memory. This condition is referred to as the standby mode of the unit. While the unit is in the standby mode, it can be turned ON from the remote control unit.

Description of main unit keys

1 POWER key

- : Press to turn the unit ON and OFF.
- : The unit may enter the standby mode when the **POWER** key is pressed to turn it ON. This is because the unit holds the memory that it has been put to the standby mode by the remote control unit in the last operation.

2 Remote control sensor

3 Mini Disc insertion slot

- : When a Mini Disc is inserted while the unit is in the standby mode, it is turned ON automatically.

4 Eject (▲) key

- : Press to eject the Mini Disc.

5 Stop (■) key

- : Press to stop playback or recording.

6 Play (▶) key

- : Press to start playback.

7 Manual search down (◀◀) key

→ 20 → 47

- : This key functions as the fast reverse key during playback.
- : During an editing mode, press to move the title input cursor or to scroll the track title display to the left.

8 Manual search up (▶▶) key

→ 20 → 47

- : This key functions as the fast forward key during playback.
- : During an editing mode, press to move the title input cursor or to scroll the track title display to the right.

9 Pause (||) key

- : Press to let playback or recording pause temporarily.

10 REC LEVEL knob

→ 28

- : Rotate to adjust the analog recording level.

11 TIMER switch

- : This switch is used in timer playback and timer recording.

12 TITLE INPUT key

→ 45

- : Press to switch the title input mode ON/OFF.

13 REC INPUT key

→ 27 → 29

- : Press to switch the recording input line between digital (optical/coaxial), analog and monaural.

14 MONITOR/DELETE key

→ 24

- : Press to monitor the sound being input from the source while the unit is in stop mode.

DELETE

- : During title editing, press to delete a character. During track editing, press to delete a track.

15 REC MODE/CHARAC. (Character) key

→ 24 → 46

REC MODE

- : Press to switch the recording setting adjustment modes (record modes) ON/OFF.

CHARAC.

- : Press to select a character group during the title input operation.

16 SET key

→ 26 → 33

- : For use in setting the editing result and input title in memory.
- : When pressed in the recording pause mode, the MEMORY REC function is set and recording starts from the sound approximately 6 seconds before the current sound.

17 JOG DIAL

→ 18 → 20 → 33

Skip down (◀◀)/ Skip up(▶▶) knob

- : During playback, rotate to skip tracks.
- : Before starting recording in record mode, rotate to select the recording setting adjustment mode.
- : During title search, rotate to select a track number.
- : During title input, rotate to select a track number or a character.
- : During editing, rotate to select the editing mode or a track number.

18 ENTER/TIME DISPLAY key

→ 34 → 49

ENTER

- : For use in executing the editing and title input operations.

TIME DISPLAY

- : Press to switch the time and title display modes.

19 EDIT/SPACE key

→ 33 → 48

EDIT

- : Press to switch the editing mode ON/OFF.

SPACE

- : Press to insert a blank space character during the title input operation.

20 OUTPUT LEVEL DOWN (▽) key

→ 12

- : Use this to decrease the volume of the headphones and the output level.

21 OUTPUT LEVEL UP (△) key

→ 12

- : Use this to increase the volume of the headphones and the output level.

22 Record (●) key

→ 26 → 28 → 30

- : Press to start recording.

In stop mode

- : When the ● key is pressed while a recordable disc is present in the unit, it enters record-pause mode. (It enters record-pause mode at the position immediately after the last existing track.)

In record-pause mode

- : When the ● key is pressed, the SOUND SYNCHRO REC standby mode is set.
- : In the SOUND SYNCHRO REC standby mode, the set functions in the same way as in the normal recording pause mode.

23 PHONES jack

- : Connect stereo headphones (optional) here.

Remote control unit (DMF-5020)

The remote control unit incorporates the basic operation keys as well as a variety of applied operation keys so that it can be used in a wide range of purposes.

The keys on the remote control unit with the same names as on the main unit have the same function as the keys on the main unit.

1 ON/STANDBY key

: Press to turn the unit between ON and STANDBY (I/⏻) modes.

2 OUTPUT LEVEL (Δ▽) keys

: Use these to adjust the output level and the volume of the headphones.

3 Character editing keys

TIME DISPLAY key

: Press to switch the time and title display.

CHARA. (Character)/ P.MODE (Play Mode) key

CHARA.

: Press to select a character group during the title input operation.

P.MODE

: Press to initiate the program mode.

DELETE / CLEAR key

DELETE

: During title input, press to delete a character.

CLEAR

: During editing, press to clear a selected track number.

: In program mode, press to clear the program.

SPACE / CHECK key

SPACE

: During title input, press to insert a blank space character.

CHECK

: In program mode, press to check the program contents.

4 MONITOR key

: Press to monitor the sound being input from the source while the unit is in stop mode.

METER key

: Press to switch the level meter display contents.

RANDOM key

: Press to initiate the random play mode.

REPEAT key

: Press to switch the repeat modes for repeat playback.

5 Basic operation keys

- ▶ : Play key
- ◀◀, ▶▶ : Skip down/up keys
- : Record key
- : Stop key
- ⏸ : Pause key

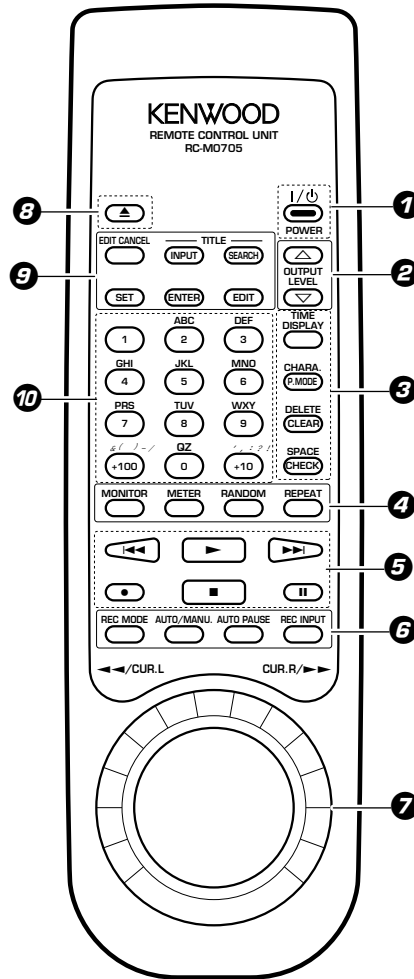

Model: RC-M0705
Infrared ray system

7 CURSOR / ◀◀, ▶▶ shuttle CURSOR

: During title input, rotate to move the cursor.

◀◀, ▶▶

: Use this during playback for forward and reverse search.

8 EJECT (▲) key

9 Editing mode keys

EDIT CANCEL key

: Press to cancel the editing operation.

TITLE INPUT key

: Press to switch the title input mode ON/OFF.

TITLE SEARCH key

: Press to switch the title search mode ON/OFF.

: During title editing, press to switch the title change input mode between the "overwrite mode" and "insert mode".

SET key

: This key is used in the title assignment or editing operations.

: When pressed in the recording pause mode, the MEMORY REC function is set and recording starts from the sound approximately 6 seconds before the current sound.

ENTER key

: Press to execute editing or enter the input title in memory.

EDIT key

: Press to switch the editing mode ON/OFF.

10 Numeric keys

0-9

: Press when selecting a track number directly.

+10

: Press when selecting a track number 10 or more.

+100

: Press when selecting a track number 100 or more.

: These keys are also used to select a character or symbol during title editing.

Remote control unit (DMF-3020/MD-203)

The remote control unit incorporates the basic operation keys as well as a variety of applied operation keys so that it can be used in a wide range of purposes.

The keys on the remote control unit with the same names as on the main unit have the same function as the keys on the main unit.

① Numeric keys / Character editing keys

Numeric keys

0-9

: Press when selecting a track number directly.

+10

: Press when selecting a track number 10 or more.

+100

: Press when selecting a track number 100 or more.

: These keys are also used to select a character or symbol during title editing.

CHARACTER DELETE / CLEAR key

CHARACTER DELETE

: During title input, press to delete a character.

CLEAR

: During editing, press to clear a selected track number.

: In program mode, press to clear the program.

CHARACTER SPACE / CHECK key

CHARACTER SPACE

: During title input, press to insert a blank space character.

CHECK

: In program mode, press to check the program contents.

CHARA. (Character)/ P.MODE (Play Mode) key

CHARA.

: Press to select a character group during the title input operation.

P.MODE

: Press to initiate the program mode.

② ON/STANDBY key

: Press to turn the unit between ON and STANDBY (I/⏻) modes.

③ REPEAT key

: Press to switch the repeat modes for repeat playback.

RANDOM key

: Press to initiate the random play mode.

④ OUTPUT LEVEL (Δ▽) keys

: Use these to adjust the output level and the volume of the headphones.

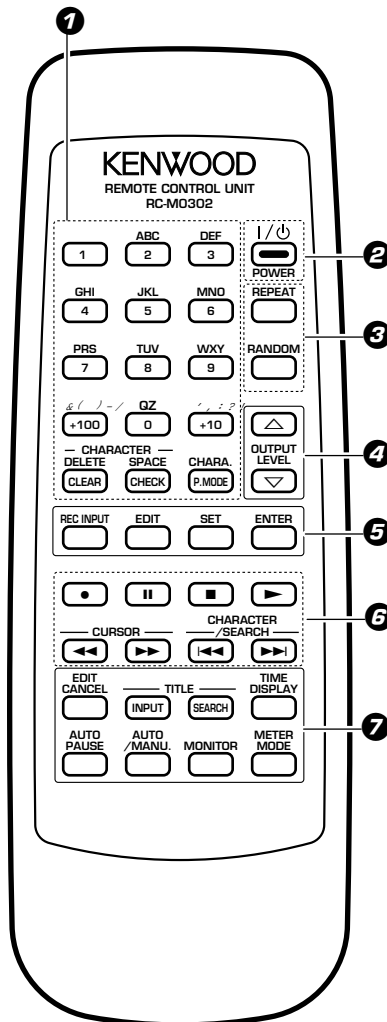

Model: RC-M0302
Infrared ray system

⑥ Basic operation keys

● : Record key

⏸ : Pause key

■ : Stop key

▶ : Play key

CURSOR / ◀▶, ▶▶, ▶▶▶ keys

◀▶, ▶▶▶

: During playback, press to fast forward or fast reverse the play.

CURSOR

: During title input, press to move the cursor.

CHARACTER/SEARCH/◀▶, ▶▶▶ keys

CHARACTER

: Press to select a character group during the title input operation.

SEARCH

: During title search, rotate to select a track number.

◀▶, ▶▶▶

: During playback, press to skip tracks in the forward or reverse direction.

⑦ Applied operation keys

EDIT CANCEL key

: Press to cancel the editing operation.

TITLE INPUT key

: Press to switch the title input mode ON/OFF.

TITLE SEARCH key

: Press to switch the title search mode ON/OFF.

: During title editing, press to switch the title change input mode between the "overwrite mode" and "insert mode".

TIME DISPLAY key

: Press to switch the time and title display.

AUTO PAUSE key

: When this key is pressed, the pause mode is initiated automatically at the point where the track number changes during playback.

: When pressed in the recording or recording standby mode, the AUTO REC PAUSE mode is turned on.

AUTO/MANU. key

: Selects whether the track numbers are to be marked automatically during recording (AUTO) or to be marked manually after it (MANUAL).

MONITOR key

: Press to monitor the sound being input from the source while the unit is in stop mode.

METER MODE key

: Press to switch the level meter display contents.

⑤ Editing mode keys

REC INPUT key

: Press to switch the recording input line between digital (optical/coaxial), analog and monaural.

EDIT key

: Press to switch the editing mode ON/OFF.

SET key

: This key is used in the title assignment or editing operations.

: When pressed in the recording pause mode, the MEMORY REC function is set and recording starts from the sound approximately 6 seconds before the current sound.

ENTER key

: Press to execute editing or enter the input title in memory.

Loading batteries

1 Remove the cover.

RC-M0705 (For DMF-5020)

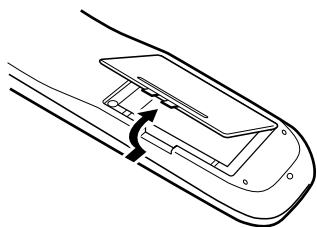

2 Insert batteries.

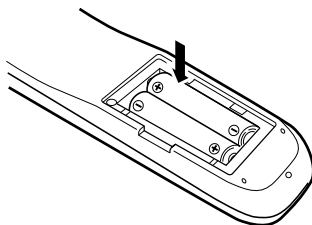

- Insert two R03 ("AAA"-size) batteries following the polarity indications.

3 Close the cover.

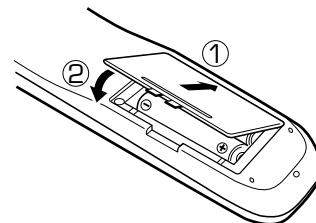
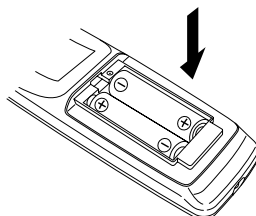
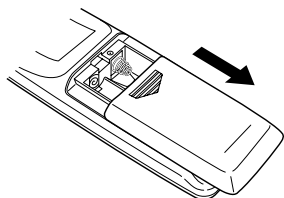
RC-M0302
(For DMF-3020/MD-203)

- Insert two R6 ("AA"-size) batteries following the polarity indications.

Operation

Plug the power cord into a power outlet, then turn on the main unit's POWER key to turn the power on. (If in the standby mode, press the ON/STANDBY key on the remote control unit.) Once the power has been switched ON, press the desired operation key.

- When pressing more than one remote control keys successively, press the keys securely by leaving an interval of 1 second or more between pressing of keys.

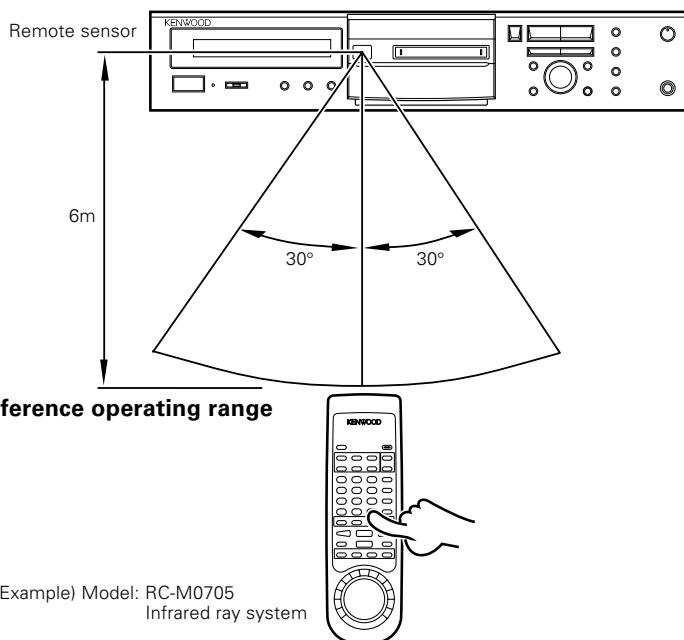

1. The provided batteries are intended for use in operation checking, and their service life may be short.
2. When the remote controllable distance becomes short, replace all batteries with new ones.
3. If direct sunlight or the light of a high-frequency fluorescent lamp (inverter type, etc.) is incident to the remote sensor, malfunction may occur. In such a case, change the installation position to avoid malfunction.

Playback of Mini Disc

Use the following procedure to play an MD in the original order of tracks from track No. 1.

Before playing an MD

Set the **TIMER** switch to **OFF**.

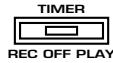

Disc recorded in monaural mode

This unit is capable of playing a Mini Disc recorded in the "monaural long-play mode." As the "monaural long-play mode" requires half the amount of data required for stereo mode recording, the playing time (recording time) of the disc is doubled (to max. 148 minutes) from that in the stereo mode.

- A Mini Disc recorded in the "monaural long-play mode" cannot be played normally with equipment which is not compatible with monaural playback.

Playing tracks in order from track No. 1

1 Turn the power ON.

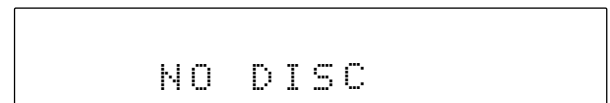
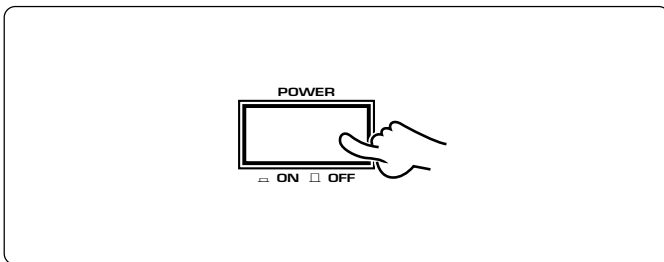

In case no disc is loaded:

2 Load a Mini Disc.

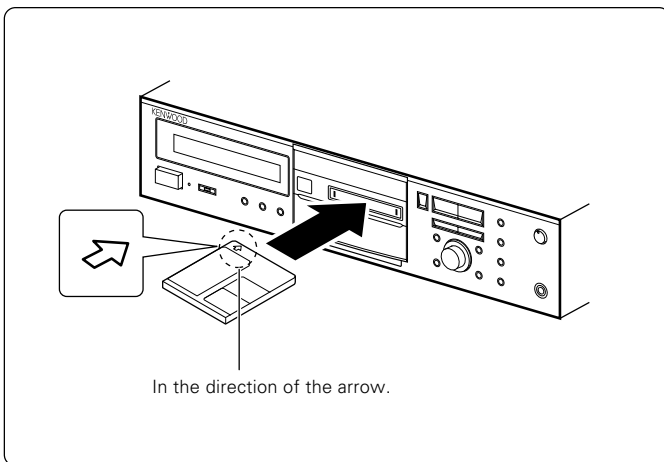

- Insert a Mini Disc into the slot securely.
- "READING" blinks while the unit checks the contents of the disc.
- If a title has been assigned to the disc, that title will be displayed.

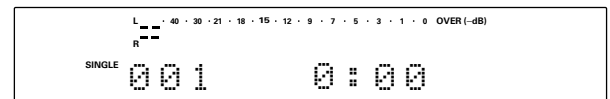

- If the "PGM" indicator is lit, press the **CHARA. / P.MODE** key of the remote control unit to turn it off.

3 Start playback.

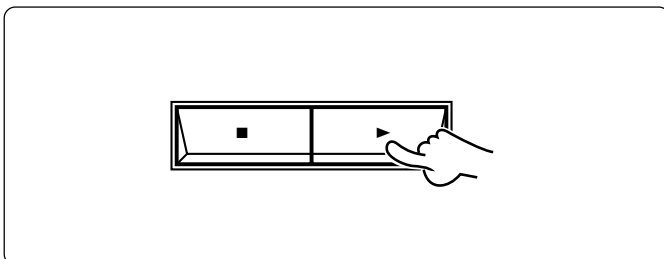

- In a few seconds, playback starts from track No. 1.

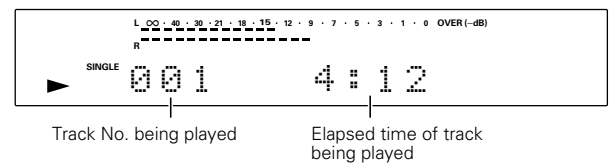

Preparation

- ① Put the MD recorder in stop mode.
- ② Check the track mode. ("PGM" goes off)



Searching a desired track by its title (TITLE SEARCH)

1 Press the **TITLE SEARCH** key.



Pressing the **TITLE SEARCH** key again cancels the title search mode.

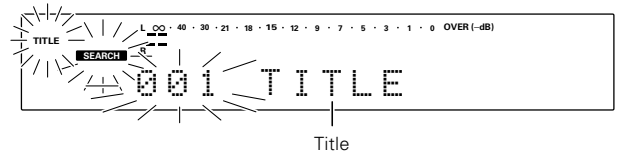

- With a track to which no title has been assigned, the track number and "....." are displayed.
- Title search is possible in either stop or play mode.

2 Select the desired title.

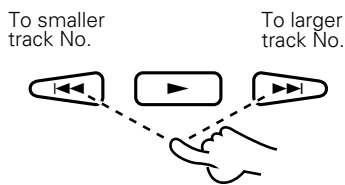

Pressing the **TITLE SEARCH** key again cancels the title search mode.

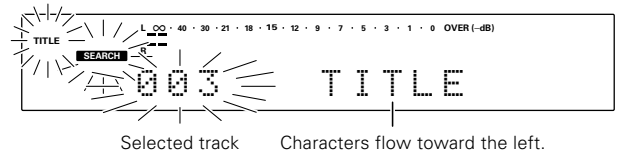

Selected track Characters flow toward the left.

3 Start playback.

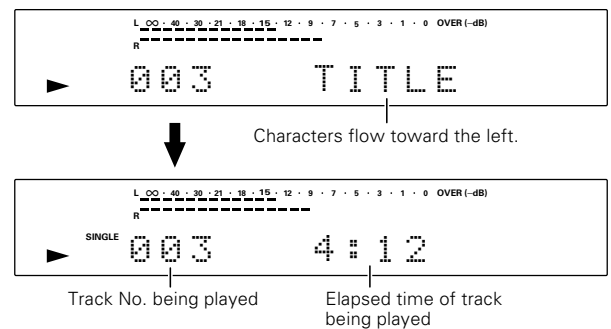

- Playback starts in a few seconds.

Playback from desired track

1 Enter the track mode.

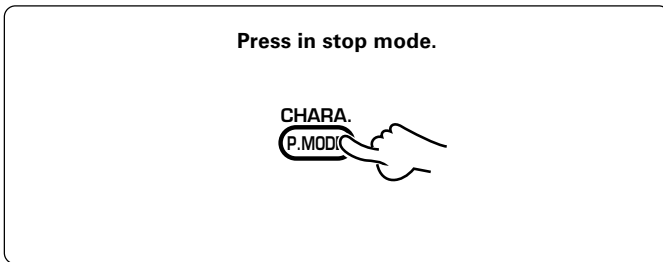

Each press switches the mode.

- ① **Track mode** : PGM goes off
- ② **Program mode** : PGM lights up

"PGM" goes off

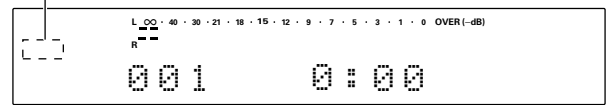

2 Select the desired track number.

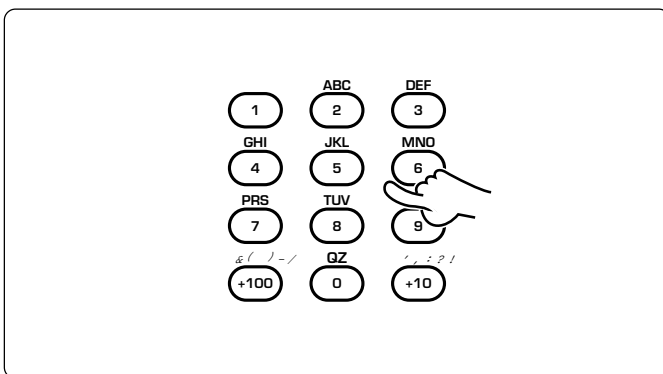

Press the numeric keys as shown below....

- To enter track No. 23 : **+10**, **+10**, **3**
- To enter track No. 40 : **+10**, **+10**, **+10**, **+10**, **0**
- To enter track No. 212 : **+100**, **+100**, **+10**, **2**

To start playback directly from a part of a track....

- Early part of track No. 7 (7.2) : **7** **0** **2**
- Middle part of track No. 7 (7.5) : **7** **0** **5**
- Latter part of track No. 7 (7.8) : **7** **0** **8**
- Middle part of current track (.5) : **0** **5**

- If a track NO. which does not exist on the disc is selected while "READING" is blinking, the last track on the disc will be played.

Random playback

1 Enter the track mode.

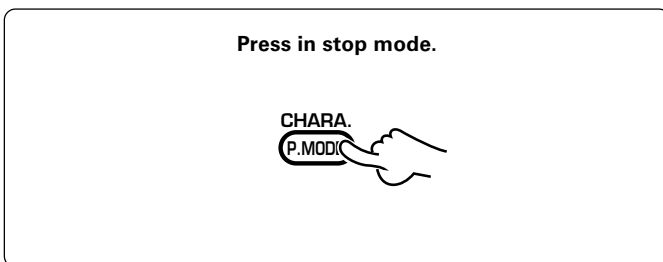

Each press switches the mode.

- ① **Track mode** : PGM goes off
- ② **Program mode** : PGM lights up

"PGM" goes off

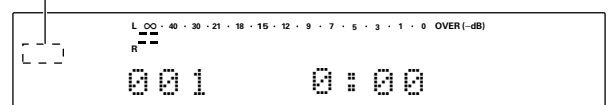

2 Press the RANDOM key.

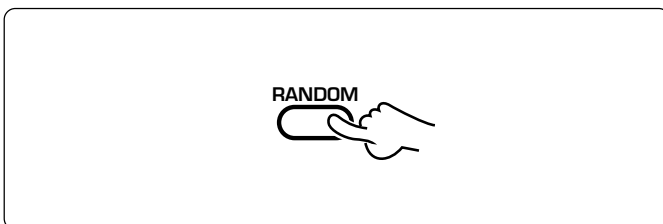

- Random playback is not possible in the program mode.
- If the **RANDOM** key is pressed during random playback, random playback is cancelled and normal playback continues from that point. (If pressed near the end of the track, playback may skip to the beginning of the next track.)
- If the **RANDOM** key is pressed during normal playback, playback of the current track stops and random playback begins.

Skipping tracks

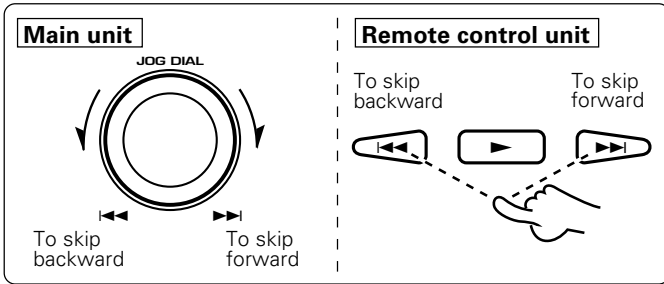

- The track in the direction of the pressed key is skipped, and the selected track will be played from the beginning.
- When the ◀◀ key is pressed once during playback, the track being played will be played from the beginning.
- To return to the beginning of the previous track to the current track, press the ◀◀ key in less than about 2 seconds after the restart of the current track.

Searching in a track

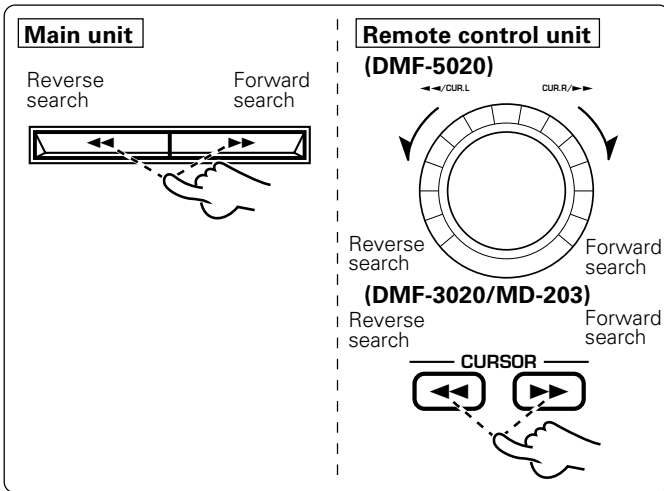

- Playback restarts from the position with which the key is released or the jog dial operation is terminated. (If the key was pressed in the pause mode, the unit returns to the pause mode at that position.)
- Sound is output when using forward or reverse search during playback.
- If forward or reverse search is started during play-pause, the disc can be searched at a high speed but sound is not output.
- When the reverse search is started during the program mode and the beginning of the current track is attained, it will be played from the beginning. → 21

To pause playback

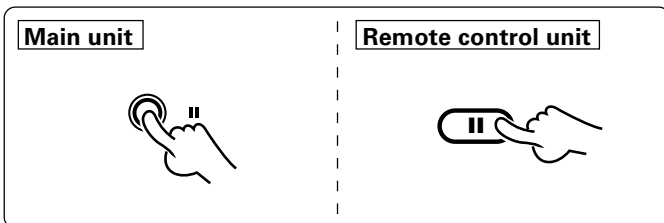

- Each press pauses and plays the MD alternately.

To stop playback

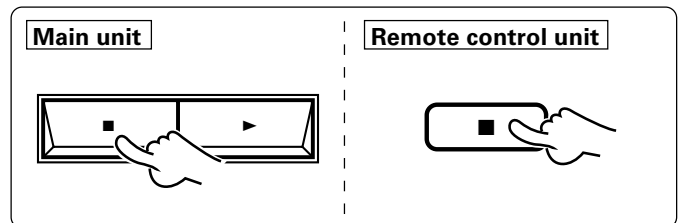

Ejecting the disc

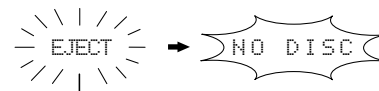
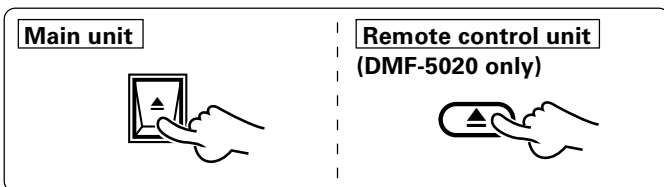

Mini Disc has been ejected.

AUTO PAUSE key (Remote control unit only)

When the AUTO PAUSE key is pressed, playback pauses after every track. This function is convenient for learning a foreign language or when time is required after each track.

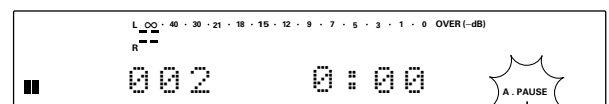
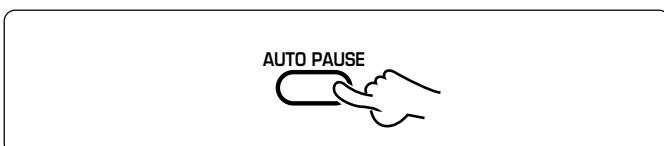

"A. PAUSE" lights up

- Press the ▶ key to resume playback.
- When this function is not required, be sure to press the **AUTO PAUSE** key so that the "A. PAUSE" indicator is extinguished.

Programming

Use the following procedure to program desired tracks in a desired order. (up to 32 tracks)

Preparation

- ① Load a disc.
- ② Put the MD recorder in stop mode.



Programming tracks in a desired order

1 Initiate the program mode.



Each press switches the mode.

- ① **Track mode** : PGM goes off
- ② **Program mode** : PGM lights up

"PGM" lights up

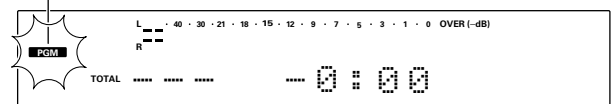

2 Select track numbers in the order you want to play them.

① Select the track number to be played.

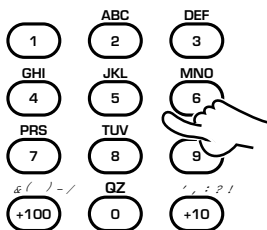

Press numeric keys in the following order.

To select track No. 12:

Press in order of **[+10]**, **[2]** key.

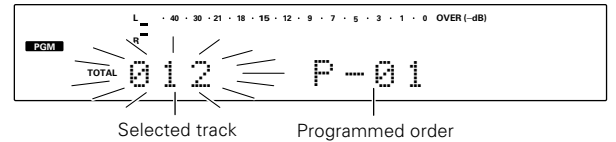

② Set the input track number.



Repeat steps ① and ② till the desired tracks have been programmed, in the desired order.

- Up to 32 tracks can be selected. "FULL" is displayed when no more track can be programmed.
- If you made a mistake, press the **DELETE / CLEAR** key and enter the track No. again.
- An extremely shot track cannot be programmed.
- "–**:*" is displayed when the total programmed period has attained 256 minutes or more.

- The input operation is aborted if the **CHARA. / P.MODE** key is not pressed while the indicator is blinking.

3 Start playback.

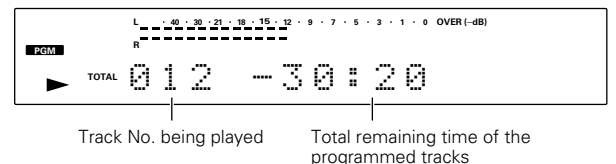

- Tracks will be played in the order they are programmed.
- When the **◀◀** or **▶▶** key is pressed during playback, tracks will be skipped in the direction of the pressed key.

To add a track to the program

Press in stop mode.

A numeric keypad with letters and symbols above each number. A hand is shown pressing the '6' key, which is labeled 'CHARA. P.MODE'.

- When a track No. is entered, the track will be added to the end of the existing program.
- The input operation is aborted if the **CHARA. / P.MODE** key is not pressed while the indicator is blinking.

Checking the order of tracks

A hand is shown pressing the 'SPACE CHEC' key.

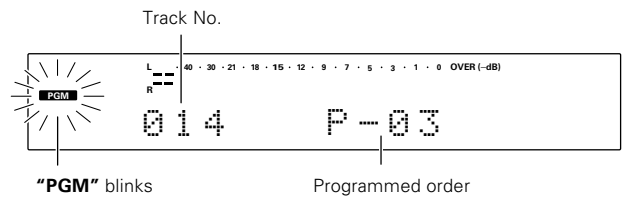

- Each press displays the next track in the program.

To clear tracks from the program

Clearing tracks from the end

Press in stop mode.

A hand is shown pressing the 'DELETE CLEAR' key.

Clearing all tracks

Press in stop mode.

A hand is shown pressing the 'CHARA. P.MODE' key or a hand is shown pressing a key with an upward-pointing triangle.

Remote control unit
(The ▲ key is only provided on the DMF-5020.)

The number of the track that has been cleared is displayed.

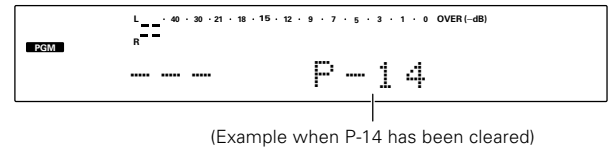

- The entire program is cleared.

The programmed tracks can be played repeatedly.

Preparation

Put the MD recorder in stop mode.



Repeated playback

To repeat only the programmed tracks

1 Program the tracks to be repeated.

1 Initiate the program mode.



2 Select the desired tracks in the desired order.

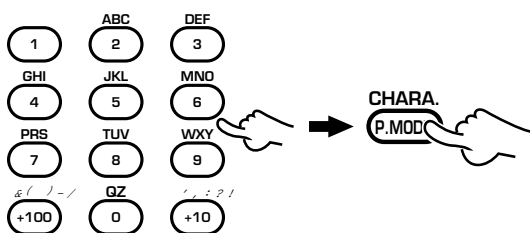

2 Repeat the procedure 2.

3 Enter the repeat mode.



4 Start playback.



Each press switches the mode.

- 1 Track mode : PGM goes off
- 2 Program mode : PGM lights up

"PGM" lights up

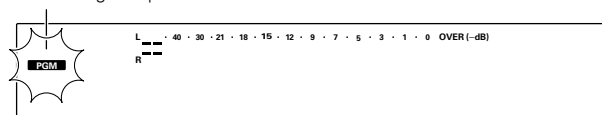

- All of the programmed tracks will be repeated.
- In case only one track is programmed, only that track will be repeated.

"REPEAT" lights up

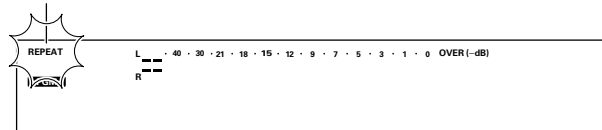

To stop repeated playback

Press the REPEAT key again.

- The "REPEAT" indicator goes off and the playback following the current mode (PROGRAM) of the MD player starts.

To repeat the entire disc

1 Enter the track mode.



2 Enter the repeat mode.



3 Start playback.



Each press switches the mode.

- 1 Track mode : PGM goes off
- 2 Program mode : PGM lights up

"REPEAT" lights up

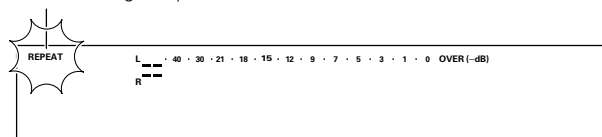

To stop repeated playback

Press the REPEAT key again.

- The "REPEAT" indicator goes off and the playback following the current mode (TRACK) of the MD player starts.

AUTO / MANU. key

This key is used to select whether track numbers are to be marked automatically during recording or they are to be marked manually during or after recording. The track numbers can be used to locate the beginning of a track during playback or programming tracks.

Select before starting recording.



(Remote control unit)

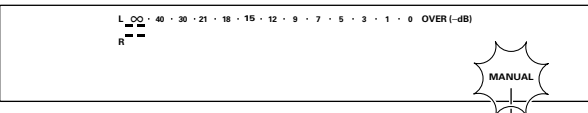

Extinguished in "AUTO" mode, lit in "MANUAL" mode.

AUTO

If a no-sound input has lasted for the time set for the AUTO TIME function during recording, the track number will be incremented automatically by "1". Usually, use this position for recording. Use this mode when recording all of the tracks in a CD. When recording music containing a continuous section with a very low level, for example when recording classic music, the track number may be incremented by "1" after such a section. In this case, cancel the track number later. It is recommended to use the MANUAL mode when recording such a kind of music. During digital recording of CD, the track number is incremented automatically by "1" according to the data contained in the digital information. The no-sound blank is not detected. When the CD track number is increased during manual search of a CD, the track number recorded on the MD may sometimes fail to be incremented. A no sound track may sometimes created at the moment the played CD stops.

MANUAL

With this setting, the MD track number is not incremented automatically during recording. Track numbers can be marked either during editing (by pressing the EDIT key) or after recording (by executing the TRACK DIVIDE operation → (37)). Even when "MANUAL" is set, the AUTO CUT and AUTO PAUSE functions work if the "AUTO CUT" and "REC AUTO PAUSE" settings are turned on. This setting is convenient when recording a CD which has been recorded in live or which contains very low-level sound such as a classical music CD.

MONITOR key

Press to monitor the sound being input from the source while the unit is in stop mode. When the REC INPUT is DIGITAL, the sampling rate (48 kHz, 44.1 kHz, 32 kHz) of the input digital signal can be displayed by pressing this key.

Press in stop mode.

Main unit

MONITOR / DELETE



Remote control unit

MONITOR



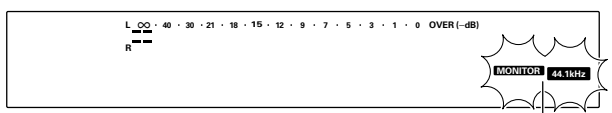



"MONITOR" and "Sampling rate" lights up

REC MODE key

The recording-related settings can be adjusted precisely by selecting the proper display modes.

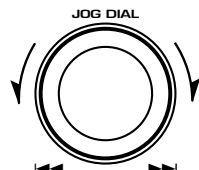
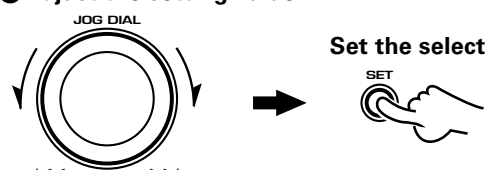
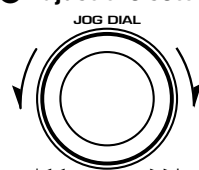
Selecting the setting adjustment mode

- ① Switch the REC MODE on.
REC MODE/CHARAC.

- ② Select the setting adjustment mode.
JOG DIAL
 → **Set the selection.**
SET

- ③ Adjust the setting value.
JOG DIAL
 → **Set the selection.**
SET

To change another setting, press the SET key. (This returns to step ② above.)

Each press switches the mode.

- ① REC MODE : off
- ② REC MODE : on

The modes are switched by rotating the JOG DIAL.

- AUTO CUT?** : AUTO CUT on/off selection.
- AUTO TIME?** : Setting of the time for detecting a no-sound blank section during automatic track number marking.
- AUTO LEVEL?** : Automatic track number marking no-sound blank detection level and SOUND SYNCHRO REC, AUTO CUT and REC AUTO PAUSE sound detection level setting
- REC→ WRITING?** : Setting of the UTOC writing after recording.

- Step ③ consists of adjusting the setting of the "Setting adjustment mode" selected in step ②.
- To end the setting adjustment, press the REC MODE/CHARAC. key again.

When "AUTO CUT?" is displayed

The "AUTO CUT" function sets "SOUND SYNCHRO REC" to the pause mode automatically when the sound falls below a certain level during recording.

If the SET key is pressed while "AUTO CUT?" is displayed, the initial AUTO CUT mode setting display appears.

Use the skip up/down knob to select AUTO CUT ON or OFF, then press the SET key to enter that setting.

The initial setting is "AUTO CUT *OFF".

Initial display

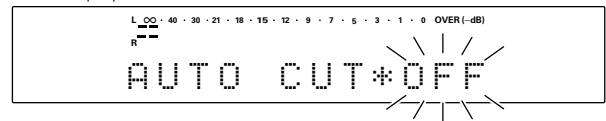

Setting display

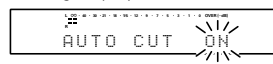

During recording



When "AUTO TIME?" is displayed

(This is effective except during digital recording of CD)

Pressing the SET key while "AUTO TIME?" is displayed initiates the initial display for the no-sound blank detection time adjustment for automatic track number marking.

Use the skip up/down knob to set the no-sound blank detection time, then press the SET key to enter that time.

The initial setting is "TIME * 2.0 SEC", which can be set in the time range between 0.5 and 4.0 seconds set in 0.5-second steps.

Initial display

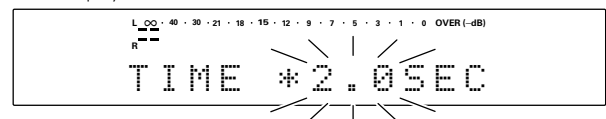

Adjusted value display



When "AUTO LEVEL?" is displayed

If the SET key is pressed when "AUTO LEVEL?" is displayed, the initial AUTO LEVEL mode setting display appears. The AUTO LEVEL mode setting sets the auto track number no-sound blank detection level as well as the SOUND SYNCHRO REC, AUTO CUT and REC AUTO PAUSE detection levels, all at once.

Use the skip up/down knob to set the no-sound blank detection level, then press the SET key to enter that level.

This level is set for all the above functions.

The initial setting is "LEVEL *0". The level can be set between +3 and -3.

Initial display

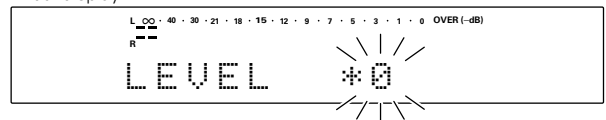

Adjusted value display



Setting	-3	-2	-1	*0	+1	+2	+3
AUTO TNO				Track number increments less easily	↔	Track number increments more easily	
AUTO CUT				Recording pauses less easily	↔	Recording pauses more easily	
REC AUTO PAUSE				Recording pauses less easily	↔	Recording pauses more easily	
SOUND SYNCHRO REC				Recording starts more easily	↔	Recording starts less easily	

● During analog recording, noise on the tape, etc., may activate the SOUND SYNCHRO REC function, causing recording to start. If this happens, raise the setting level.

AUTO TNO (Automatic track number) : Track number increments automatically

When "REC → WRITING?" is displayed

"WRITING" refers to the writing of recording-related data in the Mini Disc.

Pressing the SET key while "REC → WRITING?" is displayed initiates the initial display for the writing mode setting. The initial setting is "WRITING *ON".

Use the skip up/down knob to select whether or not to write the UTOC when recording is completed (ON or OFF), then press the SET key to enter that setting.

Initial display

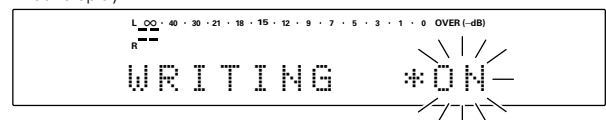

Setting display

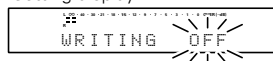

26 Recording can be started or paused simultaneously with the sound and from the sound approximately 6 seconds before the current sound.

Preparation

Set the recording pause mode.

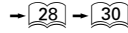

Automatically starting recording when the track starts (SOUND SYNCHRO REC)

Recording starts when a sound above a certain level is input. This function is particularly convenient when combined with the AUTO CUT function to record selected tracks.

Press while in the recording pause mode.



When the track starts, recording starts.

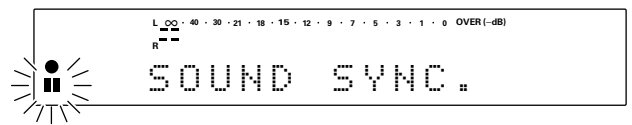

- The sound detection level can be adjusted with the REC MODE "AUTO LEVEL" setting. → 24
- When the ● key is pressed again, the normal recording pause mode is set.
- For some music sources, the beginning of the track may be cut off.

Automatically pausing recording when the track ends (REC AUTO PAUSE)

Recording is automatically paused when the sound input is below a certain level for over 3 seconds or when the track number changes during digital recording of a CD. This function comes in handy when you only want to record one track from the CD.

Press while in the recording or recording pause mode.

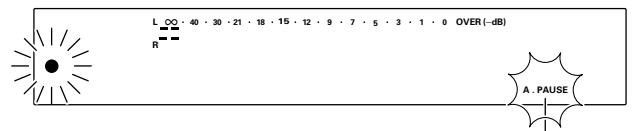
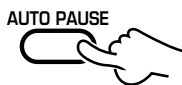

"A. PAUSE" lights up

- The sound detection level can be adjusted with the REC MODE "AUTO LEVEL" setting. → 24
- Press the ■ key or the AUTO PAUSE key again to cancel the REC AUTO PAUSE mode.

Starting recording from the sound before the current sound (MEMORY REC)

Recording starts from the sound 6 seconds before the point at which the key is pressed. Use this for example when recording radio programs.

Press while in the recording pause mode.



Recording starts from the sound 6 seconds before the current sound.

- It is not possible to start recording from the sound 6 seconds before the current sound if less than 6 seconds have passed in the recording pause mode.

Recording (ANALOG input)

The input jacks connected with audio cords accept analog signals. This unit records the analog signal from the REC IN jacks by converting it into digital signal. (This recording is simply referred to as analog recording.)

Preparation

- 1 Open the write protect tab of the Mini Disc to make it recordable. → 8
- 2 Load the Mini Disc.
- 3 Check the remaining recording time. → 49
- 4 Set the amplifier's input selector to the source to be recorded.

ANALOG recording

1 Adjust the settings if required.

- 1 Switch the REC MODE on.

REC MODE/CHARAC.



- 2 Select the setting adjustment mode.

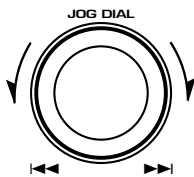

- 3 Set the selection.



Go to step 2 if setting adjustments are not required.

Each press switches the mode.

- 1 REC MODE : off
- 2 REC MODE : on

The modes are switched by rotating the JOG DIAL.

- AUTO CUT?** : AUTO CUT on/off selection.
- AUTO TIME?** : Setting of the time for detecting a no-sound blank section during automatic track number marking.
- AUTO LEVEL?** : Automatic track number marking no-sound blank detection level and SOUND SYNCHRO REC, AUTO CUT and REC AUTO PAUSE sound detection level setting.
- REC→ WRITING?** : Setting of the UTOC writing after recording.

● For details on the setting adjustment modes, see "REC MODE key".

→ 24

2 Select ANALOG or MONO.

REC INPUT



Each press switches the mode.

- 1 ANALOG : Analog "stereo mode"
- 2 DIGITAL 1 : Optical input mode
- 3 DIGITAL 2 : Coaxial input mode
- 4 MONO : Analog "monaural long-play mode"

"ANALOG" lights up

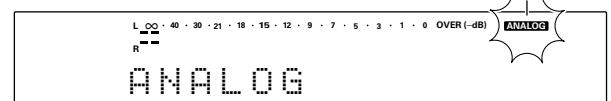

- MONO cannot be selected during recording pause.
- The REC INPUT cannot be changed during pause in the MONO mode.
- The analog "monaural long-play mode" allows to double the recording time compared to recording in the stereo mode.

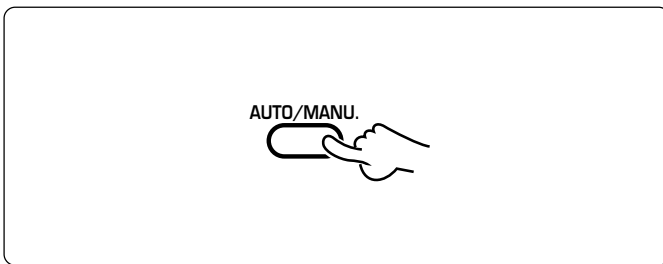
3 Select "AUTO" or "MANUAL". (Remote control unit only)

Each press switches the mode.

- ① goes off (**AUTO**) : Track numbers are marked automatically. → 24
- ② **MANUAL** : Track numbers can be marked as desired. → 24

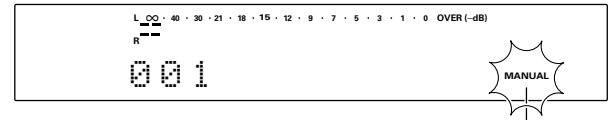

Extinguished in "AUTO" mode, lit in "MANUAL" mode.

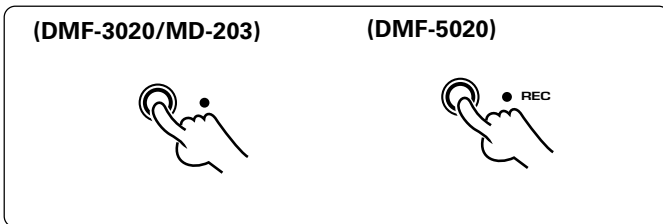
4 Enter record-pause mode.

- The unit enters record-pause mode automatically when the ● key is pressed.

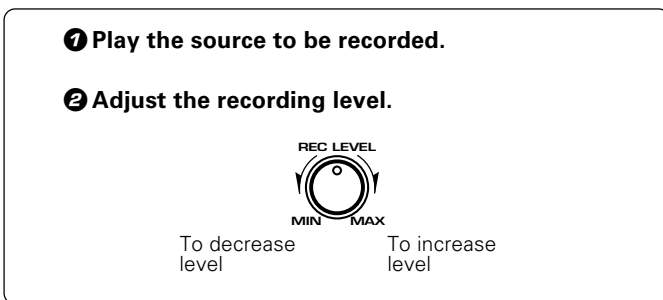
5 Adjust the recording level. (Main unit only)

- Decrease the level if the red segments of the peak level meter light.

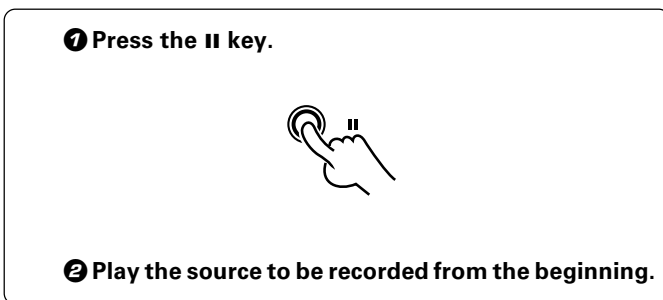
6 Start recording.

Recording is not possible if the following characters are displayed.

- "DISC FULL" : Disc is full
→ Erase undesired tracks. → 41 → 43
- "PROTECTED" : The accidental erasure protect tab is open.
→ Close it. → 8
- "PLAY ONLY" : A playback-only Mini Disc is loaded.
→ Load a recordable Mini Disc.

- When the **EDIT / SPACE** key is pressed during recording, a track number is inserted in that position.

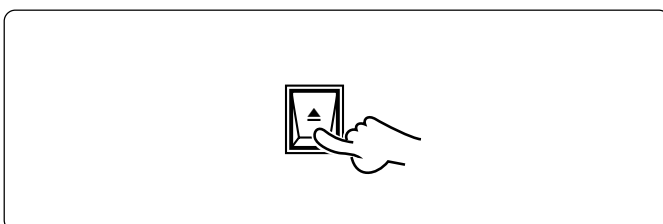
7 After recording, eject the Mini Disc.

Information is being written.

Mini Disc has been ejected.

- The eject (▲) key is not accepted during recording.



While "WRITING" is displayed, do not apply shock or vibration to the unit because information is being written on the Mini Disc.

Recording (DIGITAL input)

DMF-5020/DMF-3020/MD-203 (En)

Recording is possible using recordable Mini Discs. When this unit is connected with a component equipped with digital output, such as a CD player, through a digital cord or optical fiber cable, the signal input through the DIGITAL input jack can be recorded in the digital format (this recording is referred to as digital recording). Enjoy high-quality sound of digital recording!

29

Preparation

- 1 Open the write protect tab of the Mini Disc to make it recordable. → 8
- 2 Load the Mini Disc.
- 3 Check the remaining recording time. → 49
- 4 Set the amplifier's input selector to the source to be recorded.

DIGITAL recording

1 Adjust the settings if required.

- 1 Switch the REC MODE on.

REC MODE/CHARAC.



- 2 Select the setting adjustment mode.

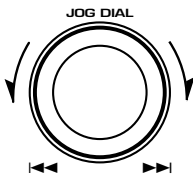

- 3 Set the selection.



Go to step 2 if setting adjustments are not required.

Each press switches the mode.

- 1 REC MODE : off
- 2 REC MODE : on

The modes are switched by rotating the JOG DIAL.

- AUTO CUT? : AUTO CUT on/off selection.
- AUTO TIME? : Setting of the time for detecting a no-sound blank section during automatic track number marking.
- AUTO LEVEL? : Automatic track number marking no-sound blank detection level and SOUND SYNCHRO REC, AUTO CUT and REC AUTO PAUSE sound detection level setting.
- REC→ WRITING? : Setting of the UTOC writing after recording.

• For details on the setting adjustment modes, see "REC MODE key".

→ 24

2 Select one of "DIGITAL 1, 2".

REC INPUT



3 Select AUTO or MANUAL. (Remotecontrol unit only)

AUTO/MANU.



Each press switches the mode.

- 1 ANALOG : Analog "stereo mode"
- 2 DIGITAL 1 : Optical input mode
- 3 DIGITAL 2 : Coaxial input mode
- 4 MONO : Analog "monaural long-play mode"

Each press switches the mode.

- 1 goes off (AUTO) : Track numbers are marked automatically. → 24
- 2 MANUAL : Track numbers can be marked as desired. → 24

4 Enter record-pause mode.

(DMF-3020/MD-203)



(DMF-5020)



- The unit enters record-pause mode automatically when the ● key is pressed.

5 Start recording.

Recording is not possible if the following characters are displayed.

- “DISC FULL” : Disc is full
→ Erase undesired tracks. → [41] → [43]
- “UNLOCK” : The digital cord or optical fiber cable is not locked in position or connected incompletely (or not connected).
→ Connect the digital cord or optical fiber cable properly. → [10]
- “SCMS ON” : Digital recording is inhibited by SCMS.
→ Use analog recording. → [27]
- “NotAudio” : The digital signal being input is not an audio signal.
→ Use analog recording. → [27]
- “PROTECTED” : The accidental erasure protect tab is open.
→ Close it. → [8]
- “PLAY ONLY” : The disc in use is a playback-only Mini Disc.
→ Use a recordable Mini Disc.

- When the **EDIT / SPACE** key is pressed during recording, a track number is inserted in that position.
- When recording is restarted after record-pause, the track number is incremented automatically by “1”.

6 Play the source to be recorded.**7** After recording, eject the Mini Disc.

- To play a track with a margin from the beginning, it is recommended to start playing the source after the time display of the MD recorder has started the count.



- The eject (▲) key is not accepted during recording.



While “WRITING” is displayed, do not apply shock or vibration to the unit because information is being written on the Mini Disc.



During recording of a CD, the track number may be incremented by “1” at the moment the CD starts to play. This is caused by a signal contained in the digital signal component of the CD. Unnecessary track numbers can be erased by following the procedure for **“Erasing the track being played (TRACK ERASE).”**

Synchro recording with CD playback

By connecting this unit with a KENWOOD "SLS" type amplifier and CD player, which are equipped with system control jacks, using system control cords, the recording of MD can be started in synchronism with the playback of the CD player.

- ❶ Set the amplifier's input selector to CD.
- ❷ Put the CD player in pause mode.
- ❸ Select the CD track to be recorded using the \ll or \gg key.
- ❹ Put the MD recorder in record-pause mode.
- ❺ Start playback of the CD player.

- Synchronized recording is not possible while the SOUND SYNCHRO REC, AUTO CUT and REC AUTO PAUSE function is operating.

DIGITAL recording and SCMS

Note that the digital recording of Mini Discs is not possible in the following cases.

Note on the sampling rate converter

Three types of digital signals are usually used according to the sampling frequencies. The sampling frequencies vary depending on the types of digital equipment as shown below.

- 48 kHz : Standard mode of DAT, B mode broadcasting of BS tuner, etc.
- 44.1 kHz : Standard mode of DAT, CD, MD, etc.
- 32 kHz : Standard and long-hour modes of DAT, A mode broadcasting of BS tuner, etc.

In general, high-quality recording based on digital signal transmission is available only when the sampling frequency of the source equipment matches that of the recorder equipment. However, this unit incorporates a sampling rate converter so that it can also record digital signals sampled at 48 kHz and 32 kHz by converting their sampling frequency into the sampling frequency of MD (44.1 kHz).

The SCMS may be activated with certain type of satellite broadcasting.

(DAT: Digital Audio Tape deck)

SCMS (Serial Copy Management System)

Designed for copyright protection, the SCMS is a prescription that copying of digital signals as they are in the digital form between digital audio equipment is allowable only for one generation.

If the digital source has a copy prohibition code, "SCMS ON" is displayed and the unit enters record-pause mode.

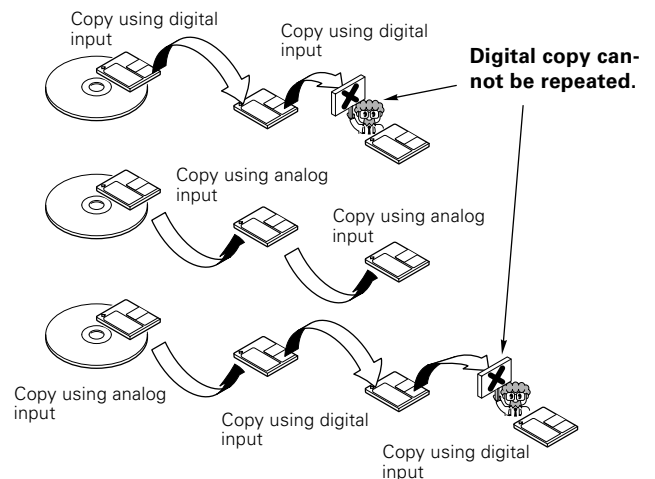

After recording of a commercially-available recordable Mini Disc, the recording can be edited in various ways. Note that it is impossible to edit a playback-only Mini Disc. (Editing is not possible while the "PGM" indicator is lit.)

The MD recorder acts based on the data loaded from the disc into the memory. As this data is written in the disc at the moment it is ejected, be sure to eject the disc every time after the title input or editing operation.

Limitation of functionality due to MD standard

Some functions are limited due to the restrictions imposed by the MD standard. Before considering the symptoms as a sign of trouble with the unit, please read "Symptoms related to MD standard". → 51

Selecting the editing function type

Reordering tracks by moving them

Moving the track being played (TRACK MOVE) → 33
 Moving several tracks at a time (QUICK MOVE) → 35

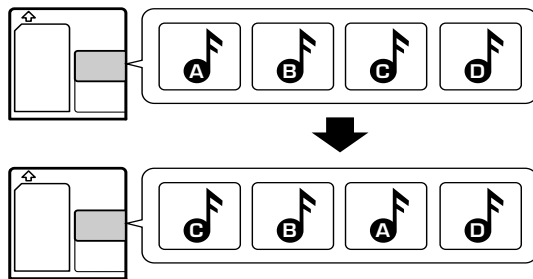

Dividing a track, combining two tracks

Dividing the track being played (TRACK DIVIDE) → 37

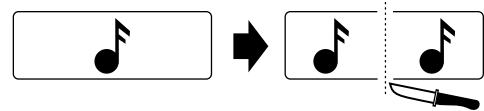

Combining the track being played (TRACK COMBINE) → 39

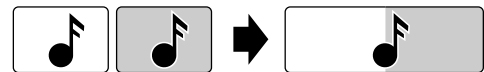

Erasing desired tracks (QUICK ERASE)

Erasing one or more track at a time (QUICK ERASE) → 43

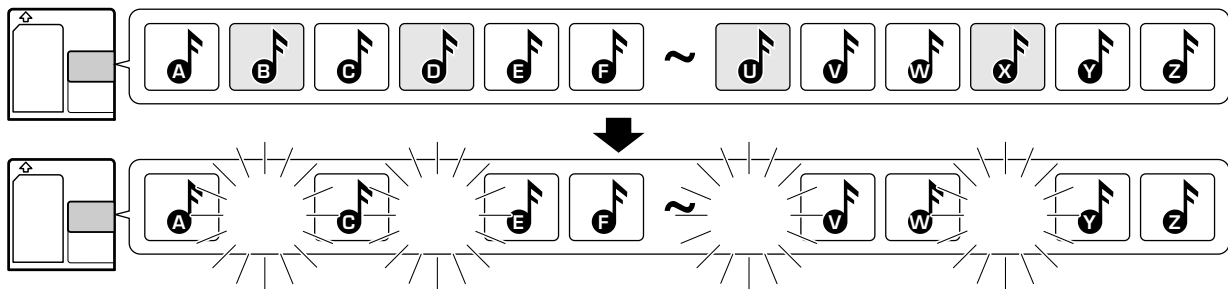

Erasing the track being played (TRACK ERASE) → 41

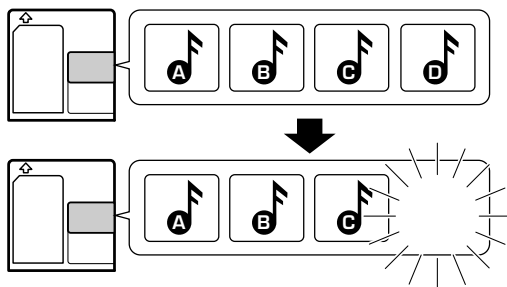

ALL ERASE → 43

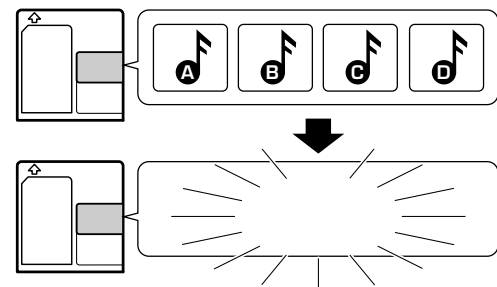

Editing titles

→ 45

Titles can be assigned to Mini Discs and tracks can have titles, and these titles can be changed or cleared later.

This procedure shows you how to select and move (insert) a track to the track number you desire. The surrounding tracks are renumbered automatically.

Preparation

- ① Play the track to be moved.
- ② Press the EDIT/SPACE key to switch the editing mode on.

Moving the track being played (TRACK MOVE)

1 Select "MOVE".

① Select "MOVE".

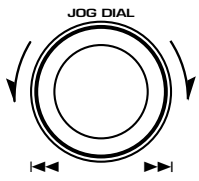

② Set the selection.



The modes are switched by rotating the JOG DIAL.

- ① **DIVIDE?** : Dividing a track
- ② **COMBINE?** : Combining tracks
- ③ **ERASE?** : Erasing track(s)
- ④ **MOVE?** : Moving (reordering) tracks

• Editing is aborted if no operation has been performed for 8 seconds.

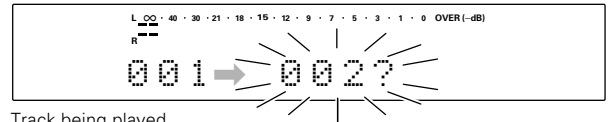
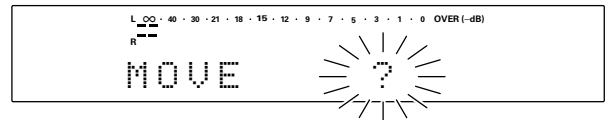

Track being played

2 Select the move destination.

① Select the move destination (the new track number to be assigned to the track being played).

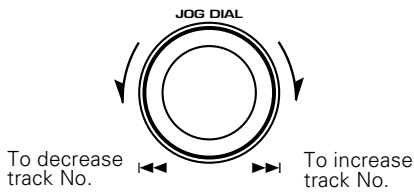

② Set the selection.



Example of MOVE: To move track No. 1 to track No. 7

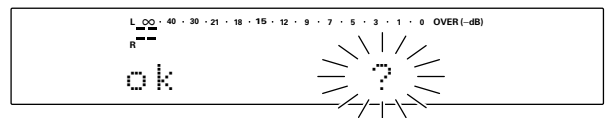
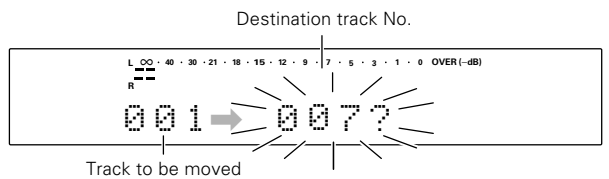

3 Execute the track reordering operation.

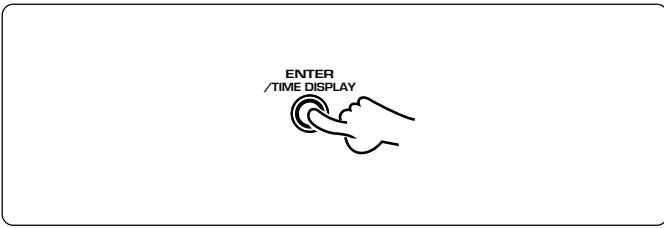

Display after execution

- “EDIT NOW!” : When editing is in progress
- “COMPLETE!” : When editing is completed successfully
- “CAN’T EDIT” : When editing is incomplete

- It takes a while until the execution completes.
- If you execute an editing operation by mistake, the condition before editing can be recovered by performing the “EDIT CANCEL” operation. → 34

4 Eject the Mini Disc.

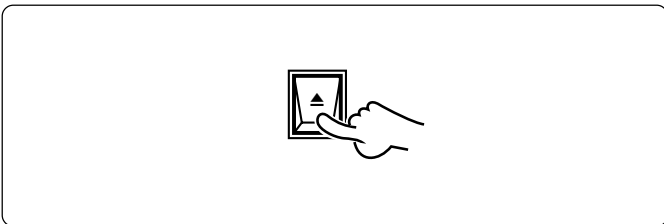

Note While “WRITING” is displayed, do not apply shock or vibration to the unit because information is being written on the Mini Disc.

Image of track moving

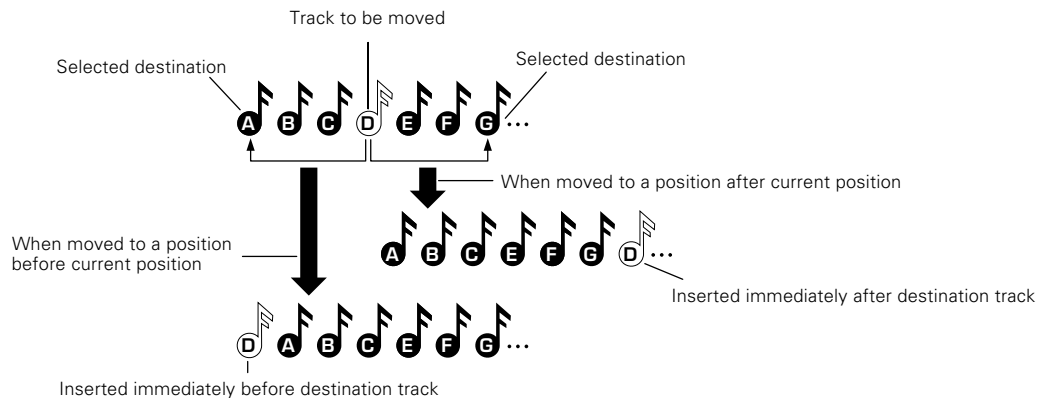

To cancel the editing results (EDIT CANCEL)

To return the Mini Disc to the condition before it was loaded in the unit, perform the following key operations before ejecting the disc.

After canceling, the editing operation can be restarted from the beginning.



- Note that editing cannot be canceled once the recording operation has been performed after “DISC ERROR” has been displayed.

Use the following procedure to change the current order of tracks by selecting a desired order and moving the tracks together.

Preparation

- ❶ Put the MD recorder in stop mode.
- ❷ Press the EDIT/SPACE key to switch the editing mode on.

Moving several tracks at a time (QUICK MOVE)

1 Select "Q.MOVE".

- ❶ Select "Q.MOVE".

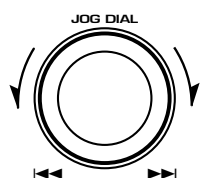

- ❷ Set the selection.



The modes are switched by rotating the JOG DIAL.

- ❶ Q.MOVE? : Moving (reordering) tracks
- ❷ Q.ERASE? : Erasing track(s)

• Editing is aborted if no operation has been performed for 8 seconds.

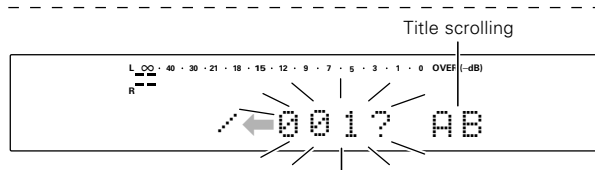
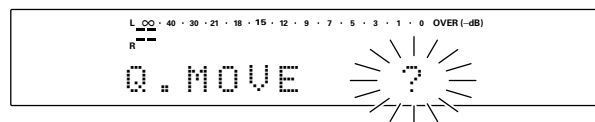

• Press the EDIT/SPACE key again to abort the editing operation.

2 Select the track numbers to be moved.

- ❶ Select a track number.

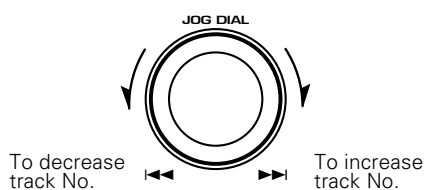

- ❷ Set the selection.



Repeat steps ❶ and ❷ until all tracks have been arranged in the desired order.

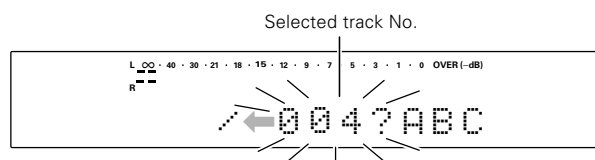

- Only the last selected track can be cleared by pressing the DELETE key of the remote control unit. (To clear all of the selected tracks, cancel editing and restart the operation from the beginning.)
- The orders of tracks can be confirmed by pressing the ◀◀ key (or ▶▶ key) of the remote control unit.

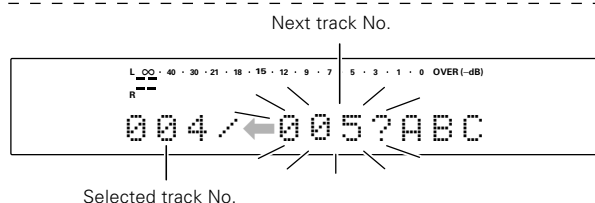

3 End the selection of the track numbers to be moved.



4 Select the move destination.

1 Select the move destination track number.

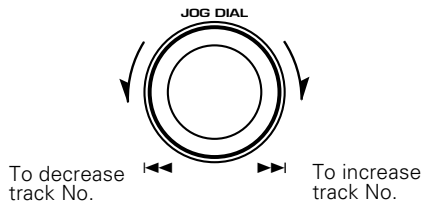

2 Set the movement destination.



Display when tracks are moved at the top of all tracks

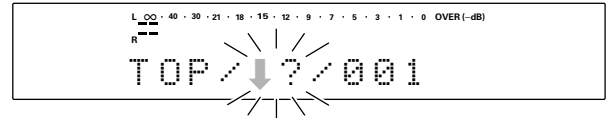

Display when tracks are moved between two track Nos.

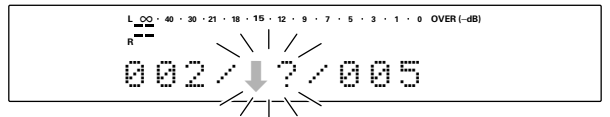

Display when tracks are moved at the end of all tracks

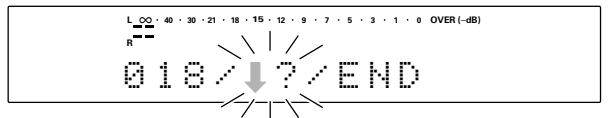

When set

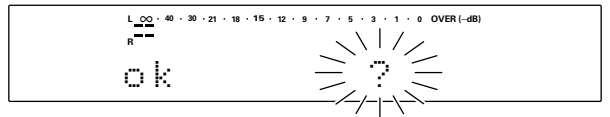

5 Execute the track reordering operation.



Display after execution

- “EDIT NOW!” : When editing is in progress
- “COMPLETE!” : When editing is completed successfully
- “CAN’T EDIT” : When editing is incomplete

- It takes a while until the execution completes.
- Do not press the **▲** or “POWER” key while “COMPLETE!” is blinking, otherwise the track reordering may be interrupted in the middle.
- If you execute an editing operation by mistake, the condition before editing can be recovered by performing the “EDIT CANCEL” operation.

6 Eject the Mini Disc .



Note While “WRITING” is displayed, do not apply shock or vibration to the unit because information is being written on the Mini Disc.

Image of track insertion

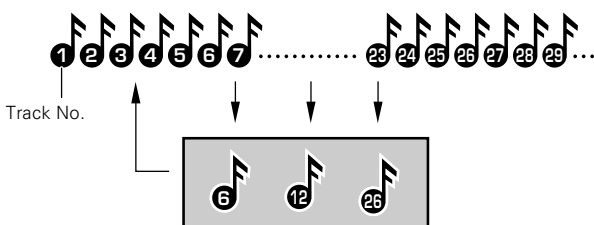

Use the following procedure to divide a track into two by inserting a track number in its middle. For example, by inserting an additional track number before the passage you are specially fond of, it is easy to skip to there when you play the disc later. Note that the track numbers of the tracks located after the divided track are automatically incremented. The preview function allows to fine-adjust the track division point by playing the divided part repeatedly.

Preparation

- ① Play the MD track to be divided.
- ② Press the EDIT/SPACE key to switch the editing mode on.

Limitation of functionality due to MD standard

Some functions are limited due to the restrictions imposed by the MD standard. Before considering the symptoms as a sign of trouble with the unit, please read "Symptoms related to MD standard".



Dividing the track being played (TRACK DIVIDE)

1 Select "DIVIDE".

① Select "DIVIDE".

② Set the selection.

When preview is not required, press the ENTER key once (so that "ok?" is displayed), then go to step 2.

2 Preview the result.

① Enter the DIVIDE mode.

② Execute preview.

③ Fine-adjust the division point.

④ Establish the division point.

The modes are switched by rotating the JOG DIAL.

- ① **DIVIDE?** : Dividing a track
- ② **COMBINE?** : Combining tracks
- ③ **ERASE?** : Erasing track(s)
- ④ **MOVE?** : Moving (reordering) tracks

● Editing is aborted if no operation has been performed for 8 seconds.

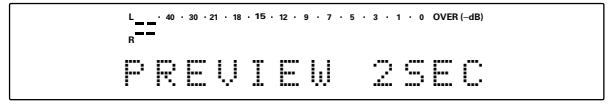
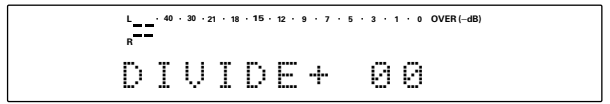
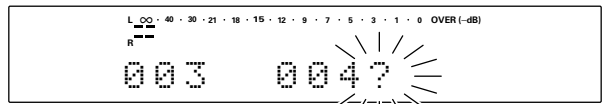
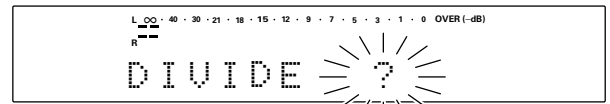

- The first 3 seconds after the division point is repeated.
- If preview is started at the end of a track, the preview continues till the next track (the first track if it is started in the last track), but the part in the next track cannot be divided by TRACK DIVIDE.

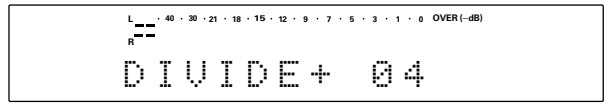

- Fine adjustment is possible while monitoring the sound.
- The dividing point can be fine-adjusted only in the forward direction from the point where the **EDIT / SPACE** key was pressed initially, in 32 steps and for about 60 ms (6/100 sec.) per step. It is recommended to start fine adjustment from slightly before the initial division point.

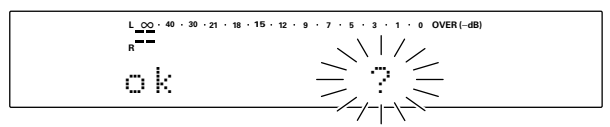

3 Execute the track divide operation.

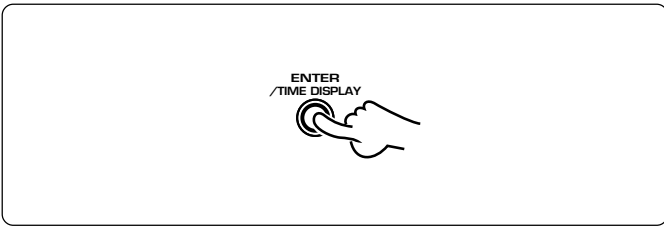

Up to 255 track numbers can be inserted additionally by repeating 1 to 3 for each of them.

4 Eject the Mini Disc.

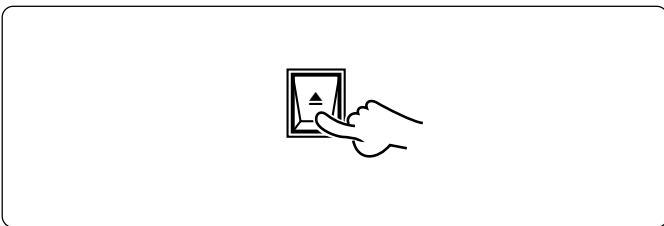

Display after execution.

- “EDIT NOW!” : When editing is in progress
- “COMPLETE!” : When editing is completed successfully
- “CAN’T EDIT” : When editing is incomplete

- It takes a while until the execution completes.
- The track is divided into two tracks.
- The unit enters pause mode at the second track.
- There is no blank space left between the two tracks.
- Track division may sometimes be impossible due to the limitations of the MD standard.
- If you execute an editing operation by mistake, the condition before editing can be recovered by performing the “EDIT CANCEL” operation. → 34



Note While “WRITING” is displayed, do not apply shock or vibration to the unit because information is being written on the Mini Disc.

Image of track division

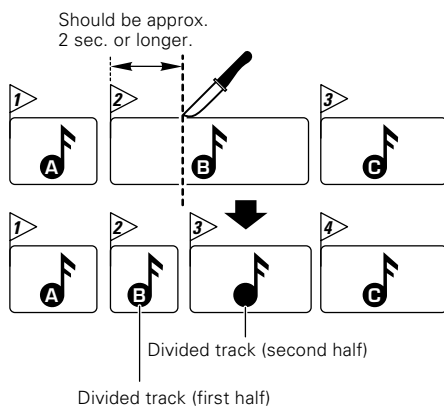
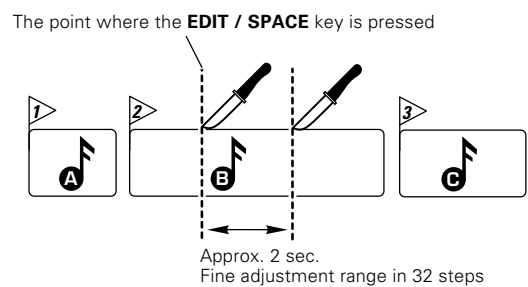

Image of preview



Use the following procedure to combine two tracks into one by deleting a track number. This operation allows to connect several tracks or a piece of music divided into several parts. After this operation, the track numbers of tracks located after the combined tracks are decreased automatically.

Preparation

- ① Play one of the MD tracks to be combined.
- ② Press the EDIT/SPACE key to switch the editing mode on.

Limitation of functionality due to MD standard

Some functions are limited due to the restrictions imposed by the MD standard. Before considering the symptoms as a sign of trouble with the unit, please read "Symptoms related to MD standard". → 51

Combining the track being played (TRACK COMBINE)

1 Select "COMBINE".

① Select "COMBINE".

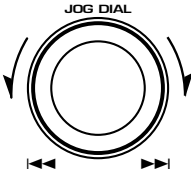

② Set the selection.



The modes are switched by rotating the JOG DIAL.

When pressed in play mode:

- ① **DIVIDE?** : Dividing a track
- ② **COMBINE?** : Combining tracks
- ③ **ERASE?** : Erasing track(s)
- ④ **MOVE?** : Moving (reordering) tracks

● Editing is aborted if no operation has been performed for 8 seconds.

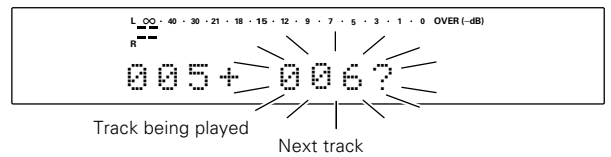
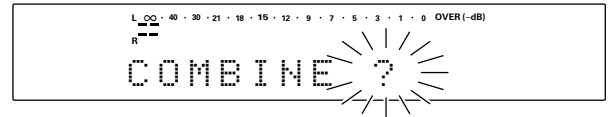

To combine the track with the next track to it, go to step 3.

- To combine two tracks during playback, press the **EDIT/SPACE** key while the first track is being played. (The track being played and the track immediately after it will be combined.)
- If the operation is started during playback, it pauses automatically.

2 Select the track to be combined.

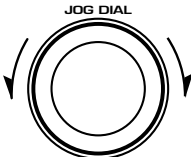

To decrease track No. ←←

→→ To increase track No.

To combine track Nos. 5 and 7 :

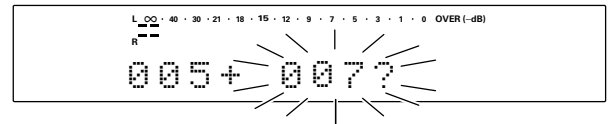

3 Set the selection.

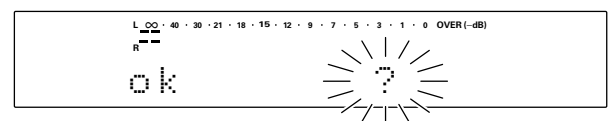
4 Execute the track combine operation.

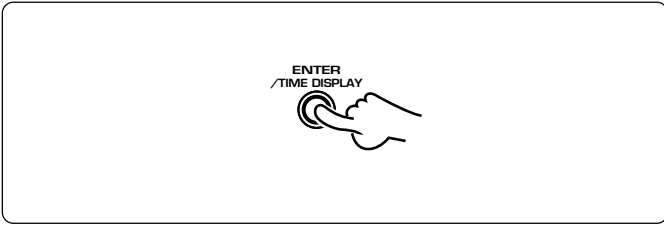

Display after execution

- “EDIT NOW!” : When editing is in progress
- “COMPLETE!” : When editing is completed successfully
- “CAN’T EDIT” : When editing is incomplete

- It takes a while until the execution completes.
- If editing has been started during playback, playback restarts automatically from the current track.
- Track combining may sometimes be impossible due to the limitations of the MD standard.
- If you execute an editing operation by mistake, the condition before editing can be recovered by performing the “EDIT CANCEL” operation. → 34

5 Eject the Mini Disc.

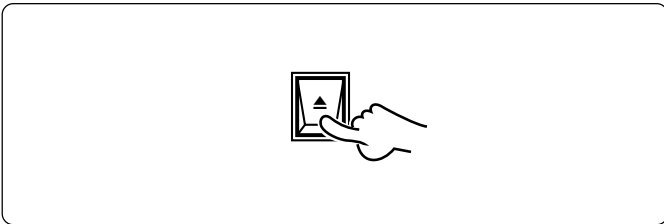

Note While “WRITING” is displayed, do not apply shock or vibration to the unit because information is being written on the Mini Disc.

Image of track combination

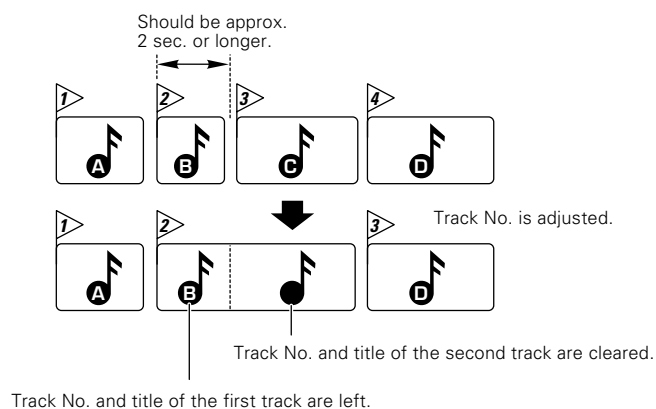

Use the following procedure to erase a single track being played.
Be careful in using this operation because a track may not be recovered once it has been erased.

Preparation

- ① Play the MD track you wish to erase.
- ② Press the EDIT/SPACE key to switch the editing mode on.

Erasing the track being played (TRACK ERASE)

1 Select "ERASE".

① Select "ERASE".

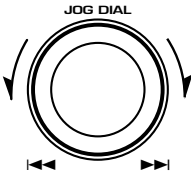

② Set the selection.



The modes are switched by rotating the JOG DIAL.

- ① **DIVIDE?** : Dividing a track
- ② **COMBINE?** : Combining tracks
- ③ **ERASE?** : Erasing track(s)
- ④ **MOVE?** : Moving (reordering) tracks

● Editing is aborted if no operation has been performed for 8 seconds.

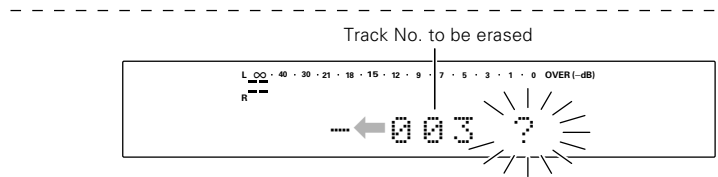
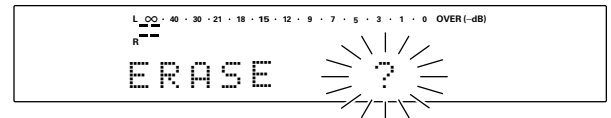

2 Confirm that the track has been erased.

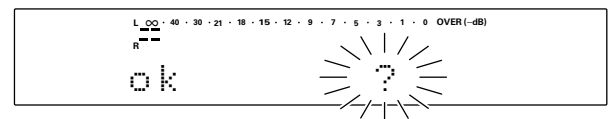
Confirm that the track has been erased.

3 Execute the track erasure operation.



Display after execution

- "EDIT NOW!" : When editing is in progress
- "COMPLETE!" : When editing is completed successfully
- "CAN'T EDIT" : When editing is incomplete

- It takes a while until the execution completes.
- The track being played is erased (together with its track title).
- If you execute an editing operation by mistake, the condition before editing can be recovered by performing the "EDIT CANCEL" operation.

4 Eject the Mini Disc.

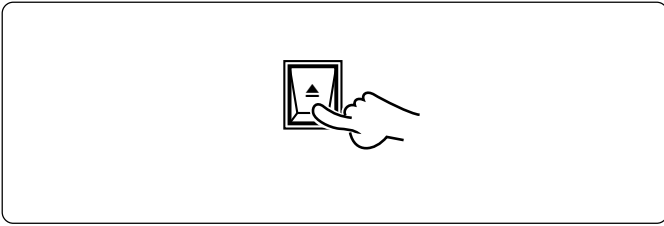

Note While "WRITING" is displayed, do not apply shock or vibration to the unit because information is being written on the Mini Disc.

Image of track erasure

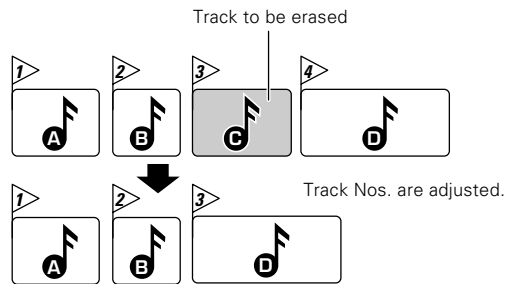

Use the following procedure to erase desired tracks in stop mode.

Be careful in using this operation because a track may not be recovered once it has been erased.

Preparation

- ❶ Put the MD recorder in stop mode.
- ❷ Press the EDIT/SPACE key to switch the editing mode on.

Erasing one or more track at a time (QUICK ERASE)

❶ Select "Q.ERASE".

❶ Select "Q.ERASE".

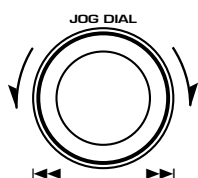

❷ Set the selection.



The modes are switched by rotating the JOG DIAL.

- ❶ Q. MOVE? : Moving (reordering) tracks
- ❷ Q.ERASE? : Erasing track(s)

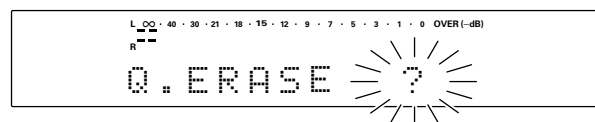

Confirmation of all track erasure

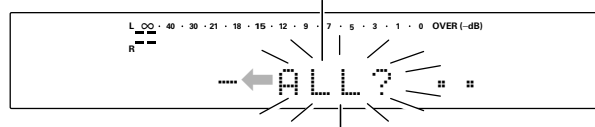

If you want to clear all tracks in a MD, go to step ❸.

❷ To erase desired tracks.

❶ Select a track number to be erased.

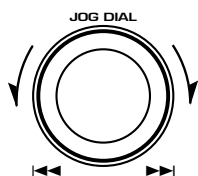

❷ Set the selection.



Erase desired tracks by repeating steps ❶ and ❷.

Selected track

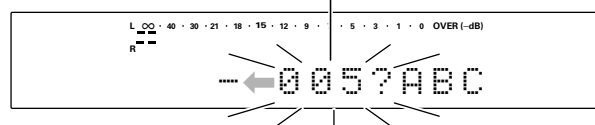

Title scrolling

- Only the last selected track can be cleared by pressing the **DELETE** key of the remote control unit. (To clear all of the selected tracks, cancel editing and restart the operation from the beginning.)
- The orders of tracks can be confirmed by pressing the **◀** key (or **▶** key) of the remote control unit.

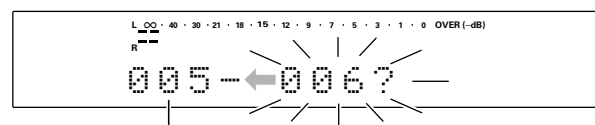

Selected track

Next track

3 End the selection of the tracks to be erased.

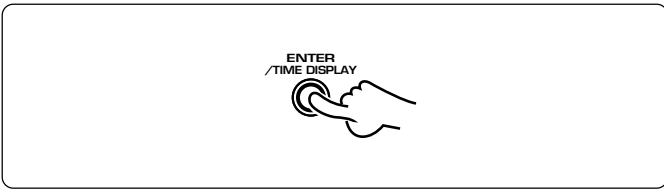

4 Execute the track erasure operation.

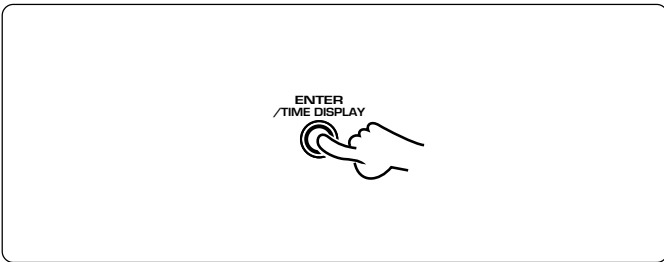

5 Eject the Mini Disc.

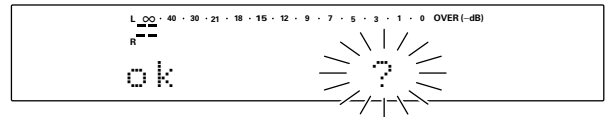
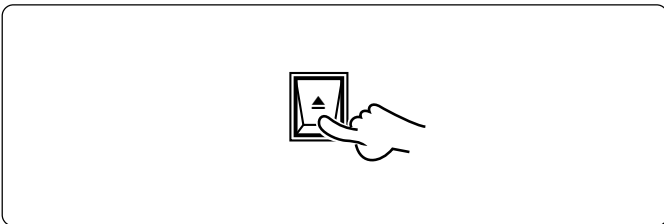

Display after execution

- “EDIT NOW!” : When editing is in progress
- “COMPLETE!” : When editing is completed successfully
- “CAN'T EDIT” : When editing is incomplete

- It takes a while until the execution completes.
- If you execute an editing operation by mistake, the condition before editing can be recovered by performing the “EDIT CANCEL” operation. → 34



Note While “WRITING” is displayed, do not apply shock or vibration to the unit because information is being written on the Mini Disc.

Image of track deleting (QUICK ERASE)

Erasing all tracks:

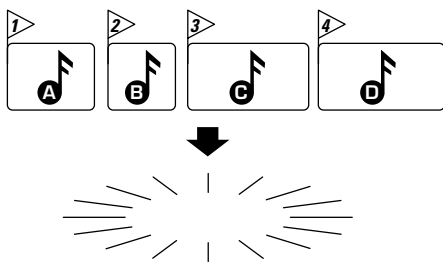

Erasing desired tracks:

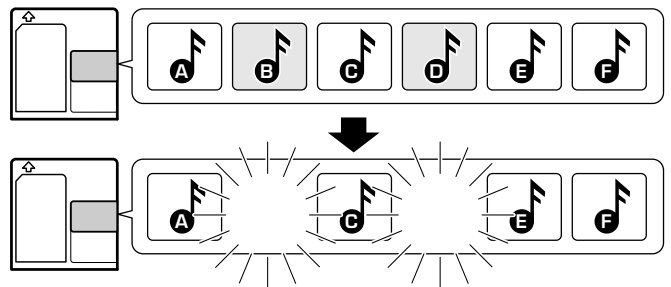

When “DISC ERROR” is displayed

If “DISC ERROR” is displayed with a Mini Disc which has been known to be normal, re-load the Mini Disc before proceeding to the ALL ERASE operation. This may makes it possible to read the Mini Disc contents.

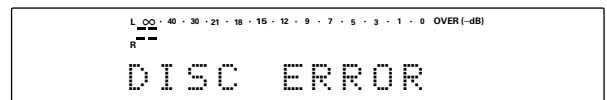

- Once the “DISC ERROR” message has been displayed, the “ALL ERASE” operation is possible but “EDIT CANCEL” operation is not possible.

When titles are assigned to a disc and its tracks, the titles cannot only be displayed during playback but title search (searching a track by the title) is also made possible. The assigned titles can be changed or deleted with the same procedure.

Preparation

- ❶ Put the MD recorder to stop, play or record mode.
- ❷ Press the TITLE INPUT key to switch the title input mode on.

About preset titles

Easy title editing is possible by memorizing titles that you often use or titles that you like at the optional preset titles. Changing preset title names to new ones and inputting those titles to the mini disc is carried out with the "Editing titles" operation.

Initial settings are as follows.

PRE1:Pops, PRE2:Rock, PRE3:Classic, PRE4:Jazz, PRE5:Disco, PRE6:Best Hits, PRE7:Air Check, PRE8:No., PRE9:Vol.

- To return a changed preset title to the initial setting, please refer to "Operation to reset".

Editing titles

1 Select the item to be edited.

Main unit

❶ Select whether the disc title or track title is input.

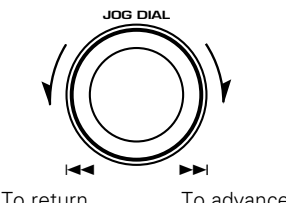

❷ Set the selection.



Remote control unit

To return To advance

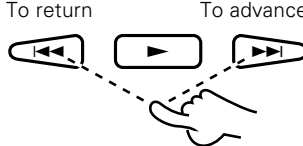

To abort operation, press the TITLE INPUT key again.

The modes are switched by rotating the JOG DIAL.

- ❶ DISC : Disc title
- ❷ 001 : Track title
- ❸ PRE 1-PRE 9 : Preset title
- ❹ ALL ERASE? : Erasing both disc and track titles

- Editing is aborted if no operation has been performed for 8 seconds.

To edit a disc title: Select "DISC".



To edit a track title: Select the desired track number.



To edit the preset titles: Select the desired preset number.

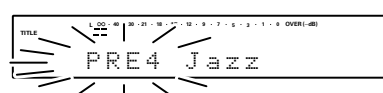

To erase both disc and track titles.



- To input a title, go to step ❷.
- To change or delete a title, go to step ❸.

Total number of title characters

Up to 1792 characters can be input per disc and up to 80 characters can be input per track. (In case of alphanumeric and symbol characters)

A space (blank character) also required the same amount of data as alphanumeric characters. When deleting a title, it is not recommended to overwrite spaces on previous characters but use the DELETE function.

Characters usable in title editing

The following alphabets and symbols (ASCII codes) can be selected for use in title editing.

- Uppercase alphabets x 26 : ABCD...WXYZ
- Lowercase alphabets x 26 : abcd...wxyz
- Numerals x 10 : 0123456789
- Space & symbols x 26 : !"#\$%&'()*+,-./:;<=>`?@^_

2 Input the title.

Main unit

1 Select a character group.



2 Select a character.

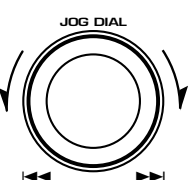

To return To advance

3 Set the selected character.



Remote control unit

1 Select a character group.



2 Select a character.

1	ABC 2	DEF 3
GHI 4	JKL 5	MNO 6
PRS 7	TUV 8	9 : ; , ? !
+100	0	+10

or



Repeat steps **1** to **3** till all of the title characters have been input.

One of the following character groups can be selected.

- A to Z and space (a blank character):
- a to z and space:
- 0 to 9, symbols, preset titles (x 9):

The characters can be switched by rotating the JOG DIAL.

- A to Z and space (a blank character):

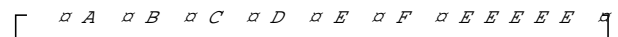

- a to z and space:

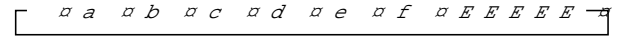

- 0 to 9, symbols, preset titles (x 9):

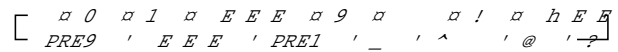

Example of new title input:

Initial display

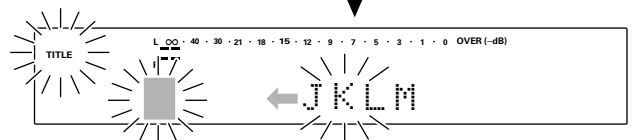
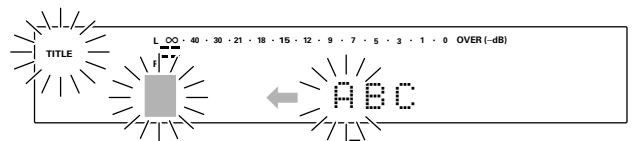

Selected character

- The display can be scrolled so that any character (in a single group) can be selected.
- Characters can also be selected directly from the remote control unit by using the numeric keys.
(Example: Each press of the **2** key switches characters in order of **A → B → C.**)
- The cursor can be moved to the left and right with the **◀** and **▶** keys.
- Pressing the **TITLE SEARCH** key during title input switches the input mode between the "overwrite mode" and "insert mode".

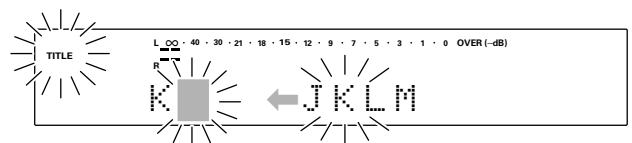

- Pressing the **EDIT/SPACE** key inserts a blank space character.

3 To change or erase a title.

Main unit

1 Move the character to the desired character (to be changed).

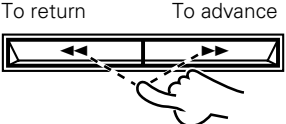

2 Select a character group.



3 Select the "overwrite mode" or "insert mode".

(Remote control unit only)



4 Select a character.

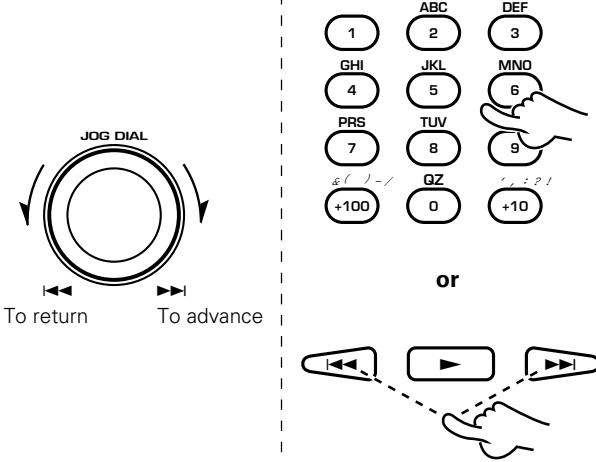

5 Set the selected character.



Remote control unit

(DMF-5020)

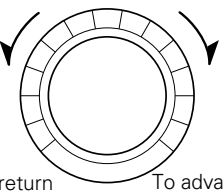

(DMF-3020/MD-203)

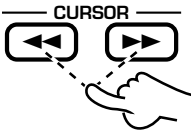

CHARA. P.MODE

All characters of a title can be changed or erased by repeating steps 1 to 5.

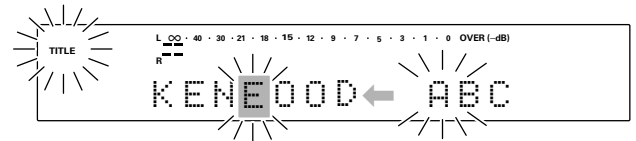

Selected character blinks.

- If the title to be changed is too long to be displayed on the display section, press the ◀◀ or ▶▶ key to scroll the display so that the characters hidden until then appear.
- Press the **DELETE** key to erase the selected character.

One of the following character groups can be selected.

- A to Z and space (a blank character):
- a to z and space:
- 0 to 9, symbols, preset titles (x 9):

- The display can be scrolled so that any character (in a single group) can be selected.

Each press switches the mode.

- ① **Overwrite mode** : Inputs a character by replacing the existing character.
- ② **Insert mode** : Inputs a character before or after an existing character.

Cursor types

- Overwrite mode** : Larger cursor "■"
- Insert mode** : Smaller cursor "▬"

Selecting the correct character (in overwrite mode):

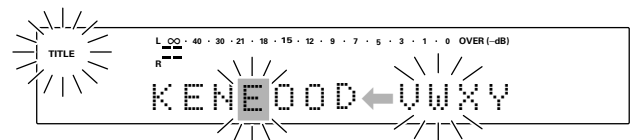

- The display can be scrolled so that any character (in a single group) can be selected.
- Characters can also be selected directly from the remote control unit by using the numeric keys.
(Example: Each press of the [2] key switches characters in order of **A → B → C.**)
- The cursor can be moved to the left and right with the ◀◀ and ▶▶ keys.

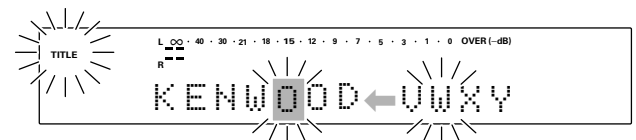

The cursor moves.

4 Execute title change or deletion.

Main unit	Remote control unit
<p>1 Enter the title in memory.</p>	
<p>2 Complete the operation.</p>	

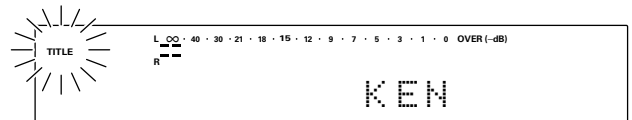
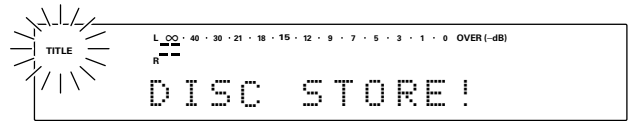

The title is scrolled automatically.

5 Eject the Mini Disc.

Main unit	Remote control unit (DMF-5020 only)



Information is being written.

Mini Disc has been ejected.

Note While "WRITING" is displayed, do not apply shock or vibration to the unit because information is being written on the Mini Disc.

Title editing function keys

CHARA. key:

Press to switch the character groups on the character display.

Manual search (◀, ▶) keys:

Press to move the cursor during title input operation.

When the cursor is (lower half only) : The input character is inserted before the character in the cursor position.

When the cursor is : The input character replaces the character in the cursor position.

DELETE key:

Press to clear (delete) the character on the cursor position and move the characters after it by one character backward. Pressing the key successively (or holding it depressed) allows to clear a title easily.

EDIT / SPACE key:

Press to enter (insert) a space (one blank character) immediately before the character in the cursor position and move the characters after it by one character forward. Multiple spaces can also be entered by pressing the key successively (or holding it depressed). The spaces are mainly used to leave spaces for later addition of characters before adding characters to a title.

Scrolling the display

There may be cases in which the amount of information is too large to be displayed at a time during the title input operation, etc. In such a case, pressing the ◀ or ▶ key repeatedly allows to move the displayed characters to the left (or right) so that other information which has been hidden can be displayed. This leftward or rightward movement of the display characters is referred to as "scrolling."

Main unit	Remote control unit (DMF-5020)
<p>Remote control unit (DMF-3020/MD-203)</p>	

Example of scrolling

Displayed area (All cannot be displayed.)

ABCDEFGHIJKLMN OPQRSTUVWXYZ

Scrolling →

ABCDEFGHIJKLMN OPQRSTUVWXYZ

← Scrolling

ABCDEFGHIJKLMN OPQRSTUVWXYZ

TIME DISPLAY key

This key allows to switch the mode of time display.

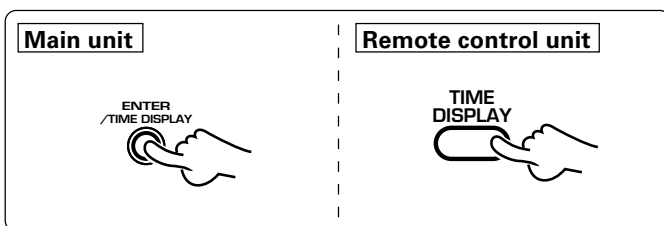

Each press switches the time display modes.

In play/stop mode

- ① **SINGLE(+)** : Elapsed time of the track being played
- ② **SINGLE(-)** : Remaining time on the track being played
- ③ **TOTAL(+)** : Total elapsed play time of tracks
- ④ **TOTAL(-)** : Total remaining play time of tracks (The total number of tracks is also displayed during stop mode.)
- ⑤ **REMAIN** : Remaining recording time of disc
- ⑥ **TITLE** : Track title display (during playback) or Mini Disc title display (during stop)

In recording mode

- ① **SINGLE(+)** : Elapsed play time of track being recorded
- ② **TOTAL(+)** : Total elapsed play time of tracks
- ③ **REMAIN** : Remaining recording time of disc

When no track has been recorded

- ① **SINGLE(+)** : "BLANK DISC" is displayed. ("NO TRACKS" is displayed if the disc has a title.)
- ② **REMAIN** : Remaining recording time of disc
- ③ **TITLE** : The Mini Disc title is displayed

METER key

The level meter display contents can be switched over in cycle.

- 1. **Normal display** : The scale around 0 dB is set finely in this mode, which is suitable for normal recording (rock) or playback (pop music).
- 2. **Wide display** : The scale is set almost evenly from 0 dB to 30 dB in this mode, which is suitable for playing music with wide level variation from pianissimo to fortissimo, such as classical music.

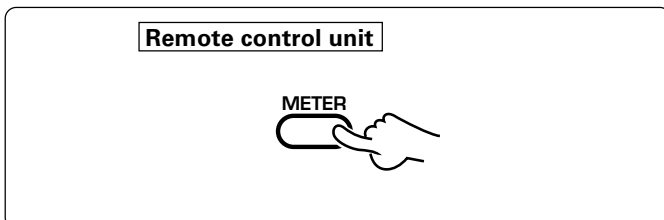

Each press switches the level meter display modes.

- ① Example of normal display:

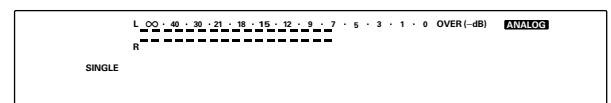

- ② Example of wide display:

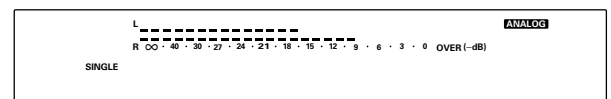

Timer operations

50

Playback or recording can also be activated at the desired time by using a commercially available timer.

Connect the power cords of the associated components so that their power can be turned ON through the audio timer. Also, be sure to read carefully the instruction manual of the timer.

Do not set timer recording in a way that the power is not turned ON for more than 3 days; otherwise, the last recorded data may be cleared.

Refer to "Memory backup". → 9

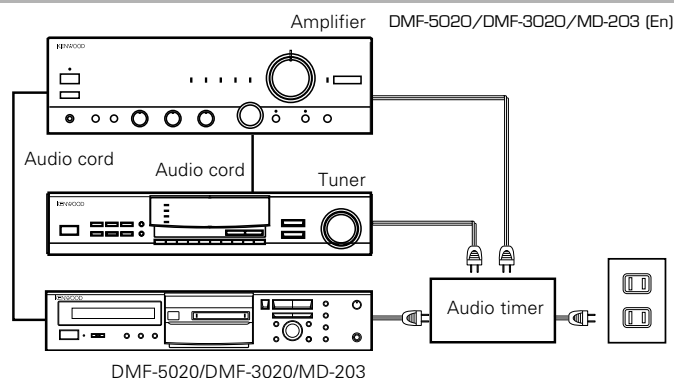

Timer playback, timer recording

1 Turn the powers of the associated components ON.

- Set the **POWER** key of the unit to ON.

2 Make preparations.

For timer playback

Load a prerecorded Mini Disc.

For timer recording

- 1 Load a recordable Mini Disc.
- 2 Receive the desired radio station.
- 3 Select the desired mode with the **REC INPUT** key. → 27
- 4 Adjust the recording level.

- For timer recording, be sure to set the write protect tab to enable recording. → 8
- For timer recording, be sure to check the remaining recording time. → 49

3 Set the amplifier volume.

For timer playback

- 1 Play the Mini Disc.
- 2 Adjust the amplifier volume.
- 3 Stop the disc.

For timer recording

Minimize the amplifier volume.

4 Set the **TIMER**.

For timer playback

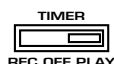

For timer recording

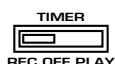

- When the set time comes, the disc playback or recording starts automatically. (Also be sure to read the instruction manual of the connected component carefully.)

5 Set the timer ON time.

For timer playback

Set the timer so that it supplies power at the specified time.

For timer recording

Set the timer so that the tuner reception can be started at the desired time of the day.

- After having set the timer, be careful not to press the **ON/STANDBY** key of the remote control unit to ON; otherwise the timer operation would be activated.

What appears to be a malfunction may not always be serious. If your unit should not perform as expected, consult the table below to see if the problem can be corrected before seeking help from your dealer or service representative.

Operation to reset

The microprocessor may fall into malfunction (impossibility to operate erroneous display, etc.) when the power cord is unplugged while power is ON or due to an external factor. In this case, execute the following procedure to reset the microprocessor and return it to normal condition.

With the POWER key left to ON, unplug the power cord from the power outlet then, while holding the eject (▲) key depressed, plug the power cord again.







- Please note that resetting the microprocessor clears the contents stored in, it returns the microprocessor to the condition when it left the factory.

Symptoms related to MD standard

Symptom	Cause
"DISC FULL" is displayed while the disc still has a remaining recordable time.	<ul style="list-style-type: none"> ● More than 255 tracks (track No. 256 or more) cannot be recorded. (There may be also cases in which recording is impossible while the track number is less than 256.) In such a case, the REMAIN time display shows "0:00".
The recordable time does not increase after a short track has been erased.	<ul style="list-style-type: none"> ● The remaining time display becomes "0:00" when the actual total remaining time of the Mini Disc is less than 12 seconds. The recordable time display changes when the total time of the erased track exceeds 12 seconds. ● When a Mini Disc has been subjected to repeated editing, the remaining time may not increase even after a short track has been erased.
Tracks cannot be combined.	<ul style="list-style-type: none"> ● A track created as a result of an editing operation may sometimes be impossible to be combined with another track.
The total of the recorded time and recordable time does not coincide with the total recording time of the MD (60 or 74 min.).	<ul style="list-style-type: none"> ● As recording is performed on a minimum recording basis of 2 seconds, the displayed time may not coincide with the consumed disc capacity.
Sound is interrupted when a track created by editing is subjected to fast forward or fast backward operation.	<ul style="list-style-type: none"> ● Sound interruption may occur due to a combination of various factors, and it is not a malfunction.
Tracks are not numbered correctly.	<ul style="list-style-type: none"> ● A short track may be created depending on the contents of the recorded source (CD, for example).
The period in which "READING" is displayed is abnormally long.	<ul style="list-style-type: none"> ● "READING" is displayed for a longer period than usual when a brand-new recordable Mini Disc (a virgin disc) is loaded. ● The Mini Disc in use has been processed with repeated editing or contains a large number of tracks.
The total number of characters used in the titles is less than 1792 characters.	<ul style="list-style-type: none"> ● As the title recording areas are used on a per-7-character basis, the total number of input characters may be less than 1792.

Displayed messages and actions to be taken against them

52

Displayed Message	Meaning	Action
NO DISC	<ul style="list-style-type: none"> ● This unit is not loaded with disc. 	<ul style="list-style-type: none"> ● Load a disc.
UNLOCK	<ul style="list-style-type: none"> ● The digital cord or optical fiber cable is not locked in position or connected incompletely (or not connected). 	<ul style="list-style-type: none"> ● The digital cord or optical fiber cable is not locked in position or connected incompletely (or not connected). →  10
SCMS ON	<ul style="list-style-type: none"> ● An attempt is made to record digital signal from a source while its digital copy has been prohibited by SCMS. 	<ul style="list-style-type: none"> ● Use analog recording. →  27
NotAudio	<ul style="list-style-type: none"> ● The digital signal being input is not an audio signal. 	<ul style="list-style-type: none"> ● Use analog recording. →  27
DISC FULL	<ul style="list-style-type: none"> ● There is no recordable area on the disc. ● An attempt is made to record a 256th track. 	<ul style="list-style-type: none"> ● Use another recordable disc. ● More than 255 tracks cannot be recorded per disc.
TITLE FULL	<ul style="list-style-type: none"> ● An attempt is made to assign a title with more characters than usable. 	<ul style="list-style-type: none"> ● Refer to "Total number of title characters". →  45
BLANK DISC	<ul style="list-style-type: none"> ● The disc does not contain any recordings. 	<ul style="list-style-type: none"> ● When playback is required, use a recorded disc.
NO TRACKS	<ul style="list-style-type: none"> ● The disc does not contain any tracks but has a disc title. 	<ul style="list-style-type: none"> ● The disc can be used for recording without any problem.
READING	<ul style="list-style-type: none"> ● The TOC*1 data of the disc is being read. 	<ul style="list-style-type: none"> ● This is a normal operation.
WRITING	<ul style="list-style-type: none"> ● The data related to editing or recording is being written in the disc. 	<ul style="list-style-type: none"> ● This is a normal operation.
DISC ERROR	<ul style="list-style-type: none"> ● The contents of UTOC*2 are abnormal. 	<ul style="list-style-type: none"> ● Erase all tracks by executing "←ALL". If this is not possible, use another Mini Disc. →  43
EDIT NOW!	<ul style="list-style-type: none"> ● The editing operation is in progress. 	<ul style="list-style-type: none"> ● This is a normal operation.
CAN'T EDIT	<ul style="list-style-type: none"> ● An attempt is made to perform editing beyond the restrictions, for example to erase a track which is too short. 	<ul style="list-style-type: none"> ● Perform editing following the restrictions.
ok? (blinking)	<ul style="list-style-type: none"> ● This is a message for confirming if editing can really be executed. 	<ul style="list-style-type: none"> ● Press the ENTER key to execute editing.
PROTECTED	<ul style="list-style-type: none"> ● The Mini Disc is in the "WRITE PROTECT" condition. 	<ul style="list-style-type: none"> ● Release the "WRITE PROTECT" condition. →  8
PLAY ONLY	<ul style="list-style-type: none"> ● A playback-only Mini Disc is loaded. 	<ul style="list-style-type: none"> ● Load a recordable Mini Disc.

Other symptoms

Symptom	Cause	Remedy
Sound is not output even when the play key is pressed.	<ul style="list-style-type: none"> ● The cords are connected erroneously. ● No disc has been loaded. ● A non-recorded disc has been loaded. ● Output level is low. 	<ul style="list-style-type: none"> ● Connect the cords in accordance with "System connections". → 10 ● Load a disc. ● Load a prerecorded disc or playback-only disc. ● Adjust with the OUTPUT LEVEL keys. → 12
Recording is not possible	<ul style="list-style-type: none"> ● The disc is write-protected. ● An attempt is made to record digital signal from a source while its digital copy has been prohibited by SCMS. ● The recording level is too low (in case of analog recording). ● A playback-only disc has been loaded. ● The disc does not have a recordable area. ● The REC INPUT key is not set to the actual input source. ● If the amplifier is connected to this unit through a system control cord, the amplifier's input selector is set to the MD input. 	<ul style="list-style-type: none"> ● Change the position of the write protect tab to the write position or use a recordable disc. → 8 ● Use analog recording. → 27 ● Adjust the recording level again. → 28 ● Use a recordable disc. ● Use another disc. ● Set it according to the actual input source. → 27 → 29 ● Set the amplifier's input selector to other position than MD.
Sound is distorted.	<ul style="list-style-type: none"> ● The recording level has not been adjusted. ● A disc in which distorted sound has been recorded is played. 	<ul style="list-style-type: none"> ● Adjust the recording level. → 28 ● Use another disc.
Noise is noticeable.	<ul style="list-style-type: none"> ● An external noise is induced. 	<ul style="list-style-type: none"> ● Install the unit at a position apart from an electric appliance or TV set.
Power cannot be turned on from the remote control.	<ul style="list-style-type: none"> ● The POWER key is set to OFF. 	<ul style="list-style-type: none"> ● Set the POWER key to on (STANDBY).

 **TOC^{*1}** : All minidisks contain a Table of Contents (TOC) in addition to sound signals. The TOC is similar to the table of contents in a book and contains information, such as track numbers, track length, and character information, that cannot be rewritten. → [52](#)

UTOC^{*2}: In addition to the TOC, minidisks also contain a special User's Table of Contents (UTOC) that contains track number, track length, and character information, that can be rewritten. → [52](#)

DMF-5020

[Format]

System Minidisc digital audio system
Laser Semiconductor laser
Recording method Field modulation overwrite method
Audio compression . ATRAC (Adaptive TRansform Acoustic Coding)
Playing rotation Approx. 400 rpm ~ 900 rpm (CLV)

[D/A conversion]

D/A conversion 1 Bit (24 Bit D.R.I.V.E. conversion)
Oversampling 8 fs (352.8 kHz)

[A/D converter]

A/D converter 5 th order sigma-delta conversion
Sampling frequency 44.1 kHz

[Digital audio performance]

Frequency response (playback mode) ... 8 Hz ~ 20 kHz (± 1 dB)
Signal to noise ratio (playback mode) More than 105 dB
Dynamic range (playback mode) More than 94 dB
Total harmonic distortion (1 kHz, playback mode) .. Less than 0.007 %
Wow & flutter Less than unmeasurable limit
Analog input sensitivity / input impedance . 500 mV / 22 k Ω or more
Analog output level / output impedance 2.0 V / Less than 400 Ω
Headphone output 20 mW/32 Ω load
Digital input
Coxaial 0.5 Vp-p / 75 Ω
Optical(Wave length 660 nm) - 15 dBm ~ - 21 dBm
Digital output
Coxaial 0.5 Vp-p / 75 Ω
Optical(Wave length 660 nm) - 15 dBm ~ - 21 dBm

[General]

Power consumption 18 W
Dimensions W : 440 mm (17 - 5 / 16")
..... H : 94 mm (3 - 11 / 16")
..... D : 379 mm (14 - 15 / 16")
Weight (Net) 4.0 kg (8.8 lb)

DMF-3020/MD-203

[Format]

System Minidisc digital audio system
Laser Semiconductor laser
Recording method Field modulation overwrite method
Audio compression . ATRAC (Adaptive TRansform Acoustic Coding)
Playing rotation Approx. 400 rpm ~ 900 rpm (CLV)

[D/A conversion]

D/A conversion 1 Bit
Oversampling 8 fs (352.8 kHz)

[A/D converter]

A/D converter 5 th order sigma-delta conversion
Sampling frequency 44.1 kHz

[Digital audio performance]

Frequency response (playback mode) ... 8 Hz ~ 20 kHz (± 1 dB)
Signal to noise ratio (playback mode) More than 100 dB
Dynamic range (playback mode) More than 90 dB
Total harmonic distortion (1 kHz, playback mode) Less than 0.01 %
Wow & flutter Less than unmeasurable limit
Analog input sensitivity / input impedance . 500 mV / 22 k Ω or more
Analog output level / output impedance 2.0 V / Less than 400 Ω
Headphone output 20 mW/32 Ω load
Digital input
Coxaial 0.5 Vp-p / 75 Ω
Optical(Wave length 660 nm) - 15 dBm ~ - 21 dBm
Digital output
Coxaial 0.5 Vp-p / 75 Ω
Optical(Wave length 660 nm) - 15 dBm ~ - 21 dBm

[General]

Power consumption 18 W
Dimensions W : 440 mm (17 - 5 / 16")
..... H : 94 mm (3 - 11 / 16")
..... D : 379 mm (14 - 15 / 16")
Weight (Net) 4.0 kg (8.8 lb)



1. KENWOOD follows a policy of continuous advancements in development. For this reason specifications may be changed without notice.
2. The full performance may not be exhibited in an extremely cold location (under a water-freezing temperature).

For the U.S.A.
FCC WARNING

This equipment may generate or use radio frequency energy. Changes or modifications to this equipment may cause harmful interference unless the modifications are expressly approved in the instruction manual. The user could lose the authority to operate this equipment if an unauthorized change or modification is made.

NOTE:

This equipment has been tested and found to comply with the limits for a Class B digital device, pursuant to Part 15 of the FCC Rules. These limits are designed to provide reasonable protection against harmful interference in a residential installation. This equipment may cause harmful interference to radio communications, if it is not installed and used in accordance with the instructions. However, there is no guarantee that interference will not occur in a particular installation. If this equipment does cause harmful interference to radio or television reception, which can be determined by turning the equipment off and on, the user is encouraged to try to correct the interference by one or more of the following measures:

- Reorient or relocate the receiving antenna.
- Increase the separation between the equipment and receiver.
- Connect the equipment into an outlet on a circuit different from that to which the receiver is connected.
- Consult the dealer or an experienced radio/TV technician for help.

For the U.S.A.

CAUTION :

Use of controls or adjustment or performance of procedures other than those specified herein may result in hazardous radiation exposure.

In compliance with Federal Regulations, following are reproductions of labels on, or inside the product relating to laser product safety.

**KENWOOD CORPORATION
 2967-3, ISHIKAWA-CHO, HACHIOJI-SHI,
 TOKYO, JAPAN**

**KENWOOD CORP. CERTIFIES THIS EQUIPMENT
 CONFORMS TO DHHS REGULATIONS NO. 21
 CFR 1040.10, CHAPTER 1, SUBCHAPTER J.**

Location: Back Panel

KENWOOD

For your records

Record the serial number, found on the back of the unit, in the spaces designated on the warranty card, and in the space provided below. Refer to the model and serial numbers whenever you call upon your dealer for information or service on this product.

Model _____ Serial Number _____

Free Manuals Download Website

<http://myh66.com>

<http://usermanuals.us>

<http://www.somanuals.com>

<http://www.4manuals.cc>

<http://www.manual-lib.com>

<http://www.404manual.com>

<http://www.luxmanual.com>

<http://aubethermostatmanual.com>

Golf course search by state

<http://golfingnear.com>

Email search by domain

<http://emailbydomain.com>

Auto manuals search

<http://auto.somanuals.com>

TV manuals search

<http://tv.somanuals.com>