

KENWOOD

MICRO HI-FI COMPONENT SYSTEM

HM-333

INSTRUCTION MANUAL

KENWOOD CORPORATION



2 Before applying power

⚠ Caution : Read this page carefully to ensure safe operation.

Units are designed for operation as follows.

U.S.A. and Canada AC 120 V only
Australia AC 240 V only
Europe and U.K. AC 230 V only

***Other countries**

..... AC 110-120 / 220-240 V switchable

For the United Kingdom

Factory fitted moulded mains plug

1. The mains plug contains a fuse. For replacement, use only a 13-Amp ASTA-approved (BS1362) fuse.
2. The fuse cover must be refitted when replacing the fuse in the moulded plug.
3. Do not cut off the mains plug from this equipment. If the plug fitted is not suitable for the power points in your home or the cable is too short to reach a power point, then obtain an appropriate safety approved extension lead or adapter, or consult your dealer. If nonetheless the mains plug is cut off, remove the fuse and dispose of the plug immediately, to avoid a possible shock hazard by inadvertent connection to the mains supply.

IMPORTANT : The wires in the mains lead are coloured in accordance with the following code:

Blue : Neutral
Brown : Live

Do not connect those leads to the earth terminal of a three-pin plug.

* AC voltage selection

The AC voltage selector switches on the rear panel are set to the voltage that prevails in the area to which the unit is shipped. Before connecting the power cord to your AC outlet, make sure that the setting positions of these switches match your line voltage. If not, they must be set to your voltage in accordance with the following direction.

AC voltage selector switches

Move switch lever to match your line voltage with a small screwdriver or other pointed tool.

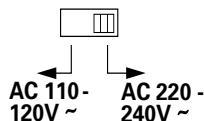

Note:

Our warranty does not cover damage caused by excessive line voltage due to improper setting of the AC voltage selector switch.

Safety precautions

WARNING : TO PREVENT FIRE OR ELECTRIC SHOCK, DO NOT EXPOSE THIS APPLIANCE TO RAIN OR MOISTURE.



CAUTION
RISK OF ELECTRIC SHOCK
DO NOT OPEN



CAUTION: TO REDUCE THE RISK OF ELECTRIC SHOCK, DO NOT REMOVE COVER (OR BACK). NO USER-SERVICEABLE PARTS INSIDE. REFER SERVICING TO QUALIFIED SERVICE PERSONNEL.



THE LIGHTNING FLASH WITH ARROWHEAD SYMBOL, WITHIN AN EQUILATERAL TRIANGLE, IS INTENDED TO ALERT THE USER TO THE PRESENCE OF UNINSULATED "DANGEROUS VOLTAGE" WITHIN THE PRODUCT'S ENCLOSURE THAT MAY BE OF SUFFICIENT MAGNITUDE TO CONSTITUTE A RISK OF ELECTRIC SHOCK TO PERSONS.



THE EXCLAMATION POINT WITHIN AN EQUILATERAL TRIANGLE IS INTENDED TO ALERT THE USER TO THE PRESENCE OF IMPORTANT OPERATING AND MAINTENANCE (SERVICING) INSTRUCTIONS IN THE LITERATURE ACCOMPANYING THE APPLIANCE.

The marking of products using lasers (Except for some areas)

**CLASS 1
LASER PRODUCT**

CAUTION
INVISIBLE LASER RADIATION
WHEN OPEN. AVOID EXPOSURE
TO BEAM.

The marking is located on the rear panel and says this product has been classified as Class 1. It means that there is no danger of hazardous radiation outside the product

Inside this laser product, a laser diode(s) exceeding Class 1 laser radiation is/are contained as alerted by the internal caution label shown above. To avoid exposure to laser beams, do not open the cover.

Special features

CD text information display

When discs conforming to CD-TEXT are played with this unit, the text information recorded on the CD (disc name or titles) is displayed automatically.

Some CDs conforming to CD-TEXT may not display text information.

Up to 1000 letters may be displayed. If the CD exceeds 1000 letters, "TEXT FULL" will be displayed.

Convenient recording features

Versatile recording features are provided, allowing the user to select desired one for each purpose.

- **One-touch recording :**

Pressing a single key starts recording of all tracks or a single track in a CD.

- **Program recording :**

Your favorite tracks can be recorded in any desired order.

Versatile timer features

- **O.T.T. (Operate easy To use Timer) :**

This timer setting is executed only for an hour (and for once) when the set start time comes.

- **Timer playback, timer recording :**

Two timer programs (PROG.1, PROG.2) are available for timer playback (AI timer playback) or timer recording. (With the AI timer playback, the playback volume increases gradually after the start of timer playback.)

- **Sleep timer :**

This timer turns the unit off automatically when the set time has elapsed. It is convenient for example for falling asleep while listening to music in the night time, etc.

In regard to demonstration

This unit is equipped with a demonstration function (only display). The demonstration consists of sequential change of display and indicators showing the operations, but the audio itself does not change. The demonstration function can be cancelled as follows.

"DEMO OFF" (To cancel demonstration):

Press the **set/demo** key during demonstration.

set / demo



"DEMO ON" (To execute demonstration):

After turning power ON, press and hold the **set/demo** key (for more than 2 seconds).

- This operates automatically when a power failure has occurred or the plug of the power cable has been pulled while the power was ON.

Unpacking

Unpack the unit carefully and make sure that all the accessories are present.

If any accessories are missing, or if the unit is damaged or fails to operate, notify your dealer immediately. If the unit was shipped to you directly, notify your shipper immediately. Kenwood recommends that you retain the original carton and packing materials in case you need to move or ship the unit in the future.

Keep this manual handy for future reference.

Accessories

Please confirm that the following accessories are present.

AM loop antenna (1)

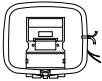

FM indoor antenna (1)



Remote control unit (1)

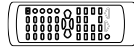

Batteries (R6/AA) (2)



AC plug adaptor (1)

Use to adapt the plug on the power cord to the shape of the wall outlet. (Accessory only for regions where use is necessary.)



For the U.S.A.

FCC WARNING

This equipment may generate or use radio frequency energy. Changes or modifications to this equipment may cause harmful interference unless the modifications are expressly approved in the instruction manual. The user could lose the authority to operate this equipment if an unauthorized change or modification is made.

NOTE:

This equipment has been tested and found to comply with the limits for a Class B digital device, pursuant to Part 15 of the FCC Rules. These limits are designed to provide reasonable protection against harmful interference in a residential installation. This equipment may cause harmful interference to radio communications, if it is not installed and used in accordance with the instructions. However, there is no guarantee that interference will not occur in a particular installation. If this equipment does cause harmful interference to radio or television reception, which can be determined by turning the equipment off and on, the user is encouraged to try to correct the interference by one or more of the following measures:

- Reorient or relocate the receiving antenna.
- Increase the separation between the equipment and receiver.
- Connect the equipment into an outlet on a circuit different from that to which the receiver is connected.
- Consult the dealer or an experienced radio / TV technician for help.

For the U.S.A.

CAUTION:

Use of controls or adjustments or performance of procedures other than those specified herein may result in hazardous radiation exposure.

In compliance with Federal Regulations, following are reproductions of labels on, or inside the product relating to laser product safety.

KENWOOD CORPORATION

2967-3, ISHIKAWA-CHO,

HACHIOJI-SHI,

TOKYO, JAPAN



**KENWOOD CORP. CERTIFIES THIS EQUIPMENT
CONFORMS TO DHHS REGULATIONS NO. 21
CFR
1040.10, CHAPTER 1, SUBCHAPTER J.**

Location: Back Panel

Contents

Caution : Read the pages marked  carefully to ensure safe operation.

Preparation section

 Before applying power	2
 Safety precautions	2
Special features	3
System connection	6
Connection of the System Accessories	6
Connection of Other Accessories (Commercially Available Parts)	8
Controls and indicators	9
Display	9
Main unit	10
Operation of remote control unit	12

Basic section

Basic use method	14
Playback of CD	16
Playback of tape	20
Receiving broadcast station	22
Collective presetting of stations	23
Channel space setting	23
Tuning a non-preset radio station (Auto tuning, Manual tuning)	24
One-by-one presetting (Manual preset)	24
R.D.S. (Radio Data System)	25
Searching for a desired program type (PTY search)	26
Recording on TAPE	28

Application section

Various CD playback features	31
Listening to the desired sequence (program playback) ..	31
Repeated playback	33
Playing tracks in a random order (random playback)	34
Convenient recording methods	35
One-touch edit recording (CD → TAPE)	36
Program recording (CD → TAPE)	37
Listening to an AUX input source	38
Clock adjustment	40
Timer operation	41
Sleep timer (SLEEP)	41
Setting the O.T.T. timer	42
Setting an everyday timer program (PROG. TIMER)	44

Knowledge sections

Important Items	47
Maintenance	47
Reference	47
In case of difficulty	49
Specifications	52

Connection of the System Accessories

This figure shows the method of connection between the main unit and provided accessories.

CAUTION Note on Connection

Connect the components as shown in the diagram.
Only plug the power cord into a power outlet once connections are completed.

Installation of speakers and positioning of TV

1. If a speaker is installed near a TV, color irregularities may be observed on the TV screen. To avoid this, install the speakers apart from a TV.
2. Color irregularities on the TV screen may also be produced depending on the method how the speakers are installed. When color irregularities are observed after the speaker installation, first turn the TV off, wait for 15 to 30 minutes and turn it on again: The interference may be improved by the self-demagnetizing function of the TV. If the color irregularities still remain, install the speakers more apart from the TV.
3. Due to induction by the electromagnetic waves produced by a TV, the speakers may produce sound even when the stereo unit is turned off. In this case also, install the speakers more apart from the TV.

CAUTION (For the U.S.A. and Canada)

Be sure to adhere followings. Or proper ventilation will be blocked causing damage or fire hazard.

- Do not place any objects impairing heat radiation onto the top of unit.

CAUTION (For other countries)

Be sure to adhere followings. Or proper ventilation will be blocked causing damage or fire hazard.

- Do not place any objects impairing heat radiation onto the top of unit.
- Leave a space around the unit (from the largest outside dimension including projection) equal or greater than, shown below.

Top panel : 50 cm

Back panel : 10 cm

AM loop antenna

The supplied antenna is for indoor use. Place it as far as possible from the main system, TV set, speaker cords and power cord, and set it to a direction which provides the best reception.

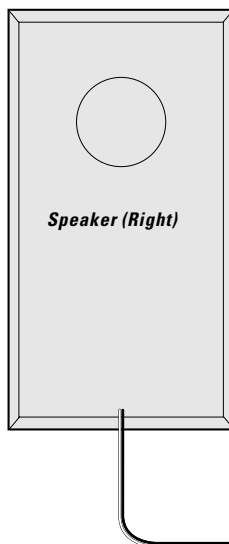
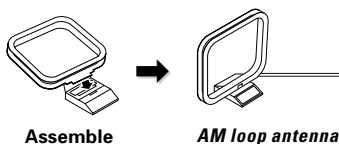

- Never short-circuit the "+" and "-" speaker cords.
- If the "+" and "-" polarity are inverted, the sound will be unnatural with unclear positioning of musical instruments, etc.
- Be sure to insert all connection cords securely. If their connections are imperfect, the sound may not be produced or noise may interfere.
- Before plugging or unplugging a connection cord, be sure to unplug the power cord from the wall AC outlet. If connection cords are plugged or unplugged with the power cord left plugged in, malfunction or damage may result.

Malfunction of microcomputer

If operation is not possible or erroneous display appears even though all connections have been made properly, reset the microcomputer referring to "In case of difficulty". - 49

FM indoor antenna

The accessory antenna is for temporary indoor use only. For stable signal reception we recommend using an outdoor antenna. Remove the indoor antenna if you connect one outdoors.

- ❶ Connect the antenna to the antenna terminal.
- ❷ Locate the position providing good reception condition.
- ❸ Fix the antenna.

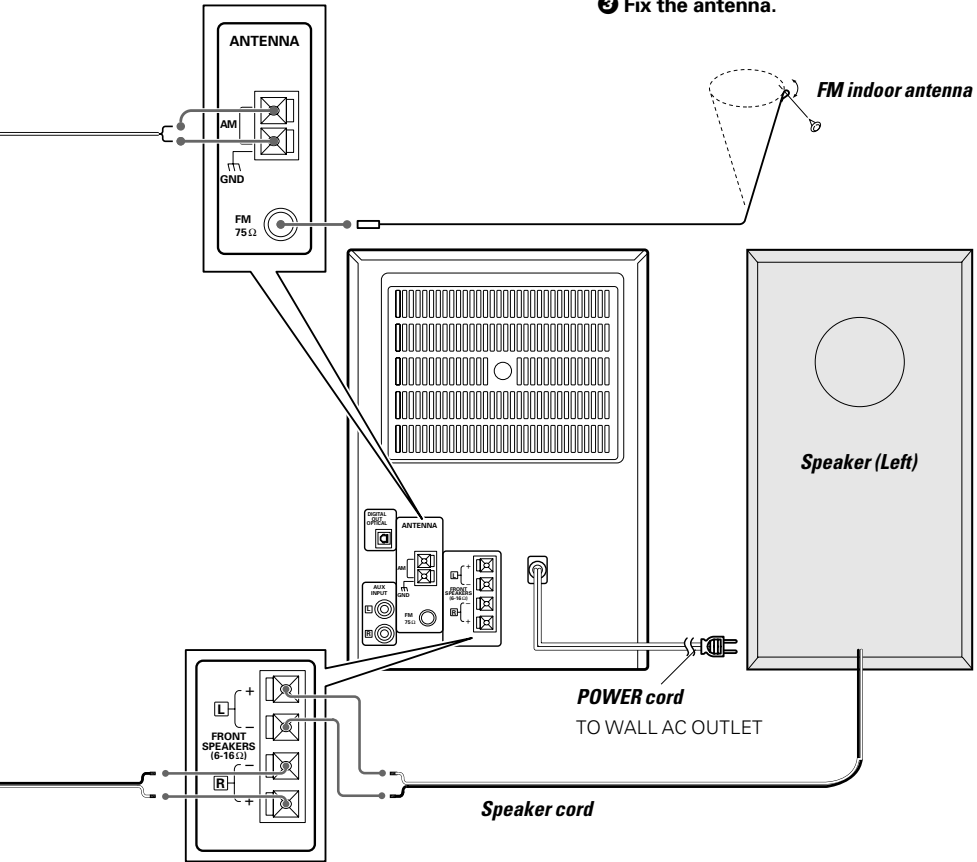

Preparation section

How to connect speaker cords to the main unit

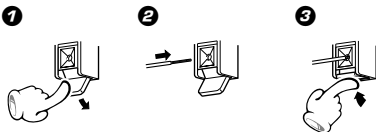

How to connect AM antenna cord to the main unit

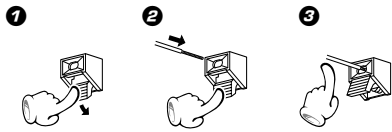

Connection of Other Accessories (Commercially Available Parts)

CAUTION Note on Connection

Connect the components as shown in the diagram. Only plug the power cord into a power outlet once connections are completed.

FM outdoor antenna

Lead the 75Ω coaxial cable connected to the FM outdoor antenna into the room and connect it to the FM 75Ω terminal. Please remove the indoor antenna after an outdoor antenna has been installed.

*DIGITAL OUT jack (OPTICAL)

The DIGITAL OUT jack (OPTICAL) outputs the CD signal.

The CD signal can be recorded in digital format by connecting a recorder to the DIGITAL IN jack (OPTICAL).

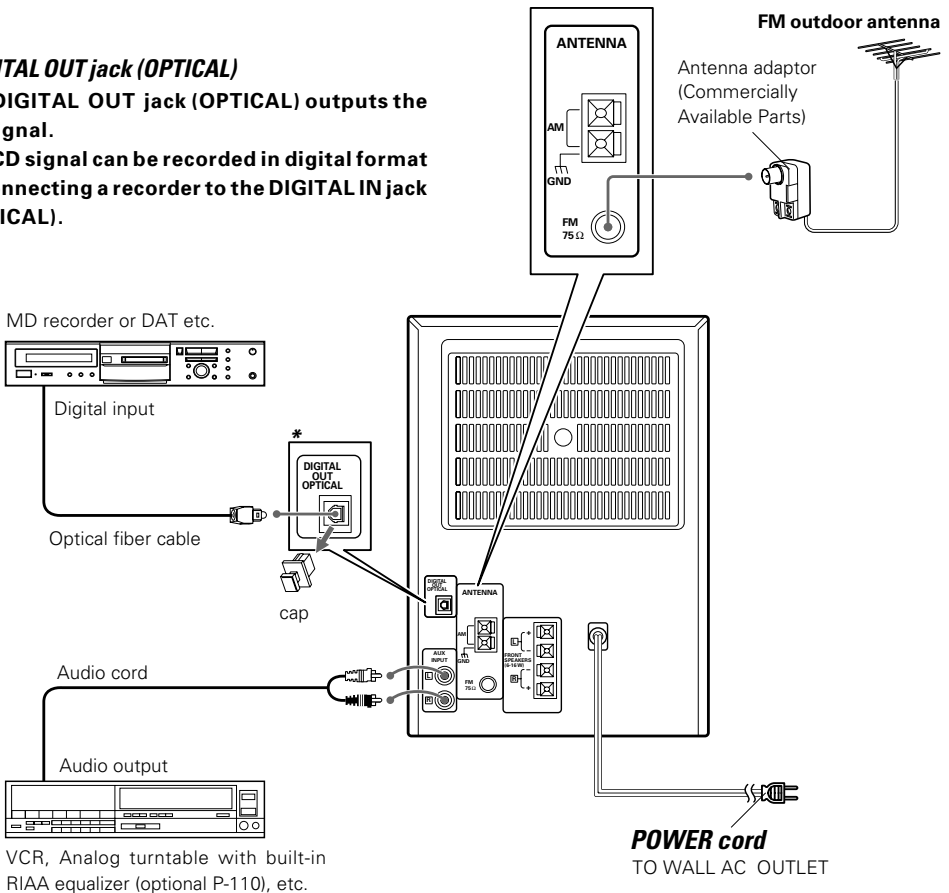

- In case an associated system component is connected, also read the instruction manual of the component.
- Be sure to insert all connection cords securely. If their connections are imperfect, the sound may not be produced or noise may interfere.
- Before plugging or unplugging a connection cord, be sure to unplug the power cord from the wall AC outlet. If connection cords are plugged or unplugged with the power cord left plugged in, malfunction or damage may result.

Display

The displays given in this manual are approximations only. They may differ from what actually appears on the display.

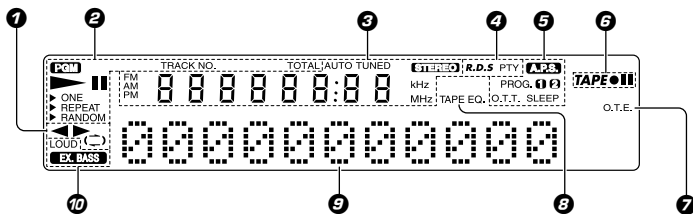

- ① Tape-related indicators
- ② CD-related indicators
- ③ Character information display/tuner-related indicators
- ④ RDS-related indicators (For Europe and U.K.)
- ⑤ Timer-related indicators
- ⑥ Tape record/record-pause indicators
- ⑦ O.T.E. (One-Touch Edit) indicator
- ⑧ TAPE EQ. indicator
- ⑨ Character information display (Dot display)
- ⑩ EX.BASS indicator, LOUD indicator

AUTO POWER SAVE function

When the unit is ON and the unit is left for 30 minutes with CD and TAPE not operating, the unit is switched off automatically by this function. This is convenient when you forgot to switch off the unit. This function can be activated or deactivated by the following operation.

① Select "A.P.S. SET?".

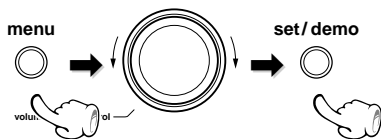

(Press the set/demo key while the "?" mark is blinking.)

② Select "A.P.S. ON" or "A.P.S. OFF".

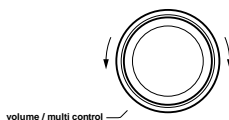

③ Set it.



- When the TUNER or AUX input is selected, APS operates only when the volume is set to zero or when MUTE is on.

Main unit

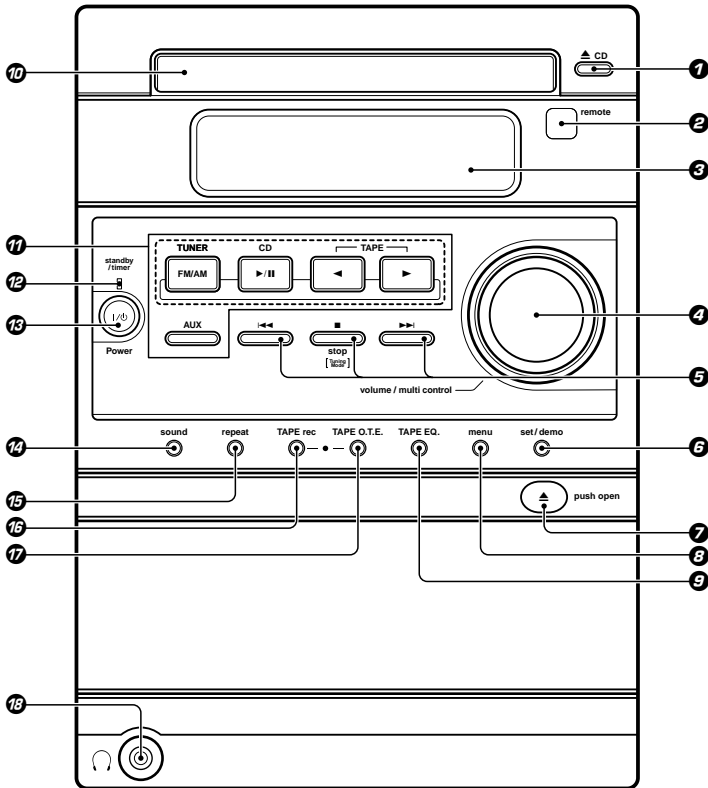

1 ▲ CD key

Press to open or close the CD tray.

— 16

2 Remote sensor

— 13

3 Display panel

* 4 volume/multi control knob

Normally, this is used for volume adjustment.

— 11 — 14

5 ◀◀ and ▶▶ keys

CD :

Used to skip CD tracks.

— 17

TAPE :

Used to fast forward or rewind tape.

— 21

TUNER :

Used to receive a preset radio station.

— 22

■ stop / Tuning Mode key

CD, TAPE :

Press to stop a disc or tape operation.

— 17 — 21

TUNER :

Press to switch between the AUTO (auto tuning, stereo reception) and MONO (manual tuning, manual reception) modes.

— 24

On standby mode:

Press to display the clock.

— 40

6 set/demo key

Press to set or enter an item selected with the **volume/multi control knob**.

This key is also used for switching demonstration on/off.

— 3

About the one-touch operation function

This unit incorporates the one-touch operation function for the user's convenience.

With this function, pressing any key enclosed in while the unit is in standby mode immediately start playback (or reception).

7 Cassette holder 

To load or eject a cassette tape, press the area marked **▲ push open** on the cassette holder to open it.

8 menu key  

Press to switch the function of the **volume/multi control knob** to the menu select mode.

This key is also used when setting the time of the day.

9 TAPE EQ. key 

Press to turn the tape equalizer on.

10 CD tray 

Press the **▲ CD** key to open or close CD tray.

11 Basic operation keys**TUNER FM/AM key** 

Press to select the TUNER input.

This key is also used to select the received broadcast band.

CD ►/II key 

Press to select the CD input and start playback. Pressing this key during CD playback initiates pause.

TAPE ◀▶ keys 

Press to select the TAPE (cassette deck) input and start playback of a tape. Pressing this key during tape playback switches the tape transport direction.

AUX key 

Press to reproduce the external source component connected to the AUX (analog auxiliary input) jacks.

Pressing this key while the unit is off turns it on at the same time as selecting the AUX input.

12 standby/timer indicator

Lights up when the unit is set to the Standby mode of power.

Red : Ordinary standby.

Green : Timer standby.

Off : The unit is On.

13 Power I / ⏻ key (For U.S.A. and Canada) **I / ⏻ key (For Other Countries)** 

Press to set the unit to On or Standby.

14 sound key 

Press to switch the sound effect to EX.BASS or LOUD.

15 repeat key 

Press for setting repeated playback.

16 TAPE rec key 

Press to start tape recording. Pressing this key during recording initiates record-pause after leaving a no-sound blank of about 4 seconds.

17 TAPE O.T.E. key 

Press to start recording CD onto a tape with one-touch operation.

Pressing this key during CD playback records only the track being played onto tape. Pressing it during CD stop records all the CD tracks onto tape.

18 Headphone jack 

Connect headphones with a stereo mini-plug (optionally available).

*** About the volume/multi control knob**





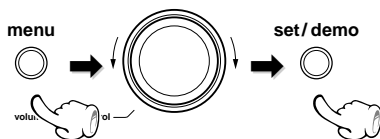

After pressing the menu key to select the menu select mode, turn the volume/multi control knob to select the desired menu item.

To set or enter the setting of the menu item, press the set/demo key.



- The function of the control knob returns to the normal mode when it has not been operated for 20 seconds.

Turning the knob switches the display contents.

- ▶ "TAPE RVS. ?" 
- ▶ "REC OPTIONS"
- ▶ "AUTO PRESET" or "AUTO MEMORY" 
- (Only when the TUNER input is selected)
- ▶ "AUX INPUT ?" 
- (Only when the AUX input is selected)
- ▶ "TIMER SET ?"  
- ▶ "A.P.S. SET ?" 

Standby mode

While the standby indicator of the unit is lit, a small amount of current is flowing into the unit's internal circuitry to back up the memory. This condition is referred to as the standby mode of the unit. While the unit is in the standby mode, it can be turned ON from the remote control unit.

Operation of remote control unit

The keys on the remote control unit with the same names as on the main unit have the same function as the keys on the main unit.

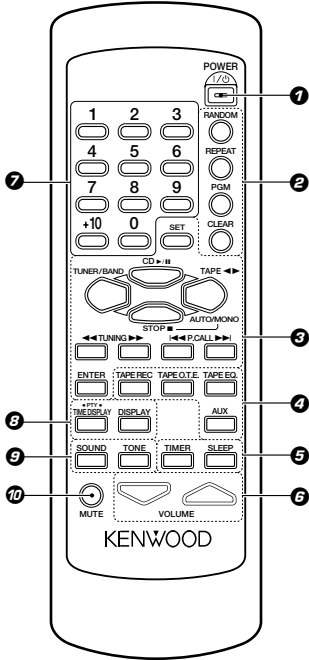

Infrared ray system

Model : RC-F0300E (For UK and Europe)
: RC-F0300 (For other countries)

- 1 POWER (I / ψ) key** - 14
Press to set the unit to On or Standby.
- 2 RANDOM key (CD)** - 34
Press for setting playback of tracks in a random order.
- REPEAT key (CD)** - 33
Press for setting repeated playback.
- PGM key (CD)** - 31
Press to program tracks in the desired sequence.
- CLEAR key (CD)** - 31
Press to clear a programmed track(s).

3 Basic operation keys

SET key

Press to set or enter an item selected with the **volume/multi control** knob.

TUNER/ BAND key

- 22

CD \blacktriangleright /II key

- 16

STOP \blacksquare key/ AUTO/MONO key

- 17 - 24

TAPE \blacktriangleleft \blacktriangleright key

- 20

\blacktriangleleft TUNING \blacktriangleright keys

CD, TAPE :

- 17 - 21

Used to fast-forward or fast-reverse the played audio.

TUNER :

- 24

Used to select a radio station.

\blacktriangleleft P.CALL \blacktriangleright keys

CD :

- 17

Used to skip CD tracks.

TAPE :

- 21

Used to fast forward or rewind tape.

TUNER :

- 22

Used to receive a preset radio station.

ENTER key

- 24

Press to enter a radio station in the preset memory of the tuner.

4 TAPE REC key

- 29

TAPE O.T.E. key

- 37

TAPE EQ. key

- 21

AUX key

- 38

Press to reproduce the external source component connected to the AUX (analog auxiliary input) jacks.

Pressing this key while the unit is off turns it on at the same time as selecting the AUX input.

5 TIMER key

- 43 - 46

Press to reserve the timer operation.

SLEEP key

- 41

Press to set the sleep timer.

6 VOLUME keys

- 14 - 15

Press to adjust the volume.

These key are also used to adjust the tone.

7 Numeric keys

→ 17 → 22

Used to select a CD track number or recall a preset station of the tuner.

8 PTY/ TIME DISPLAY key (For Europe and U.K.)

→ 18 → 21 → 26

Used at the time of program type detection. Press to switch the displayed time information on CD.

TIME DISPLAY key (For other countries)

→ 18 → 21

Press to switch the displayed time information on CD.

DISPLAY key

→ 18

Press to switch the display mode of the display panel.

9 SOUND key

→ 15

Press to switch the sound effect to EX.BASS or LOUD.

TONE key

→ 15

Press to adjust the tone.

10 MUTE key

→ 15

Press to mute the audio temporarily.

Loading batteries

1 Remove the cover.

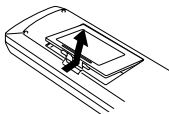

2 Insert batteries.

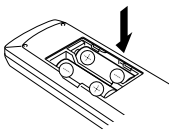

3 Close the cover.

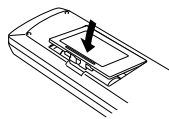

● Insert two R6 ("AA"-size) batteries following the polarity indications.

Operation

After plugging the power cord of this unit, press the **POWER (I / ⏻)** key of the remote control unit to turn the system ON. When the system is turned ON, press the key of the function to be operated.

- When pressing more than one remote control keys successively, press the keys securely by leaving an interval of 1 second or more between keys.

Operating range (approx.)

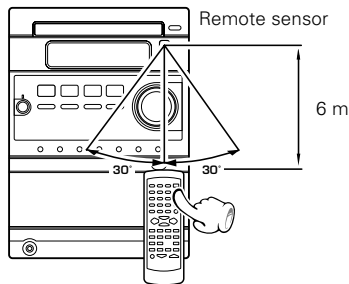

- The provided batteries are intended for use in operation checking, and their service life may be short.
- When the remote controllable distance becomes short, replace both of the batteries with new ones.
- If direct sunlight or the light of a high-frequency fluorescent lamp (inverter type, etc.) is incident to the remote sensor, malfunction may occur. In such a case, change the installation position to avoid malfunction.

Bass and treble compensation

The system is switched ON and STANDBY

Bass and treble compensation

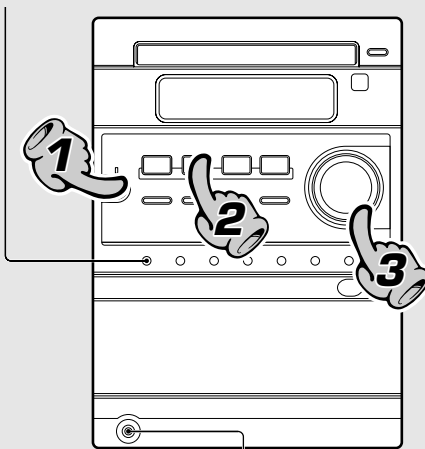
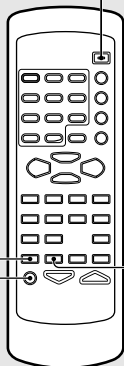

Muting the sound temporarily

Tone adjustment

Listening through headphones

Basic section

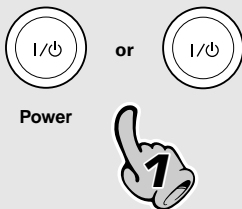

1. Set the Power I/O key to ON.

Pressing the Power I/O key when the unit is ON turns it off (Standby mode of power).

- Pressing the **TUNER FM/AM**, **CD ▶/II**, **TAPE ◀/▶** or **AUX** key also turns power on and starts playback (reception) of the corresponding input. (One-touch operation)
- When the CD or TAPE input is selected while the corresponding disc or tape has been loaded, it immediately starts to play.

Example:
To select the CD input



2. Selecting the desired output.

- CD** → [16]
- TAPE** → [20]
- TUNER (Broadcasts)** → [22]
- AUX (External input)** [Adjusting the AUX input level → [38]]

- Pressing the **TUNER FM/AM**, **CD ▶/II**, **TAPE ◀/▶** or **AUX** key selects the corresponding input.



When CD has been selected.

The volume decreases The volume increases

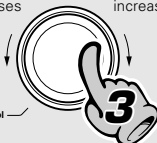

volume / multi control

3. Volume adjustment.

- The display shows a reference value.



Volume display

Listening through headphones

Insert the headphone plug into the headphone jack.



- Headphones with a stereo mini plug can be connected.
- The sounds from all speakers are cut off.

Muting the sound temporarily

Remote control unit only



- Press again to resume the original volume.
- This is also cancelled when the volume is changed.

Bass and treble compensation



Each press switches the modes as follows.

- ① **"EX.BASS" lights.**
The lowest and highest frequencies are enhanced regardless of the current volume level.
- ② **"LOUD" (Loudness) lights.**
The lowest and highest frequencies are enhanced according to the current volume level. (Effective during low-volume listening.)
- ③ **Both indicators off.**
Cancelled.

- Adjusting the tone while the "LOUD" or "EX.BASS" indicator is lit turns it off and cancels the sound enhancement mode.

Tone adjustment

Remote control unit only

The lowest and highest frequency bands can be adjusted independently.

① Select the frequency band.



Each press switches the operation.

- ① **"BASS" (low frequency) adjustment**
- ② **"TREBLE" (high frequency) adjustment**
- ③ **Normal mode**

(Go to step ② within 8 seconds.)

② Adjust.



(To adjust the other frequency band, repeat steps ① and ② for it.)

- The levels of both "BASS" and "TREBLE" can be adjusted in 2 steps in the range between -8 and +8.
- Adjusting the tone while the "LOUD" or "EX.BASS" indicator is lit turns it off and cancels the sound enhancement mode.

When a disc is placed into the CD player in advance, the unit will be switched on automatically by pressing the CD ►/II key, and playback will start.

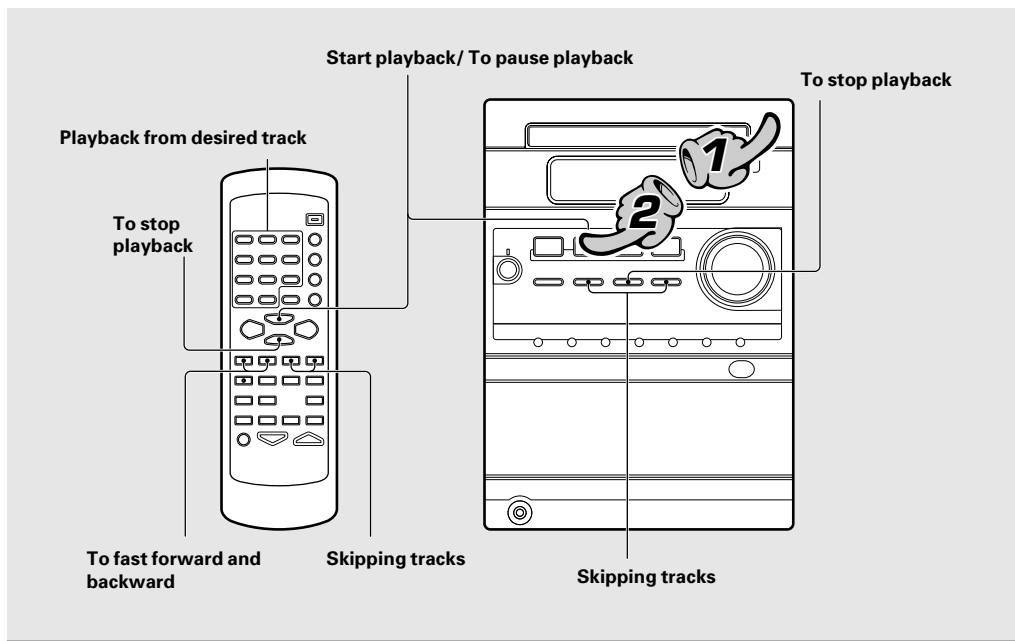

1. Load a disc.

- ❶ Press the ▲ CD key.
- ❷ Place a disc.
- ❸ Press the ▲ CD key.

The label side must be on top.



- Do not touch the played side of disc.
- Be sure to place a disc horizontally. Placing it with an inclination will result in malfunction.

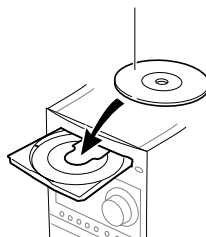

2. Start playback.

- After a few seconds, play starts from track No.1.
- Titles are displayed for discs conforming to CD-TEXT.

Track No. being played

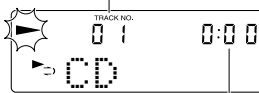

Elapsed time of track being played

Start playback/To pause playback



- Each press pauses and plays the CD alternately.

To stop playback

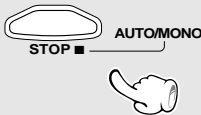

Playback from desired track

Remote control unit only

Select the desired track No.

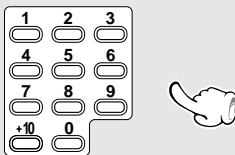

Press the numeric keys as shown below....

To select track No. 23 :+10 x 2, 3

To select track No. 40 :+10 x 4, 0

To fast forward and backward

Remote control unit only

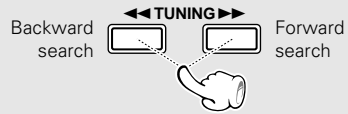

- Press and hold one of the keys during playback. Normal playback resumes at the point where the key is released.

Skipping tracks



- The track in the direction of the key pressed is skipped, and the selected track will be played from the beginning.
- When the **◀◀** key is pressed once during playback, the track being played will be played from the beginning.
- To skip further to a track located before the current track, press the **◀◀** key quickly.
- Tracks can be skipped by pressing the **◀◀** or **▶▶** key even when the CD is in stop mode. In this case, playback starts automatically from the point reached by skipping.

Eject the CD

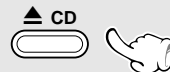

- The CD tray will open. (Pressing the key again closes the CD tray.)

Time display on CD player

Each press of the TIME DISPLAY key changes the displayed contents.

Remote control unit only



or



(For U.K. and Europe)

(For other countries)

- Only time information ① and ② can be displayed during single-track repeated playback or random playback.
- In the program mode, display ③ shows the elapsed time of the entire program and display ④ shows the remaining time of the entire program.
- When the displayed time is 256 minutes or more, the display shows "-- : --".

① Elapsed time of track being played

TRACK NO.	TIME
01	1:23

② Remaining time of track being played

TRACK NO.	TIME
01	- 2:34

③ Elapsed time of entire disc

("TOTAL" lights up)

TRACK NO.	TOTAL
01	23:45

④ Remaining time on entire disc

("TOTAL" lights up)

TRACK NO.	TOTAL
01	- 36:15

Title display with CD-TEXT compatible discs

When a CD-TEXT compatible disc is played on this unit, the disc and track titles recorded in the disc are displayed automatically provided that they use alphanumeric characters.

When a title is too long to be accommodated in the display, press the DISPLAY key to scroll the displayed title so that the previously hidden characters be viewed.

Remote control unit only



(When pressed during stop)

Scrolled disc title display

BACH: Solo V

(When pressed during play)

Scrolled track title display

BACH: Partit

- It may sometimes be unable to display the recorded characters even when the loaded disc is a CD-TEXT compatible disc. When the number of characters recorded in a disc is 1000 or more, the display will show "TEXT FULL".



If you load a tape in the cassette deck in advance while the power is off. Pressing the TAPE ◀▶ key turns power on automatically and starts the tape playback.

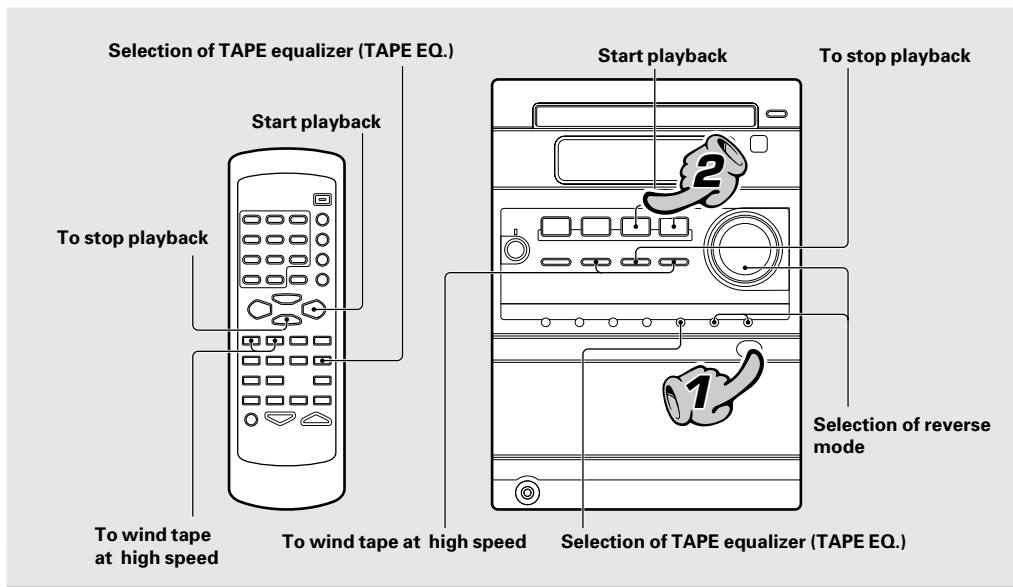

1. Load a cassette tape.

- ① Press the area marked ▲ push open to open the cassette holder.
- ② Insert a tape.
- ③ Press the area marked ▲ push open to close the cassette holder.

Do not use a cassette with more than 90-minute recording time, for the tape used with such a cassette is very thin and tends to cause troubles such as entanglement around the pinch roller or cutting of tape.

- The tape deck of the unit can play Normal (Type I), High (Type II) and Metal (Type IV) tapes.
- Remove tape slack before loading.

2. Start playback.

Press the TAPE ◀▶ key of the desired direction.

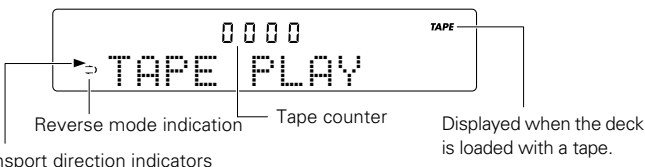
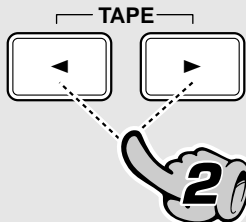

Transport direction indicators:

Indicates the tape transport direction during playback or recording by lighting of ◀ or ▶. This direction is the direction stored in memory when the tape was last stopped.

To wind tape at high speed

To fast wind in direction ← To fast wind in direction →

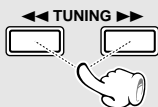

- Press the **STOP** ■ key to stop fast winding.
- The same operation is also available with the ◀ and ▶▶ keys on the main unit.

Selection of TAPE equalizer (TAPE EQ.)

When playing a tape prerecorded with Noise Reduction system (such as the DOLBY NR) ON, be sure to set the "TAPE EQ." ON for playback.

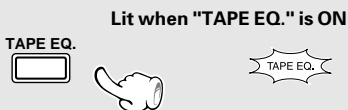

Each press switches the modes as follows.

- ① "TAPE EQ." ON
(TAPE equalizer is used)
- ② "TAPE EQ." OFF
(TAPE equalizer is not used)

- Select the "TAPE EQ." ON mode according to the recording condition of the tape.

To stop playback

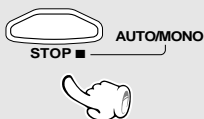

Selection of reverse mode

Main unit only

- ① Select "TAPE RVS. ?".

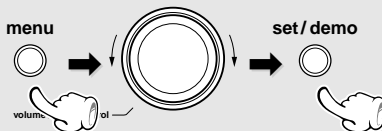

(Press the set/demo key while the "?" mark is blinking)

- ② Select.



- ① "↔": (ONE-WAY)
Only one side is played back (recorded), and then the tape stops.
- ② "⇄": (REVERSE)
Both sides are played back (recorded), and then the tape stops.
- ③ "↻": (ENDLESS)
Both sides are played back endlessly. (The tape stops after recording onto both sides.)

(The initial setting is ⇄ "REVERSE")

- ③ Set it.



A tip for use of the tape counter

The tape counter is set to "0000" when a cassette tape is loaded. By writing down the counter reading in case you want to interrupt recording (playback) in the middle of the tape, the memo will be helpful as a reference for locating the same position when continuing the recording (playback) the next time. The tape counter figure decrements during recording or playback of the back side (while the ◀ tape transport indicator is lit). To set the tape counter to "0000", open the cassette holder once. Then the counter will be reset.

Tape counter display

The displayed information is switched every time the TIME DISPLAY key is pressed.

Remote control unit only

(For U.K. and Europe)

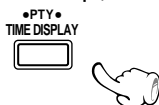

or

(For other countries)

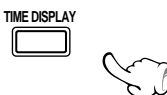

- ① Clock display
- ② Tape counter

22 Receiving broadcast station

When the TUNER FM/AM key is pressed, the unit will automatically be switched on and reception status will be reached.

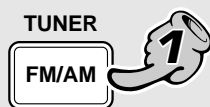
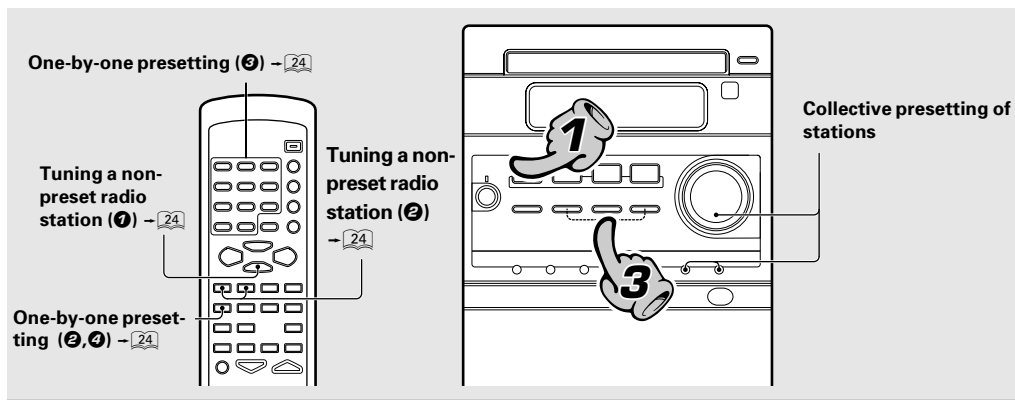

1. Select the tuner input.

Each press of the TUNER FM/AM key switches the band as follows.

- ▶ FM
- ▶ AM

2. Preset a radio station in memory.

Collective presetting of stations - [23]

Follow the procedure in "Collective presetting of stations" to preset automatically the tunable radio stations in your area.

- Once stations are stored by auto presetting, the present procedure is not required from the next time, unless you move of house or re-execute presetting of all tunable stations.

One-by-one presetting (Manual preset) - [24]

A station can also be tuned even when it is not preset. For details, read "Tuning a non-preset radio station (Auto tuning, Manual tuning)".

3. Tuning (Preset Call)

- If radio stations have already been stored with auto presetting or manual presetting, select a station using the ◀◀, ▶▶ key. Each press of the same key switches the preset stations in sequence.

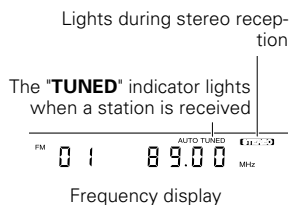
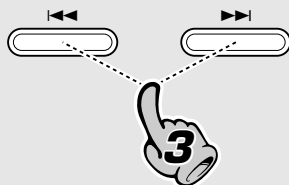

When ▶▶ is pressed : 1→2→3 ... 28→29→30→1...

When ◀◀ is pressed : 30→29→28 3→2→1→30....

- When a key is held depressed, preset stations will be skipped at an interval of about 0.5 second.
- To select a preset station from the remote, use the ◀◀ P.CALL ▶▶ key or numeric keys.

Collective presetting of stations

AUTO MEMORY .. For U.K. and Europe
AUTO PRESET For other countries

Main unit only

① Receive a broadcast.

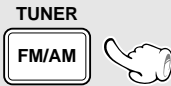

② Select "AUTO MEMORY"
 (or "AUTO PRESET").

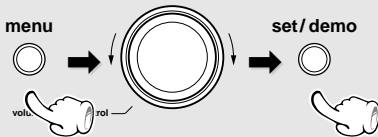

- A maximum of 30 stations of the band presently being received will be preset.
- When there are many stations and the intended station has not been preset, please also use "One-by-one pre-setting (Manual preset)".

Channel space setting (Except for U.S.A., Canada, U.K., Europe, Malaysia and Australia)

The space between radio channels has been set to the one that prevails in the area to which the system is shipped. However, if the current channel space setting does not match the setting in the area where the system is to be used, for instance when you move from area 1 or area 2 shown in the following table or vice versa, proper reception of AM/FM broadcasts cannot be expected. In this case, change the channel space setting in accordance with your area by referring to the following table.

Main unit only

① Turn power on.

② While holding TUNER FM/AM key pressed, turn the volume/multi control knob to select "FM 50/AM 9" or "FM100/AM10".

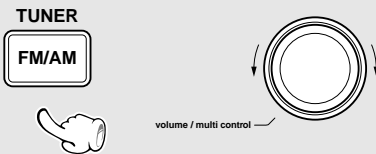

③ Set it.



Each press switches the space frequency alternately.

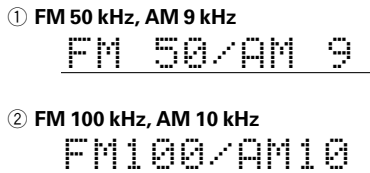

	Area	CHANNEL Space Frequency
①	USA, Canada and South American countries	FM: 100 kHz AM: 10 kHz
②	Other countries	FM: 50 kHz AM: 9 kHz

Tuning a non-preset radio station (Auto tuning, Manual tuning)

Select the tuning mode according to the radio wave receiving condition.

When the receiving condition is good: **AUTO mode**

When it is poor due to weak radio waves: **MANUAL mode**

❶ Select the **AUTO** or **MANUAL** mode.

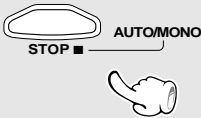

❷ Tune a station.

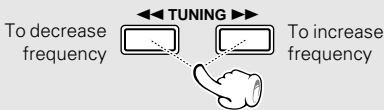

- In **MANUAL** mode, FM stations are received in monaural.

Each press alternates the mode.

- ① **"AUTO"** : Stereo reception ("AUTO" lit)
- ② **"MANUAL"** : Monaural reception ("AUTO" not lit)

- Normally, use the **AUTO** (Auto tuning, stereo reception) mode.

In AUTO mode :

The next preset station can be received automatically every time the **TUNING UP/DOWN** (◀◀ or ▶▶) key is pressed.

In MANUAL mode :

Press the **TUNING UP/DOWN** (◀◀ or ▶▶) key repeatedly until the desired station is received. The desired station can also be received by holding the **TUNING UP/DOWN** (◀◀ or ▶▶) key depressed until its frequency is displayed.

One-by-one presetting (Manual preset)

Remote control unit only

❶ Perform the procedure in "Tuning a non-preset radio station (Auto tuning, Manual tuning)" to receive the station to be preset.

❷ Press the **ENTER** key during reception.



(Proceed to step ❸ while "MEMORY" is lit.)

❸ Select one of the preset numbers from 1 to 30.

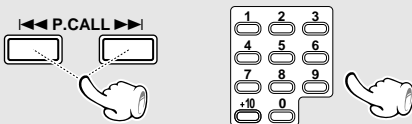

❹ Press the **ENTER** key again.



(Repeat steps ❶, ❷, ❸ and ❹ to preset other stations)



"MEMORY" lights (for approx. 20 sec.)

- A maximum of 30 stations of the band presently being received will be preset.

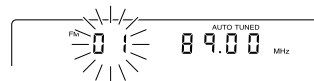

- If several stations are preset under the same number, the previous memory is replaced with the latest memory contents.

RDS is a system which transmits useful information (digital data) for FM broadcasts together with the broadcast signal. Tuners and receivers designed for RDS reception can extract the information from the broadcast signal for use with various functions such as automatic display of the station name.

This unit is equipped with the following functions utilizing RDS data :

PTY (Program Type Identification) Search :

The tuner automatically searches for a station which is currently broadcasting a specified program type (genre).

PS (Program Service Name) Display :

When an RDS broadcast is received, the station name is automatically displayed.

The "R.D.S" indicator lights up when an RDS broadcast (signal) is received.

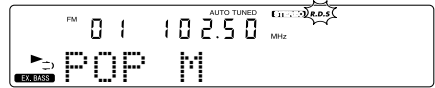

- Some functions may not be provided or be given different names depending on countries or areas.

Before using RDS

For reception of RDS stations, the auto memory function must be used to preset the stations. With the auto memory function, RDS stations are preset with priority. "No Data" will be flashed when a station is not preset by auto memory.

Searching for a desired program type (PTY search)

By specifying the type of program (genre) you want to listen to, the tuner automatically searches for a station which is currently broadcasting a program of the specified type.

Set the reception band to FM. Preset RDS stations with the auto memory function. — 23

1 Select the PTY search mode.

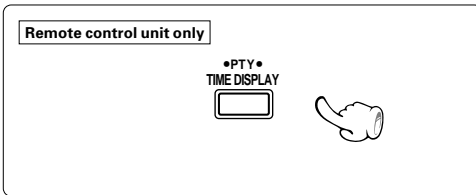

When an RDS broadcast is received, the program type is shown on the display. If no PTY data is available, or if the station is not an RDS station, "None" is displayed.

2 Select the desired program type.

Use program type table on the right for your convenience.

A Selection with the ◀◀ or ▶▶ key

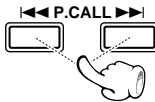

Select while "PTY" is lit.

The desired program type can be selected with the ◀◀ or ▶▶ key from 29 types. Press the key and release it when the desired type is displayed.

B Selection with the numeric keys.

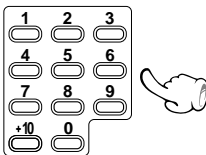

The program types 1 to 9 and 0 can be selected directly with the number keys. Use the ◀◀ or ▶▶ key to select other program types.

Program type table

◀◀, ▶▶ keys (A)	Program Type Name (B)	Display	
DOWN ↑ UP ↓	1	Pop Music	POP M
	2	Rock Music	ROCK M
	3	Easy Listening Music	EASY M
	4	Light Classical	LIGHT M
	5	Serious Classical	CLASSICS
	6	Other Music	OTHER M
	7	News	NEWS
	8	Current Affairs	AFFAIRS
	9	Information	INFO
	0	Sport	SPORT
		Education	EDUCATE
		Drama	DRAMA
		Culture	CULTURE
		Science	SCIENCE
		Varied	VARIED
		Weather	WEATHER
		Finance	FINANCE
		Children's programs	CHILDREN
		Social Affairs	SOCIAL
		Religion	RELIGION
		Phone In	PHONE IN
		Travel	TRAVEL
		Leisure	LEISURE
		Jazz Music	JAZZ
		Country Music	COUNTRY
		National Music	NATION M
		Oldies Music	OLDIES
		Folk Music	FOLK M
		Documentary	DOCUMENT

3 Start the search.

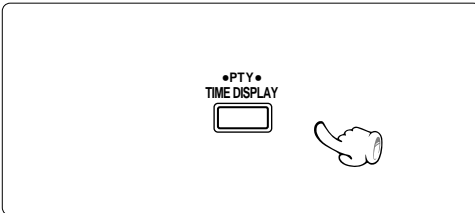

- No sound is heard while "PTY" is blinking.
- If a program of the desired type cannot be found, "No Program" is displayed, then after several seconds the display returns to the original display.
- If a program of the desired type is found, that program is received and the program type name display changes temporarily to the station name display.

To change to a different program type :

Repeat steps **1**, **2**, **3**.

When searching for a Rock Music broadcast

Display while the tuner is searching.

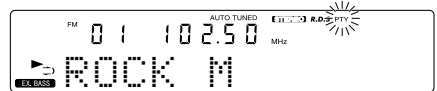

Program type name display.

When a station is received.

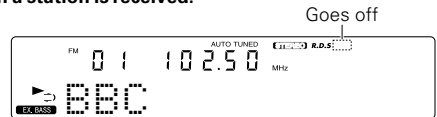

Station name display.

The tape deck of the unit can record signals only on Normal (Type I) and High (Type II) tapes. It cannot record on Metal (Type IV) tapes.

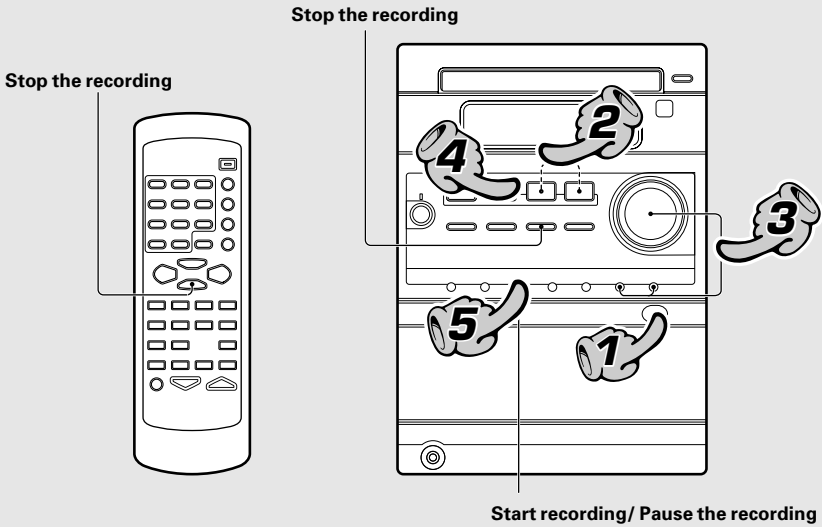

1. Load a tape in deck.

- ① Press the area marked ▲ push open to open the cassette holder.
- ② Insert a tape.
- ③ Press the area marked ▲ push open to close the cassette holder.



Do not use a cassette with more than 90-minute recording time, for the tape used with such a cassette is very thin and tends to cause troubles such as entanglement around the pinch roller or cutting of tape.

- Remove tape slack before loading.

2. Select the tape transport direction.

To reverse the transport direction :

- ① Press the TAPE ◀ ▶ key corresponding to the desired direction.
- ② Stop playback.

- When recording is started, the tape is transported in the direction selected in this step.

Check the tape transport direction indicator. - 20

- Search the position you want to start recording in advance.

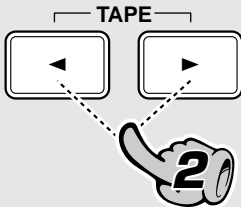

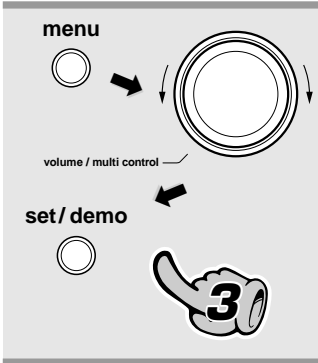

3. Set the recording condition.

Select the reverse mode. - [21]

- Check the tape transport direction before starting recording. If it is set to the reverse direction, only one side of tape can be recorded regardless of the reverse mode setting made here.
- The tape equalizer is defeated during recording.

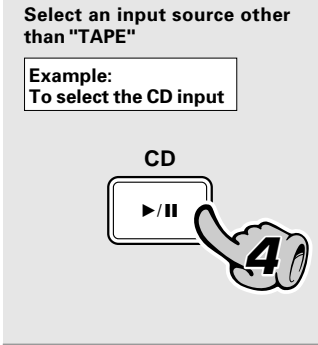

4. Select the source to be recorded.

CD

TUNER (Broadcasts)

AUX (External input) [Adjusting the AUX input level - [38]]

- If a CD has already been loaded, it starts to play now. Press the ■ STOP key to stop it.



The character information display shows the recording input source.



5. Start recording.

- 1 Press the TAPE rec key.
- 2 Play (or tune) the input source to be recorded.

- Recording stops automatically when the tape side (s) to be recorded have been fully recorded.

Pause the recording

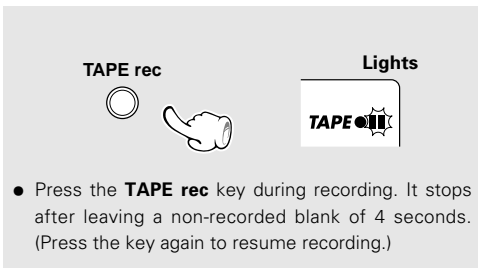

Stop the recording

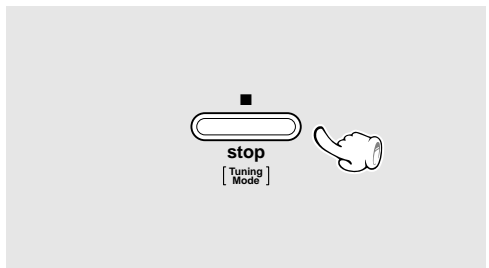

Points in CD recording

When recording CD tracks onto a tape, if you leave the cassette deck in record-pause mode beforehand, the cassette deck recording can be started at the CD starts to be played.

- ❶ Put the CD player in pause mode.
- ❷ Select the track to be recorded with the skip (|◀, ▶|) keys. (The CD player pauses at the beginning of the selected track.)
- ❸ Put the cassette deck in Record-pause mode. (Press TAPE rec key twice)
- ❹ Start playing the CD. (Recording starts)

- To stop recording, press the ■ **STOP** key.

Listening to the desired sequence (program playback)

Use the following procedure to program desired tracks in a desired order. (up to 32 tracks)

Select the CD input.

1 Let the "PGM" indicator light.

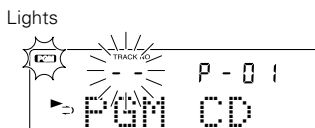
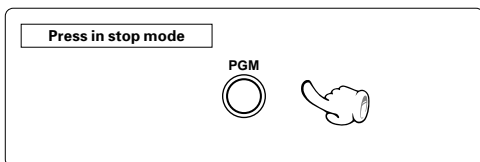

2 Select track numbers in the order you want to play them.

1 Select the track.

(Go to step 2 within 20 seconds.)

2 Confirm the selection.

(To select more than one track, repeat steps 1 and 2 for each track.)

Selection of tracks Program position of the track to be selected next.

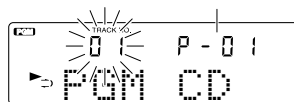

Press the numeric keys as shown below....

To select track No. 23 : +10 x 2, 3

To select track No. 40 : +10 x 4, 0

- Up to 32 tracks can be programmed. When "PGM FULL" is displayed, no more tracks can be programmed.
- If you made a mistake, press the **CLEAR** key and enter the track No. again.
- When a track No. is entered, the track will be added to the end of the existing program.
- When the total time of CD program is 256 minutes or more, the time display shows "-- : --".

3 Start playback.

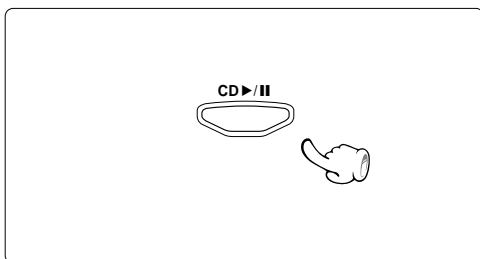

- Tracks will be played in the order they were programmed (following the program numbers).
- When the **I◀▶/▶▶** key is pressed during play, the program will jump to the preceding or the following track respectively.
- When the **I◀◀** key is pressed once during playback, the play position returns to the beginning of the current track being played.

To add a track to an existing program

- ① Select the track number to be added with the numeric keys.

Press in stop mode

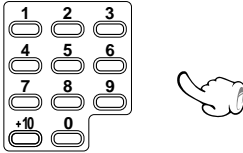

- ② Press the SET key.

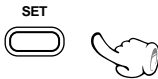

Press the numeric keys as shown below....

To select track No. 23 : +10 x 2, 3

To select track No. 40 : +10 x 4, 0

- Up to 32 tracks can be programmed. When "PGM FULL" is displayed, no more tracks can be programmed.
- If you made a mistake, press the **CLEAR** key and enter the track No. again.
- When a track No. is entered, the track will be added to the end of the existing program.

To clear a programmed track

Press in stop mode

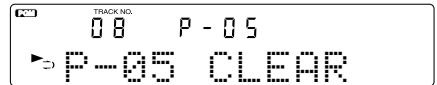
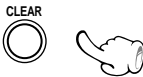

P-5 has been deleted

- Each time the key is pressed, the last track in the program is cleared.

To clear the entire program

Press in stop mode

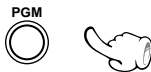

Goes off

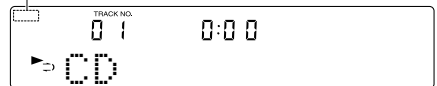

The program mode is cancelled when the unit is turned off or the programmed disc is ejected. The set program is cleared entirely at this time.

Repeated playback

You can repeatedly listen to a favorite track or disc.

Select the CD input.

Setup for repeating a single track

❶ Confirm that the "PGM" indicator is not lit.



❷ Play the track to be repeated.

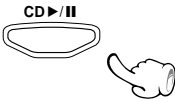

❸ Select "ONE REPEAT".



- If the "PGM" indicator is lit, turn it off by pressing the PGM key in stop mode to cancel the program mode.

Confirm that this is not lit.



Each press switches the repeat mode.

- ① "ONE REPEAT"
- ② "REPEAT"
- ③ Off.... Repeat deactivated

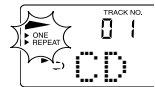

Setup for repeating all tracks in a disc

❶ Confirm that the "PGM" indicator is not lit.



❷ Select "REPEAT".



❸ Start playback.

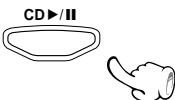

- If the "PGM" indicator is lit, turn it off by pressing the PGM key in stop mode to cancel the program mode.

Confirm that this is not lit.



Each press switches the repeat mode.

- ① "ONE REPEAT"
- ② "REPEAT"
- ③ Off.... Repeat deactivated

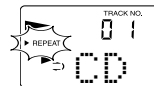

Setup for repeating selected tracks

① Program the track sequence according to steps 1 to 2 of "Listening to the desired sequence (program playback)". → 31

② Select "REPEAT".



③ Start playback.

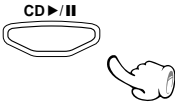

Each press switches the repeat mode.

- ① "REPEAT"
- ② Off... Repeat deactivated



- All selected tracks will be repeated.

To stop repeated playback

Press the REPEAT key repeatedly until the repeat mode is switched off.

- The "REPEAT" indicator turns off and playback according to the current CD player mode.

Playing tracks in a random order (random playback)

As the titles each time are selected randomly, the music can be enjoyed without getting tired of it.

Select the CD input.

① Confirm that the "PGM" indicator is not lit.



② Press the RANDOM key.



- If the "PGM" indicator is lit, turn it off by pressing the PGM key in stop mode to cancel the program mode.

Each press switches the modes as follows.

- ① "RANDOM" on (Random playback)
- ② "RANDOM" off (Normal playback)



- Playback stops after each title has been played once.
- The random playback can also be repeated by pressing the REPEAT key.

To select another track in the middle of playing one



- Pressing the P.CALL key returns the playback position to the beginning of the track being played.

To cancel random playback

Press so that the "RANDOM" indicator is turned off.



- The "RANDOM" indicator goes off and the playback in order of the tracks starts from the track being played.

This unit provides the following recording features in addition to normal recording. Select the appropriate method according to the purpose of recording.

The tape deck of the unit can record signals only on Normal (Type I) and High (Type II) tapes. It cannot record on Metal (Type IV) tapes.

To record CD with a simplified method (CD → TAPE) → 36

All-track recording



Records all tracks in a CD onto a tape.

Single-track recording



Records only one CD track being played onto a tape.
(This is convenient for recording of desired tracks from a disc being heard for the first time.)

To record desired CD tracks by reordering them (CD → TAPE) → 37

Program recording



Recording of programmed tracks in the programmed order.
(Convenient for recording only the desired CD tracks in the desired order.)



With recording onto tape, the track will be interrupted for the part of the guide tape at the tape reversal, where recording is not possible. Please use single-side recording if this is to be avoided.

One-touch edit recording (CD → TAPE)

Records all tracks in a CD with a simple operation. (All-track recording)

Records a single CD track being played from the beginning. (Single-track recording)

The tape deck of the unit can record signals only on Normal (Type I) and High (Type II) tapes. It cannot record on Metal (Type IV) tapes.

Be sure to put the cassette deck in stop mode.

1 Make preparation for recording.

① Perform steps 1 to 3 of the procedure in "Recording on TAPE". - 26

② Ensure that the "PGM" and "RANDOM" indicators are not lit.

③ Insert disc in the CD player.

- If the "PGM" indicator is lit, turn it off by pressing the **PGM** key in stop mode to cancel the program mode.
- If the "RANDOM" indicator is lit, turn it off by pressing the **RANDOM** key to cancel the random play mode.

2 Check the current play mode of the CD player.

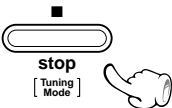
All-track recording	Single-track recording
<p>If it is in play mode, stop it.</p> 	<p>Select the desired CD track and play it.</p> <ul style="list-style-type: none"> ● When step ② is performed in the middle of CD playback, the current track will be recorded from the beginning. <p>(To record other tracks, repeat steps ② and ③ for each track)</p>

3 Start recording.

TAPE O.T.E.



If you are operating the remote, the same effect as step ② can be obtained by simply pressing the TAPE O.T.E. key to start recording.

- When either playback or recording stops, the other operation is stopped automatically.

To interrupt a recording

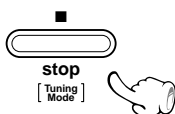

(Recording and playback will be stopped)

At the end of the recording

Cassette deck : Stop is executed after an unrecorded portion of about 4 sec. has been produced.

Program recording (CD → TAPE)

Desired CD tracks can be programmed in the desired sequence and recorded onto a tape.

The tape deck of the unit can record signals only on Normal (Type I) and High (Type II) tapes. It cannot record on Metal (Type IV) tapes.

Be sure to put the cassette deck in stop mode.

1 Make preparation for recording.

- ① Select the CD input.
- ② Ensure that the "RANDOM" indicators are not lit.
- ③ Perform steps 1 to 3 of the procedure in "Recording on TAPE". -  28
- ④ Insert disc in the CD player.

- If the "RANDOM" indicator is lit, turn it off by pressing the **RANDOM** key to cancel the random play mode.

2 Program the desired sequence of CD tracks.

Perform steps ① and ② of the procedure in "Listening to the desired sequence (Program playback)". -  31

- When the **PGM** key is pressed to cancel the edited contents, the entire editing contents will be erased. -  32
- Tracks programmed beyond the available tape recording time will be interrupted in the middle.

3 Start recording.

TAPE O.T.E.



If you are operating the remote, the same effect as step ② can be obtained by simply pressing the **TAPE O.T.E.** key to start recording.

- Recording starts from the first track in the program and ends after having recorded the entire programmed tracks.
- Recording stops automatically when the program playback of CD has completed.
- When either playback or recording stops, the other operation is stopped automatically.

To interrupt a recording

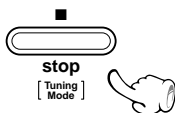

(Recording and playback will be stopped)

At the end of the recording

Cassette deck : Stop is executed after an unrecorded portion of about 4 sec. has been produced.

1 Select AUX (external input).

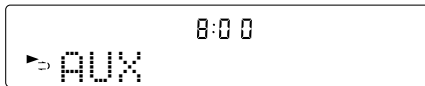
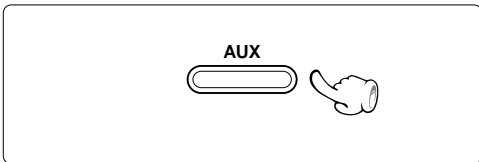

2 Play the connected equipment.

3 Adjust the volume.

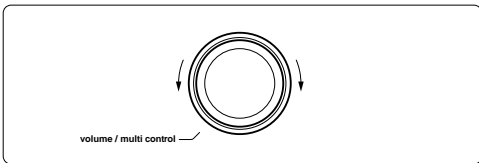

Adjusting the AUX Input Level

This adjusts the input level for the external equipment (video deck etc.) connected to the AUX input terminal. Adjust so that the volume of the AUX input source sounds at an equivalent level to the CD. (Main unit operation only)

1 Press the AUX key.

2 Select "AUX INPUT ?".

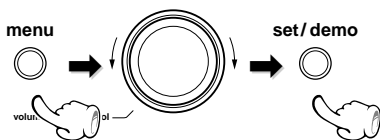

(Press the set/demo key while the "?" mark is blinking.)

3 Adjust the input level.

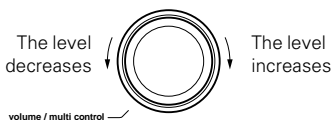

4 Set it.

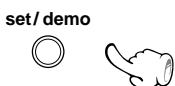

Turning the knob switches the display contents.

- "TAPE RVS. ?"
- "REC OPTIONS"
- "AUTO PRESET" or "AUTO MEMORY"
(Only when the TUNER input is selected)
- "AUX INPUT ?"
(Only when the AUX input is selected)
- "TIMER SET ?"
- "A.P.S. SET ?"



- Adjustment is possible over the range from - 5 to + 2.
- Adjusting the input level control also varies the recording level from the input source connected to the AUX input jacks.

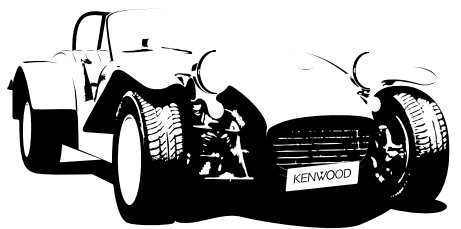

As the clock is not used to show the time of the day but is also used in timer operations, be sure to set the clock in advance.

1 *Activate the clock adjustment mode.*

Press and hold for more than 2 sec. when the power is ON.

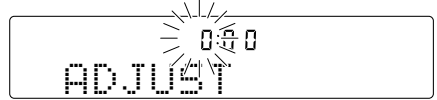
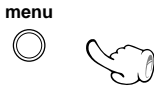

- The time display starts to blink.

2 *Enter the figure of hour.*

1 Enter the figure of hour.

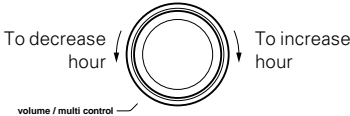

2 Set it.



Example: Adjustment to 8:07



- In other areas than the U.K. and Europe the clock shows the time of the day in the 12-hour system.
- Press the **set/demo** key. The hour is entered and the minute display starts to blink.

3 *Enter the figure of minute.*

1 Enter the figure of minute.

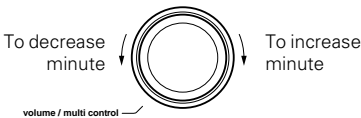

2 Set it.

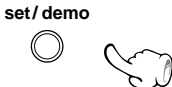

Example: Adjustment to 8:07



- If you make a mistake, restart from the beginning.
- When the time of day has been set by pressing the **set/demo** key, the display shows "COMPLETE!".
- After a power failure or the power cord has been unplugged then plugged in again, it is required to set the time again.
- When the **STOP** key is pressed while the power is in the standby mode, the time of the day will be displayed for 5 seconds.

Sleep timer (SLEEP)

The unit is turned OFF automatically after the specified period has elapsed.

Operate easy To use Timer (O.T.T.) →

Playback of the selected input source starts at the specified time, and the unit is switched off after one hour. This timer operates only once directly after setting.

Timer playback, timer recording (PROG.1, PROG.2) →

Playback of the selected input source or recording of the TUNER or AUX input starts at the specified time.

AI timer playback (PROG.1, PROG.2) →

When timer playback starts, the volume level increases gradually until a certain level is reached.

Sleep timer (SLEEP)

Set the number of minutes after which the unit is to be turned OFF.

Connect the related equipment under reference to "System connection" →  ~ 

Set the time.



- The unit is turned OFF automatically after the set time has elapsed.
- Each press increases the timer period by 10 minutes. The sleep timer can be set up to 90 minutes.

10 → 20 → 30 70 → 80 → 90 → Cancel → 10 → 20
.....



- Press the **SLEEP** key while the sleep timer is activated to check the remaining time.

To cancel

Turn the unit OFF or press the SLEEP key until the sleep time is cancelled.

The system has been set up so that the display is dimmed automatically while the sleep timer is activated.

Setting the O.T.T. timer

Timer playback which occurs only once and only for an hour can be programmed by simply setting the start time. The timer playback reproduces the source selected at the last time the unit is turned off at the last set volume.

Adjust the clock before setting the timer → 40

Connect the related equipment under reference to "System connection" → 6 ~ 8

1 Select the O.T.T. timer.

① Select "TIMER SET ?".

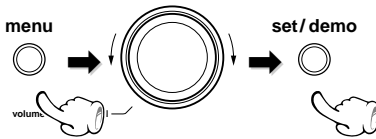

(Press the set/demo key while the "?" mark is blinking.)

② Select "O.T.T. SET ?".

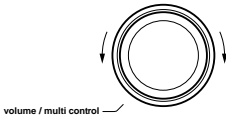

③ Set it.

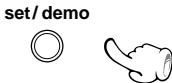

(Press during display of the program contents.)

Turning the knob switches the display contents.

- "TAPE RVS. ?"
- "REC OPTIONS"
- "AUTO PRESET" or "AUTO MEMORY"
(Only when the TUNER input is selected)
- "AUX INPUT ?"
(Only when the AUX input is selected)
- "TIMER SET ?"
- "A.P.S. SET ?"

Turning the knob switches the display contents.

- ① "O. T. T. SET ?"
- ② "PROG. 1 SET ?"
- ③ "PROG. 2 SET ?"

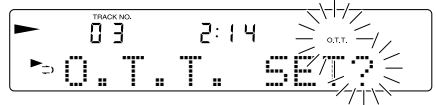

- The previously set contents are displayed. (If you do not want to change them, simply press the **set/demo** key.)
- When a timer setting has already been made in the selected timer, the setting will be overwritten by the new setting.

2 Set the time at which you want to start playback or reception (On time).

1 Adjust the time.

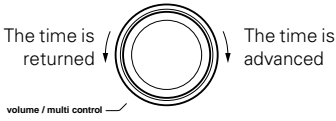

2 Set it.

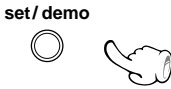

To check or modify the reservation contents, restart the timer reservation from the beginning.

3 Reserve the timer operation.

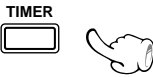

Each press switches the timer as follows.

- ① "O.T.T."
- ② "PROG. 1"
- ③ "PROG. 2"
- ④ "PROG. 1 2"
- ⑤ Extinguished

- Press the remote's **TIMER** key repeatedly until "O.T.T." lights up.
- To cancel the timer reservation after it has been activated, press the **TIMER** key while the unit is ON so that all of the timer-related indicators are turned off. (The setting made above is still left in memory.)
- When the O.T.T. timer is set while the PROG.1 or PROG.2 timer has been set, the reservation by the PROG.1 or PROG.2 timer is canceled.

4 Put the unit in standby mode.

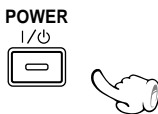

- When the unit enters the Standby mode, the **standby/timer** indicator lights in green.
- If there is a power failure or the power cord is unplugged after the timer reservation has been activated, the **standby/timer** indicator blinks in green. In this case, the clock setting should be restarted from the beginning.

Setting an everyday timer program (PROG. TIMER)

In each of PROG.1 and PROG.2, the timer data including the operating period and played contents can be set and selected to be activated or not as required.

Adjust the clock before setting the timer → [40]

Connect the related equipment under reference to "System connection" → [6] ~ [8]

1 Make preparations for the play (recording).

To listen to CD	To listen to tape	For recording
Insert a disc. (Program playback is not possible.)	Set a tape into.	Make preparations for recording. → [28]
To listen to radio	Playing the auxiliary input source	
The station should be preset prior. → [23]	Make timer setting of the component connected to the AUX input jacks.	

- Two timer settings can be reserved independently in two programs PROG.1 and PROG.2.
- Please make reservations with an interval of at least one minute, so that the operation times of PROG. 1 and PROG. 2 do not overlap.

2 Select the timer number.

① Select "TIMER SET ?".

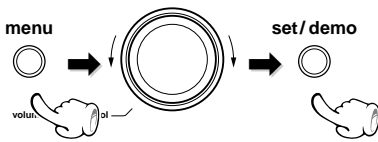

(Press the set/demo key while the "?" mark is blinking.)

② Select "PROG. 1 SET ?" or "PROG. 2 SET ?".

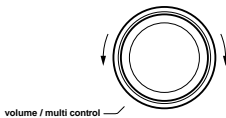

③ Set it.



(Press during display of the program contents.)

Turning the knob switches the display contents.

"TAPE RVS. ?"
 "REC OPTIONS"
 "AUTO PRESET" or "AUTO MEMORY"
 (Only when the TUNER input is selected)
 "AUX INPUT ?"
 (Only when the AUX input is selected)
 "TIMER SET ?"
 "A.P.S. SET ?"

Turning the knob switches the display contents.

① "O. T. T. SET ?"
 ② "PROG. 1 SET ?"
 ③ "PROG. 2 SET ?"

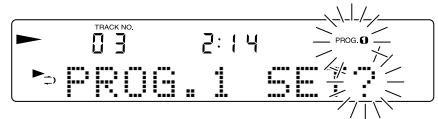

- The previously set contents are displayed. (If you do not want to change them, simply press the **set/demo** key.)
- When a timer setting has already been made in the selected timer, the setting will be overwritten by the new setting.

Continued on next page

3 Set the ON time then the OFF time.

1 Adjust the time.

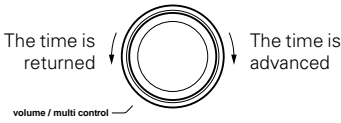

2 Set it.

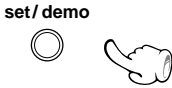

- In other areas than the U.K. and Europe the clock shows the time of the day in the 12-hour system.
- For each of the ON time and OFF time, enter the figure of "hour" by performing steps 1 and 2 then enter the figure of "minute" in the same manner.
- If you make a mistake, press the **menu** key and restart from step 2.

4 Make the desired reservation.

For timer playback or AI timer playback

1 Select the mode.

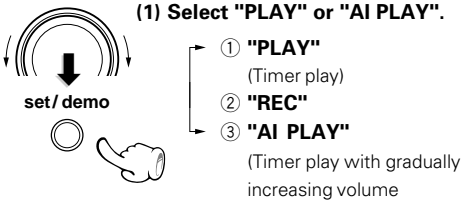

(2) Set it.

2 Select the input source.

(1) Select the source to be played.

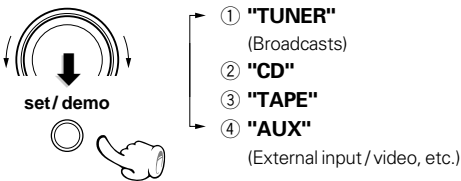

(2) Set it.

Continued on next page

For timer recording

1 Select the mode.

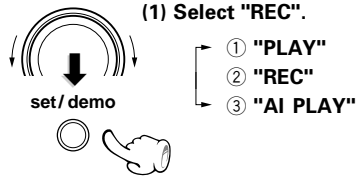

(2) Set it.

2 Select the input source.

(1) Select what is to be recorded.

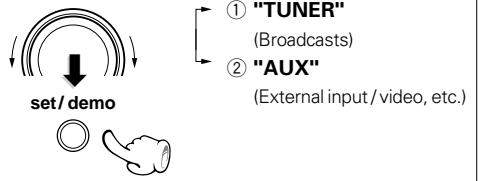

(2) Set it.

Continued on next page

④ Select the broadcast station (only when TUNER is selected above).

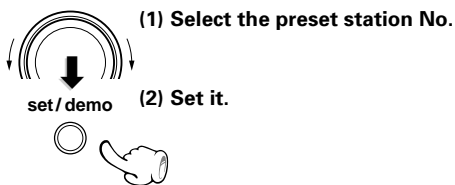

- When the timer setting is completed by pressing the **set/demo** key, "COMPLETE !" is displayed.
- When "PLAY" is selected, the timer playback will start at the volume setting used at the moment the unit is set to the Standby mode.

④ Select the broadcast station (only when TUNER is selected above).

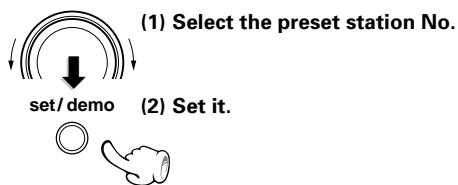

- When the timer setting is completed by pressing the **set/demo** key, "COMPLETE !" is displayed.
- The sound is muted during timer recording. If you want to monitor the recorded sound, turn the **volume/multi control** knob (or press the **VOLUME** key on the remote) to adjust the volume.



To check or modify the reservation contents, restart the timer reservation from the beginning.

5 Reserve the timer operation.

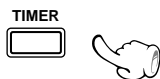

6 Put the unit in standby mode.

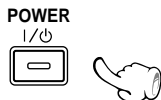

Each press switches the timer as follows.

- ① "O.T.T."
- ② "PROG. 1"
- ③ "PROG. 2"
- ④ "PROG. 1 2"
- ⑤ Extinguished

- Press the **TIMER** key on the remote repeatedly until "PROG. 1", "PROG. 2" or "PROG. 1 2" lights.
- To cancel timer reservation after it has been activated, press the **TIMER** key while the unit is on so that all of the timer-related indicators are turned off. (The setting made above is still left in memory.)

- When the unit enters the Standby mode, the **standby/timer** indicator lights in green.
- If there is a power failure or the power cord is unplugged after the timer reservation has been activated, the **standby/timer** indicator blinks in green. In this case, the clock setting should be restarted from the beginning.

Maintenance

Cleaning the head section

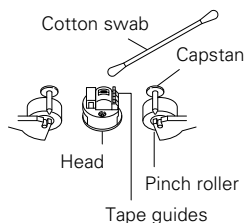

Cleaning the heads and peripheral components

Cleaning the heads and peripheral components

For maintaining the best condition of the deck and for longer service life, always keep the heads, capstan and pinch roller clean. To clean them, perform the following:

1. Open the cassette holder.
2. Using a cotton swab dipped in alcohol, clean the head, capstan and pinch roller carefully.

Demagnetizing the head

When the recording / playback head is magnetized, the sound quality will deteriorate. In such a case, demagnetize the head using a commercially available demagnetizer (head eraser).



There are precisely aligned parts around the heads, including the tape guides. When cleaning, pay special attention so as not to apply shock to them.

Maintenance of the unit

When the front panel or case becomes dirty, wipe with a soft, dry cloth. Do not use thinner, benzene, alcohol, etc. for these agents may cause discoloration.

In regard to contact cleaner

Do not use contact cleaners because it could cause a malfunction. Be specially careful not to use contact cleaners containing oil, for they may deform the plastic component.

Reference

Caution on condensation

Condensation (of dew) may occur inside the unit when there is a great difference in temperature between this unit and the outside.

This unit may not function properly if condensation occurs. In this case, leave the unit for a few hours and restart the operation after the condensation has dried up. Be specially cautious against condensation in a following circumstance:

When this unit is carried from a place to another across a large difference in temperature, when the humidity in the room where this unit is installed increases, etc.

Note related to transportation and movement

Before transporting or moving this unit, carry out the following operations.

- 1 Remove the CD from the unit.
- 2 Press the CD ►/II key.

CD NO DISC

- 3 Wait for some time and verify that the display becomes as shown in the figure.
- 4 Wait a few seconds and turn the unit OFF.

Memory backup function

Stored contents which are cleared immediately when power plug is unplugged from power outlet :

Clock display

Stored contents which are cleared in at least a day after power plug is unplugged from power outlet :

Amplifier section

"on/standby" status (ON or STANDBY), Last input selection, Volume control value, Tone control levels, AUX input level, Setting auto power save

Tuner section

Receiving band, Frequency, Preset stations, Auto/mono setting, Timer setting contents

Cassette deck section

Transport direction, Tape EQ., Reverse mode

Disc handling precautions

Handling

Hold the discs so that you do not touch the playing surface.

Do not attach paper or tape to either the playing side or the label side of the discs.

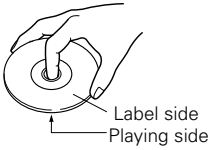

Cleaning

If fingerprints or foreign matter become attached to the disc, lightly wipe the disc with a soft cotton cloth (or similar) from the center of the disc outwards in a radial manner.

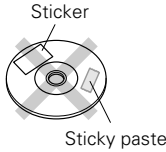

Storage

When a disc is not to be played for a long period of time, remove it from the player and store it in its case.

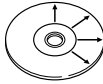

Never play a cracked or warped disc

During playback, the disc rotates at high speed in the player. Therefore, to avoid danger, never use a cracked or deformed disc or a disc repaired with tape or adhesive agent. Please do not use discs which are not round because they may cause a malfunction.

Disc accessories

The disc accessories (stabilizer, protection sheet, protection ring, etc.) which are marketed for improving the sound quality or protecting discs as well as the disc cleaner should not be used with this system because they may cause malfunction.

Discs which can be played with this unit

CD (12 cm, 8 cm) and the audio part of CD-G, CD-EG and CD-EXTRA. Use discs that comply with the IEC standard, for example a disc carrying the  marking on the label surface.

Notes on cassette tape

Safety tab (accidental erasure prevention tab)

After an important recording has been finished, break the safety tab, to prevent the recorded contents from being erased or recorded on accidentally.

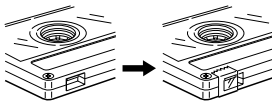
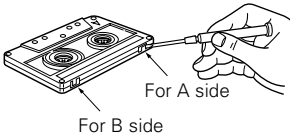

To re-record

Apply tape only to the position where the tab has been removed.

To store cassette tapes

Do not store the tapes in a place which is subject to direct sunlight, or near equipment that generates heat. Keep the cassette tapes away from any magnetic field.

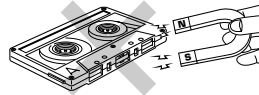

When there is slack in the tape

In such a case, insert a pencil into the reel hole and wind the reel hub to remove the slack.

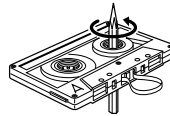

1. Longer tape than 90 minutes cassette tape

Do not use a cassette with more than 90-minute recording time, for the tape used with such a cassette is very thin and tends to cause troubles such as entanglement around the pinch roller or cutting of tape.

2. Endless tapes

Do not use an endless tape, as this could damage the mechanism of the unit.

WARNING NOTICE:

In most cases it is an infringement of copyright to make copies of tapes or discs without the permission of the copyright owners. Anyone wishing to copy commercially available tapes or disc should contact the mechanical copyright protection society limited or the performing rights society limited.

What seems to be a malfunction is not always so. Before calling for service, check the following table according to the symptom of your trouble.

Operation to reset

The microcomputer may fall into malfunction (impossibility to operate, erroneous display, etc.) when the power cord is unplugged while unit is ON or due to an external factor. In this case, execute the following procedure to reset the microcomputer and return it to normal condition.

- Please note that resetting the microcomputer clears the contents stored in and it returns to condition when it left the factory.

Unplug the power cord from the power outlet then, while holding the Power I / ⏻ key depressed, plug the power cord again.

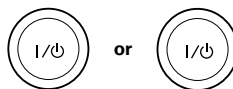

Power



Amplifier section/Speakers

Symptom	Remedy
Sound is not produced.	<ul style="list-style-type: none"> ● Connect properly referring to "System connections". → 6 ● Adjust to an required volume. ● Switch MUTE OFF. → 15 ● Unplug the headphone plug.
The "standby/timer" indicator blinks in red and no sound is put out.	<ul style="list-style-type: none"> ● A speaker cord is short-circuited. Turn power off and re-connect the speaker cord.
The "standby/timer" indicator blinks in amber.	<ul style="list-style-type: none"> ● Adjust the present time again. → 40
No sound from the headphones.	<ul style="list-style-type: none"> ● Insert correctly. → 15 ● Adjust to an required volume. → 14
Sound is not produced from the left or right speakers.	<ul style="list-style-type: none"> ● Connect properly referring to "System connections". → 6
The clock display blinks without changing the figures.	<ul style="list-style-type: none"> ● Adjust the present time again. → 40
Timer operation is not possible.	<ul style="list-style-type: none"> ● Adjust the present time referring to "Clock adjustment". → 40 ● Set the timer ON time and OFF time. → 45 ● Press the TIMER key to set up the execution. → 43 → 46

Tuner section

Symptom	Remedy
Radio stations cannot be received.	<ul style="list-style-type: none"> ● Connect antennas. → 7 ● Select a band. → 22 ● Tune to the frequency of the desired station. → 22
Noise interferes.	<ul style="list-style-type: none"> ● Install the outdoor antenna in an apart position from the road. ● Switch the suspected electric appliance OFF. ● Install the TV or the system at an increased distance between them.
A station has been preset but it cannot be received by pressing the P.CALL key.	<ul style="list-style-type: none"> ● Preset stations with tunable frequencies. → 23 ● Preset stations again. → 23

CD player section

Symptom	Remedy
A CD is placed in the player but it cannot be played.	<ul style="list-style-type: none"> Place the disc properly, with the label side facing upward. Clean the disc referring to "Disc handling precautions". → 48 Refer to "Caution on condensation" and remove the condensation by evaporation. → 47
Sound is not produced.	<ul style="list-style-type: none"> Press the CD ▶/II key. Clean the disc referring to "Disc handling precautions". → 48
Sound skips.	<ul style="list-style-type: none"> Clean the disc referring to "Disc handling precautions". → 48 Install the unit in a place not subject to vibrations.

Cassette deck section

Symptom	Remedy
Sound cannot be produced by pressing the play key.	<ul style="list-style-type: none"> Clean the head referring to "Maintenance". → 47 The tape is wound too tight due to irregular winding. Play a recorded tape.
No operation occurs even when an operation key is pressed.	<ul style="list-style-type: none"> Press operation keys in more than a few seconds after closing the cassette holder. → 20 Change the tape transport direction or reverse the tape insertion orientation. → 20
The cassette holder cannot be opened by pressing " ▲ push open ".	<ul style="list-style-type: none"> Press in stop mode. Reset the microcomputer. → 49
Sound is harsh or high frequencies are not reproduced.	<ul style="list-style-type: none"> Clean the head referring to "Maintenance". → 47 Try another tape.
Sound is distorted.	<ul style="list-style-type: none"> The recording level is not set properly (when the AUX input is recorded). Adjust the AUX input level. → 38
Noise is noticeable.	<ul style="list-style-type: none"> Demagnetize the head referring to "Maintenance". → 47 Install the system at a distance from other electric appliances and TV. Set the TAPE EQ. to on. → 21
Sound vibrates.	<ul style="list-style-type: none"> Clean the head referring to "Maintenance". → 47 Wind the tape again by fast forwarding, rewinding or playing from an end to the other. → 20 → 21
Recording cannot be started by pressing the record key.	<ul style="list-style-type: none"> Use a cassette with an unbroken recording protect tab or block the hole. → 48 Close the holder completely. → 20 Set the input selector to the source to be recorded. → 29 Change the tape transport direction or reverse the tape insertion orientation. → 20

Remote control unit

Symptom	Remedy
Remote control operation is not possible.	<ul style="list-style-type: none"> Replace with new batteries. → 13 Operate the unit inside the remote controllable range. → 13

Displayed messages and actions to be taken against them

Displayed Message	Meaning
PGM FULL	<ul style="list-style-type: none"> An attempt is made to select a 33rd track during programming of CD.
PGM Mode	<ul style="list-style-type: none"> An attempt is made to start random playback in the program mode. Exit from the program mode before random playback. → [32]
RANDOM Mode	<ul style="list-style-type: none"> An attempt is made to perform TAPE O.T.E. recording while the unit is in the CD random play mode. Exit from the random play mode. → [34]
TEXT FULL	<ul style="list-style-type: none"> An attempt is made to display the text data of a CD-TEXT disc containing more than 1 kB of text data.

For the U.S.A.**Note to CATV system installer**

This reminder is provided to call the CATV system installer's attention to Article 820-40 of the NEC that provides guidelines for proper grounding and, in particular, specifies that the cable ground shall be connected to the grounding system of the building, as close to the point of cable entry as practical.

Main unit

[Amplifier section]

(For U.S.A. and Canada)

Rated output power during STEREO operation (FTC)

21 watts per channel minimum RMS, both channels driven, at 6 Ω from 90 Hz to 15 kHz with no more than 10 % total harmonic distortion.

(For U.K. and Europe)

Effective output power during STEREO operation
(1 kHz, 10% T.H.D., at 6 Ω) 25 W + 25 W

Rated output power during STEREO operation
(1 kHz, 0.7% T.H.D., at 6 Ω) 18 W + 18 W

(For Singapore)

Rated output power during STEREO operation
(1 kHz, 10% T.H.D., at 6 Ω) 20 W + 20 W

(For other countries)

Rated output power during STEREO operation
(1 kHz, 10% T.H.D., at 6 Ω) 25 W + 25 W

Frequency response

AUX 40 Hz~50 kHz (0 dB ~ -3dB)

[Tuner section]

FM tuner section

Tuning frequency range 87.5 MHz ~ 108 MHz

MW (AM) tuner section

(For U.S.A. and Canada)

Tuning frequency range 530 kHz ~ 1,700 kHz

(For U.K. and Europe)

Tuning frequency range 531 kHz ~ 1,602 kHz

(For Australia)

Tuning frequency range 531 kHz ~ 1,602 kHz

(For other countries)

Tuning frequency range
9 kHz step 531 kHz ~ 1,602 kHz
10 kHz step 530 kHz ~ 1,610 kHz

[CD player section]

Laser Semiconductor laser

Over sampling 8 fs (352.8 Hz)

Laser wave length 760 to 800 nm

Laser power class Class 3A (IEC)

D/A Conversion 1 Bit

[Cassette deck section]

Track 4-track, 2-channel stereo

Recording system AC bias system
(Frequency: 105 kHz)

Heads

Playback/ recording head 1

Erasing head 1

Motor 1

Wow and flutter 0.2 % (W.R.M.S.)

Fast winding time Approx. 110 seconds
(C-60 tape)

[General]

Power consumption

(For U.S.A., Canada and Singapore) 70 W

(For other countries) 80 W

Dimensions W : 180 mm (7-1/16")

H : 255 mm (8-7/16")

D : 317 mm (12-7/16")

Weight (net) 5.1 kg (11.2 lb)

Speakers

Enclosure Bass-reflex type

Speaker configuration

Woofers 120 mm, cone type

Tweeter 25 mm, dome type

Impedance 6 Ω

Maximum input level 30 W

Dimensions W : 150 mm (5-7/8")

H : 255 mm (10-1/16")

D : 215 mm (8-7/16")

Weight (net) 2.3 kg (5.1 lb) (1 piece)



KENWOOD follows a policy of continuous advancements in development. For this reason specifications may be changed without notice.

- Sufficient performance may not be exhibited at extremely cold locations (where water freezes).

For your records

Record the serial number, found on the back of the unit, in the spaces designated on the warranty card, and in the space provided below. Refer to the model and serial numbers whenever you call upon your dealer for information or service on this product.

Model _____ Serial Number _____

KENWOOD

Free Manuals Download Website

<http://myh66.com>

<http://usermanuals.us>

<http://www.somanuals.com>

<http://www.4manuals.cc>

<http://www.manual-lib.com>

<http://www.404manual.com>

<http://www.luxmanual.com>

<http://aubethermostatmanual.com>

Golf course search by state

<http://golfingnear.com>

Email search by domain

<http://emailbydomain.com>

Auto manuals search

<http://auto.somanuals.com>

TV manuals search

<http://tv.somanuals.com>