

KENWOOD

AUDIO VIDEO SURROUND RECEIVER

KRF-V7090D

INSTRUCTION MANUAL

KENWOOD CORPORATION

About the supplied remote control

Compared to standard remote controls, the remote control supplied with this model has several operation modes. These modes enable the remote control unit to control other KENWOOD DVD players. In order to effectively use the remote control it is important to read the operating instructions and obtain a proper understanding of the remote control and how to switch its operation modes (etc.). Using the remote control without completely understanding its design and how to switch the operation modes may result in incorrect operations.

ENGLISH

FRANÇAIS

DEUTSCH

NEDERLANDS

ITALIANO

ESPAÑOL



6CH INPUT



Before applying the power

 **Caution : Read this page carefully to ensure safe operation.**

Units are designed for operation as follows.

U.S.A. and Canada AC 120 V only
Australia AC 240 V only
Europe AC 230 V only
Other countries AC 110-120 / 220-240 V switchable

ENGLISH

Safety precautions

WARNING :

TO PREVENT FIRE OR ELECTRIC SHOCK,
DO NOT EXPOSE THIS APPLIANCE TO
RAIN OR MOISTURE.



CAUTION
RISK OF ELECTRIC SHOCK
DO NOT OPEN



CAUTION: TO REDUCE THE RISK OF ELECTRIC SHOCK, DO NOT REMOVE COVER (OR BACK). NO USER-SERVICEABLE PARTS INSIDE. REFER SERVICING TO QUALIFIED SERVICE PERSONNEL.



THE LIGHTNING FLASH WITH ARROWHEAD SYMBOL, WITHIN AN EQUILATERAL TRIANGLE, IS INTENDED TO ALERT THE USER TO THE PRESENCE OF UNINSULATED "DANGEROUS VOLTAGE" WITHIN THE PRODUCT'S ENCLOSURE THAT MAY BE OF SUFFICIENT MAGNITUDE TO CONSTITUTE A RISK OF ELECTRIC SHOCK TO PERSONS.



THE EXCLAMATION POINT WITHIN AN EQUILATERAL TRIANGLE IS INTENDED TO ALERT THE USER TO THE PRESENCE OF IMPORTANT OPERATING AND MAINTENANCE (SERVICING) INSTRUCTIONS IN THE LITERATURE ACCOMPANYING THE APPLIANCE.

How to use this manual

This manual is divided into four sections, Preparations, Operations, Remote Control, and Additional Information.

Preparations

Shows you how to connect your audio and video components to this model and prepare the surround processor.

Since this model works with all your audio and video components, kindly follow the instructions in this manual for the correct connections.

Operations

Shows you how to operate the various functions available on this model.

Remote Control

Shows you how to operate other components using the remote control, as well as a detailed explanation of all remote control operations. Once you have setup the remote control, you'll be able to operate both this model and your KENWOOD DVD player using the remote control supplied with this model.

Additional Information

Shows you additional information such as "In case of difficulty" (troubleshooting) and "Specifications".

Maintenance of the unit



When the front panel or case becomes dirty, wipe with a soft, dry cloth. Do not use thinner, benzine, alcohol, etc. for these agents may cause discoloration.

In regard to contact cleaner

Do not use contact cleaners because it could cause a malfunction. Be specially careful not to use contact cleaners containing oil, for they may deform the plastic component.

Contents

Caution : Read the pages marked  carefully to ensure safe operation.

	Before applying the power	2
	Safety precautions	2
	How to use this manual	2
	Unpacking	4
	Preparing the remote control	4
	Special features	5
	Names and functions of parts	6
	Main Unit	6
	Remote control unit	7

Remote Control

Basic remote control operations for KENWOOD DVD players	36
DVD player operation keys	36

Additional Information

In case of difficulty	37
 Specifications	39

Preparations

Setting up the system	8
Connecting the terminals	9
Connecting a DVD player (6-channel input)	10
Connecting audio components	11
Connecting video components	12
Digital connections	13
Connecting video components (COMPONENT VIDEO)	14
Connecting the speakers	15
Connecting to the AV AUX jacks	16
Connecting the antennas	16
Preparing for surround sound	17
Speaker settings	17

Operations

Normal playback	20
Preparing for playback	20
Listening to a source component	20
Input level adjustment (analog sources only) ..	21
Adjusting the sound	21
Recording	22
Recording audio (analog sources)	22
Recording video	22
Recording audio (digital sources)	23
Listening to radio broadcasts	24
Tuning (non-RDS) radio stations	24
Using RDS (Radio Data System)	24
Presetting radio stations manually	25
Receiving preset stations	25
Receiving preset stations in order (P.CALL) ...	25
Using the RDS DISP (Display) key	26
Presetting RDS stations (RDS AUTO MEMORY)	26
Tuning by Program TYpe (PTY search)	27
Ambience effects	28
Surround modes	28
Surround play	30
DVD 6-channel playback	32
Convenient functions	32
Adjusting the sound	32
Display dimmer adjustment	34
Sleep timer	34

Unpacking

Unpack the unit carefully and make sure that all accessories are present.

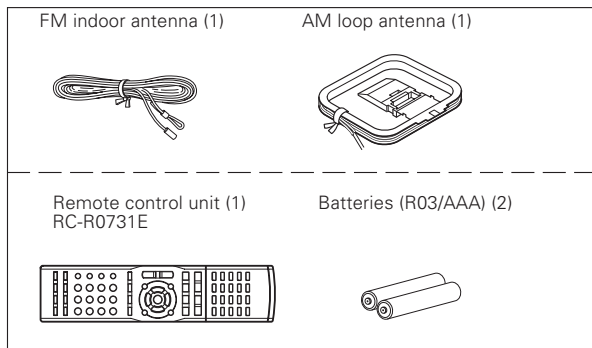

If any accessories are missing, or if the unit is damaged or fails to operate, notify your dealer immediately. If the unit was shipped to you directly, notify your shipper immediately. Kenwood recommends that you retain the original carton and packing materials in case you need to move or ship the unit in the future.

Keep this manual handy for future reference.

Preparing the remote control

Loading the batteries

① Remove the cover.

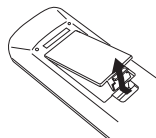

② Insert the batteries.

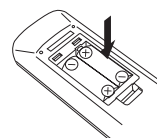

③ Close the cover.

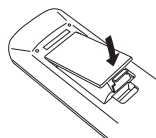

- Insert two AAA-size (R03) batteries as indicated by the polarity markings.

Operation

When the standby indicator is lit, the power turns ON when you press the **RECEIVER ON** key on the remote control. When the power comes ON, press the key you want to operate.

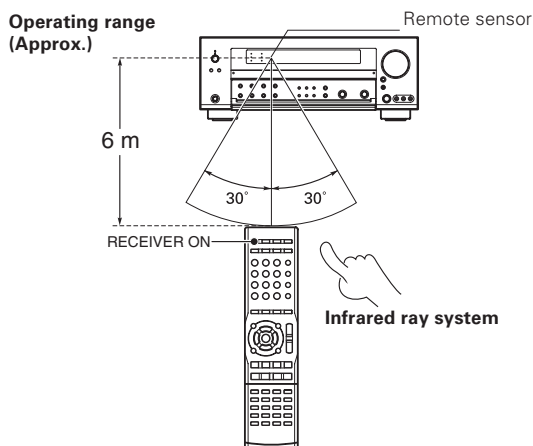

- When pressing more than one remote control key successively, press the keys securely by leaving an interval of 1 second or more between keys.

Notes

1. The supplied batteries may have shorter lives than ordinary batteries due to use during operation checks.
2. When the remote-controllable distance gets shorter than before, replace both batteries with new ones.
3. Placing the remote sensor in direct sunlight, or in direct light from a high frequency fluorescent lamp may cause a malfunction. In such a case, change the location of the system installation to prevent malfunction.

Special features

True home theater sound

— 28

This model incorporates a wide variety of surround modes to bring you maximum enjoyment from your video software. Select a surround mode according to your equipment or the software you are going to play and enjoy!

- Dolby Digital EX
- Dolby Pro Logic IIx, Dolby Pro Logic II
- Dolby Digital
- DTS-ES
- DTS Neo:6
- DTS 96/24
- DTS
- DSP Mode

ACTIVE EQ

ACTIVE EQ mode will produce a more dynamic sound quality in any condition. You can enjoy a more impressive sound effect when ACTIVE EQ is turned on.

GAME mode function

— 29

When you connect a game machine to the **AV AUX** jacks on the front panel, the input selector of the receiver switches automatically to "GAME" and the optimum sound field for enjoying games is set. This feature improves your convenience in playing video games.

IR (InfraRed) remote control

In addition to the basic receiver operations, this IR remote control supplied can also control KENWOOD DVD players directly without using the DVD Special features.

RDS (Radio Data System) tuner

This model is equipped with an RDS tuner that provides several convenient tuning functions: RDS Auto Memory, to automatically preset up to 40 RDS stations broadcasting different programs; station name display, to show you the name of the current broadcast station; and PTY search to let you tune stations by program type.

PTY (Program TYPe) search

Tune the stations by specifying the type of program you want to hear.

Names and functions of parts

Main unit

*Input channel indicators

Input channel indicators light up according to the incoming audio signals. "S" indicator will light up when the surround component of the audio signals is only 1 channel.

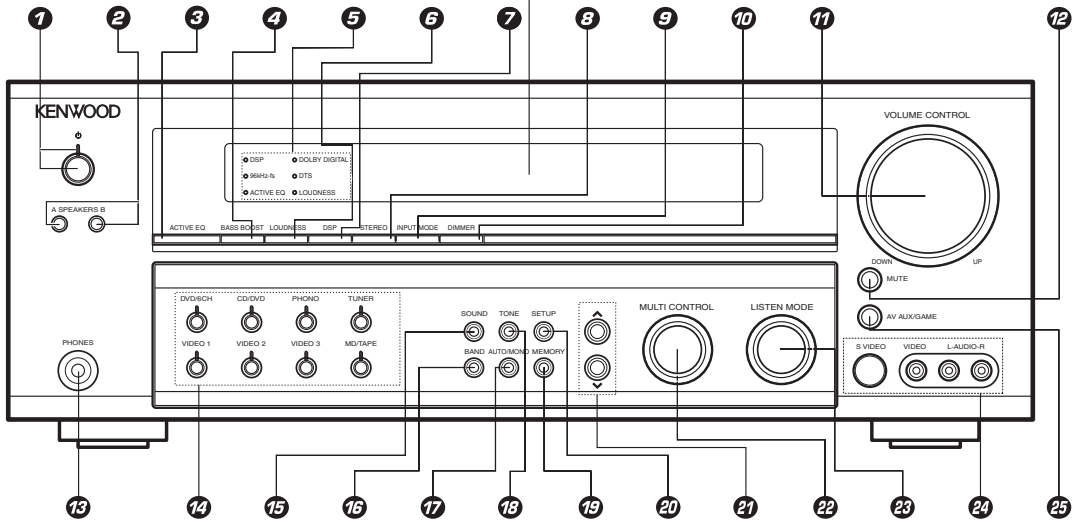
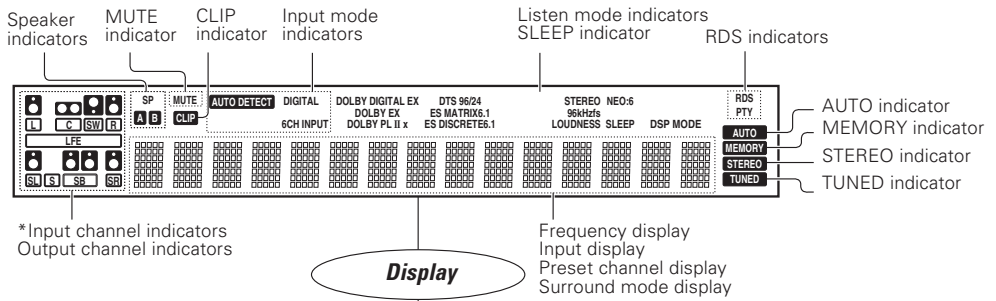

- | | | |
|---|--|---|
| 1 POWER ON/STANDBY key
Use to turn the power ON/STANDBY.
Standby indicator | 17 DSP key
Use to select any of the DSP mode. | 21 TONE key
Use to switch the status of TONE control. |
| 2 SPEAKERS A/B keys
Use to turn the A/B speakers on or off. | 18 PHONES jack
Use for headphone listening. | 22 MEMORY key
Use to store radio stations in the preset memory and to start the Auto Memory. |
| 3 ACTIVE EQ key
Use to select ACTIVE EQ setting. | 19 Input Selector keys (DVD/6CH, CD/DVD, PHONO, TUNER, VIDEO 1, VIDEO 2, VIDEO 3, MD/TAPE)
Use to select the input sources. | 23 SETUP key
Use to select the speakers' settings etc. |
| 4 BASS BOOST key
Use to select BASS BOOST setting. | 20 SOUND key
Use to adjust the sound quality and the ambience effects. | 24 AV AUX (S VIDEO, VIDEO, L-AUDIO-R) jacks |
| 5 Surround LED (lighting-emitting diode) indicators
DSP mode indicator
Lights when the receiver is in the DSP mode.
96kHz fs mode indicator
Lights when the receiver is in the 96kHz LPCM playback mode.
ACTIVE EQ mode indicator
Lights when the receiver is in the ACTIVE EQ mode.
DOLBY DIGITAL mode indicator
Lights when the receiver is in the Dolby Digital mode.
DTS mode indicator
Lights when the receiver is in the DTS mode.
LOUDNESS indicator
Lights when the LOUDNESS is ON. | 21 MUTE key
Use to temporarily mute the sound. | 25 AV AUX/GAME key
Use to switch the input to AV AUX or GAME. |
| 6 LOUDNESS key
Use to switch the status of LOUDNESS. | 22 BAND key
Use to select the broadcast band. | |
| | 23 AUTO/MONO key
Use to select the auto or manual tuning mode. | |

Standby mode

While the standby indicator is lit, a small amount of power is supplied to the system to back up the memory. This is called standby mode. Under the condition, the system can be turned ON by remote control unit.

Remote control unit

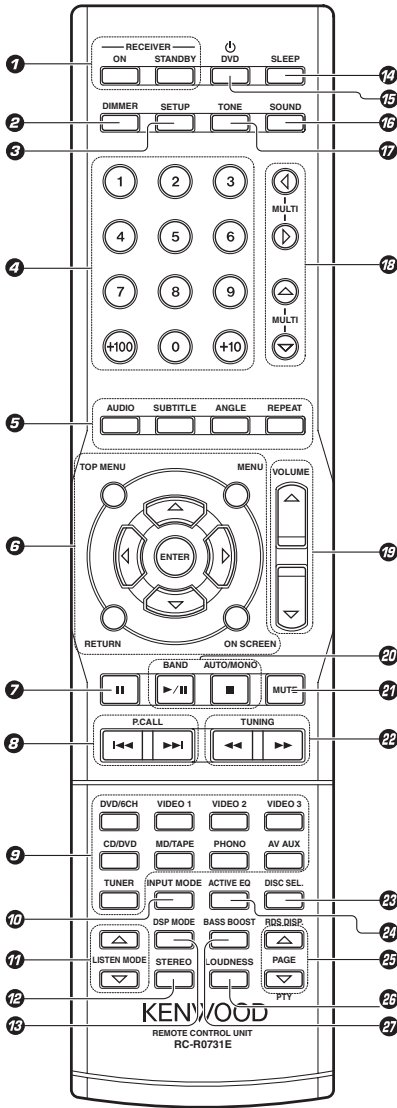

- 1 RECEIVER ON key** - [17]
Use to turn the receiver on.
- 2 RECEIVER STANDBY key** - [17]
Use to turn the receiver off (standby).
- 3 DIMMER key** - [32]
Use to adjust the brightness of the display.
- 4 DVD key** - [32]
Use to operate the DVD player.
- 5 SETUP key** - [17]
Use to select the speakers' settings etc.
- 6 Numeric keys** - [25]
Use to select preset radio stations.
- 7 AUDIO key** - [20]
SUBTITLE key
ANGLE key
REPEAT key
Use to operate the DVD player.
- 8 $\Delta/\nabla/\leftarrow/\rightarrow$ keys** - [25]
TOP MENU key
MENU key
RETURN key
ON SCREEN key
ENTER key
Use to operate the DVD player.
- 9 II key** - [25]
Use to operate the DVD player.
- 10 P.CALL $\leftarrow\leftarrow/\rightarrow\rightarrow$ keys** - [25]
Use for selection adjustments during sound, set up and preset channel functions.
- 11 Input Selector keys (DVD/6CH, VIDEO 1, VIDEO 2, VIDEO 3, CD/DVD, MD/TAPE, PHONO, AV AUX, TUNER)** - [20]
Use to select the input sources.
- 12 INPUT MODE key** - [8]
Use to select the Input mode.
- 13 LISTEN MODE Δ/∇ keys** - [30]
Use to select the listening mode.
- 14 STEREO key** - [30]
Use to switch the listen mode to STEREO.
- 15 DSP MODE key** - [30]
Use to select any of the DSP mode.
- 16 SLEEP key** - [32]
Use to set the Sleep timer.
- 17 DVD key** - [32]
Use to turn the DVD player on or off.
- 18 SOUND key** - [32]
Use to adjust the sound quality and the ambience effects.
- 19 TONE key** - [21]
Use to switch the status of TONE control.
- 20 MULTI $\triangleright/\triangleleft$ keys** - [21]
MULTI Δ/∇ keys
Use to control a variety of settings.
- 21 VOLUME Δ/∇ keys** - [20]
Use to adjust the receiver's volume.
- 22 BAND key** - [24]
Use to select the broadcast band.
- 23 \triangleright/\parallel key** - [24]
Use to operate the DVD player.
- 24 AUTO/MONO key** - [24]
Use to select the auto or manual tuning mode.
- 25 ■ key** - [24]
Use to operate the DVD player.
- 26 MUTE key** - [21]
Use to temporarily mute the sound.
- 27 TUNING $\leftarrow\leftarrow/\rightarrow\rightarrow$ keys** - [24]
Use to operate the tuner mode.
- 28 DISC SEL. key** - [21]
Use to operate the DVD player.
- 29 ACTIVE EQ key** - [21]
Use to select ACTIVE EQ's setting.
- 30 PAGE Δ/∇ keys** - [26]
Use to operate the DVD player.
- 31 RDS DISP. key** - [26]
Use to receive RDS broadcast.
- 32 PTY key** - [27]
Use for PTY search.
- 33 LOUDNESS key** - [21]
Use to switch the status of LOUDNESS.
- 34 BASS BOOST key** - [21]
Use to select the maximum adjustment setting for the low frequency range.

• Some keys can be used for operating KENWOOD DVD players by pressing CD/DVD or DVD/6CH key beforehand. - [36]

Setting up the system

Make connections as shown in the following pages. When connecting the related system components, be sure to refer to the instruction manuals supplied with the components you are connecting. Do not connect the power cord to a wall outlet until all connections are completed.

Notes

1. Be sure to insert all connection cords securely. If their connections are imperfect, sound may not be produced or there will be noise inference.
2. Be sure to remove the power cord from the AC outlet before plugging or unplugging any connection cords. Plugging/unplugging connection cords without disconnecting the power cord can cause malfunctions and may damage the unit.
3. Do not connect power cords from components whose power consumption is larger than what is indicated on the AC outlet at the rear of this unit.

Analog connections

Audio connections are made using RCA pin cords. These cables transfer stereo audio signal in an "analog" form. This means the audio signal corresponds to the actual audio of two channels. These cables usually have 2 plugs on each end, one red for the right channel and one white for the left channel. These cables are usually packed together with the source unit, or are available at your local electronics retailer.

Microcomputer malfunction

If operation is not possible or an erroneous display appears, even though all connections have been made properly, reset the microcomputer referring to "In case of difficulty". - [37]

Memory back up function

Please note that the following items will be deleted from the unit's memory if the power cord is disconnected from the AC outlet for approximately 1 day.

- Power mode
- Input selector settings
- Speaker ON/OFF
- Volume level
- BASS, TREBLE, INPUT level
- TONE ON/OFF
- LOUDNESS ON/OFF
- Dimmer level
- Listen mode setting
- Speaker settings
- Distance setting
- Input mode setting
- Sound mode settings
- Broadcast band
- Frequency setting
- Preset stations
- Tuning mode
- ACTIVE EQ mode
- GAME mode setting

Input mode settings

CD/DVD, VIDEO 2, VIDEO 3 and DVD/6CH inputs each include jacks for digital audio input and analog audio input.

The initial factory settings for audio signal playback for CD/DVD, DVD/6CH and VIDEO 2 and VIDEO 3 are FULL AUTO.

After completing connections and turning on this model, follow the steps below.

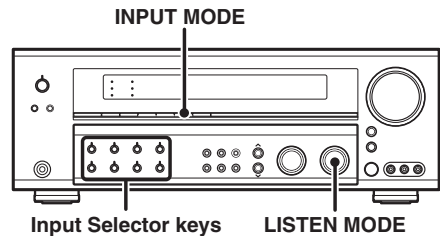

- 1 Use the Input Selector keys to select CD/DVD, VIDEO 2, VIDEO 3 or DVD/6CH.

- 2 Press the INPUT MODE key.

Each press switches the setting as follows:

In DTS play mode

- 1 FULL AUTO (digital input, analog input)
- 2 DIGITAL MANUAL (digital input)

In CD/DVD, VIDEO 2, VIDEO 3 or DVD/6CH play mode

- 1 FULL AUTO (digital input, analog input)
- 2 DIGITAL MANUAL (digital input)
- 3 6CH INPUT (DVD/6CH input only)
- 4 ANALOG (analog input)

Auto detect:

In FULL AUTO mode ("AUTO DETECT" indicator lights up), the receiver detects the digital or analog input signals automatically. The receiver will select the input mode and listening mode automatically during playback to match the type of input signal (Dolby Digital, PCM, DTS) and the speaker setting. - [30]

The "DIGITAL" indicator lights up when a digital signal is detected. The "DIGITAL" indicator is extinguished when no digital signal is detected.

Fixed to digital input:

Select this mode if you want to keep the decoding condition (Dolby Digital, DTS, PCM, etc.) in the current listen mode.

When DIGITAL MANUAL mode is selected, the set listen modes may be changed automatically depending on the input signal. - [30]

Fixed to analog input:

Select this setting to play analog signals from a VCR, etc.

If the INPUT MODE key is pressed quickly, sound may not be produced. Press the INPUT MODE key again.

Connecting the terminals

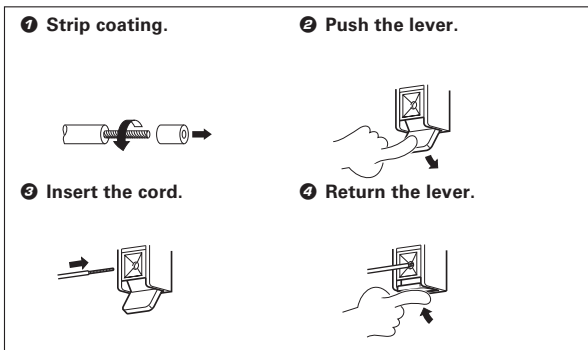
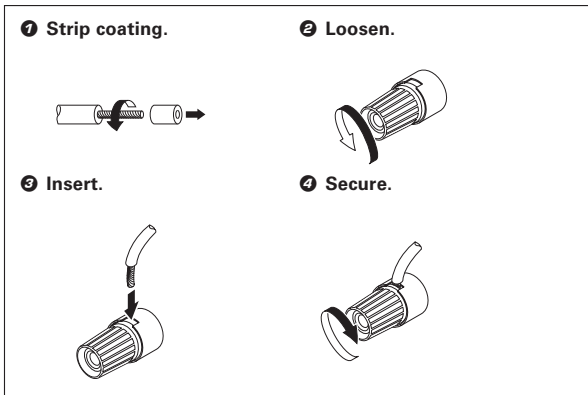

- Never short circuit the + and – speaker cords.
- If the left and right speakers are connected inversely or the speaker cords are connected with reversed polarity, the sound will be unnatural with ambiguous acoustic imaging. Be sure to connect the speakers correctly.

Speaker impedance

After confirming the speaker impedance indications printed on the rear panel of this model, connect speakers with matching impedance ratings. Using speakers with a rated impedance other than that indicated on the rear panel of this model could result in malfunctions or damage to the speakers or this model.

Speaker placement

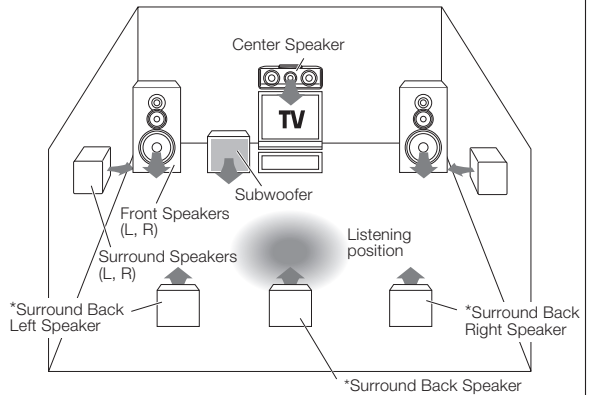

* For Surround Back Speaker, you may place either two Surround Back Speakers (Surround Back Left Speaker and Surround Back Right Speaker) for 7.1 channel surround sound system or one Surround Back Speaker for 6.1 channel surround sound system.

Front (left and right) Speakers

Place at the front left and right of the listening position. Front speakers are required for all surround modes.

Center Speaker

Place front and center. This speaker stabilizes the sound image and helps recreate sound motion. Required for surround playback.

Surround (left and right) Speakers

Place at the direct left and right, or slightly behind, the listening position at even heights, approximately 1 meter above the ears of the listeners. These speakers recreate sound motion and atmosphere.

Subwoofer

Usually, place the subwoofer in the front center position in the listening room, near one of the front speakers near the center speaker. (Since the subwoofer has less directivity than other speakers, it can be placed almost in any position that can offer the best low frequency reproduction according to the room layout.)

Surround Back Speaker/s

Place the surround back speaker behind the listening position, at the same height as the left and right surround speakers.

- Although the ideal surround system consists of all the speakers listed above, if you don't have a center speaker or a subwoofer, you can divide those signals between the available speakers in the speaker settings steps to obtain the best possible surround reproduction from the speakers you have available.

Connecting a DVD player (6-channel input)

If you have connected a DVD player to this model with digital connection, be sure to read the "Input mode settings" section carefully.



ENGLISH

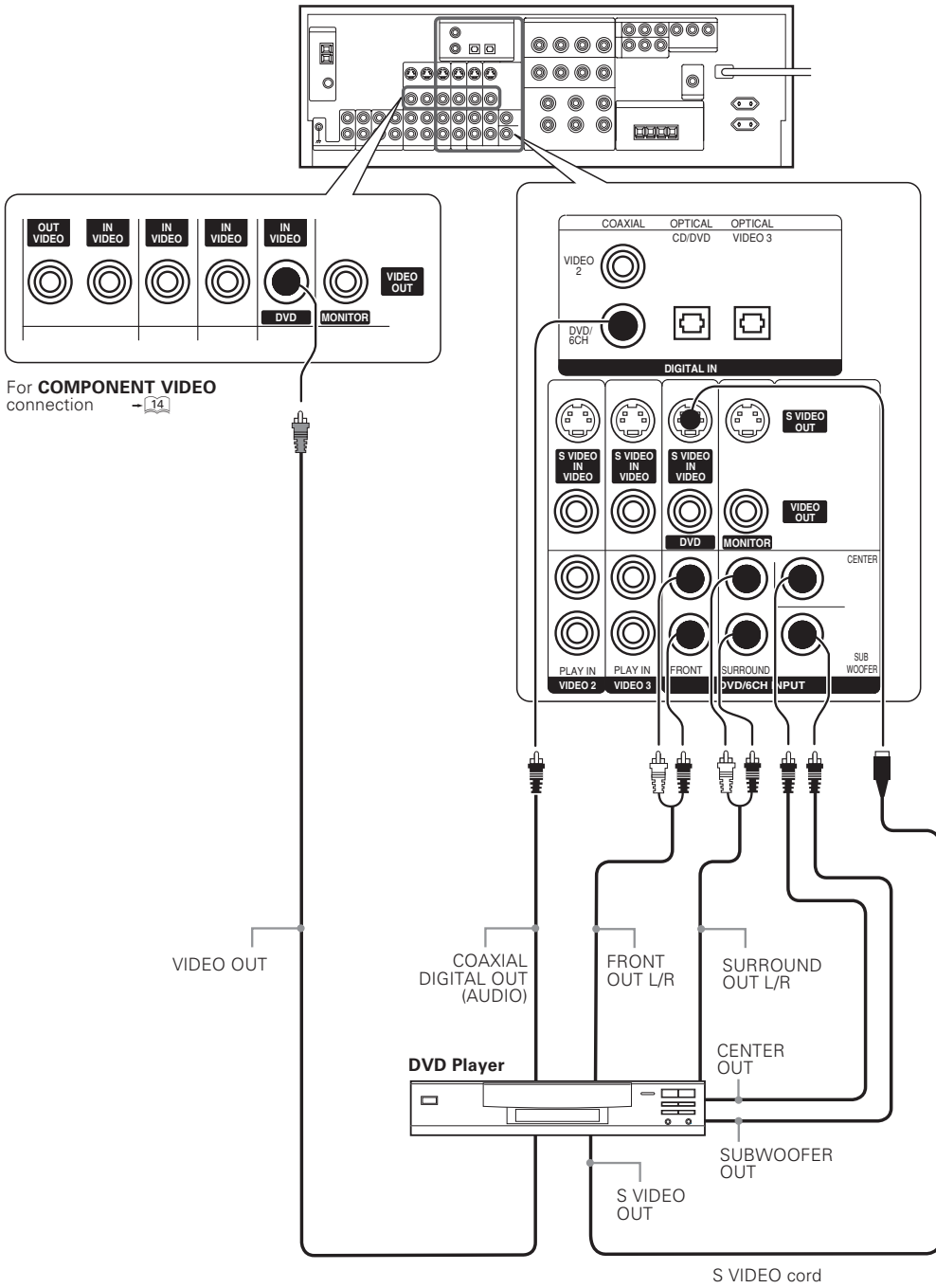

Connecting audio components

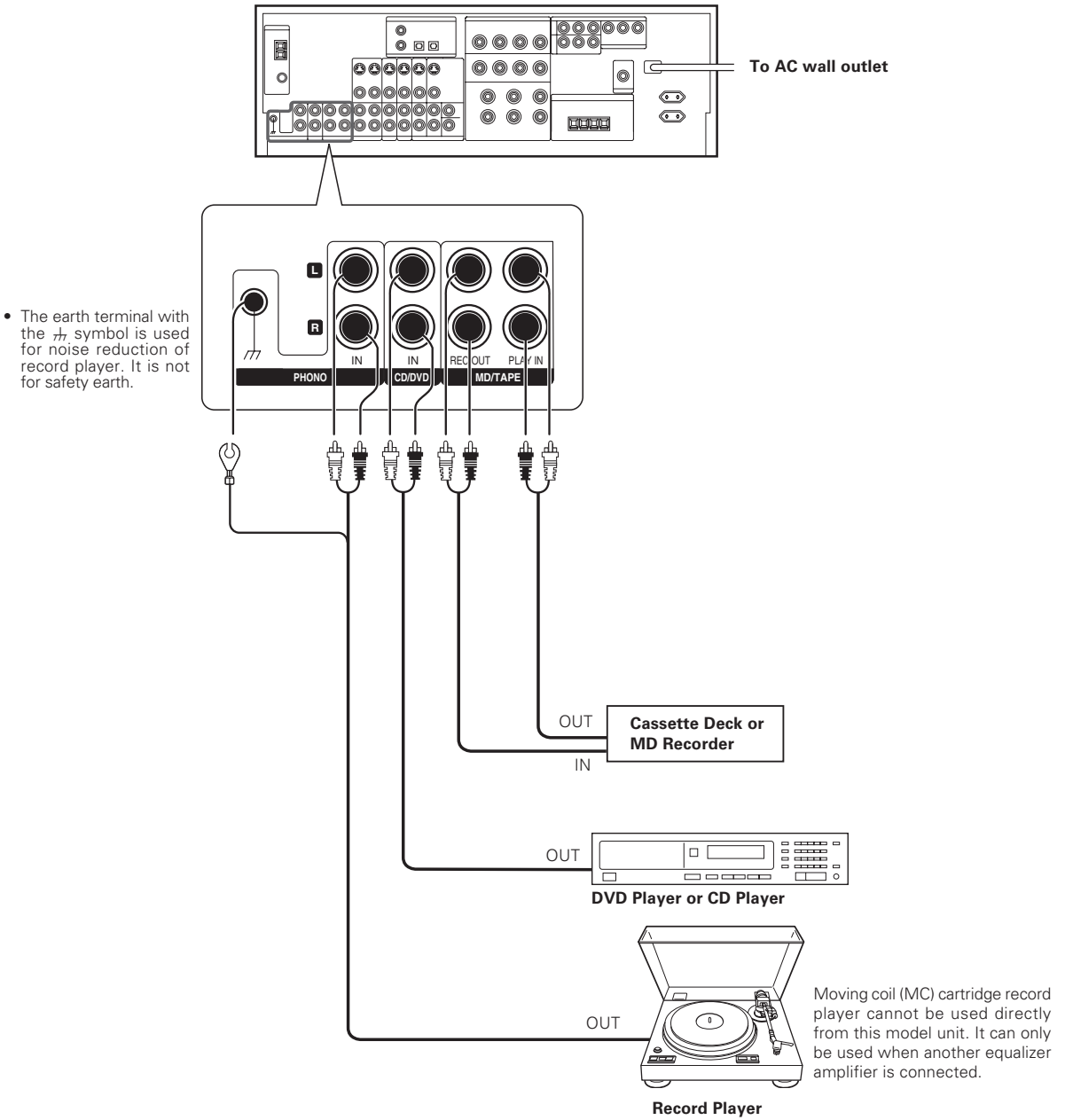

CAUTION

Be sure to adhere to the following, or proper ventilation will be blocked causing damage or fire hazard.

- Do not place any object impairing heat radiation onto the top of the unit.
- Leave a space around the unit (from the largest outside dimension including projection) equal or greater than, shown below.

Top panel : 50 cm

Side panel : 10 cm

Back panel : 10 cm

Connecting video components

ENGLISH

S Video Jacks

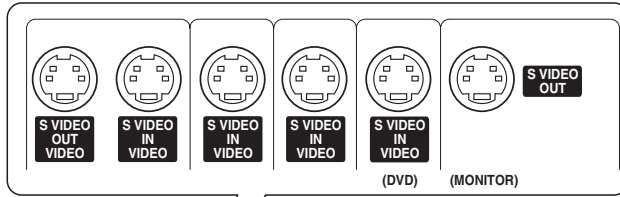

* DVD IN input jack is used for either CD/DVD input or DVD/6CH input.

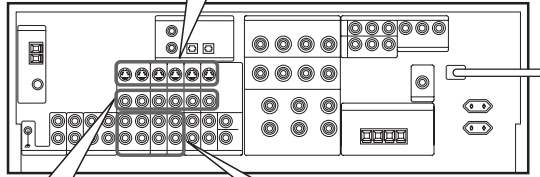

About the S VIDEO Jacks

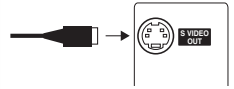

Use the S VIDEO Jacks to make connections to video components with S VIDEO IN/OUT Jacks.

- If you use the S VIDEO jacks to connect your video playback components, be sure to use the S VIDEO jacks when connecting your monitor and video recording components.

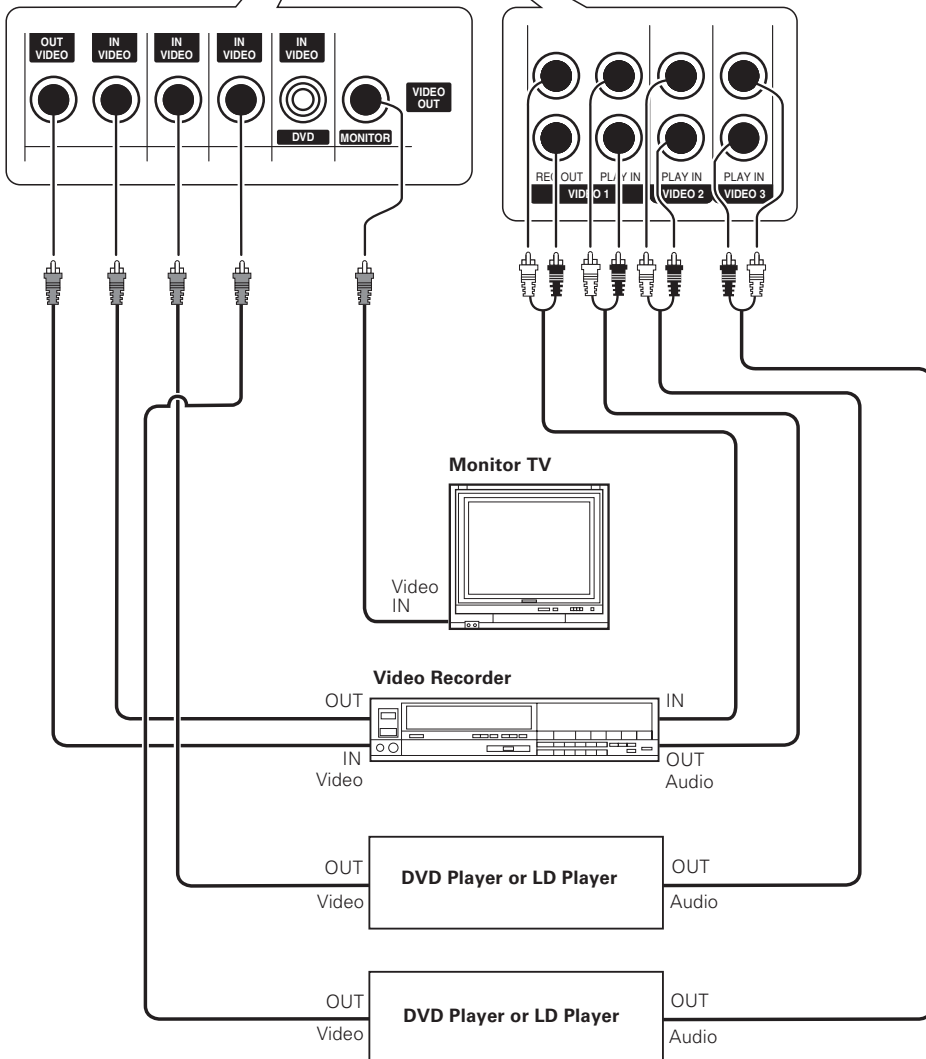

A video component with digital audio outputs should be connected to the VIDEO 2 or VIDEO 3 jacks.

Digital connections

The digital in jacks can accept DTS, Dolby Digital, or PCM signals. Connect components capable of outputting DTS, Dolby Digital, or standard PCM (CD) format digital signals.

If you have connected any digital components to this model, be sure to read the "Input mode settings" section carefully.

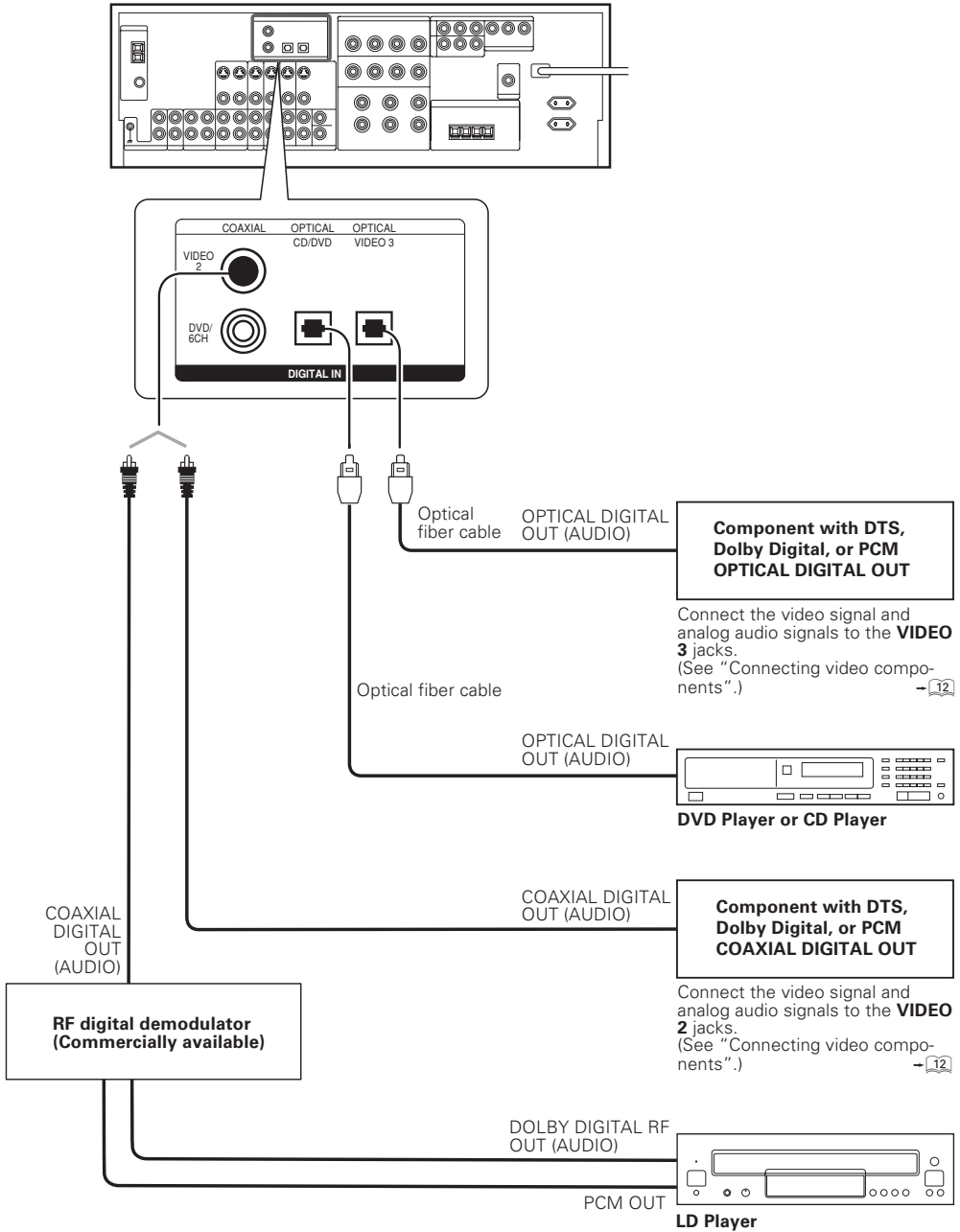

To connect an LD player with a DIGITAL RF OUT, connect the LD player to the RF digital demodulator (Commercially available). Next, connect the DIGITAL OUT jacks of the demodulator to the DIGITAL IN jacks of this model. Connect the video signal and analog audio signals to the VIDEO 2 or VIDEO 3 jacks. (See "Connecting video components".)

Connecting video components (COMPONENT VIDEO)

If you have connected this model to a video component with COMPONENT jacks, you can get a better picture quality than by connecting to the S-VIDEO jacks.

ENGLISH

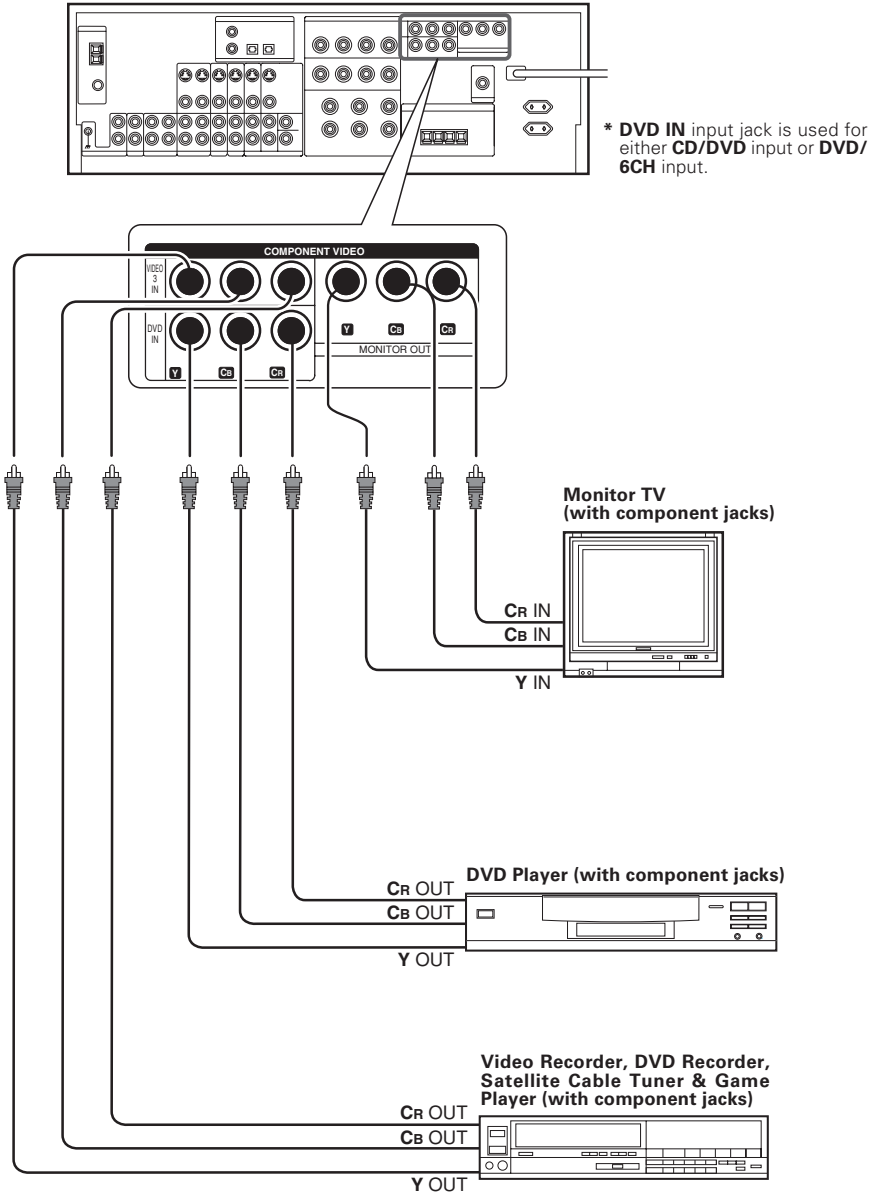

When connecting the TV to the COMPONENT jacks, be sure to connect all the other components to the COMPONENT jacks.

Connecting the speakers

Surround Back Speaker/s
When connecting a single Surround Back Speaker, connect it to SURROUND BACK L terminals and select "SB LARGEx1" or "SB NORMALx1" at Speaker settings. — 18

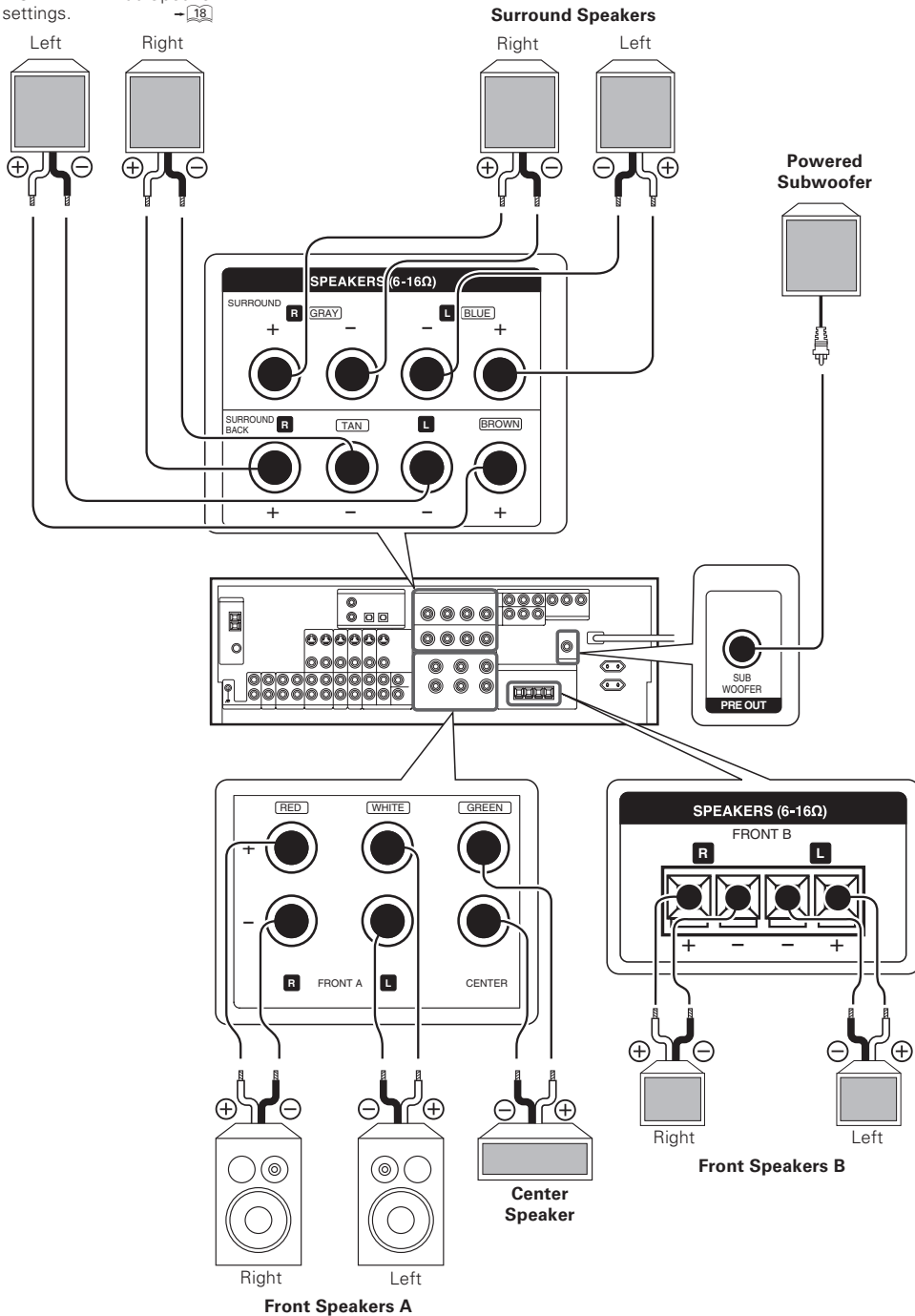

- To make sure that each speaker has been connected properly, pay attention to the test tone from each speaker. Refer to "Adjust the speaker volume level." — 18
- When you wish to connect the second pair of Front speakers or to connect the speakers in a different room to this unit, use the SPEAKERS FRONT B terminals for connection.

Connecting to the AV AUX jacks

The **AV AUX** jacks are convenient for connection of video components such as a camcorder or a video game.

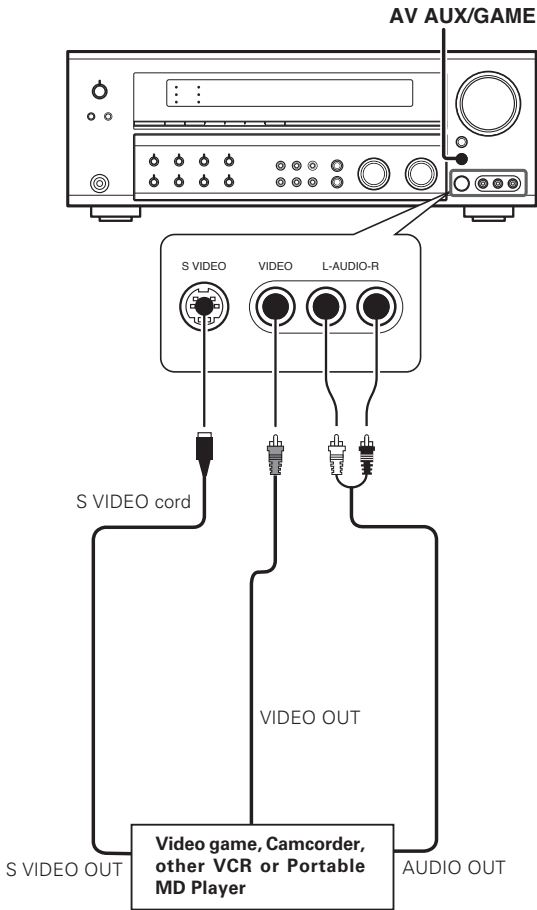

- This model has a game function which is convenient for using game equipment. It is recommended that the game equipment be connected to AV AUX jacks and the game mode be turned ON. — 20
- To select the source connected to the AV AUX jacks press AV AUX/GAME key. — 20
- When you connect the audio source such as the MD player, you do not need to connect the video cable.
- When you connect the unit and the component with the S VIDEO cord, you can get better picture quality.

Connecting the antennas

The broadcast reception cannot be made unless the antennas are connected. Connect the antennas correctly as instructed below.

AM Loop Antenna

Place the supplied loop antenna as far as possible from the receiver, TV set, speaker cords and power cord, and adjust the direction for best reception.

AM Antenna Terminal connections

1 Push lever.

2 Insert cord.

3 Release lever.

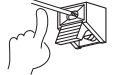
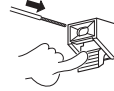

FM Indoor Antenna

The supplied indoor antenna is for temporary use only. For stable signal reception we recommend using an outdoor antenna. Disconnect the indoor antenna when you connect one outdoors.

FM Antenna Terminal connections

Insert cord.



FM Outdoor Antenna

Lead the 75Ω coaxial cable connected to the FM outdoor antenna into the room and connect it to the **75Ω FM** terminal.

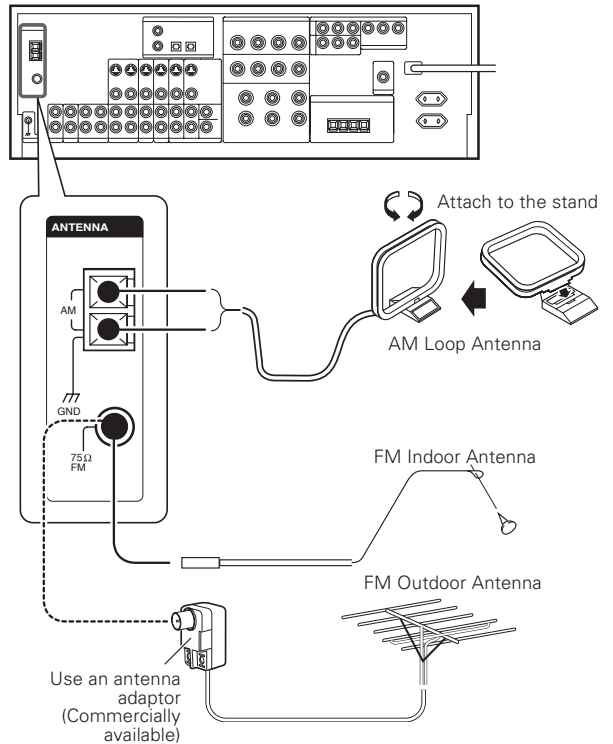

Preparing for surround sound

Speaker settings

To enable you to obtain optimum enjoyment from the receiver's listening modes, make sure to complete the speaker settings (Subwoofer, Front, Center, Surround and Surround Back Speakers) as described below.

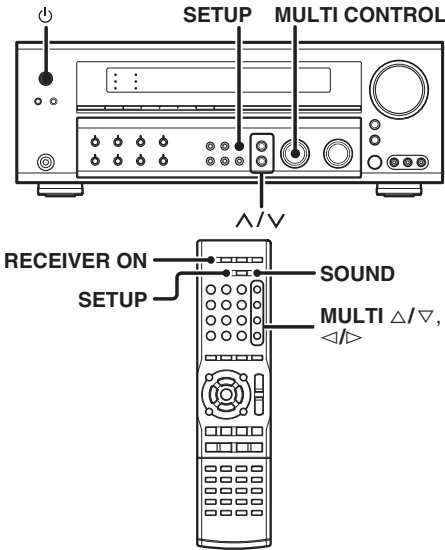

1 Turn on the power to this receiver by pressing the $\text{\textcircled{P}}$ (POWER ON/STANDBY) key or RECEIVER ON key.

If you want to use the remote control unit, press the VIDEO 1, VIDEO 2, VIDEO 3, MD/TAPE, PHONO, AV AUX or TUNER key on the remote control unit to set it to the receiver control mode.

2 Press the SETUP key to enter the SETUP mode.

Use the Δ/∇ keys or MULTI $\triangleleft/\triangleright$ keys for the following displays.

- ① SP SETUP
- ② CROSSOVER
- ③ TEST TONE
- ④ SP DISTANCE
- ⑤ LFE LEVEL
- ⑥ DISP MODE
- ⑦ EXIT

The flow of the SETUP is as follows:

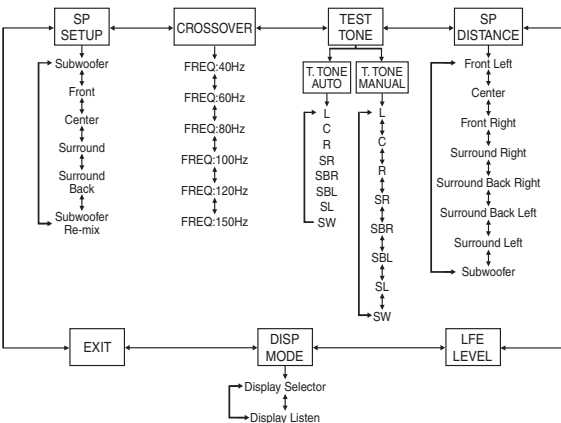

3 Select a speaker system.

- ① Select the SP SETUP and press the SETUP key again so that the subwoofer setting indication "SUBW ON" appears.

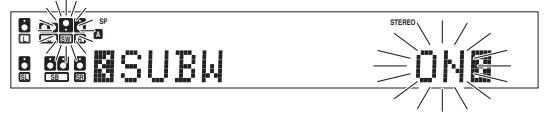

- ② Use the MULTI CONTROL knob or MULTI Δ/∇ keys to select the appropriate subwoofer setting.

- ① SUBW ON : Subwoofer setting mode to the receiver is ON.
- ② SUBW OFF : Subwoofer setting mode to the receiver is OFF.

- The initial setting is "SUBW ON".
- When the setting "SUBW OFF" is selected, the Front Speakers are automatically set to "FRNT LARGE" and the procedure skips to step ③.
- When Subwoofer output sound is required, select "FRNT NORMAL", or select both "FRNT LARGE" and "SW RE-MIX ON".

- ③ Press the Δ key or MULTI \triangleright key to accept the setting.
 - The front speakers setting indication "FRNT" appears.

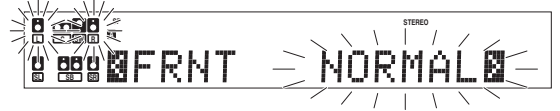

- ④ Use the MULTI CONTROL knob or MULTI Δ/∇ keys to select the appropriate front speakers setting.

- ① FRNT NORMAL : Average size Front Speakers are connected to the receiver.
- ② FRNT LARGE : Large size Front Speakers are connected to the receiver.

- ⑤ Press the Δ key or MULTI \triangleright key to accept the setting.
 - The Center Speaker setting indication "CNTR" appears.

- ⑥ Use the MULTI CONTROL knob or MULTI Δ/∇ keys to select the appropriate Center Speaker setting.

If you selected "FRNT LARGE" as the Front Speakers setting,

- ① CNTR NORMAL : An average size Center Speaker is connected to the receiver.
- ② CNTR LARGE : A large size Center Speaker is connected to the receiver.
- ③ CNTR OFF : Center Speaker setting mode to the receiver is OFF.

If you selected "FRNT NORMAL" as the Front Speakers setting,

- ① CNTR NORMAL : An average size Center Speaker is connected to the receiver.
- ② CNTR OFF : Center Speaker setting mode to the receiver is OFF.

- ⑦ Press the Δ key or MULTI \triangleright key again to accept the setting.
 - The Surround Speaker setting indication "SURR" appears.

Continued to next page.

3 Use the **MULTI CONTROL knob** or **MULTI** Δ/∇ to select the appropriate Surround Speaker setting.

If you selected "FRNT LARGE" as the Front Speaker setting,

- 1 **SURR NORMAL** : Average size Surround Speakers are connected to the receiver.
- 2 **SURR LARGE** : Large size Surround Speakers are connected to the receiver.
- 3 **SURR OFF** : Surround Speaker setting mode to the receiver is OFF.

If you selected "FRNT NORMAL" as the Front Speaker setting,

- 1 **SURR NORMAL** : Average size Surround speakers are connected to the receiver.
- 2 **SURR OFF** : Surround speaker setting mode to the receiver is OFF.

- When the setting "SURR OFF" is selected, the procedure skips to step 11.

9 Press the \wedge key or **MULTI** \triangleright key again to accept the setting.
• The Surround Back Speaker setting indication "SB" appears.

10 Use the **MULTI CONTROL knob** or **MULTI** Δ/∇ keys to select appropriate Surround Back Speaker setting.

If you selected "SURR LARGE" as the Surround Speaker setting,

- 1 **SB NORMALx1** : A single average size Surround Back Speaker is connected to the receiver.
- 2 **SB NORMALx2** : A pair of average size Surround Back Speakers are connected to the receiver.
- 3 **SB LARGEx1** : A single large size Surround Back Speaker is connected to the receiver.
- 4 **SB LARGEx2** : A pair of large size Surround Back Speakers are connected to the receiver.
- 5 **SB OFF** : Surround Back Speaker setting mode to the receiver is OFF.



If you selected "SURR NORMAL" as the Surround Speaker setting,

- 1 **SB NORMALx1** : A single average size Surround Back Speaker is connected to the receiver.
- 2 **SB NORMALx2** : A pair of average size Surround Back Speakers are connected to the receiver.
- 3 **SB OFF** : Surround Back Speaker setting mode to the receiver is OFF.

11 Press the \wedge key or **MULTI** \triangleright key again to accept the setting.
• The Subwoofer remix setting indication "SW RE-MIX" appears.

12 Use the **MULTI CONTROL knob** or **MULTI** Δ/∇ keys to select the appropriate Subwoofer re-mix setting.

- 1 **SW RE-MIX ON** : Subwoofer re-mix setting mode to the receiver is ON.
- 2 **SW RE-MIX OFF** : Subwoofer re-mix setting mode to the receiver is OFF.

- If Subwoofer is turned off or "FRNT NORMAL" is selected at the Front Speaker setting, Subwoofer re-mix setting is not visible.

13 Press the **SETUP** key again to return to the main setup displays.

4 Select the Crossover frequency.

CROSSOVER function is to adjust the receiver's audio output characteristics with the speakers' characteristics which differs depending on the size of the speakers. You will be able to enjoy a more natural and dynamic sound experience even with small size speakers.

1 Press the \wedge/∇ keys or **MULTI** $\triangleleft/\triangleright$ keys to select the **CROSS-OVER** and press the **SETUP** key.

2 Use the **MULTI CONTROL knob** or **MULTI** Δ/∇ keys to select the **CROSSOVER** frequency.

- 1 **FREQ. : 40Hz**
- 2 **FREQ. : 60Hz**
- 3 **FREQ. : 80Hz**
- 4 **FREQ. : 100Hz**
- 5 **FREQ. : 120Hz**
- 6 **FREQ. : 150Hz**

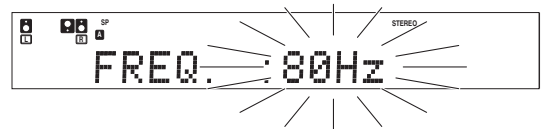

- CROSSOVER function will not be available when "LARGE" is selected for all the speakers and "SW RE-MIX OFF" is selected in step 2.

3 Press the **SETUP** key again to return to the main setup displays.

5 Adjust the speaker volume level.

From your usual listening position, adjust the volume levels. The volume levels from each speaker should be the same.

- The receiver enters the speaker volume level adjustment mode.
- Indicators appear only for the channels of the speakers selected in step 2.

1 Press the \wedge/∇ keys or **MULTI** $\triangleleft/\triangleright$ keys to select the **TEST TONE**.

2 Press the **SETUP** key for the following displays:

- 1 **T.TONE AUTO**
- 2 **T.TONE MANUAL**

3 The selection of **AUTO/MANUAL TEST TONE** is done by the **MULTI CONTROL knob** or **MULTI** Δ/∇ keys.

Press the **SETUP** key again to begin **TEST TONE**.

Use the **MULTI CONTROL knob** or **MULTI** Δ/∇ keys to adjust the volume level of the test tone output from the speaker channel to be adjusted.

For **AUTO** selection, the test tone is heard from the speakers in the following sequence for 2 seconds each starting from the **Front Left speaker**.

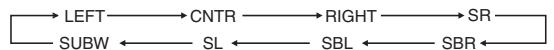

- If you have selected "SB NORMALx1" or "SB LARGEx1", "SBR" and "SBL" are not appeared but "SB" is appeared on the Display.

The channel indication blinks while the test tone is being output.



- If the speaker setting selects are OFF, the speaker level settings are reset.

For **MANUAL** selection, press the \wedge/∇ keys or **MULTI** $\triangleleft/\triangleright$ keys each time to select the speaker channel.

4 Press the **SETUP** key again.

- The test tone is turned off and return to the main setup displays.

6 Input the distance to the speakers.

- Indicators appear only for the channels of the speakers selected in step 5.

- 1 Press the \wedge/\vee keys or MULTI \triangle/∇ keys to select the SP DISTANCE on setup displays and press the SETUP key again.
- 2 Measure the distance from the listening position to each of the speakers.

Jot down the distance to each of the speakers.

Distance to Front Left Speaker (L)	:	___	feet (meters)
Distance to Center Speaker (C)	:	___	feet (meters)
Distance to Front Right Speaker (R)	:	___	feet (meters)
Distance to Surround Right (SR)	:	___	feet (meters)
Distance to Surround Back Right (SBR)	:	___	feet (meters)
Distance to Surround Back (SB)	:	___	feet (meters)
Distance to Surround Back Left (SBL)	:	___	feet (meters)
Distance to Surround Left (SL)	:	___	feet (meters)
Distance to Subwoofer (SW)	:	___	feet (meters)

- If you have selected "SB NORMALx1" or "SB LARGEx1", "SBR" and "SBL" are not appeared but "SB" is appeared on the Display.

- 3 Use the \wedge/\vee keys or MULTI \triangle/∇ keys to select the speakers and the MULTI CONTROL knob or MULTI \triangle/∇ keys to adjust the distance to the Front Speakers.

The speaker indicator to be adjusted blinks.



Indication in feet Indication in meters

- The allowable setting range is 1 to 30 feet (0.3 to 9.0 m), adjustable in 1 foot (0.3 m) increments.

- 4 Repeat steps 3 to input the distance for each of the speakers.
- 5 Press the SETUP key again to return to main setup displays.
 - The speakers you have selected should appear on the display. Confirm that all the speakers have been correctly selected.

7 Adjust the LFE LEVEL (Low Frequency Effects).

- 1 Press the \wedge/\vee keys or MULTI \triangle/∇ keys to select the LFE LEVEL.
- 2 Use the MULTI CONTROL knob or MULTI \triangle/∇ keys to adjust the LFE LEVEL.



- The LFE LEVEL can be adjusted from 0dB to -10dB in 1dB decrements.

- 3 Press the SETUP key again to return to main setup displays.

8 Select the display mode.

- 1 Press the \wedge/\vee keys or MULTI \triangle/∇ keys to select the DISP MODE.
- 2 Use the MULTI CONTROL knob or MULTI \triangle/∇ keys to select the display mode.

- 1 DISP SELECTOR : Displays the current input selector.
- 2 DISP LISTEN : Displays the current listen mode.



- 3 Press the SETUP key again to accept the setting.
- 4 Use the \wedge key or MULTI \triangleright key to select EXIT.



- 5 Press the SETUP key to exit the SETUP mode.

Normal playback

Preparing for playback

Some preparatory steps are needed before starting playback.

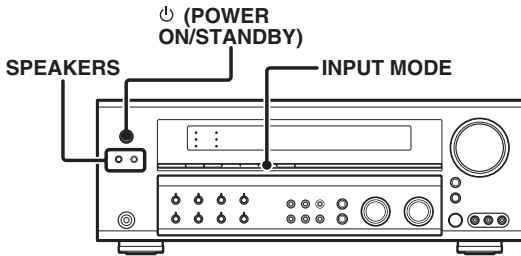

ENGLISH

Turning on the receiver

- 1 Turn on the power to the related components.
- 2 Turn on the power to this receiver by pressing the \downarrow (POWER ON/STANDBY) key.

Selecting the input mode

If you have selected a component connected to the **CD/DVD**, **VIDEO 2**, **VIDEO 3** or **DVD/6CH** jacks, make sure that the input mode setting is correct for the type of audio signal to be used. 

Selecting the speaker system

Press the **SPEAKERS** key to select the speaker system to be used.

- A ON** : Sound from the speakers connected to the **SPEAKERS A** terminals on the rear panel.
- B ON** : Sound from the speakers connected to the **SPEAKERS B** terminals on the rear panel. No sound will be heard from the subwoofer.
- A+B ON** : Sound from both the speakers connected to the **SPEAKERS A** and **B** terminals on the rear panel.
- A+B OFF** : No sound from the speakers. The display segments are different depending on the type of input signal.

The indicator for the speakers you want to use should be lit.

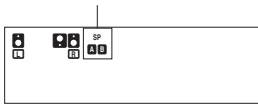

- Selecting "6CH INPUT" by pressing the **INPUT MODE** key, whereby "DVD/6CH" is the input source will cause **SPEAKERS A** to be selected automatically.
- When the **SPEAKERS B** is turned ON, the Listen mode will be switched to STEREO.

Listening to a source component

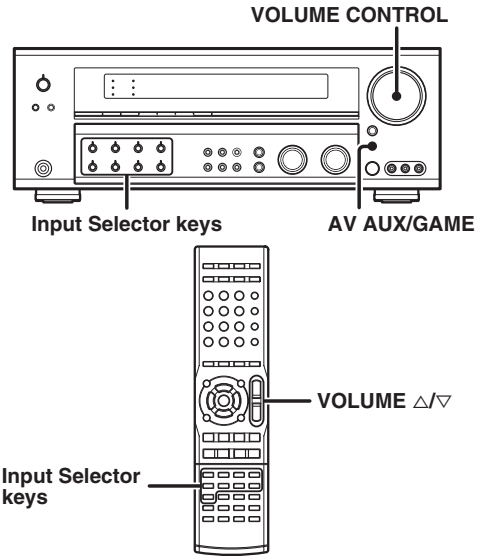

- 1 Use the **Input Selector keys** or **AV AUX/GAME** key to select the source you want to listen to.

Selecting a source using each key.

- 1 TUNER
- 2 CD/DVD
- 3 MD/TAPE
- 4 VIDEO 1
- 5 VIDEO 2
- 6 VIDEO 3
- 7 DVD/6CH
- 8 PHONO
- 9 AV AUX [GAME] (or AV AUX)

- 2 Start playback from the selected source.

- 3 Use the **VOLUME CONTROL knob** or **VOLUME Δ/▽** keys to adjust the volume.

Set up the AV AUX jacks on the front panel

Perform the setup for convenience of playing a video game using the receiver.

- 1 Use the **AV AUX/GAME** key or **Input Selector keys** to select "AV AUX [GAME]" (or "AV AUX").
- 2 Press and hold the **AV AUX/GAME** key for more than 2 seconds for the following selections;
 - 1 **AV AUX [GAME]** : When the connected game player is turned ON, the input selector is switched automatically to "AV AUX [GAME]". In addition, the ACTIVE EQ function is switched to "ACTIVE EQ GAME", and the Listen mode is switched to the appropriate mode for games.
 - 2 **AV AUX** : The game mode is switched off.

- The game mode is not activated if no video signal is input to the **VIDEO** or **S-VIDEO** jack in the **AV AUX** jack section.

Input level adjustment (analog sources only)

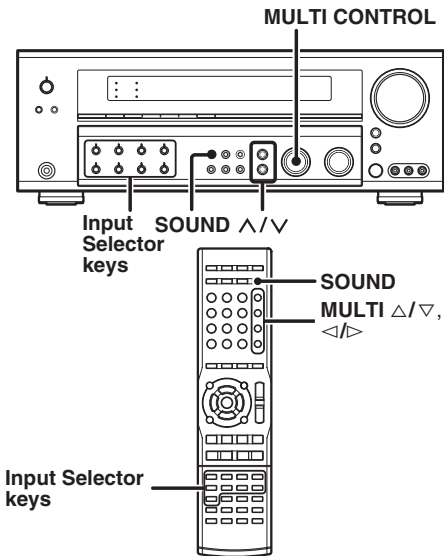

Input level adjustment (analog sources only)

If the input level of an analog source signal is too high, the CLIP indicator will blink to indicate the source signal. Adjust the input level.



- ❶ Use the Input Selector keys to select the source of which the input level you want to adjust.
 - You can store a separate input level for each input source.
- ❷ Press the SOUND and ^/v keys or MULTI </> keys repeatedly until the "INPUT" indication appears.
- ❸ Use the MULTI CONTROL knob or MULTI Δ/∇ keys to adjust the input level.

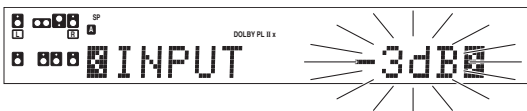

- The adjustment mode is displayed for approximately 20 seconds.
- The input level may be adjusted to any one of three settings: 0dB, -3dB, and -6dB. (The initial setting is 0dB.)

- ❹ Press the SOUND key again to return to the input indication.

Adjusting the sound

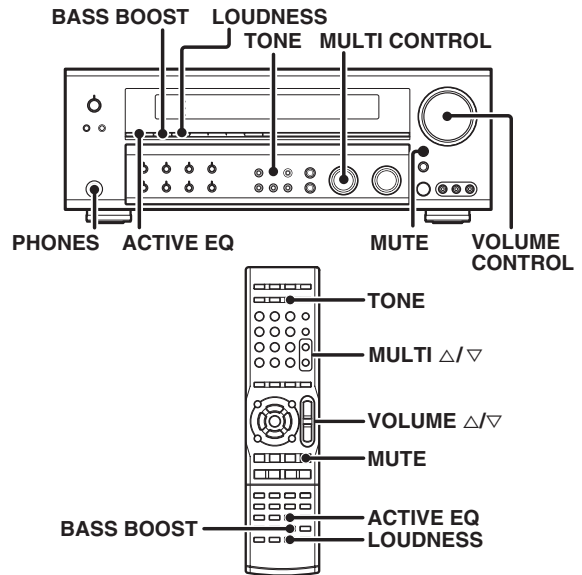

Adjusting the TONE

You can adjust the sound quality when the receiver is in the PCM stereo and analog stereo mode.

- ❶ Press the TONE key to select the TONE mode.
- ❷ Use the MULTI CONTROL knob or MULTI Δ/∇ keys to select TONE ON/OFF.



- ❸ When in TONE ON selection, press the TONE key for the following displays.
 - BASS** : Select this to adjust the low frequency range.
 - TREBLE** : Select this to adjust the high frequency range.
- ❹ Use the MULTI CONTROL knob or MULTI Δ/∇ keys to adjust the sound quality.



- The bass and treble levels are adjustable from -10 to +10 in 2 step increments.
- The adjustment item is displayed for approximately 20 seconds.
- This function is available only for speakers connected to FRONT A terminals.

Adjusting the LOUDNESS mode

You can adjust the Loudness function which controls the low volume settings to maintain the music's richness. The adjustment can be made when the receiver is in the PCM stereo and analog stereo mode.

- Press the LOUDNESS key to turn the LOUDNESS setting ON.**
- This function is available only for speakers connected to FRONT A terminals.

To cancel

Press the LOUDNESS key again so that the "LOUDNESS" indicator goes off.

Normal playback

One-touch low frequency emphasis (BASS BOOST)

You can adjust the sound quality when the receiver is in the PCM stereo and analog stereo modes.

Press the BASS BOOST key.

- Press the key once to select the maximum (+10) low frequency emphasis setting.
- This key does not function when the receiver is in the sound quality or ambience effects adjustment mode.
- This function is available only for speakers connected to FRONT A terminals.

Switching back to the previous setting

Press the BASS BOOST key again.

Muting the sound

The MUTE key lets you mute the sound of the speakers.

Press the MUTE key.

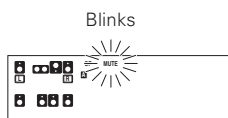

To cancel

Press the MUTE key again so that the "MUTE" indicator goes off.

- MUTE ON can also be deactivated by turning the VOLUME CONTROL knob or pressing VOLUME Δ/∇ keys.

ACTIVE EQ mode

You can enjoy a more impressive sound effect when ACTIVE EQ is turned ON.

Press the ACTIVE EQ key for the following selections;

- ① **ACTIVE EQ MUSIC** : Effective when listening to music. (The ACTIVE EQ indicator lights up.)
- ② **ACTIVE EQ CINEMA** : Effective when watching movie. (The ACTIVE EQ indicator lights up.)
- ③ **ACTIVE EQ GAME** : Effective when playing video game. (The ACTIVE EQ indicator lights up.)
- ④ **ACTIVE EQ OFF** : The ACTIVE EQ function is turned OFF. (The ACTIVE EQ indicator goes off.)

- "ACTIVE EQ" will scroll from right to left.
- ACTIVE EQ function will not be available when in REC MODE, or when searching or presetting radio stations.

Listening with headphones

- ① Connect headphones to the PHONES jack.



- The sounds from all speakers are cut off.

- ② Use the VOLUME CONTROL knob or VOLUME Δ/∇ keys to adjust the volume.

Recording

Recording audio (analog sources)

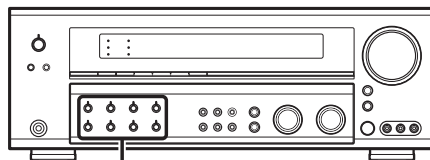

Input Selector keys



Input Selector keys

Recording a music source

- ① Use the Input Selector keys to select the source (other than "MD/TAPE") you want to record.
- ② Set the MD or TAPE recorder to record.
- ③ Start playback, then start recording.

Recording video

- ① Use the Input selector keys to select the video source (other than "VIDEO 1") you want to record.
- ② Set the video recorder connected to VIDEO 1 to record.
 - Select the REC MODE to record a digital input source.
- ③ Start playback, then start recording.
 - Recording may not be normal for some video software. This is due to the copy guard condition.

→ 37

Recording audio (digital sources)

Switch on the **REC MODE** to record a digital input source. Usually use the **REC MODE AUTO** to record audio input sources. When the digital mode changes during recording in the **REC MODE AUTO**, the audio input source may be interrupted momentarily.

Recording music in REC MODE AUTO or MANUAL

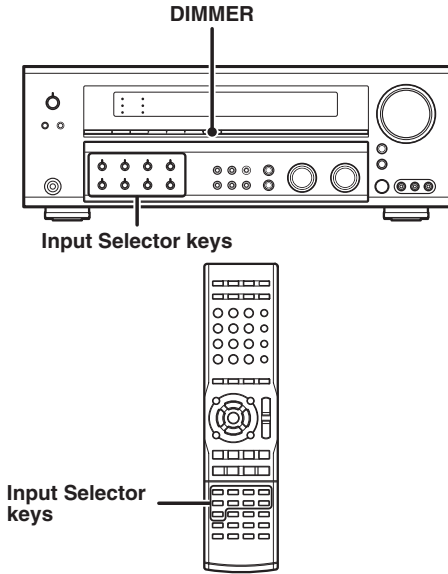

For REC MODE AUTO :



For REC MODE MANUAL :



4 Start playback, then start recording.

- If the audio reproduction stops in the middle due to change in the input signals, etc., press the **DIMMER** key.

1 Use the Input Selector keys to select the source (CD/DVD, DVD/6CH, VIDEO 2, VIDEO 3) you want to record.

2 Set the MD or TAPE recorder to record.

3 Press and hold the DIMMER key for more than 2 seconds to select the REC MODE AUTO or MANUAL.

- ① **REC MODE off** : The digital input record mode is switched off.
- ② **REC MODE AUTO** : The digital input signals (DTS, Dolby Digital, or PCM) are identified automatically and converted into stereo signals that are ready for recording.
- ③ **REC MODE MANUAL** : The input signal type at the moment this mode is selected is held throughout this mode.

- When the **REC MODE MANUAL** is selected, the digital input signal is converted to stereo signals (down-mix). But once the digital signal is changed to other signal, no signal is output. When the **REC MODE AUTO** is selected, the digital input signal is converted to stereo signals even if the digital signal is changed.

Listening to radio broadcasts

This model can store up to 40 stations in the memory and recall them by one-touch operation.

Radio stations can be classified into RDS (Radio Data System) stations and other stations. To listen to or store RDS stations in the preset memory see "Using RDS (Radio Data System)".

Tuning (non-RDS) radio stations

ENGLISH

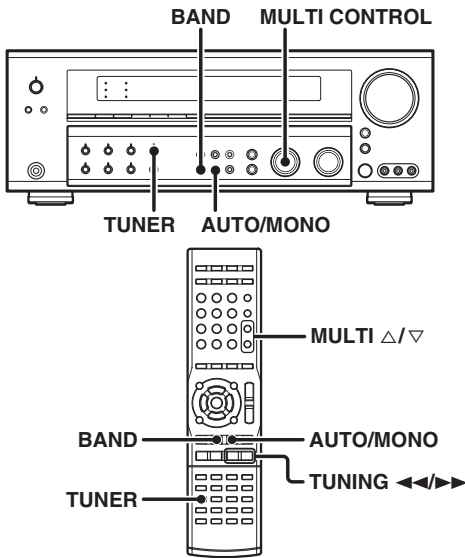

1 Use the **TUNER** key to select the tuner.

2 Use the **BAND** key to select the desired broadcast band.

Each press switches the band.



3 Use the **AUTO/MONO** key to select the desired tuning method.

Each press switches the tuning method to either auto or manual tuning.

"AUTO" indicator lights up in the display.

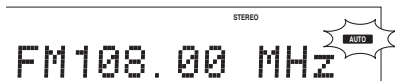

- Normally, set to "AUTO" (auto tuning). If the radio waves are weak and there is a lot of interference, switch to manual tuning. (With manual tuning, stereo broadcasts will be received in monaural.)

4 Use the **MULTI CONTROL** knob or **MULTI Δ/∇** keys, or **TUNING <</>** keys to select the station.

"STEREO" lights when a broadcast is being received in stereo.

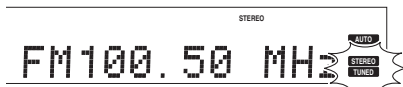

"TUNED" is displayed when a station is received.

Auto tuning : The next station is tuned automatically.

Manual tuning : Turn the knob or use the **MULTI Δ/∇** keys to select the desired station.

Using RDS (Radio Data System)

RDS is a system that transmits useful information (in the form of digital data) for FM broadcasts along with the broadcast signal. Tuners and receivers designed for RDS reception can extract the information from the broadcast signal for use with various functions, such as automatic display of the station name.

RDS functions:

PTY (Program TYPe Identification) Search

- 27

Automatically tunes to a station that is currently broadcasting the specified program type (genre).

PS (Program Service Name) Display

Automatically displays the station name transmitted by the RDS station.

RDS AUTO MEMORY function

- 26

Automatically selects and stores up to 40 RDS stations in the preset memory.

If fewer than 40 RDS stations have been stored in the preset memory, regular FM stations will be stored in the remaining places.

Radio Text function

Displays the radio text data transmitted by some RDS stations when you press the **RDS DISP** (display) key. There is "NO RT" if no text data is transmitted.

The "RDS" indicator lights up when an RDS broadcast (signal) is received.



Note

Some functions and function names may differ for certain countries and areas.

Before using a function utilizing the RDS, be sure to perform the RDS Auto Memory operation by referring to the description in "Presetting RDS stations (RDS AUTO MEMORY)".

- 26

Presetting radio stations manually

The RDS auto memory function assigns preset numbers to RDS stations starting from preset number "1". Therefore, be sure to execute the RDS auto memory function before using the following operations to manually store AM stations and other FM stations, and RDS stations. See "Presetting RDS stations (RDS AUTO MEMORY)". → 26

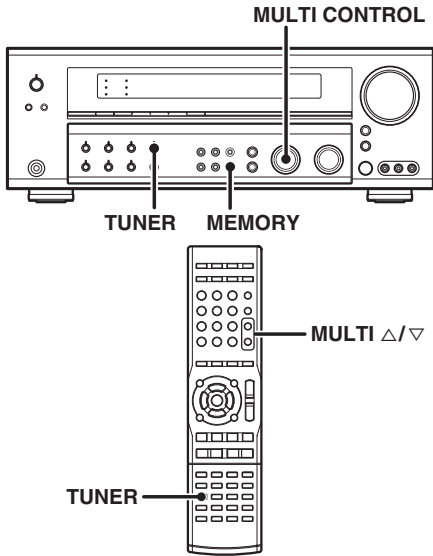

- 1 Tune to the station you want to store.
- 2 Press the **MEMORY** key while receiving the station.

Blinks for 20 seconds Lights for 20 seconds

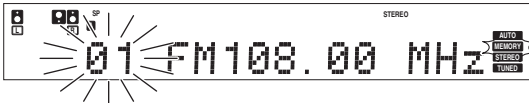

Proceed to step 3 within 20 seconds.
(If more than 20 seconds elapse, press the **MEMORY** key again).

- 3 Use the **MULTI CONTROL** knob or **MULTI** Δ/∇ keys to select one of the station presets (1 – 40).
- 4 Press the **MEMORY** key again to confirm the setting.

- Repeat steps 1, 2, 3, and 4 to store as many stations as necessary.
- If you store a station at a previously used preset, the old station will be replaced by the new one.

Receiving preset stations

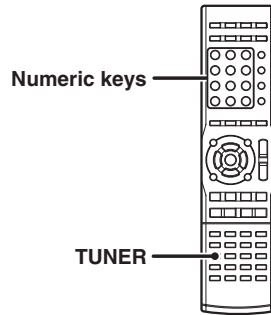

- 1 Press the **TUNER** key to select tuner as the source.
- 2 Enter the number of the preset station you want to receive (up to "40").

Press the Numeric keys in the following order:

For "15", press $+10$, 5
For "20", press $+10$, $+10$, 0

- If you make a mistake entering a two digit number, press the **+10** key repeatedly to return to the original display and start again.



Receiving preset stations in order (P.CALL)

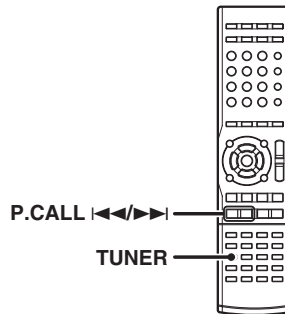

- 1 Press the **TUNER** key to select the tuner as the source.
- 2 Use the **P.CALL** \leftarrow/\rightarrow keys to select the desired station.

- Each time you press the key, another preset station is received in order.

Pressing the **P.CALL** \rightarrow does the following:

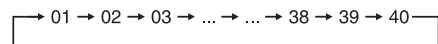

Pressing the **P.CALL** \leftarrow does the following:

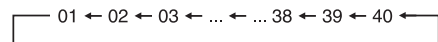

Holding down the **P.CALL** \leftarrow or \rightarrow keys, lets you skip through the presets, receiving each preset station at 0.5 second intervals.

Using the RDS DISP (Display) key

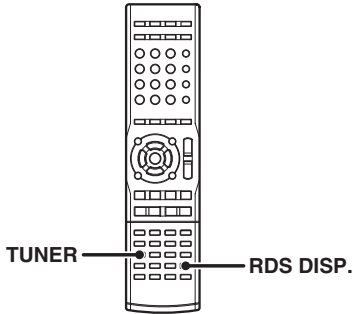

Pressing the RDS DISP. key changes the contents of the display.

Each press switches the display mode as follows :

- ① PS (Program Service name) display
- ② RT (Radio Text) display
- ③ Frequency display

① **PS (Program Service name) display :**

The station name is displayed automatically when an RDS broadcast is received.
If no PS data was sent, "NO PS" is displayed.



② **RT (Radio Text) display :**

Text data accompanying the RDS broadcast scrolls across the display.
"NO RT" is displayed if the current RDS station does not provide RT data.



③ **Frequency display :**

Displays the frequency of the current station.



Presetting RDS stations (RDS AUTO MEMORY)

This function automatically stores up to 40 RDS stations in the preset memory. In order to use the PTY function, the RDS stations must be stored in the preset memory using the RDS AUTO MEMORY function.

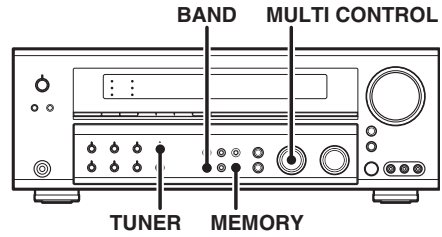

1 Press the TUNER key to enter tuner mode.

2 Use the BAND key to set the broadcast band to "FM".

3 Press the MEMORY key continuously for more than 2 seconds will start AUTO MEMORY.



- After a few minutes, up to 40 RDS stations are preset in order from channel "01".
- Stations already stored in the preset memory may be replaced by RDS stations. (i.e., If the RDS AUTO MEMORY function detects 15 RDS stations, the stations currently preset at numbers 01~15 will be replaced by the RDS stations.)

Tuning by Program Type (PTY search)

This function lets you set the tuner to automatically search for stations which are currently broadcasting the type of program (genre) you want to listen to.

Under certain receiving conditions, it may take more than 1 minute to complete the search.

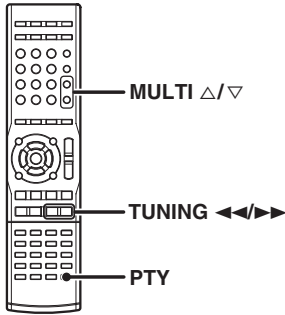

Preparations

- Execute the RDS auto memory procedure.
- Set the broadcast band to FM.
- Tune to an RDS station.

1 Press the PTY key to activate the PTY search mode.

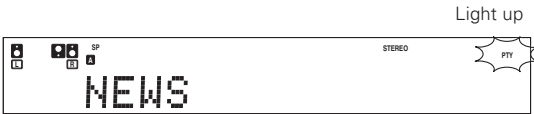

When an RDS broadcast is received, the program type is shown on the display. If no PTY data is available, or if the station is not an RDS station, "NONE" is displayed.

2 While the "PTY" indicator is lit, use the MULTI Δ/▽ keys or TUNING ◀▶ / ▶▶ keys select the program type of your choice.

Program type table

Program Type Name	Display	Program Type Name	Display
Pop Music	POP M	Weather	WEATHER
Rock Music	ROCK M	Finance	FINANCE
Easy Music	EASY M	Children's Program	CHILDREN
Light Classical Music	LIGHT M	Social Affairs	SOCIAL
Serious Classical Music	CLASSICS	Religion	RELIGION
Other Music	OTHER M	Phone In	PHONE IN
News	NEWS	Travel	TRAVEL
Current Affairs	AFFAIRS	Leisure	LEISURE
Information	INFO	Jazz Music	JAZZ
Sport	SPORT	Country Music	COUNTRY
Education	EDUCATE	National Music	NATION M
Drama	DRAMA	Oldies Music	OLDIES
Culture	CULTURE	Folk Music	FOLK M
Science	SCIENCE	Documentary	DOCUMENT
Varied Speech	VARIED		

3 Press the PTY key to start searching.

EXAMPLE : Searching for a Pop Music broadcast.

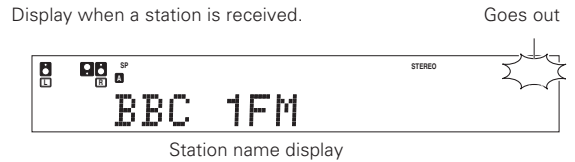
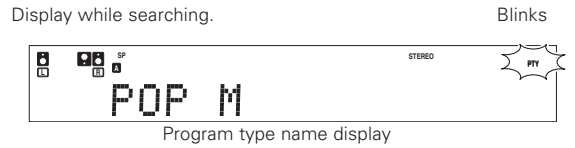

- No sound is heard while "PTY" is blinking.
- If the desired program type cannot be found, "NO PROGRAM" is displayed, then after several seconds the display returns to the original display.

To select another program type.

Repeat steps 1, 2 and 3.

Ambience effects

This receiver is equipped with listening modes that allow you to enjoy an enhanced sonic ambience with a variety of video sources.

In order to obtain the optimum effect from the surround modes, make sure to input the proper speaker settings beforehand.



Surround modes

ENGLISH

The below speaker placements are for 5.1 channel surround sound system which are;

- Dolby Digital
- Dolby Pro Logic II
- DTS
- DTS 96/24
- DVD 6-channel

The below speaker placements are for 6.1 channel surround sound system which are;

- Dolby Digital EX
- DTS-ES
- Neo:6
- DSP mode

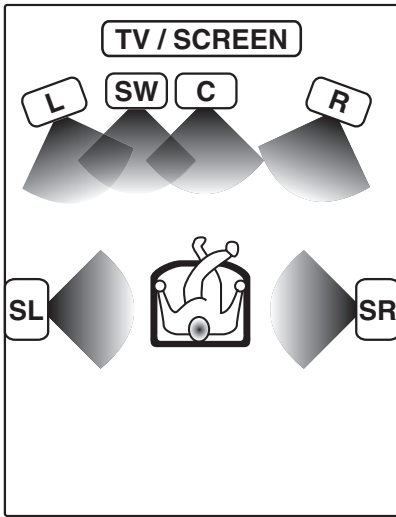

No Surround Back speaker

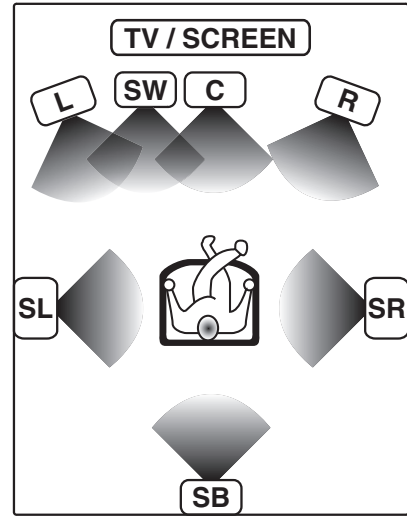

With Surround Back speaker

The below speaker placements are for 7.1 channel surround sound system which is;

- Dolby Pro Logic IIx

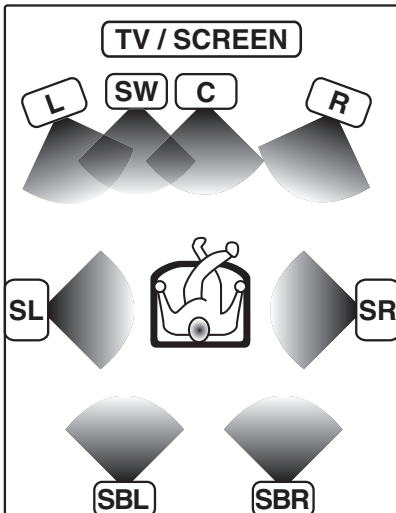

With Surround Back Left and Right speakers

- L** Front Left Speaker
- SW** Subwoofer
- C** Center Speaker
- R** Front Right Speaker
- SL** Surround Left Speaker
- SR** Surround Right Speaker
- SB** Surround Back Speaker
- SBL** Surround Back Left Speaker
- SBR** Surround Back Right Speaker

Manufactured under license from Dolby Laboratories. "Dolby", "Pro Logic", "Surround EX" and the double-D symbol are trademarks of Dolby Laboratories.

"DTS", "DTS-ES", "Neo:6" and "DTS 96/24" are trademarks of Digital Theater Systems, Inc.



Even if the speaker configuration is different from above, this receiver will let you enjoy Dolby Digital and DTS sources in a suitable condition for every speaker configuration.

Dolby Digital

The Dolby Digital surround format lets you enjoy up to 5.1 channels of digital surround sound from Dolby Digital program sources (such as Laserdisc or DVD software marked ). Compared with previous Dolby surround, Dolby Digital provides even better sound quality, greater spatial accuracy, and improved dynamic range.

Dolby Digital EX

Dolby Digital EX is an extension of Dolby Digital technology, Dolby Digital EX creates six full-bandwidth output channels from 6.1-channel sources. This is done using a matrix decoder that derives three surround channels from the two in the original recording. This is achieved by using three different surround signals, surround left, surround right, and surround back, each driving its own array of speakers. Think of it as adding a center channel for the rear speakers, which give more diffuse and natural surround effect, even if you wanted the ability to completely encircle the audience with sound, positioning sound effects exactly where they would be heard in real life. For best results, Dolby Digital EX should be used with movie soundtracks recorded with Dolby Digital Surround EX which contain a digital flag that will automatically activate this feature. However, for titles released prior to late 2001, this feature has to be activated manually.

Although Dolby Digital soundtracks incorporate a separate low frequency channel, connecting a subwoofer will also improve deep bass performance in the other surround modes. The indication "**LFE**" appears in the display when a signal is being input for this channel.

Dolby Pro Logic IIx and Dolby Pro Logic II

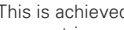
Dolby Pro Logic II was designed specifically to provide a new sense of spatiality, directionality and articulation of sounds from Dolby Surround encoded sources (such as video and Laserdisc software marked ). This is achieved with an intelligent, built-in feedback logic design, a matrix surround decoding and the decoding of stereo, full bandwidth surround outputs. Dolby Pro Logic IIx enhanced Dolby Pro Logic II's features. It creates 6.1 channel and 7.1 channel surround sound from stereo or 5.1 channel signals. This feature provides you an astonishing ambience effect which makes you feel you are surrounded by natural sound. Especially 7.1 channel surround sound can produce real back sound from Surround Back speakers.

The Pro Logic IIx modes programmed into this model are "MOVIE", "MUSIC" and "GAME". The Pro Logic II modes programmed into this model are "MOVIE", "MUSIC", "GAME" and "PRO LOGIC". The "MOVIE" mode has preset characteristics to produce a calibrated, high-level surround sound playback while the "MUSIC" mode has user-adjustable characteristics to offer the three optional controls, like "Dimension", "Center Width" and "Panorama" modes to allow optimization of the soundfields as desired. The "Dimension" control allows the user to gradually adjust the soundfield either towards the front or towards the rear; the "Center Width" control allows various adjustment of the left-center-right speakers' balance; the "Panorama" mode extends the front stereo image to include the surround speakers for an exciting "wraparound" effect with side wall imaging. The "GAME" mode provides surrounded and exciting sound when you enjoy game or TV. Especially in Pro Logic IIx "GAME" mode, base sound not only from Front and Center but also from Surround channel is added to Subwoofer. This provides ever more dynamic surround effects.

DTS

The DTS multi-channel audio format is available on CD, LD and DVD software. DTS is a strictly digital format and cannot be decoded inside most CD, LD or DVD players. For this reason, if you attempt to listen to DTS encoded software through the analog output of your new CD, LD or DVD player, you will experience digital noise in most cases. This noise can be quite loud if the analog output is connected directly to a high power amplification system. Proper measures for playing the digital output as described below should be taken to avoid this situation. To enjoy DTS Digital Surround playback, an external 5.1 channel DTS Digital Surround decoder system or an amplifier with a built-in DTS Digital Surround decoder must be connected to the digital output (S/P DIF, AES/EBU or TosLink) of a CD, LD or DVD player. All models are incorporated with the DTS decoder.

DTS-ES

DTS-ES (Digital Theater System-Extended Surround) presents 6.1 channels surround system with additional Surround Back channel which evolved from the conventional 5.1 channels surround system. DTS-ES format that was recorded in DVD, CD or LD comprises of two modes. DTS-ES Discrete 6.1 produces the discrete surround back which is completely independent and DTS-ES Matrix 6.1 produces the surround back which synthesised within the left and right surround channels using matrix technology. DTS-ES has perfect compatibility with the conventional 5.1 channels surround system. 6.1 channels surround with an additional surround back presents a more natural presence and surround effects by increasing the impression of the sound image from back. Programs which are recorded using DTS-ES technology consist of information flags which will be able to control the Discrete and Matrix mode. Thus, it can automatically select the best matched mode.

Neo:6

Neo:6 is a new technology which was developed by DTS. It can produce high grade 6 channels surround with an astonishing fidelity from 2 channels content. Neo:6 has 2 modes, "CINEMA" mode is for movie playback and "MUSIC" mode is for music playback.

DTS 96/24

DTS 96/24 made it possible to achieve a wide frequency range of over 40 kHz by increasing the sampling frequency to 96 or 88.2 kHz. Moreover, DTS 96/24's ability of 24 bit resolution offers the same frequency band and dynamic range as 96 kHz/24 bit PCM. DTS 96/24 is, as with conventional DTS Surround, compatible with multi-channels. Therefore, sources recorded using DTS 96/24 technologies can be played in high sampling frequency, multi-channel audio with ordinary DVDs and CDs.

DTS has a ".1" or "LFE" channel.

The indication "**LFE**" appears in the display when a signal is being input for this channel.

Note

LFE = Low Frequency Effects. This channel delivers separate non-directional bass signals to the subwoofer for more dynamic deep bass sound effects.

DSP mode

The DSP mode lets you add the atmosphere of a live concert or hall to almost any type of program source. These modes are particularly effective when used with stereo program sources, like CD, television, and FM radio. You might enjoy trying the ARENA, JAZZ CLUB, THEATER, STADIUM or DISCO mode the next time you watch a concert or sporting event!

What's DSP mode?

DSP stands for Digital Signal Processor. The way a sound is heard in an actual environment depends on a variety of different factors. One of the most important is reverberation (the act of decaying elements of sound echoing in various places). The DSP modes produce the feeling of presence by using the DSP to create reverberation, without spoiling the sound quality of the original signal.



DVD 6-channel mode

Using a DVD player or the like equipped with six (5.1) output channels and this model, you can enjoy multi-channel encoded DVD source material in all its splendor. Since the source signals are digital and each channel is input independently, the resulting sound quality, sense of spaciousness, and dynamic range are superb.

The indication "6CH INPUT" appears in the display during DVD 6-channel mode selection.

Surround play

The DTS compatible models can reproduce a CD, DVD, or LD carrying the DTS mark.

Dolby Digital can be used when playing DVD or LD software bearing the  mark and Dolby Digital format digital broadcasts (etc.). Dolby Pro Logic can be used when playing video, DVD, or LD software bearing the  mark.

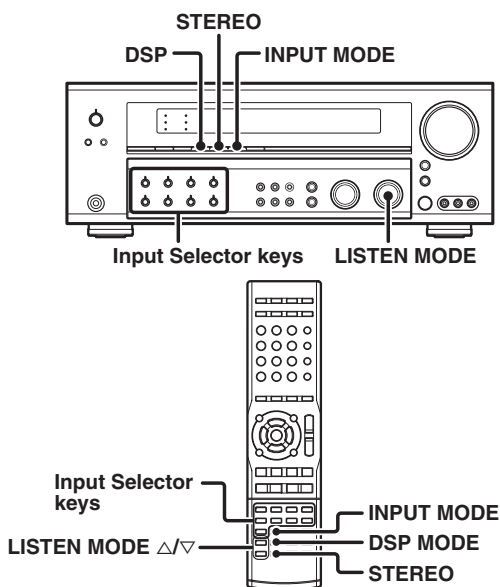

Preparations

- Turn ON related components.
- Complete "Preparing for surround sound" (speaker settings). → 17
- Use the **Input Selector** keys to select the component you wish to play back with surround sound.
- Use the **INPUT MODE** key to select the input mode (analog or digital) for the source you wish to play back. → 8
- Noise will be produced when a DTS source is played by selecting the analog input.

1 Start playing the video software.

2 Use the **LISTEN MODE** knob or **LISTEN MODE Δ/∇** keys to select the listening mode.

The listening mode settings are stored separately for each input. If the input mode is set to full auto ("AUTO DETECT" lights), the receiver selects the optimal listening mode automatically based on the type of input signal and the speaker settings.

Each turn of the LISTEN MODE knob or press of the LISTEN MODE Δ/∇ keys switches the setting as listed below.

The listening mode settings are different depending on the type of input signal.

Dolby Digital Surround EX compliant disc :

Dolby Digital Surround EX compliant disc contains identification signals. When you choose **FULL AUTO** during "Input mode settings" (→ 8), this amplifier detects the identification signals and selects an optimum LISTEN mode automatically.

Sometimes we find some discs which are Dolby Digital Surround EX compliant discs but do not contain the identification signals. In this case, select one of the LISTEN modes which are for 6.1 or 7.1 channel surround mode.

When the Dolby Digital or Dolby Digital EX signal is input :

- ① **DOLBY DIGITAL** : Dolby Digital surround.
- ② **DOLBY D EX** : Dolby Digital EX surround.
- ③ **D+PLIIx MOVIE** : Dolby Digital+Pro Logic IIx surround MOVIE mode.
- ④ **D+PLIIx MUSIC** : Dolby Digital+Pro Logic IIx surround MUSIC mode.
- ⑤ **PLIIx MOVIE** : Dolby Pro Logic IIx surround MOVIE mode.*
- ⑥ **PLIIx MUSIC** : Dolby Pro Logic IIx surround MUSIC mode.*
- ⑦ **PLIIx GAME** : Dolby Pro Logic IIx surround GAME mode.*
- ⑧ **PLII MOVIE** : Pro Logic II surround MOVIE mode.*
- ⑨ **PLII MUSIC** : Pro Logic II surround MUSIC mode.*
- ⑩ **PLII GAME** : Pro Logic II surround GAME mode.*
- ⑪ **PRO LOGIC** : Pro Logic surround.*
- ⑫ **STEREO** : Normal stereo playback.

(* This mode can be selected only when 2 channel stereo signal comes in.)

When you select **DOLBY DIGITAL** "DOLBY DIGITAL" will be displayed.



When the DTS or DTS-ES (matrix or discrete) signal is input :

- ① **DTS-ES Mtrx 6.1** : DTS-ES MATRIX 6.1 channel surround.
- ② **DTS-ES Dscrt 6.1** : DTS-ES DISCRETE 6.1 channel surround.
- ③ **DTS** : DTS 5.1 channel surround.
- ④ **DTS+NEO:6 Cin** : DTS+Neo:6 surround CINEMA mode.
- ⑤ **NEO:6 CINEMA** : Neo:6 surround CINEMA mode.*
- ⑥ **NEO:6 MUSIC** : Neo:6 surround MUSIC mode.*
- ⑦ **DTS 96/24** : DTS 96/24 playback mode.
- ⑧ **STEREO** : Normal stereo playback.

(* This mode can be selected only when 2 channel stereo signal comes in.)

When the analog signal or the digital signal (except for Dolby Digital or DTS signal) is input :

- ① **PLIIx MOVIE** : Pro Logic IIx surround MOVIE mode.
- ② **PLIIx MUSIC** : Pro Logic IIx surround MUSIC mode.
- ③ **PLIIx GAME** : Pro Logic IIx surround GAME mode.
- ④ **PLII MOVIE** : Pro Logic II surround MOVIE mode.
- ⑤ **PLII MUSIC** : Pro Logic II surround MUSIC mode.
- ⑥ **PLII GAME** : Pro Logic II surround GAME mode.
- ⑦ **PRO LOGIC** : Pro Logic surround.
- ⑧ **NEO:6 CINEMA** : Neo:6 surround CINEMA mode.
- ⑨ **NEO:6 MUSIC** : Neo:6 surround MUSIC mode.
- ⑩ **STEREO** : Normal stereo playback.

• Dolby Digital or DTS signal having more channels than the maximum number of playback channels available using the receiver's current settings is input, downmixing is performed to match the number of available channels.

3 DSP mode.

DSP can produce these effects without spoiling the sound quality of the original music or video source. This mode can be selected when digital signals other than Dolby Digital or DTS, or analog signal come in.

① **Pressing the DSP key or DSP MODE key will display the current DSP MODE status.**

② **Each press of the key will switch to the next status as shown below:**

- ① **ARENA** : DSP surround ARENA mode.
- ② **JAZZ CLUB** : DSP surround JAZZ CLUB mode.
- ③ **THEATER** : DSP surround THEATER mode.
- ④ **STADIUM** : DSP surround STADIUM mode.
- ⑤ **DISCO** : DSP surround DISCO mode.

• The DSP mode selection is displayed for approximately 3 seconds.

4 Adjust the volume.

Switching the LISTEN mode to STEREO temporarily

Pressing the **STEREO** key changes the currently selected LISTEN mode into STEREO. It will be changed back to the original LISTEN mode by pressing the **STEREO** key again.

• If the power is turned off and turned back on, or the input selector is switched to another and switched back, the LISTEN mode will be back to the original one.

Notes

- Depending on the type of the signal or speaker setting, some listening modes cannot be selected.
- When playback is started, the sound may be cut or interrupted before the input source is confirmed as Dolby Digital.
- To enjoy Dolby Digital surround (as well as all the other listening modes) from a single component, be sure to use a Dolby Digital compatible source component.

DVD 6-channel playback

Using a DVD player or the like equipped with six (5.1) output channels and the receiver, you can enjoy surround sound playback. Connecting a DVD player which can decode the surround signal itself is also acceptable.

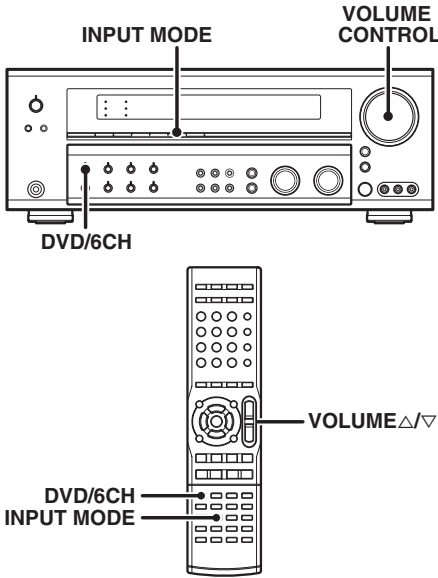

Preparations

- Connect your DVD player to the DVD/6CH jacks of the receiver.
- Turn on all other components that will be used.
- Complete "Preparing for surround sound".

1 Use the DVD/6CH key to select "DVD/6CH" as the input source.

2 Select "6CH INPUT" by pressing the INPUT MODE key.

- If speaker system B is on when "6CH INPUT" is selected as the input mode, it switches off and speaker system A turns on automatically.

3 Start playback of the DVD software.

4 Adjust the volume.

- It is not possible to adjust the volume level or sound quality (**SETUP, SOUND, LISTEN MODE, ACTIVE EQ, STEREO, DSP MODE, LOUDNESS and TONE key will not be functional**) of the channels separately when the receiver is in the 6CH INPUT mode. Adjust the volume with the controls of the DVD player. For the powered subwoofer, you can adjust the volume of the subwoofer using the subwoofer's own volume control.

Convenient functions

Adjusting the sound

You can make further adjustments to the sound while listening to playback in the surround mode.

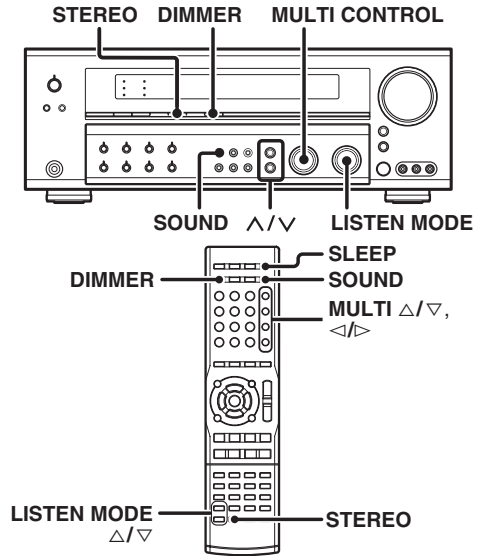

- 1 Press the **SOUND** key and then use the \wedge/\vee keys or **MULTI** \triangle/∇ keys until the desired item appears in the display.

Each time you press the \wedge/\vee keys or **MULTI** \triangle/∇ keys, the menu changes as follows:

Note that some items are not displayed depending on speaker settings and listening modes.

- ① **CNTR** (Center speaker level adjustment)*
- ② **SR** (Surround Right speaker level adjustment)*
- ③ **SB** (Surround Back speaker level adjustment)*
- ④ **SBR** (Surround Back Right speaker level adjustment)*
- ⑤ **SBL** (Surround Back Left speaker level adjustment)*
- ⑥ **SL** (Surround Left speaker level adjustment)*
- ⑦ **SUBW** (Subwoofer level adjustment)*
- ⑧ **INPUT** (Input level adjustment - analog mode only)
- ⑨ **MIDNIGHT** (Midnight mode ON/OFF - Dolby Digital and DTS mode only)
- ⑩ **PANORAMA** (Panorama mode ON/OFF)**
- ⑪ **DIMENSION** (Dimension adjustment)**
- ⑫ **CENTER WIDTH** (Center width adjustment)**
- ⑬ **CENTER IMAGE** (Center image adjustment - Neo:6 Music mode only)
- ⑭ **DUAL MONO** (Dual Mono selection - Dolby Digital mode only)

* The adjustment is only temporary for the current input selection. The value will return automatically to the original setup value when the power is turned on/off.

** Pro Logic IIx Music and Pro Logic II Music mode only.

- If you have selected "**SB NORMALx1**" or "**SB LARGEx1**", "**SBR**" and "**SBL**" are not appeared but "**SB**" is appeared on the Display.

- 2 Use the **MULTI CONTROL** knob or **MULTI** \triangle/∇ keys to adjust the setting as desired.

- The adjustment item is displayed for approximately 20 seconds.

- 3 Press the **SOUND** key again to return to the input indication.

Midnight mode (Dolby Digital and DTS mode only)

When watching movies at night, you might not be able to raise the volume as loud as normal. Midnight mode compresses the dynamic range of previously specified heavy sound passage of the Dolby Digital and DTS sound track (like scenes with sudden increases in volume) to minimize the difference in volume between the scenes with heavy sound passage and scenes with normal sound passage. This makes it easy to hear all of the sound track, even when listening at low volumes.

- 1 Press the **SOUND** key, then press the **Λ/V** keys or **MULTI** **◀/▶** keys until **"MIDNIGHT"** appears on the display.
 - This can be selected only if CD/DVD, DVD/6CH, VIDEO 2 or VIDEO 3 is selected as the source and the input signal is set to "DOLBY DIGITAL" or "DTS".
- 2 Use the **MULTI CONTROL** knob or **MULTI** **Δ/▽** keys to select the **ON** or **OFF** setting.



- The adjustment item is displayed for approximately 20 seconds.
- Some Dolby Digital or DTS software may not be compatible with the Midnight mode.

- 3 Press the **SOUND** key again to return to the input indication.

Panorama mode (Pro Logic IIx Music mode and Pro Logic II Music mode only)

When listening to music, you will be able to enjoy the "wrap-around" sound effect when you adjust the panorama mode.

- 1 Press the **SOUND** key, then press the **Λ/V** keys or **MULTI** **◀/▶** keys until **"PANORAMA"** appears on the display.
- 2 Use the **MULTI CONTROL** knob or **MULTI** **Δ/▽** keys to select **PANORAMA ON** or **OFF**.
 - 1 **PANORAMA ON** : PANORAMA mode is ON.
 - 2 **PANORAMA OFF** : PANORAMA mode is OFF.

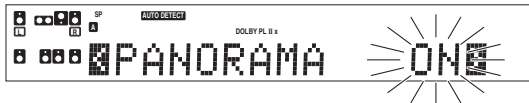

- 3 Press the **SOUND** key again to return to the input indication.

Dimension mode (Pro Logic IIx Music mode and Pro Logic II Music mode only)

When listening to music with certain recordings, you will also be able to achieve a suitable balance from all the speakers by adjusting the dimension mode.

- 1 Press the **SOUND** key, then press the **Λ/V** keys or **MULTI** **◀/▶** keys until **"DIMENSION"** appears on the display.
- 2 Use the **MULTI CONTROL** knob or **MULTI** **Δ/▽** keys to adjust the soundfield towards the rear or the front.

Soundfield is adjusted towards the front.

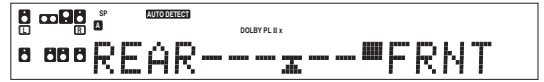

Soundfield is in neutral position.

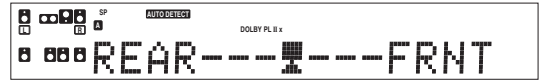

Soundfield is adjusted towards the rear.

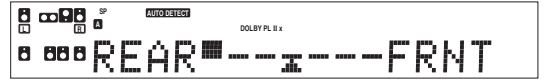

- 3 Press the **SOUND** key again to return to the input indication.

Center Width mode (Pro Logic IIx Music mode and Pro Logic II Music mode only)

Center width adjustment allows you to enjoy an enhanced sound when listening to music through center image from only center speaker, or left and right speakers or various combinations adjustments.

- 1 Press the **SOUND** key, then press the **Λ/V** keys or **MULTI** **◀/▶** keys until **"CENTER WIDTH"** appears on the display.
 - The **CENTER WIDTH** indication scrolls across the display.
 - When the center speaker is switched OFF, this mode will not be effective.
- 2 Use the **MULTI CONTROL** knob or **MULTI** **Δ/▽** keys to adjust the left-center-right output.

Center image will be heard from center speaker only.

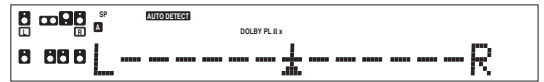

Center image will be heard from left and right speakers only.

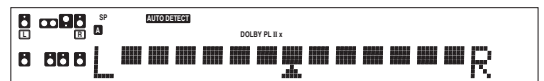

- When in other position, center image from center speaker, left and right speakers can be heard simultaneously with various combinations.

- 3 Press the **SOUND** key again to return to the input indication.

Center Image mode (Neo:6 Music mode only)

In the CENTER IMAGE setting mode of the Neo:6 MUSIC listen mode, it is possible to enhance the center channel audio by adjusting the center signal component.

- 1 Press the **SOUND** key, then press the **^/v** keys or **MULTI** **</>** keys until "CENTER IMAGE" appears on the display.



- When the center speaker is switched OFF, this mode will not be effective.

- 2 Use the **MULTI CONTROL** knob or **MULTI** **Δ/∇** keys to adjust the left-center-right output.

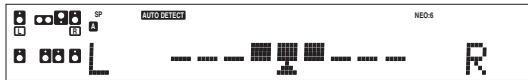

- Adjust the center component level.

- 3 Press the **SOUND** key again to return to the input indication.

Dual Mono mode (Dolby Digital mode only)

When the Dolby Digital source have Multiplex sound, you can select Main / Sub sound for Audio output.

- 1 Press the **SOUND** key, then press the **^/v** keys or **MULTI** **</>** keys until "DUAL MONO" appears on the display.

- This can be selected only if CD/DVD, DVD/6CH, VIDEO 2 or VIDEO 3 is selected as the source and the LISTEN mode is set to "DOLBY DIGITAL."

- 2 Use the **MULTI CONTROL** knob or **MULTI** **Δ/∇** keys for the following selection.

- 1 **Main** : Multiplex Main channel output.
- 2 **Sub** : Multiplex Sub channel output.
- 3 **Main + Sub** : Multiplex Main + Sub channel output.
- 4 **Stereo** : Main channel from the left speaker. / Sub channel from the right speaker.

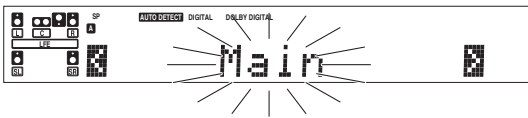

- The adjustment item is displayed for approximately 20 seconds.

- 3 Press the **SOUND** key again to return to the input indication.

96kHz LPCM playback

The receiver is compatible with the 96kHz LPCM playback. To play a 96kHz DVD, set the listen mode other than DSP mode. (96kHz fs indicator lights up)

- When in **FULL AUTO** input mode and the listen mode is set to DSP mode, the listen mode will automatically be STEREO.
- When in **DIGITAL MANUAL** input mode and the listen mode is set to DSP mode, "96kHz LPCM" will appear in the display and no sound can be heard from the speakers.

Use the **LISTEN MODE** knob, **LISTEN MODE** key or **STEREO** key to select STEREO mode to output sound from the speakers.

Display dimmer adjustment

The dimmer function lets you select the brightness of the receiver's display. You might find this useful if you darken your room to watch movies or listen to music.

If you want to use the remote control unit, press the **VIDEO 1**, **VIDEO 2**, **VIDEO 3**, **MD/TAPE**, **PHONO**, **AV AUX** or **TUNER** key on the remote control unit to set it to the receiver control mode.

Each time you press the **DIMMER** key, the display brightness changes among the three available settings. Select the brightness level you find most pleasing.

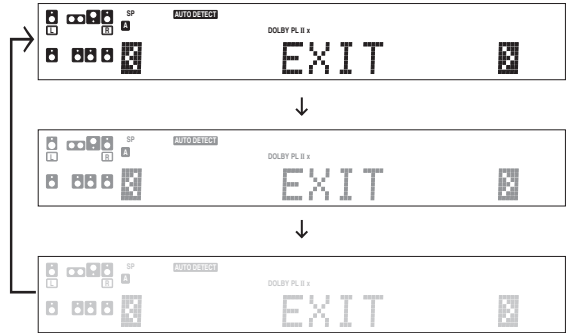

Sleep timer

The sleep timer function turns the receiver OFF (to the standby mode) automatically when the set timer period has elapsed. The sleep timer period can be set in 10-minute steps up to 90 minutes.

Press the **SLEEP** key repeatedly until the desired period before turning the receiver OFF (standby mode) is displayed.

- Each press increments the sleep timer period by 10 minutes.
10 → 20 → 3070 → 80 → 90 → Cancel → 10 → 20 → ...

The "SLEEP" indicator lights up

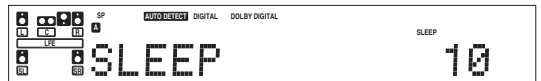

- Pressing the **SLEEP** key after the sleep timer has started allows you to check the remaining time period.
- To cancel the sleep timer, turn the receiver OFF (standby mode) or press the **SLEEP** key repeatedly until the Sleep timer indicator disappears.

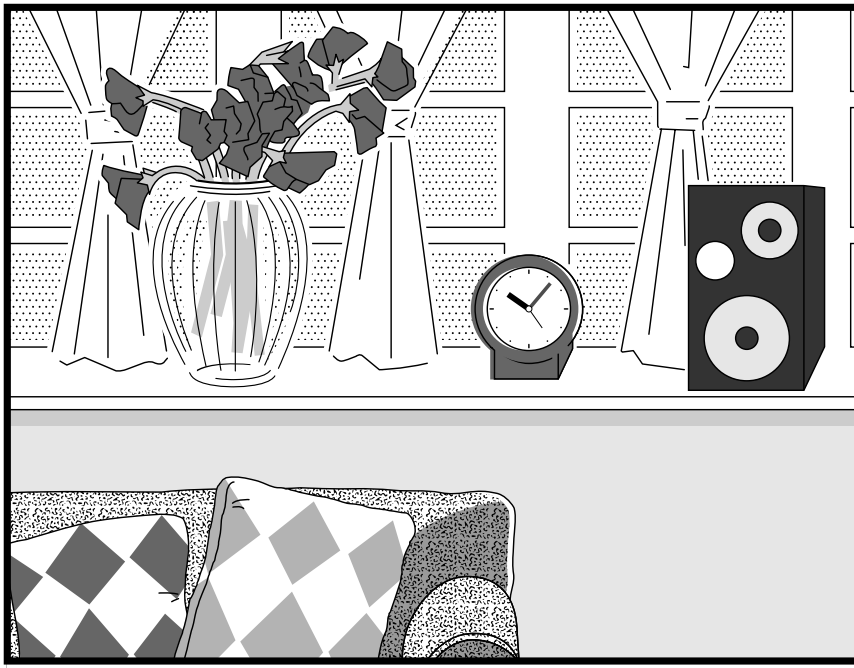

Basic remote control operations for KENWOOD DVD players

DVD player operation keys

The remote control of this unit can control KENWOOD DVD players directly without using the remote control supplied with the DVD player.

DV-4900, DV-4070B, DV-2070, DV-203, DVF-9010, DVF-K7010, DVF-5010, DVF-R9030, DVF-R7030, DVF-3530, DV-402, DV-5900, DV-5700, DVF-R9050, DVF-J6050, DV-505, DV-503, DV-502, DVF-3550, DVF-3050, DVF-R4050, DVF-605, DV-6050, DVF-R5060, DVF-3060, DVF-3060K, DV-705, DVF-R5070, DVF-3070, DVF-3080, DVF-N7080, DVF-8100, DVF-3200 and DVF-3250.

How to operate the DVD player with the remote control

1. Press the **DVD** key to turn the DVD player on.
2. Press the **CD/DVD** key or **DVD/6CH** key to operate the functions of the DVD player.
3. Press each key for DVD player operation. Refer to the instruction manual of the DVD players for the detailed operating instructions. (To return to the receiver operation mode, press other **Input Selector** key.)

DVD player operation keys

You can perform these basic operations using the keys described below when connected to KENWOOD DVD player.

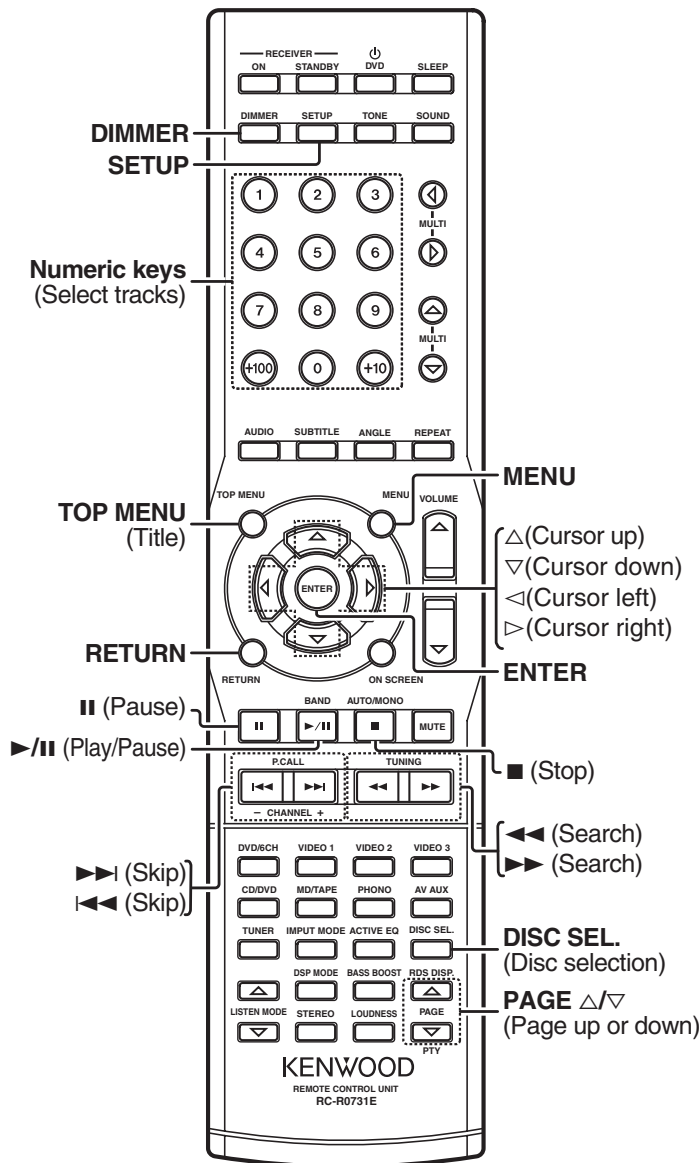

Resetting the Microcomputer

The microcomputer may malfunction (unit cannot be operated, or shows an erroneous display) if the power cord is unplugged while the power is ON, or due to some other external factor. If this happens, execute the following procedure to reset the microcomputer and return the unit to its normal operating condition.

Unplug the power cord from the wall outlet, then plug it back in while holding down the  (POWER ON/STANDBY) key.

- Please note that resetting the microcomputer will clear the contents of the memory and returns the unit to the state it was in when it left the factory.

Amplifier

Symptom	Cause	Remedy
No sound from the speakers.	<ul style="list-style-type: none"> • The speaker cords are disconnected. • VOLUME is set to the minimum position. • MUTE is ON. • The SPEAKERS switches are set to OFF. • Headphones are connected to the PHONES jack. 	<ul style="list-style-type: none"> • Connect them properly referring to "Connecting the speakers" - 16 • Adjust the volume to a proper level. • Turn OFF the MUTE. - 21 • Set the SPEAKERS switches to ON. - 20 • Unplug the headphones plug. - 22
The STANDBY indicator blinks and sound is not output.	<ul style="list-style-type: none"> • Speaker cords are short-circuited. 	<ul style="list-style-type: none"> • Turn the power off, eliminate the short-circuiting, then turn on the power again.
Sound is not output from one of the speakers.	<ul style="list-style-type: none"> • The speaker cord is disconnected. • The speaker is not set up correctly. 	<ul style="list-style-type: none"> • Connect it properly referring to "Connecting the speakers" - 16 • Set it up properly referring to "Speaker settings" - 17
Sound is not output from the surround speakers and / or the center speaker, or their sound is very small.	<ul style="list-style-type: none"> • The surround speaker cords and/or the center speaker cord is disconnected. • The speaker is not set up correctly. • A surround mode has not been engaged. • The surround and/or center volume controls are set to the minimum level. 	<ul style="list-style-type: none"> • Connect it properly referring to "Connecting the speakers" - 16 • Set it up properly referring to "Speaker settings" - 17 • Select a surround mode. • Adjust the speaker levels using the test tone. - 18
A humming noise is generated when the PHONO input selector is selected.	<ul style="list-style-type: none"> • The audio cord from the record player is not connected to the PHONO jacks. • The record player is not grounded. 	<ul style="list-style-type: none"> • Insert the audio cord plugs securely into the PHONO jacks. • Connect the grounding wire to the GND terminal on the rear panel.
When playing a Dolby Digital source signal using a DVD player, the sound is cut off soon after it starts.	<ul style="list-style-type: none"> • There are many possible causes for this problem, depending on the type of DVD player used. 	<ul style="list-style-type: none"> • Set the input mode to digital manual before starting playback of the Dolby Digital source. - 8
No sound is produced during playback from a DVD player.	<ul style="list-style-type: none"> • The input mode is set to digital manual. 	<ul style="list-style-type: none"> • Press the INPUT MODE key to select to full auto mode. - 8
A video source cannot be recorded normally.	<ul style="list-style-type: none"> • The software is copy-guarded. 	<ul style="list-style-type: none"> • Copy-guarded video software cannot be recorded.

Tuner

Symptom	Cause	Remedy
Radio stations cannot be received.	<ul style="list-style-type: none"> • No antenna is connected. • The broadcast band is not set properly. • The frequency of the desired station is not tuned. 	<ul style="list-style-type: none"> • Connect an antenna. - 16 • Set the broadcast band properly. • Tune the frequency of the desired station. - 24
Interference.	<ul style="list-style-type: none"> • Noise due to ignition noise from an automobile. • Noise due to interference from an electric appliance. • Noise due to a nearby TV set. 	<ul style="list-style-type: none"> • Install the outdoor antenna away from the road. • Turn off the power to the appliance. • Install this model farther away from the TV.
A station which was preset cannot be received by pressing the corresponding numeric key.	<ul style="list-style-type: none"> • The preset station belongs to a frequency that cannot be received. • The preset memory was cleared because the power cord had been unplugged for a long period of time. 	<ul style="list-style-type: none"> • Preset a station with a receivable frequency. • Preset the station again.

Remote control unit

Symptom	Cause	Remedy
<p>Remote control operation is not possible.</p>	<ul style="list-style-type: none"> • The remote control unit is set to the DVD player operation mode. • Batteries are exhausted. • The remote control unit is too far away from the main system, controlling angle is too large, or there is an obstacle between this model and the remote. • The remote control has not been set to the operation mode for the KENWOOD DVD player you wish to control. 	<ul style="list-style-type: none"> • Press any of the Input Selector keys to select the appropriate operation mode. • Replace with new batteries. • Operate the remote control unit within the controllable range. • Press the CD/DVD key or DVD/6CH key to activate the operation mode for the component you want to control before operation. → [36]

AUDIO section

Rated power output during STEREO operation	
IEC (20 Hz ~ 20 kHz, 0.09% T.H.D., at 6 Ω)	100 W + 100 W
DIN (1 kHz at 6 Ω)	120 W + 120 W
Effective power output during STEREO operation	
RMS (1 kHz, 10% T.H.D., at 6 Ω)	150 W + 150 W
Effective power output during SURROUND operation	
FRONT	
(20 Hz ~ 20 kHz, 0.09 % T.H.D., at 6 Ω one channel driven)	100 W + 100 W
(1 kHz, 0.7 % T.H.D., at 6 Ω one channel driven) ..	120 W + 120 W
(1 kHz, 10 % T.H.D., at 6 Ω one channel driven) ...	150 W + 150 W
CENTER	
(20 Hz ~ 20 kHz, 0.09 % T.H.D., at 6 Ω one channel driven)	100 W
(1 kHz, 0.7 % T.H.D., at 6 Ω one channel driven)	120 W
(1 kHz, 10 % T.H.D., at 6 Ω one channel driven)	150 W
SURROUND	
(20 Hz ~ 20 kHz, 0.7 % T.H.D., at 6 Ω one channel driven)	100 W + 100 W
(1 kHz, 0.7 % T.H.D., at 6 Ω one channel driven) ..	120 W + 120 W
(1 kHz, 10 % T.H.D., at 6 Ω one channel driven) ...	150 W + 150 W
SURROUND BACK	
(20 Hz ~ 20 kHz, 0.7 % T.H.D., at 6 Ω one channel driven)	100 W + 100 W
(1 kHz, 0.7 % T.H.D., at 6 Ω one channel driven) ..	120 W + 120 W
(1 kHz, 10 % T.H.D., at 6 Ω one channel driven) ...	150 W + 150 W
Total harmonic distortion	0.009 % (1 kHz, 50 W, 6 Ω)
Frequency response	
CD/DVD	10 Hz ~ 100 kHz, +0 dB ~ -3.0 dB
PHONO 'RIAA' response	40 Hz ~ 20 kHz, +1.5 dB ~ -3.0 dB
Maximum input level	
PHONO (MM)	40 mV, 1 % T.H.D., at 1 kHz
Signal to noise ratio (IHF'66)	
PHONO (MM)	75 dB
CD/DVD	95 dB
Input sensitivity / impedance	
PHONO (MM)	6 mV / 47 kΩ
CD/DVD, MD/TAPE, AV AUX, VIDEO 1, VIDEO 2, VIDEO 3, DVD/6CH	500 mV / 47 kΩ
Output level / impedance	
MD/TAPE REC	500 mV / 1 kΩ
PRE OUT (SUBWOOFER)	1 V / 1 kΩ
Tone control	
BASS	±10 dB (at 100 Hz)
TREBLE	±10 dB (at 10 kHz)
Loudness control	
VOLUME at -30 dB level	+6 dB (100 Hz)

DIGITAL AUDIO section

Sampling frequency	32 kHz, 44.1 kHz, 48 kHz, 96 kHz
Input level / impedance / wave length	
Optical	(-15 dBm ~ -24 dBm), 660 nm ±30 nm
Coaxial	0.5 Vp-p / 75 Ω

VIDEO section

VIDEO inputs / outputs	
VIDEO (composite)	1 Vp-p / 75 Ω
S VIDEO inputs / outputs	
S VIDEO (luminance signal)	1 Vp-p / 75 Ω
S VIDEO (chrominance signal)	0.286 Vp-p / 75 Ω
COMPONENT VIDEO inputs/ outputs	
COMPONENT VIDEO (luminance signal)	1 Vp-p / 75 Ω
COMPONENT VIDEO (CB/CR-signal)	0.7 Vp-p / 75 Ω

FM tuner section

Tuning frequency range	87.5 MHz ~ 108.0 MHz
Usable sensitivity	
MONO	1.3 μV (75 Ω) / 13.2 dBf (40 kHz dev, S/N 26 dB)
STEREO	45 μV (75 Ω) / 42.1 dBf (40 + 6 kHz dev, S/N 46 dB)
Total harmonic distortion	
MONO (1 kHz, 40 kHz dev)	0.2% (65.2 dBf input)
STEREO (1 kHz, 40 + 6 kHz dev)	0.8% (65.2 dBf input)
Signal to noise ratio (DIN weighted at 1 kHz)	
MONO	65 dB (65.2 dBf input)
STEREO	60 dB (65.2 dBf input)
Stereo separation (1 kHz)	36 dB
Selectivity (DIN ±300 kHz)	64 dB
Frequency response (30 Hz ~ 15 kHz)	+0.5 dB, -3.0 dB

AM tuner section

Tuning frequency range	531 kHz ~ 1,602 kHz
Usable sensitivity (30% mod, S/N 20 dB)	16 μV / (600 μV/m)
Signal to noise ratio (30% mod, 400 Hz)	50 dB (60 dBμV EMF input)

GENERAL

Power consumption	300 W
Standby Power consumption	Less than 1.5 W
AC outlet	
SWITCHED	(total 90 W max.)
Dimensions	W : 440 mm (17-5/16")
	H : 159 mm (6-1/4")
	D : 392 mm (15-7/16")
Weight (Net)	11.9 kg (26.2 lb)

Notes

1. KENWOOD follows a policy of continuous advancements in development. For this reason specifications may be changed without notice.
2. The full performance may not be exhibited in an extremely cold location (under a water-freezing temperature).

KENWOOD

For your records

Record the serial number, found on the back of the unit, in the spaces designated on the warranty card, and in the space provided below. Refer to the model and serial numbers whenever you call upon your dealer for information or service on this product.

Model _____ Serial Number _____

Free Manuals Download Website

<http://myh66.com>

<http://usermanuals.us>

<http://www.somanuals.com>

<http://www.4manuals.cc>

<http://www.manual-lib.com>

<http://www.404manual.com>

<http://www.luxmanual.com>

<http://aubethermostatmanual.com>

Golf course search by state

<http://golfingnear.com>

Email search by domain

<http://emailbydomain.com>

Auto manuals search

<http://auto.somanuals.com>

TV manuals search

<http://tv.somanuals.com>