

KENWOOD

AUDIO - VIDEO RECEIVER

VR-2090

VR-2080

KRF-V8881D

KRF-V7771D

INSTRUCTION MANUAL

KENWOOD CORPORATION

This manual contains instructions for four models.
Model availability and features (functions) may differ depending on country and sales area.

About the DTS multi-channel audio format

The DTS multi-channel audio format is available on CD, LD and DVD software. DTS is a strictly digital format and can not be decoded inside most CD, LD or DVD players. For this reason, if you attempt to listen to DTS encoded software through the analog output of your new CD, LD or DVD player, you will experience digital noise in most cases. This noise can be quite loud if the analog output is connected directly to a high power amplification system. Proper measures for playing the digital output as described below should be taken to avoid this situation. To enjoy DTS Digital Surround playback, an external 5.1 channel DTS Digital Surround decoder system or an amplifier with a built-in DTS Digital Surround decoder must be connected to the digital output (S/P DIF, AES/EBU or TosLink) of a CD, LD or DVD player.

Important: Set Up the Remote Control First

To operate your audio system correctly, it is important to first set up the remote control. The operation modes on your remote enable control over the receiver and other components in your system. Read and understand the instructions for the remote, especially how to switch operation modes.

Quick Start

To enable surround-sound in the shortest amount of time, follow the steps that are highlighted by a ☆ (star).

Before applying power

Caution : Read this section carefully to ensure safe operation.

Units are designed for operation as follows.

U.S.A. and Canada AC 120 V only
*Other countries AC 110-120/220-240 V switchable

China AC 220 V only

*AC voltage selection

The AC voltage selector switch on the rear panel is set to the voltage that prevails in the area to which the unit is shipped. Before connecting the power cord to your AC outlet, make sure that the setting position of this switch matches your line voltage. If not, it must be set to your voltage in accordance with the following direction.

Note:

Our warranty does not cover damage caused by excessive line voltage due to improper setting of the AC voltage selector switch.

AC voltage selector switch

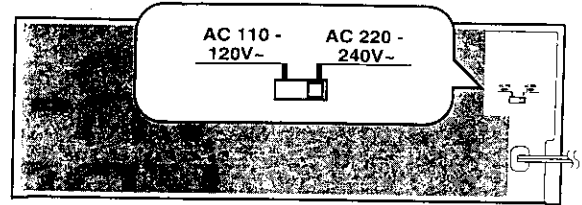

Move switch lever to match your line voltage with a small screwdriver or other pointed tool.

Safety precautions

Caution : Read this section carefully to ensure safe operation.

WARNING : TO PREVENT FIRE OR ELECTRIC SHOCK, DO NOT EXPOSE THIS APPLIANCE TO RAIN OR MOISTURE.

	CAUTION RISK OF ELECTRIC SHOCK DO NOT OPEN		CAUTION: TO REDUCE THE RISK OF ELECTRIC SHOCK, DO NOT REMOVE COVER (OR BACK). NO USER-SERVICEABLE PARTS INSIDE. REFER SERVICING TO QUALIFIED SERVICE PERSONNEL.
	THE LIGHTNING FLASH WITH ARROWHEAD SYMBOL, WITHIN AN EQUILATERAL TRIANGLE, IS INTENDED TO ALERT THE USER TO THE PRESENCE OF UNINSULATED "DANGEROUS VOLTAGE" WITHIN THE PRODUCT'S ENCLOSURE THAT MAY BE OF SUFFICIENT MAGNITUDE TO CONSTITUTE A RISK OF ELECTRIC SHOCK TO PERSONS.		
	THE EXCLAMATION POINT WITHIN AN EQUILATERAL TRIANGLE IS INTENDED TO ALERT THE USER TO THE PRESENCE OF IMPORTANT OPERATING AND MAINTENANCE (SERVICING) INSTRUCTIONS IN THE LITERATURE ACCOMPANYING THE APPLIANCE.		

Unpacking

Unpack the unit carefully and make sure that all accessories are put aside so they will not be lost. Examine the unit for any possibility of shipping damage. If your unit is damaged or fails to operate, notify your dealer immediately. If your unit was shipped to you directly, notify the shipping company without delay. Only the consignee (the person or company receiving the unit) can file a claim against the carrier for shipping damage. We recommend that you retain the original carton and packing materials for use should you transport or ship the unit in the future.

Keep this manual handy for future reference.

Accessories

Check that the following accessories are present.

Remote control unit (1)

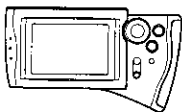

AM loop antenna (1)

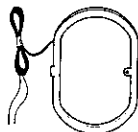

FM indoor antenna (1)



* AC plug adaptor (1)

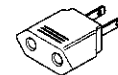

Batteries(R6/AA) (4)

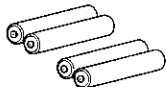

Loop antenna stand (1)

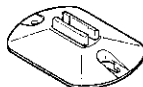

*Use to adapt the plug on the power cord to the shape of the wall outlet. (Accessory only for regions where use is necessary.)

Contents

Caution : Read the pages marked  carefully to ensure safe operation.

3

The description headlines marked with the ☆ (star) symbols show the shortest way to perform Surround Sound playback.

Introduction

Connections

Setup

RC Operations

Listening to Audio

Other

Introduction	2
△ Before applying power	2
△ Safety precautions	2
Unpacking	2
☆ Contents	3
Special features	4
Before using this unit	5
☆ How to use this manual	5
☆ System connections	6
Connection of audio components	6
Connection of video components	7
Digital connections	8
Connecting the system control	9
Speaker connections/PRE OUT connections	10
Connecting the antennas	11
FM DE-EMPHASIS / CHANNEL SPACE switch	11
Connections for remote control of other components	12
Installing the remote control transceiver	12
Making connections to another room (Room B)	13
☆ Controls and indicators	14
Turning the power on for the first time	15
Switching the display mode	15
Switching the IR RECEIVER mode	15
☆ Setup of the remote control unit	17
Controls and indicators	17
Setting up the RC according to your receiver	18
Hierarchical structure of remote control unit	19
☆ Setup for controlling AV components	21
Assigning the connected components to the selected inputs	21
Setup of components which are not listed in the Setup Codes chart (Futureset)	22
Setup for multi-room operation	24
Setup of Room A and Room B	24
Setup for playing different CDs from Room A and Room B	25
Setup of Input Level	27
Set "CD2 / Tape2"	27
☆ Setup for surround play	28
Setup for remote controlling other equipment than AV components	30
Operation in the "Function" menu	30
"Accessories" control	31
"Home Automation" control	31
Setup for macro play (automatic operation)	34
Setting up the remote control unit for macro play (automatic operation)	34
Macro Execute	36
Perfect Macro (For VR-2090/ KRF-V8881D)	36
☆ Remote control of system components	38
☆ Remote control of CD player	40
Controlling the audio in "Room A" and "Room B"	42
Convenient features	43
☆ Playing music	44
Select the speakers	45
Listening through headphones, Muting audio temporarily	45
Recording	46
Broadcast reception (U.S.A. and Canada)	48
RDS (Radio Data System) (U.S.A. and Canada)	49
Functions of RDS	49
RDS Disp. icon	49
Storing RDS stations automatically in preset memory (Auto Memory)	50
Receiving a preset RDS station	50
Manual memory of broadcast stations	51
Receiving a manually preset station	51
Receiving preset stations in the preset order (P. Call)	51
Searching for a desired program type (PTY search)	52
TP Search	54
Broadcast reception (Except for U.S.A. and Canada)	55
☆ Ambience effects	58
Sound modes	58
Available play modes	60
Surround play	61
Playback of digital input / playback of analog input	62
Checking the surround play status	62
Applying surround effect in DSP mode	63
☆ Adjusting the audio	64
In case of difficulty	65
△ Specifications	67

Connections

Setup

RC Operations

Listening to Audio

Special features

True home theater sound

DTS

DTS (Digital Theater System) is a 5.1 digital audio format that provides five full-spectrum channels and one low-frequency (subwoofer) channel for unprecedented clarity, optimum channel separation and a (wide) dynamic range. In the DTS mode, the 5.1 channel digital input from a DTS CD, LD or DVD disc (carrying the "DTS" marking) can be played in Digital Surround.

Important:

When a DTS disc is played on a CD, LD or DVD player, noise may be output from the analog output. It is recommended that you connect the digital output of the player to the digital input of this unit.

Dolby Digital (AC-3)

The Dolby Digital (AC-3) mode lets you enjoy full digital surround from software processed in the Dolby Digital (AC-3) format. Dolby Digital (AC-3) provides up to 5.1 channels of independent digital audio for better sound quality and more powerful presence than conventional Dolby Surround.

Dolby Pro Logic & Dolby 3 Stereo

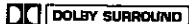
This surround system reproduces theater-like surround sound from video software marked  .

The Pro Logic mode uses the built-in adaptive matrix circuit to steer the Left, Center, Right and Surround channel audio signals. The 3 Stereo mode will redirect the surround signal to the front left and right speakers when only the front and center speakers are used.

DSP modes

The DSP (Digital Signal Processor) used for this receiver incorporates a variety of high quality adjustable sound fields, like "Arena", "Jazz Club", "Stadium", "Cathedral" and "Theater", to add the "presence" associated with an arena, jazz club or stadium (etc.) to the original signal.

Universal IR (InfraRed) remote control unit

The remote control is a multi-function unit that operates Kenwood AV components as well as those from other manufacturers. You simply enter a setup code into the remote. The remote control includes a dot matrix (64X128) LCD screen with 18 key icons, parameters and the status of the main unit. For ease of use, Kenwood placed the frequently used key icons on the first level of the hierarchy and grouped associated icons on the same screen.

Perfect Macro Operation (VR-2090/ KRF-V8881D)

The MACRO function lets you perform a series of operations automatically, like turning ON the power of the receiver and connected components, switching the input selectors, and starting playback. (Be sure to register your components before starting the macro set up procedure.) The macro setup covers the AV components from both KENWOOD and other manufacturers as well as non-audio/ video units.

Futureset, automatic update feature (U.S.A., U.S. Military and Canada)

This function lets you update the remote control so it can operate new components which do not appear in the setup code chart.

Easy surround setup and operation with LCD

This function takes advantage of LCD to simplify the surround setup procedures so you can quickly and easily match the surround processing to your speaker system, and your listening environment.

RDS (Radio Data System) (U.S.A. and Canada)

This Receiver is equipped with a RDS tuner that provides several convenient tuning functions: Auto Memory, to automatically preset up to 40 RDS stations broadcasting different programs; station name display, to show you the name of the current broadcast station; and PTY search to let you tune stations by program type.

Dual room installation capability (VR-2090: U.S.A. and Canada)

In addition to the standard "A" speaker output terminals for use in your main system, this receiver also incorporates separate "B" speaker terminals and "Room B" RCA video and stereo output jacks. This system lets you use the remote control to control and output audio and video to "Room B" independent of "Room A."

Before using this unit

Compared to standard remote controls, the remote control supplied with this receiver has several operation modes. These modes enable the remote control to perform display operations and control other audio/video components. In order to effectively use the remote control it is important to read the operating instructions and obtain a proper understanding of the remote control and how to switch its operation modes (etc.).

Using the remote control without completely understanding its design and how to switch the operation modes may result in incorrect operations.

How to use this manual

Composition of this manual

This instruction manual is composed of the following 6 chapters.

- Introduction** : Information to be read before using this unit.
Connections : Procedures for connecting other components.
Setup : Procedure for setting up the remote control unit so that it can control this unit as well as the connected components.
RC Operations : Procedures for remote controlling the connected components.
Listening Music : Procedures for playing music, listening to radio and surround play.
Other : Troubleshooting information, specification data, etc.

Example of operation description

In this manual, the menu display on the remote control unit is shown on the left half of page while the right half shows the details operating procedures, supplementary description, related notes and caution.

Remote control menu (Left side)

Operating procedure step

Operating procedure text

Menu screen used in the operating procedure

Detailed operating procedure (Right side)

Detailed operating procedure related to the menu screen on the left

1 Select the mode from the "DSP Mode" menu screen.

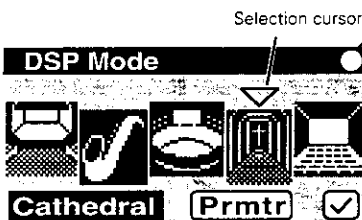

Use the joystick to move the selection cursor to the desired DSP mode and press the ENTER key.

- Arena** : the audio atmosphere in the front row of a large concert arena.
- Jazz Club** : a smaller, more intimate setting, with the listener setting close to the music.
- Stadium** : the audio environment of a vast, open-air stadium.
- Cathedral** : the musical ambience of a large, enclosed space with a high, open ceiling.
- Theater** : the crisp acoustics of theater setting.

- To adjust the audio in the "DSP Mode", select the "Prmtr" (Parameter) icon.

☆ Shortest setup for surround play



To enable surround play in the shortest amount of time, follow the steps in the table of contents that are highlighted by a ☆ (star). The ☆ (star) symbols are also found on the bottom right or left of the pages containing the shortcut steps.

Connection of audio components

The connected components shown here are given as examples because the available models vary depending on marketing areas.

Make connections as shown below.

When connecting the related system components, refer also to the instruction manuals of the related components.

⚠ Do not plug in the power lead until all connections are completed.

Also connect the system control cords when the KENWOOD Audio Component System is connected.

Malfuction of microcomputer

If operation is not possible or erroneous display appears even though all connections have been made properly, reset the microcomputer referring to "In case of difficulty".

*1 To the CD2/TAPE2 MONITOR jacks, connect a second CD player, second cassette deck or a graphic equalizer. Do not connect system control cord to the unit (except for graphic equalizer) connected to the CD2/TAPE2 MONITOR jacks.

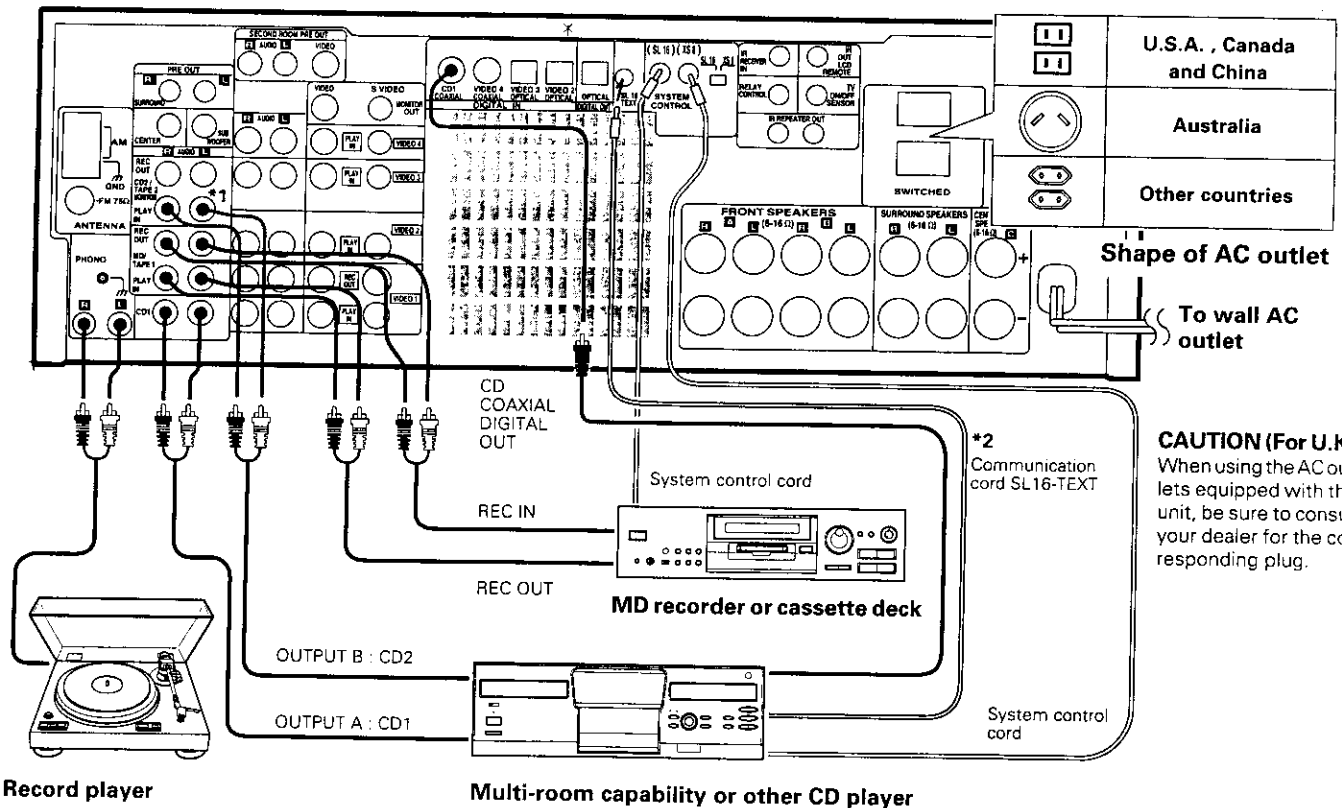

Record player

Multi-room capability or other CD player

*2 Note on the SL-16 TEXT jack (provided except for some destination areas): When using a KENWOOD CD player equipped with the SL-16 TEXT jack, connect it to this unit using the communication cord provided with the CD player. This makes it possible to display the disc and track titles on the remote control unit (provided with this unit). Do not forget to set the SL-16 / XS-8 switches of the CD player and this unit to SL-16.

Caution regarding placement (Except for U.S.A. and Canada)

To maintain proper ventilation, be sure to leave a space around the unit (from the largest outer dimensions including projections) equal to, or greater than. Left and right panels : 10 cm, Rear panel : 10 cm, Top panel : 50 cm

Ventilation fan

The ventilation fan runs during high-power reproduction. To allow for proper ventilation, maintain a certain distance (more than about 10 cm, 4 inches) between the wall and the rear of the component.



1. Connect all cords firmly. Loose connections may prevent proper sound transmission or produce noise.
2. Be sure to remove the power cord from the AC outlet before plugging or unplugging any connection cords. Plugging/unplugging connection cords without disconnecting the power cord can cause malfunctions and may damage the unit.
3. Do not connect power cords from components whose power consumption is larger than what is indicated on the AC outlet at the rear of this unit.



Connection of video components

The connected components shown here are given as examples because the available models vary depending on marketing areas.

Make connections as shown below.

When connecting the related system components, refer also to the instruction manuals of the related components.

⚠ Do not plug in the power lead until all connections are completed.

Also connect the system control cords when the KENWOOD Audio Component System is connected.

even the

CD

t for TOR

st

U.K.)
Cout-
th this
onsult
e cor-

SL-
the

ater

ches)

action

ear of

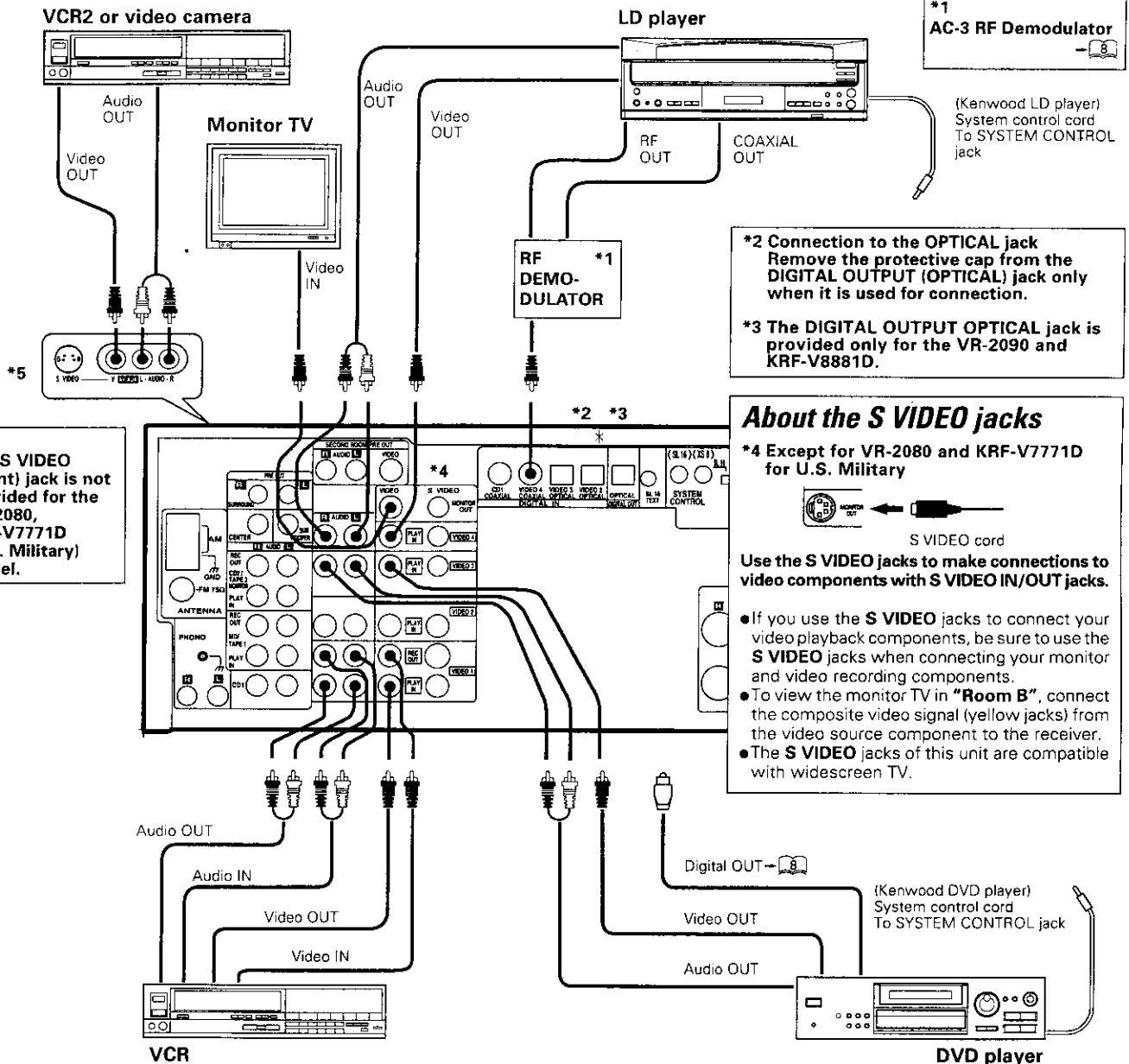

***1**
AC-3 RF Demodulator

(Kenwood LD player)
System control cord
To SYSTEM CONTROL
jack

***2** Connection to the OPTICAL jack
Remove the protective cap from the
DIGITAL OUTPUT (OPTICAL) jack only
when it is used for connection.
***3** The DIGITAL OUTPUT OPTICAL jack is
provided only for the VR-2090 and
KRF-V8881D.

About the S VIDEO jacks
***4** Except for VR-2080 and KRF-V7771D
for U.S. Military

S VIDEO cord
Use the S VIDEO jacks to make connections to
video components with S VIDEO IN/OUT jacks.
● If you use the S VIDEO jacks to connect your
video playback components, be sure to use the
S VIDEO jacks when connecting your monitor
and video recording components.
● To view the monitor TV in "Room B", connect
the composite video signal (yellow jacks) from
the video source component to the receiver.
● The S VIDEO jacks of this unit are compatible
with widescreen TV.

***5**
The S VIDEO
(Front) jack is not
provided for the
VR-2080,
KRF-V7771D
(U.S. Military)
model.

● To connect a Video CD compatible CD player and outputs its video, connect the player to one of the sets of input jacks VIDEO1 to VIDEO4. In this case, do not connect the system control cord to the CD player.

DTS disclaimer clause
When Playing DTS-encoded CDs, excessive noise will be exhibited from the analog stereo outputs. The consumer should take proper precautions when the analog stereo outputs of the CD player is connected to an amplification system. To enjoy DTS Digital Surround playback, an external 5.1 channel DTS Digital Surround decoder system must be connected to the digital output (S/PDIF, ASE/EBU, or TosLink) of the CD, LD or DVD player.



Digital connections

Make connections as shown below.

The digital in jacks can accept either DTS, Dolby Digital (AC-3) or PCM (CD Format) signals (the input signal type is detected automatically).

When connecting the related system components, be sure to also refer to the instruction manuals supplied with the components you are connecting.

Do not connect the power cord to a wall outlet until all connections are completed.

The connected components are given as examples because the available models vary depending on marketing areas.

Connect components capable of outputting Dolby Digital (AC-3) or standard PCM format digital signals.

LASER DISC RF DEMODULATOR (DEM-9991D)

Note: Only required if you wish to play Laser Discs in the Dolby Digital (AC-3) format

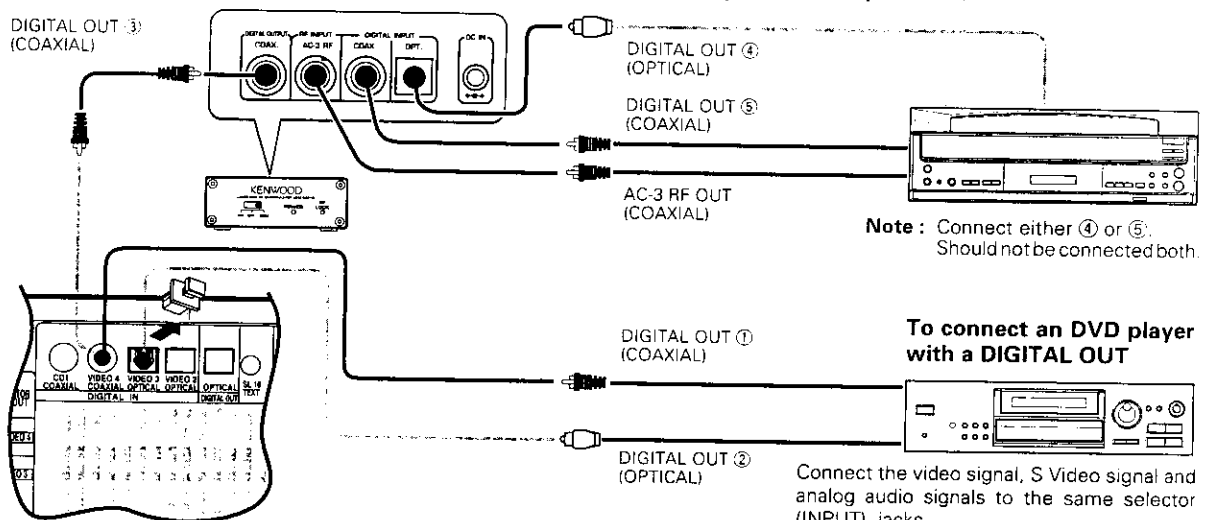

Note: Connect either (4) or (5). Should not be connected both.

To connect an DVD player with a DIGITAL OUT

Connect the video signal, S Video signal and analog audio signals to the same selector (INPUT) jacks. (See "Connecting of video components".)

Use either the (1) (COAXIAL) or (2) (OPTICAL) jack for the connection of a DVD player. To the VIDEO 4 COAXIAL jack, connect the input from the DIGITAL OUT (1) (COAXIAL) jack of a DVD player or the DIGITAL OUT (3) (COAXIAL) jack of the DEM-9991D.

LASER DISC RF DEMODULATOR DEM-9991D (Optional)

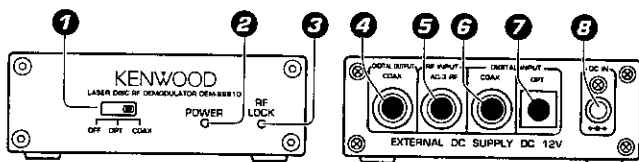

1 POWER switch

Use to switch the POWER OFF/ POWER ON (OPT./ COAX.). With the OPT. or COAX. position, the input is switched automatically to the Dolby Digital (AC-3) RF input whenever the Dolby Digital (AC-3) RF signal is input.

2 POWER indicator

Lights (red) when the power switch (1) is set to ON (OPT./ COAX.).

3 RF LOCK indicator

Lights when a Dolby Digital (AC-3) RF signal is input to the RF INPUT (AC-3 RF INPUT) jack (5). (This indicator is extinguished when a digital input is in use.)

4 DIGITAL OUTPUT COAX. (COAXIAL)

Connect this jack to the VIDEO4 COAXIAL (DIGITAL IN), jack on your Receiver. It outputs Dolby Digital (AC-3) coaxial digital signals when the POWER (1) is set to COAX. and a Dolby Digital (AC-3) RF signal is input to the RF INPUT (AC-3 RF INPUT) jack (5).

Place the power supply away from the demodulator, receiver, and any antennas.

5 RF INPUT AC-3 RF (Dolby Digital RF)

Connect this jack to the Dolby Digital (AC-3) RF OUTPUT jack on your LD player.

6 DIGITAL INPUT COAX. (COAXIAL)

Connect this jack to the COAXIAL OUTPUT jack on your LD player.

7 DIGITAL INPUT OPT. (OPTICAL)

Connect this jack to the OPTICAL OUTPUT jack on your LD player.

When there are simultaneous inputs through the RF INPUT (AC-3 RF) jack and DIGITAL INPUT jack, the input through RF INPUT (AC-3 RF) is given the priority.

8 DC IN 12V jack

Connect this jack to the AC adaptor supplied with your demodulator. Connect the AC adaptor to a wall outlet after completing all of the other connections.

Connecting the system control

Connecting system control cords after connecting a KENWOOD audio component system lets you take advantage of convenient system control operations. There are two KENWOOD system control modes. Make connections according to the groups of terminal symbols shown below.

- [XS8] Mode : lets you combine [XS], [XS8], and [XR] terminals
- [SL16] Mode : for [SL16] terminals only

This unit is compatible with both [XS8] and [SL16] modes. It comes from the factory set to the [SL16] mode. To switch to the [XS8] mode, follow the instructions in "SWITCHING FROM [SL16] TO [XS8]" below.

EXAMPLE: [XS8] mode connections

The underlined portion represents the setting of the system control mode.

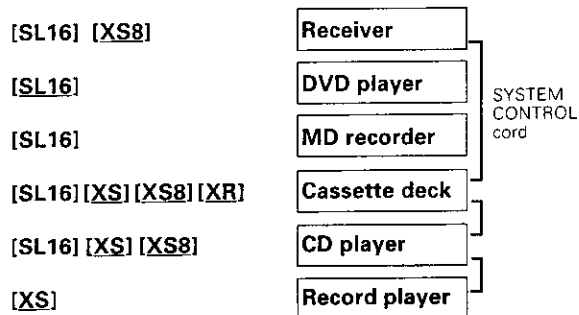

EXAMPLE: [XS16] mode connections

The underlined portion represents the setting of the system control mode.

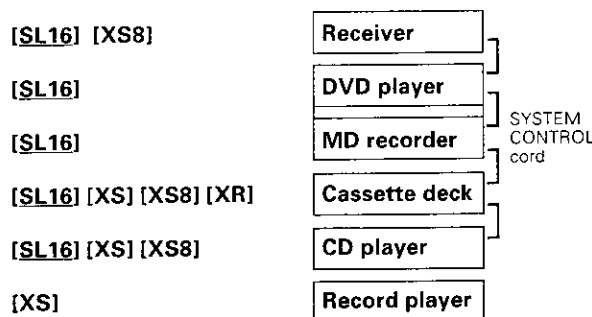

- In order to take advantage of the system control operations, the components must be connected to the correct jacks. To use a CD player it must be connected to the CD jacks. To use a cassette deck (or MD recorder) it must be connected to the TAPE1/MD jacks. When using more than one CD player (etc.) only the one connected to the specified jacks may be connected for system control.
- Some CD players and cassette decks are not compatible with the [SL16] system control mode. Be sure to use the [XS8] system control mode when making system connections with equipment that is not [SL16] compatible.
- Some MD players are not system-control compatible. The system control function is not available when a MD player is used by connecting it through a digital input. You cannot connect the system control cord to this kind of equipment.



1. [SL16] equipment cannot be combined with [XR], [XS], and [XS8] equipment for system operations. If your equipment consists of this kind of combination, please do not connect any system control cords. Even without system control cords, normal operations can be carried out without effecting performance.
2. Do not connect system control cords to any components other than those specified by KENWOOD. It may cause a malfunction and damage your equipment.
3. Be sure the system control plugs are inserted all the way in to the system control terminals.



SYSTEM CONTROL OPERATIONS

Remote Control

Lets you operate this unit with the system remote supplied with the receiver.

Automatic Operation (except [XR] equipment)

When you start playback from a source component, the input selector on this unit switches to that component automatically.

Synchronized Recording (except [XR] equipment)

Lets you synchronize recording with the start of playback when recording from CD, MD or analog discs.

SWITCHING FROM [SL16] TO [XS8]

You can easily change the system control mode by adjusting the position of the SYSTEM CONTROL switch on the rear panel. Do this operation after completing all connections.

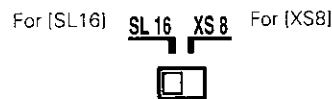

- This operation will not effect items stored in the memory.
- After switching the system control mode, turn the power off and then on once to confirm the new setting.

Registering setup codes for KENWOOD audio components

- Once you finish making the system connections, be sure to register the appropriate setup code for each component.
- If you own remote controllable KENWOOD audio components that are not compatible with system control (or cannot be combined with your other system control components), registering the setup code enables you to control those components using the remote control supplied with this unit (without connecting system control cords). To register setup codes for your remote controllable KENWOOD audio components, see "Setup for controlling AV components".

Speaker connections/PRE OUT connections

*1 The front speaker impedance is variable depending on the area where the unit is sold. Read the note printed on the rear panel of the unit.

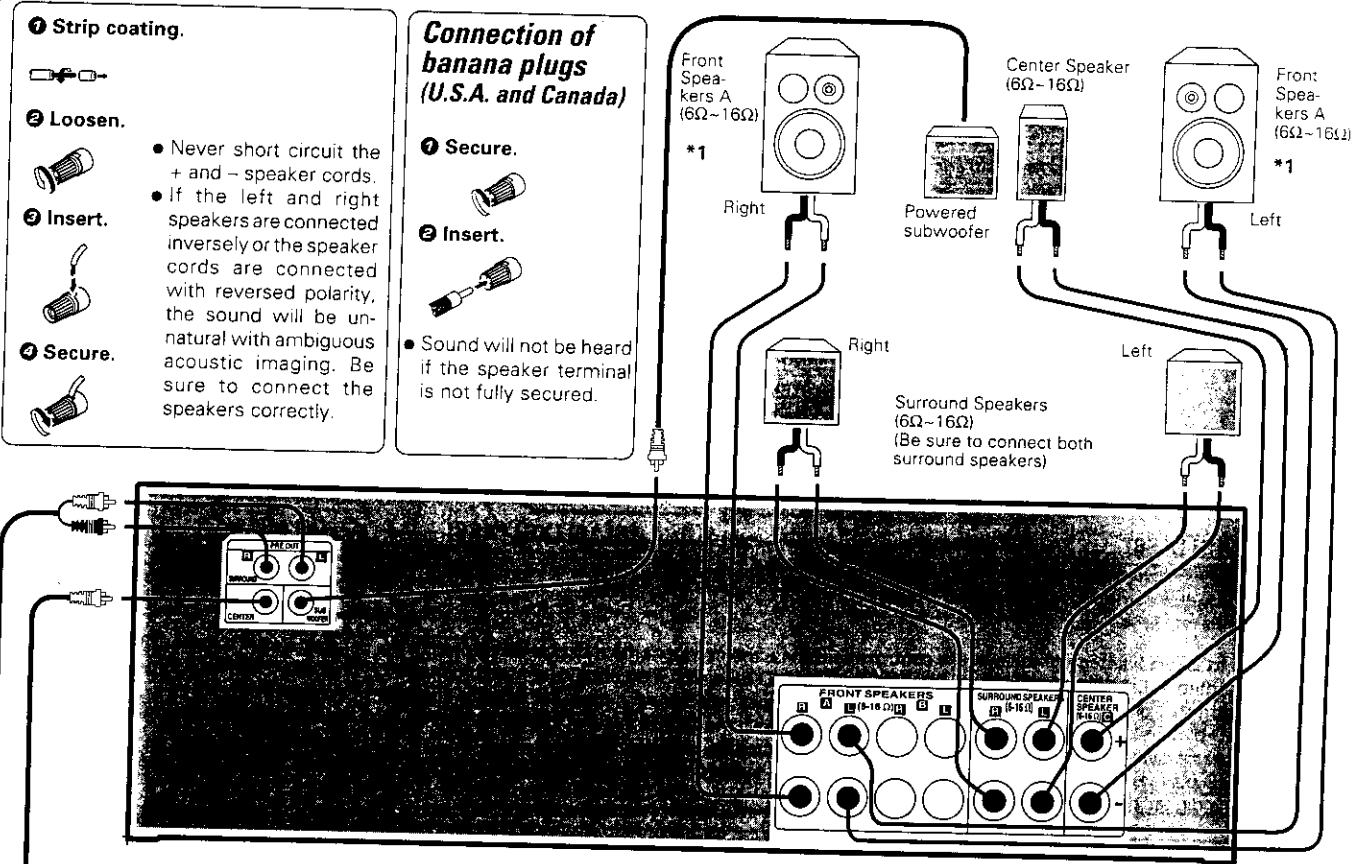

PRE OUT connections

This receiver has additional pre out jacks. These can be used for various purposes, but will need to be connected to an external power amplifier as shown in the example below. Connecting a speaker cord directly to a PRE OUT jack will not produce any sound from the speaker.

Be sure to set the **SPEAKERS A** key to the **ON** position when using the **PRE OUT** jacks in Room A.

No sound is output from the **SUBWOOFER** jack when the **SPEAKERS A** key is set to the **OFF** position.

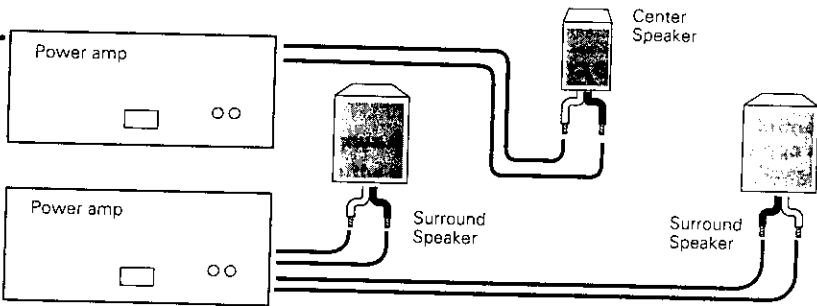

Connecting the antennas

Area
of

Make connections as shown below.
Do not connect the power cord to a wall outlet until all connections are completed.

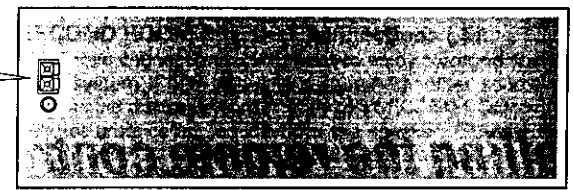
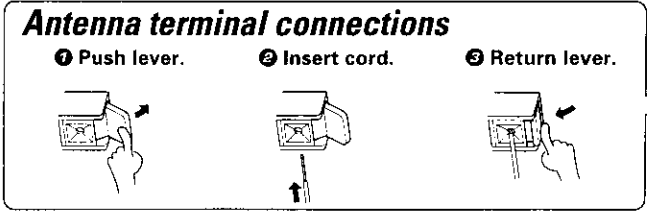

AM loop antenna

The supplied loop antenna is for use indoors. Place it as far as possible from the receiver, TV set, speaker cords and power cord, and adjust the direction for best reception.

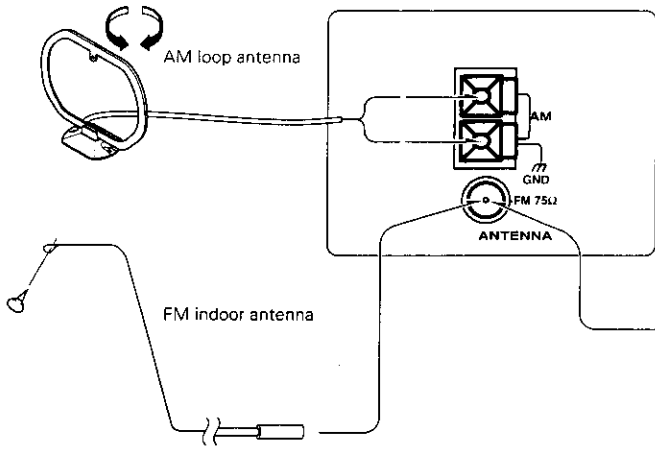

FM indoor antenna

The supplied indoor antenna is for temporary use only. For stable signal reception we recommend using an outdoor antenna. Disconnect the indoor antenna when you connect one outdoors.

FM outdoor antenna

Lead the 75Ω coaxial cable connected to the FM outdoor antenna into the room and connect it to the FM 75Ω terminal.

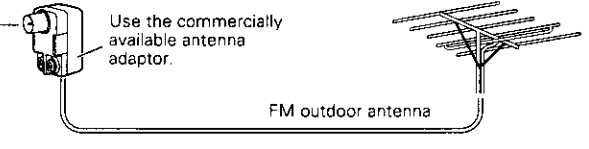
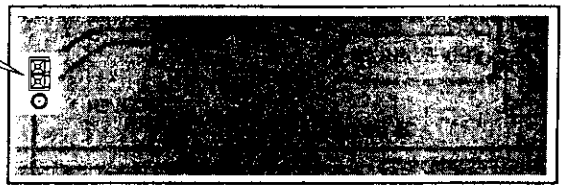

plifier

FM DE-EMPHASIS / CHANNEL SPACE switch

(Except for U.S.A., Canada, China and Australia)

The FM DE-EMPHASIS / CHANNEL SPACE switch on the rear panel is set to the correct setting that prevails in the area to which the unit is shipped. However, if the FM DE-EMPHASIS / CHANNEL SPACE setting is not matched to the area where the unit is to be used; for instance, when you move from area 1 to area 2 or vice versa, desired reception of AM / FM broadcasts is not expected. In this case, change the FM DE-EMPHASIS / CHANNEL SPACE setting in accordance with the area corresponding to the table. The FM DE-EMPHASIS is switched over at the same time.

- When changing the setting of the FM DE-EMPHASIS / CHANNEL SPACE switch, first disconnect the power cord, then reset the channel space switch, connect the power cord again, and turn the power on.

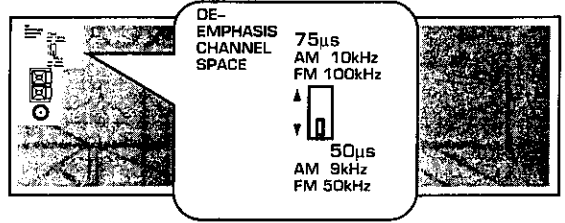

Area	CHANNEL SPACE freq.	FM DE-EMPHASIS
1 U.S.A., Canada, and South American countries	FM: 100 kHz AM: 10 kHz	75 µs
2 Other countries	FM: 50 kHz AM: 9 kHz	50 µs

Connections for remote control of other components

VR-2090/VR-2080/KRF-V8881D/KRF-V7771D (En/K)

The remote control unit provided with this unit can be used to control the components as a system by utilizing a commercially available infrared control unit or wired control unit.

By installing the IR RECEIVER and speakers in another room, the system in another room can be remote controlled. To control the desired components from another room, set the remote control unit to the Room B control mode.

Preparation

To remote control the components in your AV room as a system, make preparations such as the operations described in "Installing the remote control transceiver", "Making connections to another room (Room B)" and "Setup for multi-room operation".

Installing the remote control transceiver

The following connections (③④⑤) are only available for VR-2090 sold in the U.S.A. and Canada.

Connect the remote control transceiver, sensor and controller as shown in the illustration.

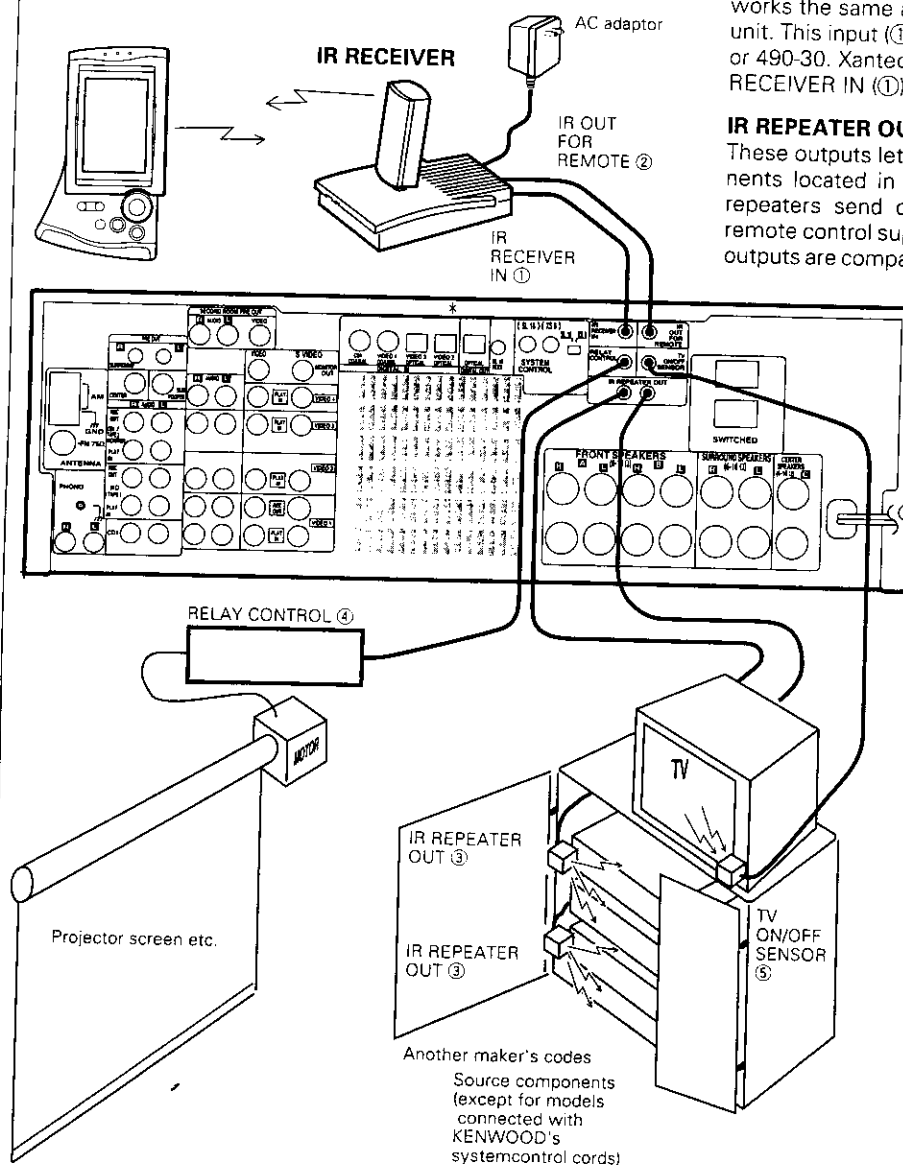

IR RECEIVER : (Optional, to be released in future)
IR RECEIVER IN ①, IR OUT FOR REMOTE ② :

These input and output let you connect an external IR receiver to enable remote control of this unit even if it is located in a cabinet or behind glass doors (etc.). The external IR receiver works the same as the IR receiver located on the front of this unit. This input (①) is compatible with Xantech 291-80, 480-30 or 490-30. Xantech 291-80, 480-30 or 490-30 are for use of IR RECEIVER IN (①) (RC sensor) only.

IR REPEATER OUT ③ : (Optional)

These outputs let you connect IR repeaters to control components located in cabinets or behind glass doors (etc.). The repeaters send out signals corresponding to those of the remote control supplied with the respective equipment. These outputs are compatible with Xantech 282-00, 286-00 or 283-00.

The IR REPEATER OUT terminals may only be used when an external IR receiver is connected to the IR RECEIVER IN terminal.

RELAY CONTROL ④ : (Optional)

This output is designed to operate external devices and is compatible with the Xantech 599-00 Pulse Switching Module. Do not exceed maximum current by connecting multiple 599-00 modules. Please consult the instruction manual of the external device for compatibility and installation instructions before attempting connections to your new receiver. Improper installation, or connection of non-compatible equipment, may damage this control output. Please consult the dealer where the external equipment was purchased or a competent installation specialist for more information.

TV ON/OFF SENSOR ⑤ : (Optional)

This sensing is used in the "Perfect Macro" feature to tell the TV ON/OFF. This input is compatible with JDS: PSS-TV or NILES: LS-1, APC-2.

Making connections to another room (Room B)

The following connections allow you to connect your main system to a monitor TV and speaker system located in another area (Room B). The monitor TV can be connected directly to the SECOND ROOM PRE OUT VIDEO jack. To connect the speakers, use either of the connections described below.

To select the input and adjust the volume (etc.) for your other area (Room B), set the remote control to the Room B operation mode.

FRONT SPEAKERS B connections (①):

These connections allow you to connect the speakers in Room B directly to the receiver without using an additional power amplifier. The sound from the main system (Room A) automatically switches to stereo when SPEAKERS B are turned on.

- If the Room B operation is not set, the speakers in another room can be used as SPEAKERS B.

SECOND ROOM PRE OUT connections (②):

Use these connections if you want to enjoy surround sound from your main system (Room A) while outputting another source to Room B. Connecting a speaker cord directly to a SECOND ROOM PRE OUT jack will not produce any sound from the speaker. Connect the SECOND ROOM PRE OUT jacks to powered speakers or power amplifiers connected to speakers.

- To view the monitor TV in "Room B", connect the composite video signal (yellow jacks) from the video source component to the receiver.

The SECOND ROOM PREOUT terminal is only available for VR-2090 sold in the U.S.A. and Canada.

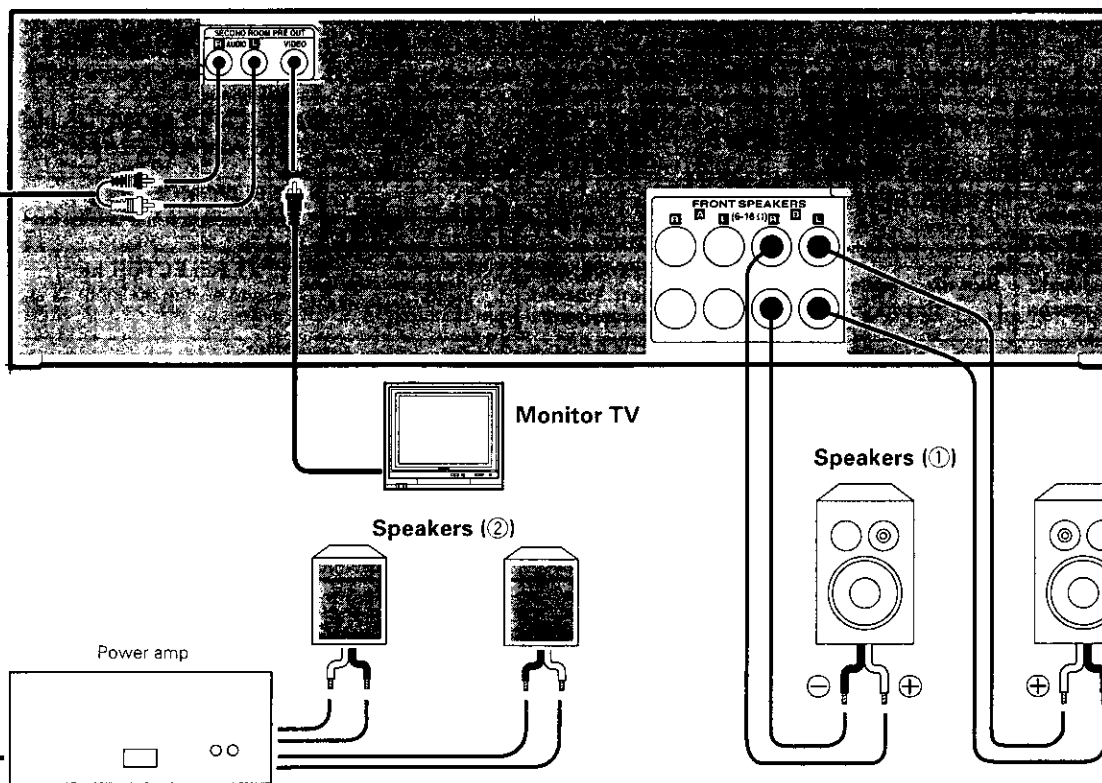
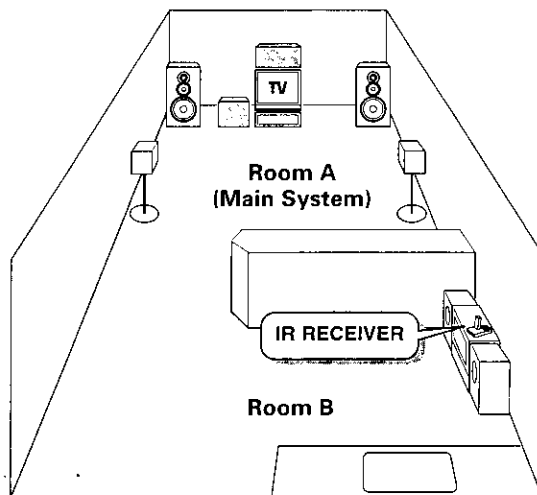

tem, stall- is to on".

iver in a iver this)-30 f IR

po- The the ese -00.

ray re- /ER

ter- the ile. on- ase ex- illa- on- per at- trol ere for ore

al) 'o" TV

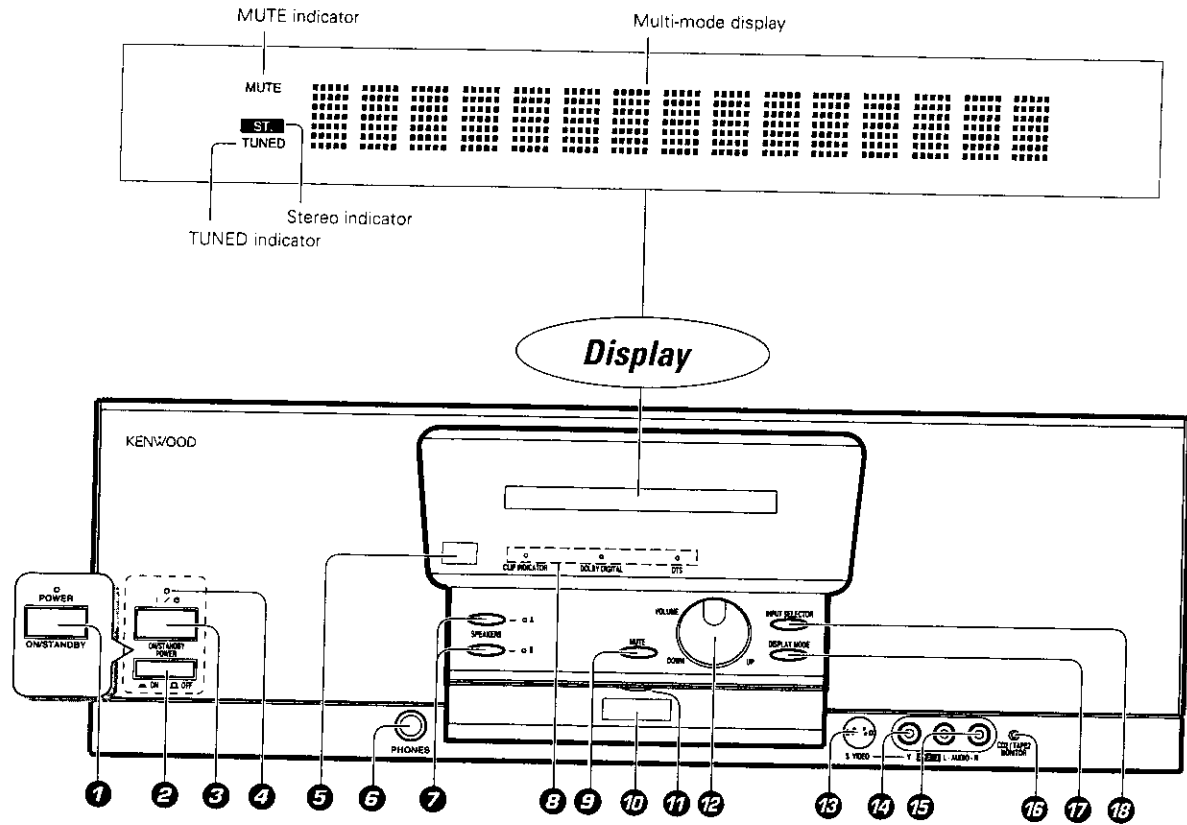

1 POWER key

(U.S.A., U.S.Military and Canada)
Press to switch power ON and OFF.

2 POWER key

(Except for U.S.A., U.S.Military and Canada)
(China : ① POWER)
Press to switch the main power ON and OFF.

3 ON/STANDBY key

(Except for U.S.A., U.S.Military and Canada)
Press to switch the power mode between STANDBY and ON.

4 STANDBY indicator

Lights in STANDBY mode.

5 RC sensor

Receives signals transmitted from the remote control unit.

6 PHONES jack

Use for listening to audio through headphones.

7 SPEAKERS keys

Press each key to switch the SPEAKERS A or SPEAKERS B ON and OFF.

8 Indicators

CLIP INDICATOR :

Lights when the input is clipped during analog to digital signal conversion. → [27]

DOLBY DIGITAL :

Lights when Dolby Digital is activated. → [60]

DTS :

Lights when the DTS is activated. → [60]

9 MUTE key

Press to mute the audio temporarily. → [45]

10 RC transmitter

Sends signals to the remote control unit.

11 Indicator

Lights when signal is input from or output to the remote control unit.

12 VOLUME control knob

Rotate to adjust the volume.

13 S VIDEO input jack

(Except for the VR-2080 or the KRF-V7771D for the U.S. Military destination)
Connect the S VIDEO output jack of an AV component.

14 VIDEO input jack

Connect the composite video output (RCA) jack of an AV component.

15 AUDIO (L, R) input jacks

Connect the audio output (RCA) jacks of an AV component.

16 CD2/TAPE2 MONITOR indicator

Lights when the CD2/Tape2 (Monitor) input is used. → [46]

17 DISPLAY MODE key

Press to switch the display on the main unit. → [15]

18 INPUT SELECTOR key

Press to switch the input as shown below.
TUNER
CD1
MD/Tape1
VIDEO1
VIDEO2
VIDEO3
VIDEO4
AV AUX
PHONO

STANDBY indication

While standby indicator is indicated, a small amount of power is supplied to the system to back up the memory. In this mode, the system can be turned ON by remote control.



Turning the power on for the first time

- ① Check that all of the connections have been made properly.
- ② Plug the power cord into an AC wall outlet.
- ③ Push the Power key on the front panel. (Except for U.S.A., U.S. Military and Canada)
- ④ Press the ON/STANDBY key on the front panel.

Switching the display mode (DISPLAY MODE key)

Use the following procedure to switch the mode of the main unit display.

- ① Press the DISPLAY MODE key.

Each press switches the mode as follows.

→ Connected component, analog/digital display → Input and connected component name display → Listen mode display →

(Example)	(Example)	(Example)
DVD DGTL	VIDEO3 : DVD	DOLBY DIGITAL
(VIDEO3 DGTL)	(VIDEO3 :)	

The display inside () is shown when the connected component name is not assigned.

Switching the IR RECEIVER mode (DISPLAY MODE key)

Use the following procedure to switch the IR remote control signal sensor (transmitter) in use between the transmitter on the main unit and the IR RECEIVER.

- ① Press and hold the DISPLAY MODE key for more than 2 seconds.

Each holding switches the mode as follows. (Possible with the VR-2090)

→ IR RECEIVER OFF → IR RECEIVER B → IR RECEIVER A →

In case the multi-room function is not provided (i.e. except for the VR-2090)

→ IR RECEIVER OFF → IR RECEIVER ON →

IR RECEIVER setting

The following table shows the IR RECEIVER setting and the status of associated functions.

IR RECEIVER Setting	IR RECEIVER OFF (Common setting for all models)	IR RECEIVER B (Possible with the VR-2090)	IR RECEIVER A (Possible with the VR-2090)	IR RECEIVER ON (Possible with other models than VR-2090)
Purpose	Do not use the IR RECEIVER.	Enables the "Room A" and "Room B" setting.	Use the IR RECEIVER in "Room A".	Use the IR RECEIVER.
Main Unit sensor/ transmitter	Use the main unit sensor/ transmitter	Use the main unit sensor/ transmitter in "Room A".	Disables the main unit sensor/ transmitter.	Disables the main unit sensor/ transmitter.
IR RECEIVER's sensor (transmitter)	Disables the use.	Uses the IR RECEIVER's sensor (transmitter) in "Room B".	Uses the IR RECEIVER's sensor (transmitter).	Uses the IR RECEIVER's sensor (transmitter).

Controls and indicators

The Remote Control unit provided with the Receiver can also control KENWOOD MD recorder, cassette decks, CD player, DVD player and LD player which are connected to it through system control cords. For details of the controllable functions, refer to the instruction manuals of these components.

RC : Infrared system

Perform "Model Type Setup" of the RC before using it. The following menu display appears after the batteries are loaded for the first time.

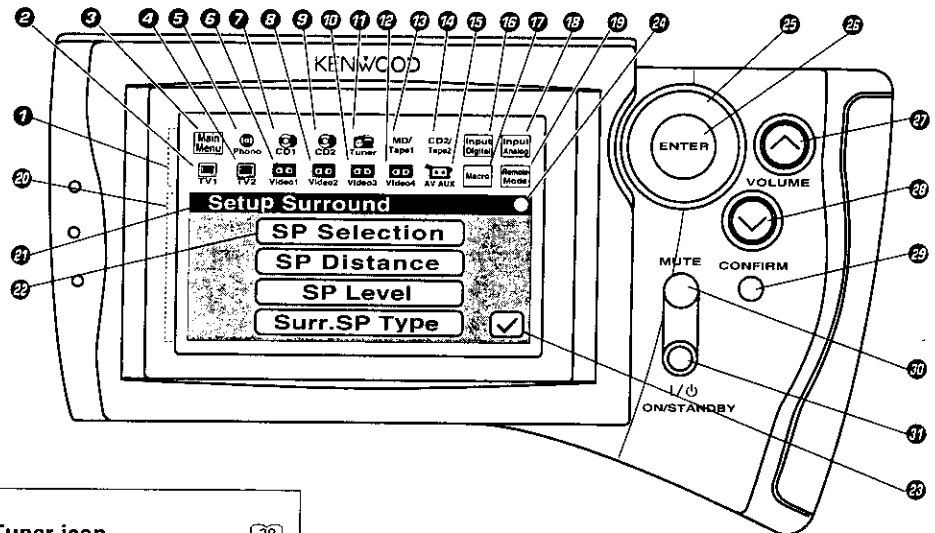

Segment screen

- | | |
|--|--|
| <p>1 Segment screen
The fixed icons are displayed in this area.</p> <p>2 TV1 icon - [39]
Select to display the TV1 control screen.</p> <p>3 Main Menu icon - [19]
Select to display the Main Menu screen.</p> <p>4 TV2 icon - [39]
Select to display the TV2 control screen.</p> <p>5 Phono icon - [39]
Select to select the PHONO input.</p> <p>6 Video1 icon - [39]
Select to control Video1.</p> <p>7 CD1 icon - [25]
Select to control CD1.</p> <p>8 Video2 icon - [39]
Select to control Video2.</p> <p>9 CD2 icon - [25]
Select to control CD2. (Room B only)</p> <p>10 Video3 icon - [39]
Select to control Video3.</p> | <p>17 Tuner icon - [38]
Select to control Tuner.</p> <p>18 Video4 icon - [39]
Select to control Video4.</p> <p>19 MD/Tape1 icon - [38]
Select to control MD or Tape1.</p> <p>20 CD2/Tape2 icon - [46]
Select to monitor the CD2/Tape2 input. (Room A only)</p> <p>21 AV AUX icon - [39]
Select to select the AV AUX input.</p> <p>22 Input Digital icon - [62]
Select to play a digital input or to switch between Auto and Manual.</p> <p>23 Macro icon - [34]
Select to control Macro.</p> <p>24 Input Analog icon - [62]
Select to play an analog input.</p> <p>25 Remote Mode icon - [46]
Select to switch the remote control operation mode without changing the selected input.</p> |
|--|--|

The displayed icons are variable depending of the "Model Type Setup" for matching specifications with the Receiver which uses the RC unit and "Setup" for matching specifications with connected source component.

Menu screen

- 26 Menu screen** - [19]
Control key icons and control levels are displayed in this area.
- 27 Status display** - [19]
The example in the illustration shows the "Setup Surround" status.
- 28 SP Selection icon** - [19]
Select to set up the speakers.
- 29 Return icon** - [19]
Select to return to the previous menu screen.
- 30 Status display** - [19]
Shows the communication status.

Operation keys

- 25 Joy stick key** - [18]
This key is used to select an icon. This key can be controlled in 4 directions.
- 26 ENTER key** - [18]
Press to enter the selection of an icon.
- 27 VOLUME (up) control key**
Press to increase the volume.
- 28 VOLUME (down) control key**
Press to decrease the volume.
- 29 CONFIRM key**
Press to select the currently displayed items.
- 30 MUTE key** - [45]
Press to mute the audio temporarily.
- 31 I/O (ON/STANDBY) key**
Press to turn this unit and the components connected to it through system cords between ON and STANDBY modes.

Approximate operating range

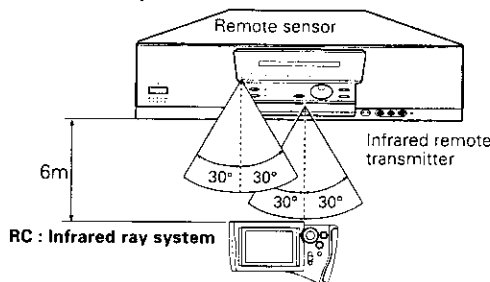

- Notes**
- The supplied batteries are intended for use in operation check. Therefore, their lives may be shorter than ordinary batteries.
 - When the remote-controllable distance gets shorter than before, replace all four batteries with new ones.
 - Malfunction may occur if direct sunlight or the light of a high-frequency lighting fluorescent lamp enters the remote sensor. In such a case, change the system installation position to prevent the malfunction.
 - The RC display may show erroneous information when the RC unit is operated from outside the specified range.

Setting up the RC according to your receiver

Perform the following procedure after inserting batteries for the first time or when the remote control back-up data has been lost.

Preparations

- Press the **POWER** key and **ON/STANDBY** key of the main unit to turn it ON. With some models sold in certain areas, simply pressing the **ON/STANDBY** key turns the unit ON.

Low battery alarm



When the alarm message appears to indicate that the remaining power is low, replace all the batteries with new ones.

Model Type Setup

1 Loading batteries

- 1 Remove the cover.
- 2 Insert batteries.
- 3 Close the cover.

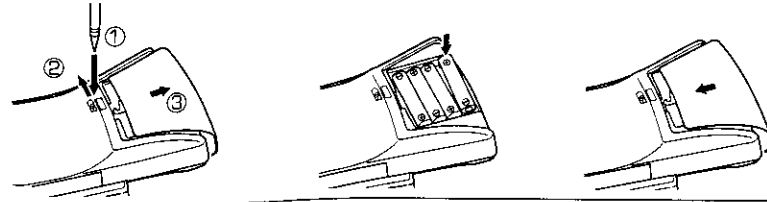

- Insert four AA-size (R6/UM-3) batteries as indicated by the polarity marking.
- To maintain the memory of the settings you made before, complete the battery replacement operation within 30 seconds.

2 Check the display.

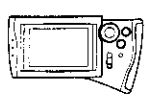

The "Model Type Setup" screen appears.

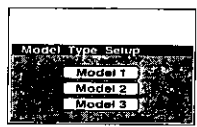

- if the remote control backup data is stored when the batteries are replaced, the "Model Type Setup" menu screen is not displayed. In this case, operations in 2, 3, 4 are not necessary.

3 Move the cursor to the Model type icon matching the receiver.

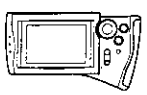

- 1 Identify the model type. (use the table on the right).
- 2 Move the cursor. It can be moved in 4 directions, depending on how you select the icon.

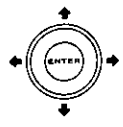

The icon on which the cursor is moved blinks in reverse video.

Main unit (RECEIVER): Model name	Remote: "Model Type Setup" icon
VR-2090	MODEL 1
VR-2080 , KRF-V7771D (U.S.Military)	MODEL 2
KRF-V8881D, KRF-V7771D (Except for U.S.Military)	MODEL 3

4 Enter the selection.



Press the ENTER key.

- After selecting an icon, always be sure to press the **ENTER** key to enter the selection.

To change "Model Type Setup"

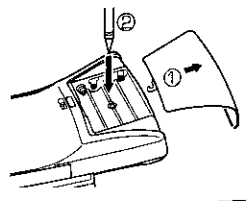

- 1 Open the cover and remove batteries.
 - 2 Press the reset button with the tip of a thin object for a few seconds.
- Use the same procedure also to reset the remote control unit (in case it malfunctions, etc.).
 - This operation clears all of the previously set-up data.

Hierarchical structure of remote control unit

The remote control unit is given with a hierarchical structure so that it can display a large number of functions. For instance, the menu screen for use in setup can be accessed from the menu screen as shown below.

① To display the "Main Menu" screen containing the "Setup" menu screen, first select the "Main Menu" icon from the fixed segments.

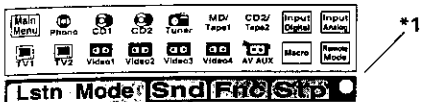

The "Main Menu" screen includes the "Lstn Mode" (Listen Mode), "Sound", "Function" and "Setup" menu screens under it. These menu screens can be displayed by moving the cursor on "Main menu" icons "Lsn", "Snd", "Fnc" and "Stp" respectively.

The Main Menu screen has the following 4 menu screens under it.

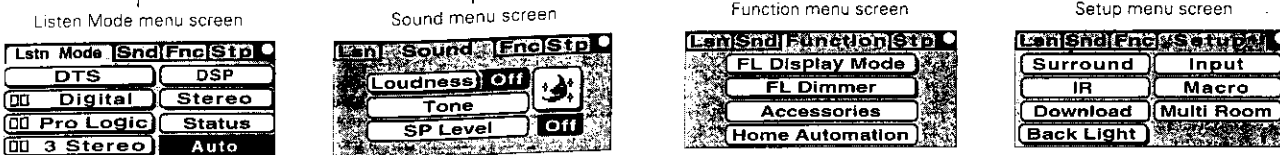

② Move the "Stp" icon in the "Main Menu" screen to display the "Setup" menu screen.

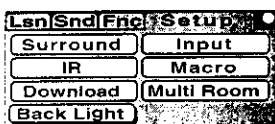

- Selecting an icon displayed inside a shaded frame (the "Back Light" icon in this example) activates the function of the icon.
- The icons displayed inside non-shaded frames (the "Surround", "IR", "Download", "Input", "Macro" and "Multi Room" icons in this example) have menu screens in the hierarchies below them.

③ Select the "Surround" icon to display the "Setup Surround" menu.

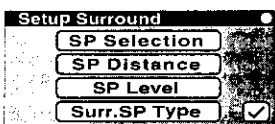

***1 : Communication status display**

- ⬆ Transmitting
- ⬇ Receiving
- ⊗ Transmission/ reception inhibited

④ If the "SP Selection" icon is selected...



⑤ If the "Next" icon is selected...

(If "Custom Setup" is selected)



(If "Next" is selected)

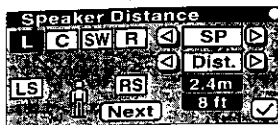

⑥ If "Next" is selected...

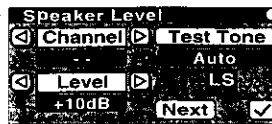

⑦ If "Next" is selected...



To return to higher hierarchy level

- Select the "✓" (checkmark) icon to return to the menu screen in the hierarchy level immediately above the current level.
- Select the "Main Menu" icon to return to the "Main Menu" screen at the highest level.

Setup for controlling AV components

The operations in this section consist of defining the relationship between the input selections displayed on the panel and the components connected to the rear panel jacks.

Assigning the connected components to the selected inputs

General setup flow

- 1 Opening the "Setup" menu
- 2 Opening the "Setup IR" menu screen
- 3 Assigning connected components to the displayed inputs
- 4 Completing the assignment of all the connected components

1 Select the "Main Menu" icon.



- 1 Select the "Stp" icon in the "Main Menu" to display the "Setup" menu.

2 Perform icon selection in the "Setup" menu.

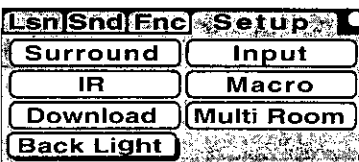

- The "Setup" menu screen shown on the left appears when the "Stp" icon is selected.
- 2 Select the "IR" icon in the "Setup" menu to perform the IR setup.

3 Assign the connected components to the inputs selected with the INPUT SELECTOR.

Select an input jack name, consult the Setup Codes chart (on the attached sheet) to find out the setup code corresponding to the component connected to the selected input, and input the corresponding 4-digit code to assign it to the selected input.

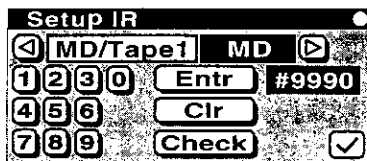

When using digital inputs, perform connection and assignment taking special care in the relations between the input jacks and connection cords.

DIGITAL INPUT jack	Usable cord connector
VIDEO2	OPTICAL connector
VIDEO3	OPTICAL connector
VIDEO4	COAXIAL connector
CD1	COAXIAL connector

* When registering setup codes for KENWOOD audio components which are connected to this unit by system control cords, use the following codes to insure proper system control operation:

- Cassette : 7990
- Single CD : 8990
- Carrousel CD : 8991
- 200-disc changer CD : 8992
- (Multi-room capability CD) : 8993
- MD : 9990

- 3 Select the "◀" or "▶" icon to select an input. The section showing "MD/Tape1" in the figure displays the current input selection.

- CD1
 - (CD2) *1
 - MD/ Tape 1
 - (Tape2)
 - TV1
 - TV2
 - Video1
 - Video2
 - Video3
 - Video4
- The inputs are switched every time the "◀" or "▶" icon is selected.
- *1: Set "CD2" when using a multi-room capable CD player. - 24 - 25

- 4 Find out the setup code of the actually connected component from the Setup Codes chart and input the code using icons 1 to 0.

[Example]
To assign a KENWOOD MD recorder : 9 9 9 0 Entr
The input setup code can be...
Checked by selecting the "Check" icon.

(This results in turning the component power on if it has been set so. However, the components with which the input of system control setup codes is required and certain components from other manufacturers than KENWOOD cannot be turned on.)
Cleared by selecting the "Clr" icon.
Select the "Entr" icon to enter the selection in memory.

- Section "MD" on the "Setup IR" menu screen shows the component connected to the input jacks on the rear panel.

4 Assign all the connected components.

Repeat step 3 for each component connected.

Setup of components which are not listed in the Setup Codes chart (Futureset)

If one of your connected components is not listed in the Setup Codes chart, its setup code can be downloaded through a telephone line.

Futureset codes are stored in memory. Each time a "Futureset Upgrade" is performed, any previous information in the Futureset memory location is erased. Please inform your customer service representative if FutureSet has been previously used.

- 1** Write down the brand name and model number of your component in the space provided before your call.

	Type	Brand	Model No.	Remote Model No.
	TV	KENWOOD	KV-????	RC-????
1				
2				

	Type	Brand	Model No.	Remote Model No.
3				
4				
5				

- 2** Call our Free-Phone Consumer Help-Line and explain which components you would like to add to your remote control.

USA: 1-800-753-9860

Canada: 1-800-644-0073

This number is designed specifically for "Futureset Upgrade", questions about system operation should be first addressed to your place of purchase.

- The hours for customer service in USA and Canada currently are:

Monday-Thursday	9:00 am - 7:00 pm EST
Friday	9:00 am - 5:30 pm EST
Saturday	12:00 pm - 4:00 pm EST

- After our customer service representative records the brand name and model number of your component, he/she will ask you to hold the remote to the speaker portion of your telephone as shown below. Your remote control is KENWOOD model number: RC-R0907

Complete steps **3**, **4** and **5** before holding the remote to the speaker portion of your telephone.

- 3** Open the "Setup" menu.

- Select the "Main Menu" icon from the fixed segments.
- Select the "Stp" icon.

- 4** Perform icon selection in the "Setup" menu.

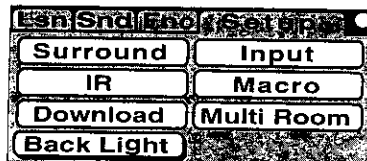

- Select the "Download" icon.

- 5** Perform icon selection in the "Futureset Upgrade" menu.



- Select the "Download" icon.

- "Loading" is displayed during readout of the remote control codes.
- The back light is turned off during "Loading".
- To abort downloading in the middle, select the **CONFIRM** key for more than 2 seconds. As "Canceled" appears after abortion, select the "☑" icon to exit the operation.

- 6** Receive the setup codes through the telephone.

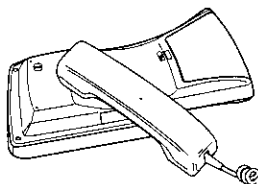

- Place the receiver speaker of the telephone set on the coil section of the remote control (as shown in the illustration on the left).

- For each setup code the operator can supply a setup code number. Should you ever need to change your input configuration, this number can be used. Please record for your future reference.
- After reception, the "Loading" message changes to the "Done" message, which is shown for a few seconds.

Code selection after mode download

After successful completion of the download, step ④ of the previous page, the remote control automatically enters a special set-up mode which works as described below.

1 Select the input and component names that you want to assign a setup code.

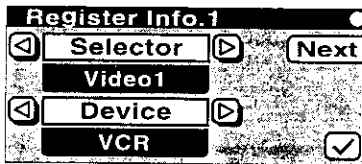

- ① Select the input name by selecting the "◀" or "▶" icon on both sides of "Selector" (input selector).
This changes the section of "Video1" in the figure.
- ② Select the component name by selecting the "◀" or "▶" icon on both sides of "Device" (component connected to the rear panel input jacks).
This changes the section of "VCR" in the figure.
- ③ Select the "Next" icon.
The "Register Info.2" menu screen appears.

2 Find out the numeric icon that outputs the power code of the component.



- Find the code with which "Device" of ① can be operated.
- ① Select the "1" icon to output its power code.
- After selecting a numeric icon, be sure to press the Joy stick key to output its power code.
- ② Select numeric icons in order from "1" until the component selected in step ① is turned ON (i.e. repeat step ① for each numeric icon).
- ③ Make sure that the component is turned on.
- ④ Select the "Entr" icon.

Select the "1" icon to output the power code of the first component on your list in step ① of the previous page. Continue to select icons "2" through "20" until the component you want to register turns on.

Though the "Futureset" memory in your remote control is quite large, only 20 different devices power codes can be put on the keypad at any one time. If you require a larger download, the standard setup procedure can be used. See "Assigning the connected components to the selected inputs", your customer service representative can supply you with the downloaded setup codes numbers.

3 Set up all the downloaded codes.

Repeat the operations of steps ① and ②.

- The setup code for the last power code to be sent in step ② is automatically registered at the location selected in step ①.

4 End of operation.

To delete a setup code

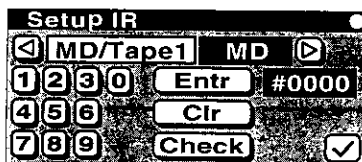

- "#0000" is displayed when the setup code is inputted while the "Setup IR" menu screen is shown.
(The input number is not shown.)
- When a setup code has been downloaded, the section where "#0000" is shown above displays "# - - -". (The number input in step ② is not shown.)

When setup codes of more than one components have been downloaded, note that all of the codes are interrelated between each other. Therefore, if any of them is deleted, you should perform the procedure of "Setup of components which are not listed in the Setup Codes chart" from the beginning.

Operation for displaying the menu screen shown on the left :

- ① Select the "Main Menu" icon.
- ② Select the "Stp" icon.
- ③ Select the "IR" icon.

Operation for deleting a setup code :

- ① Select the component to be deleted.
Select the component with the "◀" or "▶" icon.
- ② Select the 4 digit code "9999".
- ③ Select the "Entr" icon.

Setup of Room A and Room B

To control the system components in "Room A" from "Room B", it is first required to set the IR RECEIVER to "Room B". After this, perform the IR RECEIVER setup using the main unit keys as described in "Switching the IR RECEIVER mode". Then, perform the required setups for the remote control unit using its "Setup Multi Room" menu as described below.

After the "Room B" operation has been set, the audio for "Room B" is output from the speakers connected to the SPEAKERS B terminals and from the speakers of the power amplifier connected to the PREOUT jacks.

1 Select the "Main Menu" icon from the fixed segments.



- The menu screen shown in step 2 is displayed when the "Stp" icon is selected from the "Main Menu".

2 Perform icon selection in the "Setup" menu.

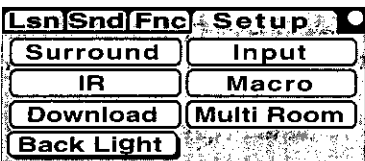

- Select the "Multi Room" icon in the "Setup" menu.

3 Perform setup.



- To control the desired components from another room, be sure to set the remote control unit to the "Room B" control mode.

DISPLAY MODE



- Setup of the remote control unit.
 - Multi Room : Yes/No
 - Select "Yes" to use the system in both "Room A" and "Room B".
 - Zone Select : Room A /Room B
 - Set according to your current location.
 - Select "Room A" if you are located in Room A.
 - Select "Room B" if you are located in Room B.
- While "Multi Room" is set to "Yes", part of the system control operation, which is a "SL16" function, is not available.
- Setup of the main unit.
 - Press and hold the DISPLAY MODE key for more than 2 seconds to set the IR RECEIVER setup to "IR RECEIVER B".
- To control components from "Room B".... See the description of "Remote control of audio in another room (Room B)".
- When "Zone Select" is set to "Room B", only the "Setup" menu can be selected from the "Main Menu" screen.

Setup for playing different CDs from Room A and Room B

Preparation

- Connect the CD player(s) to the main unit, and perform the operations in "Assigning the connected components to the selected inputs" and "Setup of Room A and Room B".

To play CD(s) in Room A and Room B, use one of the three kinds of connection methods below.

Connecting a KENWOOD Multi-room capability CD player.

Connecting two CD players.

Connecting a CD player other than KENWOOD Multi-room capability CD Player.

Setup for playing CDs in Room A and Room B using a Multi-room capability CD Player

1 Connect the Multi-room capability CD player.

To use the Multi-room capability CD Player from KENWOOD, connect its OUTPUT A to the "CD1" input jacks on the rear panel of the main unit so that OUTPUT A is remote controlled as the CD1 input. Then connect OUTPUT B to the CD2/TAPE2 MONITOR input jacks on the rear panel so that OUTPUT B is remote controlled as the "CD2" input. Connect the Multi-room capability CD Player and the main unit with a system control cord.

2 Operation in the "Setup Multi Room" menu.



- Display the "Setup Multi Room" menu screen.
- To listen in "Room A", set "SPEAKERS A" to ON.
- To listen in "Room B", set "SPEAKERS B" to ON.

Operation for displaying the "Setup Multi Room" menu screen :

- 1 Select the "Main Menu" icon.
- 2 Select the "Stp" icon.
- 3 Select the "Multi Room" icon.

Operation in the "Setup Multi Room" menu screen :

- 4 Select and set the "Multi Room" icon to "Yes".
- 5 Select and set the "Zone Select" icon to "Room A" or "Room B" according to your location.
- 6 Press and hold the "DISPLAY MODE" key on the main unit for more than 2 seconds to set the IR RECEIVER location to "IR RECEIVER B".

3 Operation in the "Setup Input" menu.

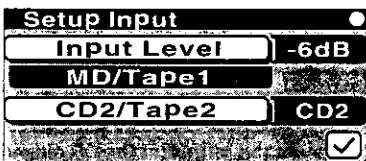

- Display the "Setup Input" menu screen.
- In this screen, perform the setup for controlling "CD2".

Operation for displaying the "Setup Input" menu screen :

- 1 Select the "Main Menu" icon.
- 2 Select the "Stp" icon.
- 3 Select the "Input" icon.

Operation in the "Setup Input" menu screen :

- 4 Select and set the "CD2/Tape2" icon to "CD2".

4 Setup IR

In step 2 of the procedure in "Assigning the connected components to the selected inputs", select the "CD1" input and input "8 9 9 2" (system control code) as the "Setup IR" code. Also input "8 9 9 2" for the "CD2" input.

Stp

both

om A.
om B.
control

than 2
ER B".

nother

menu

Setup for playing two CD players from Room A and Room B

1 Connect CD players.

The connection as described below is required when a KENWOOD CD player and a CD player from other manufacturer are connected or when two non-KENWOOD CD players are connected for listening in "Room A" and "Room B". However, note that it is not possible to connect and control two CD players from a same manufacturer. Connect the output of the first CD player to the CD1 input jacks on the rear panel so that it is remote controlled as the "CD1" from the fixed segments. Connect the output of the second CD player to the CD2/TAPE2 MONITOR input jacks on the rear panel so that it is remote controlled as the "CD2/Tape2" from the fixed segments.

2 Operation in the "Setup Multi Room" menu.



- Display the "Setup Multi Room" menu screen.
- To listen in "Room A", set "SPEAKERS A" to ON.
- To listen in "Room B", set "SPEAKERS B" to ON.

Operation for displaying the "Setup Multi Room" menu screen :

- 1 Select the "Main Menu" icon.
- 2 Select the "Stp" icon.
- 3 Select the "Multi Room" icon.

Operation in the "Setup Multi Room" menu screen :

- 4 Select and set the "Multi Room" icon to "Yes".
- 5 Select and set the "Zone Select" icon to "Room A" or "Room B" according to your location.
- 6 Press and hold the "DISPLAY MODE" key on the main unit for more than 2 seconds to set the IR RECEIVER location to "IR RECEIVER B".

3 Operation in the "Setup Input" menu.

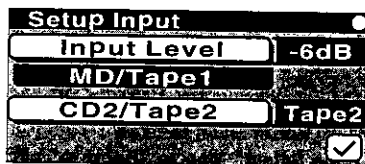

- Display the "Setup Input" menu screen.
- In this screen, perform the setup for controlling the 2nd CD player.

Operation for displaying the "Setup Input" menu screen :

- 1 Select the "Main Menu" icon.
- 2 Select the "Stp" icon.
- 3 Select the "Input" icon.

Operation in the "Setup Input" menu screen :

- 4 Select and set the "CD2/Tape2" icon to "Tape2".

4 Setup IR.

In step 2 of the procedure in "Assigning the connected components to the selected inputs", input the "Setup IR" codes of the manufacturers of the two CD players for the "CD1" and "Tape2" inputs respectively. The synchro cord can be connected to the "CD1" component only when the "CD1" component is a KENWOOD CD player.

Setup for playing a CD player from Room A and Room B (Other CD player than the Multi-room capability CD Player)

1 Connect the CD player.

To play a CD player other than the KENWOOD Twin Pick CD Player in "Room A" and "Room B", connect the output of the CD player to the CD1 input jacks on the rear panel so that it is remote controlled as the "CD1" input.

2 Operation in the "Setup Multi Room" menu.

Perform the same setup operation as in step 2 of "Setup for playing two CD players from Room A and Room B".

3 Operation in the "Setup Input" menu.

Perform the same setup operation as in step 3 of "Setup for playing two CD players from Room A and Room B".

4 Setup IR.

In step 2 of the procedure in "Assigning the connected components to the selected inputs", select the "CD1" input and input the setup code for KENWOOD system control. The synchro cord can be connected to the "CD1" component only when the "CD1" component is a KENWOOD CD player.

Setup of Input Level

Summary of Input Level Setup

If the CLIP INDICATOR on the front panel lights, change the "Input Level" setup.

- The "Input Level" can be set for any selected input.

1 Select the icon of the input for which you want to set the input level.

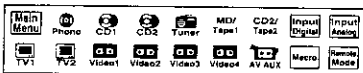

- When adjusting "CD1", "Video2", "Video3", "Video4", select the "Input Analog" icon from the fixed segment for analog input, and then go to step 2.

2 Select the "Main Menu" icon from the fixed segments.

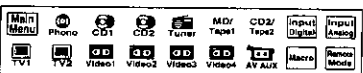

- Select the "Stp" icon to display the "Setup" menu screen.



3 Operation in the "Setup" menu.

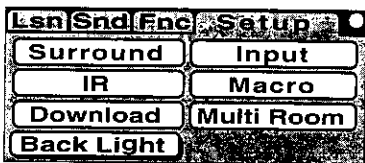

- ① Select the "Input" icon.

4 Set the "Input Level".

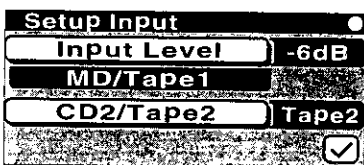

- The input level from the input selected in step 1 can be selected from "0 dB", "-3 dB" and "-6 dB". Each selection operation of the "Input Level" icon switches it. If the CLIP INDICATOR lights up, set the level of the selected input to "-3 dB" or "-6 dB".
- This setting is possible only for "Room A".

Set "CD2 / Tape2"

Set "CD2 / Tape2"

- Set the CD/TAPE2 MONITOR input jack to "CD2" or "Tape2 (Monitor)" mode.
- Set to "CD2" only when the Multi-room capability CD Player is used. Set to "Tape2 (Monitor)" otherwise.

1 Set "CD2 / Tape2"

- ① Set "CD2/ Tape2" in the same menu screen as step 2.
- Rec out is not available when the input is set to "CD2".

General setup flow

- 1 Opening the "Setup" menu screen
- 2 Selection in the "Setup" menu screen
- 3 Selecting "SP Selection"
- 4 Selecting the speakers
- 5 Setting the "Speaker Distance"
- 6 Setting the "Speaker Level"
- 7 Setting the "Surround SP Type"

1 Select the "Main Menu" icon.



- 1 Select the "Main Menu" icon from the fixed segments.
- 2 Select the "Stp" icon.
The "Setup" menu screen shown in step 2 below appears.

2 Select the "Surround" icon.

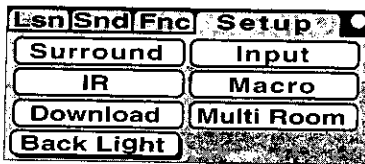

3 Select "SP Selection".

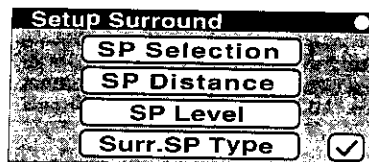

SP Selection:
Speaker selection

4 Select the on/off conditions or sizes of the speakers.

A. If you want a simplified setup operation, select "Quick Setup".

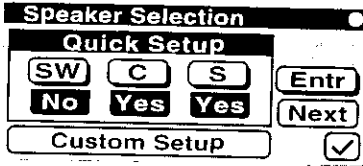

SW : Subwoofer
C : Center speaker
S : Surround speakers

- 1 Set the "Yes" or "No" condition for each of "SW", "C" and "S".
- 2 Select the "Entr" icon to enter the selection.
- 3 Select the "Next" icon to go to the next step.

B. If you want a detailed setup operation, select "Custom Setup".

When using wideband speakers, it is recommended to set the speaker size in "SP Selection (Custom)" to "Lrg". When "Custom Setup" is selected, the "SP Selection (Custom)" menu appears so you can select the "On"/"Off" condition, "Lrg"/"Nml"/"Off" size for each of "SW", "F", "C" and "S".

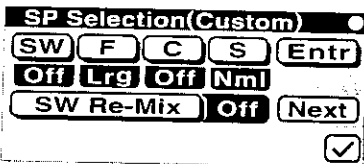

SW : Subwoofer
F : Front speakers
C : Center speaker
S : Surround speakers
Lrg : Large
Nml : Normal (Small)

- 1 Set the details of each of "SW", "F", "C" and "S".
- 2 Select the "Entr" icon to enter the selection.

List of the relationship between speaker size and on/off

F	SW	C	S
Lrg	On/Off	Off/ Nml/ Lrg	Off/ Nml/ Lrg
Nml	On	Off/ Nml	Off/ Nml

- Setting "SW Re-Mix" to "On" adds the low-frequency components of "F", "C" and "S" to "SW".
- 3 Select the "Next" icon to go to the "Speaker Distance" menu screen.

5 Set the "Speaker Distance".

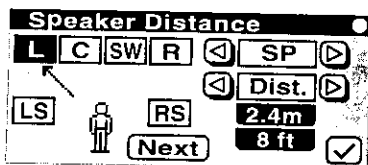

L : Left front speaker
C : Center speaker
SW : Subwoofer
R : Right front speaker
LS : Left Surround speaker
RS : Right Surround speaker

- 1 Select the speaker (SP) with the "◀" or "▶" icon.
- 2 Select the distance of the speaker (Dist.) with the "◀" or "▶" icon.
- 3 Set each of "L", "C", "R", "RS", "LS" and "SW" by repeating 1 and 2.
- 4 Select the "Next" icon to go to the next step.

6 Adjust the "Speaker Level".

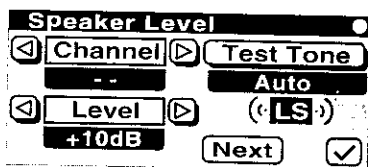

- 1 Select and set the "Test Tone" icon to "Auto".
The icon can be switched to "Off", "Auto" and "Manual" in order.
- "LS" shown in the figure on the left indicates the speaker which output the test tone when "Test Tone" is set to "Auto" (the Left Surround speaker).
- 2 Adjust the level of the speaker (Level) with the "◀" or "▶" icon.
- When "Manual" is selected above, select each speaker with the "◀" or "▶" icon of "Channel" and adjust its level.
- 3 Select the "Next" icon to go to the next step.

7 Set the "Surround SP Type".

Select whether the surround speaker is a "Wired" or "Wireless" speaker.

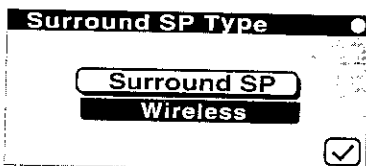

- When "Wireless" is selected, the compensation for applying equivalent signal delay to all speakers will be applied automatically.
- Display "Wired" when the surround speakers are connected to the main unit through speaker cords.

Setup for remote controlling other equipment than AV components

VR-2090/VR-2080/KRF-V8881D/KRF-V7771D (En/K)

30

Operation in the "Function" menu

The pieces of equipment which are set to "Model 1" and "Model 2" in the "Model Type Setup" can be controlled with "Accessories" or "Home Automation".

In addition to the components which can be remote controlled by setup code inputs, the following equipment can be remote controlled.

"Accessories" control

The remote control unit can output the KENWOOD-original codes.

"Home Automation" control

The remote control unit can output the X-10, Lutron and Makita codes used by commercially available non-audio equipment.

- Ⓐ X-10 control
Remote control of illumination equipment
- Ⓑ Lutron control
Remote control of illumination equipment
- Ⓒ Makita control
Remote control of the curtain opening/closing, etc.

Opening the "Function" menu

1 Select the "Main Menu" icon.



- 1 Select the "Main Menu" icon from the fixed segments.
- 2 Select the "Fnc" icon so that the "Function" menu screen shown in step 2 below appears.

2 Perform selection in the "Function" menu.

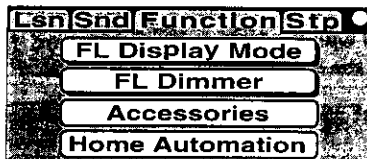

- 1 To output KENWOOD-original codes, select the "Accessories" icon.
- 2 To output the "X-10", "Lutron" or "Makita" codes, select the "Home Automation" icon.

"Accessories" control

1 Perform selection in the "Function" menu.

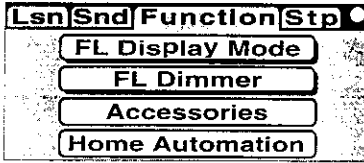

① Select the "Accessories" icon.

2 Perform selection in the "Accessories" menu.

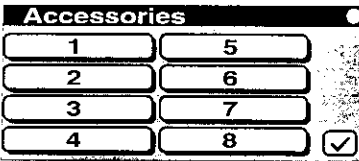

① Select "1" to "8".

"Home Automation" control

1 Perform selection in the "Function" menu.

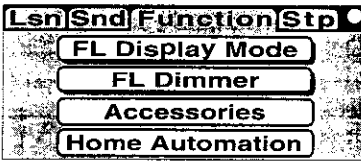

① Select the "Home Automation" icon.

X-10 control

1 Perform selection in the "Home Automation" menu.



① Select the "X-10" icon.

● The "X-10", "Lutron" or "Makita" setting screen can be opened.

2 Perform selection in the "X-10 (1-8)" menu.

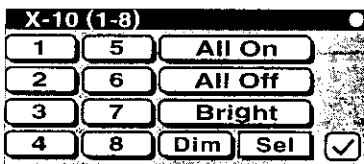

Dim : Dimmer
Sel : Select

① Select one of "1" to "8", "All On", "All Off", "Bright" and/or "Dim".

● The "Sel" icon allows you to switch between "X-10 (1-8)" and "X-10 (9-16)".

Lutron control

1 Perform selection in the "Home Automation" menu.

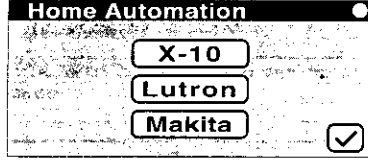

① Select the "Lutron" icon.

2 Perform selection in the "Lutron (Spacer)" menu.

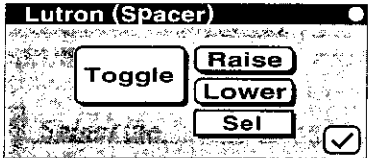

① The following icons can be selected.
 "Toggle" : Toggle switch
 "Raise" : To raise.
 "Lower" : To lower.

Sel : Select

3 Perform selection in the "Lutron (GRAFIK Eye)" menu.



① The following icons can be selected.
 "Scene 1" to "Scene 8"
 "Raise"
 "Lower"
 "Off"

• The "Sel" icon allows you to switch between "Lutron (Spacer)" and "Lutron (GRAFIK Eye)".

Makita control

1 Perform selection in the "Home Automation" menu.

Home Automation

X-10

Lutron

Makita

① Select the "Makita" icon.

2 Perform selection in the "Makita (1)" menu.

Makita (1)

Opn Curtain 1 Cls Sel

Opn Stop Cls Stop

Opn : Open
Cls : Close
Sel : Select

① The following icons can be selected.

- Open/close of "Curtain 1"
- Open stop
- Close stop

• The "Sel" icon allows you to switch between "Makita (1)", "Makita (2)", "Makita (3A)" and "Makita (3B)".

3 Perform selection in the "Makita (2)" menu.

Makita (2)

Opn Curtain 1 Cls Sel

Opn Curtain 2 Cls

Opn Stop Cls Stop

① The following icons can be selected.

- Open/close of "Curtain 1"
- Open/close of "Curtain 2"
- Open stop, Close stop

4 Perform selection in the "Makita (3A)" menu.

(3-Motor A control)

Makita (3A)

Opn Curtain 1 Cls Sel

Opn Curtain 2 Cls

Opn Curtain 3 Cls

Opn Stop Cls Stop

① The following icons can be selected.

- Open/close of "Curtain 1"
- Open/close of "Curtain 2"
- Open/close of "Curtain 3"
- Open stop, Close stop

5 Perform selection in the "Makita (3B)" menu.

(3-Motor B control)

Makita (3B)

Opn Curtain 4 Cls Sel

Opn Curtain 5 Cls

Opn Curtain 6 Cls

Opn Stop Cls Stop

① The following icons can be selected.

- Open/close of "Curtain 4"
- Open/close of "Curtain 5"
- Open/close of "Curtain 6"
- Open stop, Close stop

Setup for macro play (automatic operation)

VR-2090/VR-2080/KRF-V8881D/KRF-V7771D (E/F/K)

Setting up the remote control unit for macro play (automatic operation)

General setup flow

- 1 Selecting the "Main Menu" icon and opening the "Setup" menu
- 2 Selecting the "Macro" icon
- 3 Selecting the input to be played
- 4 Selection in the "Macro Edit: Custom 1" screen
- 5 Setting the target component in the "Edit" menu
- 6 Setting the channel, etc.

The macro play function allows you to set the remote to control several components in succession. After completing this setup, you can perform a series of operations automatically. Enter the setup codes for the components you want to control beforehand.

1 Select the "Main Menu" icon from the fixed segments.



- 1 Select the Select "Stp" icon.

2 Select the "Macro" icon.

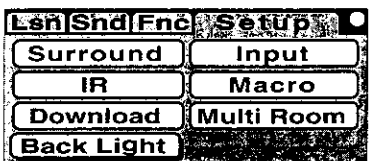

3 Perform operation in the "Custom 1", "Custom 2" or "Custom 3" screen.

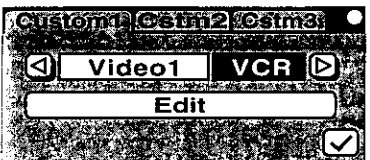

- Example when the "VCR" is assigned to "Video1".

- Three kinds of macros, "Custom 1", "Custom 2" and "Custom 3" can be set and registered.
- Select the input to be played with the "◀" or "▶" icon. Each selection of the icon switches the inputs as follows.
→ VIDEO1 ↔ VIDEO2 ↔ VIDEO3 ↔ VIDEO4 ↔ CD1
↔ MD/Tape1 ←
- Select the "Edit" icon.
- The "Edit" menu is not displayed if none of the connected components has been assigned to "Video1".

4 Perform operation in the "Macro Edit: Custom 1" screen.



- To set the timing of the component selected in step 3 above, select the icon corresponding to the component.
- **Device** : Set up the connected devices.
- **Accessories** : To set KENWOOD accessories.
- **TV** : The icon shown in the example on the left opens the TV setup.
- The displayed menu screen is variable depending on the Model Type setup.

5 Operation in the "Custom # Edit: VCR" screen.

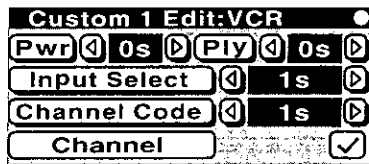

Pwr : Power
Ply : Play

- The output timing of each code can be switched as shown below.
 → -- → 0s → 1s → 2s → → 15s ←
 "- -" indicates that no code is output and "0s" indicates that the code is output at the same time as a macro execute key is pressed.
- The component name after "Edit:" is switched to "VCR", "DSS", "Cable", "Satellite", "LD", "DVD", "CD", "MD" or "Tape" according to the selected input.

- Check the operation after setting the time. If macro play does not occur, increase the time settings with the following procedure.

 - Set the "Pwr" (Power) on time.
Select with the "←" or "→" icon.
 - Select the "Pwr" icon and check operation.
 - Set the "Ply" (Play) start time.
Select with the "←" or "→" icon.
 - Select the "Ply" icon and check operation.
 - Set the "Input Select" code output timing of the VCR.
Select with the "←" or "→" icon.
 - Select the "Input Select" icon and check operation.
 - Open the "10key Pad" menu screen to select a channel.
Select "Channel" icon.
 - Set as described in step 4.
 - Set the "Channel Code" output timing of the VCR.
Select with the "←" or "→" icon.
 - Select the "Channel Code" icon and check operation.

6 Operation in the "10key Pad (Macro)" screen.



Clr : Clear
Entr: Enter
* : The number of input icons is shown in max. 10 digits.

- Clr : Select to clear all the input "*"
 - Entr : Select when it is required to enter a value selection.
 - >12 : Select when inputting a channel value of 13 or more.
 - /- : Select to switch between the 1-digit input or 2-digit input.

- To output a set channel code, select the "Channel Code" icon in step 4.

 - Set a channel.
(Example)
To set CH 11 : Select the "+10" then "1" icons.
 - Select the "☑" icon to establish the selection.
When "☑" is selected, the screen returns to the previous menu.

Custom 1 Edit 1: ACC

1 Perform selection in the "Macro Edit: Custom 1, 2 or 3" menu screen.

- Set the "Accessories" (power) ON timing.
Select with the "←" or "→" icon.

Custom 1 Edit 1 : TV

1 Perform selection in the "Macro Edit: Custom 1, 2 or 3" menu screen.



Pwr : Power

- Pwr : Setting of the TV's "Pwr" code output timing.
- TV : Selection of the controlled TV from "TV1" and "TV2".
- Video Select : Selection of the TV's "Video Select" code output timing.
- TV Select : Selection of the TV's "TV Select" code output timing.

- Check the operation after setting the time. If macro play does not occur, increase the time settings with the following procedure.

 - Set the "Pwr" (power) ON time.
Select with the "←" or "→" icon.
 - Select the "Pwr" icon and check operation.
 - Select whether "TV1" or "TV2" is to be controlled.
 - Set the "Video Select" code output timing.
Select with the "←" or "→" icon.
 - Select the "Video Select" icon and check operation.
 - Set the "TV Select" code output timing.
Select with the "←" or "→" icon.
 - Select the "TV Select" icon and check operation.

Macro Execute

General setup flow

- 1 Opening the "Macro Execute" menu screen
- 2 Operation in the "Macro Execute" menu screen

By setting up the items in "Setting up the remote control unit for macro play (automatic operation)", you can start automatic play using the macro function.

- 1 Select the "Macro" icon from the fixed segments.



- 2 Execute a macro in the "Macro Execute" menu screen.

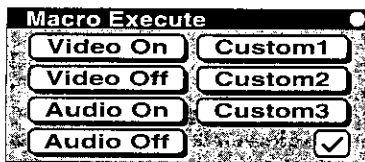

- Select the icon of the component to be controlled.

Video On : Select to turn on the video components.
Video Off : Select to turn off the video components.
Audio On : Select to turn on the audio components.
Audio Off : Select to turn off the audio components.
Custom 1 : Select to execute "Macro Custom 1".
Custom 2 : Select to execute "Macro Custom 2".
Custom 3 : Select to execute "Macro Custom 3".

Perfect Macro (For VR-2090/ KRF-V8881D)

When "Perfect Macro" is executed, all the components in the AV system are turned ON or OFF.

The "Perfect Macro" operation is possible based on detection of the ON/OFF status of all AV components.

This receiver identifies the ON/OFF status of video components by detecting the sync signals in the video signals from them. When the TV ON/OFF sensor is connected to the receiver, it detects the TV ON/OFF status by detecting the optical or magnetic wave. (As the TV ON/OFF sensor connection is not possible with the KRF-V8881D, the TV cannot be turned ON/OFF with the "Perfect Macro" operation.)

Preparation

To make "Perfect Macro" executable, it is required to perform the following related items as required.

- System connections
- Connecting the system control
- Installing the remote control transceiver
Installing the "TV ON/OFF SENSOR"
- Setup of the remote control unit
- Setup for controlling AV components
- Setup for macro play (automatic operation)

VR-2090/VR-2080/KRF-V8881D/KRF-V7771D CORRECTION

P.36 English

2 Execute a macro in the "Macro Execute" menu screen.

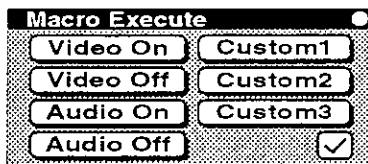

- Select the icon of the component to be controlled.

Video On : Turns the video component's power ON or OFF. (The mode before selection will be changed.) The receiver's power will be turned on at the same time. (If OFF is the mode engaged before selection is made, the unit will be turned ON. If the ON mode is already engaged, the mode will not change.)

Video Off : Turns the receiver's power OFF. (To turn the power of either the video component or the receiver OFF, set the receiver's power to OFF after first setting the video component OFF with the Video On setting.)

Audio On : Select to turn on the audio components. (In the case of system connection)

Audio Off : Select to turn off the audio components. (In the case of system connection)

Custom 1 : Select to execute "Macro Custom 1".

Custom 2 : Select to execute "Macro Custom 2".

Custom 3 : Select to execute "Macro Custom 3".

Perfect Macro (For VR-2090/ KRF-V8881D)

On Perfect Macro compatible models, when "Video On"/"Video Off" of the procedure 2 is selected, the following operations will occur. When "Perfect Macro" is executed, all the components in the AV system are turned ON or OFF.

The "Perfect Macro" operation is possible based on detection of the ON/OFF status of all AV components.

This receiver identifies the ON/OFF status of video components by detecting the sync signals in the video signals from them. When the TV ON/OFF sensor is connected to the receiver, it detects the TV ON/OFF status by detecting the optical or magnetic wave. (As the TV ON/OFF sensor connection is not possible with the KRF-V8881D, the TV cannot be turned ON/OFF with the "Perfect Macro" operation.)

Preparation

To make "Perfect Macro" executable, it is required to perform the following related items as required.

- System connections
- Connecting the system control
- Installing the remote control transceiver
Installing the "TV ON/OFF SENSOR"
- Setup of the remote control unit
- Setup for controlling AV components
- Setup for macro play (automatic operation)

- Select the icon of the component to be controlled. (Perfect Macro compatible components)

Video On : Turns the video component's power ON, and turns the power of the receiver ON at the same time.

Video Off : Turns the video component power OFF, and turns the power of the receiver OFF at the same time.

Audio On : Select to turn on the audio components. (In the case of system connection)

Audio Off : Select to turn off the audio components. (In the case of system connection)

Custom 1 : Select to execute "Macro Custom 1".

Custom 2 : Select to execute "Macro Custom 2".

Custom 3 : Select to execute "Macro Custom 3".

- May not operate normally depending on the video signals of the connected components.

"LCD FutureSet" remote "Home Automation" addition

control
n start

Control "Home Automation" products

Your new remote control comes with built-in IR commands to control non-audio/video equipment, such as drapery-opening or lighting-control equipment. Some equipment can even control virtually any electrically-powered equipment in your home.

The control feature works using built-in screens specially designed to emulate the operation of this non-audio/video equipment. Using these features requires no setup to work with the compatible products from the companies listed below. And you can combine this control with the Macro features of your remote to automatically operate your audio/video and home automation equipment - and significantly simplify and enhance your home theater and entertainment experience.

Note: The following companies and products are not owned by or affiliated with Kenwood in any way. Please contact these companies directly for further information or to find a retailer near you.

Makita Automatic Drapery Opener System



Your Kenwood remote completely replaces certain Makita Automatic Drapery Opener System remotes, using 4 built-in screens. The Makita remote models that it replaces are: ZZRC10, ZZRC20, ZZRC30 and ZZRC60.

For more information:

Makita USA Inc.
14930 Northam Street La Mirada, CA 90638-5753 USA
1-800-851-0537 (US) 1-714-522-8088 (outside the US)
1-714-522-8194 (fax)
E-mail: Makitaapd@aol.com

Lutron



Your Kenwood remote can automatically dim your lights with the Lutron Spacer system or Lutron GRAFIK Eye, using 2 built-in screens. The Lutron remote models are: SP-HT-WH, GRX-IT, and GRX-8IT.

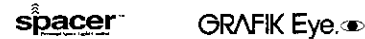

For more information:

Lutron Electronics Co., Inc. 7200 Suter Road Coopersburg, PA 18036-1299 USA
1-800-523-9466 (US, Canada, Caribbean)
Web: www.lutron.com

X-10



Your Kenwood remote can turn equipment on and off (as well as dim lighting) with the X-10 converter product, using a built-in screen.

The X-10 model is: IR-543.

For more information:

Web: www.x-10.com
E-mail: X10@x10.com

In addition, many companies sell X-10 compatible equipment. One example is the Radio Shack product # RSU 10037703, which is equivalent to the X-10 IR-543. Radio Shack has an extensive line of X-10 compatible equipment.

"Automatic Power Sensing" and "SmartButton Macros"

The combination of "Automatic Power Sensing" and "SmartButton Macros" means that you can easily turn your audio, video, and other equipment on or off by touching one button on your remote. This receiver uses "Automatic Power Sensing" to determine whether connected equipment is currently on or off. Then "SmartButton Macros" send only the needed commands to turn equipment on or off. The result is that - unlike other products - your remote won't turn a product off when you meant to turn it on.

"Automatic Power Sensing" works with these types of equipment set up using the 'universal' feature of your remote :

Audio equipment : All Kenwood equipment connected through the SL-16 bus

Video equipment : All equipment attached to this receiver with a composite video input

Video monitor : Any equipment attached through an optional "Power Sensing" unit (purchased separately)*

* You can use one of the units listed below to monitor the on/off status of your monitor by connecting the sensor output of these devices to the "TV On/Off Sensor" input of your receiver.

Note:

The following companies and products are not owned by or affiliated with Kenwood in any way. Please contact these companies directly for further information or to find a retailer near you.

JDS Technologies PSS-TV



The JDS Technologies PSS-TV unit is a magnetic field sensor.

For more information :



16750 West Bernardo Drive San Diego, CA 92127 U.S.A.
TEL 619-487-8787 FAX 619-451-2799
INTERNET www.jdstechnologies.com
E-MAIL onlinejds@aol.com

16750 West Bernardo Drive San Diego, CA 92127 U.S.A.
TEL 619-487-8787 FAX 619-451-2799
INTERNET : www.jdstechnologies.com
E-MAIL : onlinejds@aol.com

Niles Light Sensor



The Niles LS-1 Light Sensor is an LED 'power' light sensor. (In some cases, it can also be used to sense the magnetic field.)

The Niles APC-2 Current Sensing Switch senses changes in power consumption.

For more information :

Niles 12331 SW 130 Street Miami, Florida 33186 305-238-4373 305-238-0185 (fax)

Web: www.nilesaudio.com

Niles and the Niles logo are registered trademarks of Niles Audio Corporation, Inc.

them.
agnetic
with the

Remote control of system components

VR-2090/VR-2080/KRF-V8881D/KRF-V7771D (En/K)

General operation flow

- 1 Selecting the icon of the component to be controlled from the fixed segments

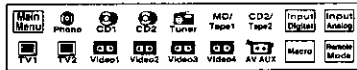

- The selected input changes according to the selection.
- 2 Performing operation in the menu screen of the selected component

- Complete the operation in "Assigning the connected components to the selected inputs" beforehand. The control icons for the non-assigned components are not displayed.
- Although the control menu screen of each component is variable depending on the setup code, this section uses the most typical control menu screens for ease of description.

Remote control of tuner

- 1 Select the "Tuner" icon.

- The "Tuner" input is selected.

- 2 Select the icon to be controlled.

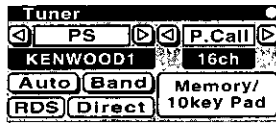

Remote control of DVD player

- It is necessary to assign the DVD player to one of the "Video" inputs previously.

- 1 Select the "Video1, 2, 3 or 4" icon.

- The "Video1/ 2/ 3/ 4" input is selected.

- 2 Select the icon to be controlled.

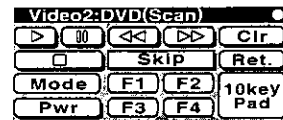

Pwr : Power
Clr : Clear
Ret. : Return

- The "Scan", "Skip" and "Slow" screens are available.

Remote control of MD recorder

- It is necessary to assign the MD recorder to the "MD/ Tape1" input previously.

- 1 Select the "MD/Tape1" icon.

- The "MD" input is selected.

- 2 Select the icon to be controlled.

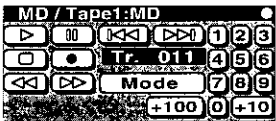

Remote control of LD player

- It is necessary to assign the LD player to one of the "Video" inputs previously.

- 1 Select the "Video1, 2, 3 or 4" icon.

- The "Video1/ 2/ 3/ 4" input is selected.

- 2 Select the icon to be controlled.



Pwr : Power

Remote control of cassette deck player

- It is necessary to assign the cassette deck player to the "MD/ Tape1" input previously.

- 1 Select the "MD/Tape1" icon.

- The "Tape1" input is selected.

- 2 Select the icon to be controlled.

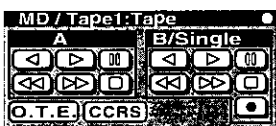

O.T.E. : One-Touch Edit

1000-0000-0000



Remote control of satellite tuner

- It is necessary to assign the satellite tuner to one of the "Video" inputs previously.

1 Select the "Video1, 2, 3 or 4" icon.

- The "Video1/ 2/ 3/ 4" input is selected.

2 Select the icon to be controlled.

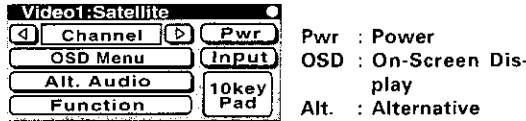

Remote control of TV

- It is necessary to assign the TV to the "TV1" or "TV2" input previously.

1 Select the "TV1 or TV2" icon.

2 Select the icon to be controlled.

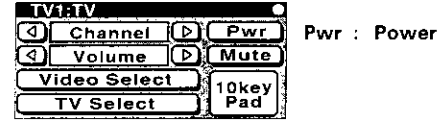

Remote control of DSS

- It is necessary to assign the DSS to one of the "Video" inputs previously.

1 Select the "Video1, 2, 3 or 4" icon.

- The "Video1/ 2/ 3/ 4" input is selected.

2 Select the icon to be controlled.

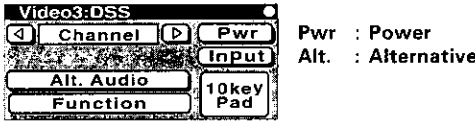

Remote control of VCR

- It is necessary to assign the VCR to one of the "Video" inputs previously.

1 Select the "Video1, 2, 3 or 4" icon.

- The "Video1/ 2/ 3/ 4" input is selected.

2 Select the icon to be controlled.



Remote control of Phono input

1 Select the "Phono" icon.

- The "PHONO" input is selected.
- The control icon is not displayed.

Remote control of AV AUX

1 Select the "AV AUX" icon.

- The "AV AUX" input is selected.
- The control icon is not displayed.

Remote control of cable TV

- It is necessary to assign the cable TV to the "TV1" or "TV2" input previously.

1 Select the "TV1 or TV2" icon.

2 Select the icon to be controlled.

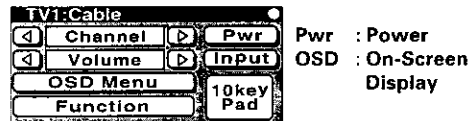

IC-Operations

Remote control of CD player

VR-2090/VR-2080/KAF-V6881D/KAF-V7771D (En/K)

40

General operation flow

- 1 Selecting the icon of the component to be controlled from the fixed segments

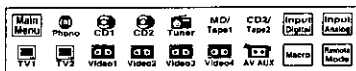

- The selected input changes according to the selection.

- 2 Performing operation in the menu screen of the selected component

The marketed models are variable depending on countries and areas. Please find the operation descriptions that are applicable to your model.

- Complete the operation in "Assigning the connected components to the selected inputs" beforehand.
- Refer to the instruction manual of each component for details.
- To read the CD text, see *2 in "Connection of audio components".

Remote controlling a Multi-room capability CD player or a 200-disc changer CD player

By connecting the Multi-room capability CD Player from KENWOOD, two CDs can be played as "CD1" and "CD2".

Preparation

- Some preparatory setups are required if you are going to use the Multi-room capability CD Player or a 200-disc changer CD Player. Perform the operations in the sections listed below:
 - "Assigning the connected components to the selected inputs", "Setup for multi-room operation".

CD1 remote control (Control of "Room A")

- 1 Select the "CD1" icon.

- The "CD1" input is selected.

- 2 Select the icon to be controlled.



Example of menu screen :
When the system setup code is input

- The same menu screen is displayed also with a 200-disc changer CD player.

CD2 remote control (Control of "Room B")

- 1 Select the "CD2" icon.

- The "CD2" input is selected.
- This specification is available only for the model with the "Room B" setup capability.

- 2 Select the icon to be controlled.



- To listen to the "CD2" source from "Room A", select the "Subout Monitor" icon. (Only with "Input Analog")

- *1 : Title Data Read
When the "Title Data Read" icon is selected, the indicator on the receiver main unit lights up. Do not displace the remote control unit during this. The read time is variable depending on the data quantity, but it may sometimes take as long as a few minutes.
- *2 : Track Title Read
If the track title cannot be displayed properly, select the "Track Title Read" icon.
- When a Multi-room capable CD player is used, the CD Text can be read by connecting the IR RECEIVER.

CD Text playback

- 1 Select the "CD1" icon.

- The "CD1" input is selected.

- 2 Select the "Mode" icon.



- 1 The "CD Mode" menu appears when the "Mode" icon is selected.

- 3 Operation in the "CD Mode" menu screen.

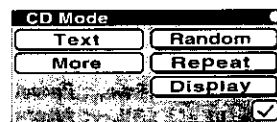

- 1 Select the "More" icon to display the "CD Mode (More)" menu screen.

- 4 Operation in the "CD Mode (More)" menu screen.

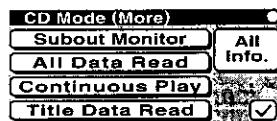

- Only "Title Data Read" is available in "Room B".

- 1 Complete "All Data Read" on the CD player before executing "Title Data Read".

- 2 Select the "Title Data Read" icon to read the disc title data. *1
 - Select the "✓" (checkmark) icon to return to the screen in 3.

- 5 Operation in the "CD Mode" menu screen.

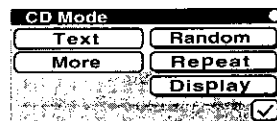

- 1 Select the "Text" icon to display the CD text display screen.

- 6 Read the CD text display screen. (Playing the CD)



D : Disc No.
T : Track No.
* : Track title read *2

- Section "D" shows the disc number and section "T" shows the title number.

- 1 Select the disc.
- 2 Select the playback icon.

- The CD can also be played by selecting one of the titles being displayed.

Single CD remote control

- It is necessary to assign the CD player input previously.

1 Select the "CD1" icon.

- The "CD1" input is selected.

2 Select the icon to be controlled.



Example of menu screen :
When the system setup code is input

3 Perform operation in the "CD Mode" menu screen.

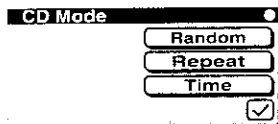

Carrousel CD remote control

- It is necessary to assign the CD player input previously.

1 Select the "CD1" icon.

- The "CD1" input is selected.

2 Select the icon to be controlled.

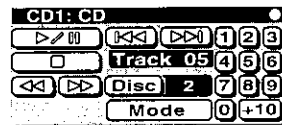

Example of menu screen :
When the system setup code is input

3 Perform operation in the "CD Mode" menu screen.

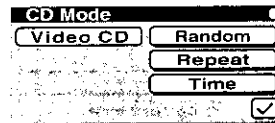

4 Perform operation in the "Video CD (CD)" menu screen.



- To play a Video CD compatible CD player and outputs its video, connect its video and audio outputs to one of the sets of input jacks VIDEO1 to VIDEO4.
- When using a Video-CD player, remove the system control cord from the CD player.

Remote control of non-KENWOOD CD player

- It is necessary to assign the CD player input previously.

1 Select the "CD1" icon.

- The "CD1" input is selected.

2 Select the icon to be controlled.

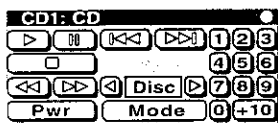

3 Select the icon to be controlled in the "CD Mode" menu screen.

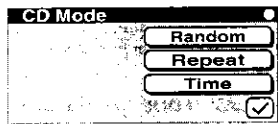

Controlling a Multi-room capability CD Player

Control from "Room A"

To control such a CD player from "Room A", set "Zone Select" to "Room A" and select the "CD1" icon. "CD2" cannot be controlled while "Room A" is set.

Control from "Room B"

To control such a CD player from "Room B", set "Zone Select" to "Room B" and select the "CD2" icon. "CD1" cannot be controlled while "Room B" is set.

- When "Room B" is set, the fixed segment icons that can be selected are limited.

Controlling other CD players than the Multi-room capability CD Player (When 2 players are connected)

When a KENWOOD CD player and a non-KENWOOD CD player or two CD players from non-KENWOOD manufacturers are connected.

Control from "Room A"

To control from "Room A", set "Zone Select" to "Room A" and select the "CD1" or "CD2/ Tape2" icon.

Control from "Room B"

To control from "Room B", set "Zone select" to "Room B" and select the "CD1" icon (i.e. the CD player connected to the "CD1" input).

- When "Room B" is set, the fixed segment icons that can be selected are limited. The CD player connected to the "CD2/Tape" input cannot be used in "Room B".

Controlling other CD players than the Multi-room capability CD Player (When one CD player is connected)

Control from "Room A"

To control such a CD player from "Room A", set "Zone Select" to "Room A" and select the "CD1" icon.

Control from "Room B"

To control such a CD player from "Room B", set "Zone Select" to "Room B" and select the "CD1" icon.

- When "Room B" is set, the fixed segment icons that can be selected are limited.

The control in "Room B" is possible when the analog inputs are used.

Preparation

The following preparatory setups are required to control the audio in "Room B".



- Perform the operations described in "Connections for remote control of other components" and "Setup for multi-room operation".
- For the connection to the speaker terminals or "PREOUT" jacks, see "Making connections to another room (Room B)".

General operation flow

- 1 Selecting the speakers
- 2 Selecting the "Room A" or "Room B" control mode
- 3 Selecting the component to be controlled
- 4 Controlling the component

1 Select the speakers.

When speakers are used :

- | | | | |
|---|------|-------------|---|
|  | - oA | 1 A ON | : Listening in "Room A" |
|  | - oB | 2 B ON | : Listening in "Room B" |
| | | 3 A + B ON | : Listening in both "Room A" and "Room B" |
| | | 4 A + B OFF | : Muting all speakers |

When SECOND ROOM PREOUT are used :

- When SECOND ROOM PREOUT jack is used, sound output from "Room B" speaker.

2 Select the "Room A" or "Room B" control mode.



Operation for displaying the "Setup Multi Room" menu screen shown on the left :

- 1 Select the "Main Menu" icon.
- 2 Select the "Stp" icon.
- 3 Select the "Multi Room" icon.

Operation in the "Setup Multi Room" menu screen :

- 4 Select and set the "Multi Room" icon to "Yes".
- 5 Select and set the "Zone Select" icon to "Room A" or "Room B" according to your current location.

Operation of main unit keys :

- 6 Press and hold the DISPLAY MODE key for more than 2 seconds to set the IR RECEIVER setup to "IR RECEIVER B".

3 Select the component to be controlled.



- The icons that can be selected may be restricted depending on the model and setup.

4 Select the control operation.

- Select the desired icon from the control menu screen.
- Unless the IR OUT FOR REMOTE (to be released in the future) is connected, the main unit status cannot be displayed on the RC unit during control in "Room B".
- While "Multi Room" is set to "Yes", part of the system control operation, which is a "SL16" function, is not available.

Display on the receiver main unit

The main unit displays the name of the component selected for "Room A".

Example: During playback of the CD player in "Room A" and the tuner in "Room B"...

↓
The main unit displays the CD input.

Convenient features

Midnight mode 1/2/Off

(Dolby Digital (AC-3) mode only)

When watching movies at night you might not be able to raise the volume as loud as normal. Midnight mode compresses the dynamic range of previously specified parts of the AC-3 sound track (like scenes with sudden increases in volume) to minimize the difference in volume between the specified and non-specified parts. This makes it easy to hear all of the sound track, even when listening at low volumes.

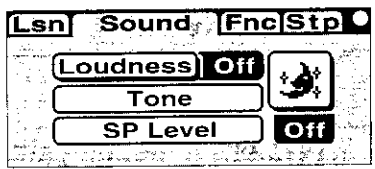

: Midnight mode

- ① Select the midnight mark icon.
- ② Adjust the parameter using the midnight mark icon.
→ 1 → 2 → Off →

- Some Dolby Digital (AC-3) software may not be compatible with the Midnight mode
- Midnight mode has no effect on parts of the sound track that are not specified for compression.

FL Dimmer, FL Display

1 Selecting the "Main Menu" icon

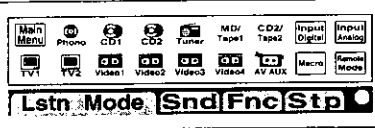

- ① Select the "Main Menu" icon from the fixed segments.
- ② Select the "Fnc" icon to display the "Function" menu shown in step 2 below.

2 Perform selection in the "Function" menu screen.

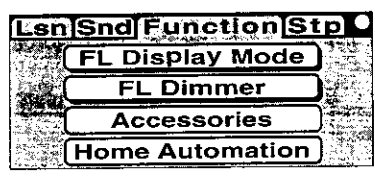

- FL dimmer setting :**
- ① Select the "FL Dimmer" icon.
 - The display tube brightness changes every time the icon is selected.
- FL display mode setting :**
- ① Select the "FL Display Mode" icon.
 - The display mode changes every time the icon is selected.

→ Connected compo- nent and analog/ digital display	→ Input terminal and connected compo- nent display	→ Listen mode dis- play
(Example) DVD DGTL (VIDEO3 DGTL)	(Example) VIDEO3 : DVD (VIDEO3 :)	(Example) DOLBY DIGITAL

The display inside () is shown when the connected component name is not assigned.

Back light

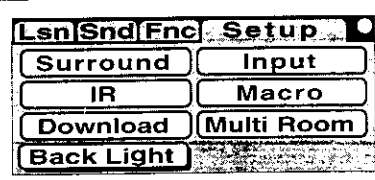

- This function turns the remote control display illumination on and off.
- ① Select the "Main Menu" icon.
 - ② Select the "Stp" icon.
 - ③ Select the "Back Light" icon.

- The illumination is turned on and off alternately every time the icon is selected.
- To save the battery power, it is recommended to keep the Back Light off in normal use.

Playing music

VR-2090/VR-2080/KRF-V8881D/KRF-V7771D (En/K)

Use the following procedure to play a CD or MD.

44

Preparation

- Perform the operations in "Connections".
- Perform the operations in "Setup" chapter.

Switching between digital input and analog input

Except when playing the digital input, select the "Input Analog" icon if you want to switch the input to the analog input.



For switching, refer to the "Playback of digital input/playback of analog input".

1 Press the ON/STANDBY (POWER) key to turn the unit ON.

Main unit

RC

- *1 : With a model for the U.S.A., U.S. Military or Canada destinations, press the **ON/STANDBY** key.
- *2 : With other model than the above, press the **POWER** key to ON before pressing the **ON/STANDBY** key.
- Load the CD player or MD recorder with the disc to be played.

2 Select the source.

Main unit

RC

Select the icon of the desired source.

On the main unit, the input sources are switched in the following order :

- Tuner (Frequency display)
- CD1
- MD/Tape1
- VIDEO1
- VIDEO2
- VIDEO3
- VIDEO4
- AV AUX
- PHONO

Be sure to perform the setups in "Setup" chapter if you want to control the system control operations.

3 Play the selected input source.

Main unit

Operation of the source component

RC

Select the play icon

etc.

4 Adjust the volume.

Main unit



RC

- Turning the **VOLUME** control at a high speed increase the volume change rate. (**AI VOLUME** function)
- The input source (which is indicated on the main unit) cannot be played while "CD2/Tape2 (Monitor)" is on (which is indicated by the lightning of the indicator on the main unit front panel).

Listening to Audio

Select the speakers

If you have not completed the setup of "Room A" and "Room B":

-  - o A ① A ON : Listening in SPEAKERS A
-  - o B ② B ON : Listening in SPEAKERS B
-  - o B ③ A + B ON : Listening in both SPEAKERS A and SPEAKERS B
- ④ A + B OFF : Muting all speakers

If you have already completed the setup of "Room A" and "Room B":

- ① A ON : Listening in "Room A"
- ② B ON : Listening in "Room B"
- ③ A + B ON : Listening in both "Room A" and "Room B"
- ④ A + B OFF : Muting all speakers
- For the "Room A" and "Room B" setup, see "Setup for multi-room operation" and "Controlling the audio in Room A and Room B" under it.

Setting up the IR RECEIVER

The following setup operations are required when the IR RECEIVER is not to be used.
For the operations performed on the IR RECEIVER, see "Switching the IR RECEIVER".

Operation to be performed on the main unit :

- Press and hold the DISPLAY MODE key for more than 2 seconds to set to IR RECEIVER OFF.

Listening through headphones

① Plug headphones.

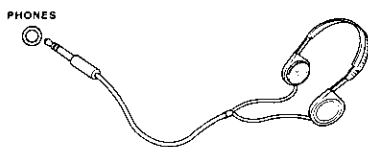

② Adjust the volume.

Main unit

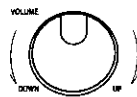

To decrease volume

To increase volume

RC

To increase volume



To decrease volume

- To listen to an Dolby Digital (AC-3) or DTS source through headphones, play it in stereo by selecting the "Stereo" icon in the "Lstn Mode" menu screen or switch the speakers off.

Muting audio temporarily

Main unit

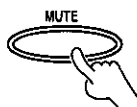

RC

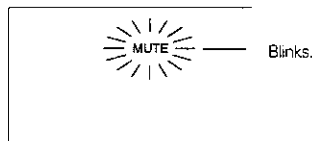

To cancel muting

Press the MUTE key again or adjust the volume.

Listening to Audio

When recording sound with a recorder component of KENWOOD, synchro recording is possible by setting the INPUT SELECTOR to select "Tape1" or "MD" according to the connected component.

Recording from audio components

Recording a music source

- 1 Select the recording source.



The icons differ according to the setup of "Setup IR" etc.

- 2 Put the MD recorder or cassette deck to record-pause mode.

- 1 Select the "Remote Mode" icon from the fixed segments.
- 2 Select the "MD/Tape1" icon.
- 3 Select the MD or cassette deck control icon and put it to record-pause mode.

- 4 Play the source and record it.

- When the "Remote Mode" icon is selected, the icons of the components assigned to the inputs, such as the "CD1", "Video1", "Video2", "Video3" and "MD/Tape1" icons blink for a few seconds.

By selecting a blinking icon, the selected component can be controlled without switching the input selector. (The "Remote Mode" icon can be used to put the recording component to pause mode without switching the input selector.)

When an icon that is not blinking is selected, the input selector is switched automatically.

- For the recording procedure of the MD recorder or cassette deck, refer to its instruction manual.

Copying tape (TAPE1 → TAPE2)

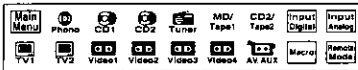

- 1 Select the "MD/Tape1" input.

- 2 Start playback of the cassette deck connected to the MD/TAPE1 input jacks, then start recording of that connected to the CD2/TAPE2 MONITOR input jacks.

Caution for recording

Digital → digital recording

The digital signal input through DIGITAL IN is output digitally at the OPTICAL jack.

Make sure the following points to record a digital signal input into the receiver. (The DTS and Dolby Digital (AC-3) signals cannot be recorded.)

- 1 Connect the digital output from the source component to the digital input of the receiver.
- 2 Connect the digital output (OPTICAL jack) of the receiver to the digital input (OPTICAL jack) of the MD recorder.
- 3 Record the signal on the recorder component (MD recorder).

Digital → analog recording

By reproducing the digital signal input to the receiver in stereo (surround mode), the signal can be recorded in analog with the following procedure.

- 1 Set up the recorder component ready for recording.
 - 2 Select the receiver's input to the source component.
 - 3 Play the desired software.
 - 4 Set the "Input Digital" icon from "Auto" to "Manual".
 - 5 In the "Lstn Mode" menu screen, select the "Stereo" icon.
 - 6 Play the software from the beginning and record it.
- Do not switch to "CD2/Tape2 (Monitor)" during recording. This may cause the interruption of the recording.

Note on CD2/ Tape2 (Monitor)

The following operations are made available by setting the "CD2/Tape2 (Monitor)" icon on the "Setup Input" menu screen to "Tape2 (Monitor)". However, remember that these functions are available only when the analog input/output are used. If the "CD2/Tape2" icon in the fixed segments is selected during playback of a digital input, the input is switched to the analog input and noise may be generated.

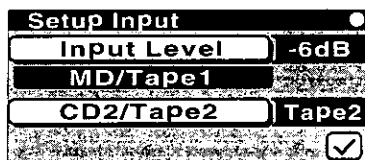

ICON



DISPLAY



"Tape2 (Monitor)" setup menu screen

For the setup of the remote control unit, please read "Set "CD2/Tape2"".

Using "CD2/Tape2"

The CD2/TAPE2 MONITOR input jacks of the main unit accept a cassette deck or graphic equalizer. When a graphic equalizer is connected, set "CD2/Tape2" to "Tape2" and select the "CD2/Tape2" icon in the fixed segments to on.

When a 3-head cassette deck is connected to the CD2/TAPE2 MONITOR input jacks, the recorded audio can be monitored during recording, and turning "CD2/Tape2" on and off allows you to compare the source audio and recorded audio. Refer to the instruction manuals of the connected components for their operating procedures.

The "CD2/Tape2 (Monitor)" function is not available during playback of a digital input. Selecting "CD2/Tape2 (Monitor)" during digital input playback switches the input to the analog input.



Recording video



- ① Select the source you want to record.
- ② Set the video deck to record.
- ③ Start playback, then start recording.

- When recording to a VCR connected to the **VIDEO1** jacks, select a source other than Video1.
- To record a digital source connected to the **VIDEO2, 3 or 4** jacks, turn the **INPUT SELECTOR** to select the appropriate component, then select the **"Stereo"** icon in the **"Lstn Mode"** menu screen. When making a digital recording, operations other than volume adjustment may cause the sound to clip during recording.
- The **AV AUX** jacks on the front panel provide a convenient way to connect a video camera (playback only).
- When recording a DTS or a Dolby Digital (AC-3) source, select the **"Stereo"** icon in the **"Lstn Mode"** menu screen. (The signal is down-mixed to 2 channels before being recorded.)
- For the operating procedures of the video components, refer to their instruction manuals.

Inputs/ Outputs and "CD2/Tape2 (Monitor)"

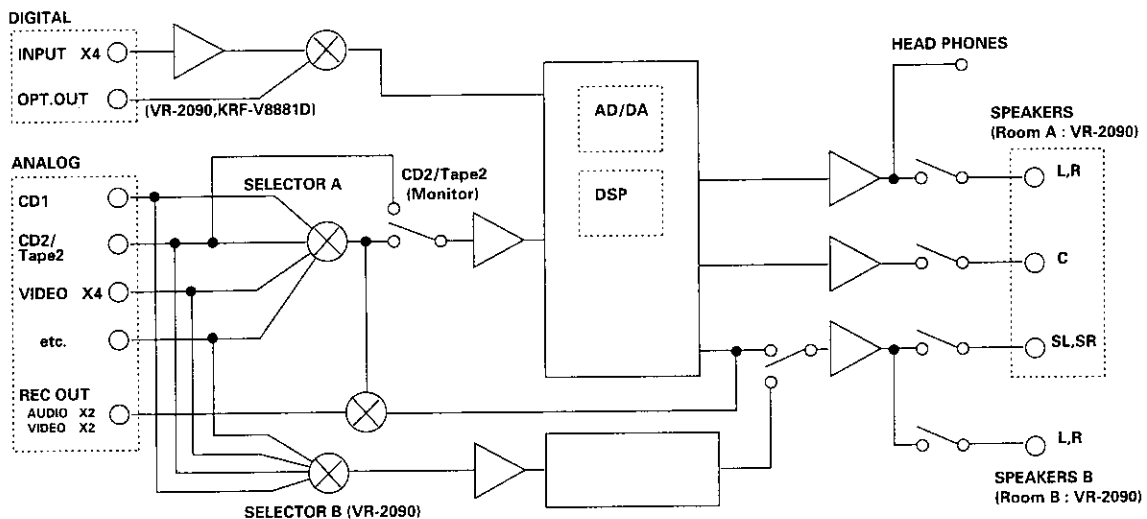

ne
W
be
te
se
is
k,
APE1
CD2/
ereo
the
1.
en to
if the
input
zer.
2"
ed
to
ted
ing

Listening to audio

48

Radio stations can be classified into RDS (Radio Data System) stations and other stations. For listening to RDS stations or storing RDS stations in preset memory, see section entitled "Functions of RDS".

→ 49

General Operation flow

- 1 Selecting the "Tuner" icon
- 2 Selecting control keys

Receiving broadcast station

1 Select the "Tuner" icon.



- The "Tuner" input is selected.

2 Perform the selections.

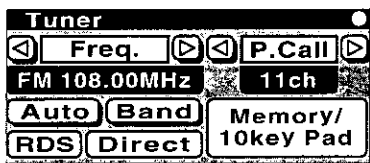

- 1 Select "Band".
The band is alternated every time "Band" is selected.
FM ↔ AM
- 2 Select the tuning method.
The tuning method is alternated every time "Auto" is selected.
"Auto" ↔ "Auto"
(Auto tuning) (Manual tuning)
- Usually set this switch to "Auto".
Select manual tuning when noise interferes due to weak radio wave. (The stereo broadcasting is received in monaural during manual tuning.)
- 3 Select a station.
Select the "◀" or "▶" icon of "Freq.".
Auto tuning : The next station found is tuned automatically.
Manual tuning : Press repeatedly or hold until a station is tuned.

Functions of RDS

RDS is a system which transmits useful information (digital data) for FM broadcasts together with the broadcast signal. Tuners and receivers designed for RDS reception can extract the information from the broadcast signal for use with various functions such as automatic display of the station name.

Functions made possible with RDS

PTY (Program Type Identification) Search :

The tuner automatically searches for a station which is currently broadcasting a specified program type (genre).

TP (Traffic Program) search :

Automatically tunes to a station broadcasting traffic information.

PS (Program Service Name) Display :

When an RDS broadcast is received, the station name is automatically displayed.

RT (Radio Text) display :

Some of the RDS stations also transmit text data. When the RT display is selected with the "RDS Disp." icon, the broadcast text is scrolled on the display.

Auto Memory :

This function automatically selects the stations providing RDS and FM broadcasting and stores them in the preset memory (up to 40 stations can be preset).

* Some functions may not be provided or be given different names depending on countries or areas.



Before using a function utilizing the RDS, be sure to perform the Auto Memory operation by referring to the description in "Storing RDS stations automatically in the preset memory".

RDS Disp. icon

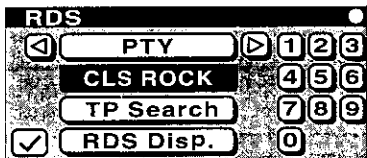

1 Select the "Tuner" icon.

2 Select the "RDS" icon.

3 Select the "RDS Disp." (Display) icon.

The displayed information (Main unit) is switched every time it is selected.

During FM reception :

PS (Program Service Name) Display :

When an RDS broadcast is received, the station name is automatically displayed. If no PS data was sent, "NO PS" is displayed.

RT (Radio Text) display :

Text accompanying RDS broadcast is scrolled on the displayed during reception. "NO RT" is displayed if the received RDS station is not accompanied with RT data.

Frequency Display :

The frequency of the current station is display.



Use the operating procedure on this page to store RDS stations automatically in preset memory. Up to 40 RDS stations can be preset and received with a simple key operation. This unit is compatible with the RDS so it can use convenient RDS functions including automatic tuning.



RDS stations should be stored in the preset memory following the procedure in "Storing RDS stations automatically in preset memory" before listening to RDS stations.

Storing RDS stations automatically in preset memory (Auto Memory)

The following procedure allows to select stations broadcasting RDS broadcast and store them in the preset memory (up to 40 stations can be preset).

1 Select the "Tuner" input.

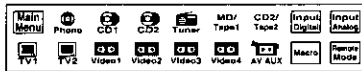

1 Select the "Tuner" icon.

• The last tuned frequency is displayed.

2 Perform selection in the "Tuner" menu screen.

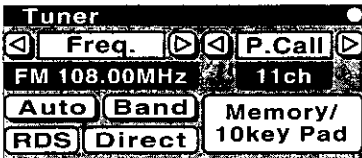

1 Set the receiving band to "FM".

The band is alternated every time "Band" is selected.
FM → AM

Let the FM indicator on the main unit light.

2 Select the "Memory/10 key Pad" icon.

3 Preset stations by performing the Auto Memory operation.



1 Select the "Auto Memory" icon.

In a few minutes, the stations with which RDS broadcast is received are stored in order beginning from preset channels "01" (up to 40 stations can be preset).

When the number of stations providing RDS broadcasting is less than 40, some of other FM stations will be preset in the vacant channels.



• During the "Auto Memory" operation, the corresponding indicator on the main unit blinks.

• If stations have already been stored in preset channels, the same number of these preset channels as the number of stations are cleared and replaced with the data of the newly preset stations.

Receiving a preset RDS station

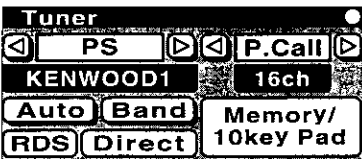

1 It can also be selected by "P.Call".

Select "←" or "→" of "P.Call".

2 It can also be selected using numeric keys.

To specify the preset number (up to 40) of the desired station:

Select numeric icons as follows...

To receive in "15" +10 5

To receive in "20" +10 +10 0



• If you make a mistake in entering the figure of 10, select the +10 icon repeatedly until the original display is shown, then enter the correct number.

The Auto Memory function gives precedence to RDS stations and assigns them from preset number 1. Therefore, when it is required to preset RDS stations as well as non-RDS stations, execute the Auto Memory operation first then proceed to the manual memory operation of non-RDS stations.

Order of radio station presetting



Other stations than the RDS stations can be stored in the preset memory by presetting them after the RDS stations preset by Auto Memory as shown below or overwriting the RDS stations preset in some preset numbers.

Preset number	
1 2	39 40

- ① Auto Memory RDS stations (~ FM stations)
- ② Manual memory FM stations or AM stations

Manual memory of broadcast stations

1 Select the "Tuner" icon.



2 Perform operation in the "Tuner" menu screen.

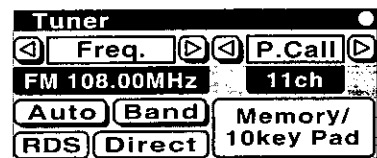

3 Perform operation in the "Memory/10key Pad" menu screen.

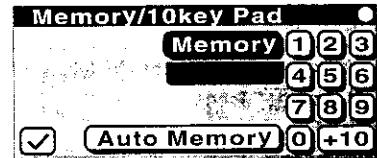

- Apart from the auto memory function, RDS stations can also be stored manually in the preset memory.
- In the manual memory storage operation of radio stations, it may take a few seconds after the "Memory" icon is selected till the memory display starts to blink depending on the receiving condition.
- ① Select the receiving band.
 - Select the "Band" icon.
- ② Select a station or frequency.
 - Select the "◀" or "▶" icon.
- ③ Select the "Memory/10key Pad".
- ④ Select "Memory" icon.
 - The memory mode "Memory" and preset call mode "Memory" are switched alternately every time the icon is selected.
- ⑤ Select one of the preset numbers from 1 to 40.
 - Select numeric icons as follows...
 - To preset in "15" +10 5
 - Repeat steps ②, ③ for each of the stations to be stored in memory.
 - If a station is stored in a preset number which has already stored a station memory under it, the previous memory is replaced by the new memory content.
 - If RDS stations are stored manually in the preset memory, the PS may not be included in the memory depending on receiving conditions.

Receiving a manually preset station

Operation in the "Memory/10key Pad" menu screen

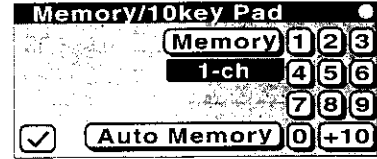

- ① Select the preset number (up to 40) of the desired preset station.
 - Select numeric icons as follows...
 - To receive in "20" +10 +10 0
 - If you make a mistake in entering the figure of 10, select the +10 icon repeatedly until the original display is shown, then enter the correct number.

Receiving preset stations in the preset order (P. Call)

Operation in the "Tuner" menu screen

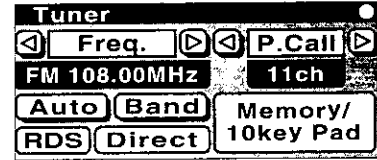

- ① Select the "◀" or "▶" icon of "P.Call".
 - When "P.Call▶" icons are selected
 - 01→02→03.....38→39→40
 - When "◀P.Call" icons are selected
 - 01→02→03.....38→39→40
 - Every time the icon is selected, the next station in the order of the preset number is received. If the icon is held selected ... Preset stations will be received successively for about half a second each.

By specifying the type of program (genre) you want to listen to, the tuner automatically searches for a station which is currently broadcasting a program of the specified type.

With certain receiving conditions, it may take more than 1 minute until the search completes.

Preparation

- Preset RDS stations with the "Auto Memory" function.
- Select the "Tuner" input.
- Set the receiving band to "FM".

Searching for a desired program type (PTY search)

- 1 Select the "Tuner" icon from the fixed segments.
- 2 Select "RDS" icon in the "Tuner" menu screen.
- 3 Perform operation in the "RDS" menu screen.

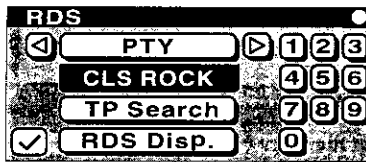

Program type table

(A)	(B)	Program Type Name	Display
(Down) (Up)	4	News	NEWS
		Information	INFORM
	9	Sports	SPORTS
	0	Talk	TALK
	7	Rock	ROCK
		Classic Rock	CLS ROCK
		Adult Hits	ADLT HIT
	8	Soft Rock	SOFT RCK
		Top 40	TOP 40
	2	Country	COUNTRY
		Oldies	OLDIES
		Soft	SOFT
		Nostalgia	NOSTALGA
	3	Jazz	JAZZ
	1	Classical	CLASSICL
		Rhythm and Blues	R & B
		Soft Rhythm and Blues	SOFT R & B
		Foreign Language	LANGUAGE
	6	Religious Music	REL MUSC
		Religious Talk	REL TALK
		Personality	PERSNLTY
	5	Public	PUBLIC
		College	COLLEGE
		Weather	WEATHER

The Program Type information is displayed during reception of RDS broadcasting. (Display on the receiver main unit)
 If the PTY data is not broadcast or the tuned station is not an RDS station, "NONE" is displayed. (Display on the receiver main unit)

- ① Select the "PTY" icon.
- ② Select the desired program type.

Select by referring to the Program Type list on the left.

- Ⓐ To select with the "◀" or "▶" icons.
- Ⓑ To select with numeric icons.

Ⓐ To select a program type with the "◀" or "▶" icon.

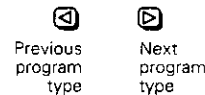

Select while "PTY" is lit.

Selecting the "◀" or "▶" icon selects the 24 program types in sequence. When the desired program type is displayed, release the icon.

Ⓑ To select a program type with numeric icons.

The numeric icons allow you to specify the desired program type from types numbered 1 to 0. To select other program type than them, use the "◀" or "▶" icon.

Correct PTY search information may not be displayed if this operation is attempted before performing the "Auto Memory" operation.

1a
em)
in/K)
ntly

4 Start the search.

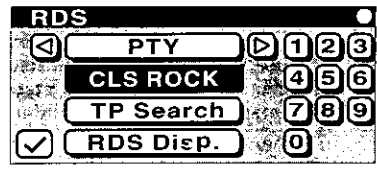

1 Select the "PTY" icon.

Select the icon again while it is displayed in reverse.

- No sound is heard while "PTY" is blinking.
- During PTY search, the corresponding indicator on the main unit blinks.
- If a program of the desired type cannot be found, "NO PROGRAM" is displayed, then after several seconds the display returns to the original display. (Display on the receiver main unit)
- When a station with the selected program type is searched, its reception starts and the type name display changes to the station name display. (Display on the receiver main unit)

To change to a different program type

Repeat steps 1, 2, 3, 4.

To cancel

1 Select the "PTY" icon during PTY search.

Listening to Ardio

TP (Traffic Program) search :
Automatically tunes to a station broadcasting traffic information.

Preparation

Perform steps 1 to 2 of "Storing RDS stations automatically in the preset memory (Auto Memory)".



This step can be omitted if you have already executed the Auto Memory procedure.

- The TP Search function cannot be used if all of the 40 preset stations have been stored using the procedure in "Storing radio stations manually in preset memory". Be sure to use the Auto Memory function.

TP Search

1 Select the "Tuner" icon from the fixed segments.

2 Perform operation in the "Tuner" menu screen.

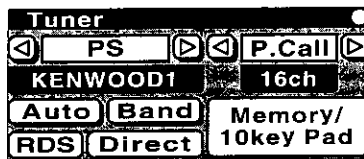

- ① Set the receiving band to "FM".
The band is alternated every time "Band" is selected.
FM ↔ AM
- ② Select the "RDS" icon to open the "RDS" menu screen.

3 Perform operation in the "RDS" menu screen.

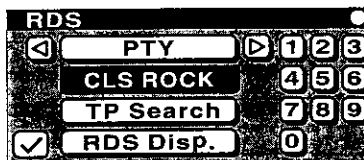

- ③ Select the "TP Search" icon .
- During TP search, the corresponding indicator on the main unit blinks.
- If TP Search is not required, perform the Auto Memory operation again.

TP (Traffic Program) Indication

When the "TP" indication is lit, this indicates that this station or a station in the same network is transmitting traffic information. When "TP" is displayed for the station presently being received, the traffic information of this station can be heard .

To cancel TP Search

Select the "TP Search" icon during TP search.



General operation flow

- 1 Selecting the "Tuner" icon
- 2 Selecting control keys

tions
ions
mory

Receiving broadcast station

1 Select the "Tuner" icon.



• The "Tuner" input is selected.

2 Perform selections.

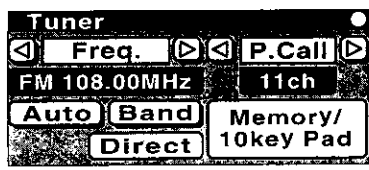

- 1 Select "Band".
The band is alternated every time "Band" is selected.
FM ↔ AM
- 2 Select the tuning method.
The tuning method is alternated every time "Auto" is selected.
"Auto" ↔ "Auto"
(Auto tuning) (Manual tuning)
- Usually set this switch to "Auto".
Select manual tuning when noise interferes due to weak radio wave. (The stereo broadcasting is received in monaural during manual tuning.)
- 3 Select a station.
Select the "◀" or "▶" icon of "Freq.".
Auto tuning : The next station found is tuned automatically.
Manual tuning : Press repeatedly or hold until a station is tuned.



Receiving a station by specifying the frequency

1 Select the "Tuner" input.

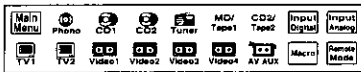

1 Select the "Tuner" icon.

• The last tuned frequency is displayed.

2 Perform selection in the "Tuner" menu screen.

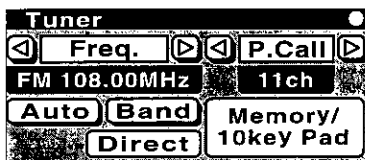

2 Set the receiving band.

Each select "Band" icon switches the indication.

FM ↔ AM

3 Specify the frequency.



3 Select the "Direct" icon.

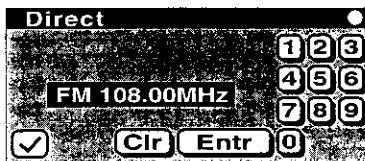

4 Input the frequency to be tuned using the numeric icons as follows.

Examples of input frequencies :

AM 310 kHz 8 1 0 Entr

AM 1260 kHz 1 2 6 0 Entr

FM 89 MHz 8 9 0 0 Entr

FM 92.5 MHz 9 2 5 0 Entr

* FM DE-EMPHASIS/CHANNEL SPACE switch.



• If you made a mistake, the frequency display will blink for a few seconds. In this case, restart operation from the beginning of step 3.

Preparation

- Select the "Tuner" input.

Presetting radio stations manually

1 Select the "Tuner" icon.

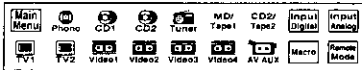

2 Perform operation in the "Tuner" menu screen.

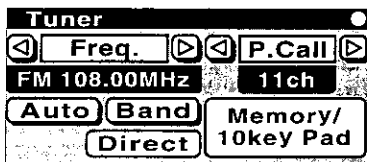

3 Perform operation in the "Memory/10key Pad" menu screen.

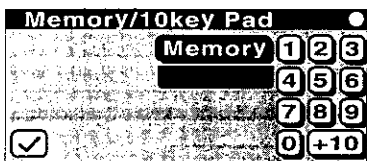

1 Select the receiving band.

Select the "Band" icon.

2 Select a station or frequency.

Select the "◀" or "▶" icon.

3 Select the "Memory/10key Pad".

1 Select "Memory" icon.

- The memory mode "Memory" and preset call mode "Memory" are switched alternately every time the icon is selected.

2 Select one of the preset numbers from 1 to 40.

Select numeric icons as follows...

To preset in "15" +10 5

- Repeat steps 2, 3 for each of the stations to be stored in memory.
- If a station is stored in a preset number which has already stored a station memory under it, the previous memory is replaced by the new memory content.

Receiving preset stations

Operation in the "Memory/10key Pad" menu screen

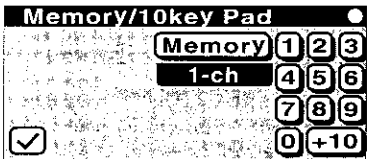

1 Select the preset number (up to 40) of the desired preset station.

Select numeric icons as follows...

To receive in "20" +10 +10 0

- If you make a mistake in entering the figure of 10, select the +10 icon repeatedly until the original display is shown, then enter the correct number.

Receiving preset stations in order (P. Call)

Operation in the Tuner menu screen

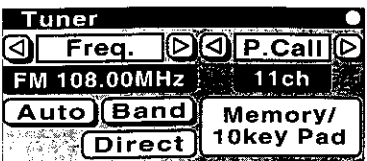

1 Select the "◀" or "▶" icon of "P.Call".

When "P.Call▶" icons are selected....

01→02→03.....38→39→40

When "◀P.Call" icons are selected....

01→02→03.....38→39→40

- Every time the icon is selected, the next station in the order of the preset number is received.
If the icon is held selected ... Preset stations will be received successively for about half a second each.

Listening to Audio



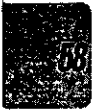

This receiver incorporates 5 different sound modes to let you enjoy surround sound with a wide variety of program sources. The Dolby Digital (AC-3) and Dolby Pro Logic surround modes let you enjoy theater-like surround effects when you play Dolby Digital (AC-3) and Dolby Surround program sources (like videotapes, LaserDiscs and DVDs). The Dolby 3 Stereo mode creates a panoramic frontal sound field. The DSP (Digital Signal Processing) mode lets you create a variety of different sonic environments from PCM as well as analog sources. To obtain the best possible surround sound, be sure to complete "Setup for surround play" before using the surround modes.

Sound modes

DTS

The DTS multi-channel audio format is available on CD, LD and DVD software. DTS is a strictly digital format and can not be decoded inside most CD, LD or DVD players. For this reason, if you attempt to listen to DTS encoded software through the analog output of your new CD, LD or DVD player, you will experience digital noise in most cases. This noise can be quite loud if the analog output is connected directly to a high power amplification system. Proper measures for playing the digital output as described below should be taken to avoid this situation. To enjoy DTS Digital Surround playback, an external 5.1 channel DTS Digital Surround decoder system or an amplifier with a built-in DTS Digital Surround decoder must be connected to the digital output (S/P DIF, AES/EBU or TosLink) of a CD, LD or DVD player.

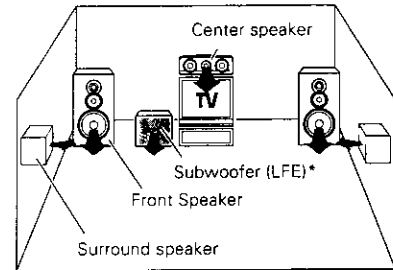

* Optional in this mode.

* LFE = Low Frequency Effects. This channel delivers separate non-directional bass signals to the subwoofer for more dynamic deep bass sound effects. DTS has a .1 or LFE channel.

Dolby Digital (AC-3)

The Dolby Digital (AC-3) surround format lets you enjoy up to 5.1 channels of digital surround sound from Dolby Digital (AC-3) program sources (such as Laserdisc software marked). Compared with previous Dolby surround, Dolby Digital (AC-3) provides even better sound quality, greater spatial accuracy, and improved dynamic range.

Note

Although a full set of speakers (front left and right, center, Surround left and right, and a subwoofer) is required for true 5.1 channel Dolby Digital (AC-3) surround sound, this receiver lets you enjoy Dolby Digital (AC-3) (and Dolby Pro Logic) program sources, even if you connect only the front speakers.

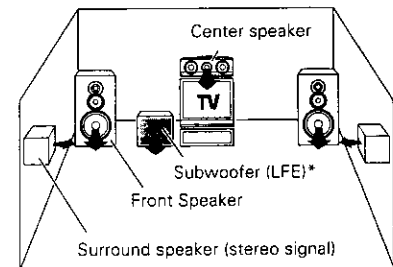

* Optional in this mode.

* LFE = Low Frequency Effects. This channel delivers separate non-directional bass signals to the subwoofer for more dynamic deep bass sound effects. Dolby Digital is the only Dolby method to have an LFE channel.

Dolby Pro Logic

Dolby Pro Logic is a specially encoded 2 channel surround format designed to provide theater-like surround sound from Dolby Surround encoded sources (such as video and Laserdisc software marked). This receiver is equipped with a Dolby Pro Logic surround decoder to let you enjoy the wide variety of currently available Dolby Surround home video software.

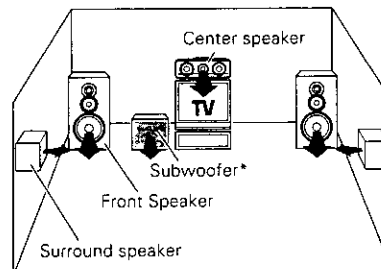

In case center speaker is not used

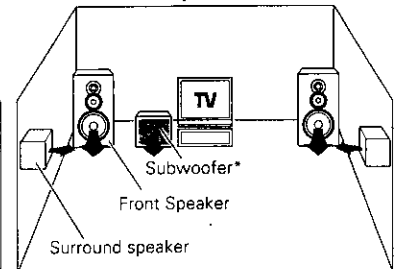

* Optional in this mode.



Dolby 3 Stereo

Dolby 3 Stereo is available for systems that do not have surround speakers. When in the Dolby 3 Stereo mode the surround information is redirected to the front left and right speakers. This mode is designed for use with Dolby Surround program sources, but can also improve sound field unity for programs that are not Dolby Surround encoded. Dialog positioning and sound image definition, however, may not be as accurate when used with programs that are not Dolby Surround encoded.

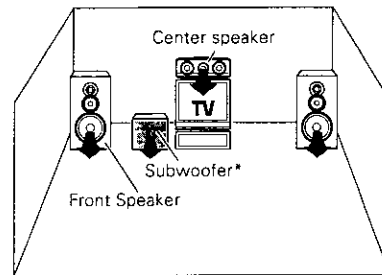

* Optional in this mode.

DSP mode

The DSP mode lets you add the atmosphere of an arena, jazz club or stadium from a PCM or analog input source. * These modes are particularly effective when used with stereo program sources, like CD, television, and FM radio. You might enjoy trying the STADIUM or ARENA mode the next time you watch a concert or sporting event!

The WALL parameter lets you adjust the "brightness" of the sonic environment according to your preference.

The ROOM SIZE parameter lets you adjust the size of the sonic environment according to your preference.

The EFFECT level lets you adjust the "presence" of the sonic environment according to your preference.

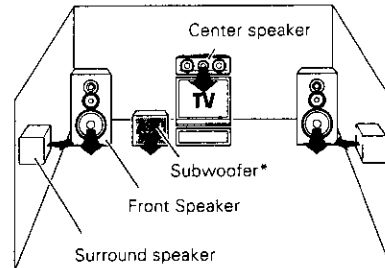

* Optional in this mode.

* The DSP mode will produce a stereo-like surround effect from monaural sources, but there will be some reduction in the presence of the arena, jazz club, or stadium (etc.).

Manufactured under license from Dolby Laboratories. "Dolby", "Pro Logic" and the double-D symbol are trademarks of Dolby Laboratories. Confidential Unpublished Works. ©1992-1997 Dolby Laboratories. All rights reserved.

Manufactured under license from DTS, Inc. "DTS", "digital surround", and "coherent acoustics" are trademarks of DTS, Inc. © 1997 DTS, Inc. All rights reserved.



Recommended speaker installation



It is recommended that the surround speakers are installed straight to the left and right of the listening position or slightly behind, at a height of about 1 meter higher than the listener's ears. See your retailer, or installation varies by room shape, size and personal preference.

What is DSP?



The DSP stands for Digital Signal Processor. In the DSP presence mode, the reverberation components (elements of sound echoed in various spaces) which determine the feeling of presence are created by digital processing by the DSP without spoiling the sound quality of the original music source.

Available play modes

The following table shows the relationship between the source signal, source component and receiver input, and the play mode than can be selected from the surround menu.

Source Signal	Source Component	Receiver Input	Play Modes That Can be Selected from "Lstn Mode" menu
DTS	CD / LD / DVD *1	Digital	DTS / Stereo
Dolby Digital (AC-3)	DVD	Digital	Dolby Digital / Stereo *2
Dolby Digital (AC-3) RF	LD (DEMODULATOR)	Digital	Dolby Digital / Stereo *2
PCM / Analog	CD / LD / DVD etc.	Digital / Analog	Pro Logic / 3 Stereo / Stereo / DSP mode

*1 Playback is possible if the source component is a DTS compatible player. Refer to the instruction manual of your player to check if DTS compatible.

*2 When the Dolby Digital (AC-3) signal has 2 or 2.1 channels, it can be played using Pro Logic or 3 Stereo mode.

Caution for surround play

During playback of a DTS source

- The "Input Analog" mode cannot be selected during playback of a DTS source.
- Playback in the DTS mode is not available in "Room B".
- Depending on the player in use, noise may be generated depending on the operation method employed for DTS play. When playing a DTS source, wait until "DTS" is displayed before proceeding to the desired operation.

Display during playback in DTS mode

Surround Play Mode	Input Signal	Panel DTS Indicator	LCD Display	
			Lstn Mode	Status
DTS	DTS	Lights	DTS	DTS
DTS	Dolby Digital	Blinks	DTS	Dolby Digital
DTS	PCM	Blinks	DTS	PCM

Display during playback in Digital (Dolby Digital) mode

Surround Play Mode	Input Signal	Panel Dolby Digital Indicator	LCD Display	
			Lstn Mode	Status
Dolby Digital	DTS	Blinks	Dolby Digital	DTS
Dolby Digital	Dolby Digital	Lights	Dolby Digital	Dolby Digital
Dolby Digital	PCM	Blinks	Dolby Digital	PCM

Display during playback in PCM mode

Surround Play Mode	Input Signal	Panel Dolby Digital Indicator	LCD Display	
			Lstn Mode	Status
PCM	DTS	Lights off	*3	DTS
PCM	Dolby Digital	Lights off	*3	Dolby Digital
PCM	PCM	Lights off	*3	PCM

*3 Pro Logic, 3 Stereo or Stereo.

During analog playback

- Noise is generated when a DTS source is played. Switch to "Input Digital" before playing a DTS source.

During "Digital Auto" play

During "Digital Manual" play

- The selection of the "Surround" icon may be restricted depending on the input signal.
- After power is switched ON/OFF (or the ON/STANDBY key is pressed to switch over to the STANDBY or ON mode), when the speakers are switched ON/OFF or when the analog input is selected after "Digital Manual" playback, "Digital Manual" is switched automatically to "Digital Auto".
- Use the "Digital Manual" mode when playing a 2/0 (2 channel or 2.1 channel) AC-3 input in the Pro Logic or 3 Stereo mode or other input than 2/0 (2 channel or 2.1 channel) signal in Stereo mode.
During "Digital Auto" playback of certain DVD and LD players, performing operations such as "Skip" or "Stop" may switch "Lstn Mode" automatically to the surround mode intended for the input signal.

Surround play

1 Select the "Main Menu" icon.



- ① If the "Lstn Mode" icon is not displayed, select "Lsn" from the menu screen to display the "Lstn Mode" menu screen.

2 Select the "Input Digital" icon so that "Auto" is displayed.

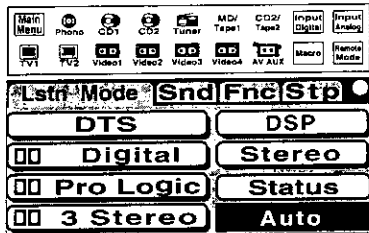

"Auto" should be displayed in normal use. If you want to set the "Lstn Mode" to "Manual", verify the surround play is still possible by referring to the table on the previous page. By setting the "Lstn Mode" to "Manual", you can always use a fixed surround mode or select the desired surround mode every time. (With "Manual", the surround mode can be selected whenever there is an input signal.)

- ② Select the "Input Digital" icon from the fixed segments so that "Auto" is displayed.
- When "Input Digital" is selected, the "Input Sound Status" menu screen appears.

The display is alternated every time the "Input Digital" icon is selected.

Auto ↔ Manual

- When "Auto" is displayed by selecting the "Input Digital" icon, the playback is switched automatically when the output signal from the source changes from a DTS or Dolby Digital signal to a PCM signal.
- If the digital input is not connected to the main unit, select "Input Analog".

3 Display the component control screen.

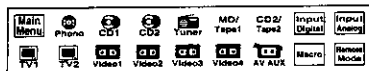

- ③ Select the icon of the component to be played from the fixed segments.

(Example)

To play a DVD disc, make sure that the DVD player is assigned to "Video3" and select the "Video3" icon.

- Select the icon of the component which has been assigned in "Assigning the connected components to the selected inputs".

4 Play the software.

- ④ Select the play key of the component to be played.

5 Adjust the volume.

Playback of digital input / playback of analog input

Switch the input setup of the receiver to "Input Digital" or "Input Analog" according to whether the input signal from the source component is digital or analog.

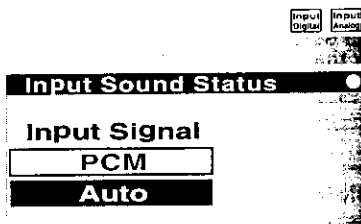

To play a digital input

Select the "Input Digital" icon in the fixed segments to play a digital input.

- 1 Select the "Input Digital" icon.
- For "Auto" and "Manual" of "Input Digital", see the description on the previous page.
- The type of the signal being played (PCM, etc.) is shown in the "Input Signal" display.

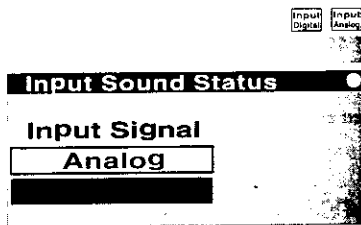

To play an analog input

Select the "Input Analog" icon in the fixed segments to play an analog input.

- 1 Select the "Input Analog" icon.
- "Analog" is shown in the "Input Signal" display.

Checking the surround play status

The surround mode and input signal used in the current playback session can be displayed.

1 Select the "Main Menu" icon.



- 1 Select the "Lsn" icon from the "Main Menu" screen to display the "Lstn Mode" menu screen.

2 Perform operation in the "Lstn Mode" menu screen.

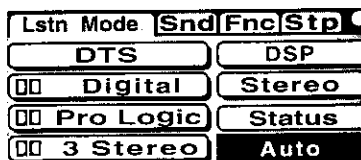

- The surround mode in use can be shown in the "Lstn Mode" menu screen.
- 1 Select the "Status" icon.
- Selecting the "Status" icon displays the "Input Sound Status" menu screen.

3 Display in the "Input Sound Status" menu screen.

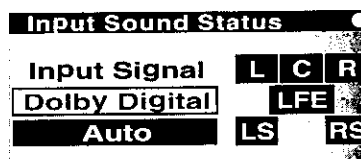

- The "Input Sound Status" menu screen shows the signal being played.
- During Dolby Digital (AC-3) playback, the input signals from the source component are shown using icons such as "L", "C" and "R".

Applying surround effect in DSP mode

If the played signal is a PCM or analog, it can be played with acoustic field by using the DSP mode.

Preparation
Play music.

1 Select the "Main Menu" icon.



- If the "Lstn Mode" icon is not displayed in the "Main Menu" screen, select the "Lsn" icon to display the "Lstn Mode" menu screen.

2 Perform operation in the "Lstn Mode" menu screen.

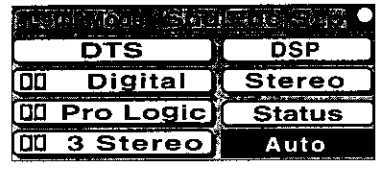

For the condition in which playback with the acoustic field effect in the DSP mode is possible, see the description in "Available play modes".

- When the digital input is connected to the main unit**
- 1 Select the "Input Digital" icon from the fixed segments so that "Auto" is displayed.
The display is alternated every time the "Input Digital" icon is selected.
Auto ↔ Manual
 - 2 Select the "DSP" icon.

- When the analog input is connected to the main unit**
- 1 Select the "Input Analog" icon from the fixed segments.
 - The "Input Analog" icon can be selected when the analog input is connected to the input jacks of the main unit.
 - 2 Select the "DSP" icon.

3 Select the mode from the "DSP Mode" menu screen.

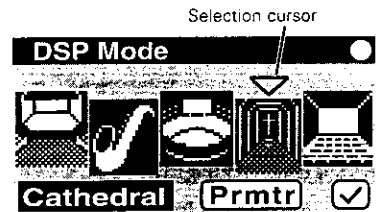

- Use the joystick to move the selection cursor to the desired DSP mode and press the ENTER key.
- Arena** : the audio atmosphere in the front row of a large concert arena.
 - Jazz Club** : a smaller, more intimate setting, with the listener setting close to the music.
 - Stadium** : the audio environment of a vast, open-air stadium.
 - Cathedral** : the musical ambience of a large, enclosed space with a high, open ceiling.
 - Theater** : the crisp acoustics of theater setting.
- To adjust the audio in the "DSP Mode", select the "Prmtr" (Parameter) icon.

4 Adjust the DSP mode.

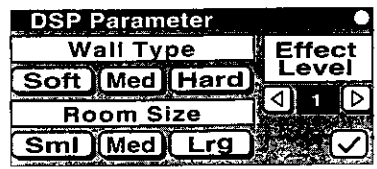

Lrg : Large
Med : Medium
Sml : Small

- Select the "Prmtr" icon in the "DSP Mode" menu screen.
- 1 Select the item to be adjusted.
 - Wall Type** : Switches the quality of the walls.
 - Room Size** : Switches the room size.
 - Effect Level** : Switches the effect level.

Adjusting the audio

VR-2090/VR-2080/KRF-V88B1D/KRF-V7771D (En/K)



The sound quality and the volumes of the speakers can be adjusted as required.

Use the procedure on this page to adjust the audio individually, on a per-source or per-program (movie) basis.

The effects of the loudness and tone setups are applied only to the sounds output from the "L" and "R" front speakers.

The loudness or tone control effect is maximized when "Lstn Mode" is set to "Stereo".

Therefore, when the front speakers are set to "Nml" (Normal), low-frequency components are output from the subwoofer so the loudness and tone effects are minimized.

1 Select the "Main Menu" icon.



- Select the "Snd" icon from the "Main Menu" screen to display the "Sound" menu screen.

2 Perform operation in the "Sound" menu screen.



SP Level : Speaker level
 : Midnight mode

- Adjust the Loudness.
This can be switched between On → Off.
- Set the midnight mode.
This setting is possible only with the Dolby Digital (AC-3) input source.
This can be switched in order of 1 → 2 → Off.
 - When adjusting the Tone, go to step 3.
 - When adjusting the speaker level, go to step 4.

3 Adjust the "Tone".

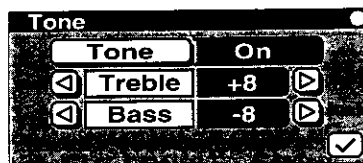

- Select the "Tone" icon in step 2.
- Set "Tone" to "On" or "Off".
 - Adjust "Treble".
 - Adjust "Bass".

4 Adjust the "SP Level".

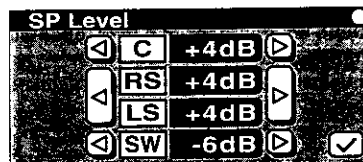

C :Center speaker
 RS :Right Surround speaker
 LS :Left Surround speaker
 SW :Subwoofer

- Select the "SP Level" icon in step 2.
- To return to step 2 from step 3, select the "✓" (checkmark) icon.
- The speaker volumes adjusted here is only temporal. These settings are returned to the setups made using "Setup" chapter when the power is switched off or another input is selected.
- The speakers which have not been set up in the "SP Selection" or "SP Selection (Custom)" menu screen under the "Setup Surround" menu are displayed as "-" in the "SP Level" menu screen.

- Adjust the level of each speaker.

Adjusting Audio



In case of difficulty

VR-2090/VR-2080/KRF-V88B1D/KRF-V7771D (En/K)

What appears to be a malfunction may not always be serious. If your unit should not perform as expected, consult the table below to see if the problem can be corrected before seeking help from your dealer or service representative.

How to reset the microcomputer

The microcomputer may malfunction (impossibility of operation, erroneous display, etc.) when the power cord is unplugged and plugged in again while the unit is in ON mode with the I/⏻ key pressed or due to other external causes. In this case, execute the procedure on the right to reset the microcomputer and return the unit to the normal condition.

- Resetting the microcomputer clears the memory you entered and returns it to the initial condition when the unit left the factory.

U.S.A. and Canada

- ① Unplug the power cord from the wall outlet.
- ② While holding the I/⏻ (ON/STANDBY) key depressed, plug the power cord into the wall outlet again.

Expect for U.S.A. and Canada

- ① With the power cord plugged in, turn the POWER key OFF.
- ② While holding down the ON/STANDBY key, press POWER key.

Amplifier

Symptom	Cause	Remedy
Sound is not output or the volume level is low.	<ul style="list-style-type: none"> ● Connection cords are unplugged from the jacks. ● MUTE is ON. (The MUTE ON indicator is blinking) ● The CD 2 / Tape 2 (Monitor) is set to ON. ● The selected surround mode does not match the input signal. 	<ul style="list-style-type: none"> ● Connect them properly referring to "System connection". ● Press the MUTE key to OFF. ● Set the CD 2 / Tape 2 (Monitor) to OFF. ● Select the surround mode according to the input signal or select "Auto" with "Input Digital".
"STANDBY" indicator blinks and sound is not output.	<ul style="list-style-type: none"> ● Speaker cords are short-circuited. 	<ul style="list-style-type: none"> ● Unplug the AC cord, remove the short-circuiting and plug the AC cord again.
Sound is not output from one of the speakers.	<ul style="list-style-type: none"> ● The speaker cord is disconnected. 	<ul style="list-style-type: none"> ● Connect it properly referring to "Speaker connections/ PRE OUT connections".
Sound is not output from the surround speaker and/or center speaker, or their sound is very small.	<ul style="list-style-type: none"> ● The surround speaker cords and/or center speaker cord are disconnected. ● The surround play mode has not been engaged. ● The surround and center speaker levels are set to the minimum positions. 	<ul style="list-style-type: none"> ● Connect them by referring to the power amplifier's instruction manual. ● Set the surround mode. ● Adjust the surround and center speaker levels.
A humming noise is generated when the PHONO input selector is selected.	<ul style="list-style-type: none"> ● The audio cord from the turntable is not connected to the PHONO jacks. ● The turntable is not grounded. 	<ul style="list-style-type: none"> ● Insert the audio cord plugs securely into the PHONO jacks. ● Connect the grounding wire to the grounding wire terminal on the rear panel.
The initial sound is intermittent when starting playback from an AC-3 source in a DVD player.	<ul style="list-style-type: none"> ● There are different causes for different types of DVD players. 	<ul style="list-style-type: none"> ● With certain DVD players, the initial sound may be intermittent.
No sound when playing a DVD.	<ul style="list-style-type: none"> ● "Auto" is not set. 	<ul style="list-style-type: none"> ● Set "Input Digital" to "Auto".
Digital playback is not possible from Dolby Digital (AC-3) sources.	<ul style="list-style-type: none"> ● "Auto" is not set. 	<ul style="list-style-type: none"> ● Set "Input Digital" to "Auto".
Noise is generated during DTS playback.	<ul style="list-style-type: none"> ● "Input Analog" is used. 	<ul style="list-style-type: none"> ● Set to "Input Digital".
System control is impossible.	<ul style="list-style-type: none"> ● System control cords are connected incorrectly. 	<ul style="list-style-type: none"> ● Connect them correctly by referring to "System connection".

Tuner

Symptom	Cause	Remedy
Radio stations cannot be received.	<ul style="list-style-type: none"> ● No antenna is connected. ● The broadcast band is not set properly. ● The frequency of the desired station is not tuned. 	<ul style="list-style-type: none"> ● Connect an antenna. ● Set the broadcast band properly. ● Tune the frequency of the desired station.
Interference.	<ul style="list-style-type: none"> ● Noise due to ignition noise of an automobile. ● Noise due to an influence from an electric appliance. ● Noise due to a nearby TV set. 	<ul style="list-style-type: none"> ● Install the outdoor antenna away from the road. ● Turn off the power to the appliance. ● Install the system farther away from the TV set.
A station which was preset cannot be received by pressing the corresponding numeric key.	<ul style="list-style-type: none"> ● The preset memory was cleared because the power cord had been unplugged for a long period of time. ● The "Tuner" input is not selected. 	<ul style="list-style-type: none"> ● Preset the stations by auto memory again. ● Select the "Tuner" input.

Memory backup function

Please note that the following items will be deleted from this unit's memory if the power cord is disconnected from the AC outlet for approximately three days.

- The input selection is cleared and the "Tuner" input is selected.
- The volume setting is cleared and the volume is set to "-66 dB".
- The receiving band setting is cleared and the "FM" band is selected.
- The frequency setting is cleared and 87.5 MHz is selected.
- The preset station memory is cleared.
- The surround setting is cleared and reset to the initial condition.

Remote control unit

Symptom	Cause	Remedy
Remote control operation is not possible.	<ul style="list-style-type: none"> ● Batteries are exhausted. ● The remote control unit is too far away from the main system, controlling angle is too large, or there is an obstacle in between. ● The audio cords and system control cords are not connected properly. ● The source component to be operated does not contain the tape(s) or disc. 	<ul style="list-style-type: none"> ● Replace with new batteries. ● Operate the remote control unit within the controllable range. ● Connect properly referring to "System connection". ● Place the tape(s) or disc in the source component to be played.
The RC screen is not displayed.	<ul style="list-style-type: none"> ● Batteries are exhausted. 	<ul style="list-style-type: none"> ● Replace with new batteries.
The RC display is abnormal.	<ul style="list-style-type: none"> ● Batteries are removed while something is displayed. 	<ul style="list-style-type: none"> ● Remove and replace batteries after the information display has disappeared.

Setup Codes chart

Although each setup code is designed to work with a number of different models, certain codes may not work with some models. (Also, certain codes may only operate some of the functions available on a given model.)

With some models, be sure to keep the ENTER key pressed for a while.

Inquiries on the setup codes loaded using the Free-Phone Consumer Help Line:

If there is any inquiry related to these setup codes, please contact the following services.

U.S.A. : 1-800-753-9860 Canada : 1-800-644-0073

For the U.S.A.

FCC WARNING

This equipment may generate or use radio frequency energy. Changes or modifications to this equipment may cause harmful interference unless the modifications are expressly approved in the instruction manual. The user could lose the authority to operate this equipment if an unauthorized change or modification is made.

NOTE:

This equipment has been tested and found to comply with the limits for a Class B digital device, pursuant to Part 15 of the FCC Rules. These limits are designed to provide reasonable protection against harmful interference in a residential installation. This equipment may cause harmful interference to radio communications, if it is not installed and used in accordance with the instructions. However, there is no guarantee that interference will not occur in a particular installation. If this equipment does cause harmful interference to radio or television reception, which can be determined by turning the equipment off and on, the user is encouraged to try to correct the interference by one or more of the following measures:

- Reorient or relocate the receiving antenna.
- Increase the separation between the equipment and receiver.
- Connect the equipment into an outlet on a circuit different from that to which the receiver is connected.
- Consult the dealer or an experienced radio / TV technician for help.

For the U.S.A.

Note to CATV system installer:

This reminder is provided to call the CATV system installer's attention to Article 820-40 of the NEC that provides guidelines for proper grounding and, in particular, specifies that the cable ground shall be connected to the grounding system of the building, as close to the point of cable entry as practical.



Do not use contact cleaning agents because they could cause a malfunction. Be specifically careful against using contact cleaning agents containing oil, since they may deform the plastic components.

⚠ Caution : Read this page carefully to ensure safe operation.

AUDIO section

Rated output power during STEREO operation

100 watts per channel minimum RMS, both channels driven, at 6 Ω from 20 Hz to 20 kHz with no more than 0.03 % total harmonic distortion.(FTC)

Rated output power during SURROUND operation

FRONT
 (1kHz, 0.7% T.H.D. at 6 Ω) 100 W + 100 W
CENTER
 (1kHz, 0.7% T.H.D. at 6 Ω) 100 W
SURROUND
 (1kHz, 0.7% T.H.D. at 6 Ω) 100 W + 100 W
 Total harmonic distortion 0.004% (1 kHz, 50 W, 6 Ω)

Frequency response (IHF'78)
 CD 5 Hz ~ 80 kHz, +0.5 dB, -3 dB
 Signal to noise ratio (IHF'66)
 PHONO (MM) 77 dB
 CD 90 dB

Input sensitivity / impedance
 PHONO (MM) 2.5 mV / 47 kΩ
 CD 200 mV / 47 kΩ

Output level / impedance
 TAPE REC 200 mV / 220 Ω
 PRE OUT (CENTER, SURROUND, SUBWOOFER)
 1 V / 1 kΩ

Tone control
 BASS ±7 dB (at 100 Hz)
 TREBLE ±7 dB (at 10 kHz)
 LOUDNESS control
 VOLUME at -40dB level ... +7 dB(100 Hz), +4 dB(10 kHz)

DIGITAL AUDIO section

Sampling frequency 32 kHz, 44.1 kHz, 48 kHz
 Input level / impedance / wave length
 Optical -15 dBm ~ -21 dBm, 660 nm ±30nm
 Coaxial 0.5 Vp-p / 75 Ω

VIDEO section

VIDEO inputs / outputs
 VIDEO (composite) 1 Vp-p / 75 Ω
 S VIDEO (luminance signal) 1 Vp-p / 75 Ω
 (chrominance signal) 0.286 Vp-p / 75 Ω

FM tuner section

Tuning frequency range 87.5 MHz ~ 108 MHz
 Usable sensitivity (MONO)
 1.6μV (75 Ω) / 15.2 dBf (75 kHz DEV., SINAD 30 dB)
 50dB quieting sensitivity
 STEREO 31.6μV (75 Ω) / 41.2 dBf
 Total harmonic distortion (1 kHz)
 MONO 0.3 % (65 dBf input)
 STEREO 0.6 % (65 dBf input)
 Signal to noise ratio (1 kHz, 75 kHz DEV.)
 MONO 75 dB (65 dBf input)
 STEREO 68 dB (65 dBf input)
 Stereo separation (1 kHz) 38 dB
 Selectivity (±400 kHz) 70 dB
 Frequency response 30 Hz ~ 15kHz,+0.5 dB, -3.0 dB

AM tuner section

Tuning frequency range
 10 kHz step 530 kHz ~ 1,700 kHz
 Usable sensitivity (30% mod., S/N 20 dB)
 16 μV / (600 μV/m)
 Signal to noise ratio (30 % mod. 1 mV input) 50 dB

Relay and IR IN/OUT section

RELAY CONTROL terminal
 Maximum output current 20 mA
 Operating voltage 12 V
 Output impedance 470 Ω

IR RECEIVER IN terminal
 Maximum output current 20 mA
 Operating voltage 12 V
 Output impedance 470 Ω

IR OUT LCD REMOTE terminal
 Maximum output current 20 mA
 Operating voltage 12 V
 Output impedance 470 Ω

IR REPEATER CONTROL terminals
 Maximum output current 20 mA
 Operating voltage 12 V
 Output impedance 470 Ω

Shape of plug to be connected

IR RECEIVER IN, IR OUT LCD REMOTE and RELAY CONTROL	IR REPEATER OUT

IR IN/OUT specification

Terminal	IR RECEIVER IN	IR REPEATER OUT and IR OUT LCD REMOTE
To Tip	Signal	Signal
To Ring	Ground	—
To Sleeve	+12 V	Ground

RELAY CONTROL specification

Status	Power off	Power on	Power on and when switch to video input
To Tip	0 V	0 V	+12 V
To Ring	0 V	+12 V	+12 V
To Sleeve	Ground	Ground	Ground

GENERAL

Power consumption 3.5 A
 AC outlet
 SWITCHED 2 (total 90 W, 0.75 A max.)
 Dimensions W: 440 mm (17-5/16")
 H: 162 mm (6-3/8")
 D: 391 mm (15-3/8")
 Weight (Net) 12 kg (26.5 lb)



1. KENWOOD follows a policy of continuous advancements in development. For this reason specifications may be changed without notice.
2. Full performance may not be exhibited in extremely cold locations (below 0 deg.C).

Specifications (VR-2080)

VR-2090/VR-2080/KRF-V8861D/

⚠ Caution : Read this page carefully to ensure safe operation.



AUDIO section

Rated output power during STEREO operation

100 watts per channel minimum RMS, both channels driven, at 6 Ω from 20 Hz to 20 kHz with no more than 0.03 % total harmonic distortion.(FTC)

Rated output power during SURROUND operation

- FRONT
(1kHz, 0.7% T.H.D. at 6 Ω) 100 W + 100 W
- CENTER
(1kHz, 0.7% T.H.D. at 6 Ω) 100 W
- SURROUND
(1kHz, 0.7% T.H.D. at 6 Ω) 100 W + 100 W
- Total harmonic distortion 0.004% (1 kHz, 50 W, 6 Ω)
- Frequency response (IHF'78)
CD 5 Hz ~ 80 kHz, +0.5 dB, -3 dB
- Signal to noise ratio (IHF'66)
PHONO (MM) 77 dB
CD 90 dB
- Input sensitivity / impedance
PHONO (MM) 2.5 mV / 47 kΩ
CD 200 mV / 47 kΩ
- Output level / impedance
TAPE REC 200 mV / 220 Ω
PRE OUT (CENTER, SURROUND, SUBWOOFER)
..... 1 V / 1 kΩ
- Tone control
BASS ±7 dB (at 100 Hz)
TREBLE ±7 dB (at 10 kHz)
- LOUDNESS control
VOLUME at -40dB level ... +7 dB(100 Hz), +4 dB(10 kHz)

DIGITAL AUDIO section

- Sampling frequency 32 kHz, 44.1 kHz, 48 kHz
- Input level / impedance / wave length
Optical -15 dBm ~ -21 dBm, 660 nm ±30nm
Coaxial 0.5 Vp-p / 75 Ω

VIDEO section

- VIDEO inputs / outputs
VIDEO (composite) 1 Vp-p / 75 Ω

FM tuner section

- Tuning frequency range 87.5 MHz ~ 108 MHz
- Usable sensitivity (MONO)
..... 1.6μV (75 Ω) / 15.2 dBf (75 kHz DEV., SINAD 30 dB)
- 50dB quieting sensitivity
STEREO 31.6μV (75 Ω) / 41.2 dBf
- Total harmonic distortion (1 kHz)
MONO 0.3 % (65 dBf input)
STEREO 0.6 % (65 dBf input)
- Signal to noise ratio (1 kHz, 75 kHz DEV.)
MONO 75 dB (65 dBf input)
STEREO 68 dB (65 dBf input)
- Stereo separation (1 kHz) 38 dB
- Selectivity (±400 kHz) 70 dB
- Frequency response 30 Hz ~ 15kHz,+0.5 dB, -3.0 dB

AM tuner section

- Tuning frequency range
10 kHz step 530 kHz ~ 1,700 kHz
- Usable sensitivity (30% mod., S/N 20 dB)
..... 16 μV / (600 μV/m)
- Signal to noise ratio (30 % mod. 1 mV input) 50 dB

Relay and IR IN/OUT section

- IR RECEIVER IN terminal
Maximum output current
- Operating voltage
- Output impedance
- IR OUT LCD REMOTE terminal
Maximum output current
- Operating voltage
- Output impedance

Shape of plug to be connected

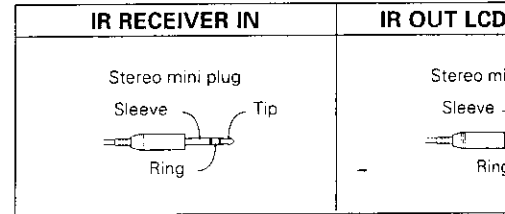

IR IN/OUT specification

Terminal	IR RECEIVER IN	IR OUT LCD
To Tip	Signal	Signal
To Ring	Ground	—
To Sleeve	+12 V	Ground

GENERAL

- Power consumption
- AC outlet
SWITCHED 2 (total 90 W)
- Dimensions W: 440 mm
H: 162 mm
D: 391 mm
- Weight (Net) 11.2 kg



1. KENWOOD follows a policy of continuous development. For this reason specifications may be changed without notice.
2. Full performance may not be exhibited in all locations (below 0 deg.C).

TV Setup Codes
Codes de configuration pour les téléviseurs
Códigos de preparación de televisores

1***
 # 1***
 # 1***

Maker Fabricants Fabricante	Setup Codes Codes de configuration Códigos de preparación
AOC	1034, 1045
Admiral	1108
Adventura	1061
Aiko	1107
Akai	1045
Alaron	1194
Ambassador	1192
Ampro	1766
Anam	1195
Anam National	1070
Audiovox	1195
Barco	1425, 1494
Belcor	1034
Bell & Howell	1031, 1169
Bradford	1195
Brockwood	1034
CXC	1195
Candle	1045, 1061, 1071 1201
Carnivale	1045
Carver	1069
Celebrity	1015
Citizen	1045, 1054, 1061, 1071, 1075, 1107, 1201, 1295
Concerto	1071
Contec	1195
Craig	1195
Crown	1054, 1195
Curtis Mathes	1045, 1054, 1075, 1169
Daewoo	1034, 1054, 1107 1466
Daytron	1034
Denon	1160
Dumont	1032, 1034
Dwin	1735, 1789
Electroband	1015
Electrohome	1396
Emerson	1034, 1054, 1169, 1192, 1193, 1194, 1195, 1251, 1295, 1297, 1478
Envision	1045
Fisher	1169, 1174

Maker Fabricants Fabricante	Setup Codes Codes de configuration Códigos de preparación
Fujitsu	1194
Funai	1194, 1195
Futuretech	1195
GE	1036, 1042, 1162, 1066, 1070, 1193, 1297, 1466
Gibraltar	1032, 1034, 1045
GoldStar	1034, 1045, 1054, 1193
Grunpy	1194, 1195
Hallmark	1193
Harvard	1195
Hitachi	1071, 1160, 1166
Infinity	1069
JBL	1069
JCB	1015
JVC	1068
Janeil	1061
KEC	1195
KTV	1045, 1054, 1195, 1295
Kenwood	1034, 1045
Kloss	1039, 1061
LXI	1062, 1069, 1169, 1171, 1193
Logik	1031
Luxman	1071
MGA	1034, 1045, 1165, 1193
MTC	1034, 1045, 1071, 1075
Magnavox	1039, 1045, 1069, 1201, 1202
Majestic	1031
Marantz	1045, 1069
Matsushita	1265
Megatron	1160, 1193
Memorex	1031, 1071, 1165 1169, 1193
Midland	1032, 1054, 1062, 1066
Minutz	1036
Mitsubishi	1034, 1108, 1165, 1193
Motorola	1070, 1108

Maker Fabricants Fabricante	Setup Codes Codes de configuration Códigos de preparación
Multitech	1195
NAD	1171, 1181, 1193
NEC	1034, 1045, 1071
NTC	1107
Nikko	1045, 1107, 1193
Noshi	1033
Onwa	1195
Optimus	1169, 1181, 1265
Optonica	1108, 1180
Orion	1251
Panasonic	1066, 1070, 1265
Penney	1033, 1034, 1036, 1042, 1045, 1054, 1062, 1066, 1075, 1171, 1193
Philco	1034, 1045, 1069
Philips	1069
Pilot	1034, 1045, 1054
Pioneer	1181
Portland	1034, 1054, 1107
Prism	1066
Proscan	1062
Porton	1046, 1193, 1481
Pulsar	1032, 1034
Quasar	1066, 1070, 1180, 1265
RCA	1033, 1034, 1062, 1105
Radio Shack	1034, 1045, 1054, 1062, 1071, 1169, 1180, 1193, 1195
Realistic	1034, 1045, 1054, 1071, 1169, 1180, 1193, 1195
Runco	1032, 1045
SSS	1034, 1195
Sampo	1045, 1054
Samsung	1034, 1045, 1054, 1071, 1075, 1193, 1442
Samsux	1054
Sansei	1466
Sanyo	1169, 1174
Scimitsu	1034

2

TV Setup codes (continued)

Codes de configuration pour les téléviseurs (suite)

Códigos de preparación de televisores (continuación)

1***

1***

1***

Maker Fabricants Fabricante	Setup Codes Codes de configuration Códigos de preparación
Scotct	1193
Scott	1034, 1193, 1194, 1195, 1251
Sears	1062, 1069, 1071, 1169, 1171, 1174, 1193, 1194
Sharp	1054, 1108, 1180, 1506
Shogun	1034
Signature	1031
Simpson	1201, 1202
Sony	1015
Soundesign	1193, 1194, 1195, 1201
Starlite	1195

Maker Fabricants Fabricante	Setup Codes Codes de configuration Códigos de preparación
Supre-Macy	1061
Supreme	1015
Sylvania	1045, 1069, 1396
TMK	1071, 1192, 1193
Tandy	1108
Tatung	1070
Technics	1066, 1265
Technol Ace	1194
Techwood	1066, 1071
Teknika	1031, 1034, 1054, 1069, 1071, 1075, 1107, 1165, 1194, 1195, 1201, 1327
Telefunken	1071
Tera	1046

Maker Fabricants Fabricante	Setup Codes Codes de configuration Códigos de preparación
Toshiba	1075, 1169, 1171
Totevision	1054
Universal	1042
Vector Research	1045
Victor	1068
Vidikron	1069
Vidtech	1034, 1193
Viking	1061, 1327
Wards	1031, 1034, 1036, 1042, 1045, 1069, 1071, 1180, 1193, 1194
Yamaha	1034, 1045
Zenith	1031, 1032

Satellite Setup codes

Codes de configuration pour les récepteurs d'émission par satellite

Códigos de preparación de satélite

2***

2***

2***

Maker Fabricants Fabricante	Setup Codes Codes de configuration Códigos de preparación
Echostar	2295
General Instrument	2376

Maker Fabricants Fabricante	Setup Codes Codes de configuration Códigos de preparación
Jerrold	2376
Primestar	2376

Maker Fabricants Fabricante	Setup Codes Codes de configuration Códigos de preparación
Realistic	2067
Uniden	2067

DSS Setup codes

Codes de configuration pour les DSS

Códigos de preparación de DDS

3***

3***

3***

Maker Fabricants Fabricante	Setup Codes Codes de configuration Códigos de preparación
Alphastar	3787
Echostar	3790
Hitachi	3834
Hughes Network System	3764

Maker Fabricants Fabricante	Setup Codes Codes de configuration Códigos de preparación
Panasonic	3716
Philips	3737, 3739
Primestar	3642

Maker Fabricants Fabricante	Setup Codes Codes de configuration Códigos de preparación
RCA	3581
Sony	3654
Toshiba	3805

VCR Setup codes
Codes de configuration pour les magnétoscopes
Códigos de preparación de videogradoras

4***

4***

4***

3

Maker Fabricants Fabricante	Setup Codes Codes de configuration Códigos de preparación
Action	4332
Admiral	4063
Adventura	4015
Aiko	4293
Aiwa	4015, 4052, 4332, 4421
Akai	4056, 4330
American Hight	4050
Asha	4255
Audiovox	4052
Beaumarck	4255
Bell & Howell	4119
Broksonic	4136, 4199, 4226, 4310, 4376
CCE	4087, 4293
Calix	4052
Canon	4050
Carver	4096
Citizen	4052, 4293
Colt	4087
Craig	4052, 4062, 4087, 4255
Curtis Mathes	4050, 4056, 4075
Cybernex	4255
Daewoo	4060, 4293
Denon	4057
Dynatech	4015
Electrohome	4052
Electrophonic	4052
Emerex	4047
Emerson	4015, 4017, 4052, 4058, 4136, 4199, 4226, 4293, 4310, 4376
Fisher	4062, 4081, 4119
Fuji	4048, 4050
Funai	4015

Maker Fabricants Fabricante	Setup Codes Codes de configuration Códigos de preparación
GE	4050, 4075
Garrard	4015
Go Video	4247, 4365
GoldStar	4052, 4053
Gradiente	4015
Hi-Q	4062
Harley Davidson	4015
Harman/Kardon	4053
Harwood	4087
Headquarter	4061
Hitachi	4056, 4057
JVC	4023, 4056, 4082
Jensen	4056
KEC	4052, 4293
KLH	4087
Kenwood	4053, 4056, 4082
Kodak	4050, 4052
LXI	4052
Lloyd's	4015
Logik	4087
MEI	4050
MGA	4058
MGN Technology	4255
MTC	4015, 4255
Magnavox	4050, 4054, 4096 4164
Magnin	4255
Marantz	4050, 4096
Marta	4052
Matsushita	4050, 4177, 4469
Memmorex	4322
Memorex	4015, 4050, 4052, 4054, 4061, 4062, 4063, 4119, 4255, 4322
Minolta	4057
Mitsubishi	4058, 4082, 4188

Maker Fabricants Fabricante	Setup Codes Codes de configuration Códigos de preparación
Motorola	4050, 4063
Multitech	4015, 4087
NEC	4053, 4056, 4082, 4119
Nikko	4052
Nikon	4049
Noblex	4255
Olympus	4050
Optimus	4052, 4063, 4119, 4117, 4469
Orion	4310
Panasonic	4050, 4177, 4469
Penney	4050, 4052, 4053, 4057, 4255
Pentax	4057
Philco	4050
Philips	4050, 4096
Pilot	4052
Pioneer	4082
Profitronic	4255
Protec	4087
Pulsar	4054
Quarter	4061
Quartz	4061
Quasar	4050, 4177, 4469
RCA	4057, 4075, 4164
Radio Shack	4015, 4052
Radix	4052
Randex	4052
Realistic	4015, 4050, 4052, 4061, 4062, 4063, 4081, 4119
Ricoh	4049
Runco	4054
STS	4057
Samsung	4060, 4255
Sanky	4054, 4063

VCR Setup codes (continued)

Codes de configuration pour les magnétoscopes (suite)

Códigos de preparación de videograbadoras (continuación)

4***

4***

4***

Maker Fabricants Fabricante	Setup Codes Codes de configuration Códigos de preparación
Sansui	4056, 4082
Sanyo	4061, 4062, 4119, 4255
Scott	4058, 4060, 4136, 4199, 4226
Sears	4050, 4052, 4057, 4061, 4062, 4081, 4119
Sharp	4063
Shintom	4087
Shogun	4255
Singer	4087

Maker Fabricants Fabricante	Setup Codes Codes de configuration Códigos de preparación
Sony	4047, 4048, 4049, 4050
Sylvania	4015, 4050, 4058, 4096
Symphonic	4015
TMK	4255
Tatung	4056
Teac	4015, 4056
Technics	4050, 4177
Teknika	4015, 4050, 4052
Toshiba	4058, 4060, 4081
Totevision	4052, 4255

Maker Fabricants Fabricante	Setup Codes Codes de configuration Códigos de preparación
Unitech	4255
Vector	4060
Vector Research	4053
Video Concepts	4060
Videosonic	4255
Wards	4015, 4050, 4057, 4062, 4063, 4075, 4087, 4096, 4164, 4255
XR-1000	4015, 4050, 4087
Yamaha	4053
Zenith	4048, 4049, 4054

LD Setup codes

Codes de configuration pour les lecteurs de LD

Códigos de preparación de reproductores de discos láser

5***

5***

5***

Maker Fabricants Fabricante	Setup Codes Codes de configuration Códigos de preparación
Carver	5209
Disco Vision	5038
Hitachi	5038
Kenwood	5273
Magnavox	5209

Maker Fabricants Fabricante	Setup Codes Codes de configuration Códigos de preparación
Marantz	5209
Mitsubishi	5074
NAD	5074
Panasonic	5219
Philips	5209

Maker Fabricants Fabricante	Setup Codes Codes de configuration Códigos de preparación
Pioneer	5038, 5074
Quasar	5219
Sega	5038
Sony	5216
Theta Digital	5029

Home Automation

Home Automation

Home Automation

6***

6***

6***

Maker Fabricants Fabricante	Setup Codes Codes de configuration Códigos de preparación
Lutron	6612
Makita	6424

Maker Fabricants Fabricante	Setup Codes Codes de configuration Códigos de preparación
One For All	6182
Security System	6182

Maker Fabricants Fabricante	Setup Codes Codes de configuration Códigos de preparación
Universal X10	6182
X10	6182

DVD Setup codes**Codes de configuration pour les lecteurs de DVD****Códigos de preparación de reproductores de videodiscos digitales**

6***

6***

6***

Maker	Setup Codes
Fabricants	Codes de configuration
Fabricante	Códigos de preparación
Kenwood	6549
Mitsubishi	6536
Panasonic	6505

Maker	Setup Codes
Fabricants	Codes de configuration
Fabricante	Códigos de preparación
Philips	6554
Pioneer	6540
RCA	6537

Maker	Setup Codes
Fabricants	Codes de configuration
Fabricante	Códigos de preparación
Sony	6548
Toshiba	6518

DAT Setup codes**Codes de configuration pour les platines DAT****Códigos de preparación de platinas de cassetes audiodigitales**

7***

7***

7***

Maker	Setup Codes
Fabricants	Codes de configuration
Fabricante	Códigos de preparación
Carver	7173
Marantz	7173

Maker	Setup Codes
Fabricants	Codes de configuration
Fabricante	Códigos de preparación
Philips	7173

Maker	Setup Codes
Fabricants	Codes de configuration
Fabricante	Códigos de preparación
Sony	7108

Casset deck Setup codes**Codes de configuration pour les platines à cassette****Códigos de preparación de platinas de cassetes**

7***

7***

7***

For Kenwood System control operation 7990

Pour la commande d'un ensemble Kenwood 7990

Para la operación de control del sistema Kenwood 7990

Maker	Setup Codes
Fabricants	Codes de configuration
Fabricante	Códigos de preparación
Aiwa	7044, 7212
Carver	7044
Denon	7091
Fisher	7089
Garrard	7323, 7324
JVC	7259, 7288, 7289
Kenwood	7086, 7198, 7249

Maker	Setup Codes
Fabricants	Codes de configuration
Fabricante	Códigos de preparación
Magnavox	7044
Marantz	7044
Onkyo	7151
Optimus	7042, 7235
Philips	7044
Pioneer	7042, 7235
Sansui	7044

Maker	Setup Codes
Fabricants	Codes de configuration
Fabricante	Códigos de preparación
Sony	7185, 7258, 7306
Teac	7323, 7324
Technics	7244
Victor	7288, 7289
Wards	7042
Yamaha	7109, 7112



CD Player Setup codes

Codes de configuration pour les lecteurs de CD

Códigos de preparación de reproductores de discos compactos

8***

8***

8***

For Kenwood System control operation 9990
 Pour la commande d'un ensemble Kenwood 9990
 Para la operación de control del sistema Kenwood 9990

Single CD / Lecteur standard 8099
 Carrousel CD / Lecteur à carrousel 8991
 200-disc changer CD / Lecteur de CD à changeur 200 disques 8992
 (Multi-room capability CD) (Lecteur de CD compatible domotique) (Reproducteur de discos compactos con capacidad para multiples habitaciones)

Disco compacto sencillo 8099
 Disco compacto de carrusel 8991
 Cambiador de 200 discos compactos 8992
 (Reproductor de discos compactos con capacidad para multiples habitaciones)

Maker	Setup Codes
Fabricants	Codes de configuration
Fabricante	Códigos de preparación
Aiwa	8139, 8172
California Audio Lab	8044
Carver	8172, 8194
DKK	8015
Denon	8018
Emerson	8320
Fisher	8063, 8103, 8194
Garrard	8408
Genexxa	8047, 8320
Hitachi	8047
JVC	8087, 8670
Kenwood	8043, 8052, 8063 8205, 8873, 8874
Krell	8172
LXI	8320
Linn	8172

Maker	Setup Codes
Fabricants	Codes de configuration
Fabricante	Códigos de preparación
MCS	8044
Magnavox	8172, 8320
Marantz	8044, 8172
Misson	8172
NSM	8172
Onkyo	8116
Optimus	8015, 8047, 8052, 8063, 8160, 8194 8320, 8483
Panasonic	8044
Philips	8172
Pioneer	8047, 8320, 8483
Proton	8172
QED	8172
Quesar	8044
RCA	8068, 8194, 8320

Maker	Setup Codes
Fabricants	Codes de configuration
Fabricante	Códigos de preparación
Realistic	8194
Rotel	8172
SAE	8172
Sansui	8172, 8320
Sanyo	8194
Scott	8320
Sears	8320
Sharp	8052
Sony	8015, 8200, 8619, 8620
Soundesign	8160
Teac	8408
Technics	8044, 8318
Victor	8087
Wards	8172
Yamaha	8051, 8202

Misc. audio Setup codes

Codes de configuration pour divers appareils audio

Códigos de preparación de otros aparatos de audio

8***

8***

8***

Maker	Setup Codes
Fabricants	Codes de configuration
Fabricante	Códigos de preparación
Jerrold	8474, 8535

Maker	Setup Codes
Fabricants	Codes de configuration
Fabricante	Códigos de preparación
Scientific Atlanta	8475

Maker	Setup Codes
Fabricants	Codes de configuration
Fabricante	Códigos de preparación
Starcom	8474

MD Setup codes

Codes de configuration pour les MD

Códigos de preparación de reproductores de minidisques

9***

9***

9***

For Kenwood System control operation 9990
 Pour la commande d'un ensemble Kenwood 9990
 Para la operación de control del sistema Kenwood 9990

Maker	Setup Codes
Fabricants	Codes de configuration
Fabricante	Códigos de preparación
Kenwood	9841

Maker	Setup Codes
Fabricants	Codes de configuration
Fabricante	Códigos de preparación
Sony	9505

Cable Setup codes
Codes de configuration pour le câble
Códigos de preparación de televisión por cable

0***
 # 0***
 # 0***

Maker Fabricants Fabricante	Setup Codes Codes de configuration Códigos de preparación
ABC	0016, 0180, 0022, 0023, 0026, 0028, 0029, 0032
Allegro	0168
Antronix	0037
Archert	0037, 0168, 0812
Cabletenna	0037
Cableview	0037
Century	0168
Citizen	0168
Colour Voice	0040
Comtronics	0055
Contec	0034
Eastern	0017
Emerson	0812
Everquest	0030, 0055
Garrard	0168
Gemini	0030
General Instrument	0026, 0491
GoldStar	0055, 0159
Goodmind	0812
Hamlin	0024, 0035, 0049, 0274

Maker Fabricants Fabricante	Setup Codes Codes de configuration Códigos de preparación
Hitachi	0026
Hytex	0022
Jasco	0168
Jerrold	0018, 0026, 0027, 0029, 0030, 0491
Memorex	0015
Movie Time	0078, 0171
NSC	0078, 0171
Oak	0022, 0034
Optimus	0036
Panasonic	0015, 0036, 0122
Paragon	0015
Philips	0040, 0168
Pioneer	0159, 0768
Prelude	0785
Pulsur	0015
RCA	0036
Radio Shack	0030
Regal	0035, 0274
Regency	0017
Rembrandt	0026
Runco	0015
SL Marx	0055

Maker Fabricants Fabricante	Setup Codes Codes de configuration Códigos de preparación
Samsung	0055, 0159
Scientific Atlanta	0023, 0032, 0492
Signal	0030, 0055
Signature	0026
Sprucer	0036
Starcom	0018, 0030
Stargate	0030, 0055, 0785
Starquest	0030
Sylvania	0016
TV86	0078
Tandy	0273
Teleview	0055
Texscan	0016
Tocom	0027, 0028
Toshiba	0015
Tusa	0030
Unika	0037, 0168
United Artists	0022
United Cable	0018
Universal	0037, 0168
Viewstar	0078, 0273
Zenith	0015, 0540

Non-IR codes
Codes Non-IR
Códigos Non-IR

About Non-IR codes

If the required setup code is not found in the setup codes chart or the desired source component cannot be activated even when its setup code is input, try using the Non-IR code so that the component can be selected from the input selector of this unit.

After selecting the input with the input selector, operate the control key in use or the remote control unit.

Quelques mots sur les codes Non-IR

Si le code de configuration ne figure pas dans le tableau des codes de configuration, ou bien si l'appareil source ne peut pas être mise en service au moyen de son code de configuration, tentez d'utiliser un code Non-IR qui permette de sélectionner l'appareil au moyen du sélecteur d'entrée de cet appareil-ci. Après avoir choisi l'entrée au moyen du sélecteur d'entrée, agissez sur la touche de commande convenable ou sur le boîtier de télécommande.

Acerca de los códigos Non-IR

Si el código de preparación necesario no se encuentra en la gráfica de códigos de preparación o el componente fuente deseado no puede activarse aunque se introduzca su código de preparación, pruebe a utilizar el códigos Non-IR para que ese componente pueda ser seleccionado con el selector de entrada de este aparato. Después de seleccionar la entrada con el selector de entrada, utilice las teclas de control o el mando a distancia.

CD player	8998
Cassette deck	7998
LD player	5998
Phono	0998

Satellite	2998
TV	1998
VCR	4998

DVD	6998
DSS	3998
MD	9998

Setup Codes chart : **Note**
Tableau des codes de configuration : **Remarque**
Gráfico de códigos de preparación : **Nota**

Although each setup code is designed to work with a number of different models, certain codes may not work with some models. (Also, certain codes may only operate some of the functions available on a given model.)
With some models, be sure to keep the ENTER key pressed for a while.

Bien que chaque code de commande doive permettre d'accéder au réglage de plusieurs modèles, il peut se trouver des codes qui sont sans effet sur un modèle donné. (Par ailleurs, selon les modèles, certains codes peuvent ne permettre que l'emploi d'un nombre limité de fonctions.)

Dans le cas de certains modèles, il vous faut maintenir la pression sur la touche ENTER pendant quelques instants.

Aunque cada código de preparación ha sido diseñado para que funcione con un número de modelos diferentes, ciertos códigos de preparación tal vez no funcionen con algunos modelos. (Además, ciertos códigos tal vez activen sólo algunas de las funciones disponibles con ciertos modelos.)

Con algunos modelos, asegúrese de mantener pulsada la tecla ENTER durante un rato.

Free Manuals Download Website

<http://myh66.com>

<http://usermanuals.us>

<http://www.somanuals.com>

<http://www.4manuals.cc>

<http://www.manual-lib.com>

<http://www.404manual.com>

<http://www.luxmanual.com>

<http://aubethermostatmanual.com>

Golf course search by state

<http://golfingnear.com>

Email search by domain

<http://emailbydomain.com>

Auto manuals search

<http://auto.somanuals.com>

TV manuals search

<http://tv.somanuals.com>