

how to

connect and set up your

VR-4900/VR-4700
KRF-V9993D

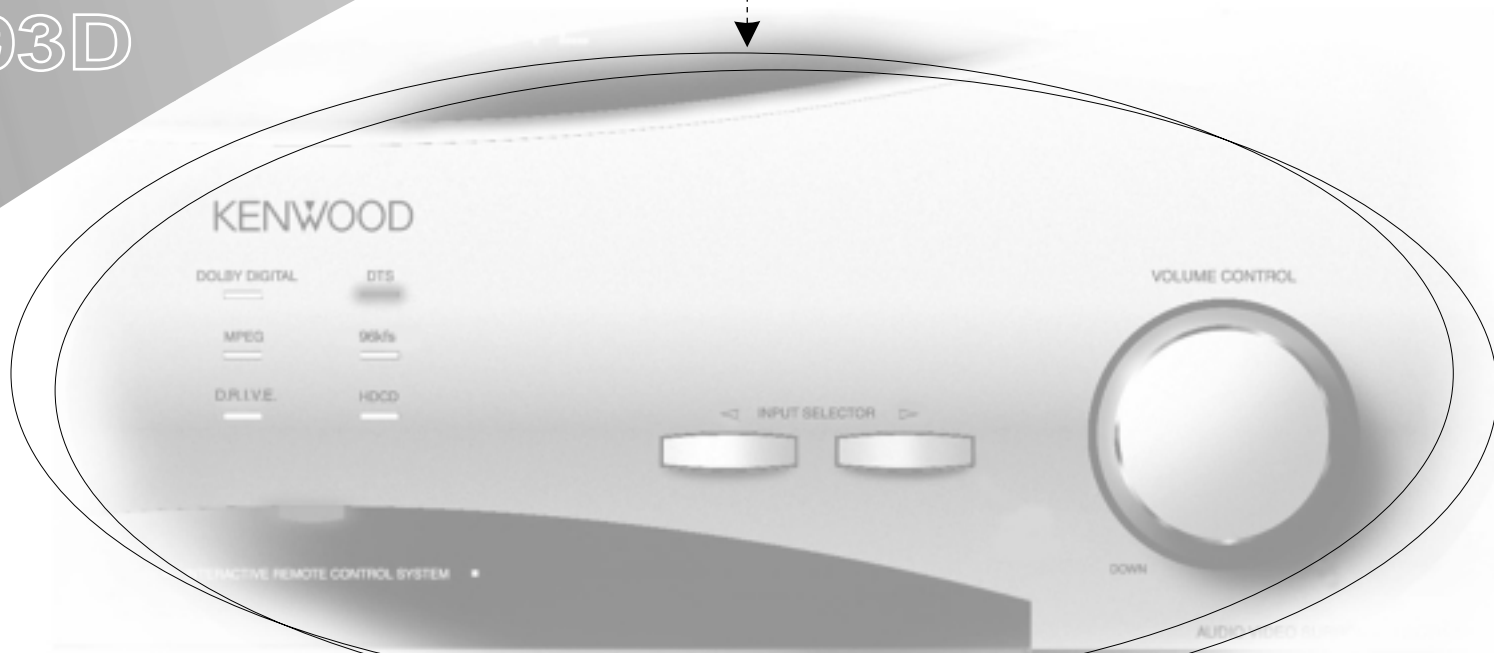

DIGITAL AUDIO/VIDEO

Receiver

This instruction manual is used to describe multiple models listed above.
Model availability and features (functions) may differ depending on the country and sales area.

KENWOOD

Connection and Setup Guide

Connecting and Setting Up Your New Kenwood Audio-Video Receiver

Welcome to the Connection and Setup Guide for your new Kenwood Audio-Video Receiver. This manual covers three models.

VR-4900 and VR-4700 are sold in USA and Canada. KRF-V9993D is sold in other countries.

The VR-4900, VR-4700 and KRF-V9993D offers 2 kinds of 5.1-channel digital decoding:

- Dolby® Digital, for the hundreds of currently available Dolby Digital DVDs and LaserDiscs.
- DTS®, a well-established multichannel format in movie theaters, is available for home theater on LaserDisc and DVD.
- MPEG 2 Audio Multichannel format

Use it to connect all your current audio and video components—the VR-4900, VR-4700 and KRF-V9993D has a variety of connection jacks so you can customize your entertainment setup.

It also includes Kenwood's remarkable PowerTouch LCD remote—a graphical user interface without having to use your TV!

Other advanced features include 5 S-Video inputs and an optical digital output for digital dubbing to MiniDisc or CD-R. For a match made in "dual-room heaven," get the CD-3280M, CD-2280M, DPF-J9010, DPF-J9020 or DPF-J9030 changer.

D.R.I.V.E. circuit: This is a KENWOOD original technology for reproducing signals with high resolution by instant switching of the internal filters according to the input signal. The VR-4900, VR-4700 and KRF-V9993D incorporate a high performance DSP to provide very high resolution from a 32-bit DRIVE III circuit, achieving stereo audio reproduction with the best quality ever reached.

HDCD®: This is a new format of high-resolution recording. The VR-4900, VR-4700 and KRF-V9993D are capable of reproducing CDs recorded in the HDCD format with high resolution and wide dynamic range.



ii



Manufactured under license from Dolby Laboratories. "Dolby", "AC-3", "Pro Logic", and the double-D symbol are trademarks of Dolby Laboratories. Confidential Unpublished Works. © 1992-1997 Dolby Laboratories. All rights reserved.



Manufactured under license from Digital Theater Systems, Inc. US Pat. No. 5,451,942 and other worldwide patents issues and pending. "DTS" and "DTS Digital Surround" are trademarks of Digital Theater Systems, Inc. © 1996 Digital Theater Systems, Inc. All rights reserved.



The above are additional trademarked names appearing in this manual. All other products named are trademarks of their respective companies.



As an ENERGY STAR® Partner, Kenwood Corporation has determined that this products meets the ENERGY STAR® guidelines for energy efficiency. This product can save energy. Saving energy reduces air pollution and lowers utility bills. (VR-4700 only)



HDCD, HDCD®, High Definition Compatible Digital® and Pacific Microsonics™ are either registered trademarks or trademarks of Pacific Microsonics, Inc. in the United States and/or other countries. HDCD system manufactured under license from Pacific Microsonics, Inc. This product is covered by one or more of the following: IN the USA: 5,479,168, 5,638,074, 5,640,161, 5,808,574, 5,838,274, 5,854,600, 5,864,311, 5,872,531, and in Australia: 669114. Other patents pending.

Before Applying Power

Read this section carefully to ensure safe operation.

VR-4900/VR-4700/KRF-V9993D is designed for operation as follows.

- U.S.A. and Canada** AC 120 V only
- Europe and United Kingdom** AC 230 V only
- Australia** AC 240 V only
- *Other countries**
..... AC 110-120/220-240 V switchable

*AC voltage selection

The AC voltage selector switch on the rear panel is set to the voltage that prevails in the area to which the unit is shipped. Before connecting the power cord to your AC outlet, make sure that the setting position of this switch matches your line voltage. If not, it must be set to your voltage in accordance with the following direction.

AC voltage selector switch

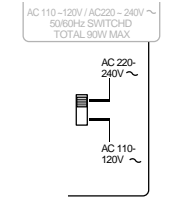

Note:

Our warranty does not cover damage caused by excessive line voltage due to improper setting of the AC voltage selector switch.





Move switch lever to match your line voltage with a small screwdriver or other pointed tool.

Safety Precautions

Read this section carefully to ensure safe operation.

WARNING :

TO PREVENT FIRE OR ELECTRIC SHOCK, DO NOT EXPOSE THIS APPLIANCE TO RAIN OR MOISTURE.

 <div style="border: 1px solid black; padding: 5px; text-align: center;"> CAUTION <small>RISK OF ELECTRIC SHOCK DO NOT OPEN</small> </div> 	<p>CAUTION: TO REDUCE THE RISK OF ELECTRIC SHOCK, DO NOT REMOVE COVER (OR BACK). NO USER-SERVICEABLE PARTS INSIDE. REFER SERVICING TO QUALIFIED SERVICE PERSONNEL.</p>
	<p>THE LIGHTNING FLASH WITH ARROWHEAD SYMBOL, WITHIN AN EQUILATERAL TRIANGLE, IS INTENDED TO ALERT THE USER TO THE PRESENCE OF UNINSULATED "DANGEROUS VOLTAGE" WITHIN THE PRODUCT'S ENCLOSURE THAT MAY BE OF SUFFICIENT MAGNITUDE TO CONSTITUTE A RISK OF ELECTRIC SHOCK TO PERSONS.</p>
	<p>THE EXCLAMATION POINT WITHIN AN EQUILATERAL TRIANGLE IS INTENDED TO ALERT THE USER TO THE PRESENCE OF IMPORTANT OPERATING AND MAINTENANCE (SERVICING) INSTRUCTIONS IN THE LITERATURE ACCOMPANYING THE APPLIANCE.</p>

CHANNEL SPACE / DE-EMPHASIS Switch

Not present for USA, Canada and Australia

The **CHANNEL SPACE/ DE-EMPHASIS** switch on the rear panel is set to the correct setting that prevails in the area to which the unit is shipped. However, if the **CHANNEL SPACE/ DE-EMPHASIS** setting is not matched to the area where the unit is to be used; for instance, if you move from area 1 to area 2 as shown in the table to the right or vice versa, desired reception of AM/ FM broadcasts is not expected. In this case, change the **CHANNEL SPACE/ DE-EMPHASIS** setting in accordance with the area corresponding to the table. The **CHANNEL SPACE/ DE-EMPHASIS** is switched over at the same time.

Area		CHANNEL SPACE freq.	DE-EMPHASIS
1	USA, Canada, and South American Countries	FM : 100 kHz AM : 10 kHz	75 μ s
2	Other Countries	FM : 50 kHz AM : 9 kHz	50 μ s

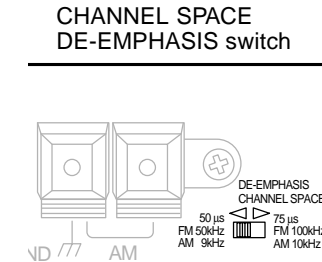

- When changing the setting of the **CHANNEL SPACE/ DE-EMPHASIS** switch, first unplug the power cord, and then reset the switch, plug the power cord back in, and turn the power switch on.

iv

Unpacking

Unpack your new receiver carefully and make sure that all the accessories are present:

Remote control unit
(PowerTouch)



Batteries
C (LR-14) × 4
(for VR-4900/VR-4700)
AA (LR-6) × 6
(for KRF-V9993D)



AM Loop Antenna

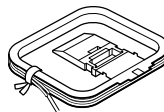

FM Antenna



RF remote Antenna
(VR-4900/VR-4700 only)



If any accessories are missing, or if the receiver is damaged or fails to operate, notify your dealer immediately. If your receiver was shipped to you directly, notify your shipper immediately. Kenwood recommends that you retain the original carton and packing materials in case you need to move or ship the receiver in the future.

Table of Contents

Chapter One : Connecting Your Devices	1	To Connect a Kenwood 200-Disc CD Changer:		Connecting Your Turntable/Record Player	28
Noting Your Devices	3	To Connect Any Other Primary CD Player or Changer:		To Connect a Turntable/Record Player:	
Connecting Your Speakers	4	To Connect a Secondary CD Player:		Connecting a Camcorder or Additional VCR	29
To Connect Front Speakers Only:		Connecting Your DVD Player	16	To Connect a Camcorder or Additional VCR:	
To Connect Front and Surround Sound Speakers:		To Connect a DVD Player:		Can I Connect an Additional VCR Permanently?	
What if I Have a Powered Subwoofer?		Connecting Your CD-R Recorder	18	What if I Have Several Kenwood Devices (System Control Chaining)?	30
What if I Have an Amplifier?		To Connect a CD-R Recorder:		System Control connection allows you to:	
Connecting Your TV	8	Connecting Your MD Recorder or Primary Tape Deck	20	Connecting the Antennas	31
To Connect a TV:		To Connect an MD Recorder:		AM Loop Antenna	V
What if I Want to Watch TV without Turning on the Receiver?		To Connect a Primary Tape Deck:		FM Indoor Antenna	
Connecting Your Cable TV or Satellite Tuner	10	To Connect a Secondary Tape Deck:		FM Outdoor Antenna	
To Connect a Cable TV Tuner with a Composite (RCA) Video Output:		Connecting Your Secondary CD Player or Tape Deck	22	Chapter Two : Setting Up PowerTouch ..	32
To Connect a Cable TV Tuner without a Composite (RCA) Video Output:		To Connect a Secondary CD Player:		Installing the Batteries	32
To Connect a Satellite Tuner:		To Connect a Secondary Tape Deck:		Calibrating the Touch Screen	33
Connecting Your VCR(s)	12	Connecting Your Laser Disc Player (with AC-3 RF Output)	24	Resetting PowerTouch	
To Connect a Primary VCR:		To Connect an AC-3 RF Output Laser Disc Player:		Selecting the Model Type	34
To Connect a Secondary VCR:		Connecting Your Laser Disc Player (without AC-3 RF Output)	26	Navigating PowerTouch Interface	34
Connecting Your Primary CD Player	14	To Connect a PCM Digital Output Laser Disc Player:		Setting Up Speakers	34
What if I Have a Video CD-Compatible CD Player?					

Table of Contents

- SP Selection
- SP Distance
- SP Level
- Surround SP Type

Identifying Devices For PowerTouch Control 37

- How Do I Identify Devices?
- What if I Connected a CD Player to the Jack Set PowerTouch Calls Tape2? (VR-4900/ KRF-V9993D only)
- How Do I Replace a Setup Code with a New One?
- How Do I Delete Setup Codes?
- What if my device does not work with any of the codes on the list?
- What if I Want PowerTouch to Control Additional Functions?

vi

Storing Radio Stations in Memory (optional) ... 40

- Storing RDS Stations Automatically (VR-4900 and KRF-V9993D)
- Storing RDS Stations Name (PS Read) (VR-4900 and KRF-V9993D)
- Storing Stations Manually

Chapter Tree : Setting Up on the Receiver 43

Chapter Four : Setting Up Multiple Rooms (except for VR-4700) 45

Making Connections 46

- Scenario 1: Surround Sound in Room A only/Stereo in Room A and Stereo in Room B (Using the Receiver's Speaker B Outputs)
- Scenario 2: Surround Sound in Room A and Stereo in Room B (Using a Stereo Amplifier in Room B)
- Both Scenarios: Connecting a Second TV/ Monitor

Setting Up the PowerTouch 47

Connecting an External Infrared Receiver and IR Repeaters 48

- To Connect a KENWOOD IR-9991 IR Receiver:
- To Connect any other IR Receiver:
- To Connect IR Repeaters:

Connecting and Setting Up On/Off Sensors or Relay Controls 50

- To Connect Relay Controls:
- To Connect TV ON/OFF Sensors:

Chapter Five : Warnings and Specifications 52

KRF-V9993D Specifications

Chapter One: Connecting Your Devices

Welcome to the Kenwood VR-4900/VR-4700/KRF-V9993D Connection and Setup Guide. This chapter guides you through connecting your home entertainment devices to your new Kenwood audio-video receiver.

Once all your devices are connected, you can set up the PowerTouch (see Chapter Two).

Refer to the following pages for details on connecting these devices:

Speakers	page 4
TV	page 8
VCR(s)	page 12
CD Player, Kenwood 200-Disc Changer	page 14
DVD Player	page 16
CD-R Recorder	page 18
MD Recorder	page 20
Tape Deck(s)	page 20
Laser Disc Player	page 24
Turntable	page 28
Camcorder/Second VCR	page 29
Antennas	page 31



All necessary cables should be provided with your home entertainment device (not with your new receiver). If you do not have the correct cables, you may purchase these cables from any home entertainment store or by visiting the Kenwood USA Web site: www.kenwoodusa.com (for USA and Canada only).

To make coaxial digital connections, be sure to use a high-quality digital audio cable, not a standard audio cable.

Do not plug in the receiver or any other device to AC power until all connections have been made. Once all devices have been connected, you may plug them in and provide power.

Important:

Your new receiver requires adequate ventilation to perform reliably. Be sure not to block the ventilation area on the top or back (or both sides) of the receiver with another device. These areas should be:

USA and Canada: at least 6 inches (15 cm) from any obstruction.

Other countries: at least top; 50cm, back; 10cm, and left and right side; 10cm.

Do not install your receiver where direct sunlight or high frequency fluorescent lighting can shine directly into the remote sensor. This can cause your new receiver to malfunction.

Before You Begin

This manual covers the most common and standard connections to the receiver. Because of its versatility, you may decide to connect your devices differently.

Before making any video connections to the your receiver :

- You can use either S-Video or standard composite (RCA) video connections.
- If all of your video devices and TV have S-Video connectors, we suggest that you use them exclusively, since it will provide superior video performance.

Before Connection:

The connection scheme in this manual shows the most typical example with a receiver. But the receiver can also be connected and used in several ways other than the example.

Before connecting any video device to the Receiver, please read carefully the following information.

Video signals

The receiver incorporates video signal separation and mixing circuitry which enables mutual conversion between the composite video and S-Video signals. It is also equipped with component video signal input/output. (VR-4900 and KRF-9993D only)

Video output at the Monitor connectors or the VIDEO connectors

The monitor connectors or the VIDEO connectors of the Receiver outputs the video signal according to the connected TV (video monitor, VCR) regardless of whether the connected video or DVD device outputs the composite video or S-Video. The component signals will be output only at the component MONITOR OUT connectors (VR-4900 and KRF-V9993D only).

- When the connected video device or TV is equipped with S-Video connectors, it is recommended to use S-Video connectors to enjoy higher video equality.
- If the video device and/or TV do not have a S-Video input connector, it is recommended only to use the (standard) video connector.

1

Mutual conversion between composite video, S-Video and component video signals is limited in the directions of arrows in the following diagram.

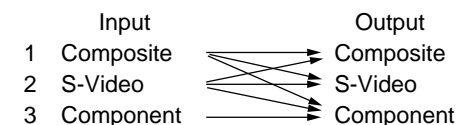

If several video connections are made, one of them will be selected based on the priority 1, 2 and 3.

- If you plan on using the VR-4900 or the KRF-V9993D in a Dual-Room application (see Chapter Four), you must use the composite video connections in addition to any S-Video connections. Only video sources connected with composite connectors can be viewed in the second room.

The following diagram shows the entire back of the VR-4900/VR-4700/KRF-V9993D.

Jacks surrounded by a solid thick line are present only on the VR-4900 and KRF-V9993D.

Note that some component jacks are linked to specific digital jacks. For example, if you connect a video component with a digital optical cable, you should connect the analog cables to the VIDEO2 video component jacks and the digital cable to the VIDEO2 digital optical jack.

Channel space/FM de-emphasis switch (only for some areas)

DE-EMPHASIS CHANNEL SPACE

50 s AM 9kHz FM 50kHz

75 s AM 10kHz FM 100kHz

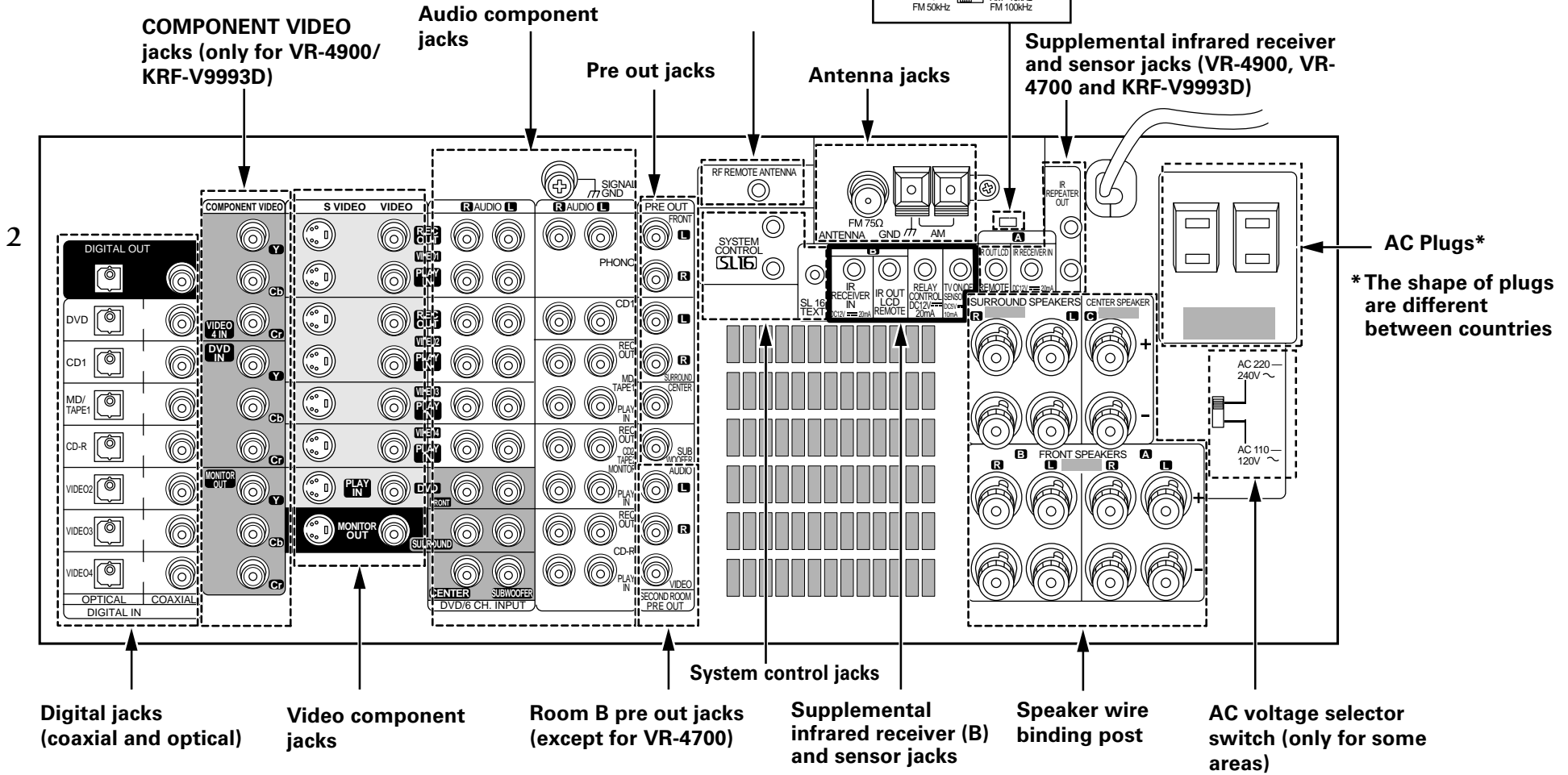

2

Digital jacks (coaxial and optical)

Video component jacks

Room B pre out jacks (except for VR-4700)

Supplemental infrared receiver (B) and sensor jacks

Speaker wire binding post

AC voltage selector switch (only for some areas)

AC Plugs*

* The shape of plugs are different between countries

Noting Your Devices

Jack Set	Device	Manufacturer	Model #	Setup Code
	PHONO			_____
	CD1			
	MD/TAPE1			
	CD2/TAPE2 MONITOR			
	CD-R			
	MONITOR OUT (TV on PowerTouch)			
	VIDEO1			
	VIDEO2			
	VIDEO3			
	VIDEO4			
	DVD			

Use this table and the diagram on the preceding page to plan your connections before you make them, or use it to record your connections as you make them.

You will need this information later, when you set up your PowerTouch (see "Identifying Devices For PowerTouch Control" on page 37). Recording this information now will save you additional trips behind your home entertainment cabinet. You will fill in the Setup Code column when you are setting up PowerTouch.

Connecting Your Speakers

4

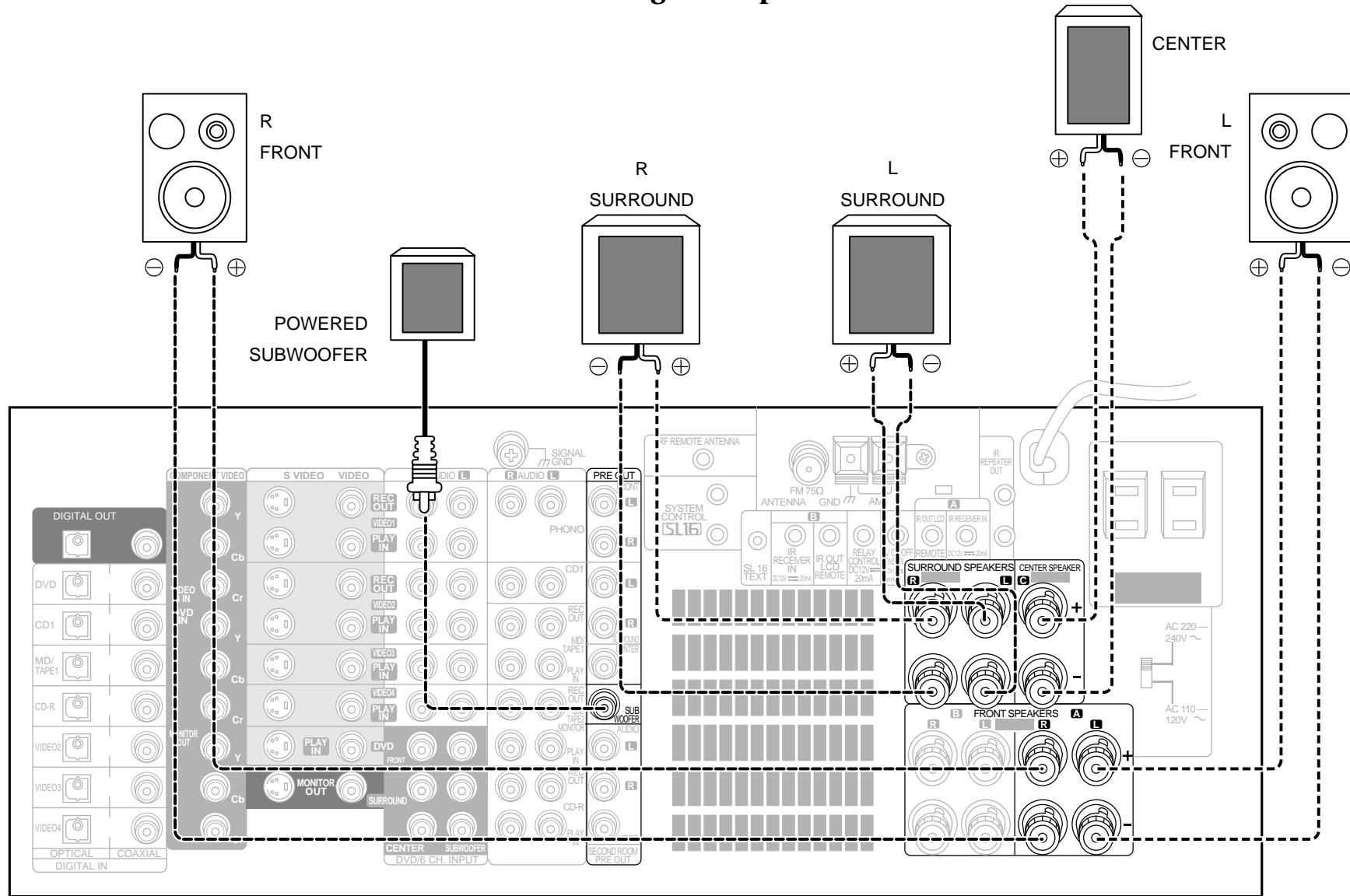

Connecting Your Speakers, continued

Do not plug in the receiver to AC power until all connections have been made.

To Connect Front Speakers Only:

If you only intend to listen to stereo sound (as opposed to surround sound), you may simply connect a single pair of speakers. To do so:

Using Banana Plugs (except for U.K.):

1. Tighten the speaker wire binding posts. If you do not tighten the posts, they will not conduct sound properly to the speakers.
2. Insert the plug from the positive jack on the **RIGHT FRONT** speaker into the pin jack on the positive **RIGHT FRONT** post. Repeat for the negative plug.
3. Repeat step 2 for the positive and negative wires on the **LEFT FRONT** speaker.

Using Bare Wires:

1. Loosen the speaker wire binding posts.
2. Insert the wire from the positive jack on the **RIGHT FRONT** speaker into the U-shaped slot in the base of the positive **RIGHT FRONT** post. Lay the wire to the right of the post; that way, when you tighten the binding post, it will naturally twist the wire into the best connection. Tighten the post. Repeat for the negative wire on the **RIGHT FRONT** speaker as shown to the right.
3. Repeat step 2 for the positive and negative wires on the **LEFT FRONT** speaker.

To Connect Front and Surround Sound Speakers:

To listen to the full surround sound that this receiver can put out, connect front speakers, center, left surround, and right surround speakers. To do so:

Using Banana Plugs (except for U.K.):

1. Tighten the speaker wire binding posts. If you do not tighten the posts, they will not conduct sound properly to the speakers.
2. Follow the steps under "To Connect Front Speakers Only" on this page to connect the **RIGHT** and **LEFT FRONT** speakers.
3. Insert the plug from the positive jack on the **CENTER** speaker into the pin jack on the positive **CENTER** post. Repeat for the negative plug.
4. Insert the plug from the positive jack on the **RIGHT SURROUND** speaker into the pin jack on the positive **RIGHT SURROUND** post. Repeat for the negative plug.
5. Repeat step 4 for the positive and negative wires on the **LEFT SURROUND** speaker.

Using Bare Wires:

1. Loosen the speaker wire binding posts.
2. Follow the steps under "To Connect Front Speakers Only" on this page to connect the **RIGHT** and **LEFT FRONT** speakers.
3. Insert the wire from the positive jack on the **CENTER** speaker into the U-shaped slot in the base of the positive **CENTER** post, as shown to the right.

Tighten the post. Repeat for the negative wire.

4. Insert the wire from the positive jack on the **RIGHT SURROUND** speaker into the U-shaped slot on the base of the positive **RIGHT SURROUND** post. Tighten the post. Repeat for the negative wire.
5. Repeat step 4 for the positive and negative wires on the **LEFT SURROUND** speaker.

What if I Have a Powered Subwoofer?

Simply connect the subwoofer's audio cable to the receiver's subwoofer **PRE OUT** jack as shown to the left.



Never short circuit the + and - speaker wires.

Do not switch the left and right speaker wires or swap the + and - wires on the binding posts.

The speakers must have a nominal impedance of between 6Ω and 16Ω (VR-4900/VR-4700) or between 4Ω and 16Ω (KRF-V9993D for Europe and U.K.).

5

Using Bare Wires



1. Loosen post



2. Insert wire

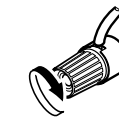

3. Tighten post

What if I Have an Amplifier?

6

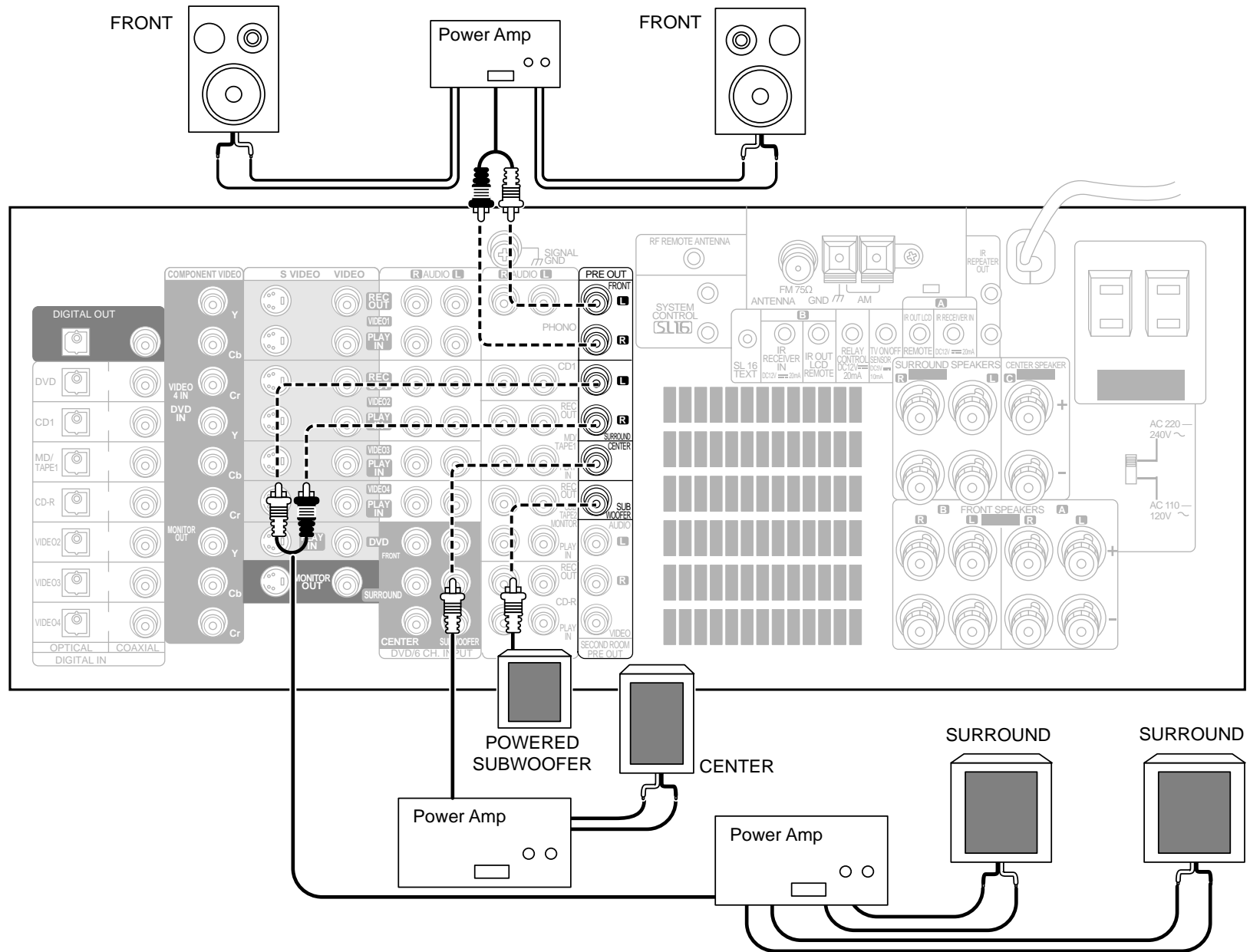

Chapter One : Connecting Your Devices

What if I Have an Amplifier?, continued

You can use supplemental power amplifiers for any of the channels instead of the receiver's built-in amplifiers.

Do not plug in the amplifiers or the receiver to AC power until all connections have been made.

To connect supplemental power amplifiers:

1. Using RCA audio cables (not supplied), connect the receiver's **PRE OUT** jacks to the amplifiers' input jacks as shown to the left.
2. Connect the speakers to the power amplifiers according to the amplifiers' instruction manuals.

Connecting Your TV

8

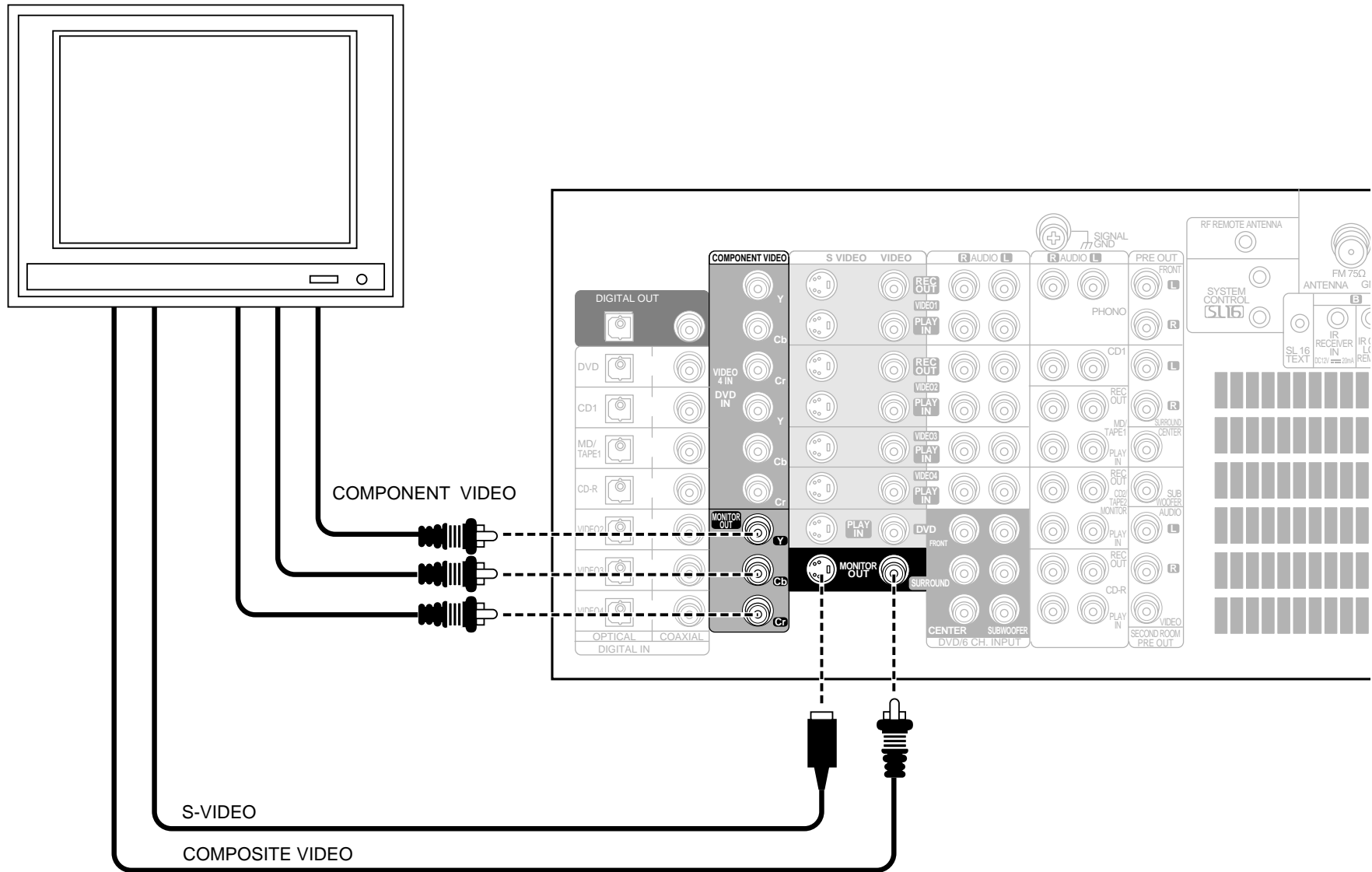



Do not plug in the receiver or devices to AC power until you have connected all your devices.

This section focuses on the connections from your TV to the VR-4900/VR-4700/KRF-V9993D. Please refer to your TV's instructions for more detail about its connection jacks and capabilities.

The instructions in this section show how to connect your TV as a monitor for the other video devices you connect (without using it as an audio/video source device itself). To use your TV as an audio/video source device, you must first connect it as described in this section, and also connect its audio/video output jacks as if they were cable TV tuner outputs, as described in "To Connect a Cable TV Tuner with a Composite (RCA) Video Output" on page 11.

Connecting Your TV, continued

To Connect a TV:

1. Review the information under "Before You Begin" on page 1. It contains important notes about the types of video connections you can make.
2. Connect a video cable from your TV's Video IN jack to the receiver's **MONITOR OUT** jack as shown to the left.
3. If your TV does not have any video input connections, you must purchase an RF modulator. The modulator will convert the video signal from the receiver to an RF signal that will work with the TV's antenna connections. Connect the receiver to the TV according to the RF modulator's instruction manual.
4. Go to "Noting Your Devices" on page 3 and note which jack you used to connect your TV. In addition, note the brand name and model number of the TV.

If you previously connected your TV directly to your VCR, you must now connect it through your new receiver.

What if I Want to Watch TV without Turning on the Receiver?

The connection described here sets your TV up as a monitor you can use to view media played on your other video devices (such as a VCR or DVD player). You can still watch TV without having to use the receiver.

Connecting Your Cable TV or Satellite Tuner

Note that video device jacks are linked to specific digital jacks. For example, if you connect a satellite tuner with a digital cable, you should connect the analog cables to the **VIDEO3** video device jacks and the digital cable to the **VIDEO3** digital jack.

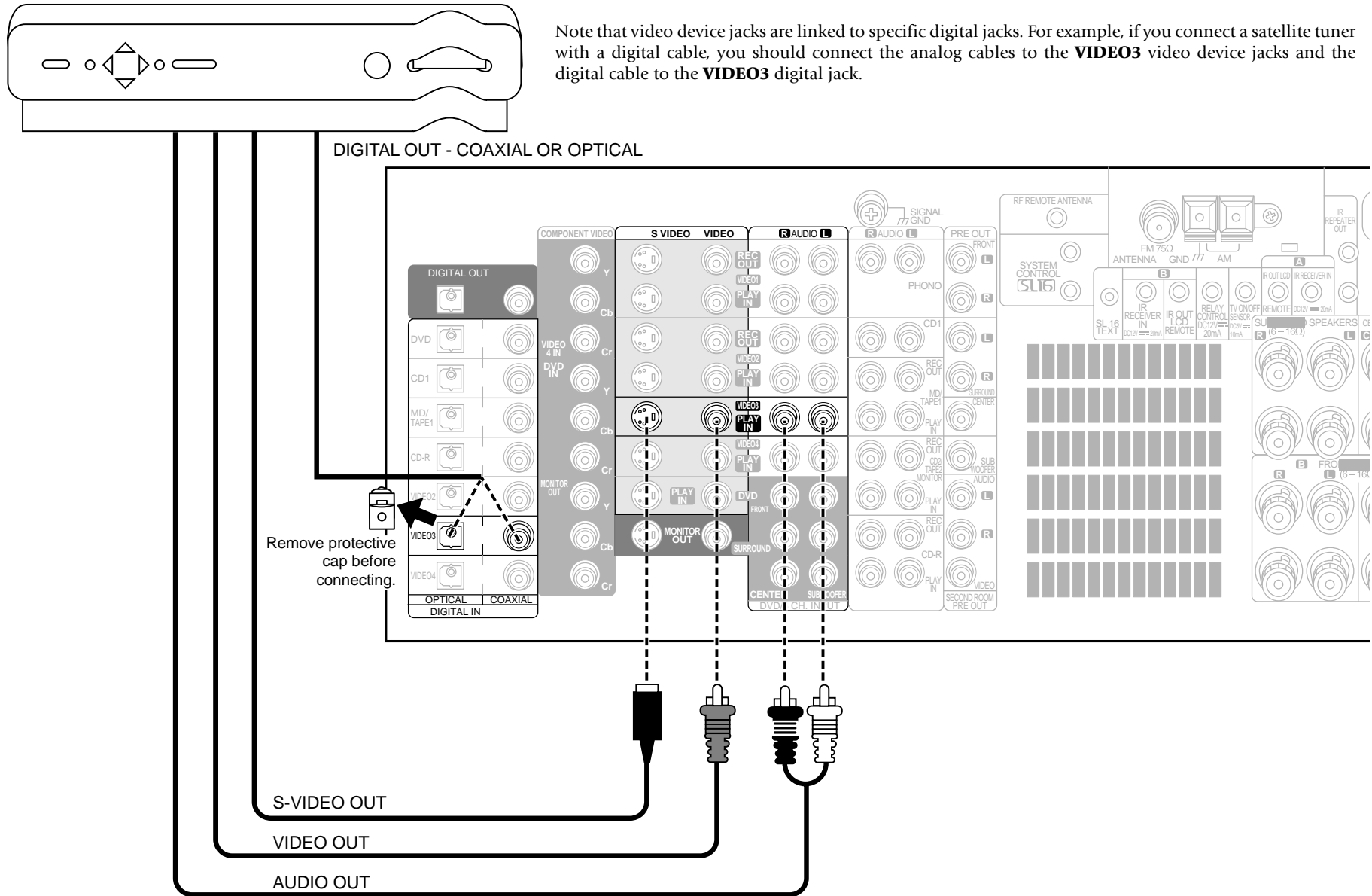

Connecting Your Cable TV or Satellite Tuner, continued

NOTES

Do not plug in the receiver or devices to AC power until you have connected all your devices.

This section focuses on the connections from your cable or satellite tuner to the VR-4900/VR-4700/KRF-V9993D. Please refer to your tuner's instructions for more detail about its connection jacks and capabilities.

The instructions in this section show one of several possible variations on connecting your tuner. For further assistance on optional configurations, contact your cable or satellite provider.

To Connect a Cable TV Tuner with a Composite (RCA) Video Output:

1. Review the information under "Before You Begin" on page 1. It contains important notes about the types of video connections you can make.
2. Connect the audio and video cables from the cable tuner's Audio and Video Out jacks to the receiver's **VIDEO2**, **VIDEO3**, or **VIDEO4 PLAY IN** jacks as shown to the left.
3. Go to "Noting Your Devices" on page 3 and note which jack you used to connect your tuner. In addition, note the brand name and model number of the tuner.

To Connect a Cable TV Tuner without a Composite (RCA) Video Output:

1. Review the information under "Before You Begin" on page 1. It contains important notes about the types of video connections you can make.
2. Connect the audio cables from the cable tuner's Audio Out jacks to the receiver's **VIDEO2**, **VIDEO3**, or **VIDEO4 PLAY IN** jacks as shown to the left.
3. Leave the cable tuner's video out (RF jack) connected directly to your VCR or TV (wherever you already have it connected). See "How Do I Operate Devices?" on page 29 of the *Users' Guide* for details about using this setup.
4. Go to "Noting Your Devices" on page 3 and note which jack you used to connect your tuner. In addition, note the brand name and model number of the tuner.

To Connect a Satellite Tuner:

1. Review the information under "Before You Begin" on page 1. It contains important notes about the types of video connections you can make.
2. If your satellite tuner has a digital output jack, connect a digital (coaxial or optical) cable between the satellite tuner's digital output jack and the receiver's **VIDEO2**, **VIDEO3** or **VIDEO4** digital input jack as shown in the figure on the left.

Note that the jack sets are linked, even though they are not adjacent. You **must** connect all of the cables from your satellite receiver to a linked jack set. For example, if you connect the analog cables to **VIDEO2** and the digital optical cable to **VIDEO3**, your satellite receiver will not work correctly.

3. Connect the audio and video cables from the satellite tuner's Audio and Video Out jacks to the receiver's **VIDEO2**, **VIDEO3**, or **VIDEO4 PLAY IN** jacks as shown to the left.
4. Go to "Noting Your Devices" on page 3 and note which jack you used to connect your tuner. In addition, note the brand name and model number of the tuner.

Connecting Your VCR(s)

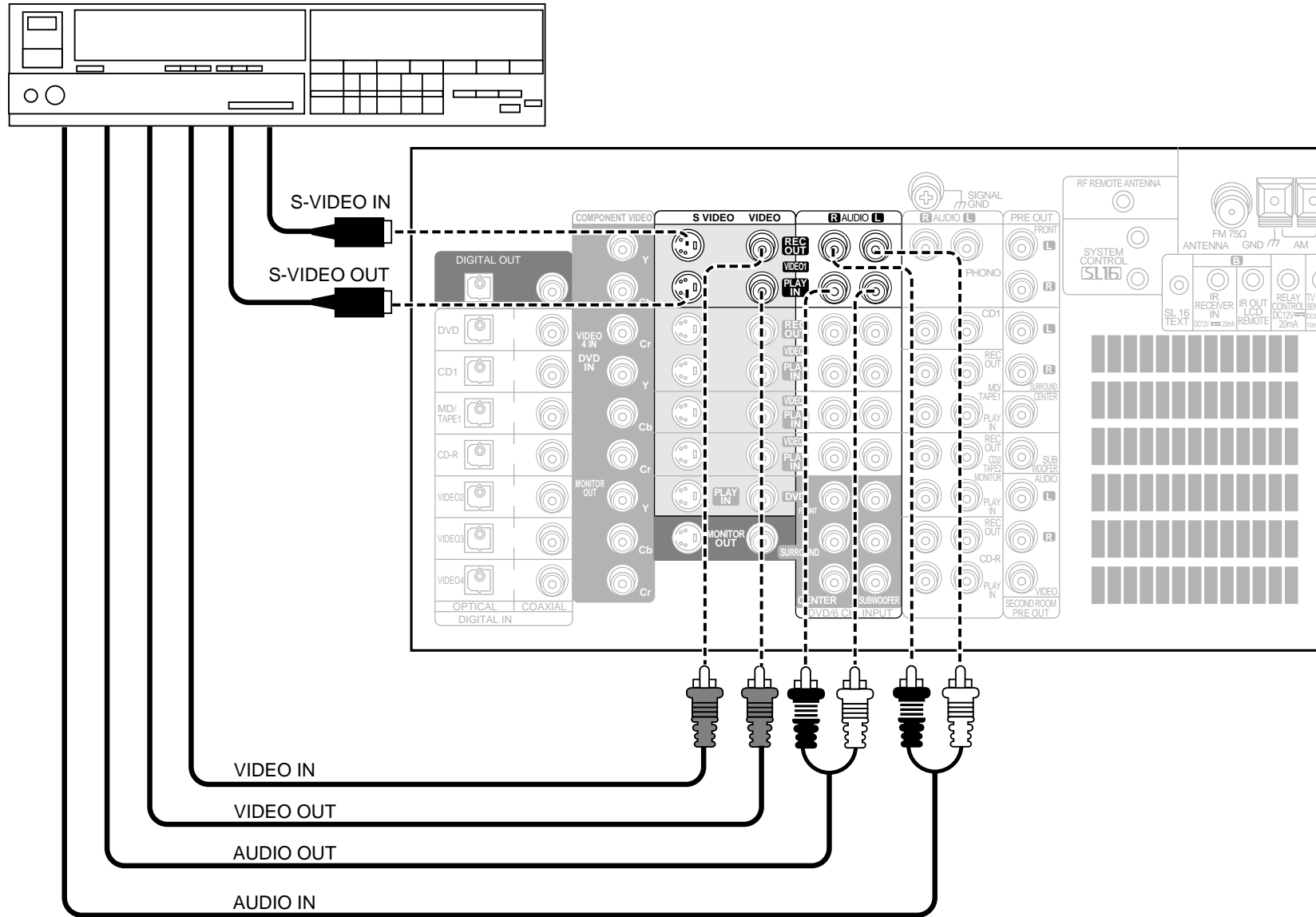

NOTES

Do not plug in the receiver to AC power until you have connected all your devices.

This section focuses on the connections from your VCR to the VR-4900/VR-4700/KRF-V9993D. Please refer to your VCR's instructions for more detail about its connection jacks and capabilities.

The instructions in this section show one of several possible variations on connecting your VCR. For further assistance on optional configurations, contact the store where you purchased your receiver.

Connecting Your VCR(s), continued

To Connect a Primary VCR:

1. Review the information under "Before You Begin" on page 1. It contains important notes about the types of video connections you can make.
2. Connect the audio and video cables from the VCR's Audio and Video jacks to the receiver's **VIDEO1 REC OUT** and **PLAY IN** jacks as shown to the left.
3. Be sure to connect the VCR **VIDEO IN** cable to the jack labeled **REC OUT** and the **VIDEO OUT** cable to the jack labeled **PLAY IN**.
4. Go to "Noting Your Devices" on page 3 and note which jack you used to connect your VCR. In addition, note the brand name and model number of the VCR.

To Connect a Secondary VCR:

1. Review the information under "Before You Begin" on page 1. It contains important notes about the types of video connections you can make.
2. Connect the audio and video cables from the VCR's Audio and Video jacks to the receiver's **VIDEO2** jacks.
3. Go to "Noting Your Devices" on page 3 and note which jack you used to connect your VCR. In addition, note the brand name and model number of the VCR.

Connecting Your Primary CD Player

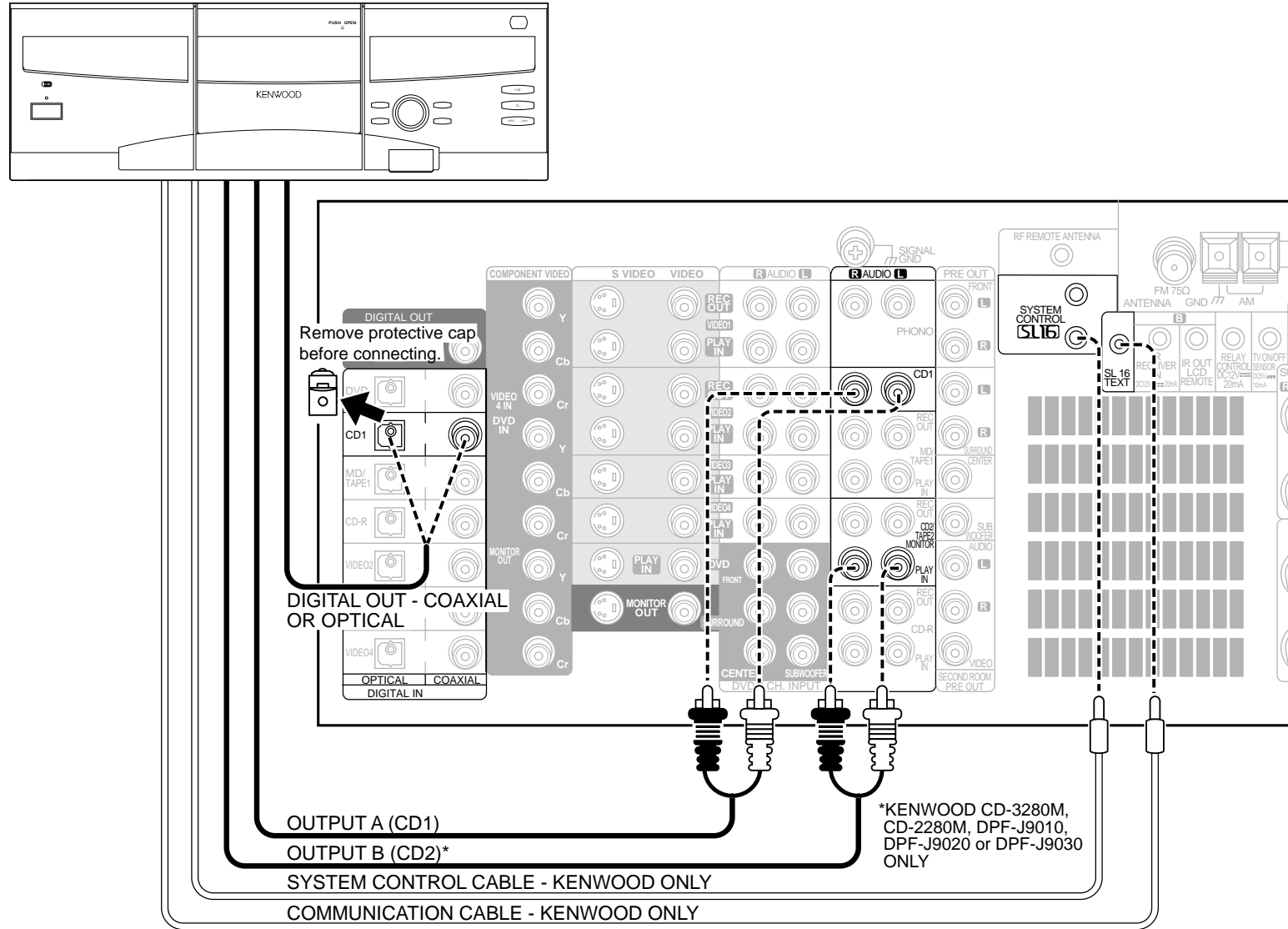

Connecting Your Primary CD Player, continued

NOTES

Do not plug in the receiver to AC power until you have connected all your devices.

This section focuses on the connections from your 200-Disc CD Changer to the VR-4900/VR-4700/KRF-V9993D. Please refer to your changer's instructions for more detail about its connection jacks and capabilities.

Each set of instructions in this section shows one of several possible variations on connecting your CD player(s). For further assistance on optional configurations, contact the store where you purchased your CD player(s).

The illustration shows a Kenwood 200-Disc CD Changer. Your CD player may look different.

The Kenwood CD-3280M, CD-2280M and DPF-J9030 / DPF-J9010 200-Disc Changers contain two CD transports. You must connect these devices as though they were two CD players. (CD-2280M and CD-3280M are sold only in USA and Canada.)

What if I Have a Video CD-Compatible CD Player?

Connect the audio and video cables from the CD player to any unused Video jack set.

Do not connect the system control cable in this instance.

To Connect a Kenwood 200-Disc CD Changer:

1. Connect one set of audio cables from the 200-Disc Changer to the receiver's CD1 jacks. If you have a CD-3280M, CD-2280M, DPF-J9010 or DPF-J9030, connect Output A to the receiver's **CD1** jacks and Output B to the receiver's **CD2/TAPE2 MONITOR PLAY IN** jacks as shown to the left.
2. Connect the digital cable from the changer to the receiver's **CD1** digital jack as shown to the left.
3. Connect the system control cable from the changer to the **SYSTEM CONTROL** jack as shown to the left.

Be sure that the SL16/XS8 switch on the changer is set to SL16.

If you are connecting more than one Kenwood device with a system control cable, see "What if I Have Several Kenwood Devices (System Control Chaining)?" on page 30 for more information.

4. Connect the SL16 text cable (communication cable) from the changer to the receiver's SL16 TEXT jack as shown to the left.
5. Go to "Noting Your Devices" on page 3 and note which jacks you used to connect your CD changer. In addition, note the brand name and model number of the CD Changer.

NOTES

See "What if I Connected a CD Player to the Jack Set PowerTouch Calls Tape2?" on page 38 to configure the **CD2/TAPE2** as a CD2 input for the CD-2280M, CD-3280M, DPF-J9010 or DPF-J9030.

To Connect Any Other Primary CD Player or Changer:

1. Connect the audio cables from the CD player's audio jacks to the receiver's **CD1** jack set as shown to the left.
2. Connect the digital cable from the CD player's digital jack to the receiver's **CD1** digital jack as shown to the left.
3. If you are connecting a Kenwood CD Player with system control, connect the system control cable from the CD player to the system control jack as shown to the left.

Be sure that the SL16/XS8 switch on the player/changer is set to SL16.

If you are connecting more than one Kenwood device with a system control cable, see "What if I Have Several Kenwood Devices (System Control Chaining)?" on page 30 for more information.

4. Go to "Noting Your Devices" on page 3 and note which jacks you used to connect your CD player/changer. In addition, note the brand name and model number of the CD player or changer.

To Connect a Secondary CD Player:

See "Connecting Your Secondary CD Player or Tape Deck" on page 22.

Do not connect the system control cable in this instance.

NOTES

When playing a HDCD disc in the HDCD format (high quality mode), use the digital connection jacks.

Connecting Your DVD Player

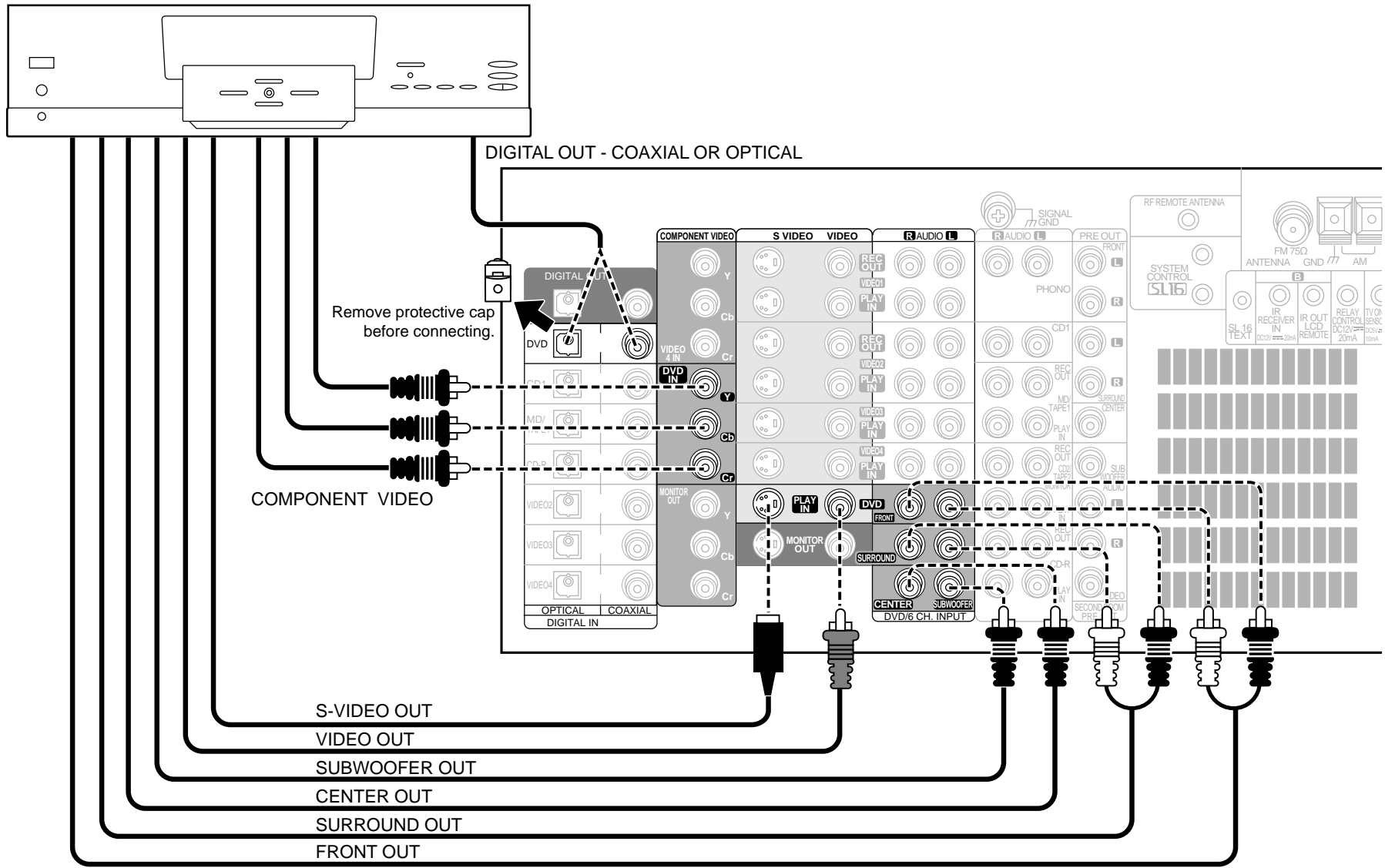

Connecting Your DVD Player, continued



Do not plug in the receiver to AC power until you have connected all your devices.

This section focuses on the connections from your DVD player to the VR-4900/VR-4700/KRF-V9993D. Please refer to your DVD player's instructions for more detail about its connection jacks and capabilities.

The instructions in this section show one of several possible variations on connecting your DVD player. For further assistance on optional configurations, contact the store where you purchased your receiver.

To Connect a DVD Player:

1. Review the information under "Before You Begin" on page 1. It contains important notes about the types of video connections you can make.
2. Connect the audio and video cables from the DVD's Audio and Video jacks to the receiver's **PLAY IN** jacks as shown to the left.

When the DVD player provides only the stereo (left, right) outputs, connect them to the receiver's **FRONT** jacks.

When the DVD player provides the DVD 6CH (DVD 5.1 CH) outputs, connect them to the **FRONT, SURROUND, CENTER** and **SUBWOOFER** input jacks.

3. Connect the digital cable (either coaxial or optical) from the DVD's digital jack to the appropriate digital jack on the receiver as shown to the left.

The illustration shows two digital connections, one for coaxial connection and one for optical connection. Your DVD player supports one or the other of these connection methods—**do not** connect both.

If you use the optical digital cable, be sure to remove the protective cover from the optical jack before connecting.

4. Go to "Noting Your Devices" on page 3 and note which jacks you used to connect your DVD player. In addition, note the brand name and model number of the DVD player.

DTS disclaimer clause

DTS Digital Surround™ is a discrete 5.1 channel digital audio format available on CD, LD, and DVD software which consequently cannot be decoded and played back inside most CD, LD, or DVD players. For this reason, when DTS-encoded software is played back through the analog outputs of the CD, LD, or DVD player, excessive noise will be exhibited. To avoid possible damage to the audio system, proper precautions should be taken by the consumer if the analog outputs are connected directly to an amplification system. To enjoy DTS Digital Surround™ playback, an external 5.1 channel DTS Digital Surround™ decoder system must be connected to the digital output (S/PDIF, AES/EBU, or TosLink) of the CD, LD or DVD player.

This unit is equipped with DTS Digital Surround™ decoder.

Connecting Your CD-R Recorder

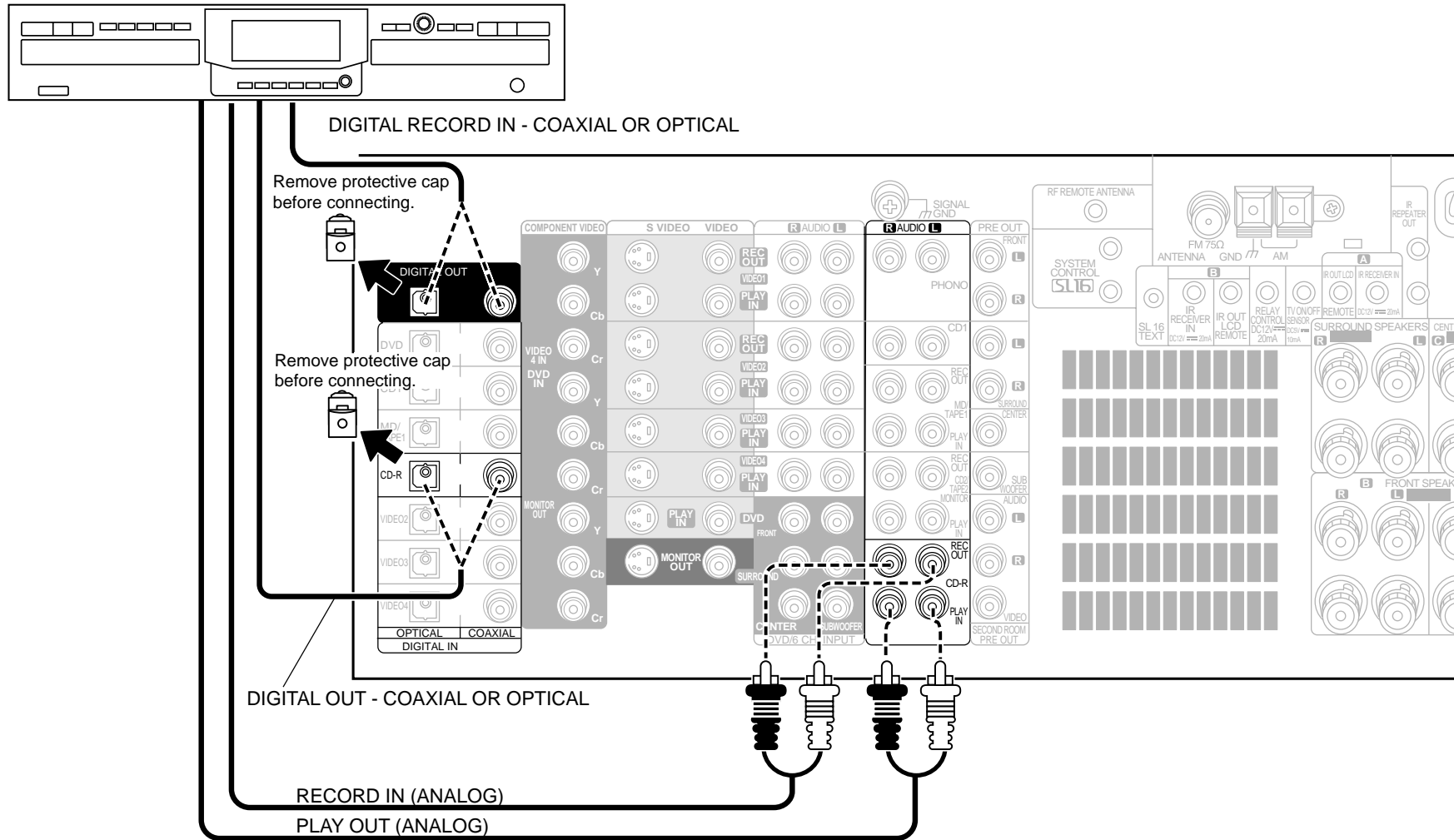

Connecting Your CD-R Recorder, continued



Do not plug in the receiver to AC power until you have connected all your devices.

This section focuses on the connections from your CD-R recorder to the VR-4900/VR-4700/KRF-V9993D. Please refer to your CD-R recorder instructions for more detail about its connection jacks and capabilities.

Each set of instructions in this section shows one of several possible variations on connecting your CD-R recorder. For further assistance on optional configurations, contact the store where you purchased your CD-R recorder.

To Connect a CD-R Recorder:

1. Connect the audio cable from the CD-R recorder's Play OUT jacks to the receiver's **CD-R PLAY IN** jacks as shown to the left.
2. Connect the audio cable from the CD-R recorder's Rec IN jacks to the receiver's **CD-R REC OUT** jacks, as shown to the left.
3. Connect the digital cable (either coaxial or optical) from the CD-R's digital jack to the appropriate digital jack on the receiver as shown to the left.

The illustration shows two digital connections, one for coaxial connection and one for optical connection. Your CD-R recorder supports one or the other of these connection methods—**do not** connect both.

If you use the optical digital cable, be sure to remove the protective cover from the optical jack before connecting.

You only need to connect to the digital out jack if you will be recording from sources that are connected to a digital in jack, such as a CD or DVD player.

4. Go to "Noting Your Devices" on page 3 and note which jacks you used to connect your CD-R recorder. In addition, note the brand name and model number of the CD-R recorder.

Connecting Your MD Recorder or Primary Tape Deck

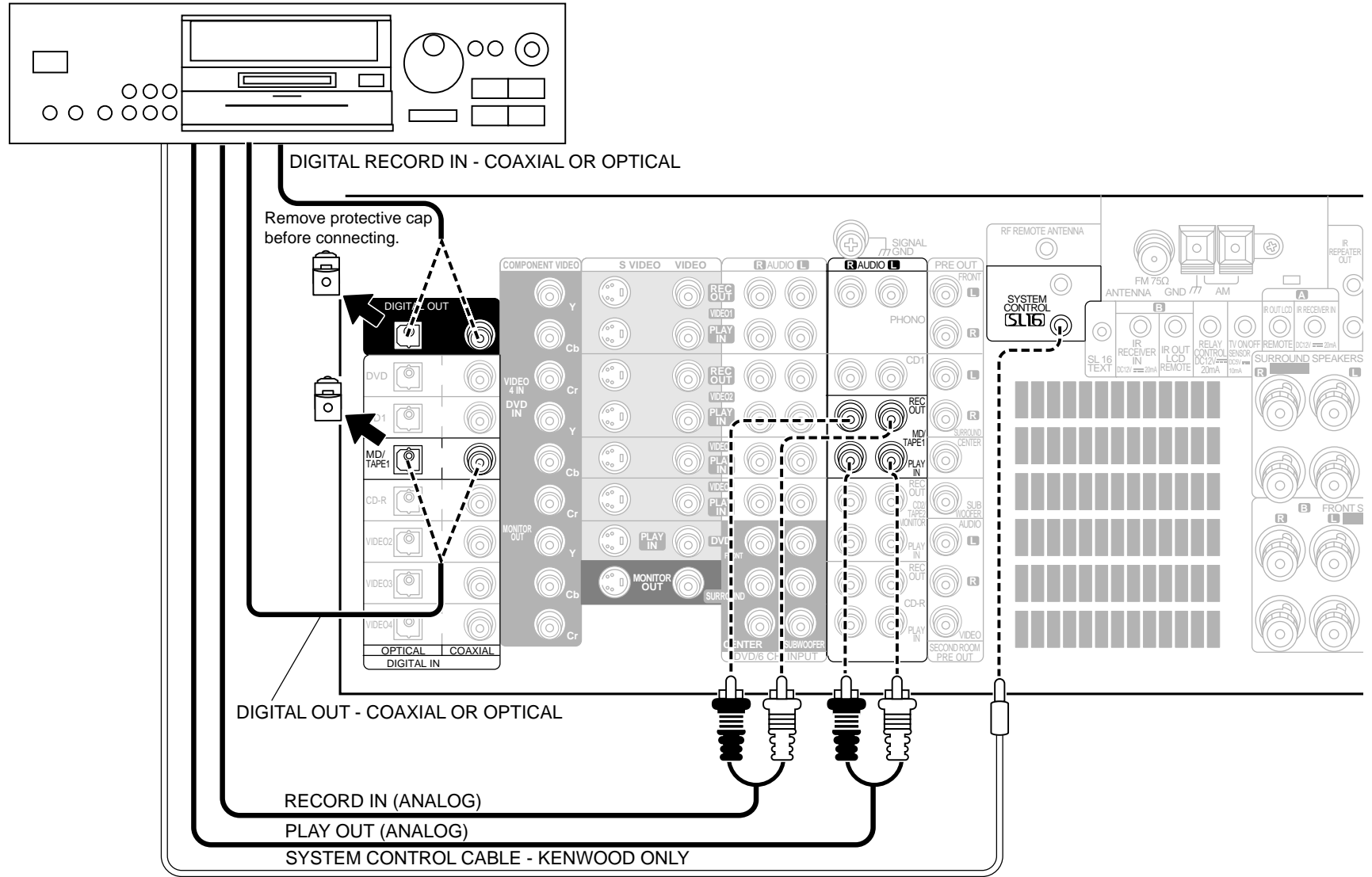

Connecting Your MD Recorder or Primary Tape Deck, continued



Do not plug in the receiver to AC power until you have connected all your devices.

This section focuses on the connections from your MD recorder or tape deck to the VR-4900/VR-4700/KRF-V9993D. Please refer to your MD recorder or tape deck's instructions for more detail about its connection jacks and capabilities.

Each set of instructions in this section shows one of several possible variations on connecting your MD recorder or tape deck. For further assistance on optional configurations, contact the store where you purchased your MD recorder or tape deck.

To Connect an MD Recorder:

1. Connect the audio cable from the MD recorder's Play OUT jacks to the receiver's **MD/TAPE1 PLAY IN** jacks as shown to the left.
2. Connect the audio cable from the MD recorder's Rec IN jacks to the receiver's **MD/TAPE1 REC OUT** jacks, as shown to the left.
3. Connect the digital cable (either coaxial or optical) from the MD's digital jack to the appropriate digital jack on the receiver as shown to the left.

The illustration shows two digital connections, one for coaxial connection and one for optical connection. Your MD recorder supports one or the other of these connection methods—**do not** connect both.

If you use the optical digital cable, be sure to remove the protective cover from the optical jack before connecting.

You only need to connect to the digital out jack if you will be recording from sources that are connected to a digital in jack, such as a CD or DVD player.

4. If you are connecting a Kenwood MD recorder, connect the system control cable from the MD recorder to the receiver.

If you are connecting more than one Kenwood device with a system control cable, see "What if I Have Several Kenwood Devices (System Control Chaining)?" on page 30.

5. Go to "Noting Your Devices" on page 3 and note which jacks you used to connect your MD recorder. In addition, note the brand name and model number of the MD recorder.

To Connect a Primary Tape Deck:

1. Connect the audio cable from the tape deck's Play OUT jacks to the receiver's MD/TAPE1 PLAY IN jacks as shown to the left.
2. Connect the audio cable from the tape deck's Rec IN jacks to the receiver's **MD/TAPE1 REC OUT** jacks as shown to the left.
3. If you are connecting a Kenwood tape deck with system control, connect the system control cable from the tape deck to the receiver. Be sure that the SL16/XS8 switch on the tape deck is set to SL16.

If you are connecting more than one Kenwood device with a system control cable, see "What if I Have Several Kenwood Devices (System Control Chaining)?" on page 30.

4. Go to "Noting Your Devices" on page 3 and note which jacks you used to connect your tape deck. In addition, note the brand name and model number of the tape deck.

To Connect a Secondary Tape Deck:

See "Connecting Your Secondary CD Player or Tape Deck" on page 22.

Connecting Your Secondary CD Player or Tape Deck

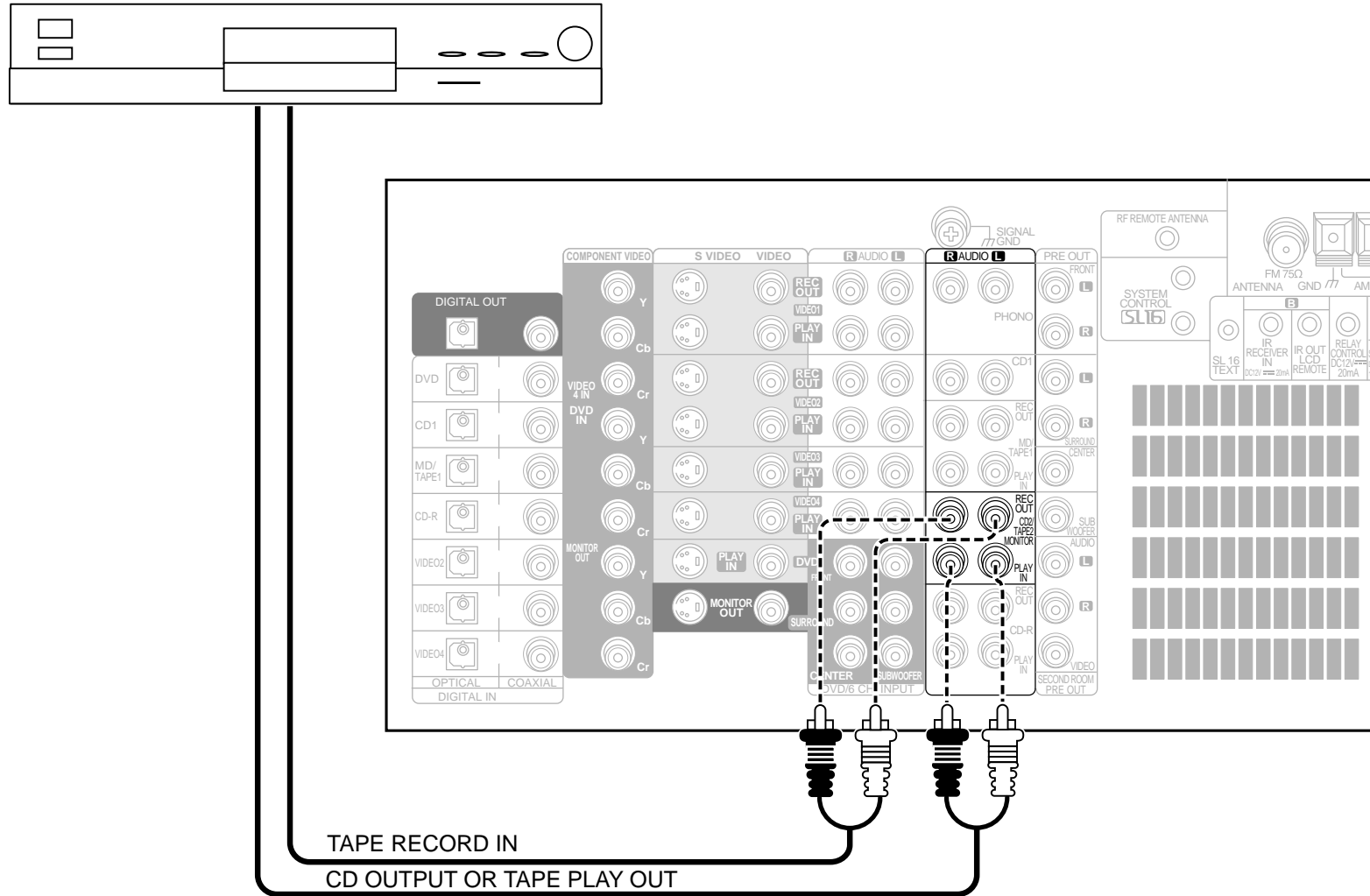

Connecting Your Secondary CD Player or Tape Deck, continued



Do not plug in the receiver to AC power until you have connected all your devices.

This section focuses on the connections from your CD player or tape deck to the VR-4900/VR-4700/KRF-V9993D. Please refer to your CD player or tape deck's instructions for more detail about its connection jacks and capabilities.

Each set of instructions in this section shows one of several possible variations on connecting your CD player or tape deck. For further assistance on optional configurations, contact the store where you purchased your CD player or tape deck.

Do not connect a system control cable from any unit connected via the **CD2/TAPE2 MONITOR** jacks.

To Connect a Secondary CD Player:

1. Connect the audio cables from the CD player's audio jacks to the receiver's **CD2/TAPE2 MONITOR PLAY IN** jack set as shown to the left.

Do not connect the system control cable from the second CD player, even if it supports system control.

2. Go to "Noting Your Devices" on page 3 and note which jacks you used to connect your CD player. In addition, note the brand name and model number of the CD player.

When you set up the PowerTouch remote to control your devices, be sure to follow the procedure under "What if I Connected a CD Player to the Jack Set PowerTouch Calls Tape2?" on page 38.

If you connect a second tape deck, you cannot connect a second CD player.

To Connect a Secondary Tape Deck:

1. Connect the audio cable from the tape deck's Play OUT jacks to the receiver's **CD2/TAPE2 MONITOR PLAY IN** jacks.
2. Connect the audio cable from the tape deck's Rec IN jacks to the receiver's **CD2/TAPE2 MONITOR REC OUT** jacks.

Do not connect the system control cable from the second tape deck, even if it supports system control.

3. Go to "Noting Your Devices" on page 3 and note which jacks you used to connect your tape deck. In addition, note the brand name and model number of the tape deck.

If you connect a second CD player, you cannot connect a second tape deck.

Connecting Your Laser Disc Player (with AC-3 RF Output)

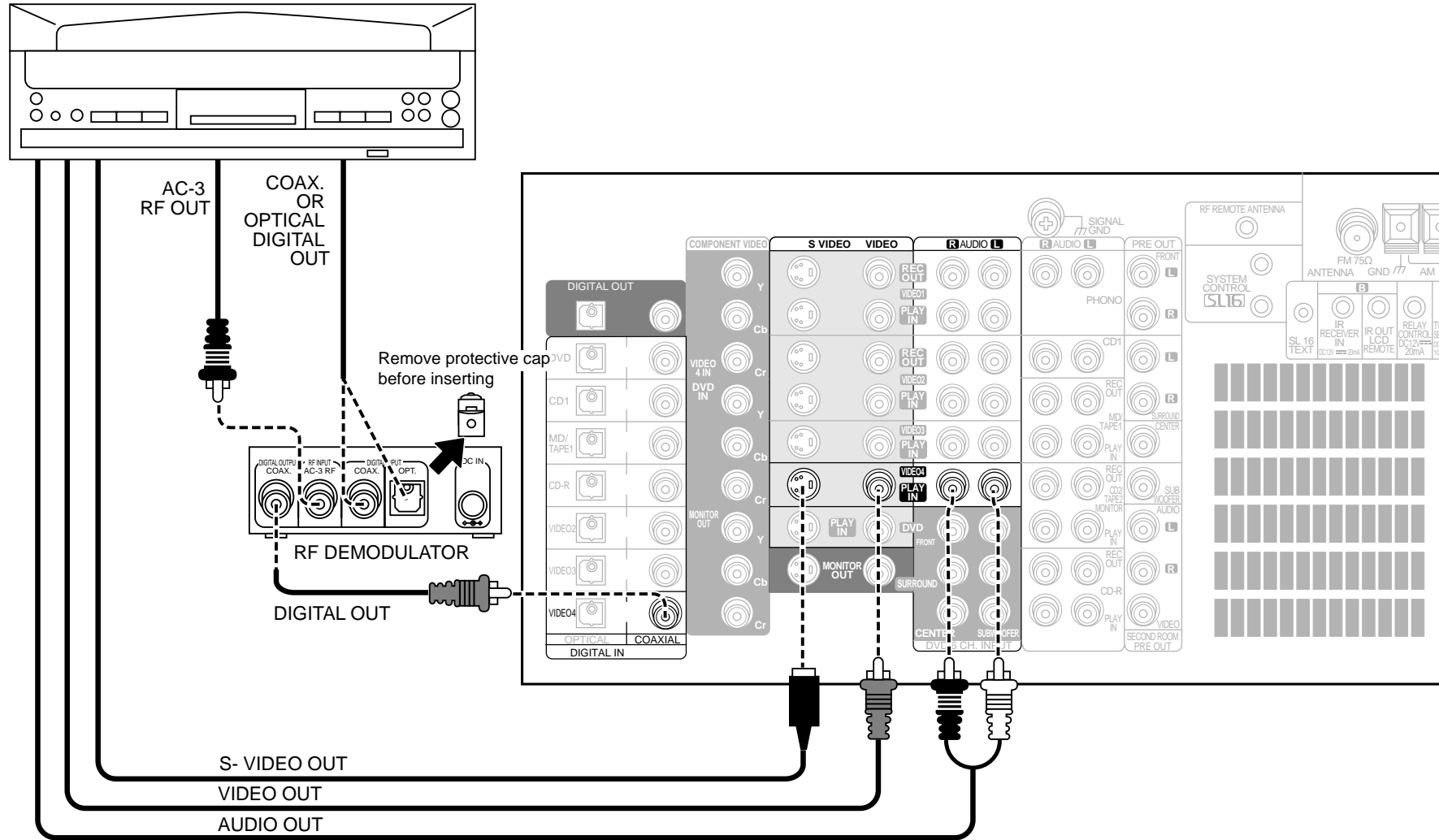

Connecting Your Laser Disc Player (with AC-3 RF Output), continued

NOTES

Do not plug in the receiver to AC power until you have connected all your devices.

You must purchase an RF Demodulator (DEM-9991D) if you plan to operate a player with a Dolby Digital (AC-3) RF Output with this receiver.

These instructions describe how to connect a laser disc player with an AC-3 RF Output. If your laser disc player does not have an AC-3 RF output, see "Connecting Your Laser Disc Player (without AC-3 RF Output)" on page 26. Please refer to your laser disc player's instructions for more detail about its connection jacks and capabilities.

The instructions in this section show one of several possible variations on connecting your laser disc player. For further assistance on optional configurations, contact the store where you purchased your receiver.

To Connect an AC-3 RF Output Laser Disc Player:

1. Review the information under "Before You Begin" on page 1. It contains important notes about the types of video connections you can make.
2. Connect the audio cables from the laser disc player's Audio OUT jacks to the receiver's AUDIO jacks (**VIDEO 4 PLAY IN**) as shown to the left.
Do not connect the digital cable (coaxial or optical) yet; it must be connected via the demodulator as described in the following steps.
3. Connect the AC-3 RF coaxial cable from the laser disc player's AC-3 RF OUT jack to the demodulator's **RF INPUT AC-3 RF** jack as shown to the left.
4. Connect the digital cable (either coaxial or optical) from the laser disc player's digital jack to the appropriate **DIGITAL INPUT** jack on the demodulator as shown to the left. Set the switch on the front of the DEM-9991D to the type of connection you made.
5. Connect the coaxial digital cable from the demodulator's **DIGITAL OUTPUT COAX** jack to the receiver's **VIDEO4 COAXIAL** jack.
6. Connect the demodulator's supplied 12V AC adapter to the DC IN jack on the demodulator. **Do not** plug the adapter into the wall until you have finished making all connections to the receiver.
7. Go to "Noting Your Devices" on page 3 and note which jacks you used to connect your laser disc player. In addition, note the brand name and model number of the laser disc player.

Connecting Your Laser Disc Player (without AC-3 RF Output)

Note that video device jacks are linked to specific digital jacks. For example, if you connect a laser disc player with a digital cable, you should connect the analog cables to the **VIDEO3** or **VIDEO4** video device jacks and the digital cable to the **VIDEO3** or **VIDEO4** digital jack.

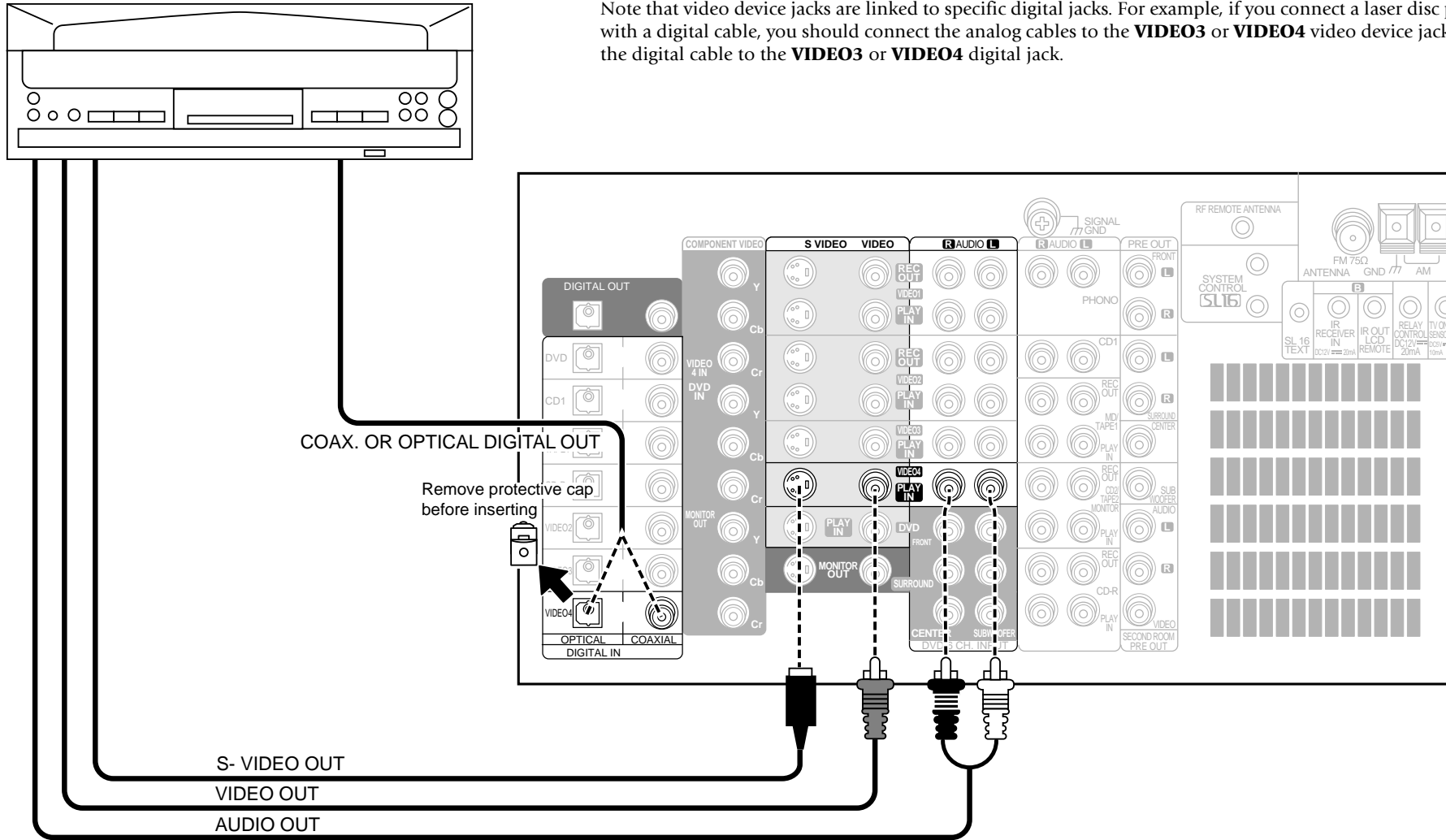

Connecting Your Laser Disc Player (without AC-3 RF Output), continued



Do not plug in the receiver to AC power until you have connected all your devices.

These instructions describe how to connect a laser disc player with a PCM Digital Output. If your player has a Dolby Digital (AC-3) RF Out, see "Connecting Your Laser Disc Player (with AC-3 RF Output)" on page 24. This configuration does not allow Dolby Digital laser discs to be played. Please refer to your laser disc player's instructions for more detail about its connection jacks and capabilities.

The instructions in this section show one of several possible variations on connecting your laser disc player. For further assistance on optional configurations, contact the store where you purchased your receiver.

To Connect a PCM Digital Output Laser Disc Player:

1. Review the information under "Before You Begin" on page 1. It contains important notes about the types of video connections you can make.
2. Connect the audio cables from the laser disc player's Audio OUT jacks to the receiver's **AUDIO** jacks as shown to the left.
3. Connect the video cable from the laser disc player's Video OUT jack to the receiver's **VIDEO PLAY IN** jack as shown to the left.

Note that the jack sets are linked, even though they are not adjacent. You **must** connect all of the cables from your laser disc player to a linked jack set. If you connect the analog cables to **VIDEO3** and the digital optical cable to **VIDEO4**, your laser disc player will not work correctly.

4. Connect the digital cable (either coaxial or optical) from the laser disc player's digital jack to the appropriate digital jack on the receiver as shown to the left. Your laser disc player supports only one of the digital connection methods—**do not** connect both.

If you use the optical digital cable, be sure to remove the protective cover from the optical jack before connecting.

5. Go to "Noting Your Devices" on page 3 and note which jacks you used to connect your laser disc player. In addition, note the brand name and model number of the laser disc player.

Connecting Your Turntable/Record Player

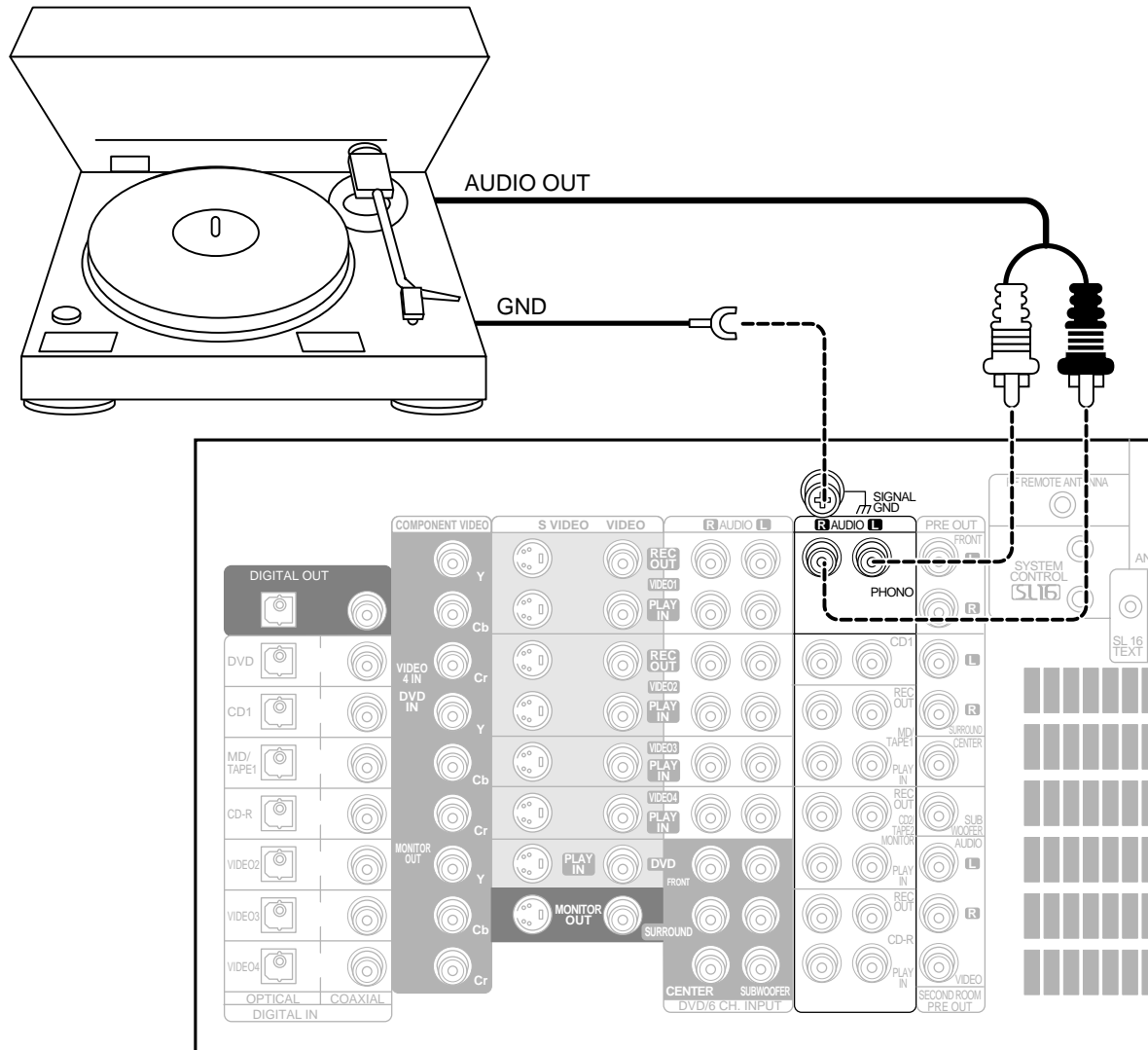

NOTES

Do not plug in the receiver to AC power until you have connected all your devices.

This section focuses on the connections from your turntable/record player to the VR-4900/VR-4700/KRF-V9993D. Please refer to your turntable/record player's instructions for more detail about its connection jacks and capabilities.

To Connect a Turntable/Record Player:

1. Connect the audio cables from the turntable audio output jacks to the receiver's **PHONO R** and **L** jacks.
2. If your turntable includes a ground cable, connect the ground cable to the receiver's **SIGNAL GND** jack.
3. Go to "Noting Your Devices" on page 3 and note which jacks you used to connect your turntable. In addition, note the brand name and model number of the turntable.

Connecting a Camcorder or Additional VCR

This section focuses on the connections from your camcorder or VCR to the front of the VR-4900/VR-4700/KRF-V9993D. Please refer to your camcorder or VCR's instructions for more detail about its connection jacks and capabilities.

These instructions describe how to connect a camcorder or VCR quickly and probably temporarily to the front of the receiver. If you want a less cluttered and more permanent connection, see "Can I Connect an Additional VCR Permanently?", below.

To Connect a Camcorder or Additional VCR:

Connect the audio and video cables from the camcorder or VCR's Audio and Video jacks to the receiver's front panel jacks as shown to the left.

Can I Connect an Additional VCR Permanently?

Yes. To do so, follow the instructions under "To Connect a Secondary VCR:" on page 13.

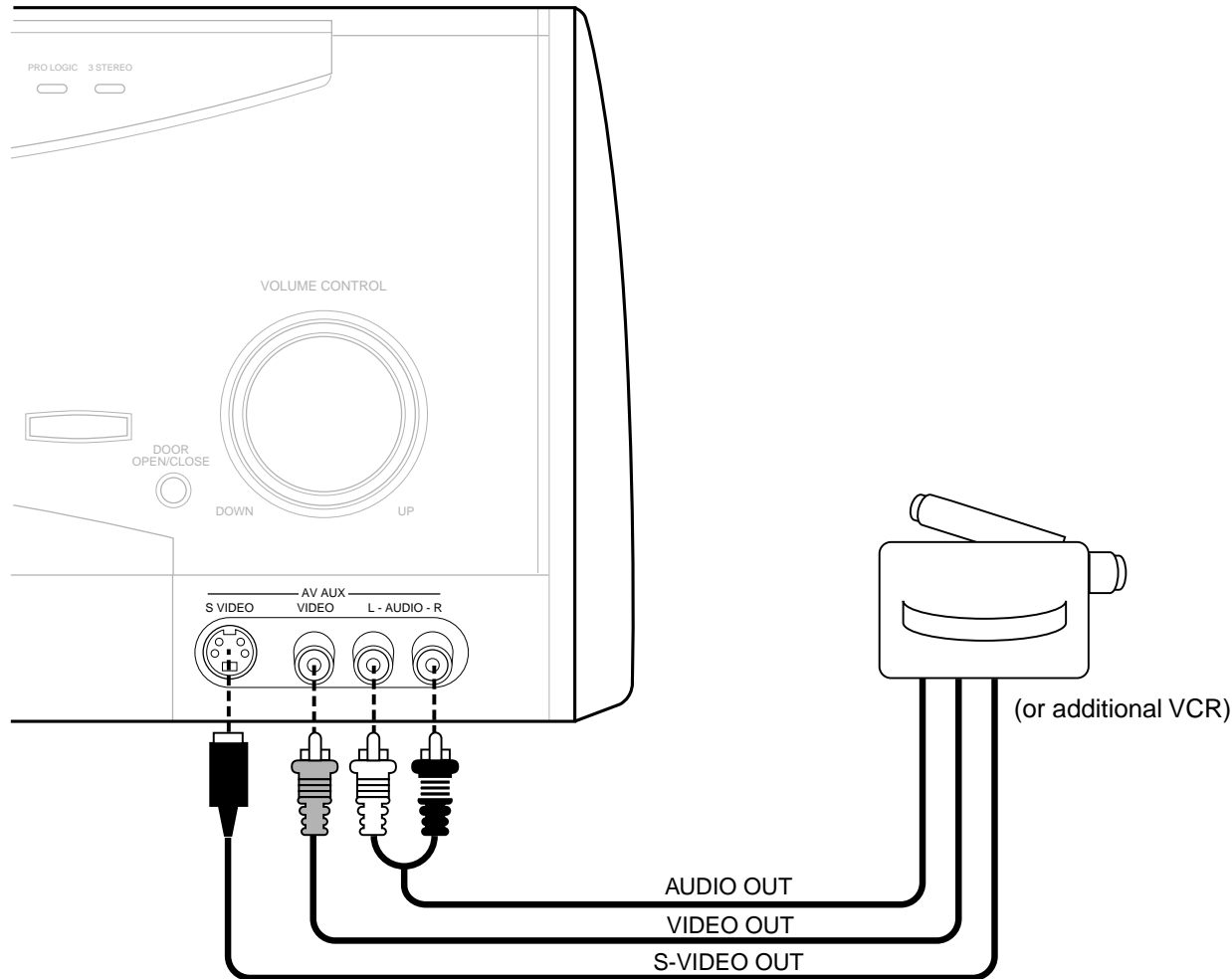

What if I Have Several Kenwood Devices (System Control Chaining)?

Connecting system control cords after connecting a KENWOOD audio component system lets you take advantage of convenient system control operations.

This unit is compatible only with the [SL16] mode. The system control operation is not available if the unit is connected in the [XS8] connection mode.

If your component has the mode select switch, set the connected components to the [SL16] mode.

- You can connect the system control cord to either system control jack of the unit.
- Do this operation after completing all connections. (Ensure that the power plug is not connected.)

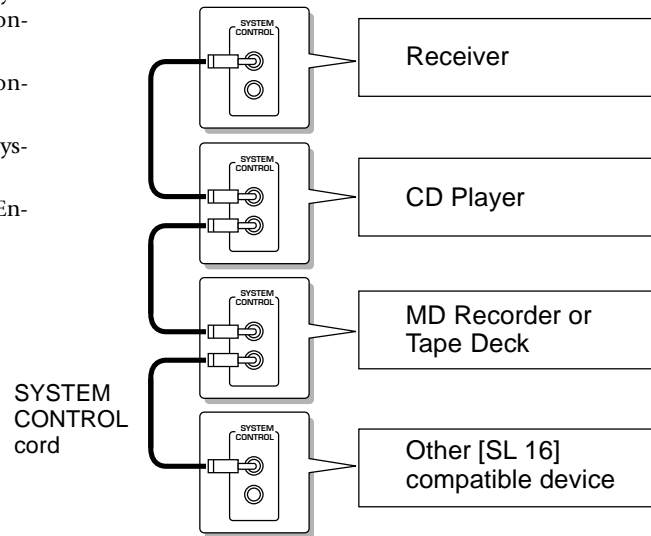

NOTES

Make sure the units are connected to the correct jacks on the receiver—for example, no device connected to the **CD2/TAPE2 MONITOR** jacks can use a system control cable.

Some CD players and cassette decks do not support the SL16 system control mode. Do not include these devices in a set of SL16 chained connections.

Do not mix connections of the two modes: if a device does not support the mode you are using for chaining, do not connect that device.

Do not connect system control cables to any device not specified by Kenwood. Using system control functions with a device that does not support them can damage the device.

Make sure system control plugs are firmly seated in the appropriate jacks.

System Control connection allows you to:

- See the current status of the selected source device, such as *Play* or *Stop*
- control connected devices via the remote
- switch the receiver's input automatically to a connected device when you start playback from that device
- synchronize recording a CD automatically when you start playback from the connected CD player

Connecting the Antennas

AM Loop Antenna

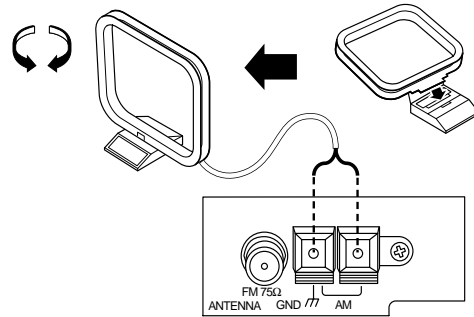

Your new receiver comes with an AM loop antenna for AM radio reception. To connect the AM antenna:

1. Insert the antenna loop into the base and position the loop.
2. Open the receiver's antenna terminal levers.
3. Insert the antenna's wires into the terminal as shown above.
4. Close the antenna terminal levers to lock the wires in place.
5. Adjust the antenna loop as necessary to improve reception.

NOTES

To prevent hum interference, keep the AM antenna wires away from speaker wires, AC power cords, the TV chassis, and the receiver.

FM Indoor Antenna

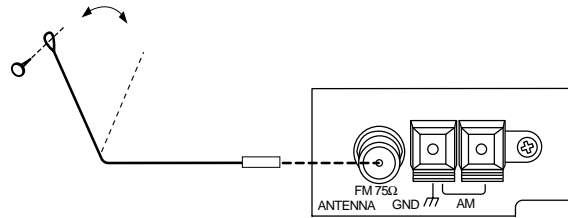

Your new receiver also comes with an FM indoor antenna for FM radio reception. To connect the FM antenna:

1. Attach the antenna sheath to the pole in the center of the receiver's FM antenna jack, as shown above. When you attach the sheath for the first time, you may need to exert quite a bit of pressure.
2. Adjust the antenna as necessary to improve reception.
3. Tack the looped end of the antenna in the location that provides the best reception.

FM Outdoor Antenna

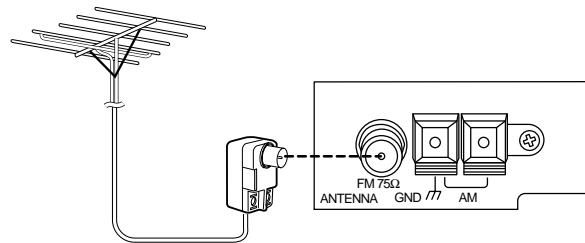

Kenwood recommends a permanently installed outdoor FM antenna for best FM reception. To connect an outdoor FM antenna:

1. Connect the antenna wire to a standard, commercially available antenna adapter as shown above.
2. Connect the adapter to the receiver's FM antenna jack.

Chapter Two: Setting Up PowerTouch

Your new PowerTouch controls your new receiver and can be set up to control most components attached to it. PowerTouch appears and functions a little differently from traditional remotes. It incorporates sophisticated engineering and design to allow you to simply touch the screen to press buttons and operate controls. You can touch the screen with your finger or with the stylus stored at the top of the PowerTouch.

Because it can control so many different devices, it presents a separate set of controls for each device on an LCD screen. Touch an icon on the screen to access further menus or controls for devices.

Only devices previously identified and connected to the receiver will appear as icons on the display screen. If you are “missing” an icon on your display screen, make sure you have identified the device to PowerTouch. This chapter describes identifying devices to PowerTouch.

This chapter contains the following sections:

Installing the Batteries	page 32
Calibrating the Touch Screen	page 33
Selecting the Model Type	page 33
Navigating PowerTouch Interface	page 34
Setting Up Speakers	page 34
Identifying Devices For PowerTouch Control	page 37
Storing Radio Stations in Memory	page 40

Installing the Batteries

Before you can set up any PowerTouch item, you need to install batteries.

- 32
- The batteries that came with your new PowerTouch are intended for you to use for an operation check—they may not last as long as ordinary batteries. We recommend replacing them with alkaline batteries for normal use.

To install the batteries:

- Press down and back on the battery cover to remove it.

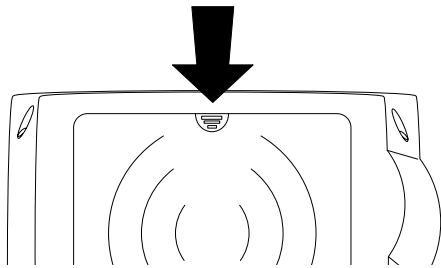

- Insert four C (LR14) batteries (for VR-4900/VR-4700) or six AA (LR6) batteries (for KRF-V9993D) as shown:

RC-R1110:
(For VR-4900/VR-4700)

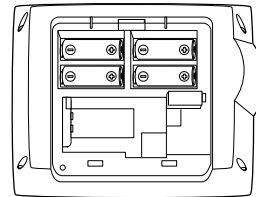

RC-R1010:
(For KRF-V9993D)

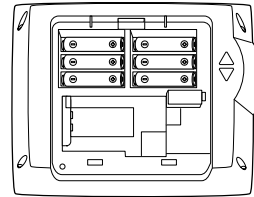

- Close the cover.

If you use PowerTouch outside of its range (see “How is PowerTouch Powered?” on page 5 of the *Users’ Guide*) PowerTouch’s display may show incorrect information.

When your batteries begin to run low, PowerTouch displays a Low Battery message. Clear the message by touching check mark icon (☑) and replace all batteries as described here.

Maximize the life of your batteries by turning the Backlight off if you are not trying to use PowerTouch in the dark. For more information on the Backlight, see the *Users’ Guide*.

If you cannot see anything on the screen after replacing batteries, try to adjust the screen contrast. See 63 page of the *Users’ Guide*.

NOTES

Under some circumstances (for example, if you plan to use multiple remotes), you can set PowerTouch up to communicate via a hardwired cable and be powered by a AC adapter/wall cube. If you choose this setup option, you should contact the store where you purchased your receiver or a qualified, competent custom installer. For more information, call 1-800-KENWOOD or visit the Kenwood Web site at <http://www.kenwoodusa.com>. (For USA and Canada only)

If you are installing the receiver in a home entertainment closet, a simpler installation option is to use the IR-9991 External Infrared Receiver. For more information, see “To Connect a KENWOOD IR-9991 IR Receiver:” on page 49.

NOTE : IR-9991 is not available as option in Europe.

Calibrating the Touch Screen

After you install the batteries or reset PowerTouch, you need to calibrate the touch screen. The touch screen responds to pressure from the included stylus or your finger:

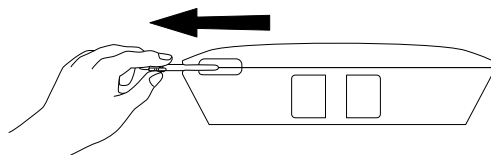

If you are replacing batteries and complete the battery replacement within 3 minutes, you do not need to calibrate the screen; calibration is stored in memory.

If the screen's performance begins to change, you can recalibrate it without resetting PowerTouch by pressing **Calib.** on the Setup Preference menu. For more information about accessing this menu, see "Identifying Devices For PowerTouch Control" on page 37.

To calibrate the touch screen, use the stylus to touch the center of each of the calibration points displayed:

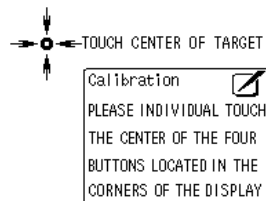

When you touch each calibration point, you should hear a beep and see the next point, indicating that area of the screen is now calibrated. If you do not hear a beep, touch the calibration point until you do.

The touch screen is sensitive to pressure, not to movement. Press firmly but gently on any touch screen element. The screen will not respond if you simply brush the stylus or your finger along the surface.

Resetting PowerTouch

If you want to reconfigure PowerTouch, you can reset it. You do not need to do this unless you experience a problem.

1. Open the cover.
2. Use the stylus to press the blue button at the bottom of the battery case:

RC-R1110:
(For VR-4900/VR-4700)

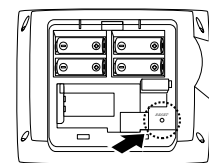

RC-R1010:
(For KRF-V9993D)

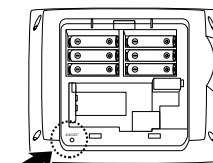

The items you set up in this chapter will remain in PowerTouch. If you want to make it to the factory-set default condition, please follow the instructions on page 98/99 of the *Users' Guide*.

Selecting the Model Type

After "Calibrating the Touch Screen", the "Selecting the Model Type" display appears automatically (Except for KRF-V9993D). (This is not displayed when the model type has already been set.)

To set the model type:

1. Press the receiver's **ON STANDBY** key to turn it **ON**.
2. Point the PowerTouch to the receiver and press the **Type** in the display.
3. The receiver automatically transmits its type code to PowerTouch. When the PowerTouch stores it, the model type selection is complete.

Now the new PowerTouch is available for operation. The "Quick Tour" is the initial display after the batteries have been loaded.

- If the model type cannot be selected automatically because the receiver is not **ON**, etc., the model type can be selected manually. In this case, refer to the table on the right and select the correct model type in step 2 above.

If you have this receiver...	Use this model type...
VR-4900	MODEL 1
VR-4700	MODEL 2
KRF-V9993D	MODEL 3

If you committed mistake in the model type selection, restart it as follows.

- While holding the **CONFIRM** and **VOLUME DOWN** keys together, press and release the RESET button under the battery cover (see above diagram). Do not release the **CONFIRM** and **VOLUME DOWN** keys until a short beep indicating the completion of setting is heard. After the above, all settings are reset to the factory settings.

Navigating PowerTouch Interface

The PowerTouch has four basic menus as shown below.

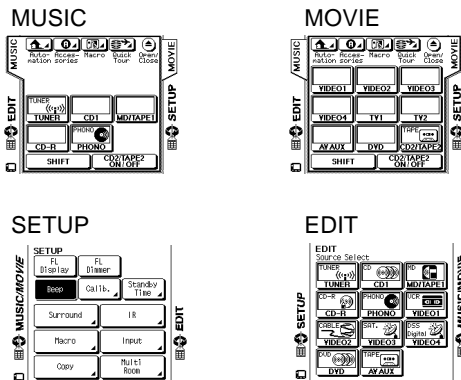

34 Some icons may not be displayed with certain models. There are two ways for moving across these four basic menus:

- Touch character or icon "MUSIC", "MOVIE", "SETUP" or "EDIT" in the screen using a stylus or your finger.
- Touch the desired icon in the quick access menu on the left of the touch-screen.

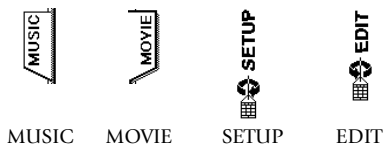



Quick access menu

For the rest of this chapter, you will be using the various settings on the Setup menu. The Setup menu includes the following settings and their subsettings:

- Preference, which contains the following:
 - IR ("Identifying Devices For PowerTouch Control" on page 37)
This menu setting allows you to identify your connected devices to PowerTouch.
 - Input (VR-4900/VR-4700/KRF-V9993D Users' Guide).
 - Multi Room ("Chapter Four: Setting Up Multiple Rooms" on page 45) VR-4900/KRF-V9993D only.
This menu setting allows you to activate dual-Room control, and to select which room you want to control with PowerTouch.
 - Copy (VR-4900/VR-4700)
This menu will allow you to copy all the settings stored in your PowerTouch to a second PowerTouch. Instructions are included in separately sold PowerTouch package.
- Surround ("Setting Up Speakers" on this page)
These menu settings allow you to set up speakers and subwoofer, set the distance from your speakers to the listening area, determine speaker levels, and set the surround speaker type. The Next button on each screen takes you to the next group of settings (i.e., pressing Next at SP Selection takes you to SP Distance without having to go back to the menu).





- Macro (VR-4900/VR-4700/KRF-V9993D Users' Guide).
This menu setting allows you to create custom macros that perform several operations (such as turning a device on, changing the receiver's input, and changing a TV station) with a single touch.

Quick Tour PowerTouch includes a Quick Tour to familiarize you with the options available and how to access them. You may want to run the Quick Tour before you begin setting up devices. To start the Quick Tour, use the stylus or your finger to touch  (Quick Tour).

To stop the Quick Tour in the middle, touch the .

To change the time until the screen goes out:

In order to reduce the battery consumption, the Power Touch has been designed so that the screen goes out when there is no operation for a given time. This time can be changed.

- 1 Touch  (Setup) to call up the SETUP screen.
- 2 Touch  to call up the Standby Time setting screen.
- 3 Touch  or  to set the desired time. The time until the screen goes out can be changed to any value from 5 to 30 seconds.
- 4 Touch  to return to the original screen.

Setting Up Speakers

Before you can begin using the receiver to control your home entertainment system, you must set up PowerTouch to operate your speakers effectively. There are four areas of speaker setup:

- SP Selection
- SP Distance
- SP Level
- Surround SP Type

You can set up your speakers in the order presented here (via the Next button) or individually, selecting each option from the Surround menu.

The receiver must be on, speakers must be connected, and Speaker A on the front panel must be turned on before you can set up speakers.

Chapter Two : Setting Up PowerTouch

To begin setting up speakers:

1. Touch  (setup) on the Main menu to access the Setup menu.

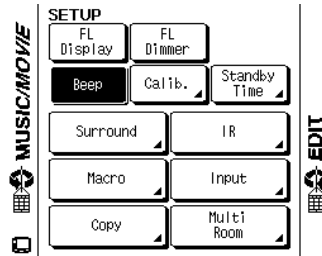

2. Touch  on the Setup settings.

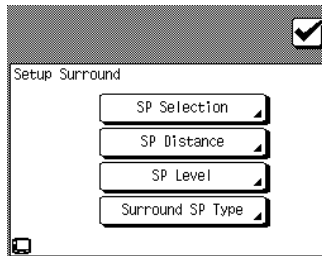

SP Selection

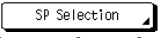

1. Touch  on the Setup Surround menu to open the Speaker Selection menu:
2. Kenwood provides two ways to set up your speakers:

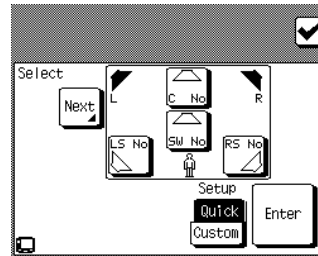
Quick Setup: Use this method for a simplified setup where you identify whether a speaker is present and let the receiver automatically determine the appropriate speaker settings.



- a. Aim PowerTouch at the receiver. If the speaker is present, touch the speaker button until "Yes" appears in the button. (SW=subwoofer, C=center, LS=left surround, and RS=right surround):

If you selected Yes for the subwoofer, all of the bass below 80Hz is removed from other speakers in your system and is sent to the subwoofer in all listening modes. This improves your speakers' power handling and reduces overall distortion.

- b. Touch  to save your settings.
- c. Touch  to move to the next speaker setting or touch  to return to the Setup Surround menu.

Custom setup: Use this method for a more customized setup where you determine more of the speaker settings, such as the bandwidth of the sound sent to each speaker. Custom setup configures the following: SW=subwoofer, L=left front, R=right front, C=Center, LS=left surround, and RS=right surround.

- a. Touch  on the Speaker Selection menu:

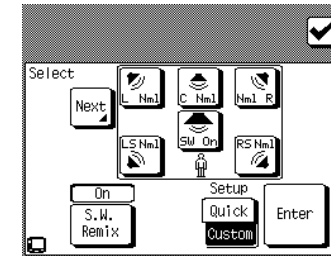

- b. Aim PowerTouch at the receiver and touch the speaker button until the correct setting appears (see below).

The left and right front buttons and the left and right surround buttons are linked; if you touch one, you change the settings for both.



- **Off** means you are not using the speaker. (Not available for front speakers). If no subwoofer is connected, all bass below 80Hz is sent to left and right front speakers.
- **On** means that you are using the speaker. (Only available for subwoofer).
- Select **Nml** (= Normal) if the speaker is not capable of producing clean, deep bass energy at output levels that match those produced by a typical powered subwoofer. All bass below 80Hz in that channel is removed from that speaker and is sent to the subwoofer (or sent to the front speakers if subwoofer is set to off) in all listening modes. Most speakers should be considered **Nml**. If no subwoofer is connected, that signal is sent to left and right front speakers.
- Select **Lrg** (= Large) if the speaker is capable of producing clean, deep bass energy at output levels that match those produced by a typical powered subwoofer. All bass below 80Hz in that channel is left in that speaker in all listening modes.

The subwoofer may not output audio depending on the setups of the input signal, speakers and listen mode.

Chapter Two : Setting Up PowerTouch

- c. If you set your left and right front speakers to **Lrg** and want to send bass to the subwoofer in all Listen modes, touch  until "On" appears above the button. All modes **SW Re-Mix** mixes some of the bass from your All the speakers back into your subwoofer.

If you set your left and right front speakers to **Nml**, **SW Re-Mix** does not function.

- d. Touch  to save your settings.
- e. Touch  to move to the next speaker setting or touch  to return to the Setup Surround menu.



36

If your front speakers are set to **Nml**, you can only set your center and surround speakers to **Nml** (or **Off**).

If you turn off the subwoofer, your front speakers are automatically set to **Lrg**. You may not set them to **Nml**.





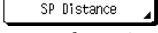

SP Distance

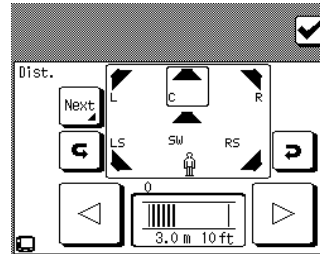
1. Measure the distance from each speaker to the seat you most often use and note it below:

Speaker	Distance (ft or m)
left front	
center	
right front	
right surround	
left surround	
subwoofer	

2. If you are not already there, touch  on the Setup Surround menu to open the Speaker Distance menu:





3. Touch  or  to set the distance for the left front speaker.
4. Touch  or  to select the next speaker.
5. Repeat steps 3 and 4 for each speaker.
6. Touch  to move to the next speaker setting or touch  to return to the Setup Surround menu.

SP Level

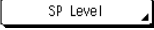

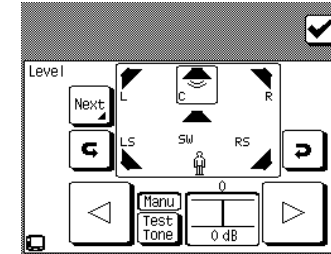

In this step you will use your ears to balance the volume level of all the system's speakers except the subwoofer for your room and listening position. (To set the subwoofer level, see "Setting the Subwoofer Level" on page 37.) When all the speakers are set at the same volume level, your system will create a more realistic, spacious surround sound environment.

1. Eliminate as many external noise sources as possible.
2. Sit in the place where you and your guests are most likely to sit while watching movies or listening to music.
3. Turn the receiver's master volume up to -25dB. (For greatest accuracy, the level-setting procedure should be performed at a moderately loud listening level.)
4. If you are not already there, touch  on the Setup Surround menu to open the Speaker Level menu:



5. Touch  until the Test Tone display reads "Manu".
6. Test noise will play from the left front speaker. Carefully listen to the volume level of the noise.



Chapter Two : Setting Up PowerTouch

7. Touch  or  to select the next speaker.
8. Carefully listen to the volume level of the test noise. If the noise is a different volume than the noise from the left front speaker, use  or  to adjust the volume so that the volume matches the volume from the left front speaker. (Do not be concerned with the volume number readout on the Level display—this is for reference purposes only. Use your ears to determine if the two speakers are playing at the same volume).
9. Repeat steps 7 and 8 until all the system's speakers (except the subwoofer) play at the same volume.
10. To confirm the volume levels, touch  until the Test Tone display reads "Auto." The test noise will automatically cycle between all of the speakers. Fine-tune the channel levels as necessary.
11. When all the channels sound like they're the same volume, you've balanced your system.

12. To turn off the test noise, touch  until the Test Tone display reads "Off."

Setting the Subwoofer Level: Because of the way humans hear, the test noise the Speaker Level menu sends through the subwoofer will not sound as loud as it really is. (The Speaker Level menu subwoofer test noise is designed to be used with a sound pressure level meter for balancing.)



Because of this, you cannot use that test noise to properly calibrate the level of your subwoofer by ear. To set the subwoofer level, listen to familiar music or films that have strong bass content and adjust the subwoofer level until it sounds balanced with the rest of the speakers.

13. Touch  to move to the next speaker setting or touch  to return to the Setup Surround menu.

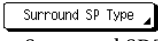
Surround SP Type

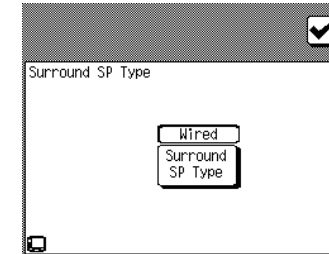
1. If you are not already there, touch  on the Setup Surround menu to open the Surround SP Type menu:





2. Touch  until the type of connection you used appears:
 - **Wired** means that you connected the speakers to the receiver via speaker wire as described in Chapter One.
 - **Wireless** is the setting for using wireless speakers. When it is set, the delay between signals will be corrected.
3. Touch  to return to the Setup Surround menu.
4. Touch  to return to the Setup menu. Touch it again to return to the Main menu. You are now finished setting up the speakers.

Identifying Devices For PowerTouch Control

Once your speakers are set up and configured, you must identify your component devices to PowerTouch. PowerTouch can be set up to control any device: if the device code is not already part of PowerTouch's extensive library, you can use the Learn feature to teach the device's

commands to PowerTouch. You can also use this Learn function to expand the control capabilities of existing codes. For more information, see "What if my device does not work with any of the codes on the list? What if I Want PowerTouch to Control Additional Functions?" on page 39.

How Do I Identify Devices?

1. Make sure you have installed batteries and chosen a model type.
2. Touch  (setup) on the Quick access menu to access the Setup menu.
3. Touch  IR button on the Setup menu to access the IR Setup menu.

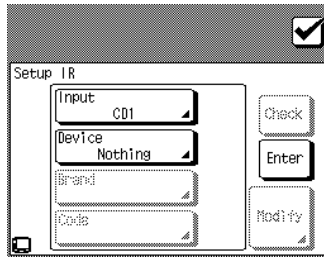

4. Refer to "Noting Your Devices" on page 3 where you noted which device was connected to which jack set.
5. Touch to open the list of available jack sets:
 - **CD1**
 - **CD2/TAPE2**
 - **MD/TAPE1**
 - **CD-R**
 - **VIDEO1** through **VIDEO4**
 - **DVD**
 - **AV AUX**
 - **TV1** and **TV2** (these allow PowerTouch to control your TV or cable tuner, even if it isn't connected to one of the receiver's input jack sets).

Touch the jack name on the list.

6. Touch to select the type of device you have connected to the jack set.
7. Touch to select the device's brand.
8. Touch . You can now choose from a list of all the codes available for the device. Touch the first code on the list.
 - If the devices are connected with a system control cable, be sure to select the code preceded by "Sys-"

or "System". This instructs PowerTouch to send all commands for the device to the receiver, which will control the device via the system control cable.

- If you have a Kenwood Dual-Play 200-Disc CD Changer, you will need to set both CD1 and CD2/TAPE2 to the correct code for this device ("Sys-Mega").

9. Touch . This instructs PowerTouch to send a "power" test signal to the receiver. If your device turns on, the code you entered was correct. If it does not turn on, try the next code in the list. Continue until one of the codes works. If none of the codes work, see "What if my device does not work with any of the codes on the list?" on page 39.

If you enter the code preceded by "Sys-" or "System" on step 8, skip this step.

10. When you have a code that works, touch . Check off that device on your list.

Repeat steps 5 through 10 until you are finished identifying devices to PowerTouch. When you are done, turn to "How Do I Operate Devices?" on page 29 in the *Users' Guide* and note which icon corresponds to which connected device.

What if I Connected a CD Player to the Jack Set PowerTouch Calls Tape2? (VR-4900/KRF-V9993D only)

To set the CD2/Tape2 input for CD:

1. Access the Setup menu.
2. Touch on the Setup menu to access the Analog Input Level menu.

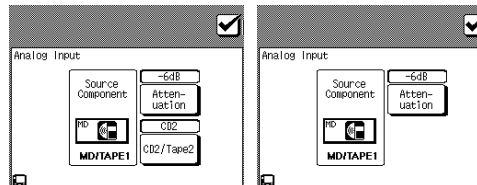

3. Touch until CD2 appears in the display.

4. Touch to return to the Setup menu.

How Do I Replace a Setup Code with a New One?

If you purchase a new device to replace an existing device, you will need to identify the new device to PowerTouch. To do so:

1. Connect the device as described in the appropriate section of Chapter One in this guide.
2. Follow the steps under "How Do I Identify Devices?" on page 37. When you touch, it will replace the other code.

How Do I Delete Setup Codes?

If you disconnect a device and do not plan to replace it, you may want to delete the setup code from PowerTouch. To do so:

1. Follow the steps under "How Do I Identify Devices?" on page 37 to select a jack set.
2. Touch . Scroll to the device "Nothing" then touch it. That device is no longer controlled by PowerTouch.

What if my device does not work with any of the codes on the list?

What if I Want PowerTouch to Control Additional Functions?

PowerTouch contains sophisticated features that allow it to “learn” new commands from other IR remotes. If none of the codes for the device and brand you select work, use this feature to instruct PowerTouch how to operate the device.

You can also use this feature to modify commands for codes that do work or even to add extra functionality to those codes.

For example, let’s say the basic control codes for your VCR are Power, Play, Rewind, Fast Forward, Pause, Channel and Record. Let’s also say that your VCR has an OSD (On Screen Display) menu that is not part of the default code set you chose. You can use your VCR’s remote to teach PowerTouch to access that menu.

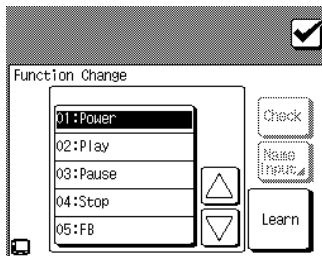

To teach PowerTouch new commands:

1. Follow the steps under “How Do I Identify Devices?” on page 37.
2. Touch  to open the Function Change menu:



3. Select the button to be programmed by learning (Include “Empty 1 to Empty 8”).

You will be able to access these new commands by touching **More** or the button you assign on any device control screen. (*Users’ Guide*)

4. When a button which can be renamed is selected,  (Name Input) button is displayed with black characters. Touch  to display the keyboard and enter the button name (Example: CD: On). If characters already have been entered, touch  to erase them. (See “How Do I Enter Text?” on page 8 of the *Users’ Guide*.)

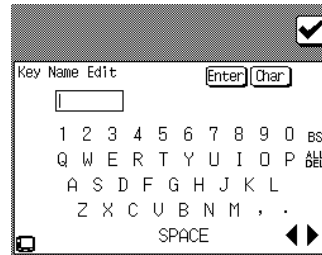

Then touch  on the keyboard display to establish the entry.



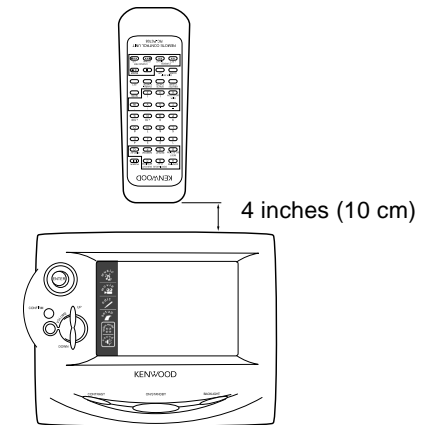

5. Touch the Learn button.
While “Learn” is displayed, perform the next operation. If the set is left untouched for more than one minute, “Time Out” will be displayed.
6. Aim the device’s remote at PowerTouch and press and hold the button *on the device’s remote* that corresponds to the command you want PowerTouch to learn: This may take a few seconds; **do not** move PowerTouch or the device’s remote until PowerTouch displays the Function Change menu again.
 - “Learn Success” is displayed when learning completes successfully.



- “Learn Fail” is displayed when it failed.

After a learning process is completed, always touch  to test the command or function that PowerTouch has learned. If the command or function does not work, perform the learning process again.

Be sure to use the device’s original remote. PowerTouch will not learn commands from other universal remotes.

7. Repeat steps 3 through 5 until you have taught PowerTouch all the commands you want it to know. If you need more function lines, touch  or  to access more lines.
8. Touch  to return to the IR Setup menu.
9. Touch  to return to the Setup menu.

NOTES

Depending on the remote control unit, “Learn” may not be possible.

Storing Radio Stations in Memory (optional)

Your new PowerTouch provides two ways to store radio stations:

- Manual Memory, which allows you to enter and store specific stations.
- RDS Automatic Memory (VR-4900 and KRF-V9993D), which searches for stations broadcasting an RDS signal and automatically stores them in the first available storage button.



There are 40 preset storage buttons available.

If you have a VR-4900 or KRF-V9993D, search for and store RDS stations first (see page 41), then set stations manually. The search function automatically assigns RDS stations to the first storage button, overwriting any stations already stored there.

40

You can overwrite RDS stations with manually stored stations.

Storing RDS Stations Automatically (VR-4900 and KRF-V9993D)

1. Touch (music) on the Main menu to access the Music menu.

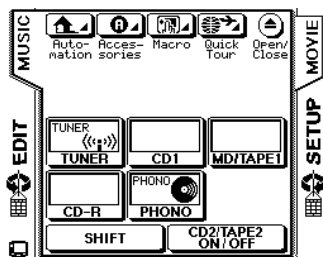

2. Touch on the Music menu to access the Tuner controls.

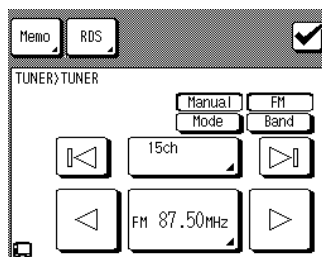

3. Touch to choose FM.
4. Touch at the top of the screen:

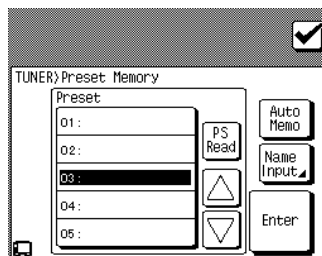

5. Touch . The receiver locates and stores any FM stations broadcasting an RDS signal. This process can take a few minutes to complete; please be patient. While the receiver is searching, "AUTO MEMORY" display blinks.



RDS stations are stored in the order they are found, up to 40 stations. If the search finds fewer than 40 stations, the receiver may automatically store other FM stations in the open storage buttons.

If you are repeating the RDS search, any existing preset stations (whether automatically or manually stored) will be replaced by the results of the new search.

Storing RDS Station Name (PS Read) (VR-4900 and KRF-V9993D)

- To execute PS Read, it is required to finish the auto memory operation in advance.

1. Touch (music) on the Main menu to access the Music menu.

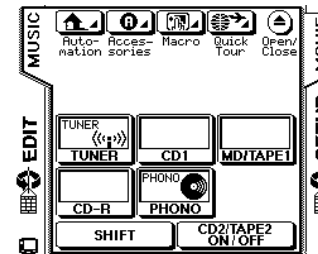



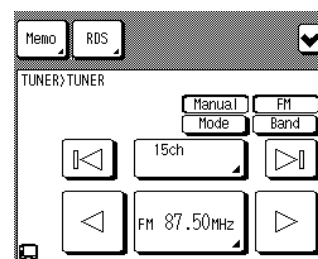

2. Touch on the Music menu to access the Tuner controls.

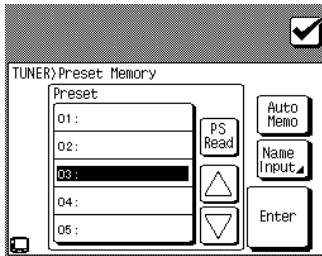

Chapter Two : Setting Up PowerTouch

3. Touch  at the top of the screen:





4. Touch .
5. Confirm the station name list and touch  if it is OK. If you do not want to finalize, touch  to return to the previous screen. .

The station name are written in the preset channel list.

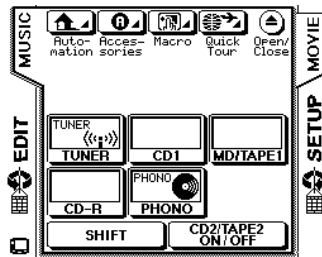

Storing Stations Manually



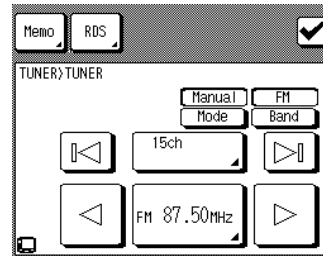

1. Touch  (music) on the Quick access menu to access the Music menu.



2. Touch  on the Music menu to access the Tuner controls.



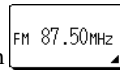

3. Touch  to choose the receiving band.
4. Touch  to switch between Auto tuning and Manual tuning. Select Manual if you experience interference due to weak radio signals.
5. Choose the station you want to store using one of the following methods:



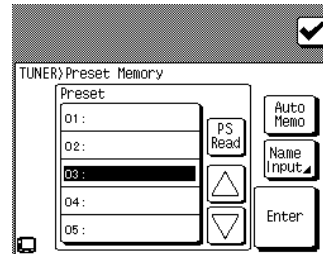



- Touch  or  until the station's broadcast frequency appears.
- Touch  and enter the broadcast frequency using the 10key pad. (e.g.; To select FM 87.5 MHz, enter 8, 7, 5, 0, and )

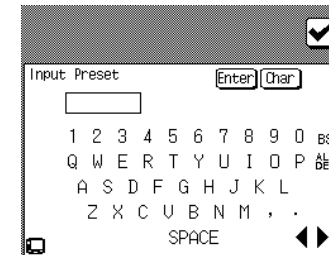

6. Touch Memo button at the top of the screen:



7. Touch a storage button. Use  or  to access more storage buttons.
If you choose a storage button that already has a station assigned, the new station will replace the previously-stored station.
8. (Optional) Touch  to enter a name for the station in the Preset Memory menu:



- Use the stylus to select characters from the keyboard. **41**
 - Touch  to access to lowercase characters. Touch it again to access special characters (such as @, !, &, etc.). Touch it a third time to return to uppercase characters.
 - Touch  or  to move back and forth between the characters.
 - Touch  (backspace) to clear the last character you entered. Touch  to delete all the characters in the line.
 - Touch  to save your title.
9. Touch  to tune to the newly saved station and return to the Tuner controls.
 10. Repeat steps 3 through 9 for each station you want to store.

Touch  (check icon) to return to the TUNER control menu, then touch  (check icon) again to return to the basic Music menu.

Chapter Three: Setting Up on the Receiver

It is possible to set up the speakers and register the input devices on the receiver main unit.

However, some of the setting items such as the controlled device registration should also be set on the PowerTouch. If setup is made on the PowerTouch, it is not necessary to repeat any setup on the receiver side.

Therefore, it is recommended to perform setup on the PowerTouch. This chapter describes the setup on the receiver only as an alternative method in case the setup is not made on the PowerTouch.

Do not operate the PowerTouch during the receiver setup.

Preparation for setup

Most of the receiver control keys are accommodated inside the panel door. Make the following preparation for setup on the receiver.

1. Plug the power cord into a household power outlet.
2. (VR-4900, VF-4700)
Press the REMOTE POWER key to turn the receiver ON.

(KRF-V9993D)

Press the POWER switch to supply the main power. The receiver now enters the STANDBY mode (in which remote control is available). Then press the **ON/STANDBY** key to turn the receiver **ON**.

3. Open the panel door.

VR-4900/KRF-V9993D

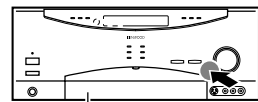

Press the DOOR OPEN/CLOSE key to open the panel door. To close it, press the key again.

Panel door

VR-4700

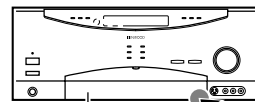

Press the lower part of the panel door.

Panel door

Key layout

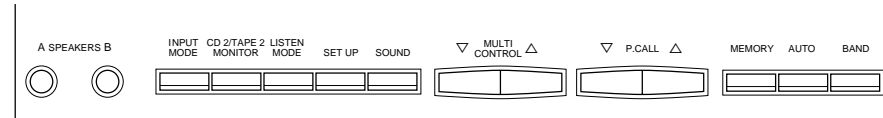

Speaker setup

1. Selecting the speakers

Selecting the **SUBWOOFER**:

- ① Press the **SET UP** key inside the panel door to display "SUBWOOFER OFF (or ON)".
- ② Press the **MULTI CONTROL** (∇/Δ) key to select **ON** (when a subwoofer is used) or **OFF** (when not).

Selecting the **FRONT** speakers:

- ③ Press the **SET UP** key to display "FRONT LARGE (or NORMAL)".
- ④ Press the **MULTI CONTROL** (∇/Δ) key to select **FRONT LARGE** (large-sized speakers) or **NORMAL** (normal-sized speakers).

If the **SUBWOOFER** is set to **OFF**, the **FRONT** speakers are set automatically to **LARGE** and the **CENTER** speaker selection display appears automatically.

Selecting the **CENTER** speaker:

- ⑤ Press the **SET UP** key to display "CENTER LARGE (or NORMAL or OFF)".
- ⑥ Press the **MULTI CONTROL** (∇/Δ) key to select **CENTER LARGE** (large-sized speaker), **NORMAL** (normal-sized speaker) or **OFF** (no center speaker).

If the **FRONT** is set to **NORMAL**, the **CENTER** speaker can be set to only either **NORMAL** or **OFF**.

Selecting the **SURROUND** speakers:

- ⑦ Press the **SET UP** key to display "SURROUND LARGE (or NORMAL or OFF)".

- ⑧ Press the **MULTI CONTROL** (∇/Δ) key to select **SURROUND LARGE** (large-sized speakers), **NORMAL** (normal-sized speakers) or **OFF** (no surround speaker).

When the **FRONT** is set to **NORMAL**, the **SURROUND** speakers can be set to only either **NORMAL** or **OFF**.

Selecting **SW RE-MIX**:

- ⑨ Press the **SET UP** key to display "SW-REMIX OFF (or ON)". If the **SUBWOOFER** is set to **OFF**, selecting SW RE-MIX step will be skipped.
- ⑩ Press the **MULTI CONTROL** (∇/Δ) key to select **ON** or **OFF**.
- ⑪ Press the **SET UP** key to proceed to "Selecting the speaker volumes" below. To exit from setting, press the **SET UP** key repeatedly until "SETUP FIXED" is displayed.

For details on the SW RE-MIX and the selection of speakers, please see page 36.

Chapter Three: Setting Up on the Receiver

2. Adjusting the speaker volumes

Adjust the volume balance between the speakers in the system by actually listening to them. See page 36 for details.

- ① Minimize external noise in the listening room.
- ② Position yourself in a place where you usually listen to music or view video.
- ③ Increase the receiver's main volume to -25 dB. (To improve the adjustment accuracy, it is effective to set the volumes at a slightly loud volume.)
- ④ Perform operation in step ① of procedure 1 above. The speaker volume adjustment display appears and test noise is generated from the front left speaker ("L 0 dB" displayed). Listen to the volume of the noise carefully.
- ⑤ When the test noise moves to the center speaker and "C 0 dB" is displayed, adjust the volume to the same level as the front left speaker by pressing the **MULTI CONTROL** (▽/△) key.
- ⑥ Similarly, adjust the volumes of the "R" (front right), "RS" (right surround) and "LS" (left surround) speakers.
- ⑦ Press the **SET UP** key to proceed to "Selecting the speaker distances" below. To exit from setting, press the **SET UP** key repeatedly until "SETUP FIXED" is displayed.

Do not adjust the "SW" (SubWoofers) volume using the test noise. It should be adjusted while listening to ordinary music.

3. Setting the speaker distances

Measure the distance between each speaker and the listening position you frequently use. See page 36 for details.

- ① After the operation of ⑦ in procedure 2 above, the speaker distance setting display appears.
- ② When "L 3.0m/10ft" is displayed, correct the distance of the front left speaker from you using the **MULTI CONTROL** (▽/△) key.
- ③ Press **SET UP** key to display "C 3.0m/10ft" and correct the distance of the center speaker from you using the **MULTI CONTROL** (▽/△) key.
- ④ Similarly, set the distances of the "R" (front right), "RS" (right surround), "LS" (left surround) and "SW" (Super Woofer) speakers.
- ⑤ Press the **SET UP** key repeatedly until "SETUP FIXED" is displayed.

Storing Radio Stations in Memory (optional)

Radio stations can be preset in the memory in the receiver and recalled by a one-touch operation.

The memory in the receiver cannot store the station names. To store the station names, use the PowerTouch. (For details, see "Storing Radio Stations in Memory (optional)" on page 40.)

Storing RDS Stations Automatically (VR-4900 and KRF-V9993D):

- ① Press the **INPUT SELECTOR** ◀ or ▶ key to select the Tuner input.
- ② Press the **BAND** key to select the FM band.
- ③ Press and hold the **MEMORY** key for more than 2 seconds. The receiver locates and stores any FM stations broadcasting an RDS signal. This process can take a few minutes to complete; please be patient. While the receiver is searching, "AUTO MEMORY" display blinks.

Storing Stations Manually:

- ① Press the **INPUT SELECTOR** ◀ or ▶ key to select the Tuner input.
- ② Press the **BAND** key to choose the receiving band.
- ③ Press the **MEMORY** key.
- ④ Press the **P.Call** (▽/△) key to display the desired preset number.
- ⑤ Press the **MEMORY** key again to complete the presetting.
- ⑥ To preset other stations, repeat steps ② to ⑤ for each station you want to store.

Chapter Four: Setting Up Multiple Rooms

The VR-4900 and KRF-V9993D offers dual-room output and control, which enables you to use a single receiver to control devices and speakers for two rooms. Due to its advanced features and controls, you can play music in one room while watching a movie in the other!

Depending on your tastes and budget, you can set up one of the following “sound scenarios” to make full use of the Receiver’s capabilities:

No additional amplifier for Room B: You can use the Receiver’s Speaker B output for Room B. This allows you to listen to full surround sound in Room A only, or in stereo in Room A when Room B is active. The sound in Room B will always be in stereo.

Stereo amplifier for Room B: You can use an additional stereo amplifier for Room B (connected to the Receiver’s Second Room Preouts). This allows you to listen to full sur-

round sound in Room A even if you are also listening in Room B. The sound in Room B will always be in stereo.

Multiple rooms require you to run wires and cabling from the primary room (Room A) where your Receiver is installed to another room (Room B) where an IR Receiver (so you can use your PowerTouch to control devices), a second set of speakers, and possibly a second TV/Monitor is installed:

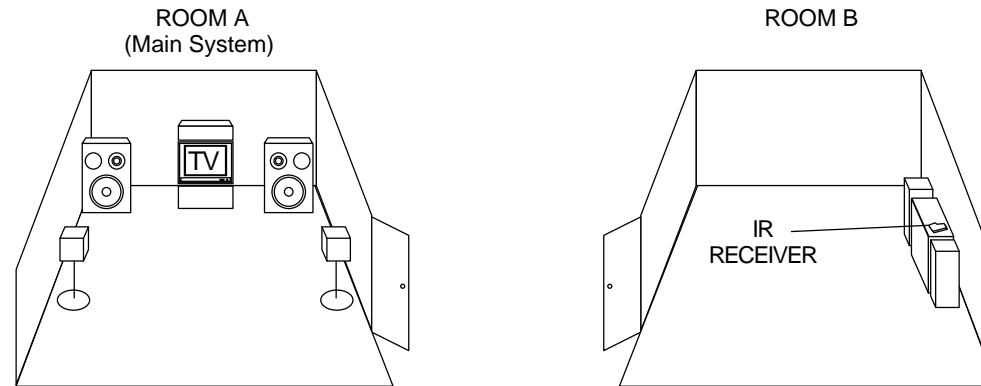

This chapter discusses some of the connection configurations and additional PowerTouch setup necessary if you want to take full advantage of the Receiver’s multiple-room capabilities. It contains the following sections:

Making Connections

page 46

Setting Up PowerTouch

page 47



Kenwood recommends hiring a competent installer to make multiple-room connections and setup.

Making Connections

This section describes how to connect speakers in the two rooms to support the different scenarios. Before you read this section, Kenwood recommends reading “Connecting

Your Speakers” on page 4 of this guide. In addition, this section discusses how to connect a second TV/Monitor and how to connect an IR Receiver, IR Repeaters, Relays, and a

TV On/Off Sensor (for use with Perfect Macro).

Scenario 1: Surround Sound in Room A only or Stereo in Room A and Stereo in Room B (Using the Receiver’s Speaker B Outputs)

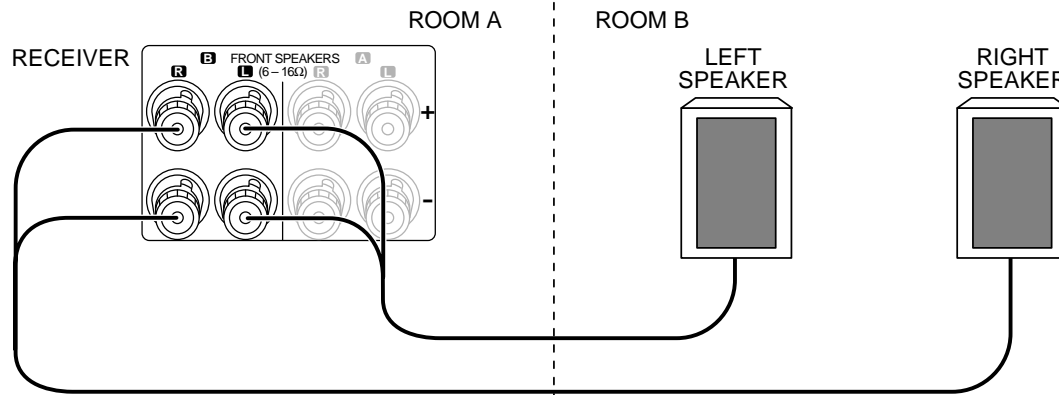

The five amplifiers built into the receiver meet your sound needs for both rooms. The built-in amplifiers allow you to listen to full surround sound if you are listening in Room A only, or stereo in Room A if both rooms are active. You will always hear stereo in Room B. Make the speaker connections as shown in the illustration under “To Connect Front and Surround Sound Speakers:” on page 5, being sure to also connect the Room B speakers to the **SPEAKER B** binding post.

Scenario 2: Surround Sound in Room A and Stereo in Room B (Using a Stereo Amplifier in Room B)

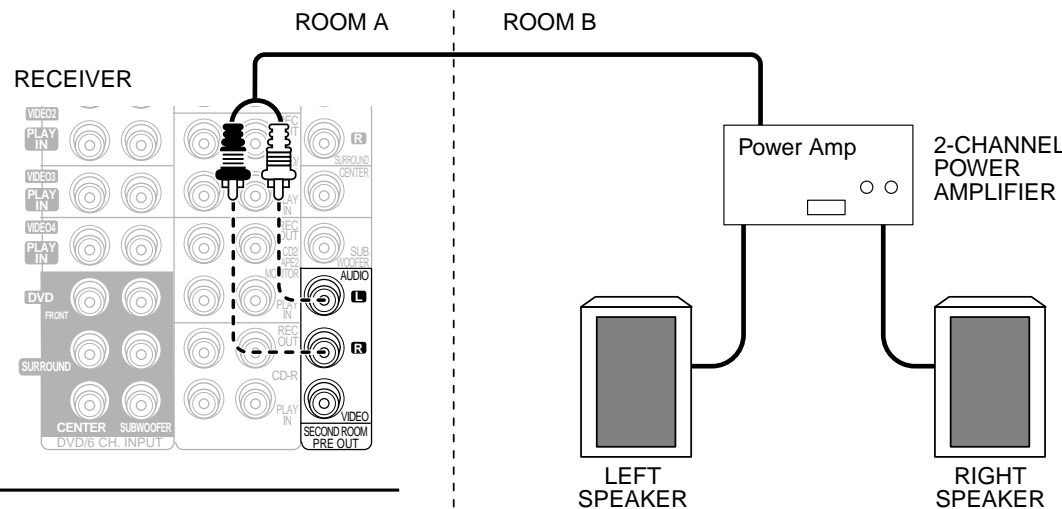

You use an additional stereo amplifier for Room B. This allows you to listen to full surround sound in Room A even if both rooms are active. You will always hear stereo in Room B. Make the speaker and amplifier connections as shown in the illustration.

Both Scenarios: Connecting a Second TV/Monitor

If you plan to watch movies, or any other visual entertainment activity in Room B, you must connect an additional TV/Monitor. To do so, connect a standard composite video cable from the Room B TV to the **SECOND ROOM PRE OUT VIDEO** jack.

The above is possible only when the composite signals are input.

You can operate equipment from two different rooms using your Kenwood PowerTouch. To do so:

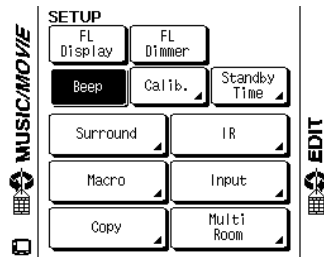

1. Make sure you have identified all the connected devices to your PowerTouch. For more information on identifying devices, see "Identifying Devices For PowerTouch Control" on page 37 of this manual.
2. Touch the  (setup) on the Quick access menu to access the Setup menu.

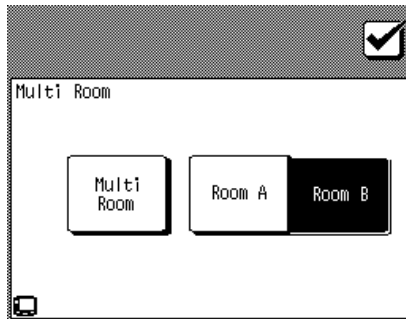

3. Touch  to access multi-room commands:



Setting Up the PowerTouch

4. Touch the  to highlight it.
5. Room A and Room B can be alternated each time the  () button is pressed. The button inverted in black is the currently controllable button.

Your PowerTouch is now set up to operate devices in multiple rooms. Which room it controls depends on which room you select. For more information on selecting rooms, see "How Do I Switch Control Modes?" on page 86 of the *Users' Guide*.

Connecting an External Infrared Receiver and IR Repeaters

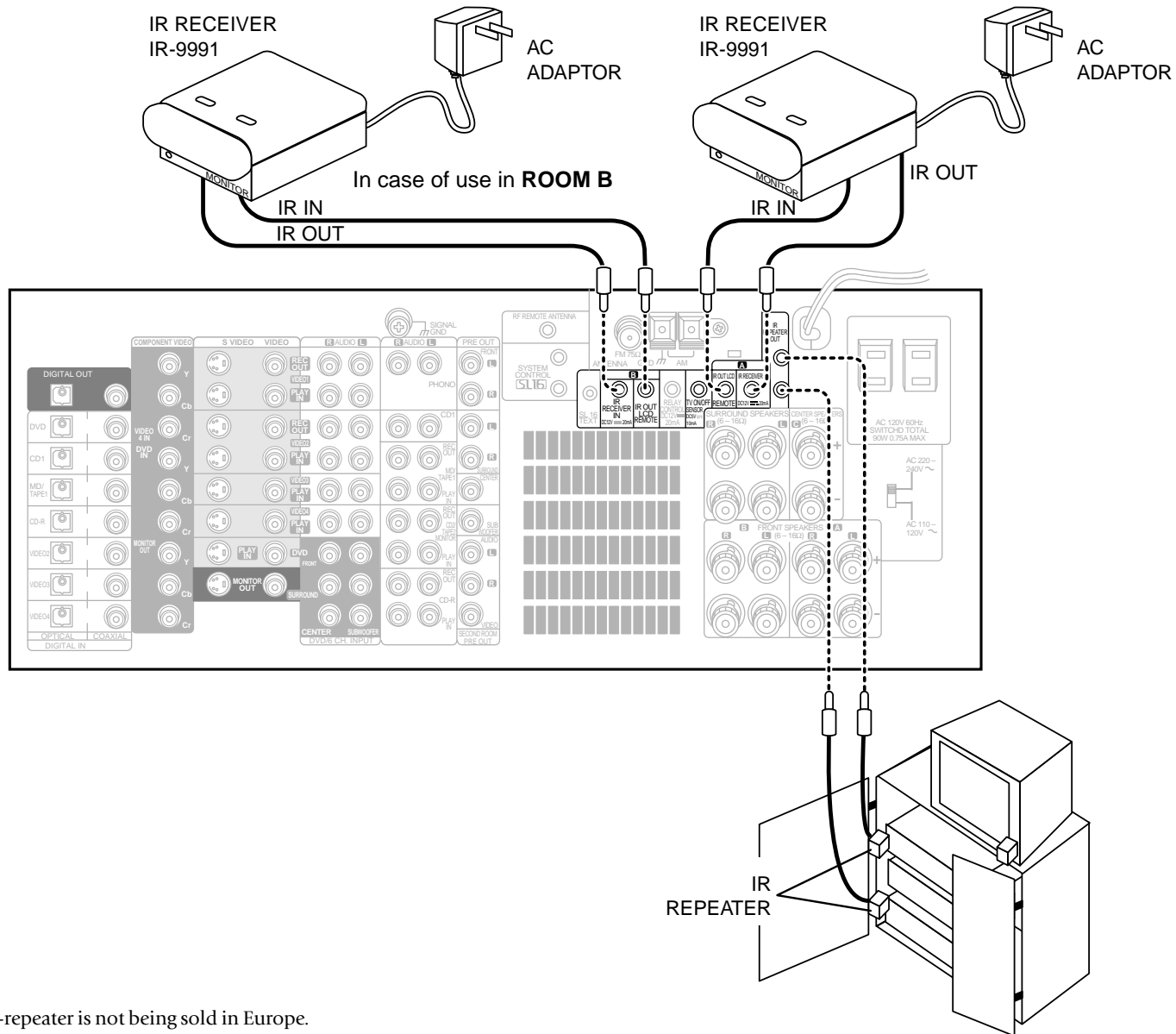

Note:

The optional IR-9991 IR-repeater is not being sold in Europe.

Connecting an External Infrared Receiver and IR Repeaters, continued

Your new audio-video receiver supports the IR-9991 two-way external infrared (IR) remote transceiver control. The IR-9991 enables you to use the Receiver's PowerTouch to operate the receiver if it is:

- in a stereo closet/cabinet
- behind glass doors
- in another room
- in any situation where the device to be controlled is not visible

You can substitute Xantech (291-80, 480-30, or 490-30 series) IR receivers for the IR-9991. However, these devices are one-way only, and will not supply system status feedback to PowerTouch.

For more information about using external IR receivers in another room, see "Chapter Four: Setting Up Multiple Rooms" on page 45.

To Connect a KENWOOD IR-9991 IR Receiver:

1. Connect the IR-9991's IR IN cable to the Receiver's **IR RECEIVER IN** jack. This jack supports a 12V 20mA signal.
2. Connect the IR-9991's IR OUT cable to the Receiver's **IR OUT LCD REMOTE** jack.
3. Connect an AC adaptor to the IR-9991. **Do not** plug the adaptor into the wall until all connections are made.
4. To activate the IR receiver connections, you need to press **INPUT MODE** key on the front panel of the receiver for more than 2 seconds.

You will see "RF OFF" (VR-4900/VR-4700) or "DATA REAR IN" (KRF-V9993D)

- The RF remote function will not be available in RF OFF mode.

To Connect any other IR Receiver:

1. Connect the IR receiver's output cable to the Receiver's **IR RECEIVER IN** jack. This jack supports a 12V 20mA signal.
2. (For some IR receiver)
Connect an AC adaptor to the IR receiver. **Do not** plug the adaptor into the wall until all connections are made.
3. To activate the IR receiver connections, you need to press **INPUT MODE** key on the front panel of the receiver for more than 2 seconds.
 - VR-4900/VR-4700 : You will see "RF OFF" on the receiver display.
 - KRF-V9993D : You will see "DATA REAR IN " on the receiver display.

To Connect IR Repeaters:

IR repeaters enable you to control components located in cabinets or behind glass doors. To connect repeaters:

1. Connect the IR repeater to the device as described in the repeater's manual.
2. Connect the IR repeater cable(s) to the Receiver's **IR REPEATER OUT** jack(s).

IR repeaters send a signal similar to the device's own remote control. Xantech repeaters (models 282-00, 286-00, or 283-00) are compatible with your new audio-video receiver.

Do not connect IR repeaters unless you have connected an external IR receiver. The connections are only active when an IR receiver is connected.

Connecting and Setting Up On/Off Sensors or Relay Controls (VR-4900 and KRF-V9993D)

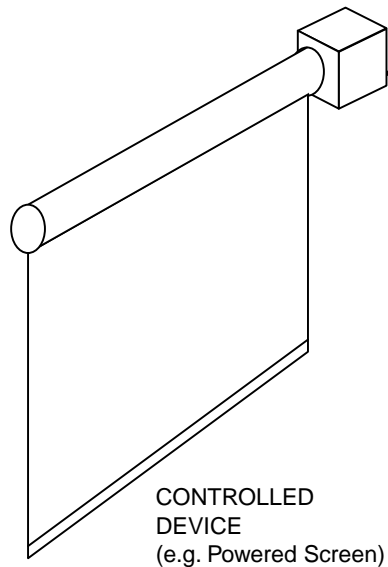
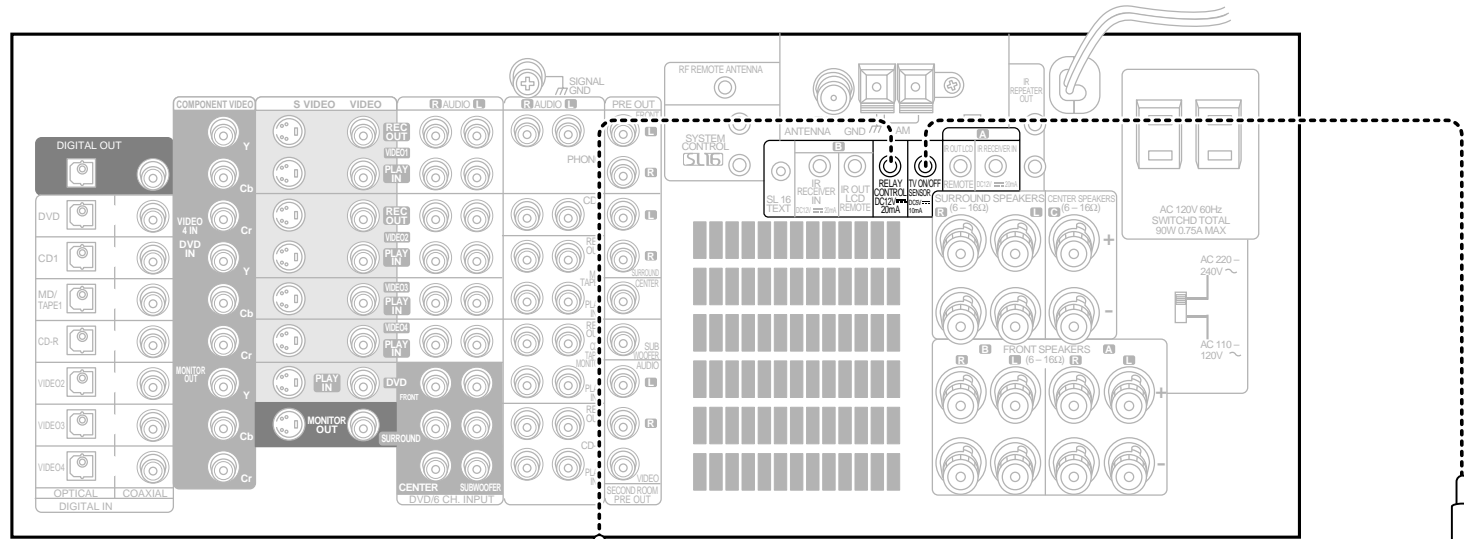

	status		
	Power Off	Power On	Power On and when switched to Video Input
To Tip	0V	0V	+12V
To Ring	0V	+12V	+12V
To Sleeve	Ground	Ground	Ground

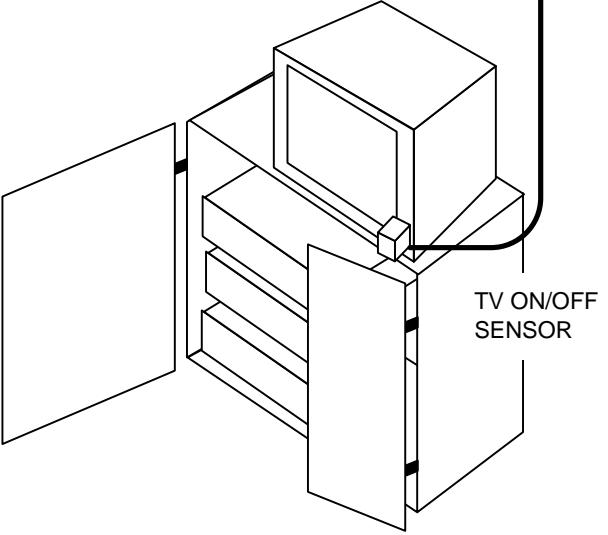

Connecting and Setting Up On/Off Sensors or Relay Controls (VR-4900 and KRF-V9993D), continued

The VR-4900 and KRF-V9993D supports 2 types of additional external controls:

- A relay control that enables you to operate external relay-control devices (such as the Xantech 590-0 programmable controller, via Xantech's 599-00 pulse switching module).
- A TV ON/OFF sensor that enables you to use the Perfect Macro feature (described further in the *Users' Guide*) to accurately sense whether the TV is already on or off and adjust accordingly.

To Connect Relay Controls:

1. Consult the relay control's manual for compatibility information and installation instructions before connecting it to your new receiver. If you install the control incorrectly or connect an incompatible control to the receiver, you may damage the control *and* your new receiver.
2. Connect the control cable to the receiver's **RELAY CONTROL** jack. This jack supports a 12V, 20mA signal.

Do not connect multiple 599-00 switching modules to each other or to the receiver, as this can exceed the maximum current capacity of the jack and damage your receiver.

To Connect TV ON/OFF Sensors:

1. Connect the sensor to the TV as described in the sensor's manual.
2. Connect the sensor cable to the receiver's **TV ON/ OFF SENSOR** jack. This jack supports a 5V, 10mA signal.

JDS:PSS-TV or NILES:LS-1, APC-2 sensors are compatible with your new receiver.

Chapter Five: Warnings and Specifications

Read this page carefully to ensure safe operation.

Warnings

FCC WARNING

This equipment may generate or use radio frequency energy. Changes or modifications to this equipment may cause harmful interference unless the modifications are expressly approved in the instruction manual. The user could lose the authority to operate this equipment if an unauthorized change or modification is made.

NOTE: This equipment has been tested and found to comply with the limits for a Class B digital device, pursuant to Part 15 of the FCC Rules. These limits are designed to provide reasonable protection against harmful interference in a residential installation. This equipment may cause harmful interference to radio communications if it is not installed and used in accordance with the instructions. However, there is no guarantee that interference will not occur in a particular installation. If this equipment does cause harmful interference to radio or television reception, which can be determined by turning the equipment off and on, the user is encouraged to try to correct the interference by one or more of the following measures:

- Reorient or relocate the receiving antenna.
- Increase the separation between the equipment and the receiver.
- Connect the equipment into an outlet on a circuit different from the one that the receiver is connected to.
- Consult the dealer or an experienced radio/TV technician for help.

Chapter Five : Warnings and Specifications

KRF-V9993D

Audio Section

Rated Output Power during stereo operation

20 Hz ~ 20 kHz, 0.05% T.H.D. , 4Ω (IEC)	130W + 130 W
1 kHz, 0.05% T.H.D. , 4Ω (DIN/IEC)	130W + 130 W

Effective Output Power during surround operation (Simultaneous power)

Front	130 W + 130 W
20 Hz ~ 20 kHz, 0.06 % T.H.D. at 4 Ω	130 W + 130 W
Center	130 W
20 Hz ~ 20 kHz, 0.06 % T.H.D. at 4 Ω	130 W
Surround	130 W + 130 W
20 Hz ~ 20 kHz, 0.06 % T.H.D. at 4 Ω	130 W + 130 W

Total Harmonic Distortion

0.005 % (1 kHz, 10 W, 4 Ω)

Frequency Response (IHF'66)

CD1	7 Hz ~ 90 kHz, 0 dB, -3 dB
DVD 6CH	7 Hz ~ 100 kHz, 0 dB, -3 dB

Signal to Noise Ratio (IHF '66)

PHONO (MM)	74 dB
CD1	97 dB

Input Sensitivity / Impedance

PHONO (MM)	2.5 mV / 47 kΩ
CD1	200 mV / 47 kΩ
DVD 6CH	200 mV / 47 kΩ

Output Level / Impedance

TAPE REC	200 mV / 2.2 kΩ
PRE OUT(Front, Center, Surround, Subwoofer) ...	1 V / 1 kΩ

Tone Control

Bass	± 7 dB (at 100 Hz)
Treble	± 7 dB (at 10 kHz)

Loudness Control Volume at -40 dB level

+6 dB (100 Hz), +3 dB (10 kHz)

Digital Audio Section

Sampling Frequency

32 kHz, 44.1 kHz, 48 kHz, 96 kHz

Input Level / Impedance / Wavelength

Optical	-15 dBm ~ -21 dBm, 660 nm ±30 nm
Coaxial	0.5 Vp-p / 75 Ω

Output Level / Impedance / Wavelength

Optical	-15 dBm ~ -21 dBm, 660 nm ±30 nm
Coaxial	0.5 Vp-p / 75 Ω

Video Section

Video Inputs / Outputs

Video (composite)	1 Vp-p / 75 Ω
S Video (luminance signal)	1 Vp-p / 75 Ω
(chrominance signal)	0.286 Vp-p / 75 Ω
Component (luminance signal)	1 Vp-p / 75 Ω
(Cb/Cr-signal)	±0.350 Vp-p / 75 Ω

FM Tuner Section

Tuning Frequency Range

87.5 MHz ~ 108 MHz

Usable Sensitivity (DIN at 75 Ω)

Mono	1.2 μV/ 13.2 dBf (40 kHz dev., S/N 26 dB)
Stereo	45 μV/ 44.2 dBf (46 kHz dev., S/N 46 dB)

Total Harmonic Distortion (1 kHz)

Mono	0.2 % (65.2 dBf input)
Stereo	0.8 % (65.2 dBf input)

Signal to Noise Ratio (DIN. at 1 kHz, 40 kHz dev.)

Mono	65 dB (65.2 dBf input)
Stereo	60 dB (65.2 dBf input)

Stereo Separation (1 kHz)

36 dB

Selectivity (DIN +300 kHz)

64 dB

Frequency Response

30 Hz ~ 15 kHz, +0.5 dB, -3.0 dB

AM Tuner Section

Tuning Frequency Range

531 kHz ~ 1,602 kHz

Usable Sensitivity (30 % mod., S/N 20 dB)

16 μV / (600 μV/m)

Signal to Noise Ratio (30 % mod., 1 mV input)

50 dB

IR In/Out Section

IR Receiver In Terminal

Maximum Output Current	20 mA
Operating Voltage	12 V
Output Impedance	470 Ω

IR Out LCD Remote Terminal

Maximum Output Current	20 mA
Operating Voltage	5 V
Output Impedance	470 Ω

SHAPE OF PLUG TO BE CONNECTED:

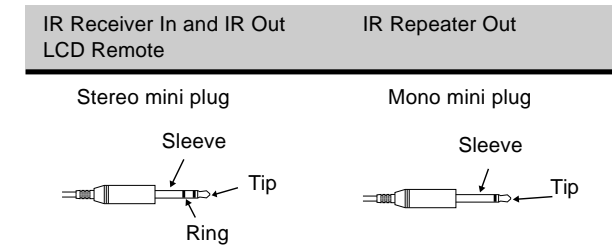

IR IN/OUT SPECIFICATION:

	IR Receiver In	IR OUT LCD REMOTE
To Tip	Signal	Signal
To Ring	Ground	
To Sleeve	+12V	Ground

RELAY CONTROL SPECIFICATION:

	Power Off	Power On	status	Power On and when switched to Video Input
To Tip	0V	0V		+12V
To Ring	0V	+12V		+12V
To Sleeve	Ground	Ground		Ground

General

Power consumption

480 W

AC outlet

Switched	2 (total 90 W max.)
----------	---------------------

Dimensions

W : 480mm
H : 191mm
D : 416mm

Weight (Net)

18 kg

Kenwood follows a policy of continuous advancements in development. For this reason, specifications may be changed without notice. Full performance may not be exhibited in extremely cold locations (below 0 deg. C).

Numerics

200-Disc CD Changer	
connecting	15
connecting SL16 text cable	15
identifying to PowerTouch	38
SL16/XS8 switch	15

A

AM antenna	
connecting	31
preventing hum interference	31
amplifier	
connecting	6
using in multiple rooms	46
analog cables	
DVD player	17
laser disc player	25, 27
antennas, connecting	31
audio cables	
200-Disc CD Changer	15
cable TV	11
camcorder	29
DVD player	17
laser disc player (AC-3 Output)	25
laser disc player (no AC-3 Output)	27
MD recorder	21
primary tape deck	21
satellite tuner	11
second tape deck	23
VCR	13, 29

B

batteries, installing in PowerTouch	32
---	----

C

cable radio, connecting (call provider)	31
cable TV	
connecting	10, 11
identifying to PowerTouch	38
with RCA video output	11
without RCA video output	11
camcorder, connecting	29
CD player, connecting	14, 15
CD-R Recorder, connecting	18, 19
CD2/TAPE2, setting the input icon	38
center speaker, connecting	5
clearing PowerTouch stored settings	33

coaxial cable	
200-Disc CD Changer	15
DVD player	17
LD player	25, 27
communication cable, connecting	14
connecting	
200-Disc CD Changer	15
AM antenna	31
amplifier	6
antennas	31
audio cable to MD recorder	21
audio cables to VCR	13
cable radio (call provider)	31
camcorder	29
CD player	14, 15
CD-R Recorder	18, 19
DVD player	16, 17
external infrared receiver	48, 49
FM antenna	31
IR repeaters	48, 49
laser disc player with AC-3 Output	24
MD recorder	20
On/Off sensors	50, 51
other primary CD player	15
primary tape deck	20
relay controls	48, 49
second VCR	13
speakers	4
speakers multiple rooms	45, 46
system control cable to primary	
tape deck	21
tape deck	20
turntable/record player	28
turntable's ground cable to receiver	28
TV	8, 46
TV On/Off sensors	50, 51
VCR	12, 29
video cables to VCR	13
video-CD compatible CD player	15
connection warning	
analog cables, laser disc player	25
DVD player	17
IR repeaters	49
laser disc player	25, 27
receiver vs. relay controls	51
second CD player	22
second tape deck	22

D

deleting, PowerTouch setup codes	38
devices	
identifying to PowerTouch	37
digital cable	
CD player	15
CD-R Recorder	19
DVD player	17
laser disc player (AC-3 Output)	25
laser disc player (no AC-3 Output)	27
digital connection warning	25
Dolby Digital (AC-3) RF Out	25
DVD player	
connecting	16, 17
identifying to PowerTouch	38

E

external infrared receiver, connecting	48, 49
--	--------

F

FM antenna, connecting	31
front speakers, connecting	5

G

ground cable, connecting turntable	28
--	----

H

hum interference	31
------------------------	----

I

IR receiver	
connecting	49
models compatible with receiver	49
IR repeaters	
connecting	49
models compatible with receiver	49

L

laser disc player	
identifying to PowerTouch	38
RF Demodulator and	25
with AC-3 Output, connecting	25
with PCM Digital Output, connecting	27
without AC-3 Output, connecting	27
without Dolby Digital Output,	
connecting	27

left speakers

front, connecting	5
surround, connecting	5

M

MD recorder, connecting	20
multiple rooms	
connecting IR repeaters	49
connecting relays	51
connecting second TV monitor	46
connecting TV On/Off sensor	51
IR receiver, connecting	49
set up	47
sound scenarios	45, 46
sound setup	47
using external infrared receiver	49

N

navigating PowerTouch interface	34
---------------------------------------	----

O

On/Off sensors, connecting	51
optical cable	
DVD player	17
MD recorder	21

P

PCM Digital Output laser disc player,	
connecting	27
powered subwoofer, connecting	5
PowerTouch	
clearing stored settings and	
reconfiguring	33
deleting setup code	38
identifying devices	37
identifying receiver model type	33
installing batteries	32
introductory information	32
navigating the display screen	34
operating components through	
external infrared receiver	49
replacing old setup code with new	38
selecting main menu	34
selecting model type	33
selecting speakers	35
setup for multiple room use	47
setup menu	35

speaker distance, setting	36
speaker level, setting	36
speaker type, setting	37
storing radio stations	40
R	
radio stations, storing in memory	40
RDS stations, storing in PowerTouch	40
receiver	
identifying model type to PowerTouch ..	33
record player/turntable, connecting	28
relay controls	
connecting	50, 51
connection warning	51
resetting	
PowerTouch	33
RF remote antenna	31
RF remote control function	42
right speakers	
front, connecting	5
surround, connecting	5
room A	
sound scenario	45, 46
room B	
connecting second TV	46
sound scenario	45, 46
S	
S video cable	
cable TV	10
DVD player	16
laser disc player	24, 26
satellite tuner	10
VCR	12
satellite tuner	
connecting	10, 11
identifying to PowerTouch	38
second tape deck	
connecting	21
connecting audio cable	21
connection warning	23
identifying to PowerTouch	38
second VCR	
connecting	13, 29
identifying to PowerTouch	38
setup codes	
deleting	38
setup menu, on PowerTouch	35
SL16	
200-Disc CD Changer	15
chained connections	30
system control mode	30
XS8 switch, 200-Disc CD Changer	15
sound scenarios	
Room A	45, 46
Room B	45, 46
speakers	
connecting	4, 45
connecting in multiple rooms	45
setting with PowerTouch	35
specifications and warnings	52
storing radio stations in memory	40
subwoofer	
connecting	4
supplemental power amplifiers, connecting	7
surround sound	
connecting speakers	5
system control cables	
200-Disc CD Changer	15
CD player	15
connection warning	30
MD recorder	20
tape deck	20
system control chaining	30
T	
tape deck	
connecting	20
identifying to PowerTouch	38
turntable/record player, connecting	28
TV	
connecting	9
identifying to PowerTouch	38
On/Off sensors, connecting	51
watching without using receiver	9
V	
VCR	
connecting	12, 13
identifying to PowerTouch	38
video cables	
another VCR	29
cable TV	11
camcorder	29
DVD player	17
laser disc player (AC-3 Output)	25
laser disc player (no AC-3 Output)	27
satellite tuner	11
TV	9
VCR	13
video CD-compatible CD player, connecting .	15
W	
warnings and specifications	52
X	
XS8 chained connections, example of	
chained components	30

KENWOOD

For your records

Record the serial number, found on the back of the unit, in the spaces designated on the warranty card, and the space provided below. Refer to the model and serial numbers whenever you call upon your dealer for information or service on this product.

Model _____ Serial Number _____

Free Manuals Download Website

<http://myh66.com>

<http://usermanuals.us>

<http://www.somanuals.com>

<http://www.4manuals.cc>

<http://www.manual-lib.com>

<http://www.404manual.com>

<http://www.luxmanual.com>

<http://aubethermostatmanual.com>

Golf course search by state

<http://golfingnear.com>

Email search by domain

<http://emailbydomain.com>

Auto manuals search

<http://auto.somanuals.com>

TV manuals search

<http://tv.somanuals.com>