

KENWOOD

AUDIO VIDEO SURROUND RECEIVER

VR-705

VR-715

KRF-V5070D

KRF-V4070D

KRF-V5570D

INSTRUCTION MANUAL

KENWOOD CORPORATION

This instruction manual is for some models. Model availability and features (functions) may differ depending on the country and sales area.

About the supplied remote control

Compared to standard remote controls, the remote control supplied with this receiver has several operation modes. These modes enable the remote control to control other audio/video components. In order to effectively use the remote control it is important to read the operating instructions and obtain a proper understanding of the remote control and how to switch its operation modes (etc.). Using the remote control without completely understanding its design and how to switch the operation modes may result in incorrect operations.

Before applying the power

⚠ Caution : Read this page carefully to ensure safe operation.

Units are designed for operation as follows.

- U.S.A. and Canada **AC 120 V only**
- Australia **AC 240 V only**
- Europe and U.K. **AC 230 V only**
- China and Russia **AC 220 V only**
- Other countries **AC 110-120 / 220-240 V switchable***

* AC voltage selection

The AC voltage selector switch on the rear panel is set to the voltage that prevails in the area to which the unit is shipped. Before connecting the power cord to your AC outlet, make sure that the setting position of this switch matches your line voltage. If not, it must be set to your voltage in accordance with the following direction.

AC voltage selector switch

Move switch lever to match your line voltage with a small screwdriver or other pointed tool.

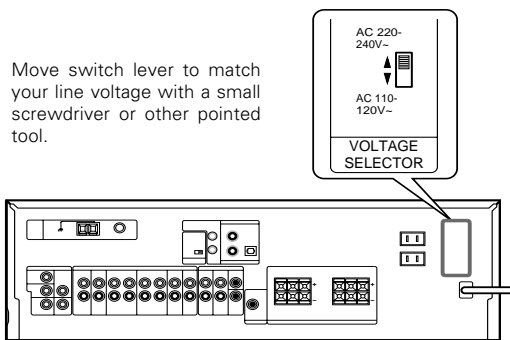



Note :

Our warranty does not cover damage caused by excessive line voltage due to improper setting of the AC voltage selector switch.

Safety precautions

WARNING :

TO PREVENT FIRE OR ELECTRIC SHOCK, DO NOT EXPOSE THIS APPLIANCE TO RAIN OR MOISTURE.

**CAUTION**
RISK OF ELECTRIC SHOCK
DO NOT OPEN

CAUTION: TO REDUCE THE RISK OF ELECTRIC SHOCK, DO NOT REMOVE COVER (OR BACK). NO USER-SERVICEABLE PARTS INSIDE. REFER SERVICING TO QUALIFIED SERVICE PERSONNEL.

 THE LIGHTNING FLASH WITH ARROWHEAD SYMBOL, WITHIN AN EQUILATERAL TRIANGLE, IS INTENDED TO ALERT THE USER TO THE PRESENCE OF UNINSULATED "DANGEROUS VOLTAGE" WITHIN THE PRODUCT'S ENCLOSURE THAT MAY BE OF SUFFICIENT MAGNITUDE TO CONSTITUTE A RISK OF ELECTRIC SHOCK TO PERSONS.

 THE EXCLAMATION POINT WITHIN AN EQUILATERAL TRIANGLE IS INTENDED TO ALERT THE USER TO THE PRESENCE OF IMPORTANT OPERATING AND MAINTENANCE (SERVICING) INSTRUCTIONS IN THE LITERATURE ACCOMPANYING THE APPLIANCE.

How to use this manual

This manual is divided into four sections, Preparations, Operations, Remote Control, and Additional Information.

Preparations

Shows you how to connect your audio and video components to the receiver and prepare the surround processor.

Since this receiver works with all of your audio and video components, we will guide you in setting up your system to be as easy as possible.

Operations

Shows you how to operate the various functions available on the receiver.

Remote Control





Shows you how to operate other components using the remote control, as well as a detailed explanation of all remote control operations. Once you have registered your components with the proper setup codes, you'll be able to operate both this receiver and your other AV components (TV, VCR, DVD player, CD player, etc.) using the remote control supplied with this receiver.

Additional Information

Shows you additional information such as "In case of difficulty" (troubleshooting) and "Specifications".

Contents

Caution : Read the pages marked  carefully to ensure safe operation.

Preparations	 Before applying the power 2
	 Safety precautions 2
	How to use this manual 2
	Unpacking 3
	Preparing the remote control 4
	Special features 5
	Names and functions of parts 6
	Main Unit 6
	Remote control unit (RC-R0626) (VR-705/ KRF-V4070D/V5570D) and (RC-R0625) (VR-715/KRF-V5070D) 7
	Setting up the system 8
	Connecting audio components 9
	Connecting video components 10
	Digital connections 11
	Connecting a DVD player (6-channel input) (For VR-715/KRF-V5070D only) 12
	Connecting the speakers 13
Connecting the terminals 14	
Connecting the antennas 14	
Connecting the system control 15	
Preparing for surround sound 16	
Speaker settings 16	
Operations	Normal playback 18
	Preparing for playback 18
	Listening to a source component 18
	Adjusting the sound 19
	Recording 20
	Recording audio (analog sources) 20
	Recording video 20
	Recording audio (digital sources) 20
	Listening to radio broadcasts 21
	Tuning radio stations 21
	Presetting radio stations manually 21
	Receiving preset stations 22
	Receiving preset stations in order (P.CALL) ... 22
	Ambience effects 23
	Surround modes 23
Surround play 25	
DVD 6-channel playback (For VR-715/ KRF-V5070D only) 26	
Convenient functions 26	
Remote Control	Basic remote control operations for other components 28
	DVD player operation keys 28
	CASSETTE deck, CD player & MD recorder operations 29
Additional Information	 In case of difficulty 30
	 Specifications 32

Unpacking

Unpack the unit carefully and make sure that all accessories are present.

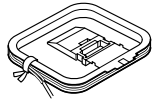
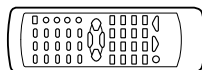
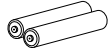
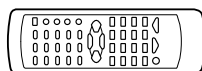
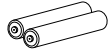
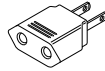
FM indoor antenna (1)	AM loop antenna (1)
	
For VR-705, KRF-V4070D and KRF-V5570D	
Remote control unit (1) RC-R0626	Batteries (R6/AA) (2)
	
For VR-715 and KRF-V5070D	
Remote control unit (1) RC-R0625	Batteries (R6/AA) (2)
	
*AC plug adapter (1)	*Use to adapt the plug on the power cord to the shape of the wall outlet. (Accessory only for regions where use is necessary.)
	

If any accessories are missing, or if the unit is damaged or fails to operate, notify your dealer immediately. If your unit was shipped to you directly, notify your shipper immediately. Kenwood recommends that you retain the original carton and packing materials in case you need to move or ship the unit in the future.

Keep this manual handy for future reference.

Maintenance of the unit

When the front panel or case becomes dirty, wipe with a soft, dry cloth. Do not use thinner, benzene, alcohol, etc. for these agents may cause discoloration.

In regard to contact cleaner

Do not use contact cleaner because it could cause a malfunction. Be specially careful not to use contact cleaners containing oil, for they may deform the plastic component.

Preparing the remote control

Loading the batteries

❶ Remove the cover.

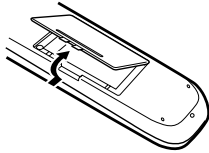

❷ Insert the batteries.

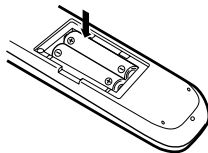

❸ Close the cover.

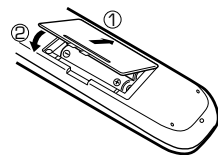

- Insert two AA-size (R6) batteries as indicated by the polarity markings.

Operation

When the **STANDBY** indicator is lit, the power turns ON when you press the **POWER** \downarrow key on the remote control. When the power comes ON, press the key you want to operate.

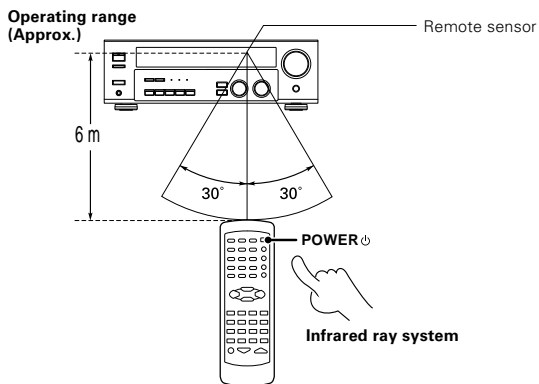

- When pressing more than one remote control key successively, press the keys securely by leaving an interval of 1 second or more between keys.

Notes

1. The supplied batteries may have shorter lives than ordinary batteries due to use during operation checks.
2. When the remote-controllable distance gets shorter than before, replace both batteries with new ones.
3. Placing the remote sensor in direct sunlight, or in direct light from a high frequency fluorescent lamp may cause a malfunction. In such a case, change the location of the system installation to prevent malfunction.

Channel space switching

(Except for the U.S.A., Canada and Australia)

The space between radio channels has been set to the one that prevails in the area to which the system is shipped. However, if the current channel space setting does not match the setting in the area where the system is to be used, for instance when you move from area 1 or area 2 shown in the following table or vice versa, proper reception of AM/FM broadcasts cannot be expected. In this case, change the channel space setting in accordance with your area by referring to the following table.

Area	CHANNEL Space Frequency
1. U.S.A., Canada and South American countries	FM: 100 kHz AM: 10 kHz
2. Other countries	FM: 50 kHz AM: 9 kHz

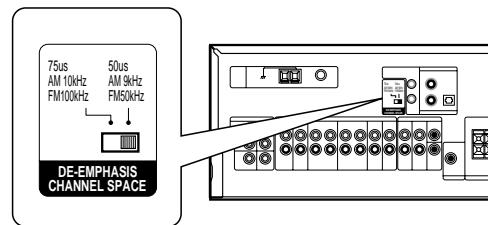

Turn the power OFF by pressing the POWER key before moving the switch level. Move the switch lever to match your area with a small screwdriver or other pointed tool, then turn the power ON again.

Memory back up function

Please note that the following items will be deleted from the unit's memory if the power cord is disconnected from the AC outlet for approximately 1 day.

- Power mode.
- Input selector settings.
- Picture output.
- Speaker ON/OFF.
- Volume level.
- BASS, TREBLE, INPUT level.
- TONE ON/OFF.
- LOUDNESS ON/OFF.
- Dimmer level.
- MD/TAPE settings.
- Listen mode setting.
- SP SYSTEM.
- Speaker settings.
- SUBWOOFER ON/OFF.
- SW RE-MIX ON/OFF.
- Distance setting.
- Input mode setting.
- Midnight mode setting.
- PRO LOGIC II mode setting.
- Broadcast band.
- Frequency setting.
- Preset stations.
- Tuning mode.
- ACTIVE EQ mode.
- DSP mode.

For the U.S.A.

FCC WARNING

This equipment may generate or use radio frequency energy. Changes or modifications to this equipment may cause harmful interference unless the modifications are expressly approved in the instruction manual. The user could lose the authority to operate this equipment if an unauthorized change or modification is made.

NOTE:

This equipment has been tested and found to comply with the limits for a Class B digital device, pursuant to Part 15 of the FCC Rules. These limits are designed to provide reasonable protection against harmful interference in a residential installation. This equipment may cause harmful interference to radio communications, if it is not installed and used in accordance with the instructions. However, there is no guarantee that interference will not occur in a particular installation. If this equipment does cause harmful interference to radio or television reception, which can be determined by turning the equipment off and on, the user is encouraged to try to correct the interference by one or more of the following measures:

- Reorient or relocate the receiving antenna.
- Increase the separation between the equipment and receiver.
- Connect the equipment into an outlet on a circuit different from that to which the receiver is connected.
- Consult the dealer or an experienced radio / TV technician for help.

For the U.S.A.

Note to CATV system installer

This reminder is provided to call the CATV system installer's attention to Article 820-40 of the NEC that provides guidelines for proper grounding and, in particular, specifies that the cable ground shall be connected to the grounding system of the building, as close to the point of cable entry as practical.



As an ENERGY STAR® Partner, Kenwood Corporation has determined that this product meets the ENERGY STAR® guidelines for energy efficiency. This product can save energy. Saving energy reduces air pollution and lowers utility bills.

Special features

True home theater sound

This receiver incorporates a wide variety of surround modes to bring you maximum enjoyment from your video software. Select a surround mode according to your equipment or the software you are going to play and enjoy!
— [23]

Dolby Digital

The DOLBY DIGITAL mode lets you enjoy full digital surround from software processed in the Dolby Digital format. Dolby Digital provides up to 5.1 channels of independent digital audio for better sound quality and more powerful presence than conventional Dolby Surround.

Dolby PRO LOGIC II

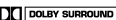
DOLBY PRO LOGIC II, whilst totally compatible with its predecessor PRO LOGIC, provides greater advantages in surround sound. It allows user to enjoy the conventional stereo or Dolby Surround with a convincing "5.1 like" presentation. PRO LOGIC II offers special features for controlling the overall spatial, dimensionality and frontal sound field imaging. PRO LOGIC II produces an impressive surround sound from video software marked  and three-dimensional space from music CD. When listening to music, you will be able to enjoy the experience of sheer STEREO surround sound.

DTS

DTS (Digital Theater System) is a 5.1 channel digital audio format that provides five full-spectrum channels and one low-frequency (subwoofer) channel for unprecedented clarity, optimum channel separation and a (wide) dynamic range.

In the DTS mode, the 5.1 channel digital input from a DTS CD, LD or DVD disc (carrying the "DTS" marking) can be played in Digital Surround.

Important:

When a DTS disc is played on a CD, LD or DVD player, noise may be output from the analog output. It is recommended that you connect the digital output of the player to the digital input of this unit.

DSP surround modes

The DSP (Digital Signal Processor) used for this receiver incorporates a variety of high quality adjustable sound fields, like "ARENA", "JAZZ CLUB", "THEATER", "STADIUM" and "DISCO". It is compatible with almost any kind of program source.

DVD 6-channel input (For VR-715/KRF-V5070D only)

If you own a DVD player equipped with 6-channel output, this receiver allows you to obtain the full surround sound impact of DVD source material featuring multi-channel encoding. Since the source signals are digital and each channel is input independently, the resulting ambience is far superior to what can be achieved with conventional surround sound systems.

ACTIVE EQ

ACTIVE EQ mode will produce a more dynamic sound quality in any condition. You can enjoy a more impressive sound effect when ACTIVE EQ is turned on during Dolby Digital and DTS playback.

IR (InfraRed) remote control

In addition to the basic receiver operations, this IR remote control supplied can also operate Kenwood cassette deck, MD recorder or CD player which are connected using the system control cords.

This remote control can also control Kenwood DVD players directly without using the DVD players' remote control.

Names and functions of parts

Main Unit

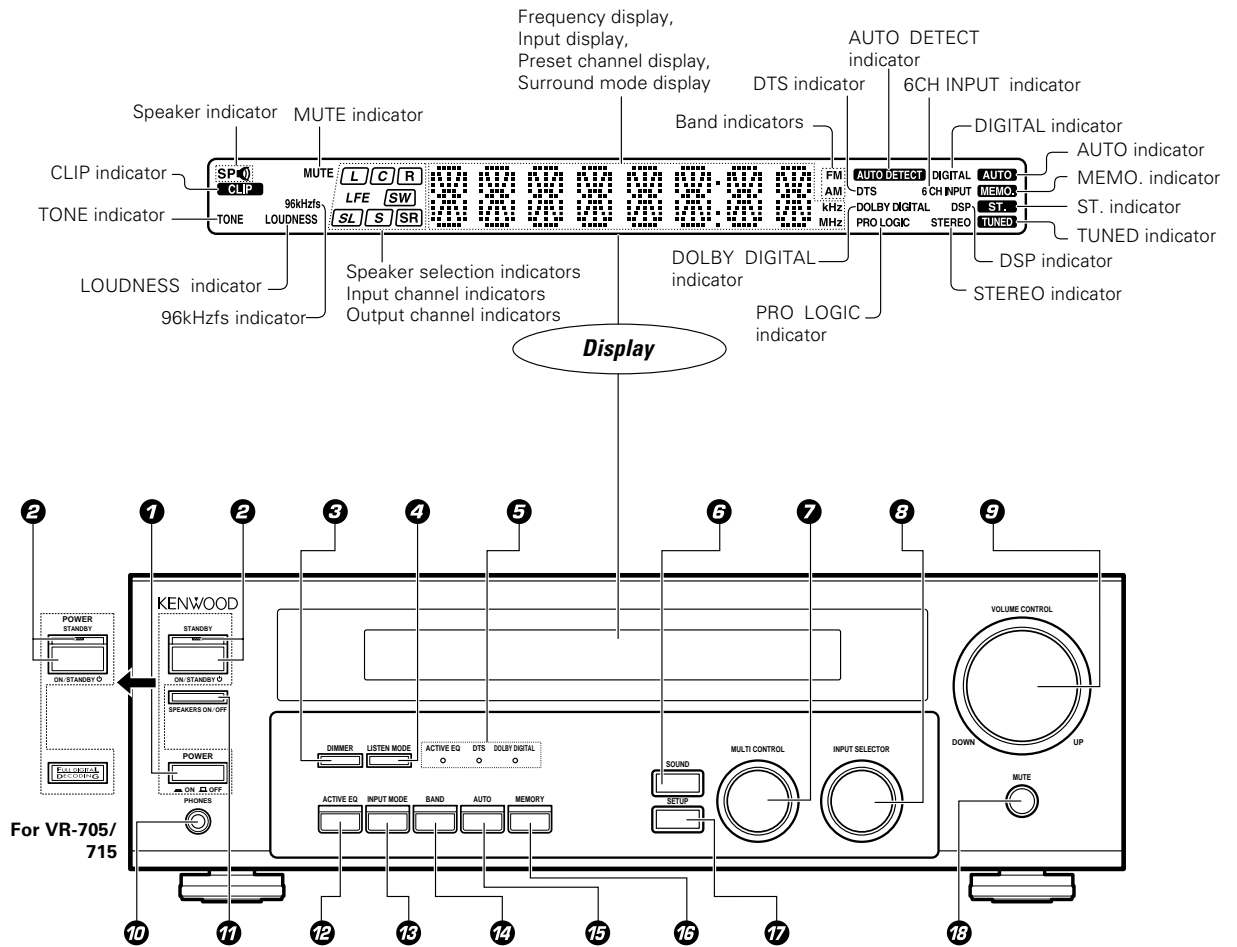

- 1 POWER ON/OFF key** (For KRF-V5070D/V4070D/V5570D) Use to turn the main power ON/OFF. - 16
- 2 ON/STANDBY key** (For KRF-V5070D/V4070D/V5570D) Use to switch the power ON/STANDBY when the POWER is turned ON. **STANDBY indicator** - 16
- 3 POWER ON/STANDBY key** (For VR-705/715) Use to turn the power ON/STANDBY. **STANDBY indicator** - 16
- 4 DIMMER key** Use to select the REC MODE. - 20
Use to adjust the brightness of the display. - 27
- 4 LISTEN MODE key** Use to select the listening mode. - 25
- 5 Surround LED (light-emitting diode) indicators** **ACTIVE EQ mode LED indicator** - 19
Lights when the receiver is in the ACTIVE EQ mode. **DTS mode LED indicator** - 25
Lights when the receiver is in the DTS mode. **DOLBY DIGITAL mode LED indicator** - 25
Lights when the receiver is in the Dolby Digital mode.
- 6 SOUND key** - 26
Use to adjust the sound quality and the ambience effects.
- 7 MULTI CONTROL knob** - 16
Use to control a variety of settings.
- 8 INPUT SELECTOR knob** - 18
Use to select the input sources.
- 9 VOLUME CONTROL knob** - 18
- 10 PHONES jack** - 19
Use for headphone listening.
- 11 SPEAKERS ON/OFF key** - 18
Use to turn the speakers ON/OFF.
- 12 ACTIVE EQ key** - 19
Use to select ACTIVE EQ setting.
- 13 INPUT MODE key** - 8
Use to switch between full auto, digital and analog inputs.
- 14 BAND key** - 21
Use to select the broadcast band.
- 15 AUTO key** - 18
Use to change "TAPE" indication to "MD". - 18
Use to select the auto tuning mode. - 21
- 16 MEMORY key** - 21
Use to store radio stations in the preset memory.
- 17 SETUP key** - 16
Use to select the speakers' settings etc.
- 18 MUTE key** - 19
Use to temporarily mute the sound.

Standby mode

While the standby indicator is lit, a small amount of power is supplied to the system to back-up the memory. This is called standby mode. Under the condition, the system can be turned ON by the remote control unit.

Connection at POWER ON/OFF key (for KRF-V5070D/V4070D/V5570D)

The power in this equipment will not be completely cut off from the AC wall outlet when the main switch is turned OFF.

Remote control unit (RC-R0626) (VR-705/KRF-V4070D/V5570D) and (RC-R0625) (VR-715/KRF-V5070D)

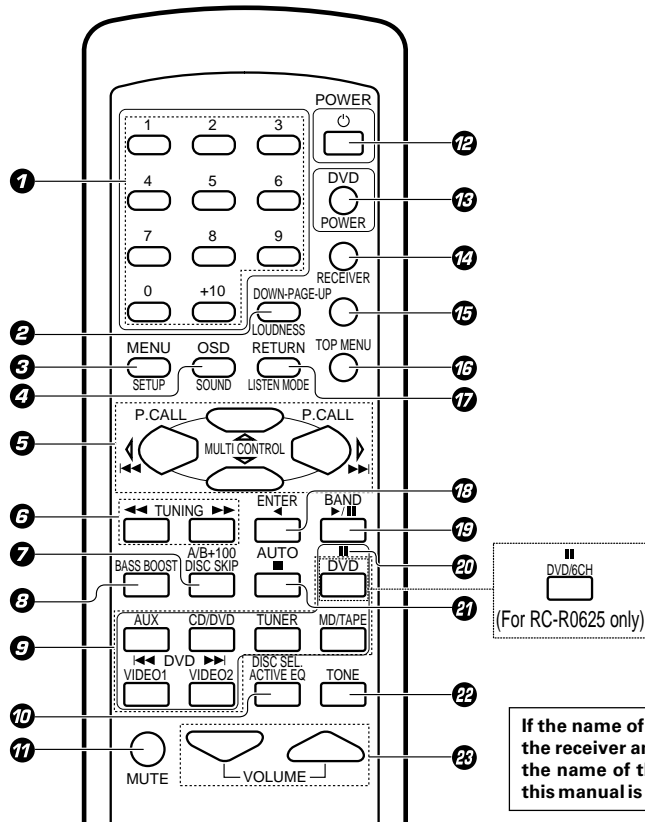

- 1 Numeric keys** - [22]
If CD or MD is selected as the input source, these keys function as numeric keys. If tuner is selected as the input source, these keys are used to call up station presets.
- 2 DOWN-PAGE- key**
Use to operate the DVD component.
- LOUDNESS key** - [19]
Use to switch the status of LOUDNESS.
- 3 MENU key**
Use to operate the DVD component.
- SETUP key** - [16]
Use to select the speakers' settings etc.
- 4 OSD (On Screen Display) key**
Use to operate the DVD component.
- SOUND key** - [26]
Use to adjust the sound quality and ambience effects.
- 5 MULTI CONTROL Δ/∇ keys** - [16]
Use to control a variety of settings.
Use to operate other components.
- P.CALL \leftarrow/\rightarrow keys** - [22]
If tuner is selected as the input source, these keys function as preset channel call keys.
- \leftarrow/\rightarrow keys**
If CD or MD is selected as the input source, these keys function as skip keys.
- 6 TUNING \leftarrow/\rightarrow keys**
Use to operate the tuner or selected component.
If CD, MD or TAPE is selected as the input source, these keys function as search keys.

- 7 A/B key**
If TAPE is selected as the input source, this is A and B deck of a double cassette deck.
- +100 key**
Use to select the disc number with the multi-CD player.
- DISC SKIP key**
If CD is selected as the input source, this key functions as the multi-CD player disc skip key.
- 8 BASS BOOST key** - [19]
Use to select the maximum adjustment setting for the low frequency range.
- 9 Input Selector keys [DVD or DVD/6CH (for RC-R0625 only), AUX, CD/DVD, TUNER, MD/TAPE, VIDEO 1, VIDEO 2]** - [18]
Use to select the input sources.
- \leftarrow DVD \rightarrow keys**
When in DVD player operations, these keys function as skip keys.
- 10 DISC SEL. key**
Use to operate other components.
- ACTIVE EQ key** - [19]
Use to select ACTIVE EQ setting.
- 11 MUTE key** - [19]
Use to temporarily mute the sound.
- 12 POWER ⏻ key**
Use to turn the receiver on and off.
- 13 DVD POWER key**
Use to turn on the DVD equipment.
- 14 RECEIVER key**
Use to return to the operation of the receiver.

- 15 -PAGE-UP key**
Use to operate the DVD component.
- 16 TOP MENU key**
Use to operate the DVD component.
- 17 RETURN key**
Use to operate the DVD component.
- LISTEN MODE key** - [25]
Use to select the listening mode.
- 18 ENTER key**
Use to operate other components.
- \blacktriangleleft key**
Use to operate other components.
- 19 BAND key** - [21]
Use to select the broadcast band.
- \blacktriangleright key**
If CD is selected as the input source, this key functions as the play/pause key.
If MD or TAPE is selected as the input source, this key functions as the play key.
- 20 || key**
Use to operate other components.
- 21 AUTO key** - [21]
Use to select the auto tuning mode.
- \blacksquare key**
If CD, MD or TAPE is selected as the input source, this key functions as the stop key.
- 22 TONE key** - [19]
Use to switch the status of TONE control.
- 23 VOLUME keys** - [18]
Use to adjust the receiver volume.

Setting up the system

Make connections as shown in the following pages. When connecting the related system components, be sure to refer to the instruction manuals supplied with the components you are connecting. Do not connect the power cord to a wall outlet until all connections are completed.

Notes

1. Be sure to insert all connection cords securely. If their connections are imperfect, the sound may not be produced or there will be noise interference.
2. Be sure to remove the power cord from the AC outlet before plugging or unplugging any connection cords. Plugging/unplugging connection cords without disconnecting the power cord can cause malfunctions and may damage the unit.
3. Do not connect power cords from components whose power consumption is larger than what is indicated on the AC outlet at the rear of this unit.

Analog connections

Audio connections are made using RCA pin cords. These cables transfer stereo audio signal in an "analog" form. This means the audio signal corresponds to the actual audio of two channels. These cables usually have 2 plugs at each end, red for the right channel and white for the left channel. These cables are usually packed together with the source unit, or are available at your local electronics retailer.

Microcomputer malfunction

If operation is not possible or an erroneous display appears, even though all connections have been made properly, reset the microcomputer by referring to "In case of difficulty". 

Input mode settings

CD/DVD, VIDEO2 and DVD or DVD/6CH (VR-715/KRF-V5070D only) inputs each include jacks for digital audio input and analog audio input.

After completing connections and turning on the receiver, follow the steps below.

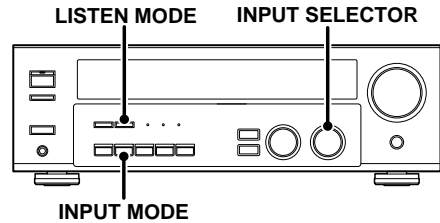

- 1 Use the **INPUT SELECTOR** knob to select **CD/DVD, VIDEO2, DVD or DVD/6CH (VR-715/KRF-V5070D only)**.

- 2 Press the **INPUT MODE** key.

Each press switches the setting as follows:

In DTS play mode

- 1 **F-AUTO** (digital input, analog input)
- 2 **D-MANUAL** (digital input)

In CD/DVD, VIDEO2, DVD or DVD/6CH (VR-715/KRF-V5070D only) play mode

- 1 **F-AUTO** (digital input, analog input)
- 2 **D-MANUAL** (digital input)
- 3 **6CH INPT** (DVD/6CH input)
- 4 **ANALOG** (analog input)

Digital input:

Select this setting to play digital signals from a DVD, CD, or LD player.

Analog input:

Select this setting to play analog signals from a cassette deck, VCR, or record player.

Auto detect:

In "**F-AUTO**" (full auto) mode (**AUTO DETECT** and **DIGITAL** indicators light up), the receiver detects the digital or analog input signals automatically. Priority is given to digital signal during input mode selection. The receiver will select the input mode and listening mode automatically during playback to match the type of input signal (Dolby Digital, PCM, DTS) and the speaker setting. The initial factory setting is full auto.

To keep the receiver set to the currently selected listening mode, use the **INPUT MODE** key to select "**D-MANUAL**" (digital manual). However, even when this setting is selected, there may be cases in which the listening mode is selected automatically to match a Dolby Digital source signal depending on the combination of listening mode and source digital.

In **D-MANUAL** mode, if the audio reproduction stops in the middle due to change in the input signals, etc, press the **LISTEN MODE** key.

If the **INPUT MODE** key is pressed quickly, sound may not be produced. Press the **INPUT MODE** key again.

Connecting audio components

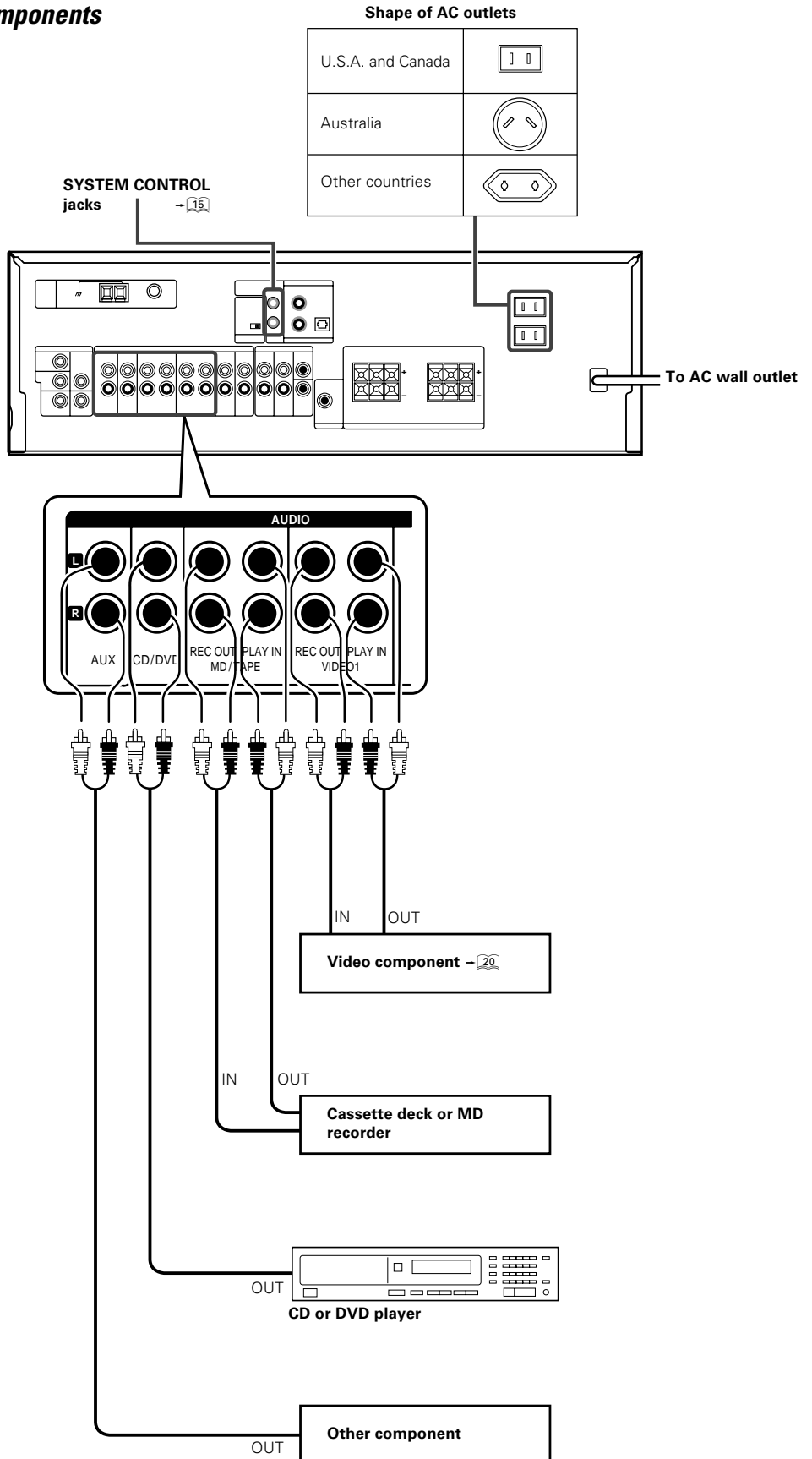

Connecting video components

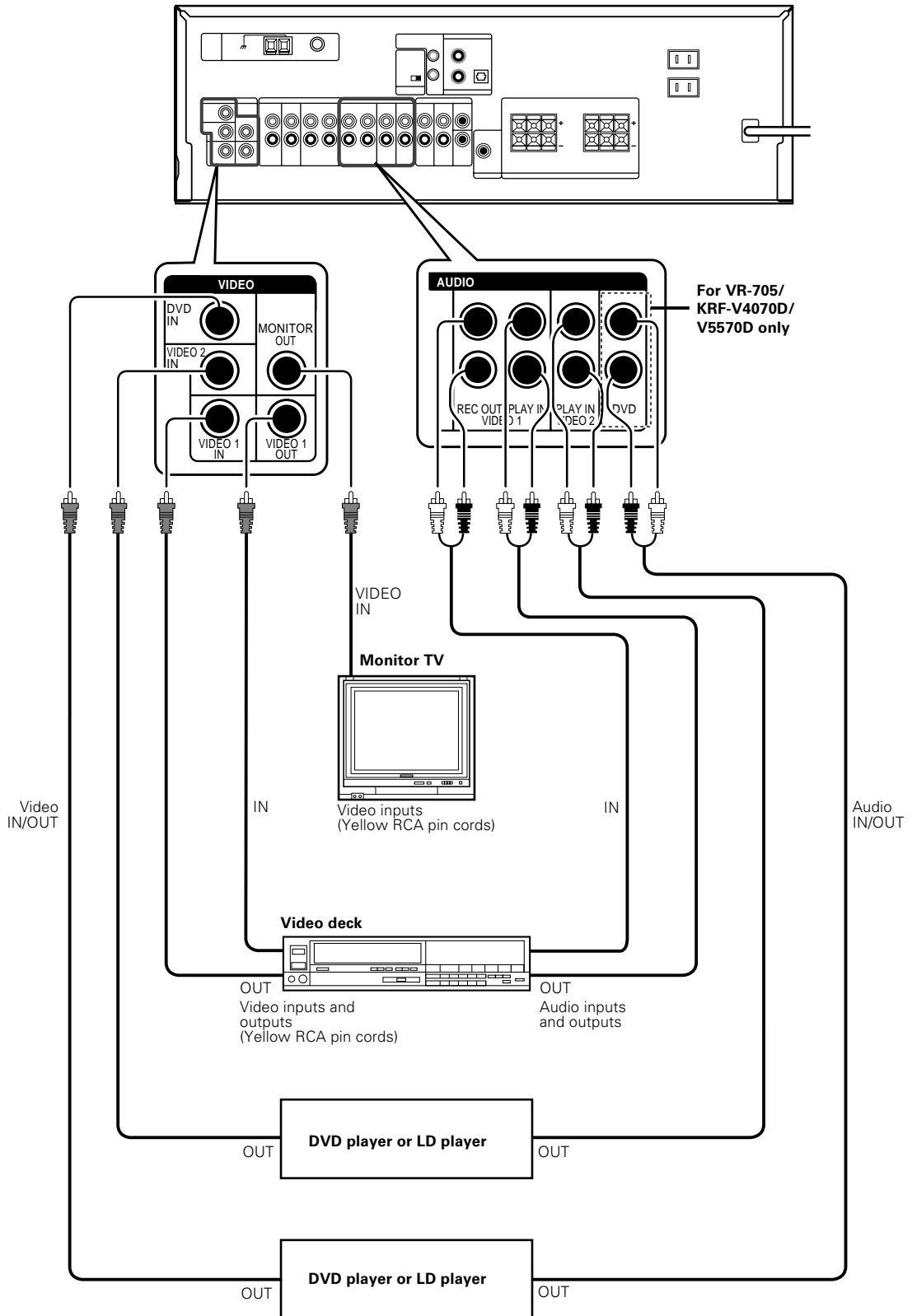

A video component with digital audio outputs should be connected to the VIDEO 2 jacks.

Digital connections

The digital in jacks can accept DTS, Dolby Digital, or PCM signals. Connect components capable of outputting DTS, Dolby Digital, or standard PCM (CD) format digital signals.

If you have connected any digital components to the receiver, be sure to read the "Input mode settings" section carefully.

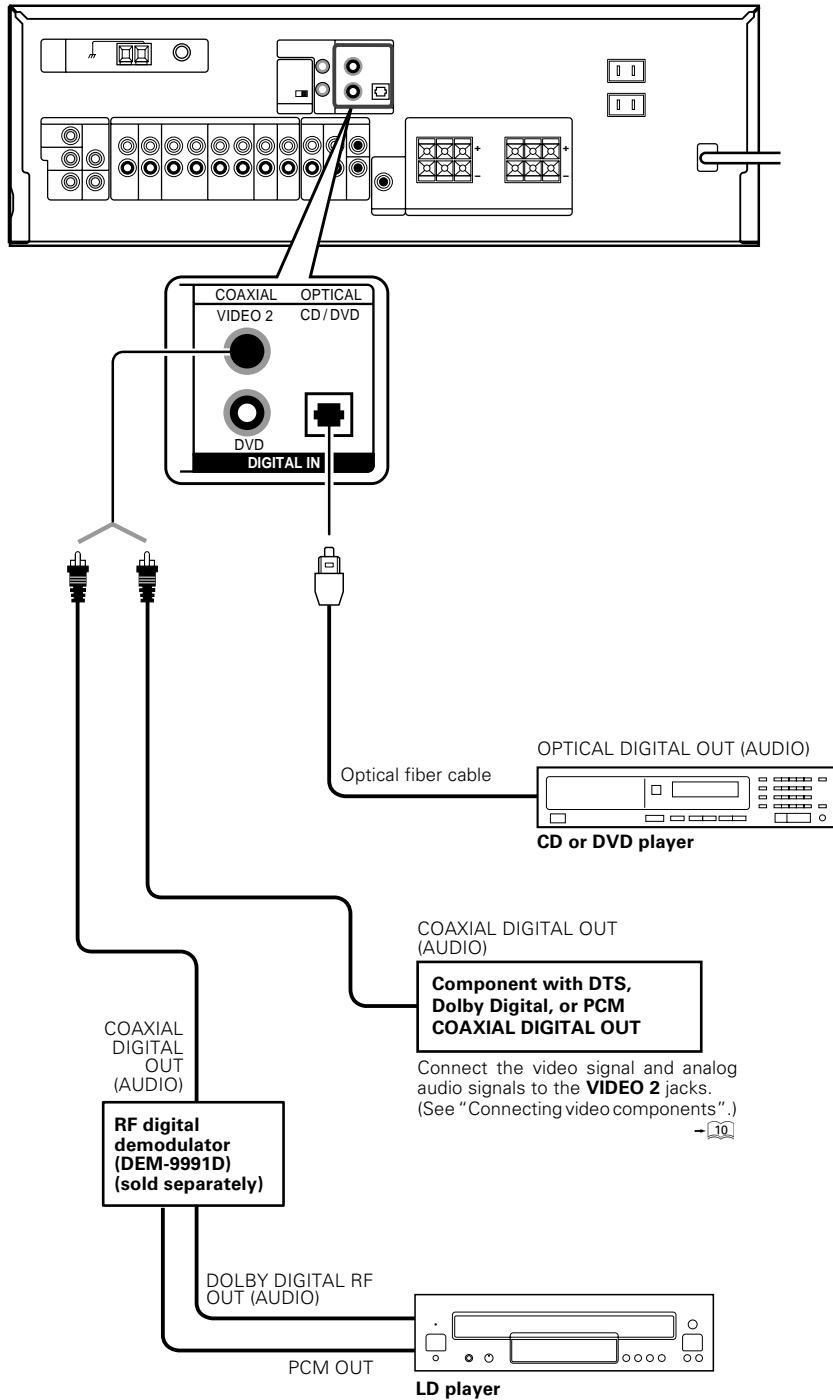

Component with DTS, Dolby Digital, or PCM COAXIAL DIGITAL OUT

Connect the video signal and analog audio signals to the **VIDEO 2** jacks. (See "Connecting video components".)



To connect an LD player with a DIGITAL RF OUT, connect the LD player to the KENWOOD RF digital demodulator (DEM-9991D). Next, connect the DIGITAL OUT jacks of the demodulator to the DIGITAL IN jacks of the receiver. Connect the video signal and analog audio signals to the VIDEO 2 jacks. (See "Connecting video components".)

Connecting a DVD player (6-channel input) (For VR-715/KRF-V5070D only)

If you have connected a DVD player to the receiver with digital connection, be sure to read the "Input mode settings" section carefully.

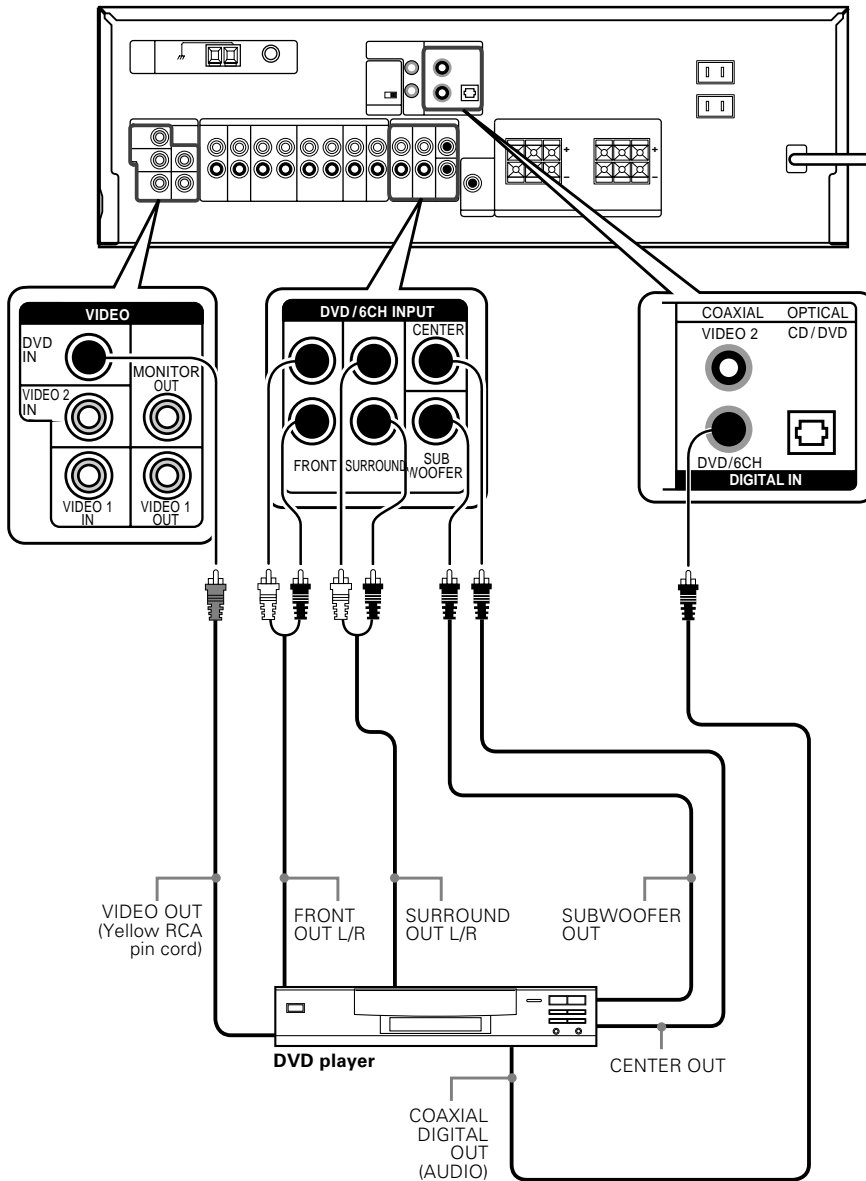

CAUTION

Be sure to adhere to the following, or proper ventilation will be blocked causing damage or fire hazard.

- Do not place any object impairing heat radiation onto the top of the unit.
- Leave a space around the unit (from the largest outside dimension including projection) equal or greater than, shown below.

Top panel : 50 cm

Side panel : 10 cm

Back panel : 10 cm

Connecting the speakers

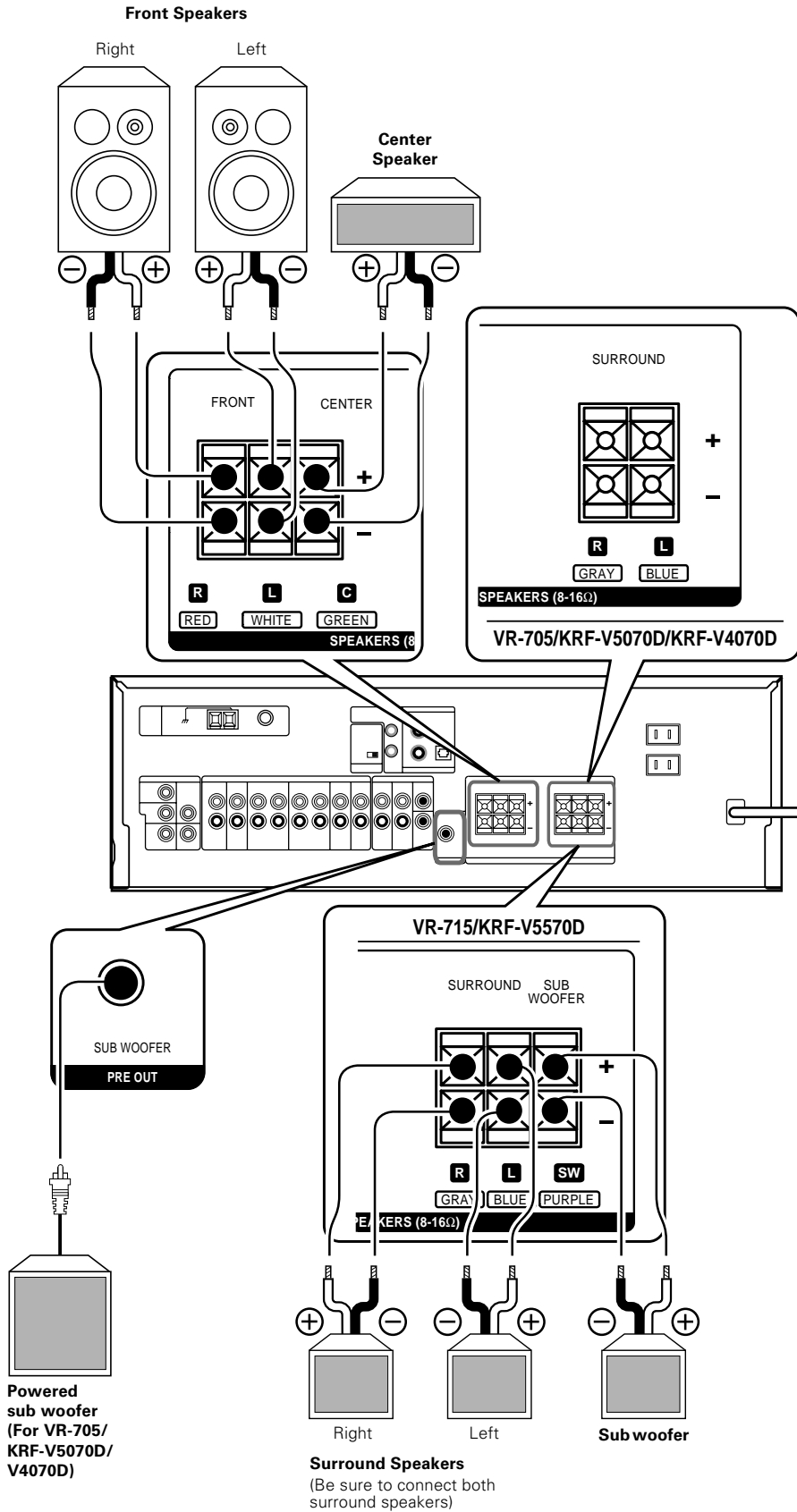

Connecting the terminals

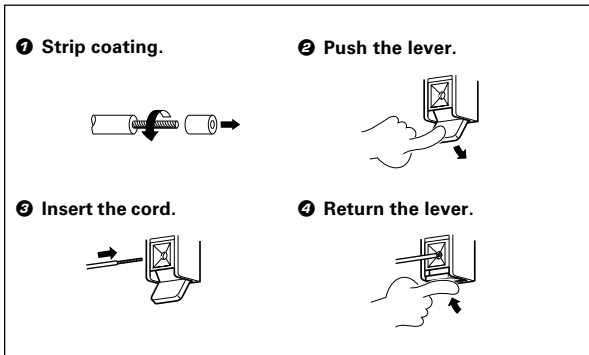

- Never short circuit the + and – speaker cords.
- If the left and right speakers are connected inversely or the speaker cords are connected with reversed polarity, the sound will be unnatural with ambiguous acoustic imaging. Be sure to connect the speakers correctly.

Speaker impedance

After confirming the speaker impedance indications printed on the rear panel of the receiver, connect speakers with matching impedance ratings. Using speakers with a rated impedance other than that indicated on the rear panel of the receiver could result in malfunctions or damage to the speakers or receiver.

Connecting the antennas

AM loop antenna

The supplied loop antenna is for use indoors. Place it as far as possible from the receiver, TV set, speaker cords and power cord, and adjust the direction for best reception.

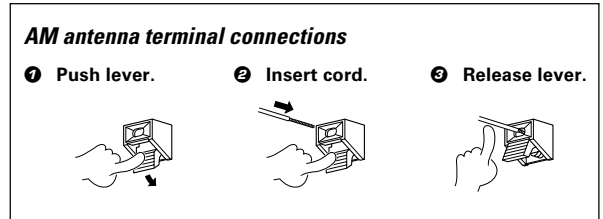

FM indoor antenna

The supplied indoor antenna is for temporary use only. For stable signal reception we recommend using an outdoor antenna. Disconnect the indoor antenna when you connect one outdoors.

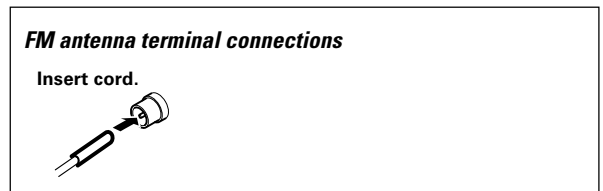

FM outdoor antenna

Lead the 75Ω coaxial cable connected to the FM outdoor antenna into the room and connect it to the FM 75Ω terminal.

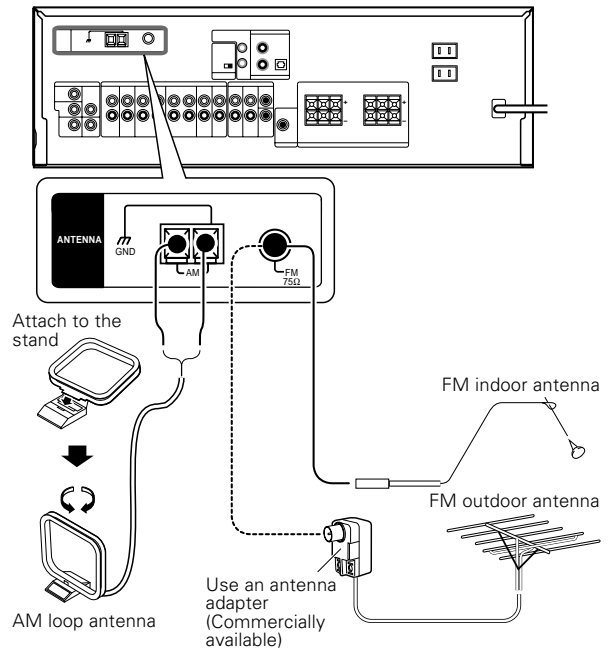

Connecting the system control

Connecting system control cords after connecting a KENWOOD audio component system lets you take advantage of convenient system control operations.

This unit is compatible only with the [SL16] mode. The system control operation is not available if the unit is connected in the [XS8], [XS], or [XR] connection mode.

If your component has the mode select switch, set the connected components to the [SL16] mode.

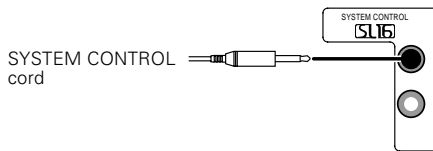

- You may connect the system control cord to either the up or down jack.

EXAMPLE: [SL16] mode connections

The underlined portion represents the setting of the system control mode.

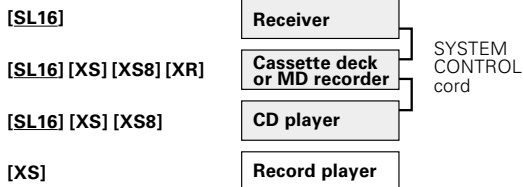

- In order to take advantage of the system control operations, the components must be connected to the correct jacks. To use a CD player it must be connected to the CD jacks. To use a cassette deck (or MD recorder) it must be connected to the MD/TAPE jacks. When using more than one CD player (etc.) only the one connected to the specified jacks may be connected for system control.
- Some CD players and cassette decks are not compatible with the [SL16] system control mode. Do not make system connections with equipment that is not [SL16] compatible.
- Some MD players are not system control compatible. You cannot make system control connections to this kind of equipment.

Notes

- [SL16] equipment cannot be combined with [XR], [XS], and [XS8] equipment for system operations. If your equipment consists of this kind of combination, please do not connect any system control cords. Even without system control cords, normal operations can be carried out without affecting performance.
- Do not connect system control cords to any components other than those specified by KENWOOD. It may cause a malfunction and damage your equipment.
- Be sure the system control plugs are inserted all the way in to the system control terminals.

SYSTEM CONTROL OPERATIONS

Remote Control

Lets you operate this unit with the system remote supplied with the receiver.

Automatic Operation

When you start playback from a source component, the input selector on this unit switches to that component automatically.

Synchronized Recording

Lets you synchronize recording with the start of playback when recording from CD, MD or analog discs.

Speaker placement

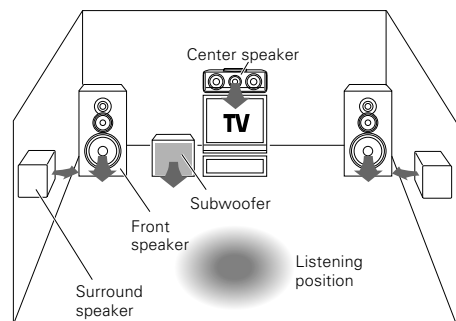

Front speakers : Place to the front left and right of the listening position. Front speakers are required for all surround modes.

Center speaker : Place front and center. This speaker stabilizes the sound image and helps recreate sound motion. Required for surround playback.

Surround speakers : Place to the direct left and right, or slightly behind, the listening position at even heights, approximately 1 meter above the ears of the listeners. These speakers recreate sound motion and atmosphere. Required for surround playback.

Subwoofer : Reproduces powerful deep bass sounds.

- Although the ideal surround system consists of all the speakers listed above, if you don't have a center speaker or a subwoofer, you can divide those signals between the available speakers in the speaker settings steps to obtain the best possible surround reproduction from the speakers you have available. - 16

Preparing for surround sound

Speaker settings

To enable you to obtain optimum enjoyment from the receiver's listening modes, make sure to complete the speaker settings (subwoofer, front, center, and surround speakers) as described below.

For Home Theater Box (HTB) model **VR-715**, do not select "LRG" (large) for front, center and surround speakers as this will cause the speakers to malfunction.

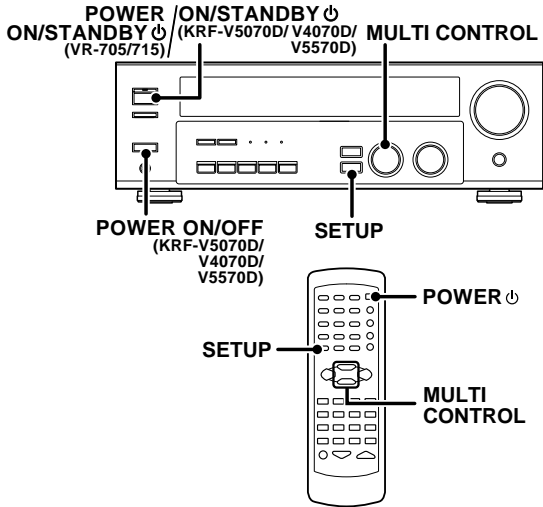

1 Turn on the power to this receiver by pressing **POWER ON/STANDBY** (for VR-705/715) or **POWER ON/OFF** and **ON/STANDBY** (for KRF-V5070D/V4070D/V5570D) or **POWER** key.

2 Press the **SETUP** key to enter the **SETUP** mode and use the **MULTI CONTROL** knob or keys for the following displays.

- 1 SP SETUP
- 2 TESTTONE
- 3 DISTANCE
- 4 EXIT

The flow of the SETUP is as follows;

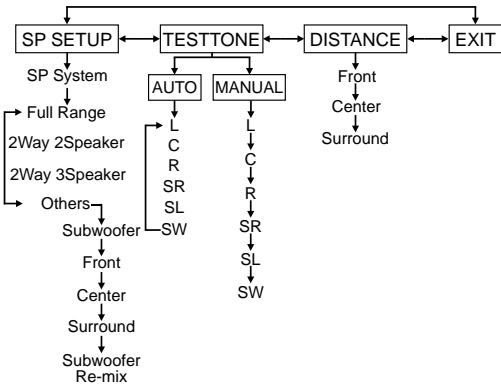

3 Select a speaker system.

1 Select **SP SETUP** and press the **SETUP** key again so that the speaker system indication "SP SYSTEM" scrolls across the display.

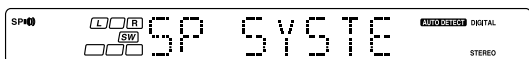

2 Use the **MULTI CONTROL** knob or keys to select the speaker system setting.

- 1 **FULL RANGE** : For selected Kenwood speaker – for example, KS-207HT.
- 2 **2WAY 2SPKR** : For selected Kenwood speaker – for example, KS-307HT.
- 3 **2WAY 3SPKR** : For selected Kenwood speaker – for example, KS-707HT.
- 4 **OTHERS** : For general speakers.

- When the setting **FULL RANGE**, **2WAY 2SPKR** or **2WAY 3SPKR** is selected, the procedure skips to step **4**.
- The initial setting for **VR-715** is **FULL RANGE**. For the other models, the setting is **OTHERS**.

3 For general speaker setting, use the **MULTI CONTROL** knob or keys to select **OTHERS** and press the **SETUP** key again.

- The subwoofer setting indication "SUBW ON" appears.



4 Use the **MULTI CONTROL** knob or keys to select the appropriate subwoofer setting.

- 1 **SUBW ON** : Subwoofer setting mode to the receiver is ON.
- 2 **SUBW OFF** : Subwoofer setting mode to the receiver is OFF.

- The initial setting is "SUBW ON".
- When the setting "SUBW OFF" is selected, the front speakers are automatically set to "FRNT LRG" and the procedure skips to step **5**.
- Before step **5**, press the **SETUP** key to accept the setting.
- When subwoofer output sound is required, select "FRNT NML".

5 Press the **SETUP** key to accept the setting.

- The front speakers setting indication "FRNT NML" appears.

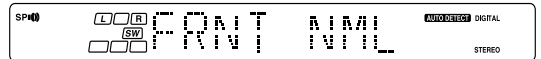

6 Use the **MULTI CONTROL** knob or keys to select the appropriate front speakers setting.

- 1 **FRNT NML** (normal) : Average size front speakers are connected to the receiver.
- 2 **FRNT LRG** (large) : Large front speakers are connected to the receiver.

- For **HTB** models, you are advised to select "NML" (normal) for the front speakers.
- For "FRNT LRG" selection, no sound will be heard from subwoofer speaker even when it is set to ON. However, if you select "SW RE-MIX ON" when subwoofer is selected, you will be able to hear sound from the subwoofer.
- When in **STEREO** mode, the sound goes directly to front speaker.

7 Press the **SETUP** key to accept the setting.

- The center speaker setting indication "CNTR NML" appears.

8 Use the **MULTI CONTROL** knob or keys to select the appropriate center speaker setting.

If you have selected "LRG" as the front speakers setting,

- 1 **CNTR NML** (normal) : An average size center speaker is connected to the receiver.
- 2 **CNTR LRG** (large) : A large center speaker is connected to the receiver.
- 3 **CNTR OFF** : Center speaker setting mode to the receiver is OFF.

- For **HTB** models, you are advised to select "NML" (normal) for the center speaker.

If you have selected "NML" as the front speakers setting,

- 1 **CNTR ON** : Center speaker setting mode to the receiver is ON.
- 2 **CNTR OFF** : Center speaker setting mode to the receiver is OFF.

9 Press the **SETUP** key again to accept the setting.

- The surround speaker setting indication "SURR NML" appears.

10 Use the MULTI CONTROL knob or keys to select the appropriate surround speaker setting.

If you have selected "LRG" as the center speaker setting,

- ① **SURR NML** (normal): Average size surround speakers are connected to the receiver.
- ② **SURR LRG** (large) : Large surround speakers are connected to the receiver.
- ③ **SURR OFF** : Surround speaker setting mode to the receiver is OFF.

- For HTB models, you are advised to select "NML" (normal) for the surround speakers.

If you have selected other than "LRG" as the center speaker setting,

- ① **SURR ON** : Surround speaker setting mode to the receiver is ON.
- ② **SURR OFF** : Surround speaker setting mode to the receiver is OFF.

11 Press the SETUP key again to accept the setting.

- The subwoofer re-mix setting indication "SW RE-MIX" scrolls across the display.



- If subwoofer is turned OFF, subwoofer re-mix setting is not visible.

12 Use the MULTI CONTROL knob or keys to select the appropriate subwoofer re-mix setting.

- ① **RMX ON** : Subwoofer re-mix set mode to the receiver is ON.
- ② **RMX OFF** : Subwoofer re-mix set mode to the receiver is OFF.

13 Press the SETUP key to accept the setting.

- The receiver enters the speaker volume level adjustment mode.
- In step 4 and 5, indications appear only for the selected channels of the speakers that require adjusting.

4 Adjust the speaker volume level.

From your usual listening position, adjust the volume levels. The volume levels from each speaker should be the same.

1 Press the SETUP key to begin TEST TONE.

The selection of AUTO/MANUAL TEST TONE is done by the MULTI CONTROL knob or keys.

- ① **AUTO**
- ② **MANUAL**

2 Press the SETUP key again to select either AUTO or MANUAL.

Use the MULTI CONTROL knob or keys to adjust the volume level of the test tone output from the speaker channel to be adjusted.

For AUTO selection, the test tone is heard from the speakers in the following sequence for 2 seconds each:

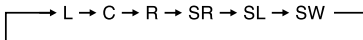

- If you change the volume level settings for the speakers while listening to music, the settings referred to on this page are also changed. - [26]
- If any of the speaker is set as OFF during SP SETUP, the TEST TONE adjustment for the speaker will be skipped.

3 Press the SETUP key.

- The test tone is turned off. The receiver enters the mode for inputting the distance to the speakers.

4 For MANUAL selection, press the SETUP key each time to select the speaker channel.

5 Input the distance to the speakers.

1 Select the DISTANCE from the set up displays and press the SETUP key again.

2 Measure the distance from the listening position to each of the speakers.

jot down the distance to each of the speakers.

- Distance to front speakers : ___ feet (meters)
- Distance to center speaker : ___ feet (meters)
- Distance to surround speakers : ___ feet (meters)

3 Use the MULTI CONTROL knob or keys to select the distance to the front speakers.

The speaker indicator to be adjusted blinks.



Indication in feet Indication in meters

- The allowable setting range is 1 to 30 feet (0.3m to 9.0m) , adjustable in 1 foot (0.3m) increments.

4 Press the SETUP key to accept the settings.

5 Repeat steps 3 and 4 to input the distance for each of the speakers.

6 Setup is complete when the EXIT indication appears.

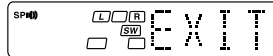

- The speakers you have selected should appear on the display. Confirm that all the speakers have been correctly selected.

7 Press the SETUP key to exit the SETUP mode.

Input level adjustment (analog sources only)

If the input level of an analog source signal is too high, the CLIP indicator will blink to indicate the source signal. Adjust the input level.

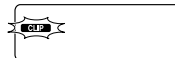

1 Use the INPUT SELECTOR knob to select the source of which the input level you want to adjust.

- You can store a separate input level for each input source.

2 Press the SOUND key repeatedly until the "INPUT" indication appears.

3 Use the MULTI CONTROL knob or keys to adjust the input level.



- The input level may be adjusted to any one of three settings: 0dB, -3dB, and -6dB. (The initial setting is 0dB.)

4 Press the SOUND key again to return to the input indication.

Normal playback

Preparing for playback

Some preparatory steps are needed before starting playback.

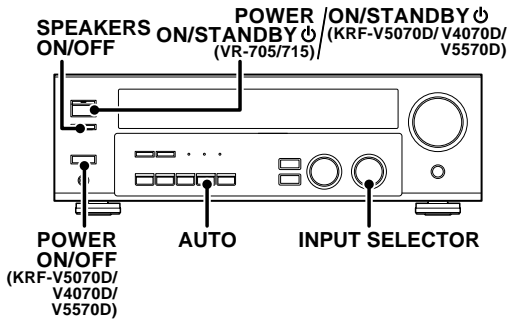

Turning on the receiver

- 1 Turn on the power to the related components.
- 2 Turn on the power to this receiver by pressing **POWER ON/STANDBY** (for VR-705/715) or **POWER ON/OFF and ON/STANDBY** (for KRF-V5070D/V4070D/V5570D) key.

Selecting the input mode

If you have selected a component connected to the **CD/DVD, VIDEO2, DVD or DVD/6CH (VR-715/KRF-V5070D only)** jacks, make sure that the input mode setting is correct for the type of audio signal to be used.



Selecting MD/TAPE

Select the source name corresponding to the component connected to the MD/TAPE jacks. The initial factory setting is "TAPE". To change the source to "MD", follow the steps below:

- 1 Use the **INPUT SELECTOR** knob to select "TAPE".
- 2 Hold down the **AUTO** key for more than 2 seconds.
 - The source indication changes to "MD".
 - To return to the original indication, repeat procedure 2.

Setting the speaker status

The speaker indicator lights up.

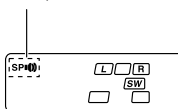

Press the **SPEAKERS ON/OFF** key to switch the speaker on or off.

Listening to a source component

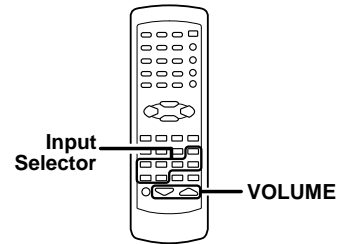
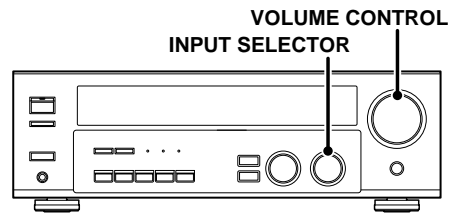

- 1 Use the **INPUT SELECTOR** knob or keys to select the source you want to listen to.

The input sources change as shown below:

- 1 "AUX"
- 2 "TUNER"
- 3 "CD/DVD"
- 4 "TAPE" or "MD"
- 5 "VIDEO1"
- 6 "VIDEO2"
- 7 "DVD" or "DVD/6CH" (for VR-715/KRF-V5070D only)

- 2 Start playback from the selected source.

- 3 Use the **VOLUME CONTROL** knob or **VOLUME** keys to adjust the volume.

Adjusting the sound

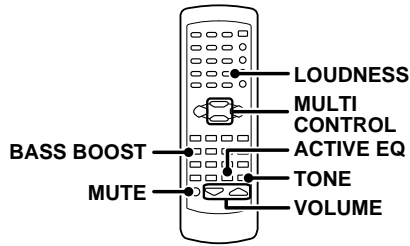
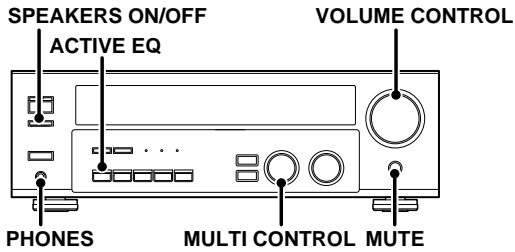

Adjusting the TONE (remote control only)

You can adjust the sound quality when the receiver is in the PCM stereo and analog stereo mode.

- 1 Press the **TONE** key to select the **TONE** mode.
- 2 Use the **MULTI CONTROL** knob or keys to select **TONE ON/OFF**.

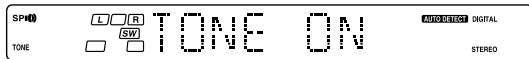

- 3 When in **TONE ON** selection, press the **TONE** key for the following displays.

BASS : Select this to adjust the low frequency range.
TREB : Select this to adjust the high frequency range.

- 4 Use the **MULTI CONTROL** knob or keys to adjust the sound quality.

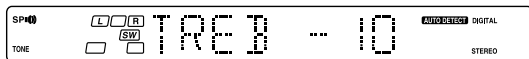

- The bass and treble levels are adjustable from -10 to +10 in 2 step increments.

Once-touch low frequency emphasis (BASS BOOST) (remote control only)

You can adjust the sound quality when the receiver is in the PCM stereo and analog stereo modes.

Press the **BASS BOOST** key.

- Press the key once to select the maximum (+10) low frequency emphasis setting.
- TONE will automatically be turned ON.
- This key does not function when the receiver is in the sound quality or ambience effects adjustment mode.

Switching back the previous setting

Press the **BASS BOOST** key again.

Adjusting the LOUDNESS mode (remote control only)

You can adjust the Loudness function which controls the low volume settings to maintain the music's richness. The adjustment can be made when the receiver is in the PCM stereo and analog stereo mode.

Press the **LOUDNESS** key to turn the **LOUDNESS** setting ON.

To cancel

Press the **LOUDNESS** key again so that the "LOUDNESS" indicator goes off.

Muting the sound

The **MUTE** key lets you mute the sound of the speakers.

Press the **MUTE** key.

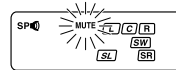

To cancel

Press the **MUTE** key again so that the "MUTE" indicator goes off.

- MUTE ON can also be deactivated by turning the volume control knob.

ACTIVE EQ mode

You can enjoy a more impressive sound effect when ACTIVE EQ is turned ON during Dolby Digital and DTS playback and, when in PCM and analog stereo mode

Press the **ACTIVE EQ** key for the following selections;

- 1 **ACTIVE EQ MUSIC** : Effective when listening to music. (The ACTIVE EQ LED indicator lights up.)
- 2 **ACTIVE EQ CINEMA** : Effective when watching a movie. (The ACTIVE EQ LED indicator lights up.)
- 3 **ACTIVE EQ TV** : Effective when watching TV. (The ACTIVE EQ LED indicator lights up.)
- 4 **ACTIVE EQ OFF** : The ACTIVE EQ function is turned OFF. (The ACTIVE EQ LED indicator goes off.)

- ACTIVE EQ function will not be available when REC MODE, AUTO TUNING or PRESET MEMORY is ON and during 96kHz LPCM playback.

Listening with headphones

- 1 Press the **SPEAKERS ON/OFF** key so that the speaker indicator goes off.

Make sure the SP indicator is turned OFF.



- If you turn off all of the speakers when in surround mode, the surround mode will be canceled as well, resulting in stereo playback.

- 2 Connect headphones to the **PHONES** jack.

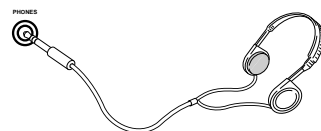

- 3 Use the **VOLUME CONTROL** knob or **VOLUME** keys to adjust the volume.

Recording

Recording audio (analog sources)

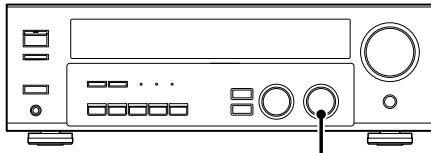

INPUT SELECTOR

Recording a music source

- 1 Use the INPUT SELECTOR knob to select the source (other than "MD/TAPE") you want to record.
- 2 Set the MD or TAPE recorder to record.
- 3 Start playback, then start recording.

Recording video

- 1 Use the INPUT SELECTOR knob to select the video source (other than "VIDEO1") you want to record.
- 2 Set the video deck connected to VIDEO 1 to record.
 - Select the REC MODE to record a digital input source.
- 3 Start playback, then start recording.
 - Recording may not be normal for some video software. This is due to the copy guard condition. - [30]

Recording audio (digital sources)

Switch on the **REC mode** to record a digital input source. Usually use the **A-REC (Auto-Record) mode** to record audio input sources. When the digital mode changes during recording in the **A-REC mode**, the audio input source may be interrupted momentarily.

Recording music in A-REC or M-REC mode

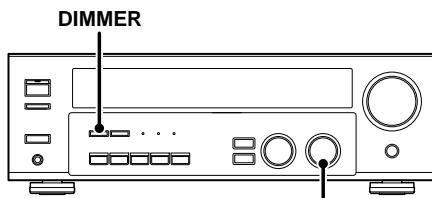

INPUT SELECTOR

- 1 Use the INPUT SELECTOR knob to select the source [CD/DVD, DVD or DVD/6CH (VR-715/KRF-V5070D only) or VIDEO2] you want to record.
- 2 Set the MD or TAPE recorder to record.

- 3 Press and hold the DIMMER key for more than 2 seconds to select the A-REC or M-REC mode during digital input.

- 1 **Rec mode off** : The digital input record mode is switched off.
- 2 **A-REC mode** : The digital input signals (DTS, Dolby Digital, or PCM) are identified automatically and converted into stereo signals that are ready for recording.
- 3 **M-REC mode** : The input signal type at the moment this mode is selected is held throughout this mode.

For A-REC mode:

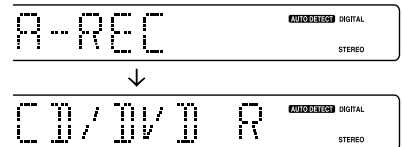

For M-REC mode:

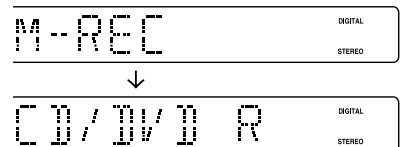

- 4 Start playback, then start recording.

- If the audio reproduction stops in the middle due to change in the input signals, etc., press the **DIMMER** key.

Listening to radio broadcasts

The receiver can store up to 40 stations in the memory and recall them by one-touch operation.

Tuning radio stations

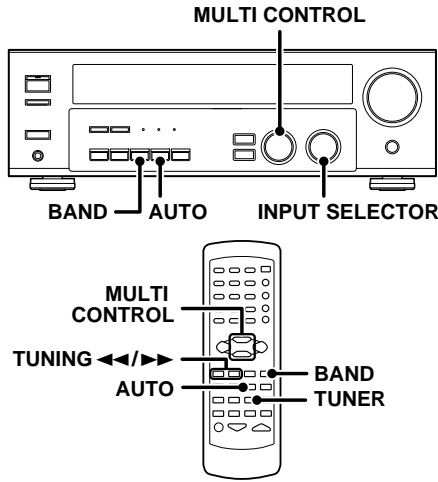

1 Use the **INPUT SELECTOR** knob or **TUNER** key to select the tuner.

2 Use the **BAND** key to select the desired broadcast band.

Each press switches the band as follows:

- ① FM
- ② AM

"AM" or "FM" indicator appears in the display

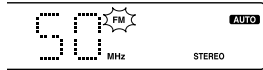

3 Use the **AUTO** key to select the desired tuning method.

Each press switches the tuning method as follows:

- ① **AUTO** lit (auto tuning)
- ② **AUTO** not lit (manual tuning)

"AUTO" indicator lights up in the display.

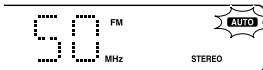

- Normally, set to "AUTO" (auto tuning). If the radio waves are weak and there is a lot of interference, switch to manual tuning. (With manual tuning, stereo broadcasts will be received in monaural.)

4 Use the **MULTI CONTROL** knob or keys, or **TUNING** ◀◀ / ▶▶ keys to select the station.

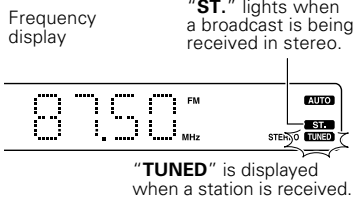

Auto tuning : The next station is tuned automatically.

Manual tuning : Turn the knob (press the key) to select the desired station.

Presetting radio stations manually

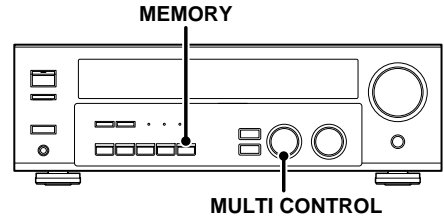

1 Tune to the station you want to store.

2 Press the **MEMORY** key while receiving the station.

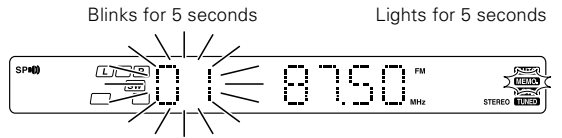

Proceed to step **3** within 5 seconds. (If more than 5 seconds elapse, press the **MEMORY** key again).

3 Use the **MULTI CONTROL** knob to select one of the station presets (1 – 40).

4 Press the **MEMORY** key again to confirm the setting.

- Repeat steps **1**, **2**, **3**, and **4** to store as many stations as necessary.
- If you store a station at a previously used preset, the previous station will be replaced by the new one.

Receiving preset stations

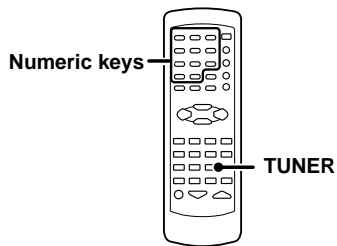

1 Press the **TUNER** key to select tuner as the source.

2 Enter the number of the preset station you want to receive (up to "40").

Press the numeric keys in the following order:

For "15", press **+10**, **5**

For "20", press **+10**, **+10**, **0**

• If you make a mistake entering a two digit number, press the +10 key repeatedly to return to the original display and start again.



Receiving preset stations in order (P.CALL)

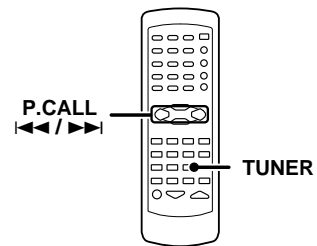

1 Press the **TUNER** key to select tuner as the source.

2 Use the **P.CALL** |◀◀/▶▶| key to select the desired station.

• Each time you press the key, another preset station is received in order.

Pressing the P.CALL ▶▶| does the following :

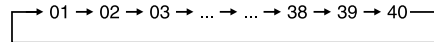

Pressing the P.CALL |◀◀ does the following :

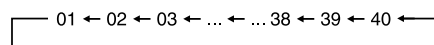

Holding down the ▶▶| or |◀◀ key, lets you skip through the presets, receiving each preset station at 0.5 second intervals.

Ambience effects

This receiver is equipped with listening modes that allow you to enjoy an enhanced sonic ambience with a variety of video sources.

In order to obtain the optimum effect from the surround modes, make sure to input the proper speaker settings beforehand.



Surround modes

The below speaker placements are for 5.1 channel surround sound system which are;

- Dolby Digital
- Dolby Pro Logic II
- DTS
- DSP
- DVD 6-channel (For VR-715/KRF-V5070D only)

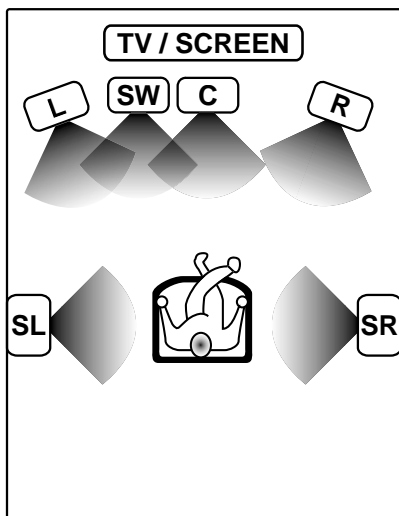

- | | |
|-----------|-------------------------------|
| L | Front left speaker |
| SW | Subwoofer |
| C | Center speaker |
| R | Front right speaker |
| SL | Surround left speaker |
| SR | Surround right speaker |

Manufactured under license from Dolby Laboratories. "DOLBY", the double-D symbol and "PRO LOGIC" are trademarks of Dolby Laboratories.

"DTS" and "DTS Digital Surround" are registered trademarks of Digital Theater Systems, Inc.



Dolby Digital

The Dolby Digital surround format lets you enjoy up to 5.1 channels of digital surround sound from Dolby Digital program sources (such as Laserdisc or DVD software marked ). Compared with previous Dolby surround, Dolby Digital provides even better sound quality, greater spatial accuracy, and improved dynamic range.

Although a full set of speakers (front left, right, and center, surround left and right, and a subwoofer) is required for true 5.1 channel Dolby Digital surround sound, this receiver lets you enjoy Dolby Digital (and Dolby Surround) program sources, even if you connect only the front speakers.

Although only Dolby Digital soundtracks incorporate a separate low frequency channel, connecting a subwoofer will also improve deep bass performance in the other surround modes.

The indication "LFE" appears in the display when a signal is being input for this channel.

Dolby PRO LOGIC II

Dolby Pro Logic II was designed specifically to provide a new sense of spatiality, directionality and articulation of sounds from Dolby Surround encoded sources (such as video and Laserdisc software marked ). This is achieved with an intelligent, built-in feedback logic design, a matrix surround decoding and the decoding of stereo, full bandwidth surround outputs. The PRO LOGIC II modes programmed into this receiver are "MOVIE", "MUSIC" and "PRO LOGIC". The "MOVIE" mode of the PRO LOGIC II has preset characteristics to produce a calibrated, high-level surround sound playback while the "MUSIC" mode has user-adjustable characteristics to offer the three optional controls, like "Dimension", "Center Width" and "Panorama" modes to allow optimization of the soundfields as desired. The "Dimension" control allows the user to gradually adjust the soundfield either towards the front or towards the rear; the "Center Width" control allows various adjustment of the left-center-right speakers' balance; the "Panorama" extends the front stereo image to include the surround speakers for an exciting "wraparound" effect with side wall imaging.

Note

LFE = Low Frequency Effects. This channel delivers separate non-directional bass signals to the subwoofer for more dynamic deep bass sound effects.

DTS mode

The DTS multi-channel audio format is available on CD, LD and DVD software. DTS is a strictly digital format and cannot be decoded inside most CD, LD or DVD players. For this reason, if you attempt to listen to DTS encoded software through the analog output of your new CD, LD or DVD player, you will experience digital noise in most cases. This noise can be quite loud if the analog output is connected directly to a high power amplification system. Proper measures for playing the digital output as described below should be taken to avoid this situation. To enjoy DTS Digital Surround playback, an external 5.1 channel DTS Digital Surround decoder system or an amplifier with a built-in DTS Digital Surround decoder must be connected to the digital output (S/P DIF, AES/EBU or TosLink) of a CD, LD or DVD player.

All models are incorporated with the DTS decoder.

DTS has a .1 or **LFE** channel.

The indication "**LFE**" appears in the display when a signal is being input for this channel. — [23]

DVD 6-channel mode (For VR-715/KRF-V5070D only)

Using a DVD player or the like equipped with six (5.1) output channels and the receiver, you can enjoy multi-channel encoded DVD source material in all its splendor. Since the source signals are digital and each channel is input independently, the resulting sound quality, sense of spaciousness, and dynamic range are superb.

The indication "**LFE**" appears in the display during DVD 6-channel mode selection. — [23]

DSP mode

The DSP mode lets you add the atmosphere of a live concert or hall to almost any type of program source. These modes are particularly effective when used with stereo program sources, like CD, television, and FM radio. You might enjoy trying the ARENA, JAZZ CLUB, THEATER, STADIUM or DISCO mode the next time you watch a concert or sporting event!

What's DSP?

DSP stands for Digital Signal Processor.

The way a sound is heard in an actual environment depends on a variety of different factors. One of the most important is reverberation (the act of decaying elements of sound echoing in various places).

The DSP modes produce the feeling of presence by using the DSP to create reverberation, without spoiling the sound quality of the original signal.

Surround play

The DTS compatible models can reproduce a CD, DVD, or LD carrying the DTS mark.

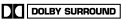
DOLBY DIGITAL can be used when playing DVD or LD software bearing the  mark and DOLBY DIGITAL format digital broadcasts (etc.). DOLBY PRO LOGIC can be used when playing video, DVD, or LD software bearing the  mark.

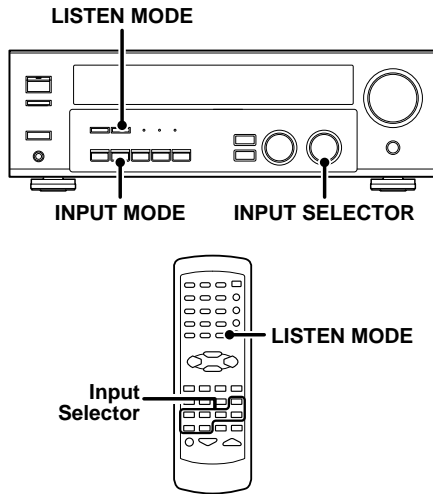

Preparations

- Turn ON related components.
- Complete "Preparing for surround sound" (speaker settings). -- 16
- Use the **INPUT SELECTOR** to select the component you wish to play back with surround sound.
- Use the **INPUT MODE** key to select the input mode (analog or digital) for the source you wish to playback. -- 8
- Noise will be produced when a DTS source is played by selecting the analog input.

1 Start playing the video software.

2 Press the LISTEN MODE key to select the listening mode.

The listening mode settings are stored separately for each input. If the input mode is set to full auto ("AUTO DETECT" lights), the receiver selects the optimal listening mode automatically based on the type of input signal and the speaker settings.

Each press of the LISTEN MODE key switches the setting as listed.

The listening mode settings are different depending on the type of input signal.

When the DOLBY DIGITAL signal is input:

(The DOLBY DIGITAL, PRO LOGIC, or STEREO indicator lights up.)

- ➔ ① **DOLBY DIGITAL** : DOLBY DIGITAL surround.
(The DOLBY DIGITAL LED indicator lights up.)
- ② **PL II MOVIE** : PRO LOGIC II surround MOVIE mode.
(The PRO LOGIC indicator lights up.)
- ③ **PL II MUSIC** : PRO LOGIC II surround MUSIC mode.
(The PRO LOGIC indicator lights up.)
- ④ **PRO LOGIC** : PRO LOGIC II surround PRO LOGIC mode.
(The PRO LOGIC indicator lights up.)
- ⑤ **STEREO** : Normal stereo playback.
(The STEREO indicator lights up.)

When you select DOLBY DIGITAL

"DOLBY DIGITAL" will scroll from right to left.

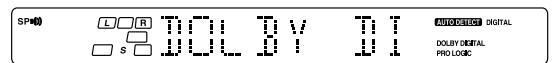

When the DTS signal is input:

(The DTS LED indicator lights up.)

- ➔ ① **DTS** : DTS surround
- ② **STEREO** : Normal stereo playback

When the analog signal or the digital signal (except for DOLBY DIGITAL or DTS signal) is input:

- ➔ ① **PL II MOVIE** : PRO LOGIC II surround MOVIE mode.
(The PRO LOGIC indicator lights up.)
- ② **PL II MUSIC** : PRO LOGIC II surround MUSIC mode.
(The PRO LOGIC indicator lights up.)
- ③ **PRO LOGIC** : PRO LOGIC II surround PRO LOGIC mode.
(The PRO LOGIC indicator lights up.)
- ④ **ARENA** : DSP Surround ARENA mode.
- ⑤ **JAZZ CLUB** : DSP Surround JAZZ CLUB mode.
- ⑥ **THEATER** : DSP Surround THEATER mode.
- ⑦ **STADIUM** : DSP Surround STADIUM mode.
- ⑧ **DISCO** : DSP Surround DISCO mode.
- ⑨ **STEREO** : Normal stereo playback.
(The STEREO indicator lights up.)

- Dolby Digital or DTS signal having more channels than the maximum number of playback channels available using the receiver's current settings is input, downmixing is performed to match the number of available channels.

3 Adjust the volume.

Notes

- Depending on the type of the signal or speaker setting, some listening modes cannot be selected.
- When playback is started, the sound may be cut or interrupted before the input source is confirmed as Dolby Digital.
- To enjoy Dolby Digital surround (as well as all the other listening modes) from a single component, be sure to use a Dolby Digital compatible source component.

DVD 6-channel playback (For VR-715/KRF-V5070D only)

Using a DVD player or the like equipped with six (5.1) output channels and the receiver, you can enjoy surround sound playback. Connecting a DVD player which can decode the surround signal itself is also acceptable.

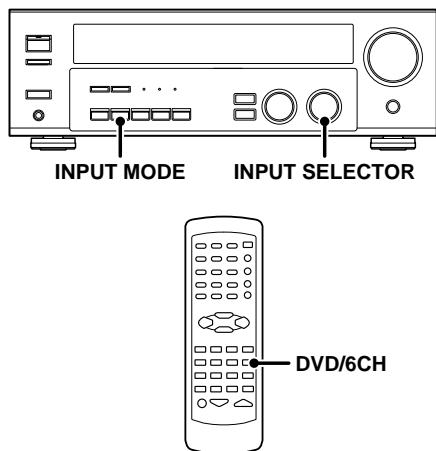

Preparations

- Connect your DVD player to the DVD/6CH jacks of the receiver.
- Turn on all other components that will be used.
- Complete "Preparing for surround sound".



1 Select "DVD/6CH" as the input source.

2 Select "6CH INPT" by pressing the INPUT MODE key.

3 Start playback of the DVD software.

4 Adjust the volume.

- It is not possible to adjust the volume level or sound quality (**SETUP, SOUND, LISTEN MODE, ACTIVE EQ and TONE keys will not be functional**) of the channels separately when the receiver is in the 6CH INPUT mode. Adjust the volume with the controls of the DVD player.
For the powered subwoofer, you can adjust the volume of the subwoofer using the subwoofer's own volume control.

Convenient functions

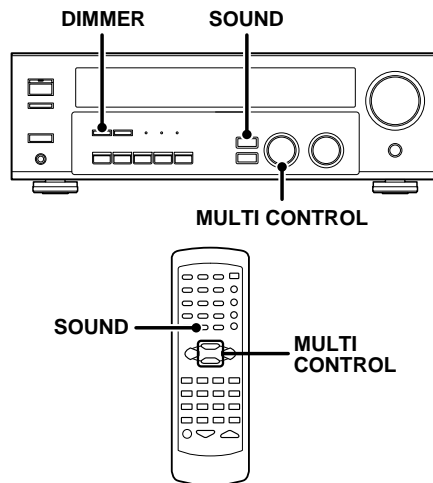

Adjusting the sound

You can make further adjustments to the sound while listening to playback in the surround mode.

1 Press the **SOUND** key until the desired item appears in the display.

**Each time you press the button, the menu changes as follows:
Note that some items are not displayed in certain modes.**

- ① **C** (center speaker level adjustment)*
- ② **SR** (right surround speaker level adjustment)*
- ③ **SL** (left surround speaker level adjustment)*
- ④ **SW** (subwoofer level adjustment)*
- ⑤ **INPUT** (input level adjustment - analog mode only) 
- ⑥ **NIGHT** (midnight mode ON/OFF - Dolby Digital mode only)
- ⑦ **PANORAMA** (panorama mode ON/OFF)**
- ⑧ **DIMENSION** (dimension adjustment)**
- ⑨ **CENTER WIDTH** (center width adjustment)**

* The adjustment is only temporary for the current input selection. The value will return automatically to the original setup value when the power is turned on/off or when the input selection is changed.

** Pro Logic II Music mode only.

2 Use the **MULTI CONTROL** knob or keys to adjust the setting as desired.

Midnight mode (Dolby Digital mode only)

When watching movies at night, you might not be able to raise the volume as loud as normal. Midnight mode compresses the dynamic range of previously specified heavy sound passage of the Dolby Digital sound track (like scenes with sudden increases in volume) to minimize the difference in volume between the scenes with heavy sound passage and scenes with normal sound passage. This makes it easy to hear all of the sound track, even when listening at low volumes.

1 Press the **SOUND** key repeatedly until "NIGHT" appears on the display.

- This can be selected only if CD/DVD, DVD or DVD/6CH (VR-715/KRF-V5070D only), or VIDEO2 is selected as the source and the listen mode is set to "DOLBY DIGITAL."

- ② Use the MULTI CONTROL knob or keys to select the ON or OFF setting.



- Some Dolby Digital software may not be compatible with the Midnight mode.

Panorama mode (Pro Logic II Music mode only)

When listening to music, you will be able to enjoy the “wraparound” sound effect when you adjust the panorama mode.

- ① Press the SOUND key repeatedly until “PANORAMA” appears on the display.

- The PANORAMA setting indication scrolls across the display.

“PANORAMA” will be scrolled from right to left.



- ② Use the MULTI CONTROL knob or keys to select PANORAMA ON or OFF.

- ① ON : PANORAMA mode is ON.
- ② OFF : PANORAMA mode is OFF.



Dimension mode (Pro Logic II Music mode only)

When listening to music with certain recordings, you will also be able to achieve a suitable balance from all the speakers by adjusting the dimension mode.

- ① Press the SOUND key repeatedly until “DIMENSION” appears on the display.

- The DIMENSION indication scrolls across the display.

- ② Use the MULTI CONTROL knob or keys to adjust the soundfield towards the rear or the front.

Soundfield is adjusted towards the front.



Soundfield is in neutral position.



Soundfield is adjusted towards the rear.



Center Width mode (Pro Logic II Music mode only)

Center Width adjustment allows you to enjoy an enhanced sound when listening to music through center image from only center speaker, or left and right speakers or various combinations adjustments.

- ① Press the SOUND key repeatedly until “CENTER WIDTH” appears on the display.

- The CENTER WIDTH indication scrolls across the display.
- When the center speaker is switched OFF, this mode will not be effective.

- ② Use the MULTI CONTROL knob or keys to adjust the left-center-right output.

Center image will be heard from center speaker only.

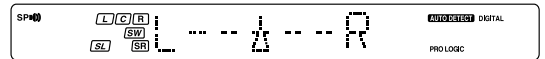

Center image will be heard from left and right speakers only.



- When in other positions, center image from center speaker, left and right speakers can be heard simultaneously with various combinations.

Display dimmer adjustment

The dimmer function lets you select the brightness of the receiver's display. You might find this useful if you darken your room to watch movies or listen to music.

Each time you press the DIMMER key, the display brightness changes among the three available settings. Select the brightness level you find most pleasing.

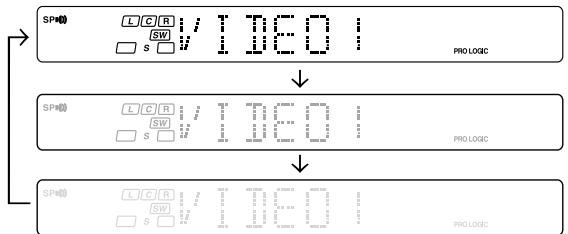

96kHz LPCM playback

The receiver is compatible with the 96kHz LPCM playback. To play a 96kHz DVD, set the listen mode to “STEREO”.

- In **F-AUTO** input mode, the listen mode will automatically be STEREO.
- When in **D-MANUAL** input mode (listen mode is not STEREO), “FS 96kHz” will appear in the display and no sound can be heard from the speakers. Press the LISTEN MODE key (the listen mode changes to the STEREO mode) to output sound from the speakers.

Basic remote control operations for other components

DVD player operation keys

The remote control of this unit can control two groups of KENWOOD DVD players directly without using the remote control supplied with the DVD player.

Group-1 : DV-4900, DV-4070B, DV-2070, DV-203, DVF-9010, DVF-K7010, DVF-5010, DVF-R9030, DVF-R7030, DVF-3530, DV-402, DV-5900, DV5700, DVF-R9050, DVF-J6050, DV-505, DV-503, DV-502, DVF-3550, DVF-3050, DVF-R4050, DVF-605, DV-6050, DVF-R5060, DVF-3060, DVF-3060K, DV-705, DVF-R5070 and DVF-3070.

Group-2 : DV-4050, DV-303, DVF-R6030, DVF-K5020, DVF-5020, DVF-3020 and DVF-3030.

Depending on your KENWOOD DVD model, you need to set up your receiver remote control as follows:

To set for Group-1 DVD players:

Press the numeric "1" key while pressing the "POWER ⏻" key (not the DVD Power key) on your remote control.

To set for Group-2 DVD players:

Press the numeric "2" key while pressing the "POWER ⏻" key (not the DVD Power key) on your remote control.

- If your DVD player is not listed in the list above, perform the set up for either Group-1 or Group-2. When the set up is successful, then your DVD player falls into that particular group.

How to operate the DVD player with the remote control

1. Pressing the DVD Power key for more than 2 seconds turns the DVD player on or off.
2. To carry out the functions of the DVD player, first press the DVD Power key, then press each key for each operation as explained in the DVD operation pages in the operating instructions. In this case, the DVD operation mode is retained for 15 seconds after pressing any of those DVD operation buttons.
(To turn the receiver operation mode within 15 seconds, press the RECEIVER key.)

DVD player operation keys

You can perform these basic operations using the keys described below when connected to KENWOOD DVD player.

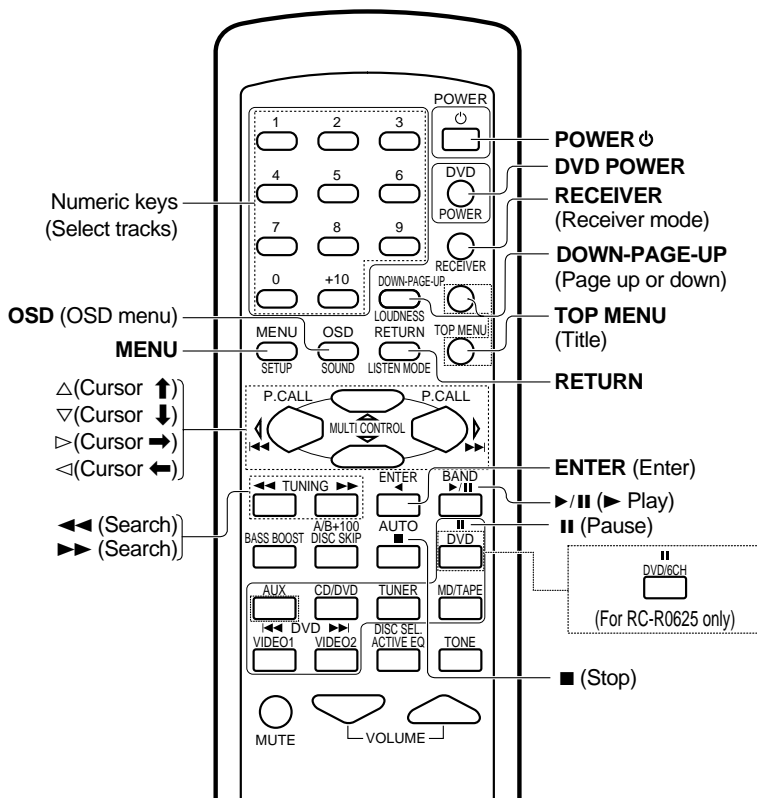

CASSETTE deck, CD player & MD recorder operations

You can perform these basic operations using the keys described below when connected to KENWOOD cassette deck, MD recorder or CD player equipped with system control operations. - 15

Cassette deck operations' keys

CD player operations' keys

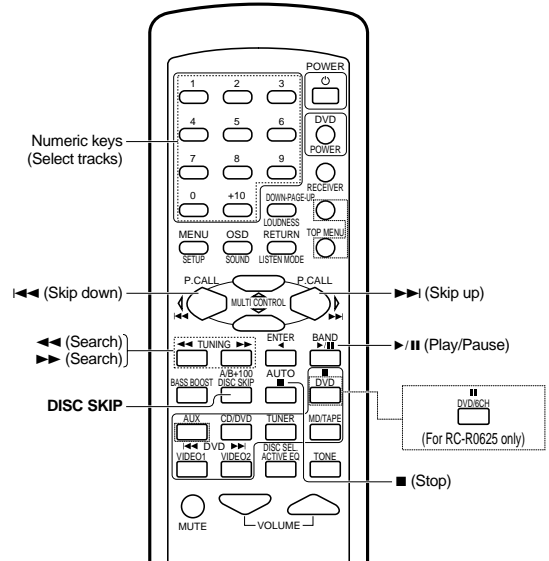
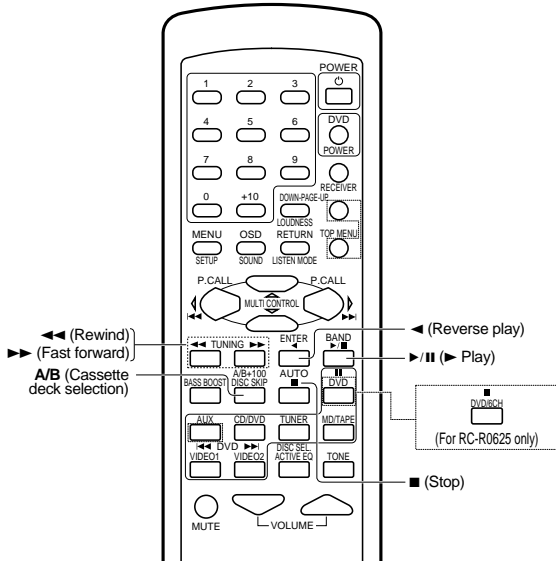

MD recorder operations' keys

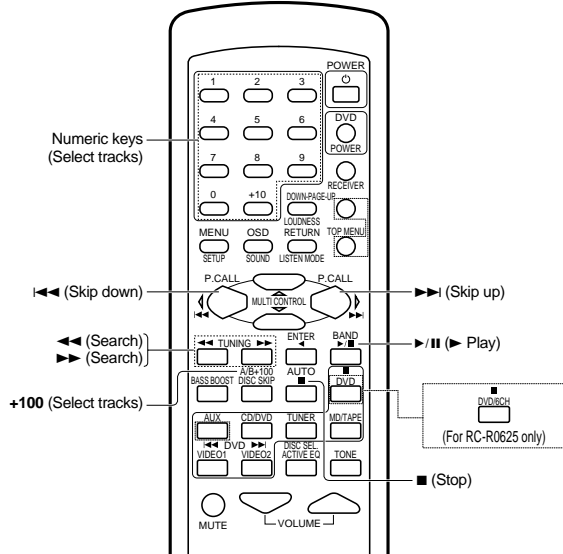

Notes

1. Certain codes may only operate some of the function available on a given model.
2. The pictures above show the typical functions available for each component. Some manufacturers use different key combinations to perform similar functions. For that reason, we have programmed extra functions on some of the unused number keys to help you control your equipment.

In case of difficulty

Resetting the Microcomputer

The microcomputer may malfunction (unit cannot be operated, or shows an erroneous display) if the power cord is unplugged while the power is ON, or due to some other external factor. If this happens, execute the following procedure to reset the microcomputer and return the unit to its normal operating condition.

- Please note that resetting the microcomputer will clear the contents of the memory and return the unit to the state it was in when it left the factory

For the U.S.A. and Canada

Unplug the power cord from the wall outlet, then plug it back in while holding down the POWER ON/STANDBY \cup key.

For other countries

With the power cord plugged in, turn the POWER ON/OFF key OFF. Then, while holding down the ON/STANDBY \cup key, press POWER ON/OFF key.

Amplifier

Symptom	Cause	Remedy
No sound from the speakers.	<ul style="list-style-type: none"> • The speaker cords are disconnected. • VOLUME is set to the minimum position. • MUTE is ON. • The SPEAKERS switches are set to OFF. 	<ul style="list-style-type: none"> • Connect them properly referring to "Connecting the speakers". → 13 • Adjust the volume to a proper level. • Turn OFF the MUTE. → 19 • Set the SPEAKERS switch to ON. → 18
The standby indicator blinks and sound is not output.	<ul style="list-style-type: none"> • Speaker cords are short-circuited. 	<ul style="list-style-type: none"> • Turn the power off, eliminate the short-circuiting, then turn on the power again.
Sound is not output from one of the speakers.	<ul style="list-style-type: none"> • The speaker cord is disconnected. 	<ul style="list-style-type: none"> • Connect it properly referring to "Connecting the speakers". → 13
Sound is not output from the surround speakers and / or the center speaker, or their sound is very soft.	<ul style="list-style-type: none"> • The surround speaker cords and/or the center speaker cord is disconnected. • A surround mode has not been activated. • The surround and/or center volume controls are set to the minimum level. 	<ul style="list-style-type: none"> • Connect it properly referring to "Connecting the speakers". → 13 • Select a surround mode. • Adjust the speaker levels using the test tone. → 17
When playing a Dolby Digital source signal using a DVD player, the sound is cut off soon after it starts.	<ul style="list-style-type: none"> • There are many possible causes for this problem, depending on the type of DVD player used. 	<ul style="list-style-type: none"> • Set the input mode to digital manual before starting playback of the Dolby Digital source. → 8
No sound is produced during playback from a DVD player.	<ul style="list-style-type: none"> • The input mode is set to digital manual. 	<ul style="list-style-type: none"> • Press the INPUT MODE key to select to full auto mode. → 8
A video source cannot be recorded normally.	<ul style="list-style-type: none"> • The software is copy-guarded. 	<ul style="list-style-type: none"> • Copy-guarded video software cannot be recorded.

Tuner

Symptom	Cause	Remedy
Radio stations cannot be received.	<ul style="list-style-type: none"> • No antenna is connected. • The broadcast band is not set properly. • The frequency of the desired station is not tuned. 	<ul style="list-style-type: none"> • Connect an antenna. → 14 • Set the broadcast band properly. • Tune the frequency of the desired station. → 21
Interference.	<ul style="list-style-type: none"> • Noise due to ignition of an automobile. • Noise due to interference from an electric appliance. • Noise due to a nearby TV set. 	<ul style="list-style-type: none"> • Install the outdoor antenna away from the road. • Turn off the power to the appliance. • Install the receiver farther away from the TV.
A station which was preset cannot be received by pressing the corresponding numeric key.	<ul style="list-style-type: none"> • The preset station belongs to a frequency that cannot be received. • The preset memory was cleared because the power cord had been unplugged for a long period of time. 	<ul style="list-style-type: none"> • Preset a station with a receivable frequency. • Preset the station again.

Remote control unit

Symptom	Cause	Remedy
Remote control operation is not possible.	<ul style="list-style-type: none">• The remote control is set to a different operation mode.• Batteries are exhausted.• The remote control unit is too far away from the main system, controlling angle is too large, or there is an obstacle between the receiver and the remote.• The audio cords and system control cords are not connected properly.• No tape or CD is placed in the source component.• An attempt is made to play a tape which is being recorded in the cassette deck.	<ul style="list-style-type: none">• Press the source select keys or DVD POWER keys to select the appropriate operation mode.• Replace with new batteries.• Operate the remote control unit within the controllable range. • Connect properly referring to "Setting up the system".• Place the tape or CD in the source component which you want to play.• Wait for recording to complete.

Specifications

⚠ Caution : Read this page carefully to ensure safe operation.

For the U.S.A and Canada

AUDIO section (VR-705/715)

Rated power output during STEREO operation

100 watts per channel minimum RMS, both channels driven, at 8Ω from 40 Hz to 20 kHz with no more than 0.7% total harmonic distortion. (FTC)

Effective power output during SURROUND operation

FRONT (40 ~ 20 kHz, 0.7% T.H.D. at 8Ω one channel driven) 100 W + 100 W
 CENTER (40 ~ 20 kHz, 0.7% T.H.D. at 8Ω one channel driven) 100 W
 SURROUND (40 ~ 20 kHz, 0.7% T.H.D. at 8Ω one channel driven) 100 W + 100 W
 SUBWOOFER (80 Hz, 0.7% T.H.D. at 8Ω one channel driven) (VR-715) 100 W

Total harmonic distortion 0.05% (1 kHz, 50 W, 8Ω)

Frequency response

CD/DVD 20 Hz ~ 70 kHz, +0 dB, -3.0 dB

Signal to noise ratio (IHF'66)

CD/DVD, AUX, TAPE, VIDEO1, VIDEO2 95 dB

Input sensitivity / impedance

CD/DVD 550 mV / 47 kΩ

DVD/6CH INPUT (VR-715) 550 mV / 47 kΩ

Output level / impedance

TAPE REC 550 mV / 1 kΩ

PRE OUT (SUBWOOFER) (VR-705) 1.5 V / 2.2 kΩ

Tone control

BASS ±10 dB (at 100 Hz)

TREBLE ±10 dB (at 10 kHz)

Loudness control

VOLUME at -30dB level +8 dB (at 100 Hz)

For other countries

AUDIO section (KRF-V5070D/V5570D)

Rated power output during STEREO operation

100 watts per channel minimum RMS, both channels driven, at 8Ω from 40 Hz to 20 kHz with no more than 0.7% total harmonic distortion. (FTC)

Effective power output during SURROUND operation

FRONT (1 kHz, 0.7% T.H.D. at 8Ω one channel driven) 100 W + 100 W
 CENTER (1 kHz, 0.7% T.H.D. at 8Ω one channel driven) 100 W
 SURROUND (1 kHz, 0.7% T.H.D. at 8Ω one channel driven) 100 W + 100 W
 SUBWOOFER (80 Hz, 0.7% T.H.D. at 8Ω one channel driven) (KRF-V5570D) 100 W

Total harmonic distortion 0.05% (1 kHz, 50 W, 8Ω)

Frequency response

CD/DVD 20 Hz ~ 70 kHz, +0 dB, -3.0 dB

Signal to noise ratio (IHF'66)

CD/DVD, AUX, TAPE, VIDEO1, VIDEO2 95 dB

Input sensitivity / impedance

CD/DVD 550 mV / 47 kΩ

DVD/6CH INPUT (KRF-V5070D) 550 mV / 10 kΩ

Output level / impedance

TAPE REC 550 mV / 1 kΩ

PRE OUT (SUBWOOFER) (KRF-V5070D) 1.5 V / 2.2 kΩ

Tone control

BASS ±10 dB (at 100 Hz)

TREBLE ±10 dB (at 10 kHz)

Loudness control

VOLUME at -30dB level +8 dB (at 100 Hz)

AUDIO section (KRF-V4070D)

Effective power output during STEREO operation

1 kHz, 0.7% T.H.D. at 8Ω 50 W + 50 W

Rated power output during STEREO operation

40 watts per channel minimum RMS, both channels driven, at 8Ω from 40 Hz to 20 kHz with no more than 0.7% total harmonic distortion. (FTC)

Effective power output during SURROUND operation

FRONT (1 kHz, 0.7% T.H.D. at 8Ω one channel driven) 50 W + 50 W

CENTER (1 kHz, 0.7% T.H.D. at 8Ω one channel driven) 50 W
 SURROUND (1 kHz, 0.7% T.H.D. at 8Ω one channel driven) 50 W + 50 W

Total harmonic distortion 0.15% (1 kHz, 20 W, 8Ω)

Frequency response

CD/DVD 20 Hz ~ 70 kHz, +0 dB, -3.0 dB

Signal to noise ratio (IHF'66)

CD/DVD, AUX, TAPE, VIDEO1, VIDEO2 95 dB

Input sensitivity / impedance

CD/DVD 400 mV / 47 kΩ

Output level / impedance

TAPE REC 400 mV / 1 kΩ

PRE OUT (SUBWOOFER) 1.5 V / 2.2 kΩ

Tone control

BASS ±10 dB (at 70 Hz)

TREBLE ±10 dB (at 10 kHz)

Loudness control

VOLUME at -30dB level +8 dB (at 100 Hz)

DIGITAL AUDIO section

Sampling frequency 32 kHz, 44.1 kHz, 48 kHz, 96 kHz

Input level / impedance / wave length

Optical (-15 dBm ~ -21 dBm), 660 nm ±30 nm

Coaxial 0.5 Vp-p / 75 Ω

VIDEO section

VIDEO inputs / outputs

VIDEO (composite) 1 Vp-p / 75 Ω

FM tuner section

Tuning frequency range 87.5 MHz ~ 108.0 MHz

Usable sensitivity (MONO)

VR-705/715 1.3 μV (75 Ω) / 13.2 dBf (75 kHz DEV., SINAD 30 dB)

KRF-V5070D/V4070D/V5570D 1.6 μV (75 Ω) / 15.2 dBf (75 kHz DEV., SINAD 30 dB)

50dB quieting sensitivity

STEREO 28 μV (75 Ω) / 40.2 dBf

Total harmonic distortion (1 kHz)

MONO 0.5% (71.2 dBf input)

STEREO 0.7% (71.2 dBf input)

Signal to noise ratio (1 kHz, 75 kHz DEV.)

MONO 75 dB (71.2 dBf input)

STEREO 68 dB (71.2 dBf input)

Stereo separation (1 kHz)

STEREO 40 dB

Selectivity (±400 kHz) VR-705/715

KRF-V5070D/V4070D/V5570D 70 dB

Frequency response (30 Hz ~ 15kHz), +0.5 dB, -3.0 dB

AM tuner section

Tuning frequency range

10 kHz step (VR-705/715) 530 kHz ~ 1,700 kHz

10 kHz step (KRF-V5070D/V4070D/V5570D) 530 kHz ~ 1,610 kHz

9 kHz step (KRF-V5070D/V4070D/V5570D) 531 kHz ~ 1,602 kHz

Usable sensitivity (30% mod., S/N 20dB) (VR-705/715)

..... 16 μV / (600 μV/m)

Usable sensitivity (KRF-V5070D/V5570D/V4070D) .16 μV / (600 μV/m)

Signal to noise ratio (30% mod. 1 mV input) 50 dB

GENERAL

Power consumption VR-705/715 2.2 A

KRF-V5070D/V5570D 280W

KRF-V4070D 200W

AC outlet

SWITCHED

VR-705/715 (total 150 W, 1.25 A max.)

KRF-V5070D/V4070D/V5570D (total 90 W max.)

Dimensions W : 440 mm (17-5/16")

H : 143 mm (5-5/8")

D : 303 mm (11-15/16")

Weight (Net)

VR-705/715 8.7 kg (19.18 lb)

KRF-V5070D/V4070D/V5570D 9.3 kg (20.50 lb)

Notes

1. KENWOOD follows a policy of continuous advancements in development. For this reason specifications may be changed without notice.
2. The full performance may not be exhibited in an extremely cold location (under a water-freezing temperature).

KENWOOD

For your records

Record the serial number, found on the back of the unit, in the spaces designated on the warranty card, and in the space provided below. Refer to the model and serial numbers whenever you call upon your dealer for information or service on this product.

Model _____ Serial Number _____

Free Manuals Download Website

<http://myh66.com>

<http://usermanuals.us>

<http://www.somanuals.com>

<http://www.4manuals.cc>

<http://www.manual-lib.com>

<http://www.404manual.com>

<http://www.luxmanual.com>

<http://aubethermostatmanual.com>

Golf course search by state

<http://golfingnear.com>

Email search by domain

<http://emailbydomain.com>

Auto manuals search

<http://auto.somanuals.com>

TV manuals search

<http://tv.somanuals.com>