



website <http://www.lgservice.com>
e-mail <http://www.lgeservice.com/techsup.html>

LG

LG Floor Standing Type Air Conditioner

INSTALLATION MANUAL

IMPORTANT

- Please read this installation manual completely before installing the product.
- Installation work must be performed in accordance with the national wiring standards by authorized personnel only.
- Please retain this installation manual for future reference after reading it thoroughly.

P/No.: 3828A20025V

TABLE OF CONTENTS

OUT-LINE OF INSTALLATION

Safety Precautions	3
Installation of Indoor, Outdoor Unit	6
1) Selection of the best location.....	6
2) Indoor Unit Installation	8
3) Outdoor unit installation	8
4) Refrigerant amount	8
5) Installation guide at the seaside	9
6) Installation method procedure.....	10
7) Preparation of installation parts and tools	11
8) Preparation of piping.....	12
9) Connection of piping	13
10) Precautions in bending	13
11) Connecting the cable to the indoor unit	14
12) Connecting the piping to the outdoor unit.....	15
13) Connecting the cable to the outdoor unit.....	15
14) Power supply and wiring	16
15) Vacuum drying of the connecting pipes and the indoor unit.....	17
16) Form the pipe.....	18
Final Check and Test Run	19

Safety Precautions



To prevent injury to the user or other people and property damage, the following instructions must be followed.

- Incorrect operation due to ignoring instruction will cause harm or damage. The seriousness is classified by the following indications.

⚠ WARNING This symbol indicates the possibility of death or serious injury.

⚠ CAUTION This symbol indicates the possibility of injury or damage.

- Meanings of symbols used in this manual are as shown below.

	Be sure not to do.
	Be sure to follow the instruction.

⚠ WARNING

■ Installation

Do not use a defective or underrated circuit breaker. Use this appliance on a dedicated circuit.

- There is risk of fire or electric shock.

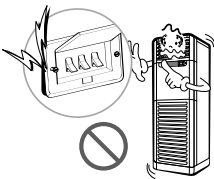

For electrical work, contact the dealer, seller, a qualified electrician, or an Authorized Service Center.

- Do not disassemble or repair the product. There is risk of fire or electric shock.



Always ground the product.

- There is risk of fire or electric shock.

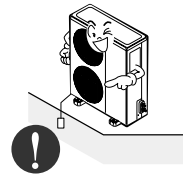

Install the panel and the cover of control box securely.

- There is risk of fire or electric shock.



Always install a dedicated circuit and breaker.

- Improper wiring or installation may cause fire or electric shock

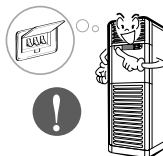

Use the correctly rated breaker or fuse.

- There is risk of fire or electric shock.



Do not modify or extend the power cable.

- There is risk of fire or electric shock.

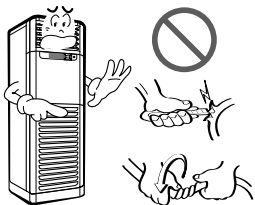

For installation, always contact the dealer or an Authorized Service Center.

- There is risk of fire, electric shock, explosion, or injury.

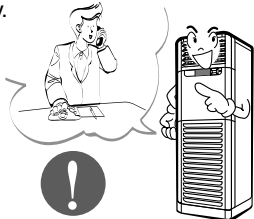

Be sure the installation area does not deteriorate with age.

- If the base collapses, the air conditioner could fall with it, causing property damage, product failure, and personal injury.

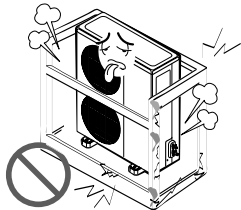

■ Operation

Do not store or use flammable gas or combustibles near the product.

- There is risk of fire or failure of product.

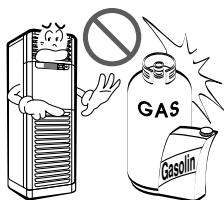

Be cautious when unpacking and installing the product.

- Sharp edges could cause injury. Be especially careful of the case edges and the fins on the condenser and evaporator.

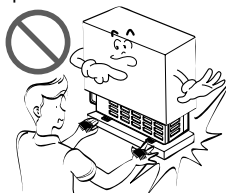

Do not install the product on a defective installation stand.

- It may cause injury, accident, or damage to the product.

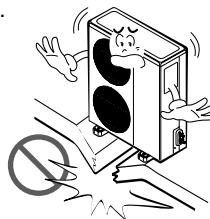

Do not let the air conditioner run for a long time when the humidity is very high and a door or a window is left open.

- Moisture may condense and wet or damage furniture.

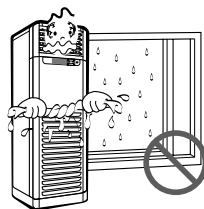

CAUTION

Installation

Always check for gas (refrigerant) leakage after installation or repair of product.

- Low refrigerant levels may cause failure of product.

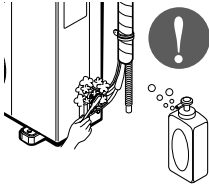

Install the drain hose to ensure that water is drained away properly.

- A bad connection may cause water leakage.

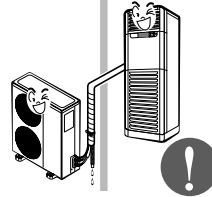

Keep level even when installing the product.

- To avoid vibration or water leakage.

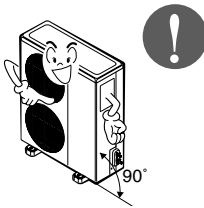

Do not install the product where the noise or hot air from the outdoor unit could damage the neighborhoods.

- It may cause a problem for your neighbors.

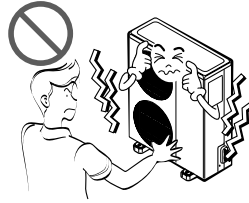

Use two or more people to lift and transport the product.

- Avoid personal injury.

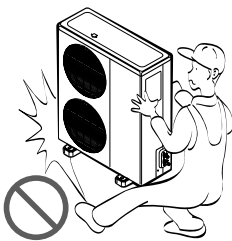

Do not install the product where it will be exposed to sea wind (salt spray) directly.

- It may cause corrosion on the product. Corrosion, particularly on the condenser and evaporator fins, could cause product malfunction or inefficient operation.

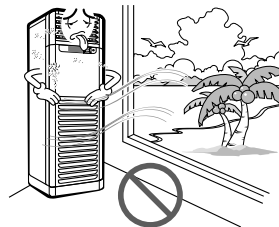

Installation of Unit

Selection of the best location

1. Indoor unit

- There should not be any heat source or steam near the unit.
- There should not be any obstacles to prevent the air circulation.
- A place where air circulation in the room will be good.
- A place where drainage can be easily obtained.
- A place where noise prevention is taken into consideration.
- Do not install the unit near the door way.
- Ensure the spaces indicated by arrows from the wall, ceiling, or other obstacles.
- The indoor unit must keep the maintenance space.

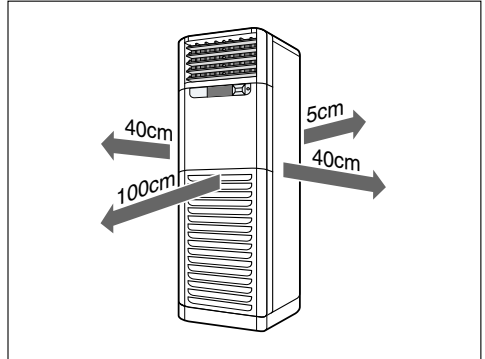

2. Outdoor unit

- If an awning is built over the unit to prevent direct sunlight or rain exposure, be careful that heat radiation from the condenser is not restricted.
- There should not be any animals or plants which could be affected by hot air discharged.
- Ensure the spaces indicated by arrows from the wall, ceiling, fence or other obstacles.

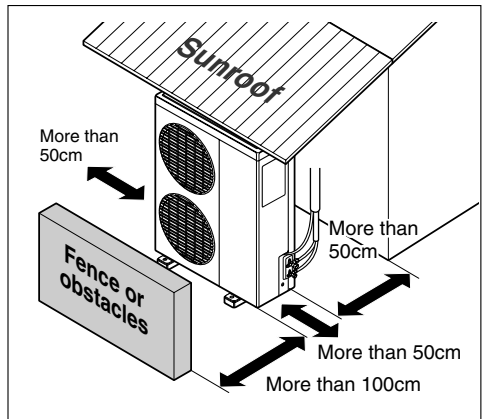

3. Piping length and the elevation

MODEL (BTU/h)	PIPE SIZE		Max. Length A (m)	Max. Elevation B (m)
	GAS SIDE	LIQUID SIDE		
20k/28k/30k/40k	5/8"	3/8"	30	20
44k/48k/50k/55k/60k	3/4"	3/8"	40	25
80k	1"	5/8"	50	30

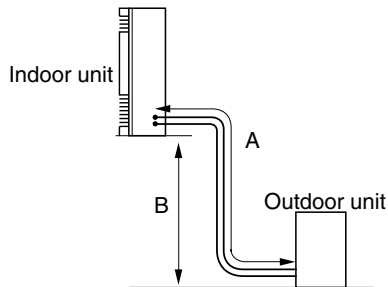

CAUTION:

- Capacity is based on standard length and maximum allowance length is on the basis of reliability.
- Oil trap should be installed every 5~7 meters.

The Indoor Unit Installation

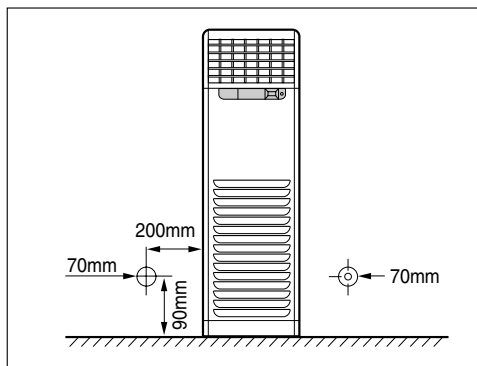

1. The mounting floor should be strong and solid enough to prevent it from vibration.
2. Drill the piping hole with 70mm diameter hole-core drill at either the right or the left of indoor unit. The hole should be slightly slant to the outdoor side.
3. Insert the plastic tube through the hole.
4. Cut the extruded outside part of the plastic tube, if necessary.

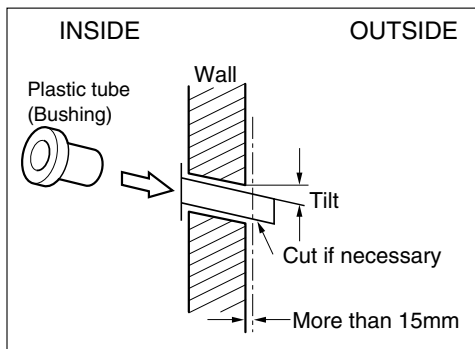
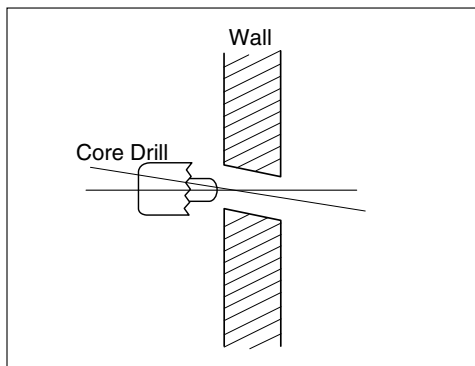

Outdoor unit Installation

1. Install the outdoor unit on the concrete or any solid base securely and horizontally by securing it with bolts (Ø12mm) and nuts.
2. If there is any vibration transmitted to the building, mount the rubber underneath the outdoor unit.

Refrigerant amount

Before shipment, this air conditioner is filled with the rated amount of refrigerant including additional amount required for air-purging, subject to 7.5m piping length. (The rated amount of refrigerant is indicated on the name plate.) But when the piping length exceeds 7.5 meters, additional charge is required according to the following table.

MODEL	REFRIGERANT CHARGE
20k/28k/30k/40k (BTU/h)	30g/m (1.06oz/m)
44k/48k/50k/55k/60k (BTU/h)	40g/m (1.41oz/m)
80k (BTU/h)	80g/m (2.82oz/m)

Example) 28k/30k

In case of 10m long pipe(one-way), the amount of refrigerant to be replenished is:

$$(10-7.5) \times 30 = 75g$$

$$(10-7.5) \times 1.06 = 2.65oz$$

Installation guide at the seaside

⚠ CAUTION

1. Air conditioners should not be installed in areas where corrosive gases, such as acid or alkaline gas, are produced.
2. Do not install the product where it could be exposed to sea wind (salty wind) directly. It can result in corrosion on the product. Corrosion, particularly on the condenser and evaporator fins, could cause product malfunction or inefficient performance.
3. If an outdoor unit is installed close to the seaside, it should avoid direct exposure to the sea wind. Otherwise, it needs additional anticorrosion treatment on the heat exchanger.

Selecting the location(Outdoor Unit)

1. If the outdoor unit is to be installed close to the seaside, direct exposure to the sea wind should be avoided. Install the outdoor unit on the opposite side of the sea wind direction.

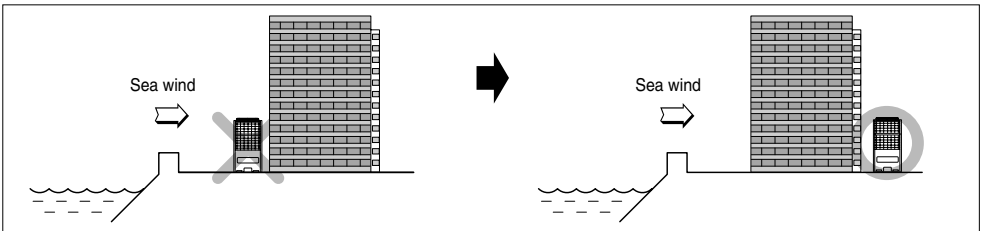

2. In case, to install the outdoor unit on the seaside, set up a windbreak not to be exposed to the sea wind.

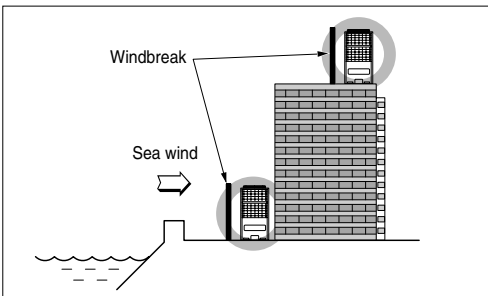

- It should be strong enough like concrete to prevent the sea wind from the sea.
- The height and width should be more than 150% of the outdoor unit.
- It should be kept more than 70 cm of space between the outdoor unit and the windbreak for easy air flow.

3. Select a well-drained place.

1. If you can't meet the above guide line in the seaside installation, please contact LG Electronics for the additional anticorrosion treatment.
2. Periodic (more than once/year) cleaning of the dust or salt particles stuck on the heat exchanger by using water.

Installation Method

No.	Installation works	Descriptions
1	Preparation of tools and installation parts	Preparation of installation
2	Flaring the pipes	To insert the flare nuts, mounted on the connection parts of both indoor and outdoor unit, onto the copper pipes.
3	Pipe bending	To reduce the flow resistance of refrigerant.
4	Connection of installation parts (elbows, socket etc)	Connection of long piping
5	Tighten the flare nut (outdoor)	Connecting the pipings of the outdoor unit.
6	Blowing the pipings	To remove dust and scale in working.
7	Tighten the flare nut (indoor)	Connecting the pipings of the indoor unit.
8	Check a gas-leakage of the connecting part of the pipings.	
9	Vacuum drying of the piping and indoor unit	The air which contains moisture and which remains in the refrigeration cycle may cause a malfunction on the compressor
10	Open the 3-way (liquid side) and 3-way (gas side) valves.	
11	Form the pipings	To prevent heat loss and sweat
12	Checking the drainage (indoor unit)	To ensure if water flow drain hose of indoor unit.
13	Connecting the cable between outdoor and indoor unit	Preparation of the operating
14	Connecting the main cable to outdoor unit	
15	Supply the power to the crankcase heater (Before the operating the unit)	To prevent the liquid back to the compressor. (Heat pump only)
16	Cooling operation (Use the remote control or display of the indoor unit)	

Preparation of installation parts and tools

No.	Installation Parts, Tools	Use
1	Flaring tool (Ø 6.35 - Ø 19.05)	Flaring the pipes
2	Remear	Remove burrs from cut edges of pipes.
3	Pipe cutter (MAX 35mm Copper pipe)	Cutting the pipings
4	Wrench (H5, H4 hexagonal wrench)	To open the service valve
5	Pipe bender	Bending the pipings
6	Leak detector	Check a gas-leakage of connecting part of the pipings
7	Manifold gauge	To measure the pressure, to charge the refrigerant
8	Charge-nipple	To connect the bombe
9	Vacuum pump	To remove the air in the pipe.
10	Charge cylinder balance	To measure the refrigerant amount
11	Bombe (Freon-22)	Gas charge Cleaning the pipe
12	Spanner	To tighten the connecting parts of the pipings
13	Monkey spanner	
14	Driver(⊕, ⊖)	
15	Benchi (150mm)	Cutting the wires
16	Tapeline	To measure the length
17	Core drill	To make holes through the concrete wall and blocks
18	Voltmeter, Amperemeter, Clampmeter	To measure the current and voltage
19	Insulation resistance tester	To measure the insulation resistance
20	Glass thermometer	To measure the intake and outlet air temperature of the indoor unit
21	Copper tubes	To use the connecting pipings
22	Insulation material	To cover the connecting pipings
23	Tape	To finish the connecting pipings
24	Electrical Leakage Breaker	To shut off the main power
25	Cable	To connect the cable from outdoor unit to indoor unit
26	Drain hose sockets, elbows	To remote the condensing water

Preparation of Piping

Main cause of gas leakage is defect in flaring work. Carry out correct flaring work in the following procedure.

1. Cut the pipes and the cable.

- Use the accessory piping kit or the pipes purchased locally.
- Measure the distance between the indoor and the outdoor unit.
- Cut the pipes a little longer than measured distance.
- Cut the cable 1.5m longer than the pipe length.

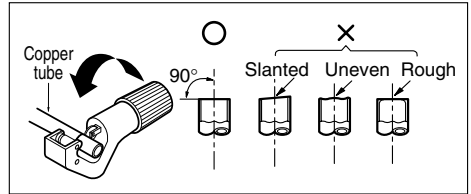

2. Burrs removal

- Completely remove all burrs from the cut cross section of pipe/tube.
- Put the end of the copper tube/pipe to downward direction as you remove burrs in order to avoid to let burrs drop in the tubing.

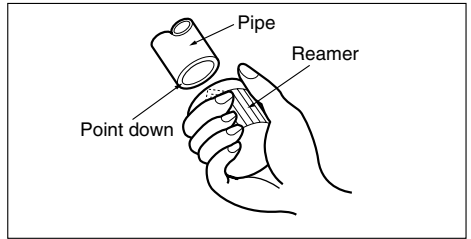

3. Putting nut on

- Remove flare nuts attached to indoor and outdoor units, than put them on pipe/tube having completed burr removal. (Not possible to put them on after flaring work)

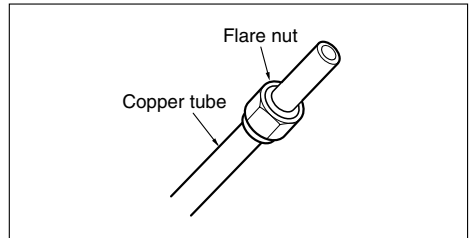

4. Flaring work

- Carry out flaring work using dedicated flaring tool for R-22 as shown below.

Outside diameter		A
mm	inch	mm
Ø6.35	1/4	1.1~1.3
Ø9.52	3/8	1.5~1.7
Ø12.7	1/2	1.6~1.8
Ø15.88	5/8	1.6~1.8
Ø19.05	3/4	1.9~2.1

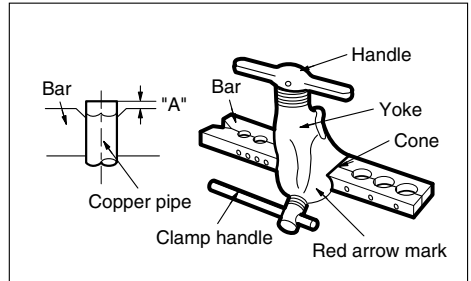

Firmly hold copper tube in a bar(or die) as indicated dimension in the table above.

5. Check

- Compare the flared work with figure below.
- If flare is noted to be defective, cut off the flared section and do flaring work again.

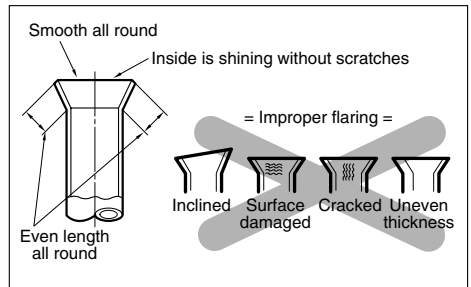

Connection of piping

1. Move the indoor tubing and drain hose to the hole
 - Remove tubing holder and pull the tubing out of the chassis.
2. Replace the tubing holder into original position
3. Route the tubing and the drain hose straight backwards.
4. Insert the connecting cable into the indoor unit through the hole.
 - Do not connect the cable to the indoor unit
 - Make a small loop with the cable for easy connection later.
5. Tape the tubing and the connecting cable.
6. Indoor unit installation.
7. Connecting the pipings to the indoor unit.

PIPE SIZE	TORQUE
1/4"	1.8~2.5 kgf·m
3/8"	3.4~4.2 kgf·m
1/2"	5.5~6.6 kgf·m
5/8"	6.3~8.2 kgf·m
3/4"	9.9~12.1 kgf·m

- Align the center of the pipings and sufficiently tighten the flare nut with fingers.
- Finally, tighten the flare nut with torque wrench until the wrench clicks. When tightening the flare nut with torque wrench, ensure the direction for tightening follows the arrow on the wrench.

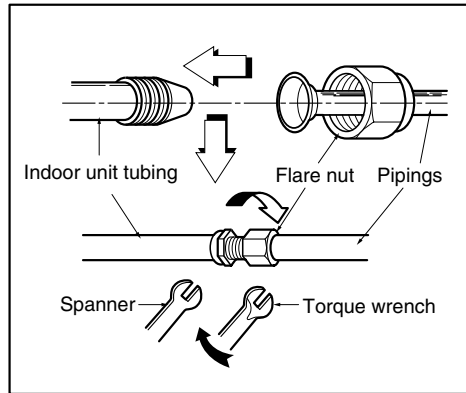

Precautions in bending

1. If it is necessary to bend or stretch the tubing, use the spring which is attached to the tubing in stead of pipe bender.
 - Please make a careful notice to make a smooth line.
 - Hold the tubing with your two hands closely and then bend or stretch it slowly not to make any crack.
 - Remember that the radius (R) should not exceed 70mm (Refer to Fig. 1)
2. Do not repeat the bending process to prevent the tubing from cracking or crushing.
3. Keep in mind that the bending part should not be cracked and make the radius (R) as long as possible (Refer to Fig. 2)

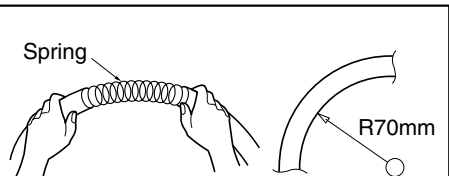

(Fig. 1)

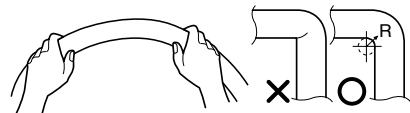

(Fig. 2)

Connecting the Cable to Indoor Unit

- The inside and outside connecting cable can be connected after opening the inlet grille.

1. Open the inlet grille manually.(Fig.1)
2. Open the terminal block cover with driver(⊕).
3. Connect the cables(LG doesn't supply) to the Terminal Block in the front Bracket. (Fig.2)
4. Secure the terminal block cover to the original position with the screw.
5. Insert the plastic tube(Bushing)in small hole in order to prevent the connecting wires from being cut by sharp edge of the hole. (Fig. 3) , America, Canada only.
6. Close the inlet grille.

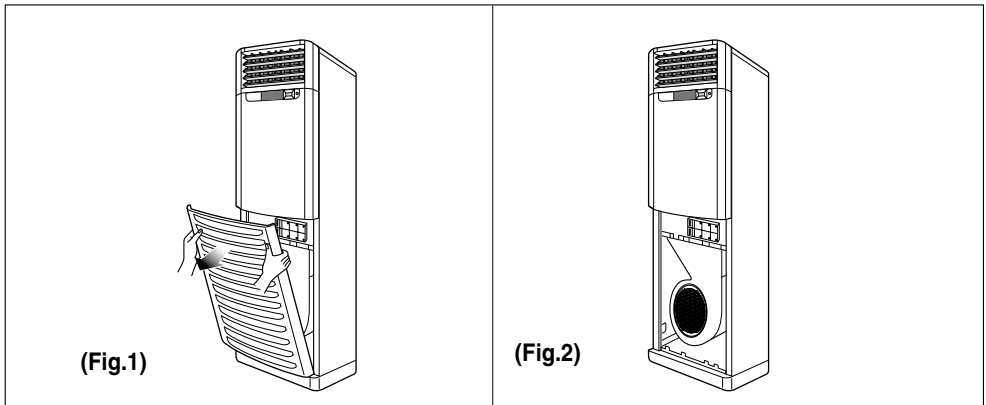

Detail Wiring of Fig.2

1. Cooling Model

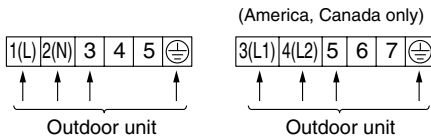

2. Heating Model

(America, Canada only)

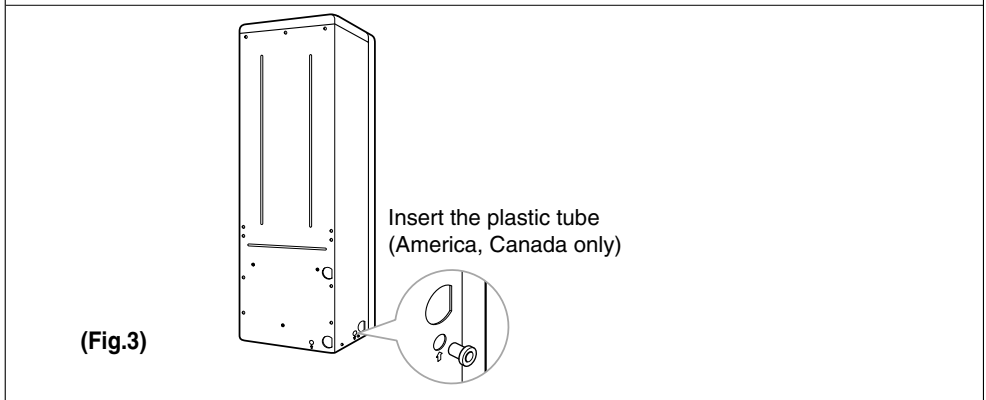
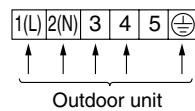

Connecting pipings to the outdoor unit .

1. Align the center of the pipings and sufficiently tighten the flare nut with fingers.
2. Finally tighten the flare nut with torque wrench until the wrench clicks.
 - When tightening the flare nut with torque wrench, ensure the direction for tightening follows the arrow on the wrench.

PIPE SIZE	TORQUE
1/4"	1.8~2.5 kgf·m
3/8"	3.4~4.2 kgf·m
1/2"	5.5~6.6 kgf·m
5/8"	6.3~8.2 kgf·m
3/4"	9.9~12.1 kgf·m

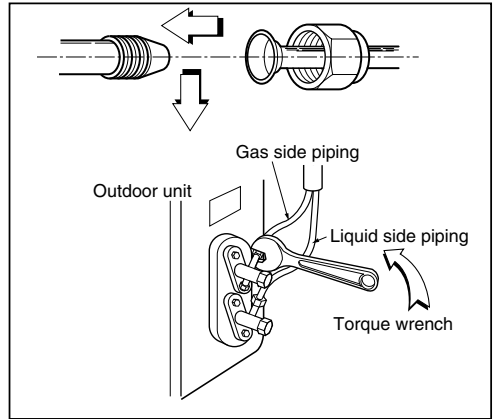

Connecting the cables to the outdoor unit

1. Open the control board cover from the outdoor unit by removing the screws.
2. Connect wires to the terminals on the control board individually and secure the cables onto the control board with clamp.
3. Secure the control board cover to the original position with the screws.



CAUTION: Perform grounding

- This product should be grounded.
- Defective grounding could cause an electric shock.

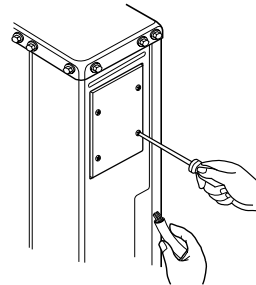
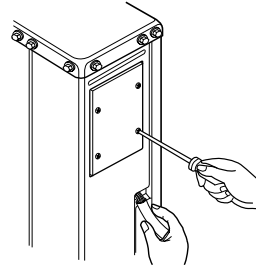
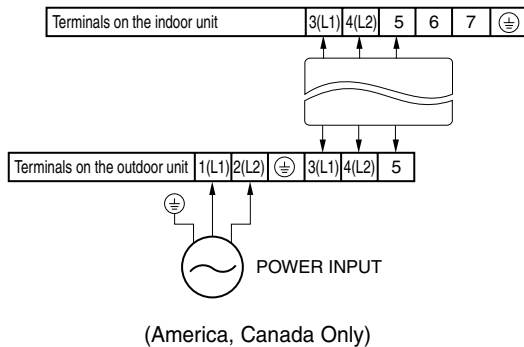

(America, Canada Only)

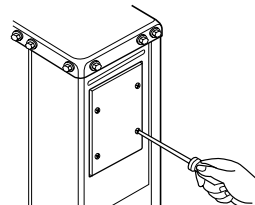

Power Supply and Wiring

The unit is completely wired internally at the factory according to general rule of electrical technology, but local rules, if they are required, should be complied with.

1. Power supply

Power source must fulfill the following conditions:

- The working voltage should be higher than 90% and lower than 110% of the rated voltage marked on the name plate.
- The starting voltage should be higher than 85% of the rated voltage marked on the name plate.

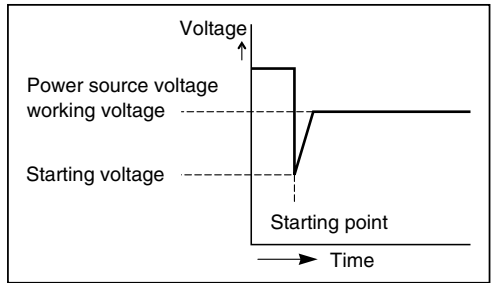

2. Wiring

After the confirmation of the above conditions, prepare the wiring as follows:

- Use the power supply cord (Rubber insulation, type Ho7RNF approved by HAR or SAA) suitable for the product's electrical capacity.

UNIT (BTU/h)		VOLTS	Conductor cross-sectional area
20k/28k/ 30k/40k	H/P	450/750V	4.0mm ²
	C/O	450/750V	4.0mm ²
44k/48k/ 50k	H/P	450/750V	5.5mm ²
	C/O	450/750V	5.5mm ²
80k	H/P	450/750V	8.0mm ²
	C/O	450/750V	8.0mm ²

- The screws which fasten the wiring in the casing of electrical fittings are liable to come loose from vibrations to which the unit is subjected during the course of transportation. Check them and make sure that they are all tightly fastened. (If they are loose, it could give rise to burn-out of the wires.)

- See to it that the starting voltage is maintained at more than 90 percent of the rated voltage marked on the name plate.
- The following troubles would be caused by voltage drop-down. Vibration of a magnetic switch, damage on the contact point there of, fuse breaking, disturbance to the normal function of a overload protection device.

- Provide a recognized circuit breaker as below between power source and unit. A disconnection device to adequately disconnect all supply lines must be fitted. (for service operations)

*Separate main and heater power supply for Z model. (Do not connect together to the same power supply)

UNIT (BTU/h)			Circuit breaker capacity
1 Phase	20K/28K/ 30K/40K	H/P	30A
		C/O	30A
	44K/48K/ 55K/60K	H/P	40A
		C/O	40A
3 Phase	44K/48K/ 50K/60K	H/P	30A
		C/O	30A
	80K	H/P	50A
		C/O	50A

Heater Wiring Spec.	Unit (BTU/h)	Breaker	Conductor
	20k/28k 30k/40k	30A	3.5mm ²
	80k	50A	8mm ²

Vacuum Drying of the Connecting Pipes and the Indoor Unit

The air which contains moisture remaining in the refrigeration cycle may cause a malfunction on the compressor.

1. Confirm that both the liquid side valve and the gas side valve are set to the closed position.
2. After connecting the piping, check the joints for gas leakage with gas leak detector.
3. Remove the service port nut, and connect the gauge manifold and the vacuum pump to the service port by the charge hose.
4. Vacuum the indoor unit and the connecting pipes until the pressure in them lowers to below -76cmHg.
5. Remove the valve stem nuts, and fully open the stems of the 2-way and 3-way valves with a hexagon wrench.
6. Tighten the valve stem nuts of the 2-way valve and 3-way valve.
7. Disconnect the charge hose and fit the nut to the service port.
(Tightening torque: 1.8kg.m)

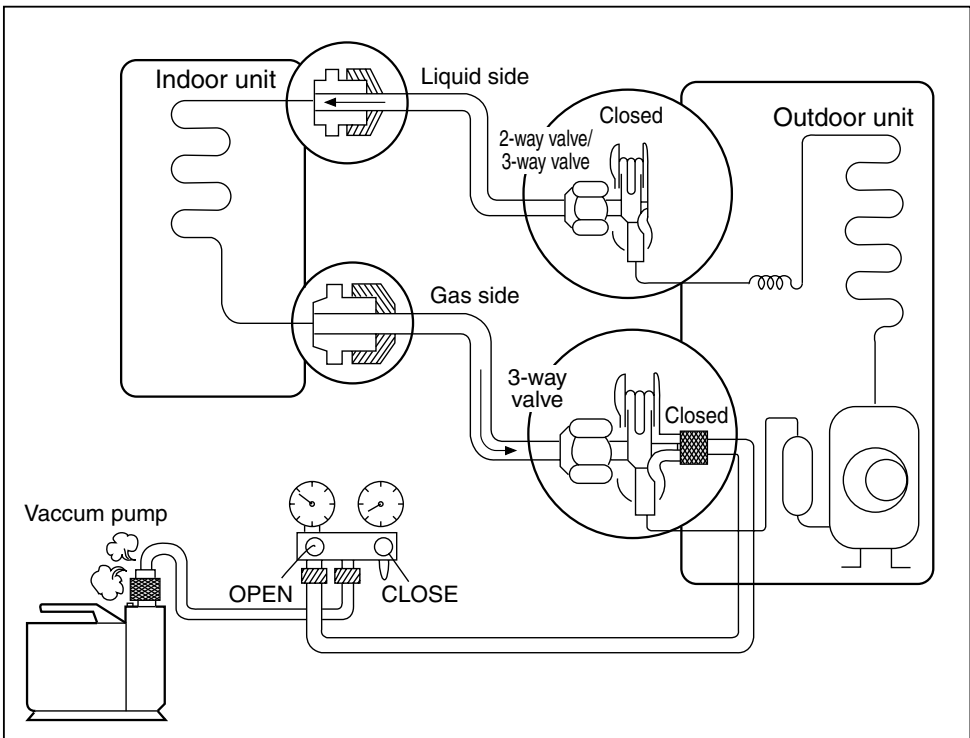

Form the Piping

1. Wrap the connecting portion of indoor unit with the insulation material and secure it with two Plastic Bands. (for the right piping)

- If you connect an additional drain hose, the end of the drain-outlet should be kept distance from the ground. (Do not dip it into water, and fix it on the wall to avoid swinging in the wind.)

In case of the outdoor unit is installed below position of the indoor unit.

2. Tape the Piping, and Connecting Cable from down to up.
3. Form the piping gathered by taping along the exterior wall and fix it onto the wall by saddle or equivalent.

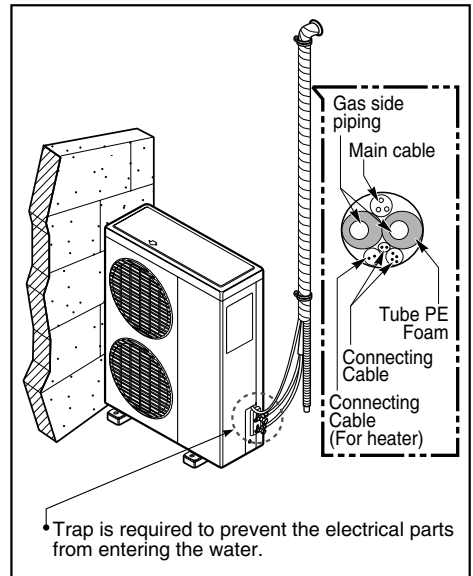

In case of the outdoor unit is installed upper position of the indoor unit.

1. Tape the piping and connecting cable from down to up.
2. In order to prevent water from entering the room, form a trap and tape the piping.
3. Fix the piping onto the wall with saddle or bracket.

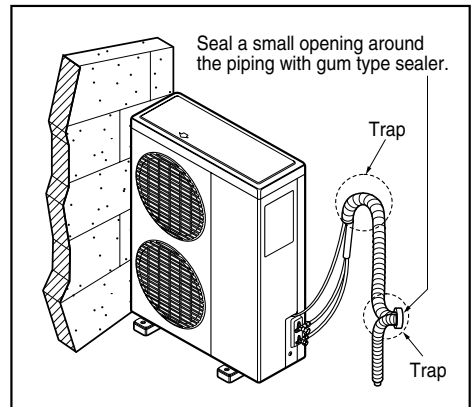

Drain water treatment of outdoor unit(Heat Pump Only)

1. When using the drain elbow hose, use a mount of 3cm of higher.
2. In the cold district (0°C(32°F) continued for 2~3 day), the drain water is frozen and the fan fail to function, do not use the drain elbow.

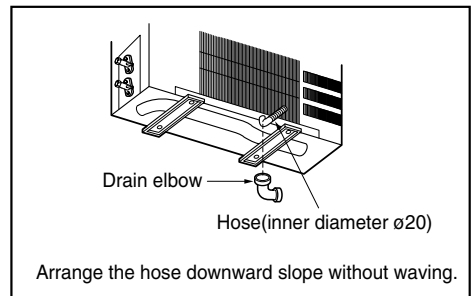

Final Check and Test Run

After installing the unit, perform the final check and running test as follows:

Final check points

- ① **Is the unit securely mounted?**
- ② **Is the installation location adequate?**
- ③ **Is the water piping work adequately and without leakage?**
- ④ **Are trapped drain lines installed at condensate drain connections?**
- ⑤ **Has the refrigeration cooling cycle been kept sealed?**
- ⑥ **Is the electrical wiring adequate and are the screws tightened on terminals?**

After the above final checkings, prepare the running test as follows:

- ① **Connect compound gauges to the check joints at discharge and suction sides of the compressor.**
- ② **Turn all switches "OFF".**
- ③ **Turn the main switch "ON".**

Running test should be accomplished as follows:

- ① **Set operation switch at "FAN" and the fan will start. Check to ensure that the fan sounds normal.**
- ② **Next, set it at "COOL" and the compressor will start. Check to ensure that the compressor sounds normal.**
- ③ **Check discharge and suction pressure on the compound gauges.**
- ④ **Check working voltage, phase balance and running current.**
- ⑤ **Check to ensure that the thermistor functions properly.**
- ⑥ **Check to ensure that the high pressure control switch functions correctly.**

Free Manuals Download Website

<http://myh66.com>

<http://usermanuals.us>

<http://www.somanuals.com>

<http://www.4manuals.cc>

<http://www.manual-lib.com>

<http://www.404manual.com>

<http://www.luxmanual.com>

<http://aubethermostatmanual.com>

Golf course search by state

<http://golfingnear.com>

Email search by domain

<http://emailbydomain.com>

Auto manuals search

<http://auto.somanuals.com>

TV manuals search

<http://tv.somanuals.com>