



website <http://www.lgservice.com>

LG

ENGLISH

FRANÇAIS

ESPAÑOL

# LG Cassette-Type Air Conditioner

## **OWNER'S MANUAL**

Prior to installation, this air-conditioning unit must be submitted for approval by the utility service which provides electricity (EN 61000-2, EN 61000-3 Norm).

### **IMPORTANT**

- Please read this owner's manual carefully and thoroughly before installing and operating your room air conditioner.
- Please retain this owner's manual for future reference after reading it thoroughly.

# TABLE OF CONTENTS

Safety Precautions .....3

Operating Instructions .....8

Maintenance and Service ....23



## FOR YOUR RECORDS

Write the model and serial numbers here:

**Model #** \_\_\_\_\_

**Serial #** \_\_\_\_\_

You can find them on a label on the side of each unit.

**Dealer's Name** \_\_\_\_\_

**Date Purchased** \_\_\_\_\_

- Staple your receipt to this page in the event you need it to prove date of purchase or for warranty issues.



## READ THIS MANUAL

Inside you will find many helpful hints on how to use and maintain your air conditioner properly. Just a little preventive care on your part can save you a great deal of time and money over the life of your air conditioner.

You'll find many answers to common problems in the chart of troubleshooting tips. If you review our chart of

**Troubleshooting Tips** first, you may not need to call for service at all.



## PRECAUTION

- Contact the authorized service technician for repair or maintenance of this unit.
- Contact the installer for installation of this unit.
- The air conditioner is not intended for use by young children or invalids without supervision.
- Young children should be supervised to ensure that they do not play with the air conditioner.
- When the power cord is to be replaced, replacement work shall be performed by authorized personnel only using only genuine replacement parts.
- Installation work must be performed in accordance with the National Electric Code by qualified and authorized personnel only.



# Safety Precautions



To prevent injury to the user or other people and property damage, the following instructions must be followed.

■ Incorrect operation due to ignoring instruction will cause harm or damage. The seriousness is classified by the following indications.

**⚠ WARNING** This symbol indicates the possibility of death or serious injury.

**⚠ CAUTION** This symbol indicates the possibility of injury or damage.

■ Meanings of symbols used in this manual are as shown below.

	<b>Be sure not to do.</b>
	<b>Be sure to follow the instruction.</b>

## ⚠ WARNING

### ■ Installation

**Do not use a defective or underrated circuit breaker. Use this appliance on a dedicated circuit.**

- There is risk of fire or electric shock.

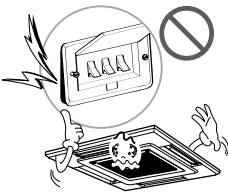

**For electrical work, contact the dealer, seller, a qualified electrician, or an Authorized Service Center.**

- Do not disassemble or repair the product. There is risk of fire or electric shock.

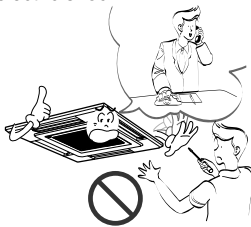

**Always ground the product.**

- There is risk of fire or electric shock.

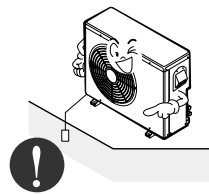

**Install the panel and the cover of control box securely.**

- There is risk of fire or electric shock.

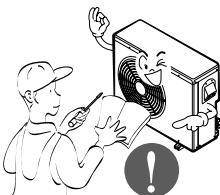

**Always install a dedicated circuit and breaker.**

- Improper wiring or installation may cause fire or electric shock

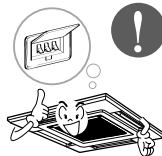

**Use the correctly rated breaker or fuse.**

- There is risk of fire or electric shock.

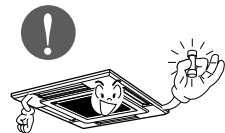

## Safety Precautions

### Do not modify or extend the power cable.

- There is risk of fire or electric shock.

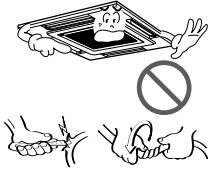

### Do not install, remove, or re-install the unit by yourself (customer).

- There is risk of fire, electric shock, explosion, or injury.



### Be cautious when unpacking and installing the product.

- Sharp edges could cause injury. Be especially careful of the case edges and the fins on the condenser and evaporator.



### For installation, always contact the dealer or an Authorized Service Center.

- There is risk of fire, electric shock, explosion, or injury.



### Do not install the product on a defective installation stand.

- It may cause injury, accident, or damage to the product.

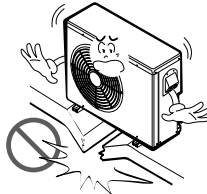

### Be sure the installation area does not deteriorate with age.

- If the base collapses, the air conditioner could fall with it, causing property damage, product failure, and personal injury.

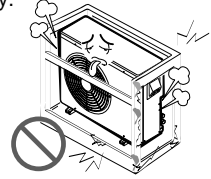

## ■ Operation

### Do not let the air conditioner run for a long time when the humidity is very high and a door or a window is left open.

- Moisture may condense and wet or damage furniture.



### Take care to ensure that power cable could not be pulled out or damaged during operation.

- There is risk of fire or electric shock.

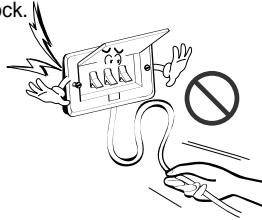

### Do not place anything on the power cable.

- There is risk of fire or electric shock.

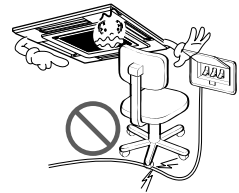

### Do not plug or unplug the power supply plug during operation.

- There is risk of fire or electric shock.

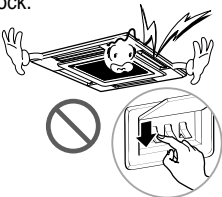

### Do not touch (operate) the product with wet hands.

- There is risk of fire or electrical shock.



### Do not place a heater or other appliances near the power cable.

- There is risk of fire and electric shock.

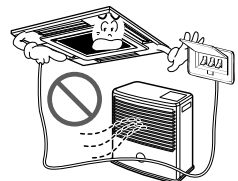

**Do not allow water to run into electric parts.**

- It may cause There is risk of fire, failure of the product, or electric shock.

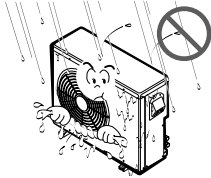

**Do not store or use flammable gas or combustibles near the product.**

- There is risk of fire or failure of product.

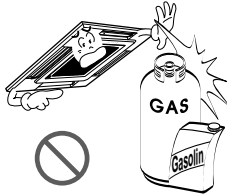

**Do not use the product in a tightly closed space for a long time.**

- Oxygen deficiency could occur.

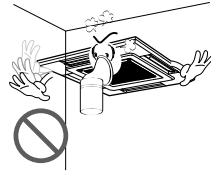

**When flammable gas leaks, turn off the gas and open a window for ventilation before turn the product on.**

- Do not use the telephone or turn switches on or off. There is risk of explosion or fire

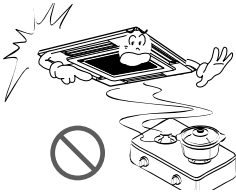

**If strange sounds, or small or smoke comes from product. Turn the breaker off or disconnect the power supply cable.**

- There is risk of electric shock or fire.



**Stop operation and close the window in storm or hurricane. If possible, remove the product from the window before the hurricane arrives.**

- There is risk of property damage, failure of product, or electric shock.

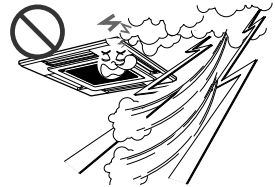

**Do not open the inlet grill of the product during operation. (Do not touch the electrostatic filter, if the unit is so equipped.)**

- There is risk of physical injury, electric shock, or product failure.



**When the product is soaked (flooded or submerged), contact an Authorized Service Center.**

- There is risk of fire or electric shock.



**Be cautious that water could not enter the product.**

- There is risk of fire, electric shock, or product damage.

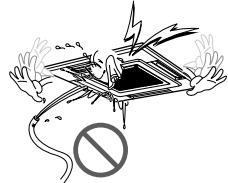

**Ventilate the product from time to time when operating it together with a stove, etc.**

- There is risk of fire or electric shock.

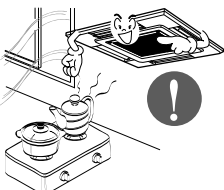

**Turn the main power off when cleaning or maintaining the product.**

- There is risk of electric shock.

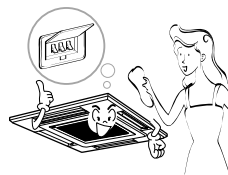

When the product is not be used for a long time, disconnect the power supply plug or turn off the breaker.

- There is risk of product damage or failure, or unintended operation.

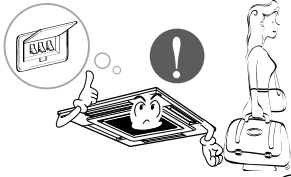

Take care to ensure that nobody could step on or fall onto the outdoor unit.

- This could result in personal injury and product damage.



## CAUTION

### Installation

Always check for gas (refrigerant) leakage after installation or repair of product.

- Low refrigerant levels may cause failure of product.

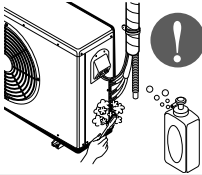

Install the drain hose to ensure that water is drained away properly.

- A bad connection may cause water leakage.

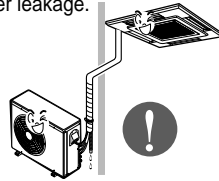

Keep level even when installing the product.

- To avoid vibration or water leakage.

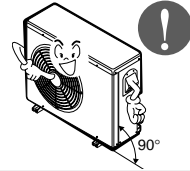

Do not install the product where the noise or hot air from the outdoor unit could damage the neighborhoods.

- It may cause a problem for your neighbors.



Use two or more people to lift and transport the product.

- Avoid personal injury.



Do not install the product where it will be exposed to sea wind (salt spray) directly.

- It may cause corrosion on the product. Corrosion, particularly on the condenser and evaporator fins, could cause product malfunction or inefficient operation.

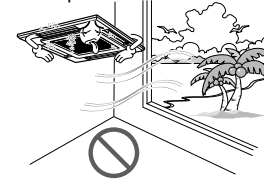

### Operation

Do not expose the skin directly to cool air for long periods of time. (Don't sit in the draft.)

- This could harm your health.

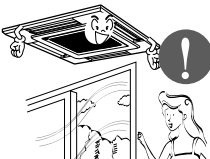

Do not use the product for special purposes, such as preserving foods, works of art, etc. It is a consumer air conditioner, not a precision refrigeration system.

- There is risk of damage or loss of property.

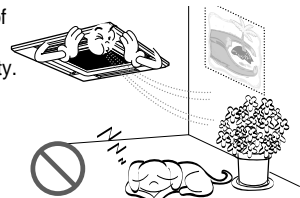

**Do not block the inlet or outlet of air flow.**

- It may cause product failure.

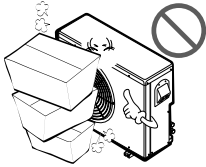

**Use a soft cloth to clean. Do not use harsh detergents, solvents, etc.**

- There is risk of fire, electric shock, or damage to the plastic parts of the product.

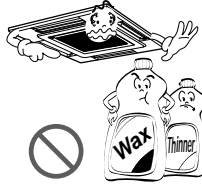

**Do not touch the metal parts of the product when removing the air filter. They are very sharp!**

- There is risk of personal injury.

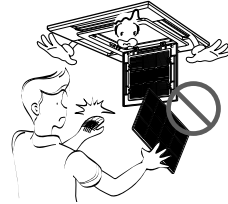

**Do not step on or put anything on the product. (outdoor units)**

- There is risk of personal injury and failure of product.



**Always insert the filter securely. Clean the filter every two weeks or more often if necessary.**

- A dirty filter reduces the efficiency of the air conditioner and could cause product malfunction or damage.

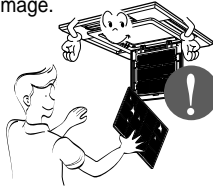

**Do not insert hands or other objects through the air inlet or outlet while the product is operated.**

- There are sharp and moving parts that could cause personal injury.

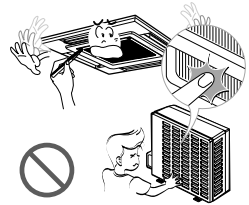

**Do not drink the water drained from the product.**

- It is not sanitary and could cause serious health issues.

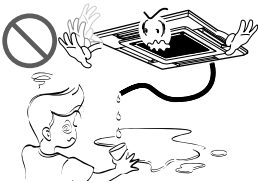

**Use a firm stool or ladder when cleaning or maintaining the product.**

- Be careful and avoid personal injury.

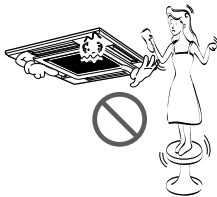

**Replace the all batteries in the remote control with new ones of the same type. Do not mix old and new batteries or different types of batteries.**

- There is risk of fire or explosion

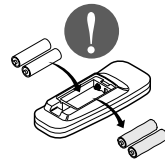

**Do not recharge or disassemble the batteries. Do not dispose of batteries in a fire.**

- They may burn or explode.

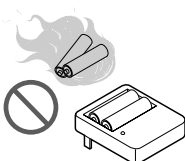

**If the liquid from the batteries gets onto your skin or clothes, wash it well with clean water. Do not use the remote if the batteries have leaked.**

- The chemicals in batteries could cause burns or other health hazards.



# Operating Instructions

## Indoor Unit

### Signal Receiver

Receives the signals from the remote control.

(Signal receiving sound: two short beeps or one long beep.)

### Cassette Type Indoor Unit

- ① On/Off : Lights up during the system operation.
- ☑ Filter Sign : Lights up after 2400 hours from the time of first operating unit.
- 🕒 Timer : Lights up during Timer operation.
- 🔊 Forced Operation : Operation procedures when the remote control can't be used.
- 🏠 Outdoor Unit Operation : Lights up during outdoor unit operation.

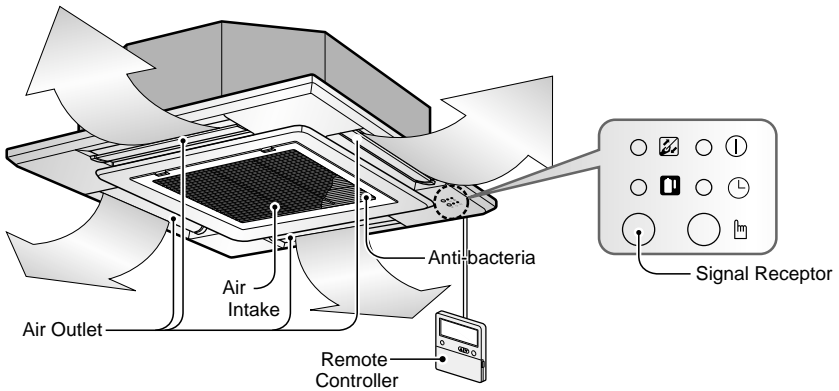



## Name and Function of Remote Controller

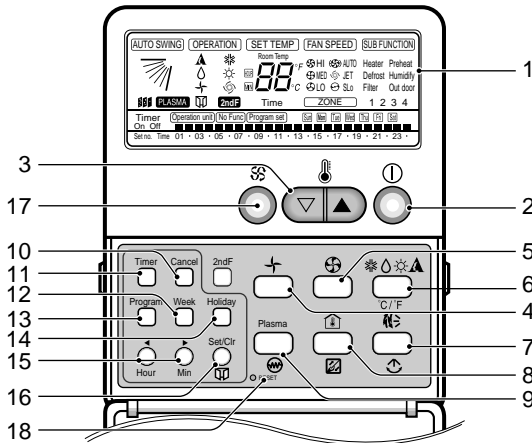

- 1 Operation display**  
Displays the operation conditions.
- 2 On/Off Button**  
Operation starts when this button is pressed, and stops when the button is pressed again.
- 3 Set Temperature Button**  
Used to set the temperature when the desired temperature is obtained.
- 4 FAN Operation Button**  
Used to circulate room air without cooling.
- 5 Fan Speed (Jet Cool Button)**  
Used to set the desired fan speed or select Jet cool mode.
- 6 Operation Mode Selection Button**  
Used to select the operation mode.
  - Auto Operation Mode
  - Cooling Operation Mode
  - Soft Dry Operation Mode
- 7 Auto Swing Button**  
Used to swing up and down.
- 8 Room Temperature Checking Button**  
Used to check the room temperature.
- 9 Plasma Air Clean Button**
- 10 Timer Cancel Button**  
Used to cancel the timer.
- 11 Timer Set Button**  
Used to set the timer when the desired time is obtained.
- 12 Week Button**  
Used to set a day of the week.
- 13 Program Button**  
Used to set the weekly timer.
- 14 Holiday Button**  
Used to set a holiday of the week.
- 15 Time Set Button**  
Used to set the time of the day and change the time in the weekly timer Function.
- 16 Set and Clear Button**  
Used to set and clear the weekly timer.
- 17 Swirl Button**  
Used to select swirl mode.
- 18 Reset Button**  
Used to set the current time and clear the setting time.

\* Display temperature can be different from actual room temperature if the remote controller is installed at the place where sun-rays are falling directly or the place nearby heat source.

# Wireless Remote Controller

**Controls**

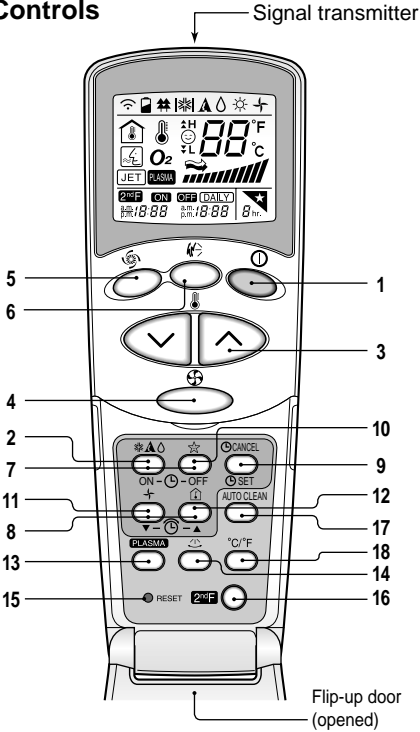

- 1. START/STOP BUTTON**  
Operation starts when this button is pressed and stops when the button is pressed again.
- 2. OPERATION MODE SELECTION BUTTON**  
Used to select the operation mode.
- 3. ROOM TEMPERATURE SETTING BUTTONS**  
Used to select the room temperature.
- 4. INDOOR FAN SPEED SELECTOR**  
Used to select fan speed in four steps low, medium, high and CHAOS.
- 5. JET COOL**  
Used to start or stop the speed cooling. (speed cooling operates super high fan speed in cooling mode.)
- 6. AUTO SWING BUTTON**  
Used to stop or start louver movement and set the desired up/down airflow direction.
- 7. ON/OFF TIMER BUTTONS**  
Used to set the time of starting and stopping operation.
- 8. TIME SETTING BUTTONS**  
Used to adjust the time.
- 9. TIMER SET/CANCEL BUTTON**  
Used to set the timer when the desired time is obtained and to cancel the Timer operation.
- 10. SLEEP MODE AUTO BUTTON**  
Used to set Sleep Mode Auto operation.
- 11. AIR CIRCULATION BUTTON**  
Used to circulate the room air without cooling or heating.
- 12. ROOM TEMPERATURE CHECKING BUTTON**  
Used to check the room temperature.
- 13. PLASMA**  
Used to start or stop the plasma-purification function.
- 14. HORIZONTAL AIRFLOW DIRECTION CONTROL BUTTON (OPTIONAL)**  
Used to set the desired horizontal airflow direction.
- 15. RESET BUTTON**  
Used prior to resetting time.
- 16. 2nd F Button**  
Used prior to using modes printed in blue at the bottom of buttons.
- 17. AUTO CLEAN (OPTIONAL)**  
Used to set Auto Clean mode.
- 18. °C TO °F SWITCHING BUTTON**  
Used to switch temperature reading from Centigrade to Fahrenheit.

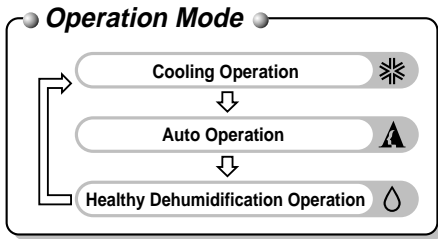

\* The wireless remote controller do not operate the swirl mode.

**CAUTION:** of handling the Remote Controller

- Aim at the signal receiver on the wired remote controller so as to operate.
- The remote control signal can be received at a distance of up to about 7m.
- Be sure that there are no obstructions between the remote controller and the signal receptor.
- Do not drop or throw the remote controller.
- Do not place the remote controller in a location exposed to direct sunlight, or near the heating unit, or any other heat source.
- Block a strong light over the signal receptor with a curtain or etc. so as to prevent the abnormal operation. (ex:electronic quick start, ELBA, inverter type fluorescent lamp)

## Set the Current Time and day of the Week

Unless you press any button about 5 (sometimes 10) seconds while setting function, the setting mode returns to initial mode.

**1** Press the '  ' button.

Each time the button is pressed, the number is changed from *00* to *23*.  
This number indicates current hour.

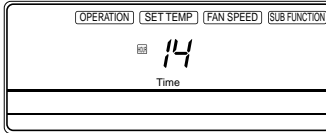



For example, if it is 14:25, press  button 14 times.

**2** Press the '  ' button.

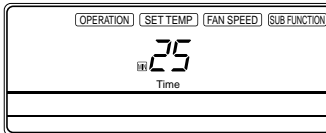
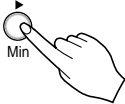
Each time the button is pressed, the number increases from *00* to *59*.  
This number indicates current minute.





For example, if it is 14:25, press  button 25 times.

**3** Press '  ' button.

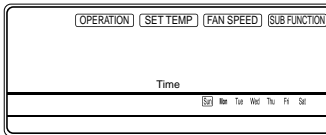
Each time the button is pressed, a day of the week is shifted from Sunday to Saturday.



For example, if today is Wed, press  button 3 times.

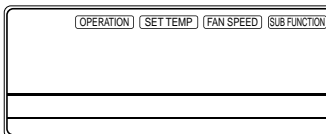

**4** Press the '  ' button.

If you want to confirm the current time and a day of the week, click the Reset button.





# Weekly Programming

**1** Press the Program button.

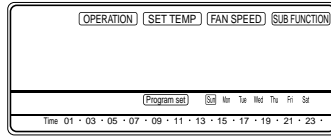
The remote controller is displayed like a picture. Then '  ', '  ' and '01' is blinked.





**2** Press the '  ' button.

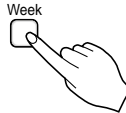

Press  button repeatedly until desired mode appears.



For example, if you want Thu, press  button 4 times.

**3** Select the time you want.

Press  or  button, then blinking letter is shown.

If you press  button, then '  ' shape appears.

'  ' shape means that five o'clock is reserved.

Using below buttons, you can reserve time.

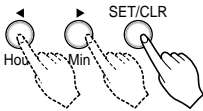

\* For example, the air-conditioner is on 6,7,8 and 13~22 o'clock.

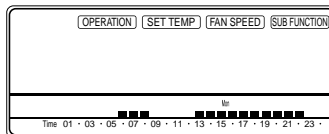

## Holiday Setting

If Tuesday is a holiday in this week, you may set a holiday.

- 1 Press the Program button.



- 2 Press the Week button.  
Select the Tuesday.



- 3 Press the Holiday button.



Then the remote controller will be displayed 'Tue'.  
The outside rectangular means holiday.

\* You cannot set the weekly program for a holiday.

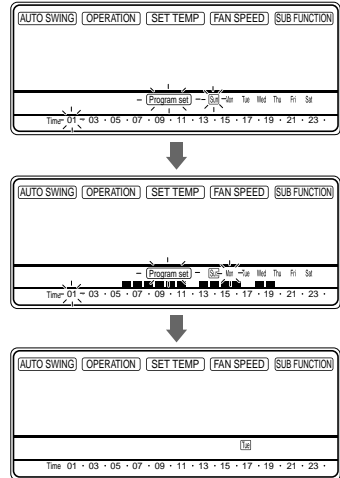



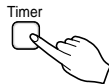

## Timer Setting

If you want to turn it 'ON' during 'OFF' mode or turn it 'OFF' during 'ON' mode, you can use timer setting function.

- 1 Press the Timer button.



- 2 Press  or  button, then you can control the desired time.

If you press  button, the display panel shows ( ex :  ).

It means 3 hours later, it will stop while 'ON' mode, it will operate while 'OFF' mode.

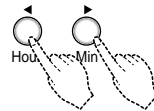

- 3 If you want to cancel the timer setting function, press the Cancel button.

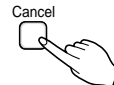

## Self-diagnosis Function

'CH' will flash in the remote controller display when a problem occurs.  
Then please contact your dealer.

## Operation Mode

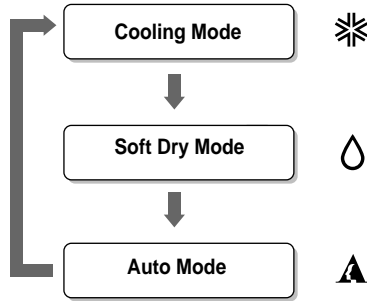

## Operation Procedure

**1st** On/Off Button

**2nd** Operation Mode Selection Button

**3rd** Room Temperature Setting Button

**4th** Indoor Fan Speed Selection Button

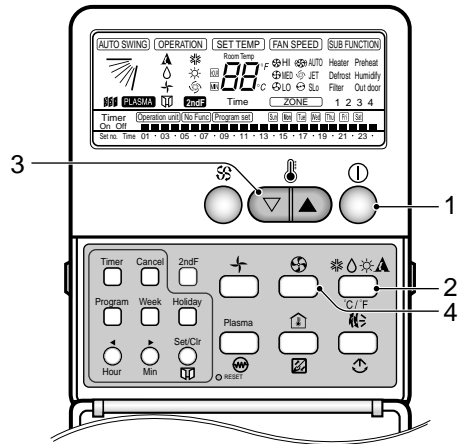

## Cooling Operation Mode

**1** Press the On/Off Button.

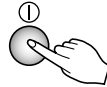

**2** Select Cooling Operation.  
Press the Operation Mode Selection Button.  
Each time the button is pressed, the operation mode is shifted in the arrow direction.

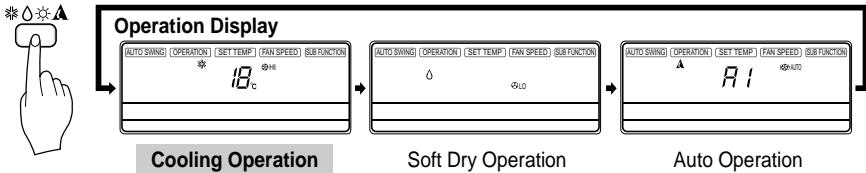

**3** Set the temperature lower than the room temperature. • The temperature can be set within a range of 18°C ~ 30°C by 1°C .

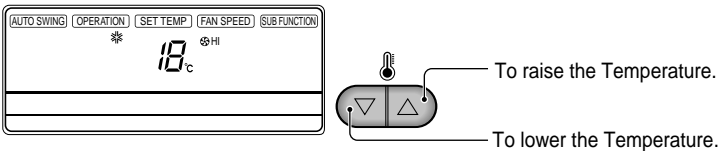

**4** Set the fan speed.

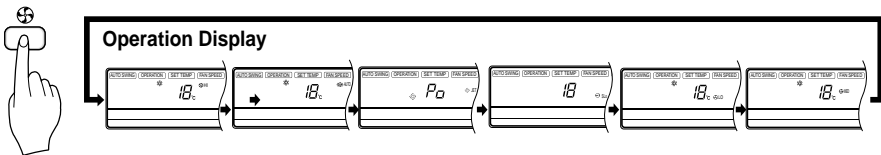

- Select the fan speed in six steps-high, auto, power jet, super-low, low, medium.
- The display shows high fan speed.
- Each time the button is pressed, the fan speed mode is shifted.

## Soft Dry Operation Mode

This mode dehumidifies without overcooling.

**1** Press the On/Off Button.

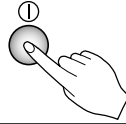

**2** Select Soft Dry Operation.

Press the operation Mode Selection Button.

Each time the button is pressed, the operation mode is shifted in the arrow direction.

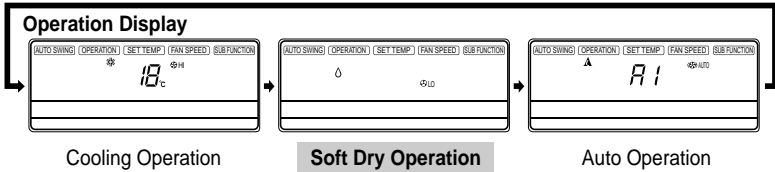

**3** During Dry Operation.

- The indoor fan speed is automatically set to the low, so the shift of the indoor fan speed is impossible because of already being set to the best speed for Dry Operation by Micom Control.



## Auto Operation Mode

**1** Press the On/Off Button.

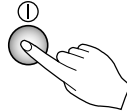

**2** To select **Auto Operation**, press the Operation Mode Selection button. Each time the button is pressed, the operation mode is shifted in the direction of the arrow.

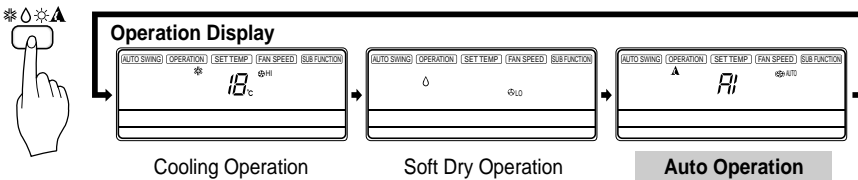

**3** The temperature and fan speed are automatically set by the electronic controls based on the actual room temperature. If you want to change the set temperature, close the door on the remote control and press the Room Temperature Setting buttons. The cooler or warmer you feel, the more times (up to two times) you should press the button. The set temperature will then be changed. The temperature can be set within a range of -2-2 by 1 level.

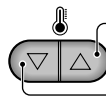
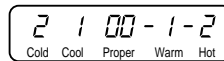
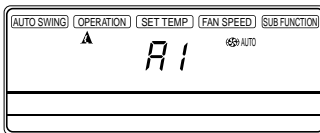

To raise the Temperature.

To lower the Temperature.

(This indication will be shifted to the initial Auto Mode Display state after 5 seconds.)

### During Auto Operation:

- You cannot switch the indoor fan speed. It has already been set by the Fuzzy rule.
- If the system is not operating as desired, manually switch to another mode. The system will not automatically switch from the cooling mode to the heating mode, or from heating to cooling, it must be done by manually resetting.
- During Auto Operation, pressing the chaos swing button makes the horizontal louvers swing up and down automatically. If you want to stop auto-swing, press the chaos swing button again.

# FAN Operation Mode

**1** Press the On/Off Button.

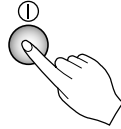

**2** Press FAN Operation Button.

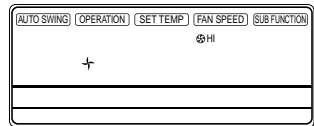

**3** Each time Fan Speed button is pressed, the fan speed mode is shifted in the arrow direction.

• Fan speed is high.

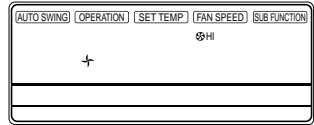

• Fan speed is medium.

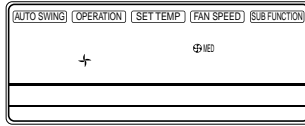

• Fan speed is low.

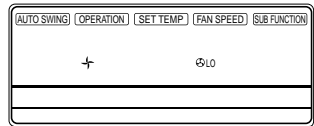

## Comfort Operation with Swirl

- It is the function for comfort cooling/heating operation.
- The diagonal two louvers are opened the more larger than the other louvers. After one minute, it is opposite.

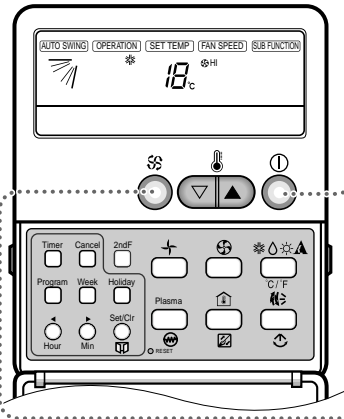
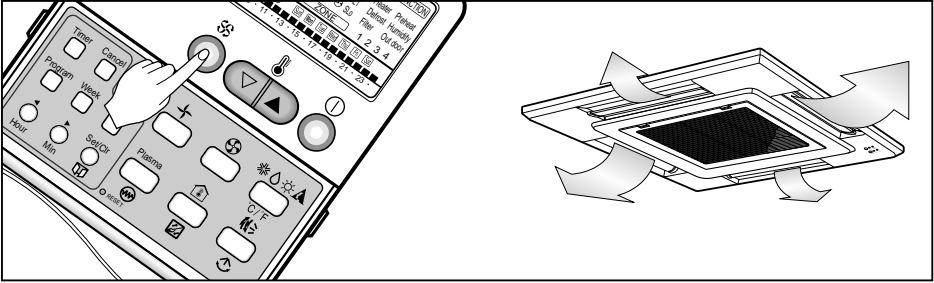

- 1** Press the On/Off Button.  
The unit will respond with a beep.

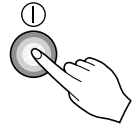

- 2** Press the Swirl Button to operate comfort cooling or heating.  
Then it will be changed the open angle of two horizontal louvers.



- 3** To cancel the Swirl Mode, press the Swirl Button again.



# Vane Control

You can change the open angle to the install situation.

**1** Press the On/Off Button.

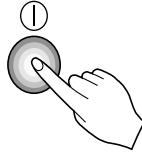

**2** Press the right arrow and auto swing button simultaneously for three seconds. Then the display will be toggled like before. Detach your finger from buttons at the moment that it is displayed "P0" in the operation display.

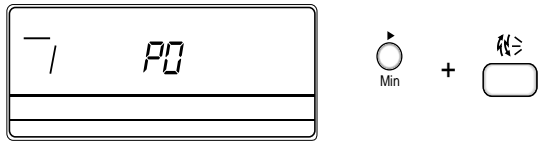

**3** Press the Auto Swing button again. Then it will be changed the open angle of two horizontal louvers. (from P0 to P5)

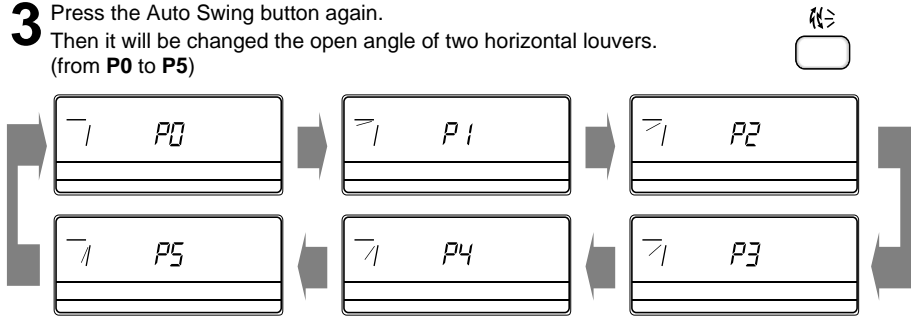

**4** Press the right arrow button and Auto Swing button to finish the setting.

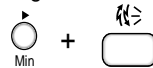

**5** Press the left arrow button and Auto Swing button for three seconds in order to set the other two louvers. Next procedure is the same before.

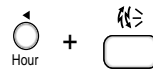

**6** Although the air conditioner is turned ON/OFF, the previous setting position is not changed. If you want to set the default position, you have to set the "P0". Because the default is the "P0".

## Auto Swing Mode

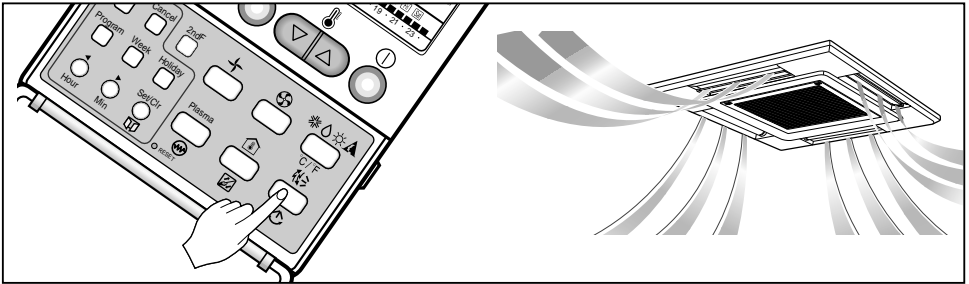

**1** Press the On/Off button.  
(Confirm the unit on operation.)



**2** Press the Auto Swing button then the horizontal louvers swing up and down automatically.



**3** Press again the Auto Swing button to cancel the Auto Swing mode.



## Child Lock Function

This is the Function that any children cannot used to the air-conditioner.

### Operation procedure

**1 To set the Child-Lock Function**

Press the Timer button and Minute Set button for three seconds. Then the operation mode shift to child lock mode and it is displayed 'CL' in the operation display. When you press any button in this time, the remote controller is not converted to any selected mode and the 'CL' is displayed in the remote controller for about three seconds. But the Room Temperature function is operated in spite of child lock mode.

**2 To cancel the Child-Lock Function**

Press the Timer button and Minute Set button for three seconds. Then the child-lock mode is cancelled and the preselected mode is displayed in the remote controller.

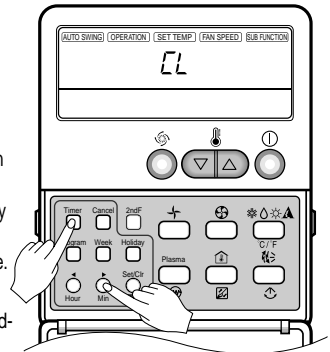

### Helpful information

Fan speed and cooling capacity.  
The cooling capacity indicated in the specification is the value when the fan speed is set to high, and the capacity will be lower at low or medium fan speed. High fan speed is recommended when you wish to cool the room quickly.

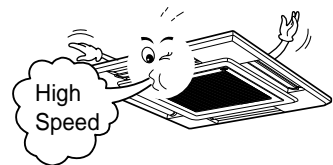

## Forced Operation

Operation procedures when the remote control can't be used.  
 Press the tact switch (Forced operation) for 2 seconds.  
 If you want to stop operation, press again the tact switch.  
 In case the power comes on again after power failure on the Forced Operation mode, the operating conditions are automatically set as follows:  
 During Forced Operation, the initial mode continues.

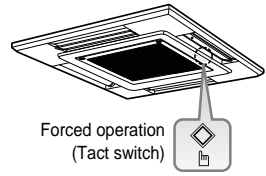

	Cooling Model	Heat pump Model	
		Room Temp. $\geq$ set Temp.-2°C	Room Temp. $<$ set Temp.-2°C
Operating mode	Cooling	Cooling	Heating
Indoor FAN Speed	High	set available	set available
Setting Temperature	22°C	set available	set available

## Auto Restart Function

In case the power comes on again after a power failure, Auto Restarting Operation is the function to operate procedures automatically to the previous operating conditions.

## Tips for Filter sign LED

- 1 Filter sign lamp (LED) is ON.
- 2 If LED indicating filter sign lamp is ON, clean the filter.
- 3 After cleaning the filter, press the Timer button and ◀ button of wired remote controller at the same time for 3 sec. Then filter sign LED is OFF.

## PLASMA Purification Operation

- 1 Press the On/Off button. The unit will respond with a beep.
- 2 Open the door on the remote control. Press the PLASMA air purifying operation ON/OFF button. Operation will start when the button is pressed and stop when the button is pressed again.
- 3 Set the fan speed again with door of the remote control closed. You can select the fan speed in four steps-low, medium, high or Auto. Each time the button is pressed, the fan speed mode is shifted.

# Maintenance and Service

## Indoor Unit

### Grille, Case and Remote Control

- Turn the system off before cleaning. To clean, wipe with a soft, dry cloth. Do not use bleach or abrasives.

### NOTICE

Supply power must be disconnected before cleaning the indoor unit.

### Air Filters

The air filters behind the front grille should be checked and cleaned once every 2 weeks or more often if necessary.

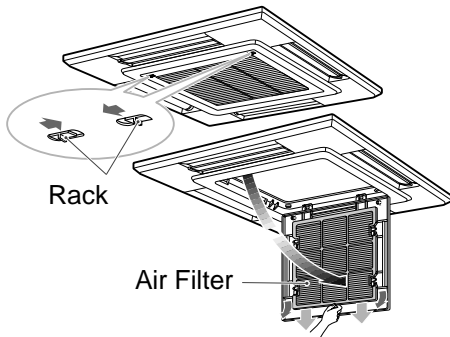

- Never use any of the followings:
  - Water hotter than 40°C. Could cause deformation and/or discoloration.
  - Volatile substances. Could damage the surfaces of the air conditioner.

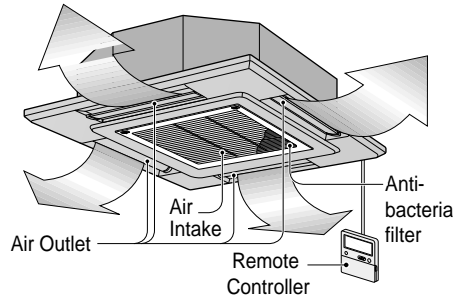

- 1 **Remove the Air filters.**
  - Take hold of the tab and pull slightly forward to remove the filter.



**CAUTION:** When the air filter is to be removed, do not touch the metal parts of the indoor unit.

It may cause an injury.

- 2 **Clean dirt from the air filter using a vacuum cleaner or washing with water.**
  - If dirt is conspicuous, wash with a neutral detergent in lukewarm water.
  - If hot water (50°C or more) is used, it may be deformed.
- 3 **After washing with water, dry well in the shade.**
  - Do not expose the air filter to direct sunlight or heat from a fire when drying it.

- 4 **Install the air filter.**

## Purifying filter

### Cleaning

The PLASMA filter behind the air filters should be checked and cleaned once every 3 months or more often if necessary.

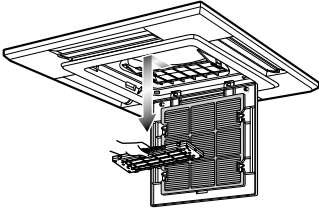

- 1 After removing the air filters, pull slightly forward to remove the PLASMA filter.
- 2 Dip the PLASMA filter into the water mixed with neutral detergent, for 20~30 minutes.
- 3 Dry the PLASMA filter in the shade for a day (Especially, the humidity must be removed perfectly on this parts).
- 4 Note the cuts of electric discharge lines.
- 5 Re-install the PLASMA filter to the original position.



**CAUTION: Don't touch this PLASMA Filter within 10 seconds after opening the inlet grille, it may cause an electric shock.**

### Replacement

• Recommended use period : About 2 years

- 1 Open front panel and remove air filter.
- 4 Reinsert air filter and close front panel.

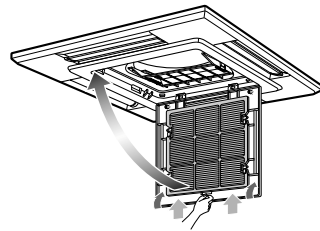
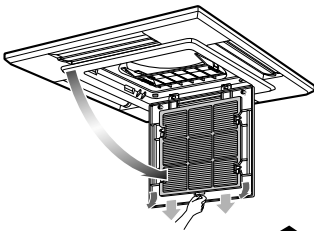

- 2 Remove air purifying filter.
- 3 Insert new air purifying filter.

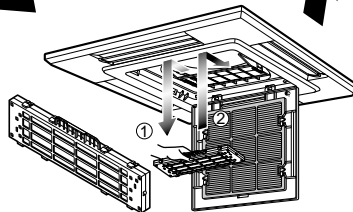



**When the air conditioner is not GOING to be used for a long time.**

**When it is not going to be used for a long time.**

- 1 Operate the air conditioner at the following settings for 2 to 3 hours.**
  - Type of operation: Fan operation mode. (Refer to page 18.)
  - This will dry out the internal mechanisms.
- 2 Turn off the breaker.**



**CAUTION:** Turn off the breaker when the air conditioner is not going to be used for a long time.

Dirt may collect and may cause a fire.

**When the air conditioner is to be used again.**

- 1 Clean the air filter and install it in the indoor unit.**  
(Refer to page 24 for cleaning it.)
- 2 Check that the air inlet and outlet of the indoor/outdoor unit are not blocked.**
- 3 Check that the ground wire is connected correctly. It may be connect to the indoor unit side.**

**Helpful information**

The air filters and your electric bill. If the air filters become clogged with dust, the cooling capacity will drop, and 6% of the electricity used to operate the air conditioner will be wasted.

**Operation Tips**

**Do not overcool the room.**

This is not good for the health and wastes electricity.

**Make sure that the doors and windows are shut tight.**

Avoid opening doors and windows as much as possible to keep the cool air in the room.

**Keep blinds or curtains closed.**

Do not let direct sunshine enter the room when the air conditioner is in operation.

**Clean the air filter regularly.**

Blockages in the air filter reduce the airflow and lower cooling and dehumidifying effects. Clean at least once every two weeks.

**Keep the room temperature uniform.**

Adjust the vertical and horizontal airflow direction to ensure a uniform temperature in the room.

**Ventilate the room occasionally.**

Since windows are kept closed, it is a good idea to open them and ventilate the room now and then.

## Troubleshooting

Check the following points before requesting repairs or service.... If the malfunction persists, please contact your dealer.

Case	Explanation	See page
The air conditioner does not operate.	• Have you made a mistake in timer operation?	13
	• Has the fuse blown or has the circuit breaker been tripped?	-
The room has a peculiar odor.	• Check that this is not a damp smell exuded by the walls, carpet, furniture or cloth items in the room.	-
It seems that condensation is leaking from the air conditioner.	• Condensation occurs when the airflow from the air conditioner cools the warm room air.	-
Air conditioner does not operate for about 3 minutes when restart.	• This is the protector of the mechanism.	-
	• Wait about three minutes and operation will begin.	-
Does not cool or heat effectively.	• Is the air filter dirty? See air filter cleaning instructions.	24
	• The room may have been very hot when the room air conditioner was first turned on. Allow time for it to cool down.	-
	• Has the setting temperature been set incorrectly?	15, 17
	• Are the indoor unit's air inlet or outlet vents obstructed?	-
The air conditioner operation is noisy.	• For a noise that sounds like water flowing. -This is the sound of freon flowing inside the air conditioner unit.	-
	• For a noise that sounds like the compressed air releasing into atmosphere. -This is the sound of the dehumidifying water being processed inside the air conditioning unit.	-
Crack sound is heard.	• This sound is generated by the expansion/contraction of the inlet grille, etc. due to changes of temperature.	-
Remote control display is faint, or no display at all.	• Has the circuit breaker been tripped? • Are the batteries inserted in the opposite (+) and (-) directions?	-



## Free Manuals Download Website

<http://myh66.com>

<http://usermanuals.us>

<http://www.somanuals.com>

<http://www.4manuals.cc>

<http://www.manual-lib.com>

<http://www.404manual.com>

<http://www.luxmanual.com>

<http://aubethermostatmanual.com>

Golf course search by state

<http://golfingnear.com>

Email search by domain

<http://emailbydomain.com>

Auto manuals search

<http://auto.somanuals.com>

TV manuals search

<http://tv.somanuals.com>