



LG Electronics Canada Inc.
1-888-LG-Canada (542-2623) www.LG.ca

2000~2005
Global No.1



ELEGANT. EFFICIENT. EXTRAORDINARY.

PRODUCT GUIDE

Ductless Air Conditioning Systems
ARTCOOL™ • Mini-Split • Flex Multi Split
Floor Standing • Ceiling Cassette
PTAC



LG

MINI-SPLIT ART COOL, SINGLE ZONE



9,000 and 12,000 BTUs
Cooling, and Heat Pump



12,000 BTUs
Cooling, and Heat Pump



18,000 BTUs
Cooling

MINI-SPLIT STANDARD, SINGLE ZONE



9,000-24,000 BTUs
Cooling and Heat Pump



30,000 BTUs
Cooling and Heat Pump

FLEX MULTI SPLIT, DUAL & TRI-ZONE



Dual Zone: Mix and match for 18,000 to 24,000 BTUs
Tri-Zone: Mix and match for 27,000 to 36,000 BTUs
Cooling and Heat Pump

FLOOR STANDING & CEILING CASSETTE, SINGLE ZONE



28,000 BTUs
Cooling



48,000 BTUs
Cooling



24,000 and 34,000 BTUs
Cooling

PACKAGED TERMINAL AIR CONDITIONERS



7,000-15,000 BTUs
Heat/Cool

ENVIRONMENTALLY FRIENDLY



LG air conditioners are environmentally friendly and future-oriented.

To reduce Freon gas, a prime ozone destroyer, they adopt alternative refrigerant R-410A, and neo plasma air-purifying system for powerful sterilization for health-conscious customers.

Also, ARTCOOL™ series with outstanding designs have received International Forum Design Award and Reddot Design Award.

They have improved air flow innovatively to realize world's lowest noise, and provide a more pleasant and convenient indoor environment.

The LG HVAC Advantage

Take advantage of our smart solutions for residential & commercial air conditioning applications.

LG HVAC systems offer a range of solutions that are cost-efficient, quiet, and attractive. They provide a smart alternative to both central HVAC and window-mounted air conditioners, and are available in a variety of configurations to suit different cooling and heating situations.

Split Systems

These innovative systems are “split” into indoor and outdoor units. The interior units are available in several different configurations: ARTCOOL™, standard wall-mounted, floor standing and ceiling cassettes. All interior units have remote controls for easy use. Installation by a qualified HVAC contractor is safe and easy—no duct work or sheet metal is needed. Single, dual and tri-zone systems, as well as cooling only and heat pump models are available.

PTAC Models

LG's new PTAC units are perfect for lodging and healthcare applications. These units have an extremely low decibel level and outstanding sound ratings. Plus, LG models have efficiency ratings up to 12.7 EER, which translates into excellent energy savings.

Feature Advantages:

Look for these key features throughout the LG line.

- **Attractive, customizable indoor units.** ARTCOOL™ provides numerous options to compliment any décor. The ARTCOOL™ Customizable Art Panel works like a picture frame – any art or photograph can be displayed. Other ARTCOOL™ units come in a variety of beautiful colors and finishes to suit any room.



- **Multi Power System™** Energy-saving twin compressors: one provides power at 60% capacity until the system reaches a desired temperature. Then the smaller compressor takes over to provide sustained operation at 40% capacity, saving money and energy.



- **R-410A Refrigerant.** Environmentally friendly refrigerant utilized in the majority of LG systems.
- **Neo Plasma Air Purifying System.** The 4-stage system features a large, permanent filter and an electronic air purifier that captures microscopic contaminants like dust, mite, pollen, and pet fur.

- **Triple-Filter Air Purifying System.** An electrostatic filter removes dust, pollen and smoke; an anti-fungal filter prevents bacteria and mold from forming; and a deodorizing filter freshens the air.
- **ARTCOOL™ Self-Cleaning Indoor Coil.** Drives dirt and moisture from coil surface leaving it clean and fresh smelling.
- **Dehumidifying Mode.** Indoor unit accurately senses room temperature and controls humidity by shutting down the compressor before a room is over-cooled.
- **Chaos Swing.** Electronically controlled louvers and fan speeds create a more natural, random flow of air, reducing temperature stratification.
- **ARTCOOL™ Three-way Cooling.** Air flows out of the unit from three directions, creating more natural circulation.
- **Jet Cool.** Operates at high speed for up to 30 minutes to quickly cool a room down to 65° F.
- **Swirl Wind.** Four-way controlled louvers and fan speeds create a stronger, wider air flow and reduces temperature stratification.
- **Auto Operation.** Provides three levels of comfort from which to choose. Temperature and fan speed will set automatically.
- **Manual Power Switch.** Easily accessed button that allows for continued operation if the remote control is misplaced.
- **Defrost Control.** Shuts down the indoor fan to prevent cold air from being blown into the house. Removes frost from outdoor coil when the outdoor temperature is low (Heat Pump only).
- **Temperature Display.** Shows room temperature of interior unit.
- **Auto Sleep Mode.** Automatically increases the temperature setting 2° F twice (after 1/2 hour and one hour). The interior unit shuts off when the timer setting is reached.
- **Auto Restart.** Automatically restarts a unit to programmed setting when the electricity comes on after a power failure.

NOTE: All features are not available on all models.
See product pages for details.

The LG HVAC Advantage

Ultra Silent Operation

Cross-flow fan operates at low speed but generates more air. The special fan housing creates a smooth and quiet air flow.

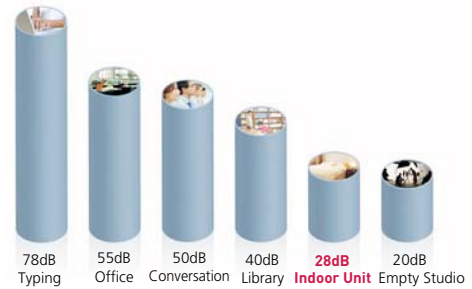
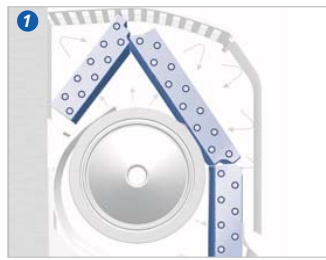

The Quiet operation has a three-layer and new design

1 Less noise with a three-layer, anti-noise mechanism

A three-layer, anti-noise mechanism covers the noise coming from the fan and the motor.

2 Conveniently attaches to the wall

The double-tubing cover minimizes space between the wall and the air conditioner in order to reduce the noise caused by motor vibration.

Chaos Swing

A natural air flow system. Computer-controlled vanes create a more natural flow of air, reducing temperature stratification.



It swings at an angle twice wider than that in conventional air conditioners, thus minimizing differences in indoor temperatures, and allowing air to circulate in every corner of the room.

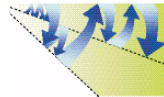

Indoor Temperature Distribution Chart

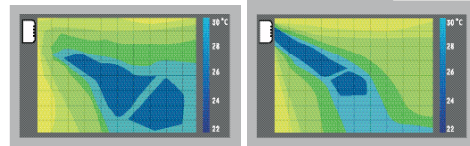

Chaos Swing

Auto Swing

4-Way Auto Swing

Air flows in 4 directions, creating more natural circulation.

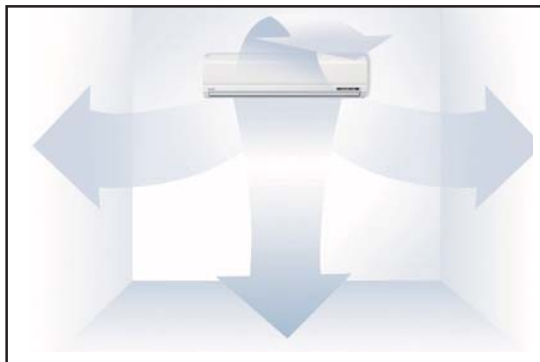

Even & Fast Cooling

Have an even and fast air flow with the Twin Air Vane™, which regulates cool and warm air.

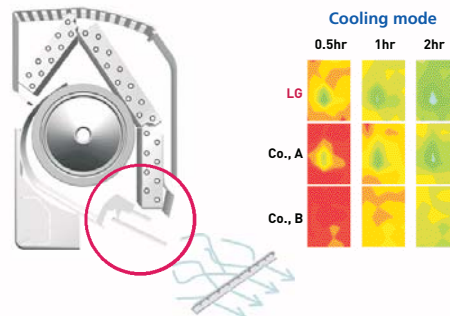

The LG HVAC Advantage

Perfect Finishing

Additional wide cover to hold tubing assembly



Wide area for piping & drain hose arrangement, wide cover to hold piping & drain hose.



Installation fully and strongly inserted structure



Additional wide cover to hold tubing assembly

Conventional



New LG



Optimum Effective Cooling

LG Wall Mounted Split models feature a Dehumidification mode to remove uncomfortable humidity from the room without over cooling.

Conventional



Since the surrounding temperature is measured after the air from the unit is widely distributed, an accurate assessment of the air is not possible.

LG



By increasing the vane angle, a better assessment of the actual temperature is possible to prevent over cooling.

Jet Cool Operation

Jet Cool operates at a high speed for up to 30 minutes to quickly cool a room down to 18°C. It can cool a certain area up to 10 meters away.



ART COOL™

ART COOL MINI-SPLIT SINGLE ZONE

Customized good looks

The slim, contemporary styling of the Art Cool™ models will appeal to today's discerning customer. The 9,000 and 12,000 BTU picture models come with a frame that allows the customer to modify and personalize the unit with their own artwork or photography – the ultimate in custom design. Other indoor units are available in popular finishes and colors to compliment any décor.

Ductless Mini-Split Air conditioning Systems from LG maximize the efficiency and economics of ductless technology. Now you can bring more attractive, cost effective solutions to your commercial and residential customers, providing single zone systems in both air conditioning and heat pump models.



Neo Plasma

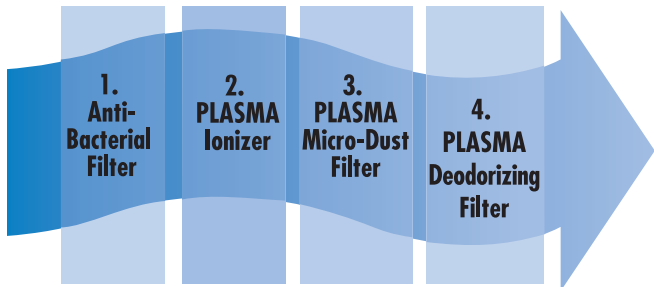

Available styles and finishes

Mini-Split
ARTCOOL™ Indoor Unit
Customizable Art Panel

Mini-Split
ARTCOOL™ Indoor Unit
Mirror Finish

Mini-Split
ARTCOOL™ Indoor Unit
Metal Finish

Outstanding air purification

The wall unit features LG's Neo Plasma Air Purifying System that provides excellent indoor air quality. Freshen the air anytime, whether cooling a room or operating in fan only mode.

9,000 BTUs

LA090CP (A/C Model)
 C 9,000 BTUs **Cooling**

LA090HP (H/P Model)
 C 9,000 BTUs **Cooling**
 H 9,000 BTUs **Heating**

12,000 BTUs

LA120CP (A/C Model)
 C 12,000 BTUs **Cooling**

LA120HP (H/P Model)
 C 12,000 BTUs **Cooling**
 H 12,000 BTUs **Heating**

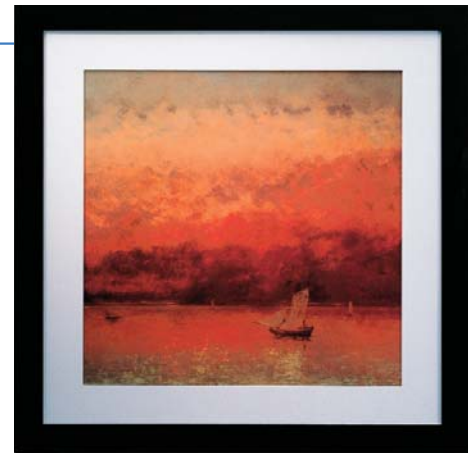

Features:

- Customizable art panel
- R-410A Refrigerant
- Neo Plasma Air Purifying System
- Self-cleaning indoor coil
- Dehumidifying mode
- Chaos Swing

- Three-way cooling
- Jet Cool
- Cooling mode
- Heating mode (H/P model only)
- Fan mode
- Auto operation
- Manual power switch
- Auto sleep mode

- Auto restart
 - 24-Hour on/off timer
 - Evaporator frost control
- Interior Unit Includes:**
- Wall unit
 - Installation plate & hardware
 - Remote control, batteries, holder & holder hardware

- Installation manual
- Exterior Unit Includes:**
- Exterior unit
 - Exterior unit has sufficient refrigerant for charging indoor coil and a 25' line set

System Model #	LA090CP	LA090HP	LA120CP	LA120HP
Indoor Model #	LA090CPI	LA090HPI	LAN120CPI	LAN120HPI
Outdoor Model #	LA090CPO	LA090CPO	LAU120CPO	LAU120HPO
Performance				
Capacity (BTUs)	C 9,000	C 9,000 H 9,000	C 12,000	C 12,000 H 12,000
SEER	13	13	13	13
Air Circulation (CFM H/M/L)	283/230/177	283/230/177	330/261/194	330/261/194
Fan Speeds	4/Auto/Chaos	4/Auto/Chaos	4/Auto/Chaos	4/Auto/Chaos
Dehumidification (pts/hour)	2.6	2.6	3.0	3.0
Indoor dB(A)*	35/30/25	35/30/25	41/35/29	41/35/29
Outdoor dB(A)*	48	48	48	48
Electrical				
Rated Voltage Outdoor	115-60-1	115-60-1	115-60-1	115-60-1
Rated Voltage Indoor	36V DC	36V DC	36V DC	36V DC
Indoor Dimensions				
W x H x D (inches)	23 5/8 x 5 3/4	23 5/8 x 5 3/4	23 5/8 x 5 3/4	23 5/8 x 5 3/4
Weight (lbs.)	30.9	30.9	30.9	30.9
Outdoor Dimensions				
W x H x D (inches)	30 5/16 x 9 5/8	30 5/16 x 9 5/8	30 5/16 x 9 5/8	30 5/16 x 9 5/8
Weight (lbs.)	66.1	66.1	70.5	70.5
Thermostat Range				
Cooling / Heating (°F)	64-86	64-86/60-86	64-86	64-86/60-86

*LG verified sound ratings

How to replace the picture in your customizable ARTCOOL™ air conditioning unit:



1. Turn off the power.
2. Pull open the top part of the front panel.
3. Pull out tabs from the bottom of the front panel, then pull the bottom of the panel forward, until it is secured. Take out the existing picture from under the panel.
4. Slide the new picture under the panel, and press the front panel shut.
5. Secure the tabs on the bottom of the front panel
6. Your new picture should now be displayed in your LG ARTCOOL™.

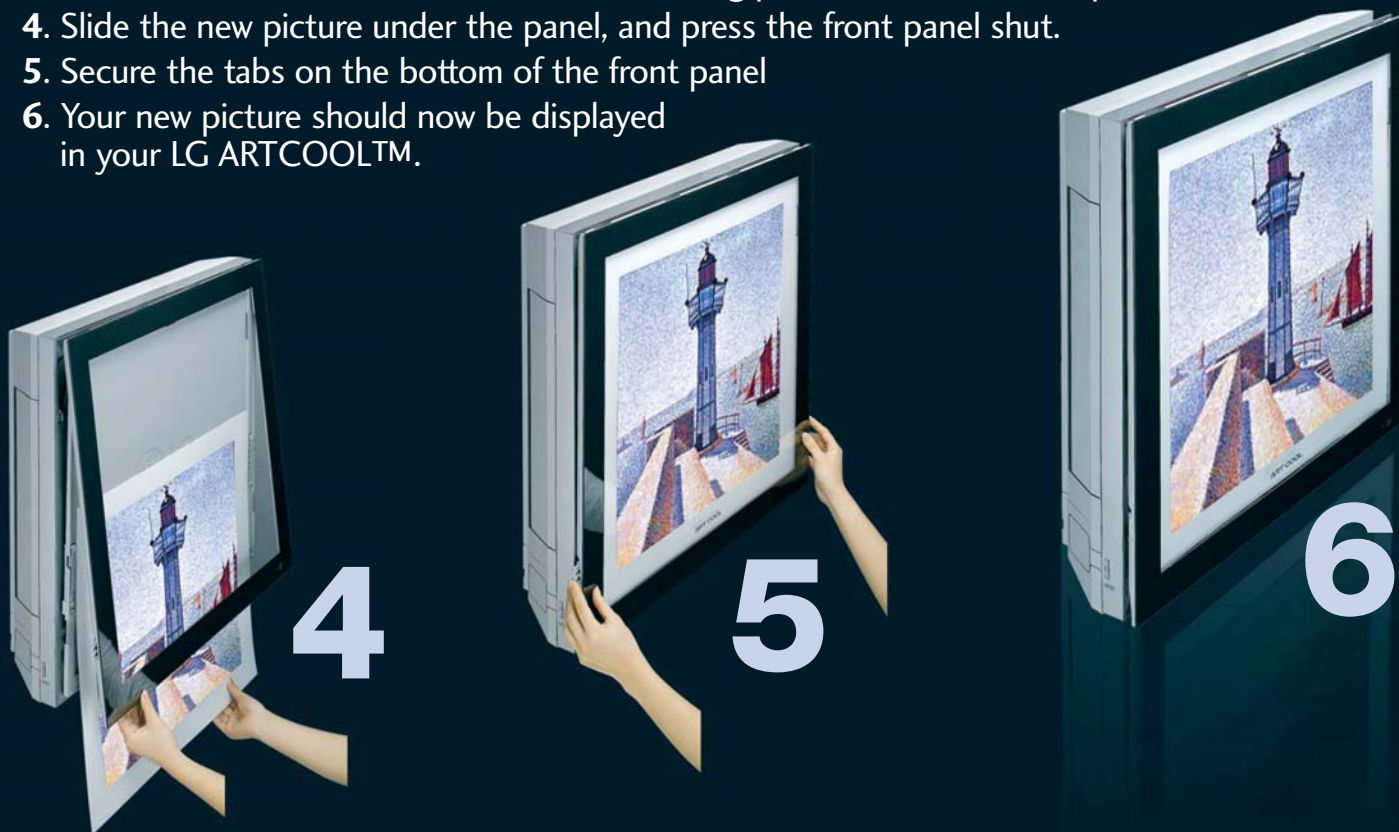

12,000 BTUs

LA121CPM (A/C Model)

C 11,500 BTUs **Cooling**

LA121HPM (H/P Model)

C 11,500 BTUs **Cooling**

H 11,500 BTUs **Heating**



Features:

- R-410A Refrigerant
- Neo Plasma Air Purifying System
- Self cleaning indoor coil
- Dehumidifying mode
- Chaos Swing
- Jet Cool
- Cooling mode

- Heating mode (H/P model only)
- Fan mode
- Auto operation
- Manual power switch
- Defrost control (H/P model only)
- Auto sleep mode
- Auto restart
- 24-Hour on/off timer
- Evaporator frost control

Ultra-quiet operation

Interior Unit Includes:

- Wall unit
- Installation plate & hardware

- Remote control, batteries, holder & holder hardware
- Installation manual

Exterior Unit Includes:

- Exterior unit
- Exterior unit has sufficient refrigerant for charging indoor coil and a 25' line set

System Model #	LA121CPM	LA121HPM
Indoor Model #	LAN121CPMI	LAN121CPMI
Outdoor Model #	LAU121CPMO	LAU121CPMO
Performance		
Capacity (BTUs)	C 11,500	C 11,500 H 11,500
SEER	13	13
Air Circulation (CFM H/M/L)	330/261/194	330/261/194
Fan Speeds	4/Auto/Chaos	4/Auto/Chaos
Dehumidification (pts/hour)	3.0	3.0
Indoor dB(A)*	41/38/34	41/38/34
Outdoor dB(A)*	48	48
Electrical		
Rated Voltage Outdoor	115-60-1	115-60-1
Rated Voltage Indoor	36V DC	36V DC
Indoor Dimensions		
W x H x D (inches)	36 x 11 3/32 x 6 1/2	36 x 11 3/32 x 6 1/2
Weight (lbs.)	20.5	20.5
Outdoor Dimensions		
W x H x D (inches)	30 5/16 x 21 5/16 x 9 5/8	30 5/16 x 21 5/16 x 9 5/8
Weight (lbs.)	70.5	70.5
Thermostat Range		
Cooling / Heating (°F)	64-86	64-86/60-86

*LG verified sound ratings

18,000 BTUs

LA180CP (A/C Model)

18,000 BTUs Cooling



Features:

- Multi Power System™
- R-410A Refrigerant
- Neo Plasma Air Purifying System
- Self cleaning indoor coil
- Dehumidifying mode
- Chaos Swing
- Three-way cooling

- Jet Cool
- Cooling mode
- Fan mode
- Auto operation
- Manual power switch
- Temp. display on indoor unit
- Auto sleep mode
- Auto restart
- 24-Hour on/off timer

- Evaporator frost control
- Interior Unit Includes:**
- Wall unit
 - Installation plate & hardware

- Remote control, batteries, holder & holder hardware
 - Installation manual
- Exterior Unit Includes:**
- Exterior unit
 - Exterior unit has sufficient refrigerant for charging indoor coil and a 25' line set

System Model #	LA180CP
Indoor Model #	LAN180CPI
Outdoor Model #	LAU180CPO
Performance	
Capacity (BTUs)	18,000/17,800
SEER	13
Air Circulation (CFM H/M/L)	460/353/247
Fan Speeds	4/Auto/Chaos
Dehumidification (pts/hour)	5.3
Indoor dB(A)*	44/40/36
Outdoor dB(A)*	55
Electrical	
Rated Voltage Outdoor	230/208-60-1
Rated Voltage Indoor	36V DC
Indoor Dimensions	
W x H x D (inches)	36 1/2 x 20 19/32 x 5 25/32
Weight (lbs.)	37.5
Outdoor Dimensions	
W x H x D (inches)	34 5/16 x 25 13/16 x 12 5/8
Weight (lbs.)	149.9
Thermostat Range	
Cooling / Heating (°F)	64-86

*LG verified sound ratings



Electrical Specifications								
ARTCOOL™	Type	Model	BTUs	Voltage		Rated Amps	MCA*	MOP**
				Indoor	Outdoor			
Single Zone	A/C	LA090CP	9,000	36V DC	115	7.2	15	15
	A/C	LA120CP	12,000	36V DC	115	9.3	15	20
	A/C	LA121CPM	11,500	36V DC	115	10.5	15	20
	A/C	LA180CP	18,000	36V DC	230/208	9.8	15	20
	H/P	LA090HP	9,000	36V DC	115	7.2	15	20
	H/P	LA120HP	12,000	36V DC	115	9.3	15	20
	H/P	LA121HPM	11,500	36V DC	115	10.5	15	20

All equipment single phase.

NOTE: Recommend shielded cable for low voltage wiring.
Please see local electrical codes for proper wire specifications.

*Minimum Circuit Ampacity
**Maximum Overcurrent Protection

Wire Size	
Minimum AWG	14-3
Indoor/Outdoor Connecting Cable Shielded	18-4

Refrigerant Line Specifications***								
ARTCOOL™	Type	Model	BTUs	Pipe Size		Additional Refrigerant	Max. Pipe Length	Max. Elevation
				Liquid	Suction			
Single Zone	A/C	LA090CP	9,000	1/4"	3/8"	0.21 oz./ft.	50'	25'
	A/C	LA120CP	12,000	1/4"	1/2"	0.21 oz./ft.	50'	25'
	A/C	LA121CPM	11,500	1/4"	1/2"	0.21 oz./ft.	50'	25'
	A/C	LA180CP	18,000	1/4"	1/2"	0.21 oz./ft.	100'	50'
	H/P	LA090HP	9,000	1/4"	3/8"	0.21 oz./ft.	50'	25'
	H/P	LA120HP	12,000	1/4"	1/2"	0.21 oz./ft.	50'	25'
	H/P	LA121HP	11,500	1/4"	1/2"	0.21 oz./ft.	50'	25'

***Each system is pre-charged with enough refrigerant to charge 25 ft. of line and the interior unit.

NOTE: Systems having the outdoor unit mounted above the indoor unit (e.g. basement installations) have the following additional requirement:

For systems with maximum elevation of 25 ft. (see Figure A), refrigerant lines must be oil trapped between 8 ft. and 12 ft. of elevation.

For systems with elevation of greater than 25 ft. Refrigerant lines must be oil trapped at least every 12 ft. of elevation.

* Each system should have a 6-8 inch inverted trap at the condensing unit if mounted above indoor unit.

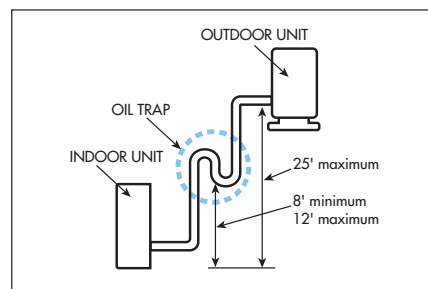

Figure A.
Example: 25 ft. maximum elevation.

MINI-SPLIT STANDARD AIR CONDITIONERS SINGLE ZONE

Mini-Split Standard systems utilize the same ductless technology as ARTCOOL™ units, in a streamlined, low profile design. Models are available in a variety of sizes from 9,000 through 30,000 BTUs. LG's Mini-split standard air conditioners are easy-to-install, efficient and cost effective.



9,000 BTUs

LS090CP (A/C Model)

C 9,000 BTUs **Cooling**

LS090HP (H/P Model)

C 9,800 BTUs **Cooling**

H 9,800 BTUs **Heating**



Standard Features:

- R-410A Refrigerant
- Dehumidifying mode
- Neo Plasma Air Purifying System
- Chaos Swing
- Jet Cool
- Cooling mode
- Heating mode (H/P model only)

- Fan mode
- Auto operation
- Manual power switch
- Defrost control (H/P model only)
- Temperature display on indoor unit
- Auto sleep mode
- Auto restart
- 24-Hour on/off timer

- Built-in low ambient standard, down to 0°F (cooling mode)
 - Ultra-quiet operation
 - Evaporator frost control
- Interior Unit Includes:**
- Wall unit
 - Installation plate & hardware
 - Remote control, batteries, holder & holder hardware

Installation manual
Exterior Unit Includes:

- Exterior unit
- Exterior unit has sufficient refrigerant for charging indoor coil and a 25' line set

System Model #	LS090CP	LS090HP
Indoor Model #	LS090CPI	LS090HPI
Outdoor Model #	LS090CPO	LS090HPO
Performance		
Capacity (BTUs)	C 9,000	C 9,800 H 9,800
SEER	13	13
Air Circulation (CFM H/M/L)	250/210/170	330/280/230
Fan Speeds	4/Auto/Chaos	4/Auto/Chaos
Dehumidification (pts/hr)	2.6	3.0
Indoor dB(A)*	36/31/28	41/36/34
Outdoor dB(A)*	48	48
Electrical		
Rated Voltage Outdoor	115-60-1	115-60-1
Rated Voltage Indoor	36V DC	36V DC
Indoor Dimensions		
W x H x D (inches)	33 1/16 x 10 5/8 x 6 1/32	35 3/16 x 11 x 6 1/32
Weight (lbs.)	15.4	15.4
Outdoor Dimensions		
W x H x D (inches)	30 5/16 x 21 5/16 x 9 19/32	30 5/16 x 21 5/16 x 9 19/32
Weight (lbs.)	66.1	72.8
Thermostat Range		
Cooling / Heating (°F)	64-86	64-86/60-86

*LG verified sound ratings

12,000 BTUs

LS120CP (A/C Model)

C 12,000 BTUs **Cooling**

LS120HP (H/P Model)

C 11,500 BTUs **Cooling**

H 11,500 BTUs **Heating**



Standard Features:

- R-410A Refrigerant
- Dehumidifying mode
- Neo Plasma Air Purifying System
- Chaos Swing
- Jet Cool
- Cooling mode
- Heating mode (H/P model only)

- Fan mode
- Auto operation
- Manual power switch
- Defrost control (H/P model only)
- Temperature display on indoor unit
- Auto sleep mode
- Auto restart
- 24-Hour on/off timer

- Built-in low ambient standard, down to 0°F (cooling mode)
 - Ultra-quiet operation
 - Evaporator frost control
- Interior Unit Includes:**
- Wall unit
 - Installation plate & hardware
 - Remote control, batteries, holder & holder hardware

Installation manual
Exterior Unit Includes:

- Exterior unit
- Exterior unit has sufficient refrigerant for charging indoor coil and a 25' line set

System Model #	LS120CP	LS120HP
Indoor Model #	LS120CPI	LS120HPI
Outdoor Model #	LS120CPO	LS120HPO
Performance		
Capacity (BTUs)	C 12,000	C 11,500 H 11,500
SEER	13	13
Air Circulation (CFM H/M/L)	330/280/230	330/280/230
Fan Speeds	4/Auto/Chaos	4/Auto/Chaos
Dehumidification (pts/hr)	3.0	3.0
Indoor dB(A)*	41/36/34	41/36/34
Outdoor dB(A)*	48	48
Electrical		
Rated Voltage Outdoor	115-1-60	115-1-60
Rated Voltage Indoor	36V DC	36V DC
Indoor Dimensions		
W x H x D (inches)	35 3/16 x 11 x 6 1/2	35 3/16 x 11 x 6 1/2
Weight (lbs.)	20.5	20.5
Outdoor Dimensions		
W x H x D (inches)	30 5/16 x 21 5/16 x 9 19/32	30 5/16 x 21 5/16 x 9 19/32
Weight (lbs.)	70.5	72.8
Thermostat Range		
Cooling / Heating (°F)	64-86	64-86/60-86

*LG verified sound ratings

18,000 BTUs

LS180CP (A/C Model)

C 18,000 BTUs **Cooling**

LS180HP (H/P Model)

C 19,500 BTUs **Cooling**

H 19,500 BTUs **Heating**



Standard Features:

- Multi Power System™
- R-410A Refrigerant
- Neo Plasma Air Purifying System
- Dehumidifying mode
- Chaos Swing
- Jet Cool
- Cooling mode

- Heating mode (H/P model only)
- Fan mode
- Auto operation
- Manual power switch
- Defrost control (H/P model only)
- Temperature display on indoor unit
- Auto sleep mode
- Auto restart
- 24-Hour on/off timer
- Ultra-quiet operation
- Evaporator frost control

Interior Unit Includes:

- Wall unit
- Installation plate & hardware
- Remote control, batteries, holder & holder hardware
- Installation manual

Exterior Unit Includes:

- Exterior unit
- Exterior unit has sufficient refrigerant for charging indoor coil and a 25' line set

System Model #	LS180CP	LS180HP
Indoor Model #	LS180CPI	LS180HPI
Outdoor Model #	LS180CPO	LS180HPO

Performance

Capacity (BTUs)	C 18,000/17,800	C 19,500/19,000 H 19,500/19,000
SEER	13	13
Air Circulation (CFM H/M/L)	460/380/320	530/450/370
Fan Speeds	4/Auto/Chaos	4/Auto/Chaos
Dehumidification (pts/hr)	5.3	6.6
Indoor dB(A)*	41/38/36	46/41/38
Outdoor dB(A)*	55	57

Electrical

Rated Voltage Outdoor	230/208-60-1	230/208-60-1
-----------------------	--------------	--------------

Rated Voltage Indoor	36V DC	36V DC
----------------------	--------	--------

Indoor Dimensions

W x H x D (inches)	42 15/16 x 11 13/16 x 7 1/32	42 15/16 x 11 13/16 x 7 1/32
--------------------	------------------------------	------------------------------

Weight (lbs.)	28.6	28.6
---------------	------	------

Outdoor Dimensions

W x H x D (inches)	34 5/16 x 25 13/16 x 12 5/8	34 5/16 x 25 13/16 x 12 5/8
--------------------	-----------------------------	-----------------------------

Weight (lbs.)	149.9	169.6
---------------	-------	-------

Thermostat Range

Cooling / Heating (°F)	64-86	64-86/60-86
------------------------	-------	-------------

*LG verified sound ratings

24,000 BTUs

LS240CP (A/C Model)

C 22,500 BTUs **Cooling**

LS240HP (H/P Model)

C 22,500 BTUs **Cooling**

H 22,500 BTUs **Heating**



Standard Features:

- Multi Power System™
- R-410A Refrigerant
- Neo Plasma Air Purifying System
- Dehumidifying mode
- Chaos Swing
- Jet Cool
- Cooling mode

- Heating mode (H/P model only)
- Fan mode
- Auto operation
- Manual power switch
- Defrost control (H/P model only)
- Temperature display on indoor unit
- Auto sleep mode
- Auto restart

- 24-Hour on/off timer
- Ultra-quiet operation
- Evaporator frost control

Interior Unit Includes:

- Wall unit
- Installation plate & hardware
- Remote control, batteries, holder & holder hardware
- Installation manual

Exterior Unit Includes:

- Exterior unit
- Exterior unit has sufficient refrigerant for charging indoor coil and a 25' line set

System Model #	LS240CP	LS240HP
Indoor Model #	LS240CPI	LS240HPI
Outdoor Model #	LS240CPO	LS240HPO
Performance		
Capacity (BTUs)	C 22,500/22,100	C 22,500/22,100 H 22,500/22,100
SEER	13	13
Air Circulation (CFM H/M/L)	530/450/370	530/450/370
Fan Speeds	4/Auto/Chaos	4/Auto/Chaos
Dehumidification (pts/hr)	6.6	6.6
Indoor dB(A)*	46/41/38	46/41/38
Outdoor dB(A)*	57	57
Electrical		
Rated Voltage Outdoor	230/208-60-1	230/208-60-1
Rated Voltage Indoor	36V DC	36V DC
Indoor Dimensions		
W x H x D (inches)	42 15/16 x 11 13/16 x 7 1/32	42 15/16 x 11 13/16 x 7 1/32
Weight (lbs.)	28.6	28.6
Outdoor Dimensions		
W x H x D (inches)	34 5/16 x 31 1/2 x 12 5/8	34 5/16 x 31 1/2 x 12 5/8
Weight (lbs.)	166.6	169.6
Thermostat Range		
Cooling / Heating (°F)	64-86	64-86/60-86

*LG verified sound ratings



30,000 BTUs

LS302CP (A/C Model)

C 28,000 BTUs **Cooling**

LS302HP (H/P Model)

C 28,000 BTUs **Cooling**

H 29,000 BTUs **Heating**



Standard Features:

- Multi Power System™
- R-410A Refrigerant
- Neo Plasma Air Purifying System
- Dehumidifying mode
- Chaos Swing
- Jet Cool
- Cooling mode

- Heating mode (H/P model only)
- Fan mode
- Auto operation
- Manual power switch
- Defrost control (H/P model only)
- Temperature display on indoor unit
- Auto sleep mode
- Auto restart
- 24-Hour on/off timer
- Ultra-quiet operation
- Evaporator frost control

Interior Unit Includes:

- Wall unit
- Installation plate & hardware
- Remote control, batteries, holder & holder hardware
- Installation manual

Exterior Unit Includes:

- Exterior unit
- Exterior unit has sufficient refrigerant for charging indoor coil and a 25' line set

System Model #	LS302CP	LS302HP
Indoor Model #	LS302CPI	LS302HPI
Outdoor Model #	LS302CPO	LS302HPO

Performance

Capacity (BTUs)	C 28,000/27,000	C 28,000/27,000 H 29,000/29,000
SEER	13	13
Air Circulation (CFM H/M/L)	740/630/520	740/630/520
Fan Speeds	4/Auto/Chaos	4/Auto/Chaos
Dehumidification (pts/hr)	7.8	7.8
Indoor dB(A)*	48/44/40	48/44/40
Outdoor dB(A)*	63	63

Electrical

Rated Voltage Outdoor	230/208-60-1	230/208-60-1
-----------------------	--------------	--------------

Rated Voltage Indoor	36V DC	36V DC
----------------------	--------	--------

Indoor Dimensions	LS302CP	LS302HP
W x H x D (inches)	47 19/32 x 13 5/8 x 8 1/16	47 19/32 x 13 5/8 x 8 1/16

Weight (lbs.)	37.5	37.5
---------------	------	------

Outdoor Dimensions	LS302CP	LS302HP
W x H x D (inches)	40 7/8 x 12 5/8	40 7/8 x 12 5/8

Weight (lbs.)	178.6	180.3
---------------	-------	-------

Thermostat Range

Cooling / Heating (°F)	64-86	64-86 /60-86
------------------------	-------	--------------

*LG verified sound ratings

MINI-SPLIT STANDARD SINGLE ZONE ELECTRICAL & REFRIGERATION • QUICK REFERENCE

Electrical Specifications									
	Type	System Model #	BTUs	Voltage		Rated Amps	MCA*	MOP**	
				Indoor	Outdoor				
Mini-Split	A/C	LS090CP	9,000	36V DC	115	7.0	15	15	
Standard	A/C	LS120CP	11,500	36V DC	115	10.5	15	25	
Single Zone	A/C	LS180CP	18,000	36V DC	230/208	8.6/9.5	15	20	
	A/C	LS240CP	22,500	36V DC	230/208	11.5/12.5	20	30	
	A/C	LS302CP	28,000	36V DC	230/208	14.5/15.6	25	30	
	H/P	LS090HP	9,800	36V DC	115	10.5	15	25	
	H/P	LS120HP	11,500	36V DC	115	10.5	15	30	
	H/P	LS180HP	19,500	36V DC	230/208	11.5/12.5	20	30	
	H/P	LS240HP	22,500	36V DC	230/208	11.5/13.0	20	30	
	H/P	LS302HP	28,000	36V DC	230/208	14.5/15.6	25	30	

All equipment single phase.

NOTE: Recommend shielded cable for low voltage wiring.

Please see local electrical codes for proper wire specifications.

*Minimum Circuit Ampacity
**Maximum Overcurrent Protection
***For LS180HP, LS240CP/HP, LS302CP/HP

Wire Size	
Minimum AWG	14-3
	12-3***
Indoor/Outdoor Connecting Cable Shielded	18-4

Refrigerant Line & Formula Specifications***									
	Type	System Model #	BTUs	Pipe size		Additional Refrigerant	Max. length each pipe	Max. elevation	
				Liquid	Suction				
Mini Split	A/C	LS090CP	9,000	1/4"	3/8"	0.25 oz./ft.	50'	25'	
Standard	A/C	LS120CP	11,500	1/4"	1/2 "	0.25 oz./ft.	50'	25'	
Single Zone	A/C	LS180CP	18,000	1/4"	1/2 "	0.25 oz./ft.	100'	50'	
	A/C	LS240CP	22,500	1/4"	5/8"	0.25 oz./ft.	100'	50'	
	A/C	LS302CP	28,000	1/4"	5/8"	0.35 oz./ft.	100'	50'	
	H/P	LS090HP	9,000	1/4"	1/2"	0.25 oz./ft.	50'	25'	
	H/P	LS120HP	11,500	1/4"	1/2 "	0.25 oz./ft.	50'	25'	
	H/P	LS180HP	19,500	1/4"	5/8 "	0.25 oz./ft.	100'	50'	
	H/P	LS240HP	22,500	1/4"	5/8"	0.25 oz./ft.	100'	50'	
	H/P	LS302HP	28,000	1/4"	5/8"	0.35 oz./ft.	100'	50'	

***Each system is pre-charged with enough refrigerant to charge 25 ft. of line and the interior unit.

NOTE: Systems having the outdoor unit mounted above the indoor unit (e.g. basement installations) have the following additional requirement:

For systems with elevation of 25 ft. (see figure A), refrigerant lines must be oil trapped between 8 ft. and 12 ft. of elevation.

For systems with elevation of greater than 25 ft. Refrigerant lines must be oil trapped at least every 12 ft. of elevation.

* Each system should have a 6-8 inch inverted trap at the condensing unit if mounted above indoor unit.

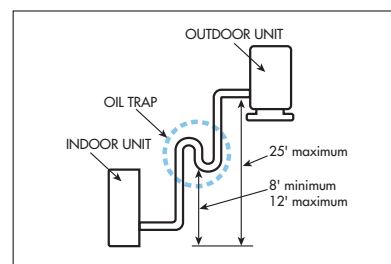

Figure A.
Example: 25 ft. maximum elevation.
Must install trap inverted.

ATTRACT YOUR ATTENTION

LG is the first company in the world to introduce the design concept of ARTCOOL™. We have introduced emotional elements to air conditioners beyond their functional features, and thus ARTCOOL™'s refined modern designs are created to highlight your own individuality and style.

We believe that everything in your home should offer you convenience and pleasure. ARTCOOL™ has thus won world-class design awards because of its remarkable concept.

If you're looking for something innovative and attractive that fits you, put it up on a wall with a painting by a master. The classic ART COOL type lets you express your personality and also make an artistic statement.



CHANGE STYLES

LG ARTCOOL™ allows you to change the image of the panel to match your interior's color scheme.

This air conditioner can simulate the ambiance you want, allowing you full control to enjoy your life.

The panel, with mirror-like finish, will inject a more modern and stylish sense in your interiors.



FLEX MULTI SPLIT AIR CONDITIONERS DUAL ZONE & TRI-ZONE

Flex Multi Split Systems

The larger, Flex Multi Split systems operate two or three interior units that are mounted in separate rooms. Each indoor unit comes with its own remote control, allowing the customer to set the temperature individually in different rooms. These units are connected to a single exterior unit.

9,000 and 12,000 Flex Multi indoor units can be combined to achieve between 18,000 and 24,000 BTUs on a Dual Zone system, and from 27,000 to 36,000 BTUs on a Tri-Zone system. The interior units are available in a variety of styles including ARTCOOL™ and Standard models. Both Dual Zone and Tri-Zone are available in Cooling Only or Heat Pump systems.

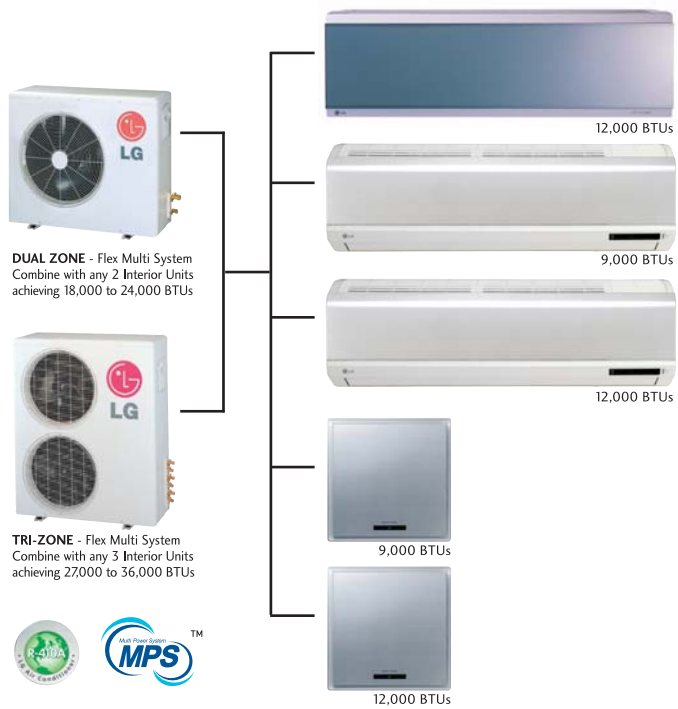

Available styles and finishes



Flex Multi Split
ARTCOOL™ Indoor Unit
Mirror Finish
12,000 BTU's
Cooling only
or Heat Pump



Flex Multi Split
ARTCOOL™ Indoor Unit Metal
Finish
9,000/12,000 BTU's
Cooling only
or Heat Pump



Flex Multi Split
Standard Indoor Unit
9,000/12,000 BTU's
Cooling only
or Heat Pump

18,000-24,000 BTUs Dual Zone

Outdoor Unit
C LM0240C

Choose any two indoor cooling units for a combined 18,000 - 24,000 BTUs cooling. Pick the same style, or mix and match.

Outdoor Unit
C H LM0240H

Choose any two indoor heat pump units for a combined 18,000 - 24,000 BTUs heating/cooling. Pick the same style, or mix and match.



Outdoor Unit Cooling LM0240C
 Outdoor Unit Heat Pump LM0240H

27,000-36,000 BTUs Tri-Zone

Outdoor Unit
C LM0360C

Choose any three indoor cooling units for a combined 27,000 - 36,000 BTUs cooling. Pick the same style, or mix and match.

Outdoor Unit
C H LM0360H

Choose any three indoor heat units for a combined 27,000 - 36,000 BTUs heating/cooling. Pick the same style, or mix and match.



Outdoor Unit Cooling LM0360C
 Outdoor Unit Heat Pump LM0360H



Model #	LM1090CP	LMA090CP	LM1120CP	LMA120CP	LMA121CPM
Performance					
Capacity (BTUs)	C 9,000/8,850	9,000/8,850	12,000/11,800	12,000/11,800	12,000/11,800
Air Circulation (CFM H/M/L)	250/210/170**	264/230/177**	330/280/230**	265/230/177**	330/261/194**
Fan Speeds	4/Auto/Chaos	4/Auto/Chaos	4/Auto/Chaos	4/Auto/Chaos	4/Auto/Chaos
Dehumidification (pts/hr)	2.3	2.3	2.5	3.0	2.5
Indoor dB(A)*	31/29/22	37/31/27	39/25/21	43/39/31	39/25/21
Outdoor dB(A)*	50	50	50	50	50
Electrical					
Rated Voltage Outdoor	230/208-60-1	230/208-60-1	230/208-60-1	230/208-60-1	230/208-60-1
Rated Voltage Indoor	36V DC	36V DC	36V DC	36V DC	36V DC
Indoor Dimensions					
W x H x D (inches)	33 1/16 x 10 5/8 x 6 1/32	22 13/32 x 22 13/32 x 5 3/8 x	35 3/16 x 11 x 6 1/2	22 13/32 x 22 13/32 x 5 3/8 x	36 x 11 3/32 x 6 1/2
Weight (lbs.)	15.4**	24.9**	20.5**	24.9**	20.5**
Outdoor Dimensions					
Dual Zone	40 5/32 x 34 3/16 x 17 5/16	40 5/32 x 34 3/16 x 17 5/16	40 5/32 x 34 3/16 x 17 5/16	40 5/32 x 34 3/16 x 17 5/16	40 5/32 x 34 3/16 x 17 5/16
Tri Zone	41 5/32 x 44 7/8 x 17 5/16	41 5/32 x 44 7/8 x 17 5/16	41 5/32 x 44 7/8 x 17 5/16	41 5/32 x 44 7/8 x 17 5/16	41 5/32 x 44 7/8 x 17 5/16
Dual Zone Weight (lbs.)	139.0	139.0	139.0	139.0	139.0
Tri Zone Weight (lbs.)	172.0	172.0	172.0	172.0	172.0
Thermostat Range					
TH-Zone Cooling / Heating (°F)	64-86	64-86	64-86	64-86	64-86

*LG verified sound ratings

**Per indoor unit

18,000-24,000 BTUs Dual Zone

27,000-36,000 BTUs Tri-Zone

Mirror Finish



12,000 BTUs Indoor Model #: LMA121CPM, LMA121HPM

ARTCOOL™ Metal Finish



9,000 BTUs Indoor Model #: LMA090CP, LMA090HP
12,000 BTUs Indoor Model #: LMA120CP, LMA120HP

Standard



9,000 BTUs Indoor Model #: LMI090CP, LMI090HP
12,000 BTUs Indoor Model #: LMI120CP, LMI120HP

Features:

- Changeable front color panel option
- Multi Power System™
- R-410A Refrigerant
- Neo Plasma Air Purifying System
- Self cleaning indoor coil
- Dehumidifying mode
- Chaos Swing
- Jet Cool
- Three-way cooling
- Cooling mode
- Heating mode (H/P Model only)
- Fan mode
- Auto operation
- Manual power switch
- Defrost control (H/P model only)
- Temperature display on indoor unit
- Auto sleep mode
- Auto restart
- 24-Hour on/off timer
- Evaporator frost control
- Ultra-quiet operation
- Interior Unit Includes:**
- 2 Wall units
- 2 Wall unit installation plates & hardware
- 2 Remote controls w/batteries, 2 holders & holder hardware
- Installation manual
- Exterior Unit Includes:**
- Exterior unit
- Exterior unit has sufficient refrigerant for charging 2 indoor coils and a 25' line set per indoor unit

Model #	LMI090HP	LMA090HP	LMI120HP	LMA120HP	LMA121HPM
Performance					
Capacity (BTUs)	C 9,000/8,850	9,000/8,850	12,000/11,800	12,000/11,800	12,000/11,800
	H 9,000/9,000	9,000/9,000	12,000/12,000	12,000/12,000	12,000/12,000
Air Circulation (CFM H/M/L)	250/210/170**	264/230/177**	330/280/230**	318/261/194**	330/261/194**
Fan Speeds	4/Auto/Chaos	4/Auto/Chaos	4/Auto/Chaos	4/Auto/Chaos	4/Auto/Chaos
Dehumidification (pts/hr)	2.3	2.3	2.5	3.0	2.5
Indoor dB(A)*	31/29/22	37/31/27	39/25/21	43/39/31	39/25/21
Outdoor dB(A)*	50	50	50	50	50
Electrical					
Rated Voltage Outdoor	230/208-60-1	230/208-60-1	230/208-60-1	230/208-60-1	230/208-60-1
Rated Voltage Indoor	36V DC	36V DC	36V DC	36V DC	36V DC
Indoor Dimensions					
W x H x D (inches)	33 1/16 x 10 5/8 x 6 1/32	22 13/32 x 22 13/32 x 5 3/8 x	35 3/16 x 11 x 6 1/2	22 13/32 x 22 13/32 x 5 3/8 x	36 x 11 3/32 x 6 1/2
Weight (lbs.)	15.4**	24.9**	20.5**	24.9**	20.5**
Outdoor Dimensions					
Dual Zone	40 5/32 x 34 3/16 x 17 5/16	40 5/32 x 34 3/16 x 17 5/16	40 5/32 x 34 3/16 x 17 5/16	40 5/32 x 34 3/16 x 17 5/16	40 5/32 x 34 3/16 x 17 5/16
Tri Zone	41 5/32 x 44 7/8 x 17 5/16	41 5/32 x 44 7/8 x 17 5/16	41 5/32 x 44 7/8 x 17 5/16	41 5/32 x 44 7/8 x 17 5/16	41 5/32 x 44 7/8 x 17 5/16
Dual Zone Weight (lbs.)	139.0	139.0	139.0	139.0	139.0
Tri Zone Weight (lbs.)	172.0	172.0	172.0	172.0	172.0
Thermostat Range					
Cooling / Heating (°F)	64-86/60-86	64-86/60-86	64-86/60-86	64-86/60-86	64-86/60-86

*LG verified sound ratings

**Per indoor unit

***Exterior unit has sufficient refrigerant for charging 25' of line set to each indoor coil



ELECTRICAL & REFRIGERATION • QUICK REFERENCE

Electrical Specifications									
Zone	Type	Model	BTUs	Voltage		Rated Amps	MCA*	MOP**	
				Indoor	Outdoor				
Flex Multi Split Indoor Units	A/C		LMI090CP	9,000	36V DC	—	0.5	—	—
	A/C		LMA090CP	9,000	36V DC	—	1.3	—	—
	A/C		LMI120CP	12,000	36V DC	—	0.5	—	—
	A/C		LMA120CP	12,000	36V DC	—	1.3	—	—
	A/C		LMA121CPM	12,000	36V DC	—	0.5	—	—
	H/P		LMI090HP	9,000	36V DC	—	0.5	—	—
	H/P		LMA090HP	9,000	36V DC	—	1.3	—	—
	H/P		LMI120HP	12,000	36V DC	—	0.5	—	—
	H/P		LMA120HP	12,000	36V DC	—	1.3	—	—
	H/P		LMA121HPM	12,000	36V DC	—	0.5	—	—
Outdoor Units	A/C		LMO240C	24,000		230/208	11.1	20	20
	A/C		LMO360C	36,000		230/208	16.6	20	30
	H/P		LMO240H	24,000		230/208	11.1	20	20
	H/P		LMO360H	36,000		230/208	16.6	20	30

All equipment single phase.

NOTE: Recommend shielded cable for low voltage wiring.
Please see local electrical codes for proper wire specifications.

*Minimum Circuit Ampacity
**Maximum Overcurrent Protection

Wire Size	
Minimum AWG	14-3
Indoor/Outdoor Connecting Cable Shielded	18-4

Refrigerant Line & Formula Specifications***

Type	Model	BTUs	Pipe size		Additional Refrigerant	Max. length each pipe	Max. elevation		
			Liquid	Suction					
Flex Multi Split	A/C		LMI090CP	9,000	1/4"	3/8"	0.21 oz./ft.	50'	25'
	A/C		LMA090CP	9,000	1/4"	3/8"	0.21 oz./ft.	50'	25'
	A/C		LMI120CP	12,000	1/4"	3/8"	0.21 oz./ft.	50'	25'
	A/C		LMA120CP	12,000	1/4"	3/8"	0.21 oz./ft.	50'	25'
	A/C		LMA121CPM	12,000	1/4"	3/8"	0.21 oz./ft.	50'	25'
	H/P		LMI090HP	9,000	1/4"	3/8"	0.21 oz./ft.	50'	25'
	H/P		LMA090HP	9,000	1/4"	3/8"	0.21 oz./ft.	50'	25'
	H/P		LMI120HP	12,000	1/4"	3/8"	0.21 oz./ft.	50'	25'
	H/P		LMA120HP	12,000	1/4"	3/8"	0.21 oz./ft.	50'	25'
	H/P		LMA121HPM	12,000	1/4"	3/8"	0.21 oz./ft.	50'	25'

***Dual Zone: exterior unit has sufficient refrigerant for charging two indoor coils and a 25 ft. line set per indoor unit.
Tri Zone: exterior unit has sufficient refrigerant for charging three indoor coils and a 25 ft. line set per indoor unit.

NOTE: Systems having the outdoor unit mounted above the indoor unit (e.g. basement installations) have the following additional requirement:
For systems with maximum elevation of 25 ft. (see Figure A), refrigerant lines must be oil trapped between 8 ft. and 12 ft. of elevation.
For systems with elevation of greater than 25 ft. Refrigerant lines must be oil trapped at least every 12 ft. of elevation.

* Each system should have a 6-8 inch inverted trap at the condensing unit if mounted above indoor unit.

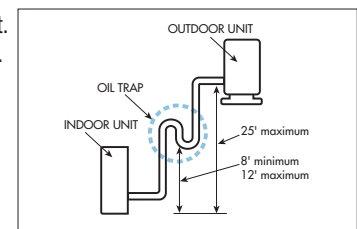

Figure A.
Example: 25 ft. maximum elevation.

DUCTLESS FLOOR STANDING & CEILING CASSETTE AIR CONDITIONERS

High Capacity Split Systems

The floor-standing and ceiling cassette models are ideal for light commercial applications, and work well in large, open spaces. The ceiling cassette is a useful alternative when floor space is limited.

The outdoor unit for both operate on high-voltage (230/208) power and utilize one or two compressors, depending on the size.



Ductless Split Floor Standing Indoor Units White Finish

Ductless Split Ceiling Cassette Indoor Units White Finish

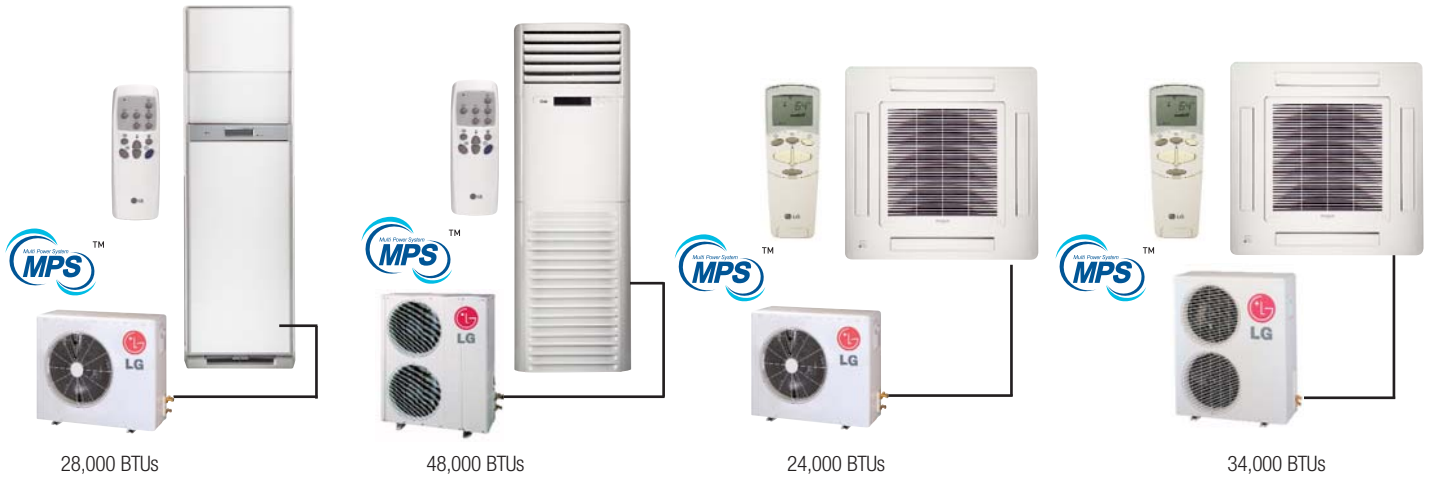

Single Zone Split Systems Floor Standing

Single Zone Split Systems Ceiling Cassette

28,000 BTUs

LF300CP (A/C Model)

28,000 BTUs Cooling



Standard Features:

- Multi Power System™
- R-22 Refrigerant
- Chaos Swing
- Three dimensional cooling
- Jet Cool
- Cooling mode
- Dehumidifying mode

- Evaporator frost control
- 7-Hour on/off timer
- Auto restart
- Auto operation
- Plasma Air Purifying System
- Temperature display on indoor unit
- Built-in remote control holder

- Control lock function
- Ultra quiet turbo fan

Interior Unit Includes:

- Floor standing unit
- Remote control and batteries
- Installation manual

Exterior Unit Includes:

- Exterior unit
- Exterior unit has sufficient refrigerant for charging indoor coil and a 25' line set

System Model #	LF300CP
Indoor Model #	LF300CPI
Outdoor Model #	LF300CP0
Performance	
Capacity (BTUs)	28,000/28,000
SEER	13
Air Circulation (CFM H/M/L)	671/565/459
Fan Speeds (Cooling/Fan)	4/3
Dehumidification (pts/hr)	7.8
Indoor dB(A)*	45/42/40
Outdoor dB(A)*	53
Electrical	
Rated Voltage Outdoor	230/208-60-1
Rated Voltage Indoor	230/208
Indoor Dimensions	
W x H x D (inches)	22 13/32 x 71 21/32 x 12 1/4
Weight (lbs.)	72.7
Outdoor Dimensions	
W x H x D (inches)	34 5/16 x 25 13/16 x 12 19/32
Weight (lbs.)	136.6
Thermostat Range	
Cooling (°F)	61-86

*LG verified sound ratings

48,000 BTUs

LF480CE (A/C Model)

48,000 BTUs Cooling



Standard Features:

- Multi Power System™
- Chaos Swing
- Jet Cool
- Cooling mode
- Dehumidifying mode
- Fan mode
- Evaporator frost control

- 7-Hour on/off timer
- Auto restart
- Auto operation
- Temperature display on indoor unit
- Control lock function
- Ultra quiet turbo fan

Interior Unit Includes:

- Floor standing unit
- Remote control and batteries
- Installation manual

Exterior Unit Includes:

- Exterior unit
- Exterior unit has sufficient refrigerant for charging indoor coil and a 25' line set

System Model #	LF480CE
Indoor Model #	LF480CEI
Outdoor Model #	LF480CEO
Performance	
Capacity (BTUs)	48,000/48,000
SEER	13
Air Circulation (CFM H/M/L)	1,236/1,059/882
Fan Speeds (Cooling/Fan)	3/3
Dehumidification (pts/hr)	8.7
Indoor dB(A)*	56/53/51
Outdoor dB(A)*	58
Electrical	
Rated Voltage Outdoor	230/208-60-1
Rated Voltage Indoor	230/208
Indoor Dimensions	
W x H x D (inches)	23 7/32 x 71 1/4 x 17 5/16
Weight (lbs.)	127.9
Outdoor Dimensions	
W x H x D (inches)	35 7/16 x 48 7/32 x 14 9/16
Weight (lbs.)	198.4
Thermostat Range	
Cooling (°F)	61-86

*LG verified sound ratings



CEILING CASSETTE

24,000 BTUs

LC240CP (A/C Model)

24,000 BTUs Cooling



Standard Features:

- Multi Power System™
- R-410A Refrigerant
- Internal condensate pump included
- Swirl Wind
- Four-way cooling
- Jet Cool

- Cooling mode
- Dehumidifying mode
- Fan mode
- Evaporator frost control
- 24-Hour on/off timer
- Auto restart
- Auto operation
- Plasma Air Purifying System

- Temperature display on remote
 - Ultra quiet turbo fan
- Interior Unit Includes:**
- Ceiling unit
 - Wired control and wireless remote control with batteries
 - Installation manual

Exterior Unit Includes:

- Exterior unit
- Exterior unit has sufficient refrigerant for charging indoor coil and a 25' line set

System Model

LC240CP

Indoor Model #

LC240CPI

Outdoor Model #

LC240CPO

Performance

Capacity (BTUs) **24,000/23,500**

SEER 13

Air Circulation (CFM H/M/L) 650/600/550

Fan Speeds (Cooling/Fan) 5/4

Dehumidification (pts/hr) 6.3

Indoor dB(A)* 38/35/32

Outdoor dB(A)* 55

Electrical

Rated Voltage Outdoor 230/208-60-1

Rated Voltage Indoor 230/208

Indoor Dimensions 33 1/16 x

W x H x D (inches) 33 1/16 x
8 7/8

Weight (lbs.) 57.3

Outdoor Dimensions 34 1/4 x

W x H x D (inches) 31 1/2 x
12 5/8

Weight (lbs.) 160.0

Thermostat Range

Cooling (°F) 64-86

*LG verified sound ratings

34,000 BTUs

LC340CP (A/C Model)

C 34,000 BTUs Cooling



Standard Features:

- Multi Power System™
- R-410A Refrigerant
- Internal condensate pump included
- Swirl Wind
- Four-way cooling
- Jet Cool

- Cooling mode
- Dehumidifying mode
- Fan mode
- Evaporator frost control
- 24-Hour on/off timer
- Auto restart
- Auto operation
- Plasma Air Purifying System

- Temperature display on remote
 - Ultra quiet turbo fan
- Interior Unit Includes:**
- Ceiling unit
 - Wired control and wireless remote control with batteries
 - Installation manual

Exterior Unit Includes:

- Exterior unit
- Exterior unit has sufficient refrigerant for charging indoor coil and a 25' line set

System Model #	LC340CP
Indoor Model #	LC340CPI
Outdoor Model #	LC340CPO
Performance	
Capacity (BTUs)	C 34,000/33,500
SEER	13
Air Circulation (CFM H/M/L)	883/812/742
Fan Speeds (Cooling/Fan)	5/4
Dehumidification (pts/hr)	7.8
Indoor dB(A)*	40/37/34
Outdoor dB(A)*	58
Electrical	
Rated Voltage Outdoor	230/208-60-1
Rated Voltage Indoor	230/208
Indoor Dimensions	
W x H x D (inches)	33 1/16 x 33 1/16 x 8 7/8
Weight (lbs.)	70.4
Outdoor Dimensions	
W x H x D (inches)	35 7/16 x 45 7/8 x 14 9/16
Weight (lbs.)	57.3
Thermostat Range	
Cooling (°F)	64-86

*LG verified sound ratings



Electrical Specifications								
	Type	System #	BTUs	Voltage		Rated Amps	MCA*	MOP**
				Indoor	Outdoor			
Floor Standing	A/C	LF300CP	28,000	230/208	230/208	11.5/11.5	17***	25***
	A/C	LF480CE	48,000	230/208	230/208	20.0/20.0	28.9***	50***
Ceiling Cassette	A/C	LC240CP	24,000	230/208	230/208	11.5/12.4	17.3	30
	A/C	LC340CP	34,000	230/208	230/208	15.1/16.5	27.5	50

All equipment single phase.

NOTE: Please see local electrical codes for proper wire specifications.

*Minimum Circuit Ampacity

**Maximum Overcurrent Protection

***Floor standing MCA + MOP calculated for indoor and outdoor units connected to common breaker (Preferred method).

Wire Size	
Minimum AWG	14-3
Indoor/Outdoor Connecting Cable Minimum AWG	14-3

Refrigerant Line Specifications [†]								
	Type	System #	BTUs	Pipe size		Additional Refrigerant	Max. length each pipe	Max. elevation
				Liquid	Suction			
Floor Standing	A/C	LF300CP	28,000	3/8"	5/8"	0.32 oz./ft.	100'	66'
	A/C	LF480CE	48,000	3/8"	3/4"	0.42 oz./ft.	131'	82'
Ceiling Cassette	A/C	LC240CP	24,000	1/4"	1/2"	0.32 oz./ft.	100'	50'
	A/C	LC340CP	34,000	1/4"	5/8"	0.42 oz./ft.	115'	66'

[†]Each system is pre-charged with enough refrigerant to charge 25 ft. of line and the interior unit.

NOTE: Systems having the outdoor unit mounted above the indoor unit (e.g. basement installations) have the following additional requirement:

For systems with maximum elevation of 25 ft. (see Figure A), refrigerant lines must be oil trapped between 8 ft. and 12 ft. of elevation.

For systems with elevation of greater than 25 ft. Refrigerant lines must be oil trapped at least every 12 ft. of elevation.

* Each system should have a 6-8 inch inverted trap at the condensing unit if mounted above indoor unit.

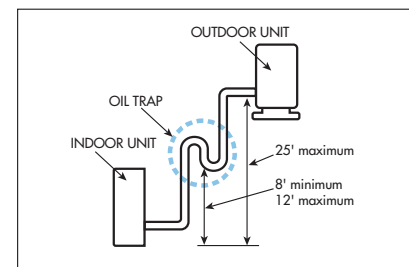

Figure A.
Example: 25 ft. maximum elevation.

PACKAGED TERMINAL AIR CONDITIONERS

Ultra quiet operation is the hallmark of LG's new line of PTAC products. Low decibel levels and outstanding sound prevention rating make this your best choice for a quiet environment. And with efficiency ratings up to 12.7 EER, these units are also your energy efficient choice.

Other features include standard connections for remote thermostat and front desk controls. Gold Fin™ technology protects the unit from the corrosive effects of outside air and extends the operating life of PTAC models. And the industry standard size makes installation easy and economical.



7,000 – 15,000 BTUs

7,000-15,000 BTUs



- **LP070CED** (H/C Model)
7,600 BTUs **Cooling & Heating**
- **LP090CED** (H/C Model)
9,000 BTUs **Cooling & Heating**
- **LP120CED** (H/C Model)
11,800 BTUs **Cooling & Heating**
- **LP150CED** (H/C Model)
14,300 BTUs **Cooling & Heating**

Standard Features:

- Gold Fin™ anti-corrosion treatment
- Cooling mode
- Heating mode
- Fan mode

- Energy saver mode
- Auto restart
- Wall thermostat temperature control
- Front desk control connection

- Dip switch settings
- Evaporator frost control
- Temperature display on unit
- Freeze room protection

System Includes:

- Wall unit
- Installation manual

System Model #	LP070CED	LP090CED	LP120CED	LP150CED
Performance				
Capacity (BTUs)	● 7,600/7,400	9,000/8,800	11,800/11,500	14,300/14,100
EER	12.7	11.7	11.2	10.0
Air Circulation (CFM H/L)	335/300	335/300	390/355	390/355
Fan Speeds (Cooling/Heating/Fan)	2/2/2	2/2/2	2/2/2	2/2/2
Dehumidification (pts/hr)	2.0	2.6	3.3	4.4
Indoor dB(A)*	45/43	45/43	49/47	49/47
Outdoor dB(A)*	60/58	60/58	63/61	63/61
STC	30	30	30	30
Electrical				
Rated Voltage	230/208-60-1	230/208-60-1	230/208-60-1	230/208-60-1
Electric Heater (kW)	2.5	3.5	3.5	3.5
Dimensions				
W x H x D (inches)	42 x 16 x 19 7/8	42 x 16 x 19 7/8	42 x 16 x 19 7/8	42 x 16 x 19 7/8
Weight (lbs.)	90.8	95.2	99.6	104.1
Thermostat Range				
Cooling/Heating (°F)**	54-86/54-86	54-86/54-86	54-86/54-86	54-86/54-86

*LG verified sound rating

**Adjustable by temperature limiting with DIP switches on the unit



Wall Sleeve
AYSVB01A



Stamped Aluminum Grille
AYRGALA01A

Architectural Grilles



Aluminum
AYAGALA01A



Dark Bronze
AYAGALB01A



Soft Dove
AYAGALC01A

Description	Model #
Sub Base 20A 230/208V	AYSB1101A
Sub Base 30A 230/208V	AYSB2101A
Control Panel Key Lock	AYCP101
Remote Escutcheon Kit - Ten Pack	AYRE110
Electrical Wall Thermostat	PYRCUCA0
Replacement Filter - 10 Pack	AYFT110
Hard Wire Kit	AYHW101
Condensate Drain Kit	AYDR101
Fuse Holder Kit	AYFH1401
Leveling Legs	AYLL101
Condensate Disposal Kit 230/208V	AYCD2101

ELECTRICAL & INSTALLATION • QUICK REFERENCE

Electrical Specifications								
Type		Model #	BTUs	Voltage	Rated Amps	MCA*	MOP**	
PTAC	A/C	Ⓒ	LP070CED	7,600	230/208 - 60-1	2.7/2.9	11.3	20
	A/C	Ⓒ	LP090CED	9,000	230/208 - 60-1	3.5/3.8	13.2	20
	A/C	Ⓒ	LP120CED	11,800	230/208 - 60-1	4.8/5.2	13.2	20
	A/C	Ⓒ	LP150CED	14,300	230/208 - 60-1	6.5/7.1	13.2	20

NOTE: Please see local electrical codes for proper wire specifications.

*Minimum Circuit Ampacity
**Maximum Overcurrent Protection

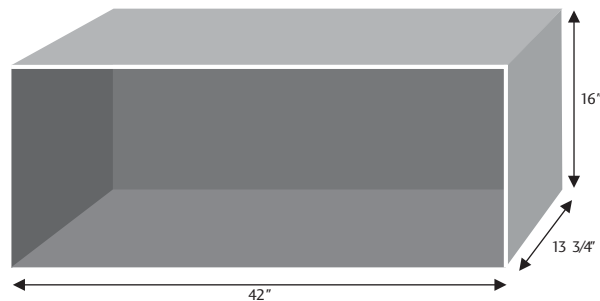
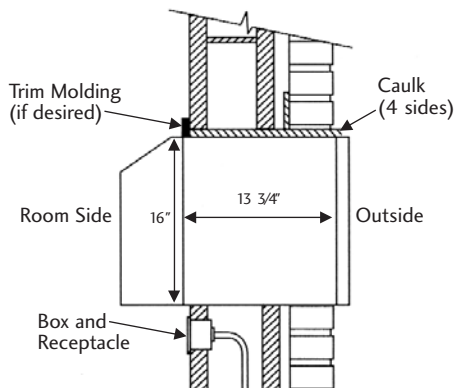

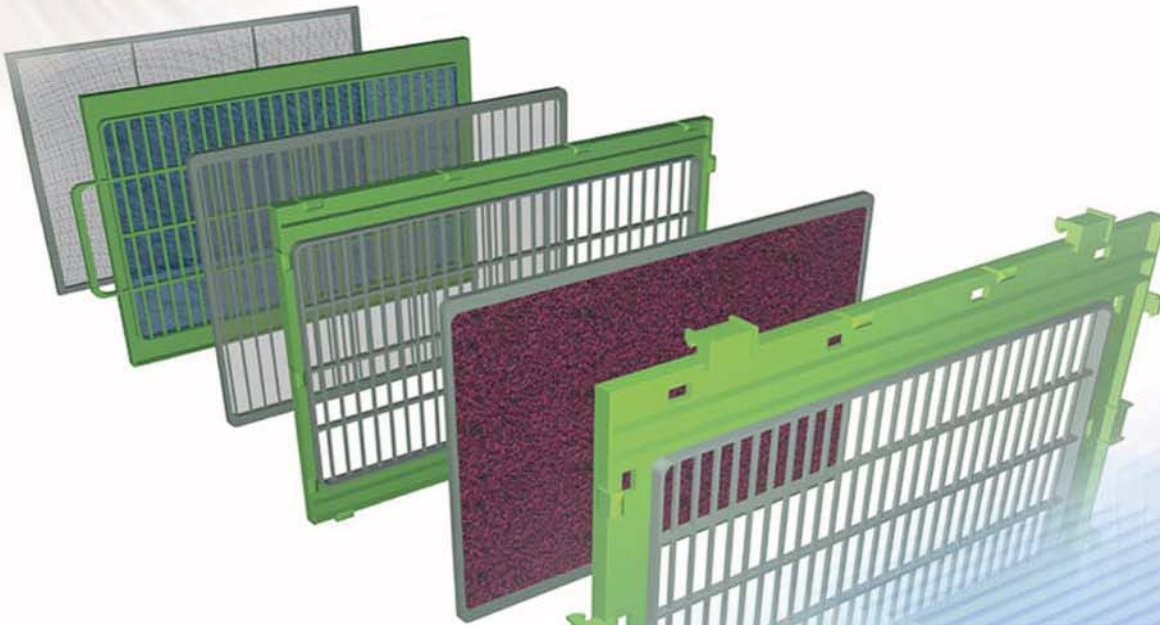

Size

Wide plasma Filter

LG Electronics' unique neo-plasma air-purifying system, equipped with 12-level bio-enzyme filters, features a more enhanced sterilization power. When air passes through each level of filters, the system can sterilize the household's fine dust, molds, ordinary odors, and more.

Old

New

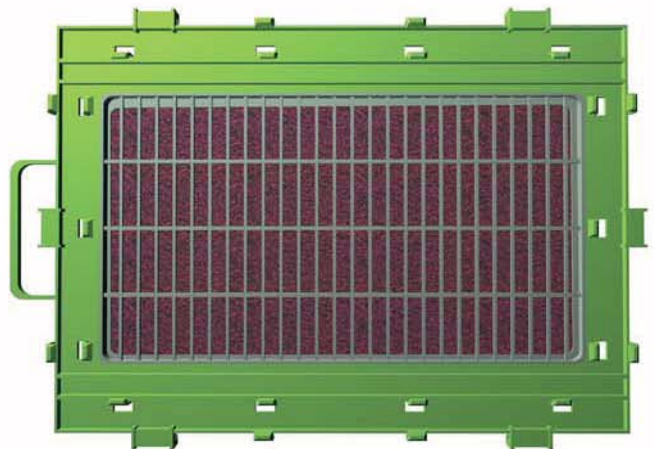

4 times larger

Neo Plasma Air Purifying System

LG Electronics' unique neo-plasma air-purifying system, equipped with 12-level bio-enzyme filters, features a much enhanced sterilization power. When air passes through each level of filters, the system can more powerfully sterilize the household's fine dust and molds, ordinary odors, food smells, and cigar smoke, as well as destroy bacteria's cell walls to completely eliminate them.

Plasma Filter

The PLASMA Air Purifying System developed uniquely by LG not only removes microscopic contaminants and dust, but also removes house mites, pollen, and pet fur to prevent allergic diseases like asthma.

What is Nano Carbon Ball?

Nano(1/1Bil) ball structure, consisted of Nano carbon, is adopted as deodorizing material first in the world



Kitasato Research Center of Environmental Sciences
- Inactivating Germs Test Result 99.9% Performance (No. 16_0113_1,2,3)

Japan Food Research Laboratories
- Inactivating Germs Test Result 99.9% Performance (No. 104093863-001,2,3,4,5)
- Killing Virus (No. 204031236-001,2,3)

Japan Spinners Inspecting Foundation (No. 624217, 019355-13)
- NCB Deodorizing 4 Type Test Result 78%~98% Security

FITI Korea Consumer Science Center (No. 513104-195-A-01)
- Killing bacteria, fungi Test Result 99.9% Security

ITS(International Technical Standard Center) (No. IL26937-A,B)
- Inactivating bacteria Test Result 99.9% Security

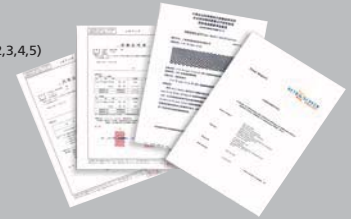

Nano Bio Fusion Filter

Nano bio fusion filters allow their nano-size bio enzymes to directly penetrate through cell walls of bacteria and allergen to decompose its cell nuclei and kill them. While conventional filters merely inactivate bacteria or destroy external cell walls, this innovative sterilization technology can completely decompose bacteria's cell nuclei and kill them.

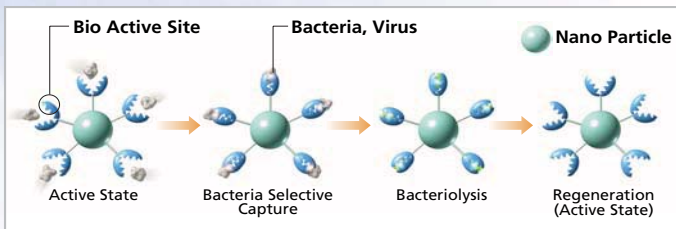

Distinctions from Conventional Filters

Conventional

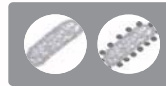

Simply inactivate bacteria

Nano Bio Fusion Filter



Destroy bacteria but allow part of them to survive



The bio enzyme destroys cell walls and nuclei of bacteria and allergens, thus completely kills bacteria

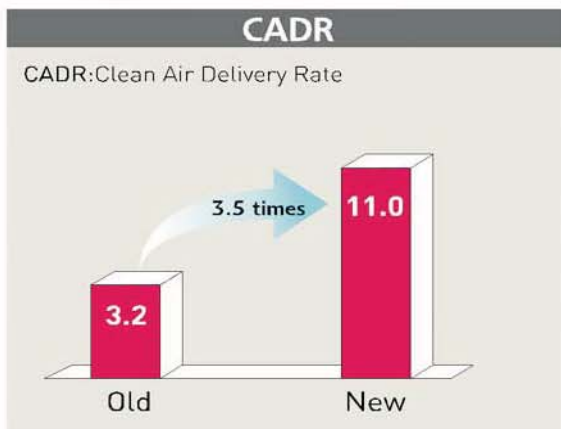

※ Increased Performance of purification

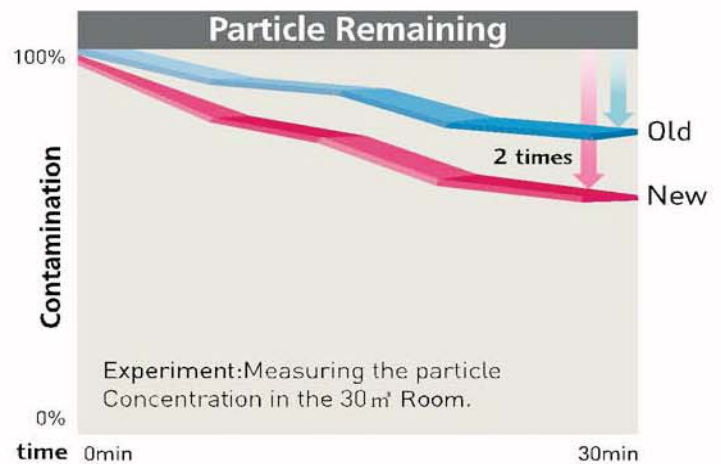

Free Manuals Download Website

<http://myh66.com>

<http://usermanuals.us>

<http://www.somanuals.com>

<http://www.4manuals.cc>

<http://www.manual-lib.com>

<http://www.404manual.com>

<http://www.luxmanual.com>

<http://aubethermostatmanual.com>

Golf course search by state

<http://golfingnear.com>

Email search by domain

<http://emailbydomain.com>

Auto manuals search

<http://auto.somanuals.com>

TV manuals search

<http://tv.somanuals.com>