



website <http://www.lgservice.com>

LG

ENGLISH

ESPAÑOL

LG

Window-Type Air Conditioner

OWNER'S MANUAL

MODELS, MODELOS:

WK Series: LW7000ER
LW8000ER

WL Series: L1004R
LW1000ER
L1204R
LW1200ER
L1404R

LB Series: LB1000ER
LB1200ER
WP Series: LW1400ER
L1504R
LW1500ER
L1804R
LW1800ER

IMPORTANT

Please read through this manual. It contains valuable information about your air conditioner. This manual may help save time and money by explaining proper air conditioner maintenance and preventing improper use.

PRECAUTIONS

Pay close attention to precautions in order to prevent potential hazards and damage from misuse or improper installation. LG is not responsible for any damages caused by misuse of the air conditioner.

TABLE OF CONTENTS

1. *Safety Precautions*

2. *Operating Instructions*

3. *Care and Maintenance*

4. *Hardware Installation*

5. *Common Issues*



FOR YOUR RECORDS

Write the model and serial numbers here:

Model # _____

Serial # _____

You can find them on a label on the side of each unit.

Dealer's Name _____

Date Purchased _____

■ Staple your receipt to this page in the event you need it to prove date of purchase or for warranty issues.



READ THIS MANUAL

Inside you will find many helpful hints on how to use and maintain your air conditioner properly. Just a little preventive care on your part can save you a great deal of time and money over the life of your air conditioner.

You'll find many answers to common problems in the chart of troubleshooting tips. If you review our chart of

Troubleshooting Tips first, you may not need to call for service at all.



PRECAUTION

- Contact the authorized service technician for repair or maintenance of this unit.
- Contact the installer for installation of this unit.
- The air conditioner is not intended for use by young children or invalids without supervision.
- Young children should be supervised to ensure that they do not play with the air conditioner.
- When the power cord is to be replaced, replacement work shall be performed by authorized personnel only using only genuine replacement parts.
- Installation work must be performed in accordance with the National Electric Code by qualified and authorized personnel only.





**Safety
Precautions**



Precautions

To prevent injury to the user or other people and property damage, the following instructions must be followed.

- Incorrect operation due to ignoring instruction will cause harm or damage. The seriousness is classified by the following indications.

 WARNING	This symbol indicates the possibility of death or serious injury.
 CAUTION	This symbol indicates the possibility of injury or damage to properties only.

- Meanings of symbols used in this manual are as shown below.

	Be sure not to do.
	Be sure to follow the instruction.

WARNING

Installation

Always install the expansion panel(s).

- No installation may cause fire and electric shock accident.

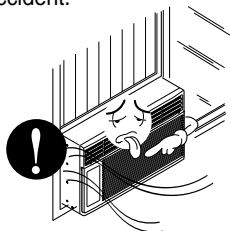

Do not place the power cord near a heater.

- It may cause fire and electric shock.

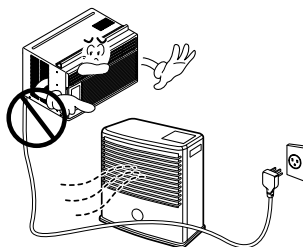

Do not use the power cord near flammable gas or combustibles such as gasoline, benzene, thinner, etc.

- It may cause explosion or fire.

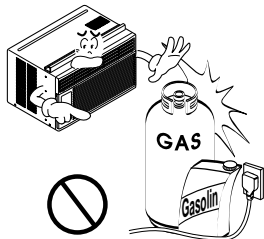

Do not disassemble or modify products.

- It may cause failure and electric shock.

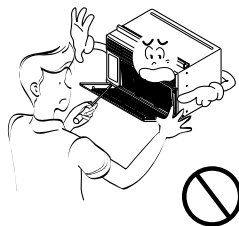

■ Operation

Plug in the power plug properly.

- Otherwise, it will cause electric shock or fire due to heat generation or electric shock.

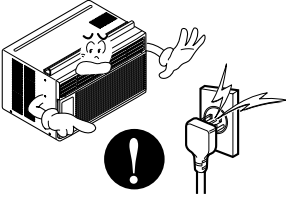

Do not operate or stop the unit by inserting or pulling out the power plug.

- It will cause electric shock or fire due to heat generation.

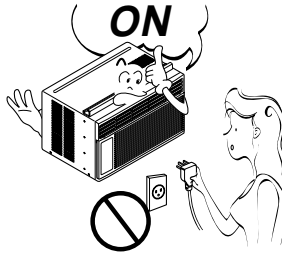

Do not damage or use an unspecified power cord.

- It will cause electric shock or fire.

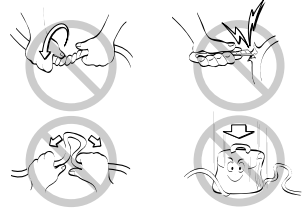

Do not modify power cord length.

- It will cause electric shock or fire due to heat generation.

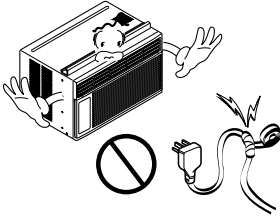

Do not share the outlet with other appliances.

- It will cause electric shock or fire due to heat generation.

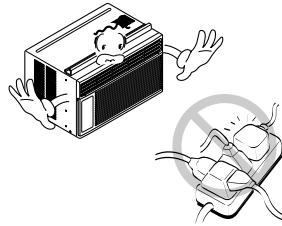

Always plug into a grounded outlet.

- No grounding may cause electric shock (See Installation Manual).

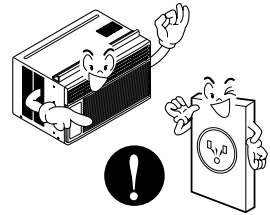

Unplug the unit if strange sounds, odors, or smoke come from it.

- Otherwise it may cause fire and electric shock accident.

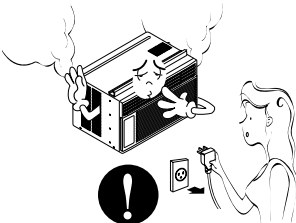

Do not use the socket if it is loose or damaged.

- It may cause fire and electric shock.



Do not operate with wet hands or in damp environment.

- It will cause electric shock.

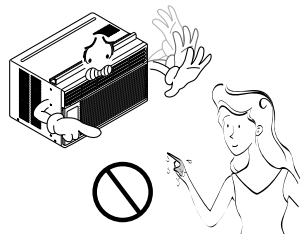

Do not allow water to run into electric parts.

- It will cause failure of machine or electric shock.

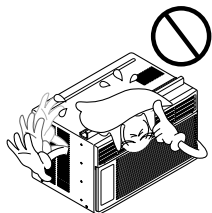

Leave the door closed while the air conditioner is running.

- It is not designed to cool the entire house.

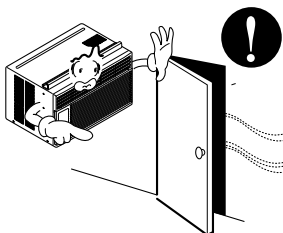

Ventilate before operating air conditioner when gas goes out.

- It may cause explosion, fire, and burn.

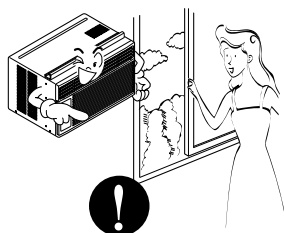

CAUTION

Installation

Never touch the metal parts of the unit when removing the filter.

- They are sharp and may cause injury.

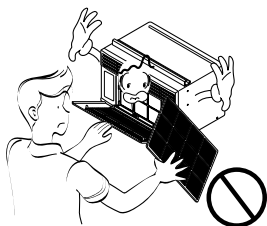

Do not block the inlet or outlet.

- It may cause failure of appliance or accident.

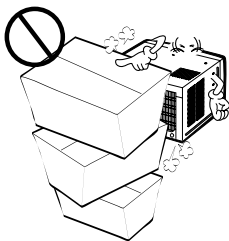

Ensure that the outer case is not damaged by age or wear.

- If leaving appliance damaged, there is concern of damage due to the falling of product.

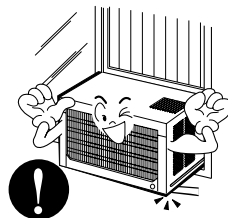

Operation

Be cautious not to touch the sharp edges when installing.

- It may cause injury.

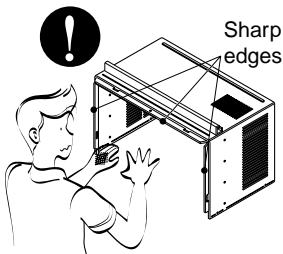

Hold the plug by the head when taking it out.

- It may cause electric shock and damage.

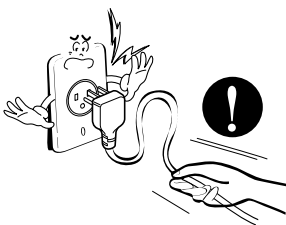

Turn off the main power switch when not using it for a long time.

- Prevent accidental startup and the possibility of injury.

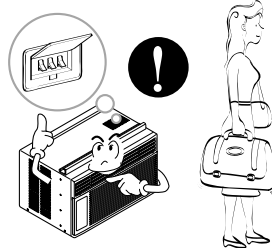

Do not place heavy object on the power cord and take care so that the cord should not be pressed.

- There is danger of fire or electric shock.

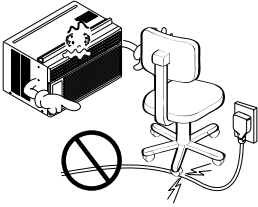

If water enters the product, turn off the the power switch of the main body of appliance. Contact service center after taking the power-plug out from the socket.



Do not clean the air conditioner with water.

- Water may enter the unit and degrade the insulation. It may cause an electric shock.

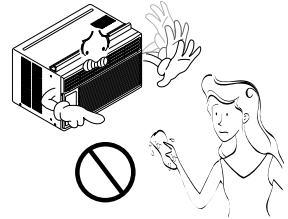

Turn off the power and breaker firstly when cleansing the unit.

- Since the fan rotates at high speed during operation, it may cause injury.



Do not put a pet or house plant where it will be exposed to direct air flow.

- This could injure the pet or plant.

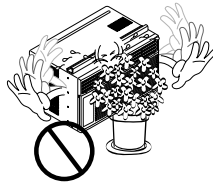

Do not use this appliance for special purposes such as pets, foods, precision machinery, or objects of art.

- It is an air conditioner, not a precision refrigeration system.

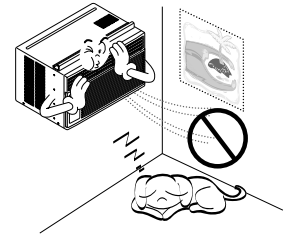

Always insert the filter securely. Clean it every two weeks.

- Operation without filters will cause failure.



Use a soft cloth to clean. Do not use wax, thinner, or a strong detergent.

- The appearance of the air conditioner may deteriorate, change color, or develop surface flaws.

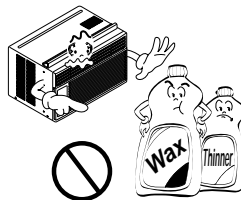

Do not drink water drained from air conditioner. / Do not direct airflow at room occupants only.

- It contains contaminants and will make you sick. / This could damage your health.

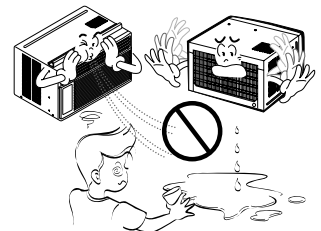

Preparing for operation

- 1 Contact an installation specialist for installation.
- 2 Plug in the power plug properly.
- 3 Do not share the same outlet with other appliances
- 4 Do not use an extension cord.
- 5 Do not start/stop operation by plugging/unplugging the power cord.
- 6 If cord/plug is damaged, replace only with an authorized part.

Usage

- 1 Being exposed to direct airflow for an extended period of time could be hazardous to your health. Do not expose occupants, pets, or plants to direct airflow for extended periods of time.
- 2 Due to the possibility of oxygen deficiency, ventilate the room when using together with stoves or other heating devices.
- 3 Do not use this air conditioner for non-specified special purposes (e.g. preserving precision devices, food, pets, plants, and art objects). Usage in such a manner could harm such property.

Cleaning and maintenance

- 1 Do not touch the metal parts of the unit when removing the filter. Injuries can occur when handling sharp metal edges.
- 2 Do not use water to clean inside the air conditioner. Exposure to water can destroy the insulation, leading to possible electric shock.
- 3 When cleaning the unit, first make sure that the power and breaker are turned off. The fan rotates at a very high speed during operation. There is a possibility of injury if the unit's power is accidentally triggered on while cleaning inner parts of the unit.

Service

For repair and maintenance, contact your authorized service dealer.

The remote control and control panel will look like those represented in the following pictures.

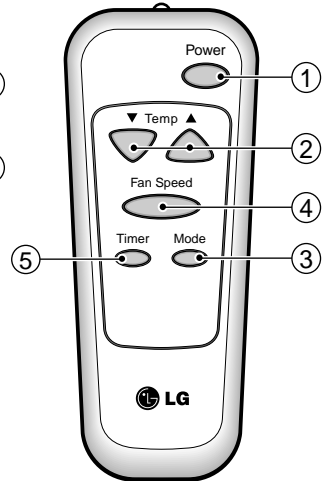
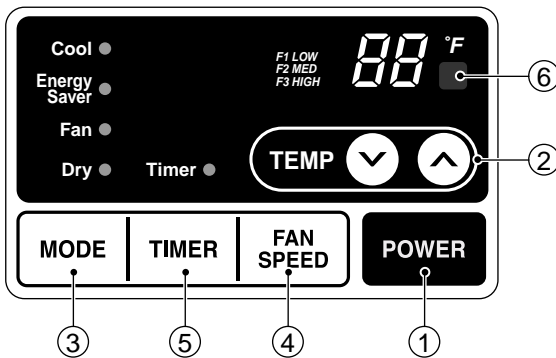
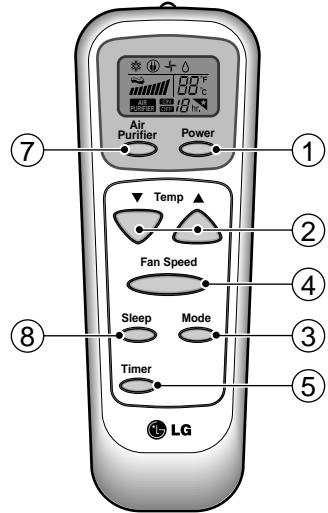
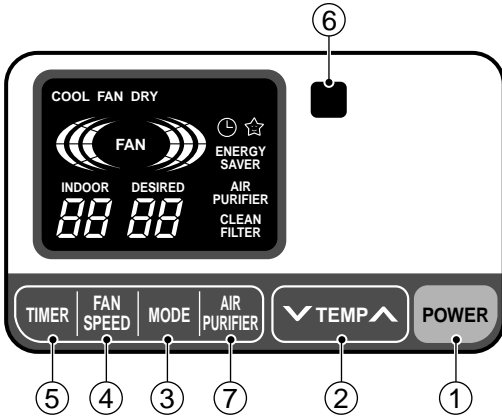

Remote Control Operations

1 POWER

Operation starts when this button is pressed and stops when you press the button again.

2 TEMPERATURE CONTROL

The thermostat monitors room temperature to maintain the desired temperature.

The thermostat can be set between 60°F~86°F (16°C~30°C).

The unit takes an average of 30 minutes to adjust the room temperature by 1°F.

3 OPERATION MODE SELECTOR

Select cooling mode to cool the room.

Select energy saver mode for energy saving operation.

Select fan mode for basic ventilating fan operation. Select dry mode for dry operation.

4 FAN SPEED SELECTOR

For increased power while cooling, select a higher fan speed.

3 steps: High → Low → Med

5 ON/OFF TIMER

The timer can be set to start and stop the unit in hourly increments (up to 12 hours).

6 REMOTE CONTROL SENSOR

NOTICE : CLEAN FILTER

You can see "CLEAN FILTER" display after 1000 hours that it is the time of cleaning filter when operating in Air purifier.

AUTO RESTART

In failure of electric power, the unit runs as previous setting operation.

7 AIR PURIFIER

- Press the Air Purifier button. Operation will start when the button is pressed and stop when the button is pressed again.

- Set the fan speed again with the remote control. You can select the fan speed in three steps-high, low or medium.

Each time the button is pressed, the fan speed mode is shifted.

- If you press the only Air Purifier button, only air purifying operates without cooling. Then, fan speed is low.

You can select the fan speed in three steps; high, low, or medium.

Each time the fan speed button is pressed, the fan speed mode is shifted.

8 SLEEP MODE

- Press the sleep mode button to set the time you want the unit to turn off automatically.

- Every time you push this button, the remaining time will be set as follows. (1Hour → 2Hours → 3Hours → 4Hours → 5Hours → 6Hours → 7Hours → 0Hours → 1Hour → 2Hours → ...)

Inserting the Remote Control Batteries

1 Push out the cover on the back of the remote control with your thumb

2 Pay attention to polarity and insert two new AAA 1.5V batteries.

3 Reattach the cover.

NOTICE : Do not use rechargeable batteries. Make sure that both batteries are new.

- In order to prevent discharge, remove the batteries from the remote control if the air conditioner is not going to be used for an extended period of time

Keep the remote control away from extremely hot or humid places.

To maintain optimal operation of the remote control, the remote sensor should not be exposed to direct sunlight.

- The remote control can be mounted on a wall using the mountable holder.

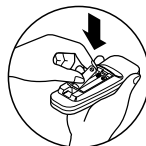

Vent Control

For maximum cooling efficiency, CLOSE the vent. This will allow internal air circulation.

OPEN the vent to discharge stale air.

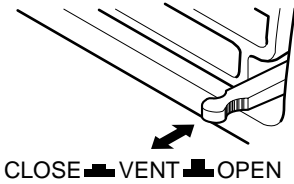

NOTICE : Before using the ventilation feature, position the vent lever by pulling Part A out straight and snapping it into place.

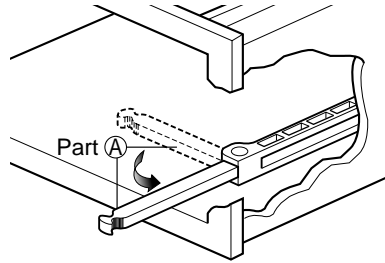

Adjusting the Air Flow Direction

Airflow can be adjusted by changing the direction of the air conditioner's louvers. This can also increase the cooling efficiency of the air conditioner.

• Adjusting Horizontal Air Flow Direction

Adjusting the vertical louvers left and right will change horizontal airflow.

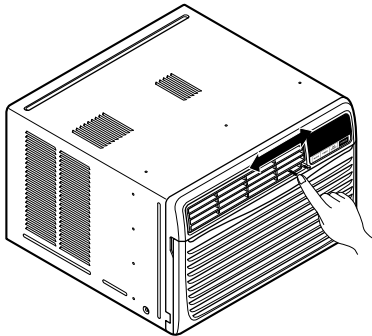

Adjusting horizontal air flow

• Adjusting Vertical Air Flow Direction

Adjusting the horizontal vane up and down will change vertical airflow. The vane can be adjusted by nudging the vane backward or forward.

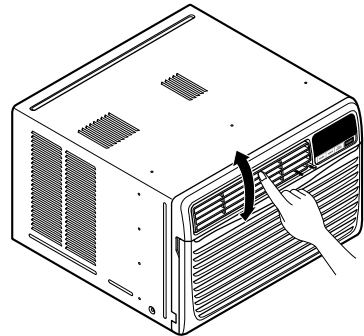

Adjusting vertical air flow

• Recommended orientation of louvers

Adjust louvers to face upwards when cooling to maximize cooling efficiency.

Turn the power off and unplug the power plug before cleaning the air conditioner.

Air Filter

The air filter behind the inlet grille should be checked and cleaned at least once every 2 weeks (or as necessary) to maintain optimal performance of the air conditioner.

How to remove the air filter

- 1 The grille may be opened from the top for easy maintenance after installation.
- 2 Open the inlet grille by pulling off the exposed door on the top of the unit (based on installation).
- 3 Pull the tab slightly to release the filter. Pull the filter in the same direction as the opening.
- 4 Clean the filter with warm, soapy water. The water should be below 40°C (104°F).
- 5 Rinse off and gently shake off excess water from the filter. Let it dry before replacing it.

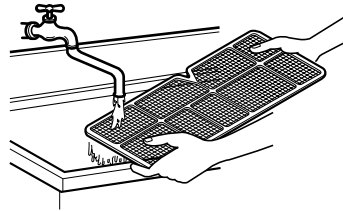
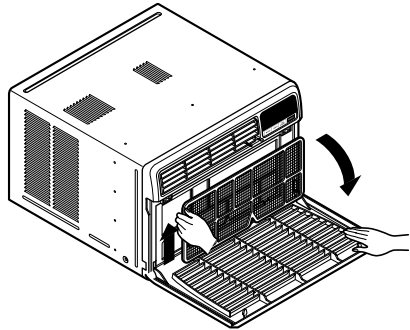

Drainage

The base pan may overflow due to high humidity. To drain the excess water, remove the drain cap from the back of the unit and secure the drainpipe.

When pressing the drainpipe into place, apply force in the direction away from the fins to avoid injuring yourself.

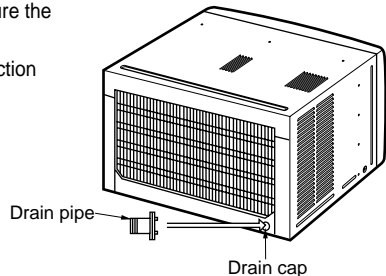

Air Purifying Filter (Optional)

The Air Purifying filter behind the air filter should be checked and cleaned once every 3 months or more often if necessary.

- 1 After removing the Air Purifying Filter, pull slightly forward to remove the Air Purifying filter.
- 2 Soak the Air Purifying Filter in water mixed with a mild detergent for 20–30 minutes.
- 3 Dry the Air Purifying Filter in the shade for a day. (The moisture must be removed completely on this part.)
- 4 Note the cuts of electric discharge lines.
- 5 Re-install the Air Purifying Filter to the original position.

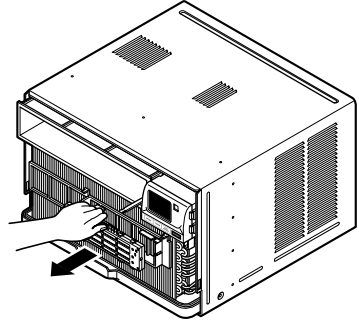

WARNING: Don't touch this Air Purifying Filter within 10 seconds after opening the inlet grille; it may cause an electric shock. least 3 minutes before resetting to the cooling operation again.

How to Attach Drain Pan (Optional)

The air conditioner employs a proper drain method whereby the condensed water (moisture removed from the air) is drained to the outside.

In very humid weather, (and for reverse cycle models in the reverse mode) excessive condensate water removed from the air may cause some water to collect. To remove this excess water you can install the drain pan as detailed below.

- 1 Take the drain pan which is located in the air discharge.
- 2 Remove the hole rubber from the base-pan (for some models).
- 3 Install the drain pan to the right corner of the cabinet with 4 (or 2) screws.
- 4 Connect the drain hose of 3/5" inside diameter to the outlet located at the bottom of the drain pan. You can purchase the drain hose or tubing locally to satisfy your particular needs. (Drain hose is not supplied).

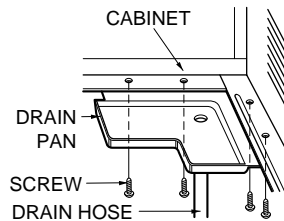

Product Features



CAUTION: This appliance should be installed in accordance with national wiring regulations. The following information serves acts as a guide to help to explain product features.

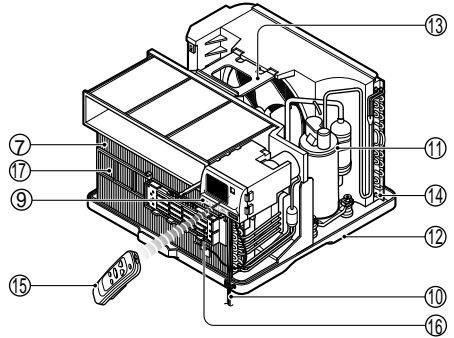
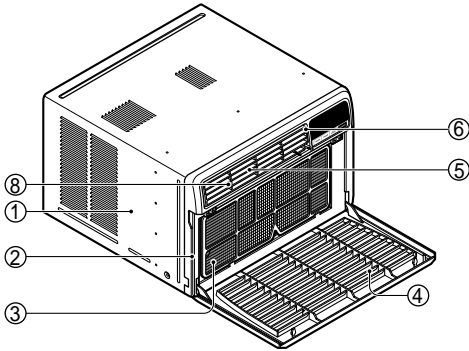

- 1. CABINET
- 2. FRONT GRILLE
- 3. AIR FILTER
- 4. AIR INTAKE (INLET GRILLE)
- 5. AIR DISCHARGE
- 6. VERTICAL AIR DEFLECTOR (HORIZONTAL LOUVER)
- 7. EVAPORATOR
- 8. HORIZONTAL AIR DEFLECTOR (VERTICAL LOUVER)

- 9. CONTROL PANEL
- 10. POWER CORD
- 11. COMPRESSOR
- 12. BASE PAN
- 13. BRACE
- 14. CONDENSER
- 15. REMOTE CONTROLLER
- 16. AIR PURIFYING FILTER (Optional)
- 17. CASE, FILTER (Optional)

Installing the Power cord

You can choose between two methods below according to your window stool shape and preference.

Using slit "A"

- Fasten the stopper using 2 screw holes, and lead out the power cord through slit "A".

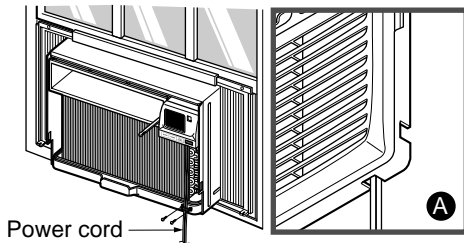

Power cord

Using slit "B"

- Fasten the stopper using left screw hole, and rotate properly to lead the power cord out through slit "B".

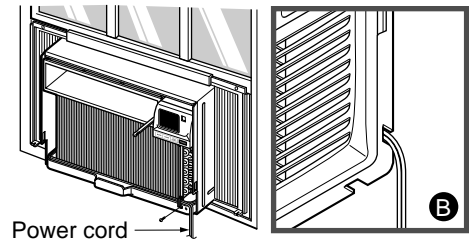

Power cord

How to Install the Unit

- 1 To prevent vibration and noise, make sure the unit is installed securely and firmly.
- 2 Install the unit where the sunlight does not shine directly on the unit.
- 3 The outside of the cabinet must extend outward for at least 12" and there should be no obstacles, such as a fence or wall, within 20" from the back of the cabinet because it will prevent heat radiation of the condenser. Restriction of outside air will greatly reduce the cooling efficiency of the air conditioner.

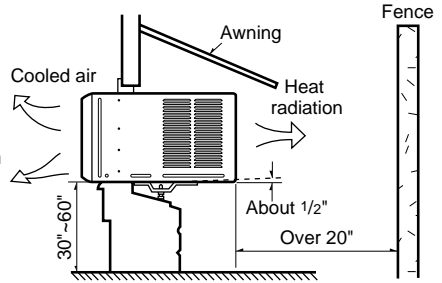

CAUTION: All side louvers of the cabinet must remain exposed to the outside of the structure.

- 4 Install the unit a little slanted so the back is slightly lower than the front (about 1/2"). This will force condensed water to flow to the outside.
- 5 Install the unit with the bottom about 30"~60" above the floor level.

Window Requirements

NOTICE : All supporting parts should be secured to firm wood, masonry, or metal.

- This unit is designed for installation in standard double hung windows with actual opening widths from 25" to 36".
- The top and bottom window sash must open sufficiently to allow a clear vertical opening of 15" from the bottom of the upper sash to the window stool.

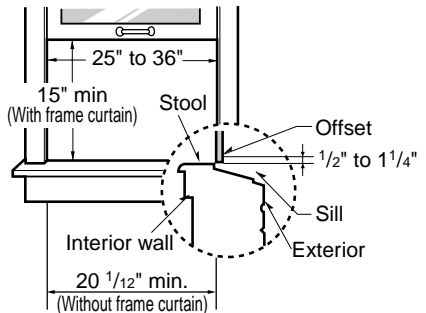

How to Install the Unit

- 1 To prevent vibration and noise, make sure the unit is installed securely and firmly
- 2 Install the unit where the sunlight does not shine directly on the unit.
- 3 The outside of the cabinet must extend outward for at least 12" and there should be no obstacles, such as a fence or wall, within 20" from the back of the cabinet because it will prevent heat radiation of the condenser. Restriction of outside air will greatly reduce the cooling efficiency of the air conditioner.

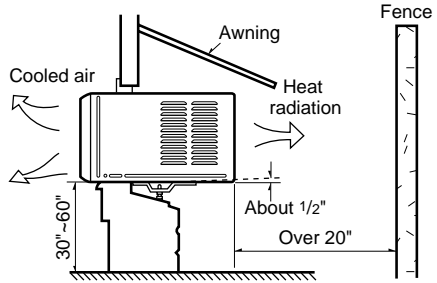

CAUTION: All side louvers of the cabinet must remain exposed to the outside of the structure.

- 4 Install the unit a little slanted so the back is slightly lower than the front (about 1/2"). This will force condensed water to flow to the outside.
- 5 Install the unit with the bottom about 30"–60" above the floor level.

Window Requirements

NOTICE : All supporting parts should be secured to firm wood, masonry, or metal.

- This unit is designed for installation in standard double hung windows with actual opening widths from 27" to 39"
- The top and bottom window sash must open sufficiently to allow a clear vertical opening of 16" from the bottom of the upper sash to the window stool.

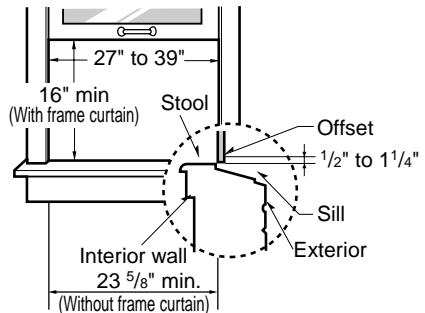

How to Install the Unit

- 1 To prevent vibration and noise, make sure the unit is installed securely and firmly.
- 2 Install the unit where the sunlight does not shine directly on the unit.
- 3 There should be no obstacles, such as a fence and wall, within 20" from the back of the cabinet because it will prevent heat radiation of the condenser. Restriction of outside air will greatly reduce the cooling efficiency of the air conditioner.

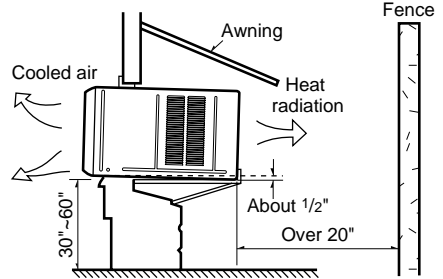

CAUTION: All side louvers of the cabinet must remain exposed to the outside of the structure.

- 4 Install the unit a little slanted so the back is slightly lower than the front (about 1/2"). This will force condensed water to flow to the outside.
- 5 Install the unit with the bottom about 30"~60" above the floor level.

Window Requirements

NOTICE : All supporting parts should be secured to firm wood, masonry, or metal.

- This unit is designed for installation in standard double hung windows with actual opening widths from 29" to 41".
- The top and bottom window sash must open sufficiently to allow a clear vertical opening of 18" from the bottom of the upper sash to the window stool.

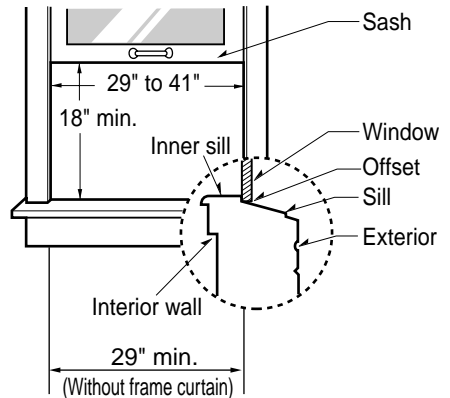

Installation Kits Contents

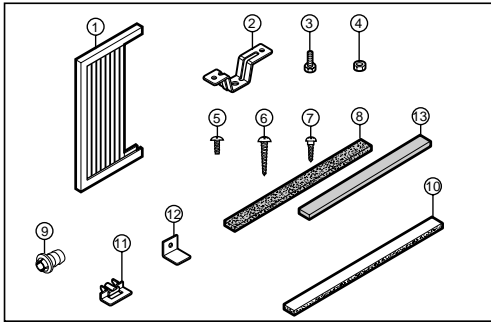

NO.	NAME OF PARTS	Q'TY
1	FRAME CURTAIN	2
2	SILL SUPPORT	2
3	BOLT	2
4	NUT	2
5	SCREW (TYPE A)	16
6	SCREW (TYPE B)	3
7	SCREW (TYPE C)	5
8	FOAM-STRIP	1
9	DRAIN PIPE	1
10	FOAM-PE	1
11	FRAME GUIDE	2
12	WINDOW LOCKING BRACKET	1
13	FOAM-PE	1

Suggested Tool Requirements

SCREWDRIVER(Philips and Flatead), RULER, KNIFE, HAMMER, PENCIL, LEVEL

PREPARATION OF CHASSIS

- 1 Remove the screws which fasten the cabinet at both sides and at the back.
- 2 Slide the unit from the cabinet by gripping the base pan handle and pulling forward while bracing the cabinet.
- 3 Cut the window sash seal to the proper length. Peel off the backing and attach the Foam-PE 13 to the underside of the window sash.
- 4 Remove the backing from the top upper guide Foam-PE 10 and attach it to the bottom of the Upper Guide.
- 5 Attach the upper guide onto the top of the cabinet with 3 Type A screws 5.
- 6 Insert the Frame Guides 11 into the bottom of the cabinet.
- 7 Insert the Frame Curtain 1 into the Upper Guide and Frame Guides 11.
- 8 Fasten the curtains to the unit with 4 Type A screws 5.

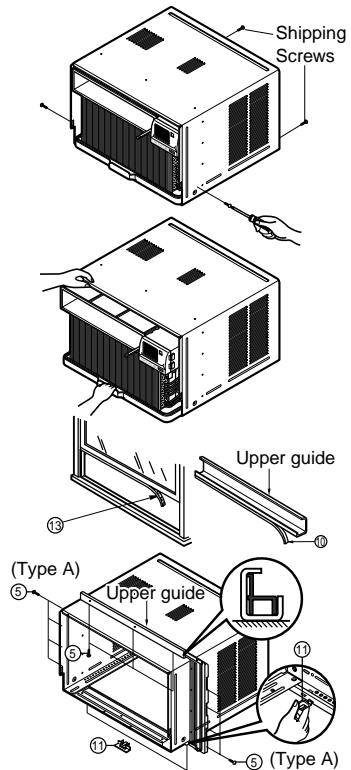

Cabinet Installation

- 1 Open the window. Mark a line on center of the window stool.
Carefully place the cabinet on the window stool and align the center mark on the bottom front with the center line marked in the window stool.

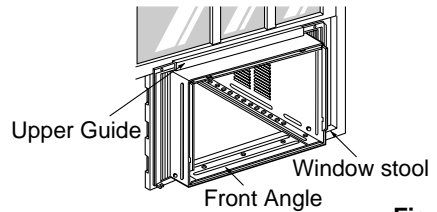

Fig. 1

- 2 Pull the bottom window sash down behind the Upper Guide until it meets.

NOTICE : Do not pull the window sash down tightly that the movement of Frame Curtain ① is restricted.

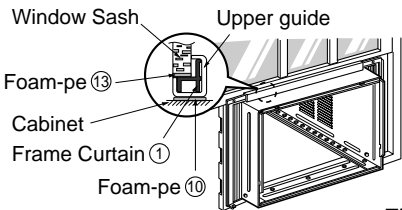

Fig. 2

- 3 Loosely assemble the Sill Support ② using the parts in Fig. 3.

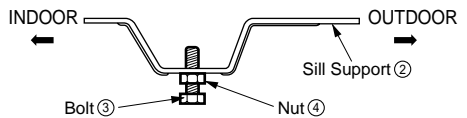

Fig. 3

- 4 Select the position that will place the Sill Support ② near the outer most point on sill (See Fig. 4)

NOTICE : Be careful when you install the cabinet (Frame Guides ⑪ are broken easily).

- 5 Attach the Sill Support ② to the cabinet track hole in relation to the selected position using 2 Type A screws in each support (See Fig. 4).

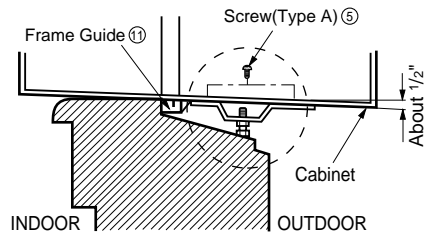
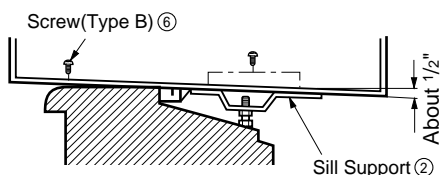
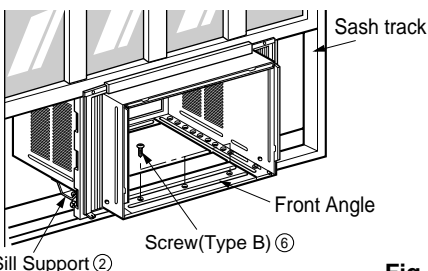

Fig. 4

- 6 The cabinet should be installed with a very slight tilt (about 1/2") downward toward the outside (See Fig. 5).
Adjust the bolt and the nut of Sill Support ② for balancing the cabinet.



- 7 Attach the cabinet to the window stool by driving the screws ⑥ (Type B: Length 16mm (5/8 inch) and below.) through the front angle into window stool.



- 8 Pull each Frame Curtain ① fully to each window sash track, and repeat step 2.

- 9 Attach each Frame Curtain ① the window sash using screws ⑦ (Type C). (See Fig. 6)



CAUTION: Do not drill a hole in the bottom pan. The unit is designed to operate with approximately 1/2" of water in bottom pan. There is no need to add water if the pan is dry.

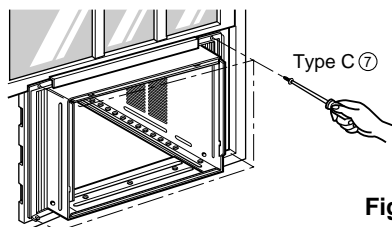

Fig. 5

Fig. 6

- 10 Slide the unit into the cabinet. (See Fig. 7)



CAUTION: For security purpose, reinstall screws (Type A) at cabinet's sides.

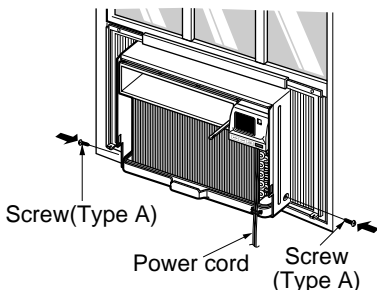

Fig. 7

- 11 Cut the Foam-Strip ⑧ to the proper length and insert between the upper window sash and the lower window sash. (See Fig. 8)

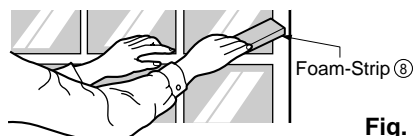

Fig. 8

- 12 Attach the Window Locking Bracket 12 with a Type C screw 7. (See Fig. 9)

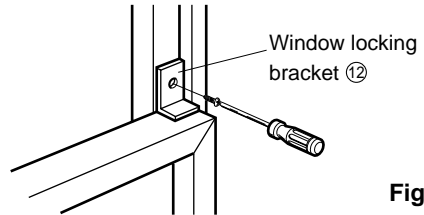

Fig. 9

- 13 Attach the front grille to the cabinet by inserting the tabs on the grille into the tabs on the front of the cabinet. Push the grille in until it snaps into place. (See Fig. 10)

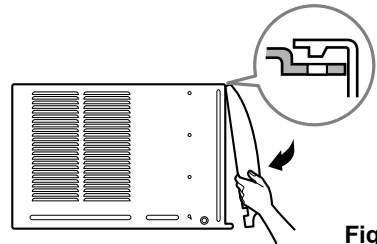

Fig. 10

- 14 Pull down the inlet grille and secure it with a Type A screw 5 through the front grille. (See Fig. 11)
- 15 Window installation of room air conditioner is now completed. See ELECTRICAL DATA for attaching power cord to electrical outlet.

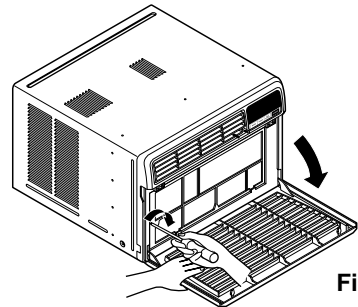
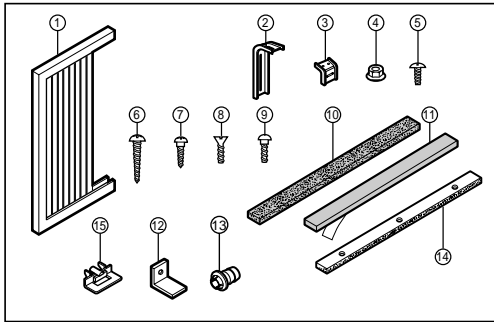

Fig. 11

Installation Kits Contents



NO.	NAME OF PARTS	Q'TY
1	FRAME CURTAIN	2
2	SUPPORT BRACKET	2
3	SILL BRACKET	2
4	LOCK NUT	4
5	SCREW (TYPE A)	14
6	SCREW (TYPE B)	7
7	SCREW (TYPE C)	5
8	SCREW (TYPE D)	2
9	CARRIAGE BOLT	2
10	FOAM STRIP	1
11	FOAM SEAL	1
12	WINDOW LOCKING BRACKET	1
13	DRAIN PIPE	1
14	FOAM-PE	1
15	FRAME GUIDE	2

Suggested Tool Requirements

SCREWDRIVER(Philips and Flatead), RULER, KNIFE, HAMMER, PENCIL, LEVEL

PREPARATION OF CHASSIS

- 1 Remove the screws which fasten the cabinet at both sides and at the back.
- 2 Slide the unit from the cabinet by gripping the base pan handle and pulling forward while bracing the cabinet.
- 3 Cut the window sash seal to the proper length. Peel off the backing and attach the Foam-Seal 11 to the underside of the window sash.
- 4 Remove the backing from the top upper guide Foam-PE 14 and attach it to the bottom of the Upper Guide.
- 5 Attach the upper guide onto the top of the cabinet with 3 Type A screws 5.
- 6 Insert the Frame Guides 15 into the bottom of the cabinet.
- 7 Insert the Frame Curtain 1 into the Upper Guide and Frame Guides 15.
- 8 Fasten the curtains to the unit with 10 Type A screws 5.

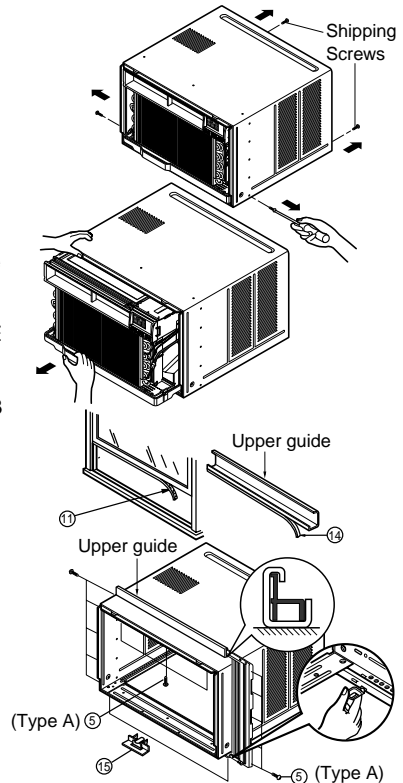

Cabinet Installation

- 1 Open the window. Mark a line on the center of the window stool between the side window stop moldings. Loosely attach the sill bracket to the support bracket using the carriage bolt and the lock nut.

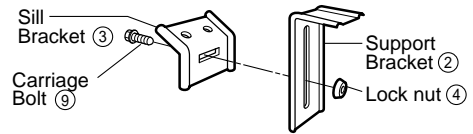

Fig. 12

- 2 Attach the sill bracket to the window sill using the screws (Type B). Carefully place the cabinet on the window stool and align the center mark on the bottom front with the center line marked window stool.

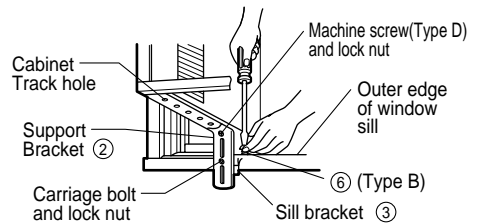

Fig. 13

- 3 Using the M-screw and the lock nut, attach the support bracket to the cabinet track hole. Use the first track hole after the sill bracket on the outer edge of the window sill. Tighten the carriage bolt and the lock nut. Be sure the cabinet slants outward.

CAUTION: Do not drill a hole in the bottom pan. The unit is designed to operate with approximately 1/2" of water in bottom pan.

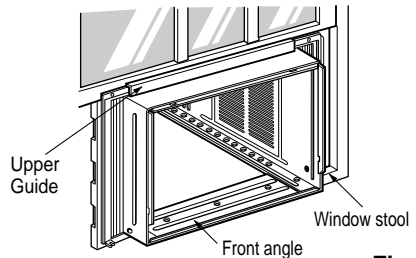

Fig. 14

- 4 Pull the bottom window sash down behind the Top retainer bar until they meet.

NOTICE : 1. Do not pull the window sash down so tightly that the movement of Frame curtain is restricted.

Attach the cabinet to the window stool by driving the screws (Type B) through the cabinet into window stool.

2. The cabinet should be installed with a very slight tilt downward toward the outside.

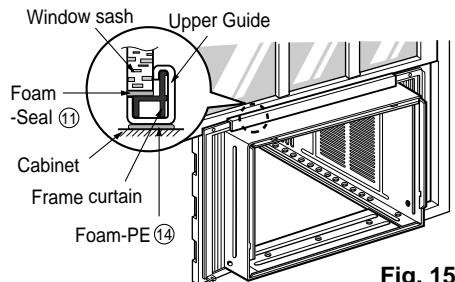

Fig. 15

- 5 Pull each Frame curtain fully to each window sash track, and pull the bottom window sash down behind the Top retainer bar until it meets.

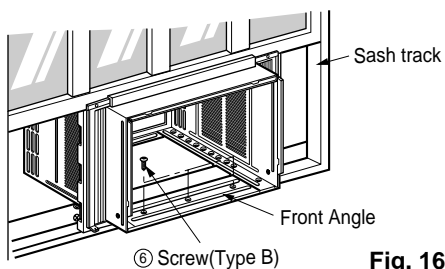

Fig. 16

- 6 Attach each Frame curtain the window sash by using screws (Type C.) (See Fig. 17)

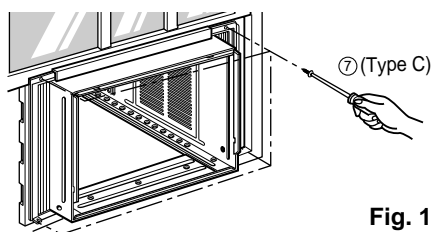

Fig. 17

- 7 Slide the unit into the cabinet. (See Fig. 18)

CAUTION: For security purpose, reinstall screws (Type A) at cabinet's sides.

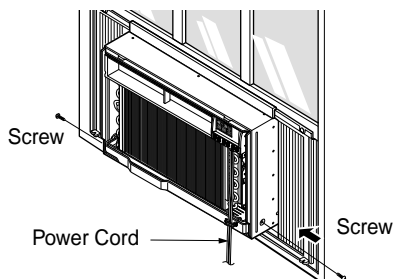

Fig. 18

- 8 Cut the Foam-strip to the proper length and insert between the upper window sash and the lower window sash. (See Fig. 19)

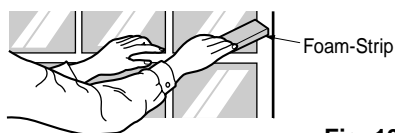

Fig. 19

- 9 Attach the Window locking bracket with a screw (Type C.) (See Fig. 20)

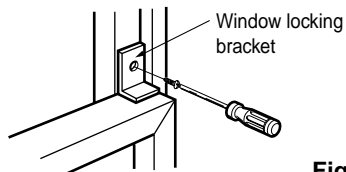
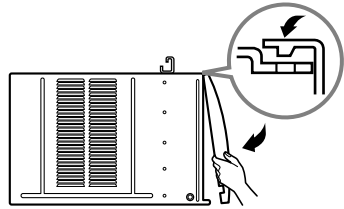

Fig. 20

- 10 Attach the front grille to the cabinet by inserting the tabs on the grille into the tabs on the front of the cabinet. Push the grille in until it snaps into place. (See Fig. 21)



- 11 Lift the inlet grille and secure it with a screw (Type A) through the front grille. (See Fig. 21)

- 12 Window installation of room air conditioner is now completed. See ELECTRICAL DATA for attaching power cord to electrical outlet.

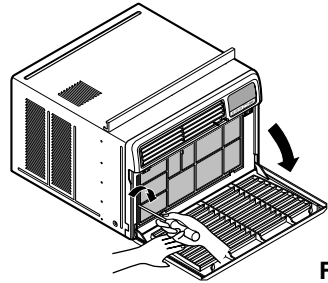



Fig. 21



Electrical Data

Line Cord Plug	Use Wall Receptacle	Power Supply
 <p>Do not under any circumstances cut or remove the grounding prong from the plug.</p> <p>Power supply cord with 3-prong grounding plug</p>	 <p>Standard 125V, 3-wire grounding receptacle rated 15A, 125V AC</p>	<p>Use 15 AMP, time delay fuse or circuit breaker.</p>

Use of extension cords

- Because of potential safety hazards, we strongly discourage the use of an extension cord. However, if you wish to use an extension cord, use a CSA certified/UL-listed 3-wire (grounding) extension cord, rated at 15A, 125V.

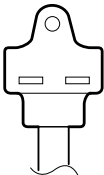
Electrical Data (L1804R, LW1800ER MODELS)

Line Cord Plug	Use Wall Receptacle	Power Supply
	<p>230V/208V</p>  <p>tandem type</p>	<p>Use 15 AMP circuit. Refer to nameplate for correct fusing.</p>

All wiring should be made in accordance with local electrical codes and regulations.

NOTICE : Aluminum house wiring may pose special problems. Consult a qualified electrician.

Electrical Safety

IMPORTANT (PLEASE READ CAREFULLY)

FOR THE USER'S PERSONAL SAFETY, THIS APPLIANCE MUST BE PROPERLY GROUNDED

The power cord of this appliance is equipped with a three-prong (grounding) plug. Use this with a standard three-slot (grounding) wall power outlet (Fig. 22) to minimize the hazard of electric shock. The customer should have the wall receptacle and circuit checked by a qualified electrician to make sure the receptacle is properly grounded.

PREFERRED METHOD

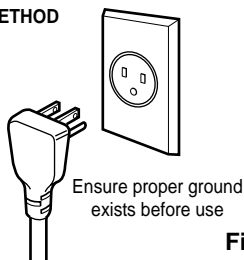

Fig. 22

DO NOT CUT OR REMOVE THE THIRD (GROUND) PRONG FROM THE POWER PLUG.

A. SITUATIONS WHEN THE APPLIANCE WILL BE DISCONNECTED OCCASIONALLY:

TEMPORARY METHOD

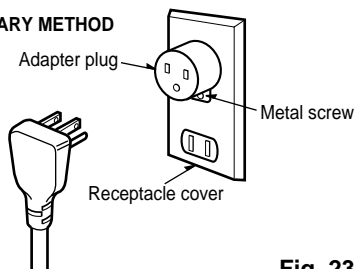

Fig. 23

Because of potential safety hazards, we strongly discourage the use of an adapter plug. However, if you wish to use an adapter, a TEMPORARY CONNECTION may be made. Use UL-listed adapter, available from most local hardware stores (Fig. 23). The large slot in the adapter must be aligned with the large slot in the receptacle to assure a proper polarity connection.



CAUTION: Attaching the adapter ground terminal to the wall receptacle cover screw does not ground the appliance unless the cover screw is metal, and not insulated, and the wall receptacle is grounded through the house wiring. The customer should have the circuit checked by a qualified electrician to make sure the receptacle is properly grounded.

Disconnect the power cord from the adapter, using one hand on each. Otherwise, the adapter ground terminal might break. **DO NOT USE** the appliance with a broken adapter plug.

B. SITUATIONS WHEN THE APPLIANCE WILL BE DISCONNECTED OFTEN.

Do not use an adapter plug in these situations. Unplugging the power cord frequently can lead to an eventual breakage of the ground terminal. The wall power outlet should be replaced by a three-slot (grounding) outlet instead.

USE OF EXTENSION CORDS

Because of potential safety hazards, we strongly discourage the use of an extension cord. However, if you wish to use an extension cord, use a CSA certified/UL-listed 3-wire (grounding) extension cord, rated at 15A, 125V.

Electrical Safety (L1804R, LW1800ER MODELS)

IMPORTANT (PLEASE READ CAREFULLY)

FOR THE USER'S PERSONAL SAFETY, THIS APPLIANCE MUST BE PROPERLY GROUNDED

The power cord of this appliance is equipped with a three-prong (grounding) plug. Use this with a standard three-slot (grounding) wall power outlet (Fig. 24) to minimize the hazard of electric shock. The customer should have the wall receptacle and circuit checked by a qualified electrician to make sure the receptacle is properly grounded.

PREFERRED METHOD

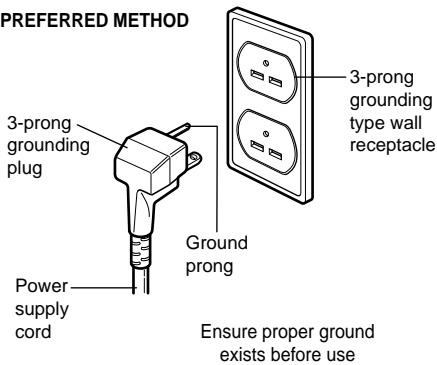

Fig. 24

DO NOT CUT OR REMOVE THE THIRD (GROUND) PRONG FROM THE POWER PLUG.

FUSE – Use a time-delay fuse or circuit breaker. Refer to serial plate for proper power supply requirements.

230, 208, and 230/208 VOLT UNITS

These units are equipped with a three-prong grounding plug on the power supply cord, which must be plugged into a matching properly grounded three-prong wall receptacle for your protection against possible shock hazard. If such an outlet is not present, one must be installed by a qualified electrician in accordance with the National Electrical Code and local codes and ordinances.

NOTICE : DO NOT USE AN EXTENSION CORD
on 230, 208, and 230/208 Volt units.

Before calling for service, please review the following list of common problems and solutions.

The air conditioner is operating normally when:

- You hear a pinging noise. This is caused by water being picked up by the condenser on rainy days or in highly humid conditions. This feature is designed to help remove moisture in the air and improve cooling efficiency.
- You hear the thermostat click. This is caused by the compressor cycle starting and stopping.
- You see water dripping from the rear of the unit. Water may be collected in the base pan in highly humid conditions or on rainy days. This water overflows and drips from the rear of the unit.
- You hear the fan running while the compressor is silent. This is a normal operational feature.

The air conditioner may be operating abnormally when:

Problem	Possible Causes	What To Do
The air conditioner does not operate at all	■ The air conditioner is unplugged or not plugged in completely	• Make sure the plug is completely plugged into the outlet
	■ The fuse is blown/circuit breaker is triggered	• Check the fuse/circuit breaker box and replace the fuse or reset the breaker
	■ Power failure.	• In the event of a power failure, set the power control to OFF. When the power is restored, wait 3 minutes to restart the air conditioner to prevent the compressor from overloading
Air conditioner does not cool	■ Air flow is restricted	• Make sure there are no curtains, blinds, furniture or other obstacles in front of the air conditioner
	■ The THERMOSTAT may not be set cool enough	• Turn the knob to a higher setting. The highest setting provides maximum cooling
	■ The air filter is dirty.	• Clean the filter at least every 2 weeks. Refer to the "Care and Maintenance" section (p.11) of the manual.
	■ The air conditioner was just turned on.	• After the air conditioner is turned on, you need to give the air conditioner some time to cool the room.
	■ Cold air is escaping.	• Check for open furnace floor registers and cold air returns. • CLOSE the air conditioner vent
	■ Cooling coils are iced up	• See Ice appears on the air conditioner below
Ice appears on the air conditioner.	■ The cooling coils are iced over.	• Ice may block the air flow and obstruct the air conditioner from properly cooling the room. Set the fan at MED or HIGH while setting the thermostat at 1 or 2 until the ice melts.

* You can refer to the Energy Star program in detail at "www.energystar.gov".

LG ROOM AIR CONDITIONER LIMITED WARRANTY – USA

LG Electronics Inc. will repair or at its option replace, without charge, your product if it proves to be defective in material or workmanship under normal use during the warranty period set forth below, effective from the date of original consumer purchase of the product. This limited warranty is good only to the original purchaser of the product and effective only when used in the United States including Alaska, Hawaii, and U.S. Territories.

<p><u>WARRANTY PERIOD:</u></p> <p>Labor: 2 Years from the Date of Purchase.</p> <p>Parts: 2 Years from the Date of Purchase.</p> <p>Compressor: 5 Years from the Date of Purchase.</p>	<p><u>HOW SERVICE IS HANDLED:</u></p> <p>Call 1-877-714-7486 and choose the appropriate prompt. Please have product type (Room Air Conditioner), model number, serial number, and ZIP/postal code ready.</p> <p>The warranted labor covers the cost of In-Home Service on all parts including the compressor.</p>
--	--

THIS WARRANTY IS IN LIEU OF ANY OTHER WARRANTIES, EXPRESS OR IMPLIED, INCLUDING WITHOUT LIMITATION, ANY WARRANTY OF MERCHANTABILITY OR FITNESS FOR A PARTICULAR PURPOSE. TO THE EXTENT ANY IMPLIED WARRANTY IS REQUIRED BY LAW, IT IS LIMITED IN DURATION TO THE EXPRESS WARRANTY PERIOD ABOVE. LG WILL NOT BE LIABLE FOR ANY CONSEQUENTIAL, INDIRECT, OR INCIDENTAL DAMAGES OF ANY KIND, INCLUDING LOST REVENUES OR PROFITS, IN CONNECTION WITH THE PRODUCT. SOME STATES DO NOT ALLOW LIMITATION ON HOW LONG AN IMPLIED WARRANTY LASTS OR THE EXCLUSION OF INCIDENTAL OR CONSEQUENTIAL DAMAGES, SO THE ABOVE LIMITATIONS OR EXCLUSIONS MAY NOT APPLY TO YOU.

THIS LIMITED WARRANTY DOES NOT APPLY TO:

1. Service trips to your home to deliver, pick up, and/or install the product, instruct, or replace house fuses or correct wiring, or correction of unauthorized repairs; and
2. Damages or operating problems that result from misuse, abuse, operation outside environmental specifications or contrary to the requirements or precautions in the Operating Guide, accident, vermin, fire, flood, improper installation, acts of God, unauthorized modification or alteration, incorrect electrical current or voltage, or commercial use, or use for other than intended purpose.
3. Therefore, the cost of repair or replacement of such a defective product shall be borne by the consumer.

CUSTOMER INTER-ACTIVE CENTER NUMBERS:

<p>To Prove Warranty Coverage</p>	<p>Retain your Sales Receipt to prove date of purchase. A copy of your Sales Receipt must be submitted at the time warranty service is provided.</p>
<p>To Obtain Nearest Authorized Service Center or Sales Dealer, or to Obtain Product, Customer, or Service Assistance</p>	<p>Call 1-877-714-7486, 24 hrs a day, 7 days per week. Press the appropriate option, and please have your product type (AIR CONDITIONER), and ZIP/postal code ready.</p>

Free Manuals Download Website

<http://myh66.com>

<http://usermanuals.us>

<http://www.somanuals.com>

<http://www.4manuals.cc>

<http://www.manual-lib.com>

<http://www.404manual.com>

<http://www.luxmanual.com>

<http://aubethermostatmanual.com>

Golf course search by state

<http://golfingnear.com>

Email search by domain

<http://emailbydomain.com>

Auto manuals search

<http://auto.somanuals.com>

TV manuals search

<http://tv.somanuals.com>