



Visit us at : <http://www.lgservice.com>

LG

LG

AHU CONTROL KIT

Owner's Manual

**Models: PRCKD20E
PRCKD40E**

ENGLISH

ITALIANO

ESPAÑOL

FRANÇAIS

PORTUGUESE

IMPORTANT

- Please read this installation manual completely before installing the product.
- Installation work must be performed in accordance with the national wiring standards by authorized personnel only.
- Please retain this installation manual for future reference after reading it thoroughly.



TABLE OF CONTENTS

- Safety Precautions.....3
- Necessary sensor by operating mode6
- Part Description7
- Basic operation of wired remote controller.....8
- Main function of wired remote controller9
- Supplementary function of wired remote controller11
 - Humidifier11
 - Desired humidity control12
 - Auto ventilaton13
 - Desired CO₂ level control14
- Reservation function of wired remote controller15
 - Changing Current Time15
 - Programming : Setting Simple Reservation.....17
 - Programming : Setting ON Reservation.....18
 - Programming : Setting OFF Reservation.....19
 - Programming : Weekly Reservation.....20
 - Programming : Holiday Reservation.....22
- Setting function of wired remote controller installation23
 - How to start installation setting mode23
 - Setting function by code24
 - Central control address setting.....25
 - Damper opening setting26
 - Remote control Master/Slave setting28
- Manual operating mode.....29
 - SA fan operation29
 - RA fan operation29
- Check before requesting for service30
- Test run31
 - Self diagnosis function.....31

Safety Precautions

To prevent injury to the user or other people and property damage, the following instructions must be followed.

■ Incorrect operation due to ignoring instruction will cause harm or damage. The seriousness is classified by the following indications.

 WARNING	This symbol indicates the possibility of death or serious injury.
 CAUTION	This symbol indicates the possibility of injury or damage.

■ Meanings of symbols used in this manual are as shown below.

	Be sure not to do.
	Be sure to follow the instruction.

WARNING

■ Installation

- | | | |
|-----------------------------------------------------------------------------------------------------------------------------------------------------------------------------------------------------------------------------------------------------------------------|----------------------------------------------------------------------------------------------------------------------------------------------------------------------------------------------------------------------------------------------------------|---------------------------------------------------------------------------------------------------------------------------------------------------------------------------------------------------------------------------------------|
| <p>System air conditioner can only be installed by specialized service provider with air condition installation certifications.</p> <ul style="list-style-type: none"> • Inappropriate installation can cause leakage, fire and electric shock. | <p>When moving or reinstalling the air conditioner, please contact the MULTI V™ AHU installation service provider.</p> <ul style="list-style-type: none"> • Inappropriate installation can cause leakage, fire and electric shock. | <p>Do not disassemble, repair or reconfigure the product arbitrarily.</p> <ul style="list-style-type: none"> • It can cause a fire and electric shock. |
| <p>Do not store or use flammable gas or volatile substance near the air conditioner.</p> <ul style="list-style-type: none"> • It can cause a fire or problem to the product. | <p>Do not bend or damage the power cable.</p> <ul style="list-style-type: none"> • It can cause a fire or an electric shock. | <p>For the electric construction, request for service to the distributor or the service center.</p> <ul style="list-style-type: none"> • Arbitrary disassembly or repair can cause a fire or an electric shock. |
| <p>Always ground the product.</p> <ul style="list-style-type: none"> • If the product is not grounded properly, it can cause an electric shock. | <p>When installing the product, always install the electric circuit breaker and the exclusive switch.</p> <ul style="list-style-type: none"> • If they are not installed, it can cause a fire or an electric shock. | <p>Do not use damaged circuit breaker or exclusive switch.</p> <ul style="list-style-type: none"> • It can cause a fire or an electric shock. |

When opening the box or installing the product, be careful of any sharp objects.

- It can cause an injury.

Use the fuse of rated capacity.

- It can cause a fire or an electric shock.

For the product installation, request for service to the service center or the installation service provider.

- It can cause a fire , an electric shock, an explosion or an injury.

The electric construction must be performed by an electrician for electric installation based on the installation manual and designated circuit diagram.

- Use of inappropriate wire and electric construction, can result in an electric shock or a fire. Technical standard for electric equipment

Use designated installation material at the designated location for the product installation.

Do not install the product outdoors.

■ Operation

Do not let water get inside (Controller) the product. Especially do not wash the product with water.

- It can cause an electric shock or a problem to the product.

Do not leave the product near a heating device.

- It can cause a fire.

Do not change or expend the power cord arbitrarily.

- It can cause a fire or an electric shock.

Use exclusive cable for the product.

- It can cause a fire or an electric shock.

If you hear or smell a weird sound or odor, or if you see smoke from the product or if you experience a power outage, pull down the main power switch.

- If not, it can cause a fire or an electric shock.

Do not put any heavy objects on top of the power cable.

- It can cause a fire or an electric shock.

Do not let the work or the user get on top of the product.

- He or she can fall over to get injured.

Do not use any heating devices near the power cable.

- It can cause a fire or an electric shock.

Do not turn off the power with the main power switch while the product is operating.

- It can cause a fire or an electric shock.

Do not operate the switch with wet hands.

- It can cause a fire or an electric shock.

If you are not planning to use the product for a long period of time, pull down the main power switch.

- It can cause a fire or an electric shock.

If the gas leaks, open the window to ventilate the room before operating the product.

- It can cause an explosion or a fire.

Do not put containers with water on top of the product.

- If the water spills over, it can cause a fire or an electric shock.

 **CAUTION**

ENGLISH

■ Operation

When installing the product, make sure to level the product.

- It can cause vibration or leakage.

Do not install the product at a location where flammable gas is leaking.

- It can cause a fire or a problem to the product.

Do not carry the product by yourself.

- You can get injured by doing so.

Necessary sensor by operating mode

Operating mode	Necessary sensor	Function
Air conditioning	SA temperature sensor RA temperature sensor	<ul style="list-style-type: none"> - This runs indoor air conditioning. - Initial external air inlet setting is 30% of the air supply during the air conditioning and this can be changed by the user. But, when the damper actuator is installed on AHU, the setting can be changed.
Heating	SA temperature sensor RA temperature sensor	<ul style="list-style-type: none"> - This runs the indoor heating. - Initial external air inlet setting is 30% of the air supply during the heating and this can be changed by the user. But, when the damper actuator is installed on AHU, the setting can be changed.
Power save	SA temperature sensor RA temperature sensor OA temperature/ humidity sensor Damper actuator	<ul style="list-style-type: none"> - This is the operating function to run indoor air conditioning by controlling multiple outdoor units by comparing the enthalpy of the indoor/outdoor air. - During the power save operation, the operation switches between partial air conditioning operation (Controlling multiple outdoor units) and external air conditioning operation (Outdoor unit OFF, 100% external air flow). - This is operating function is mainly used in between seasons. But if there is no OA temperature/humidity sensor and RA temperature/humidity sensor on the AHU, the power save operation cannot be selected.
Dehumidify	SA temperature sensor RA temperature sensor OA temperature/ humidity sensor	<ul style="list-style-type: none"> - This is the operating function to remove the indoor humidity when the humidity level indoor is excessive. - During the dehumidifier operation, the set value is 50%RH and the user cannot change this setting. But if there is no OA temperature/humidity sensor and RA temperature/humidity sensor on the AHU, the dehumidifier operation cannot be selected.
Humidification	SA temperature sensor RA temperature sensor	<ul style="list-style-type: none"> - This is the operating function to control the humidity to the set value by detecting the indoor humidity level. - This can be selected during heating operation. But if there is no humidifier/humidifying valve and RA temperature/humidity sensor on the AHU, the humidifier operation cannot be selected.
Auto ventilation	SA temperature sensor RA temperature sensor CO ₂ sensor Damper actuator	<ul style="list-style-type: none"> - This is the operating function to control the amount of external air flow so that the CO₂ level is controlled within the set level by detecting the indoor CO₂ level. - The initial CO₂ level is set to 1000ppm, and can be changed by the user. - This function operates when auto ventilator (Additional operation) is selected during air conditioning or heating operation. But if there is no CO₂ sensor and damper actuator on the AHU, the auto ventilator operation cannot be selected.
Preheating	SA temperature sensor RA temperature sensor Mixing temperature/ humidity sensor	<ul style="list-style-type: none"> - When the mixing temperature during the heating operation is below the set value (5°C), preheating device automatically operates. The preheating device and mixing temperature sensor must be installed on AHU for this to operate automatically.

Part Description

Name and Function of Remote Controller

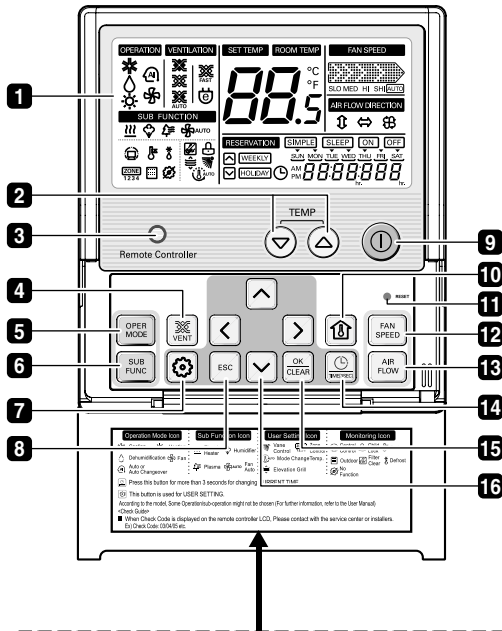

Please attach the inform label inside of the door.
Please choose proper language depend on your country.

- 1** OPERATION INDICATION SCREEN
- 2** SET TEMPERATURE Button
- 3** WIRELESS REMOTE CONTROLLER RECEIVER
 - Some products don't receive the wireless signals.
- 4** VENTILATION Button
- 5** OPERATION MODE SELECTION Button
- 6** SUBFUNCTION Button
- 7** FUNCTION SETTING Button
- 8** EXIT Button
- 9** ON/ OFF Button
- 10** ROOM TEMPERATURE Button
- 11** RESET Button
- 12** FAN SPEED Button
- 13** AIR FLOW Button
- 14** RESERVATION/ TIME SETTING Button
- 15** SETTING/ CANCEL Button
- 16** UP, DOWN, LEFT, RIGHT Button

- 3/4/12/13 does not work.
- 6 Additional operation button depends on the application of the sensor.

Basic operation of wired remote controller

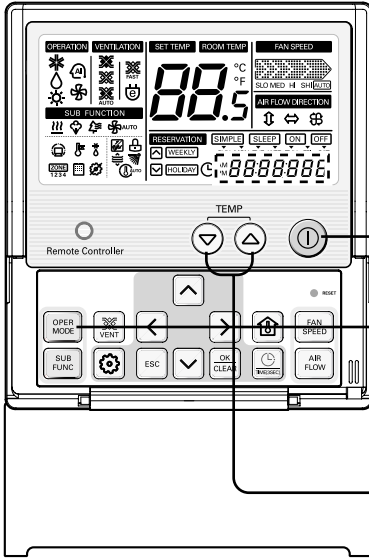

1 Press the Run/Stop button on the control part of the remote controller to start the operation.



2 Press the Operation Selection button to set the operating mode (Heating/Cooling etc.).



3 Press the Temperature Control button to set the desired temperature below the indoor temperature. (Based on air conditioning operation)

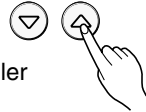

(Example) Remote controller display window

▲ Indoor temperature ▲ Desired temperature

During the initial operation, the desired temperature is automatically set below the indoor temperature.

4 When you press the Run/Stop button during use, the operation will stop.



Main function of wired remote controller

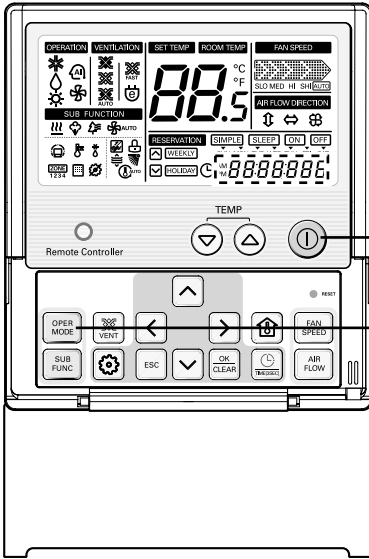

1 Every time you press the Run/Stop button, the ON and OFF will be repeated.



2 Every time you press the Operation Selection button, it will change in the order of Air Conditioner Dehumidifier Heater Power Save Fan. There are operating modes that cannot be set depending on the applied sensor.



<Air Conditioner>

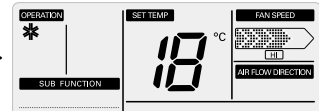

<Dehumidifier>

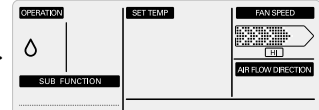

<Heater>

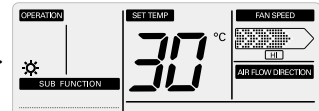

<Power Save>

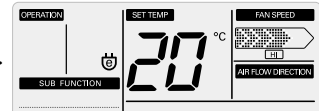

<Fan>

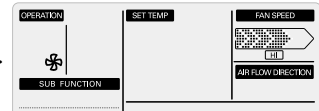

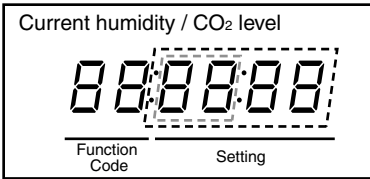
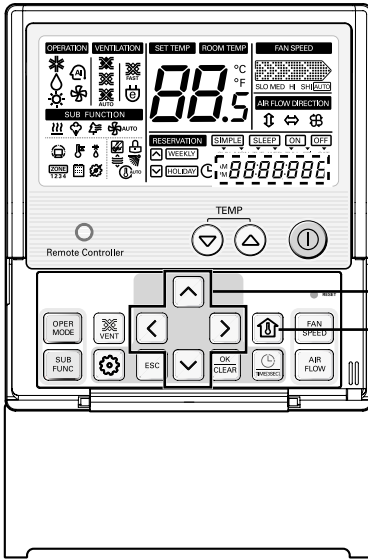

- (Function set by code)
 * Code 01: Current humidity
 * Code 02: Current CO₂ level

: Current humidity

: Current CO₂ level

(Example)

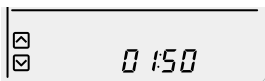

<Current humidity: 50%>

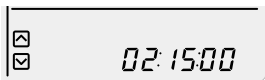

<Current CO₂ level: 1500ppm>

3 Every time you press the Temperature Control button and the Up/Down button, the desired temperature will change.
 Air Conditioner/Power Save: 18~30°C / Heater: 16~30°C
 Dehumidifier/Fan:
 Desired temperature cannot be changed

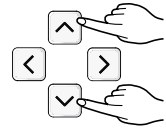

4 When you press the Indoor Temperature button, the Return Temperature of AHU will be displayed for about 5 seconds.

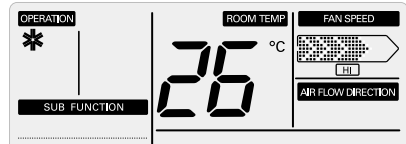

5 To check the current humidity, press the 'Left' button when the indoor temperature is displayed and the indoor humidity will be displayed at Display 'C'.
 To check the current CO₂ level, press the 'Right' button when the indoor temperature is displayed and the current CO₂ level will be displayed at Display 'C'.



Supplementary function of wired remote controller

Humidifier

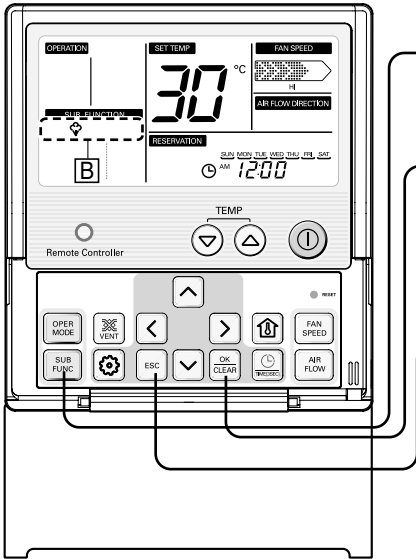

1 Press the Additional Operation button.



2 When the Humidifier icon flashes in Display 'B', press the Set/Cancel button to start the humidifier.



3 When you press the OK/CLEAR button one more time, the humidifier will stop.





* Humidifier can only be set during heating operation.

* Humidifier operation can only be used when the humidifier is installed.

* The humidifier operation is controlled by the desired temperature set.

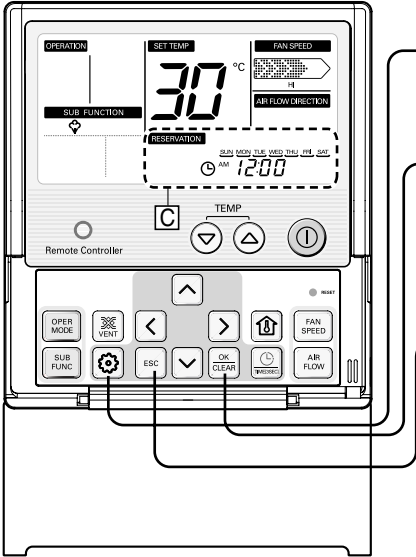
Desired humidity control

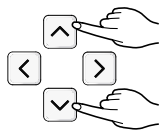

- 1 Press the Function Setting button. 
- 2 Set the Function Code of Display 'C' to 01.
- 3 Press the Up/Down button to set the target humidity. 
- 4 Press the OK/CLEAR button to decide the desired humidity. 

* Desired humidity can be controlled in the range of 40~60% by 5% increment.
 * Default humidity is set to 50%.

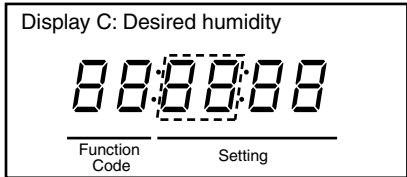

(Function set by code)
 * Code 01: Current humidity
 [dashed box] : Desired humidity

(Example)



<Current humidity: 50%>

Auto ventilator

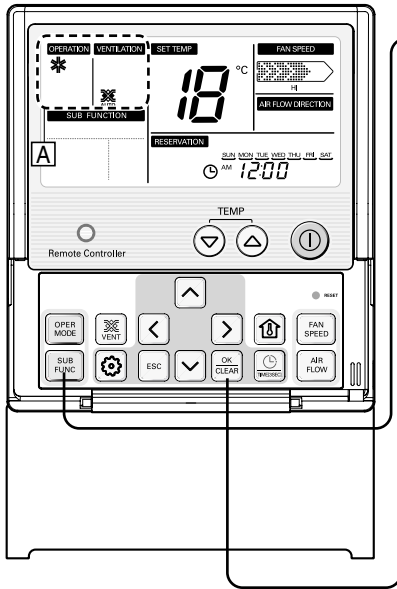

1 Press the Additional Operation button.



2 When the Auto icon flashes in Display 'A', press the OK/CLEAR button to start the Auto Ventilator.



3 When you press the OK/CLEAR button one more time, the Auto Ventilator will be canceled and return to the previous operating condition.



* Auto Ventilator function can only be set during the Air Conditioning/Heating operation.

Desired CO₂ level control

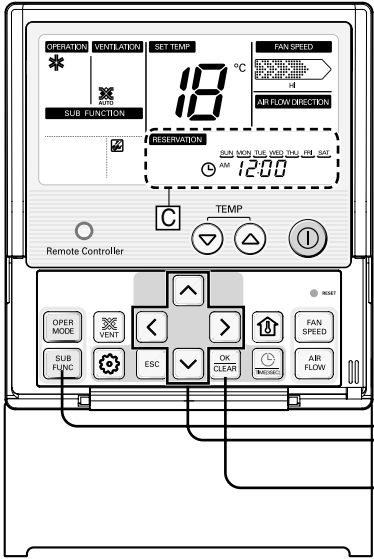

1 Press the Additional Operation button.



2 Set the Function Code of Display 'C' to 02.

3 Press the Up/Down button to set the target CO₂ level.

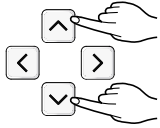

4 Press the OK/CLEAR button to set the target CO₂ level.



* Desired CO₂ level can be controlled in the range of 500~1500ppm by 100ppm increment.
 * Default humidity is set to 1000ppm.

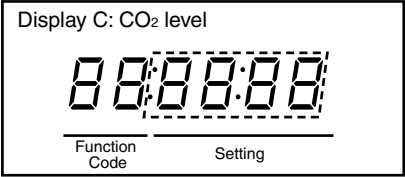

(Function set by code)
 * Code 02: Desired CO₂ level
 [dashed box] : Desired CO₂ level

(Example)

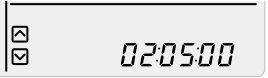

<Desired CO₂ level: 500ppm>

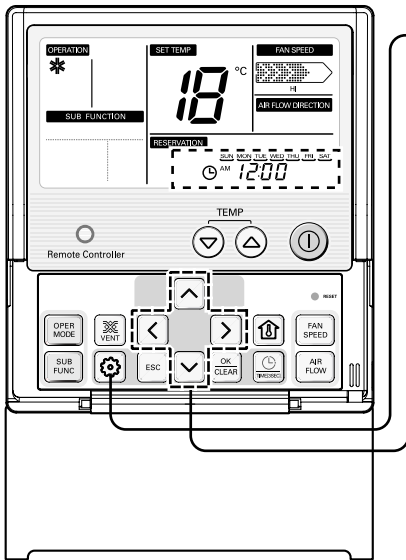

Reservation function of wired remote controller

Changing Current Time



- 1** Keep pressing  button for 4 secs to enter Setting current time mode.

Ex) Changing Current Time as 'Monday / AM 10:20'.

- 2** Press   key to adjust the current day.

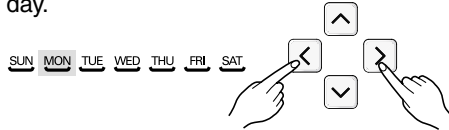

- 3** Press  key to move to AM/ PM setting mode (the 'AM/ PM segment will flash').



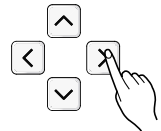

- 4** Setting AM/ PM value by pressing  button.



- 5** Press  button to move to 'Hour' setting mode. (the 'Hour' segment will flash)



- 6** Setting Hour value by pressing   button.



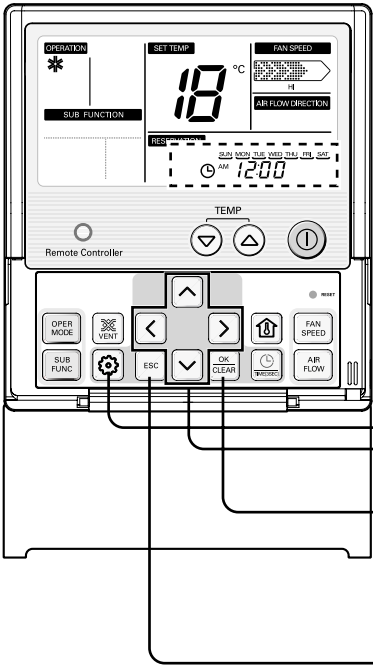

7 Press button to move to 'Minute' setting mode. (the 'Minute' segment will flash)



8 Setting Minute value by pressing button.



9 Press button to finish.

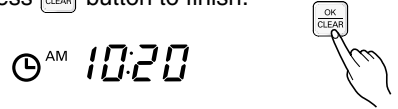

10 In the process, press button to release and exit from setting mode. (In case of exit with incomplete information, it will return to the previous setting)



Programming : Setting Simple Reservation

In case of there is not any reservation setup on system, it is possible to make a SIMPLE reservation on indoor unit.

1 Press button to enter the Programming mode.
(the **SIMPLE** segment flashing)

Ex) Setting Simple Reservation time as '3'.

2 Press button to adjust reservation time.

3 Press button to finish setting.

4 Adjusting the reservation time after finish reservation setting will release the previous one.

* If the indoor is ON, we can make the reservation for turning OFF. In reserve, if the indoor is OFF, we can set the timer for turning ON. The reservation time is from 1 to 7 hours.

Programming : Setting ON Reservation

This function is able to turn air conditioner ON after a setting time.

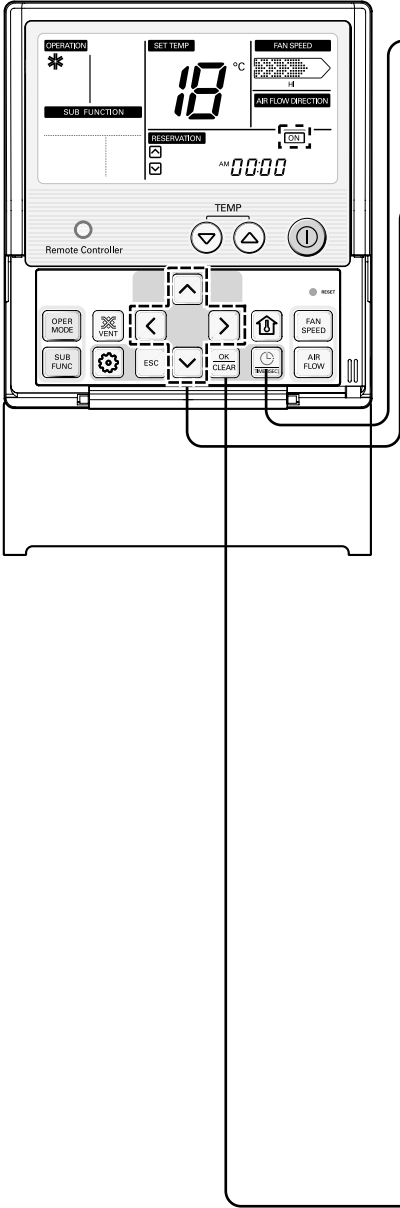

- 1** Press button.

Ex) Setting ON Reservation Time as 'AM 10:20'.
- 2** Repeat pressing button to enter the ON reservation setting mode. (segment flashing)
- 3** Press button to adjust AM/ PM setting.

AM 12:00
- 4** Press button to Hour setting mode. When the Hour icon flash, please setting time. The setting range is within 1~12.

AM 12:00

AM 10:00
- 5** Press button to shift to Minute setting mode. When the Minute icon flash, please setting minute the setting range is within 00~59.

AM 10:00

AM 10:20
- 6** Press button to finish setting.

AM 10:20

Programming : Setting OFF Reservation

This function is able to turn air conditioner OFF after a setting time.

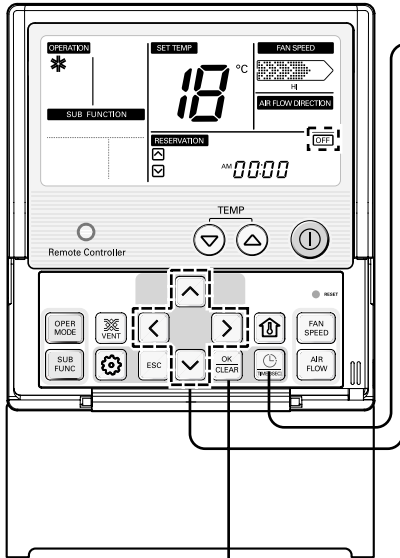

1 Press button.

Ex) Setting OFF Reservation
Time as 'AM 10:20'.



2 Repeat pressing button to enter the OFF reservation setting mode.
(segment flashing)



3 Press button to adjust AM/ PM setting.

AM 12:00

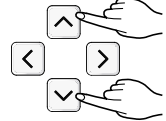

4 Press button to shift to Hour setting mode. When the Hour icon flash, please setting time.
The setting range is within 1~12.

AM 12:00

AM 10:00

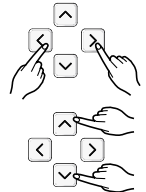

5 Press button to shift to Minute setting mode. When the Minute icon flash, please setting minute the setting range is within 00~59.

AM 10:00

AM 10:20

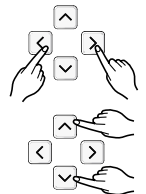



6 Press button to finish setting.

AM 10:20



Programming : Weekly Reservation

The weekly reservation is active after setting current time

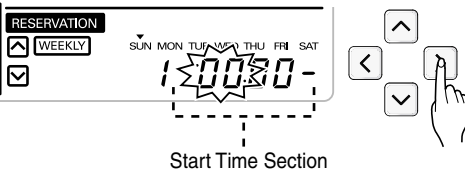
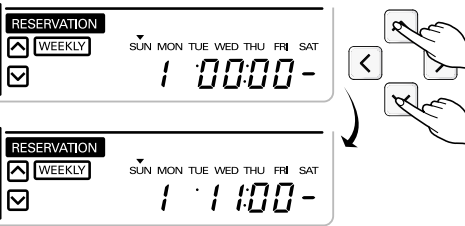
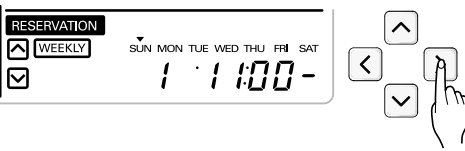
<p>1 Press programming button to enter the Programming mode. Repeat pressing button to select [Weekly reservation]. (The segment will be flashed)</p> <p>Ex) Setting one action as below.</p> <ul style="list-style-type: none"> - Day : TUE - ON Time : 11:30 AM - OFF Time : 12:30 PM 	
<p>2 Press left, right button to adjust the current day.</p>	
<p>3 Press up, down button to adjust the action number.</p>	
<p>4 Press right button to move to 'Hour' Part on ON Time section. (The 'Hour' segment will be flashed)</p>	 <p style="text-align: center;">Start Time Section</p>
<p>5 Press up, down button to adjust the Hour on Start Time section.</p>	
<p>6 Press right button to move to 'Minute' Part on Start time section. (The 'Minute' segment will be flashed)</p>	

- 7** Press up, down button to adjust the Minute on Start Time section.

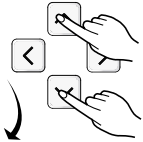
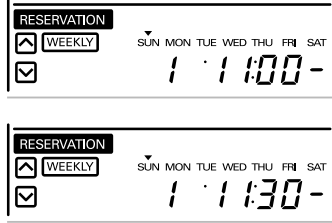

- 8** Press right button to move to 'Hour' Part on OFF Time section. (The 'Hour' segment will be flashed)

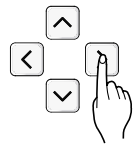
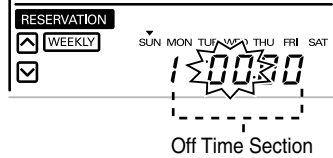

- 9** Please refer the process from No.5 to No.7 for setting OFF Time. It is same method.

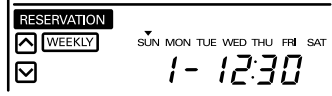

- 10** If you finish the setting, press setting/cancel button to complete programming. The under bar segment will be created, when it finished.

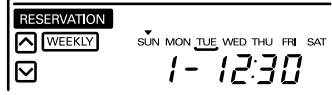

- 11** Please refer the process from No.2 to No.10 for setting other day weekly program. It is same method.



- 12** Press exit button to exit or system will automatically release without any input after 25 seconds.



<Note>

Description of weekly reservation

<Start Time Section>

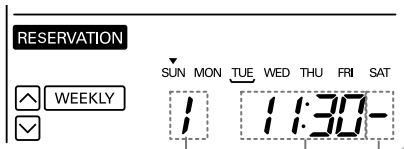

Action
Start Time
Front

<Off Time Section>

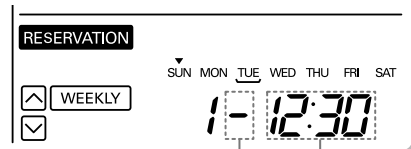

To
Off Time

* Two actions per weekday can be programmed, in total 14 actions

Programming : Holiday Reservation

This function is to automatically stop the machine working on some days.

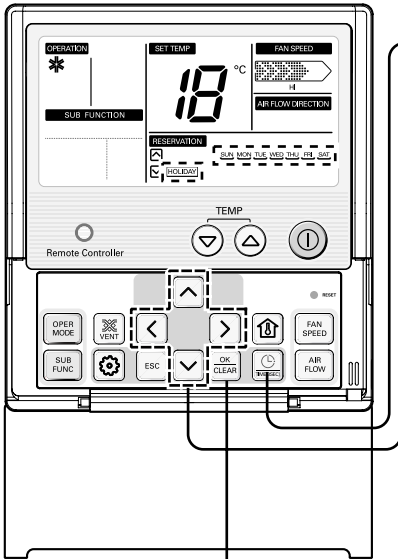

1 Press button to enter the reservation setting mode.



2 Repeat pressing button to enter the holiday reservation setting mode.
(HOLIDAY segment flashing)



3 Press button to move to holiday position.

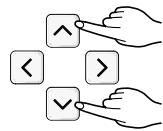

4 Press button to set or release a selected day as holiday or not.
(* the holiday is indicated with a underline)

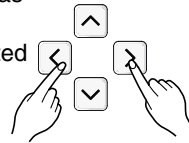

5 If there is any holiday from Monday to Sunday, HOLIDAY segment on LCD will be displayed.

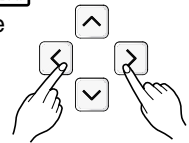

6 Press the button to exit or if there is not any input, system will release any setting after 10 seconds.



7 It is possible to set the air conditioner OFF in every "holiday"
(ex. 9:00, 10:00, 13:00)

Setting function of wired remote controller installation

How to start installation setting mode

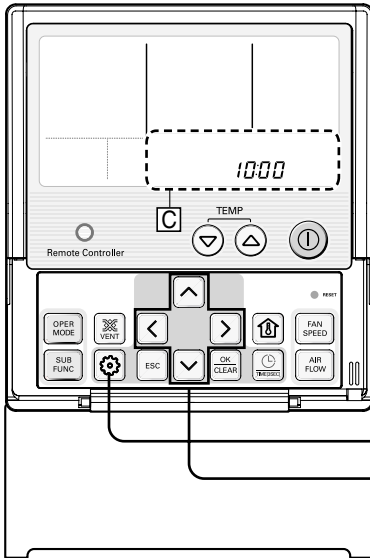

1 Press the Function Setting button for more than 3 seconds and the Code will be displayed on Display 'C' to enter the installation mode.



2 When you now press the Function Setting button, the function code will change.

3 Press the Up/Down button to change the setting.

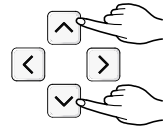

4 Press the Left/Right button to navigate through the items.

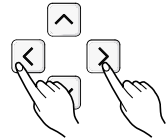

5 Press the Set/Cancel button to complete the setting.

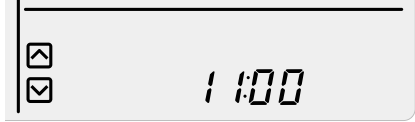
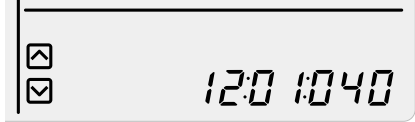
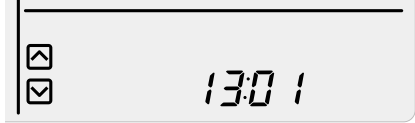
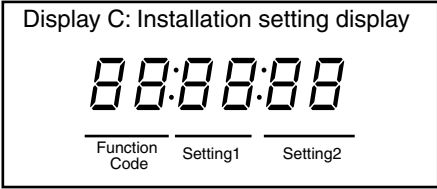

Setting function by code

<p>Code 10: Test run (AHU has no function)</p>	
<p>Code 11: Central control address setting</p>	
<p>Code 12: Damper opening setting</p>	
<p>Code 13: Remote controller Master/Slave setting</p>	
<p>Display C: Installation setting display</p>  <p>Function Code Setting1 Setting2</p>	

Central control address setting

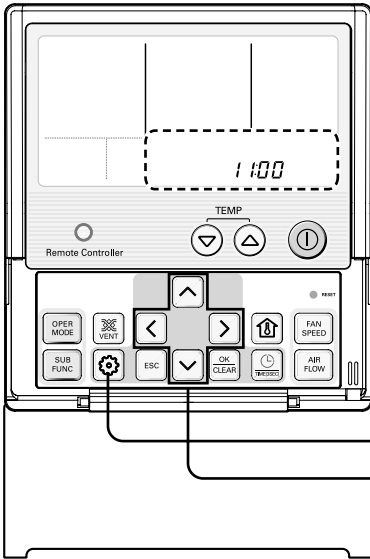

1 Enter the Installation Setting mode.



2 Press the Function Setting button repeatedly to reach function code of '11'.

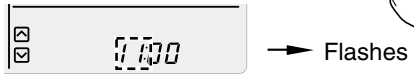

Flashes

3 Press the Right button to move to 'Setting of 1'.

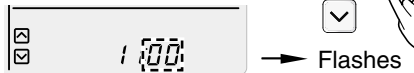
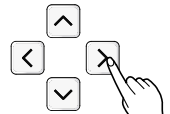

Flashes

4 Press the Up/Down button to set the central control address.

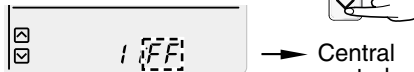
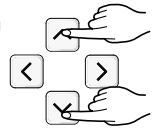

Central control address

5 Press the Set/Cancel button to complete the central control address setting.



* This is the function to set the central control address of AHU.

Display C: Installation setting display

00:00:00

Function Code

Setting1

Setting2

Damper opening setting

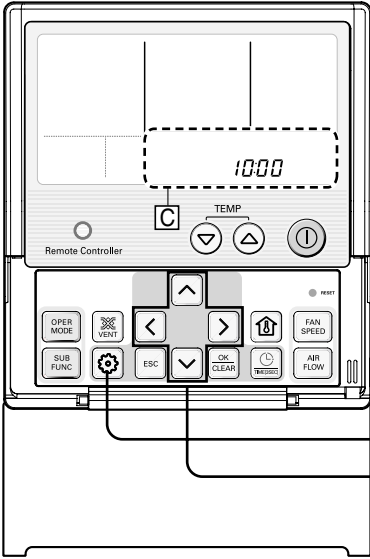

1 Enter the Installation Setting mode.



2 Repeatedly press the Function Setting button to reach function code of '12'.



3 Press the Right button to move to 'Setting of 1'.

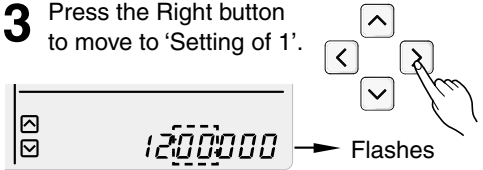

4 Press the Up/Down button to set the value.

'Setting of 1' for each mode is as follows.

* Cooling mode ['01' (OA) / '02' (EA) / '03' (Mixing)]

* Heating mode ['04' (OA) / '05' (EA) / '06' (Mixing)]

* Fan mode ['07' (OA) / '08' (EA) / '09' (Mixing)]

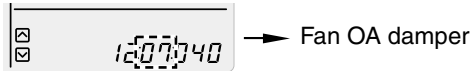
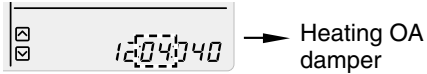
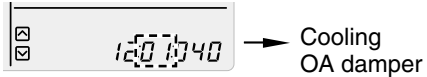
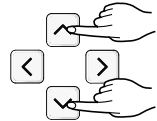

Display C: Installation setting display

00:00:00

Function Code Setting1 Setting2

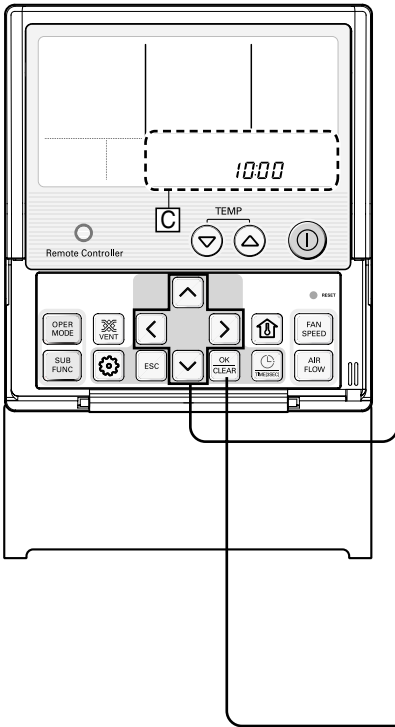

5 Press the Right button to move to 'Setting of 2' by each mode.

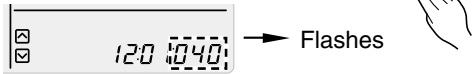

6 Press the Up/Down button to select the damper opening.
The damper opening that can be set is in the range of 1~91 degrees.

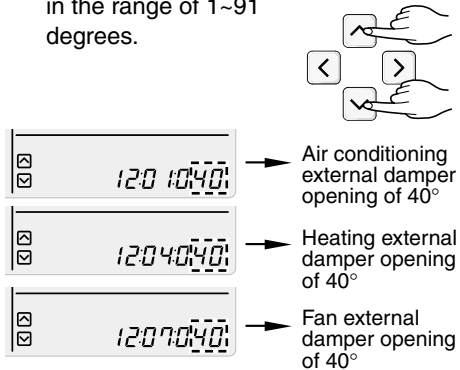

7 Press the OK/CLEAR button to complete the setting.



* This is the function to set the damper opening of AHU.
* This applies only to the site where the damper actuator is installed.

Display C: Installation setting display

88:88:88

Function Code Setting1 Setting2

Remote control Master/Slave setting

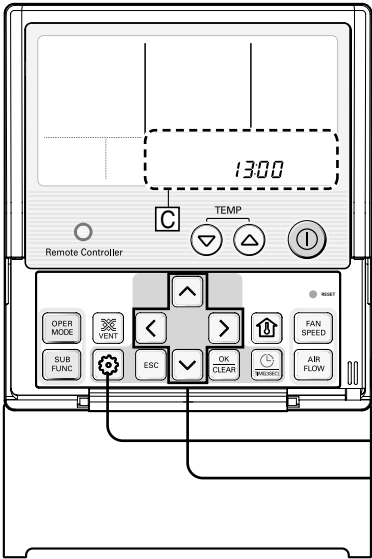

- 1** Enter the Installation Setting mode.
- 2** Press the Function Setting button repeatedly to reach function code of '13'.
- 3** Press the Right button to move to 'Setting of 1'.
- 4** Press the Up/Down button to set the value. Setting value of '01' is the Master and '00' is the Slave.
- 5** Press the OK/CLEAR button to complete the setting.

* This is the function to set the mainly used remote controller.

* You can set one remote controller as the Master and the rest as Slave.

Display C: Installation setting display

88.88.88

Function Code	Setting1	Setting2
---------------	----------	----------

Manual operating mode

SA fan operation

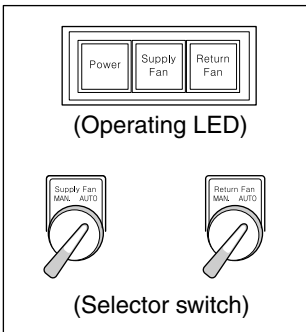
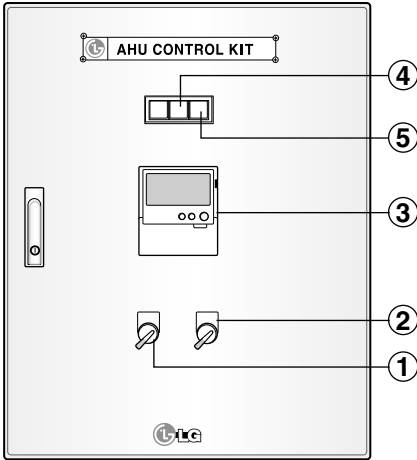

- ① RA fan operating LED
- ② SA fan operating LED
- ③ Wired remote controller
- ④ SA fan switch
- ⑤ RA fan switch

- 1** When you set the SA Fan Switch to ON, the SA fan will operate manually. 

- 2** SA fan operating LED will be turned on.

- 3** When you set the SA Fan Switch to OFF, the SA fan will stop operating and can be operated automatically with the wired remote controller. 

* The SA switch of the control kit during AHU operation with the wired remote controller must be maintained at OFF condition.

RA fan operation

- 1** When you set the RA Fan Switch to ON, the RA fan will operate manually. 

- 2** RA fan operating LED will be turned on.

- 3** When you set the RA Fan Switch to OFF, the RA fan will stop operating and can be operated automatically with the wired remote controller. 

* The RA switch of the control kit during AHU operation with the wired remote controller must be maintained at OFF condition.

Check before requesting for service

When there is a problem with the product, check the following detail before requesting for service to the service center.

Symptom	Check	Action
The product does not work at all.	* Is the main switch turned off?	* Turn on the main power switch.
	* Is there a power outage?	* Check the other electric appliances. (If the power works, try operating the product again.)
	* The fuse inside the product can be disconnected.	* Request for service to the installation service provider or the service center.
The cool air does not flow continuously.	* Is the desired temperature set higher than the indoor temperature?	* Set the desired temperature to be lower than the indoor temperature.
	* Is the product running in Dehumidifier/Power save mode?	* Change the operating mode to air conditioning.
I cannot set the scheduled operation.	* Is the schedule properly set?	* Refer to the manual and try setting up the schedule again.
	* Did you check the current time?	* If the current time is incorrect, try setting again.
AHU automatically goes off.	* Is the OFF schedule set?	* Check the remote controller and cancel the OFF schedule.

Test run

Self diagnosis function

Error display

- This function displays the self diagnosis and the type of error if identified.
- For the error display, the applicable code is displayed on the 7 segment LED on the wired remote controller and AHU controller.
- If there are 2 or more errors simultaneously, the codes are displayed in the order of occurrence.
- Once you resolve the error, the error code will disappear.

Error display method

- The first display on the 7 segment display refers to the error code and the second part refers to the location information of the communication PCB address or sensor location. Refer to the following for details.

Error type	Display condition	Example of output	Detail description
Basic error	CH [Error code] 0	CH30	Error #3
Communication PCB error	CH [Error code] [Address]	CH204	Error #2 in communication PCB with address of '#4'
Sensor error	CH [Error code] [Location]	CH1302	Air supply temperature sensor error
Outdoor unit error	CH [Error code] [Address]	CH17304	Error #173 on the outdoor unit connected to communication PCB with address of '#4'

* The address the communication PCB refers to the rotary switch number on the communication PCB.

Location number	Location name	Applicable sensor type
01	RA	Temperature sensor, humidity sensor
02	SA	Temperature sensor, humidity sensor
03	OA	Temperature sensor, humidity sensor
04	Mixing	Temperature sensor
05	Differential pressure	Differential pressure sensor
06	Static pressure	Static pressure sensor

* The above table shows the information of the attached location by sensor.

Error display (AHU)

■ ‘##’ refers to the address information of the communication PCB.

Display number		Error item	Cause of error	Cause or error	
CH	2	##	Temperature sensor error at pipe inlet of indoor unit	Communication PCB rotary switch number ##	Temperature sensor disconnection or short circuit at pipe inlet of indoor unit
CH	3	00	Communication error between wired remote controller and AHU controller	-	No communication signal for more than 3 minutes from wired remote controller to the AHU controller
CH	4	##	Communication error between AHU controller and communication PCB	Communication PCB rotary switch number ##	No communication signal for more than 3 minutes from communication PCB to AHU controller
CH	5	##	Communication error between communication PCB and outdoor unit	Communication PCB rotary switch number ##	No communication signal for 5 minutes continuously from communication PCB to outdoor unit
CH	6	##	Temperature sensor error on pipe outlet of indoor unit	Communication PCB rotary switch number ##	Temperature sensor disconnection or short circuit on pipe outlet of indoor unit
CH	8	00	Emergency operation	-	The operating status of the smoke control mode through smoke detector is displayed
CH	13	01	Temperature sensor error	RA	Temperature sensor (RA/SA/Mixing) disconnection/short circuit/misconnection or when the sensor value is in the error range
				SA	
				Mixing	
CH	14	01	Humidity sensor error	RA	Humidity sensor (RA/SA/OA) disconnection/short circuit/misconnection or when the sensor value is in the error range
				SA	
				OA	
CH	15	00	CO ₂ sensor error	-	CO ₂ sensor disconnection/short circuit/misconnection or when the sensor value is in the error range
CH	16	05	Pressure sensor error	Differential pressure	Pressure sensor (Differential pressure, static pressure) disconnection/short circuit/misconnection or when the sensor value is in the error range
				Static pressure	
CH	17	01	Air flow sensor error	RA	Air flow sensor (RA, SA) disconnection/short circuit/misconnection or when the sensor value is in the error range
				SA	

Example of error

Situation	Error
Pipe inlet temperature sensor error (Communication PCB rotary switch number: 01)	CH → 2 → 01
Communication error between communication PCB and outdoor unit (Communication PCB rotary switch number: 05)	CH → 5 → 05
SA duct temperature error	CH → 13 → 02
RA duct humidity error	CH → 14 → 01

Sequence of error

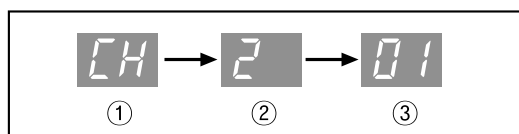

* The occurrence of error is displays in the order of ① → ② → ③ on 7 segment.

* Refer to page 43 for details of ② and ③.

Refer to the MULTI V technical material for details on error code and checkpoints of the outdoor unit.



Free Manuals Download Website

<http://myh66.com>

<http://usermanuals.us>

<http://www.somanuals.com>

<http://www.4manuals.cc>

<http://www.manual-lib.com>

<http://www.404manual.com>

<http://www.luxmanual.com>

<http://aubethermostatmanual.com>

Golf course search by state

<http://golfingnear.com>

Email search by domain

<http://emailbydomain.com>

Auto manuals search

<http://auto.somanuals.com>

TV manuals search

<http://tv.somanuals.com>