



MULTI V™ SPACE



MULTI V™ SYNC



MULTI V™ PLUS



2007 **MULTI V™** Air Conditioning System

If you need a highly efficient air conditioning system in your building, LG **MULTI V™** is the right choice for you.

Great Company Great People



Test Tower

Brief History

Establishment

- 1947 Establishment of the LG Group
- 1958 Establishment of LG Electronics Inc.
- 1962 Establishment of Digital Appliance Company

Growth

- 1968 Manufactured Korea's first air conditioners
- 1985 Introduced Korea's first Inverter air conditioners
- 1986 Exported Korea's first window-type air conditioner

U.S.

- 1989 Won the approval of "UL's MDP & CSA's EEVP"
- 1993 Obtained ISO 9001 Certification from "BSI-QA"
- 1994 Export Records US\$ 100 Million

Global

- 1995 Establishment of LGETA in China

Expansion

- 1997 Establishment of LGEIL in India
- 1999 Establishment of LGEAT in Turkey
- 1999 Establishment of LGEMH in Vietnam
- 2001 Establishment of LGEAZ in Brazil
- 2002 Establishment of LGETH in Thailand
- 2002 Establishment of LGEIN in Indonesia
- 2004 Turnover of US\$1.4 Billion dollars
- 2006 Achieved No.1 position for 7 years (2000~2006)



LG Air Conditioner Global



LG Air Conditioning Division, Korea



LGE Tianjin Appliance Co., Ltd. China



LG Electronics Thailand



LG Electronics Arcelik Turkey



LGE New Delhi Ltd., India



LGE Haiphong Inc., Vietnam



LGE da Amazonia Ltd., Brazil



LG Electronics Indonesia

MULTI V™

52 Indoor unit

55	66	68	70
ART COOL Series	Wall Mounted	Ceiling Cassette - 1way	Ceiling Cassette - 2way



10 Outdoor unit

16

MULTI V™ PLUS

28

MULTI V™ SYNC

42

MULTI V™ SPACE

72

Ceiling Cassette -
4way

74

Ceiling & Floor

76

Ceiling
Suspended

78

Ceiling
Concealed Duct
- High Static

80

Ceiling
Concealed Duct
- Low Static

82

Ceiling
Concealed Duct
- Built in

84

Floor Standing
- With Case

86

Floor Standing
- Without Case

90 Network solution & Accessory

90

Individual
Controller

92

Simple Central
Controller

93

Deluxe Central
Controller

94

PC Based
Central
Controller

95

PDI

96

BNU-LW

97

BNU-BN

98

Accessory



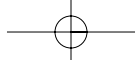

MULTI V™ Outdoor unit line up



HP	5	8	10	12	14	16	18	20
MULTI V™ PLUS								
Heat pump								
MULTI V™ SYNC								
Heat recovery								
MULTI V™ SPACE								
Heat pump								

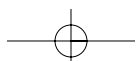

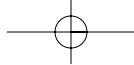

22

24

26

28

30

32

34

36





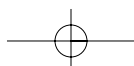
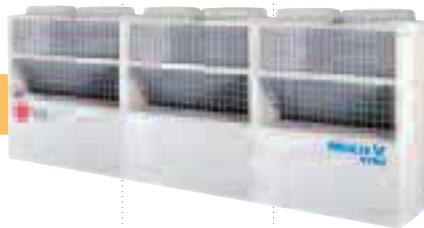







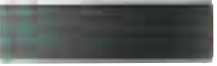

38

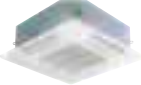
40



MULTI V™ Indoor unit line up



Btu / h		7k	9k	12k
ART COOL Series	Gallery 	[Orange bar]		
	Panel 	[Orange bar]		
	Wide 			
	Mirror 	[Orange bar]		
SRAC	Wall Mounted 	[Orange bar]		
Ceiling Cassette	1way 	[Orange bar]		
	2way 			
	4way (570*570) 	[Orange bar]		
	4way (840*840) 			
Ceiling & Floor			[Orange bar]	
Ceiling Suspended				
Ceiling Concealed Duct	High Static 			
	Low Static 	[Orange bar]		
	Built-in 	[Orange bar]		
Floor Standing	With Case 	[Orange bar]		
	Without Case 	[Orange bar]		

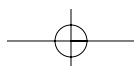
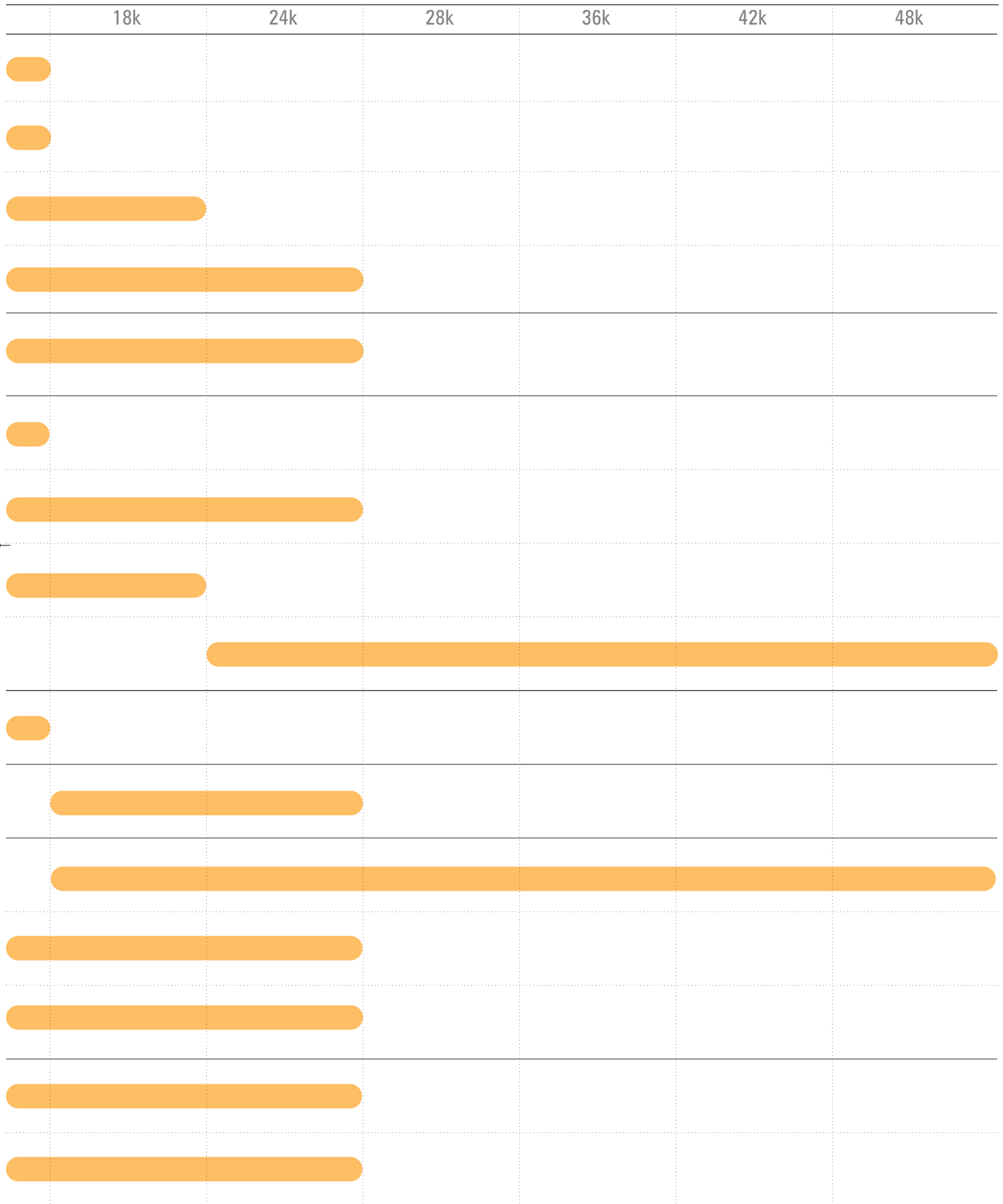
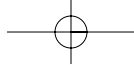

MULTI V™ Outdoor unit

The MULTI V system is composed of serially arranged refrigerant piping, and multiple indoor units connected to one outdoor unit. It is a highly efficient system that offers outstanding energy reduction, simple and easy design and installation, and the ability to connect to many types of indoor unit for all types of application.



16 MULTI V™ **PLUS**

42 MULTI V™ **SPACE**





MULTI V™ SYNC 28



MULTI VTM**MULTI V**TM

Pursuing the market needs of high energy efficiency and environmental friendliness.

■ A line up with a wide range of model/capacity selection

The various selection of outdoor units coupled with the wide range of indoor units, means that the **MULTI V** system has the ability to make any space comfortable whether it be a small shop, residential application, or large office building.



■ Longer field piping runs for flexible installation

With a maximum pipe run of 150m from the outdoor unit to the furthest indoor unit, there is greater choice of where the outdoor and indoor units can be positioned. Therefore the **MULTI V** system is suitable for installation into most types of building.

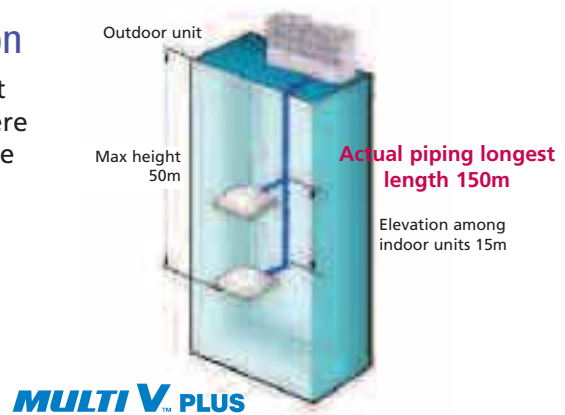

MULTI V incorporates inverter compressor and fan motors.

Why inverter?

- Higher efficiency
- Reduced operation noise
- Less vibration
- Enhanced capacity control



Automatic addressing between outdoor and indoor units

The addressing between outdoor unit and indoor units is carried out by the touch of a button. When the addressing is complete, the system is ready to run.

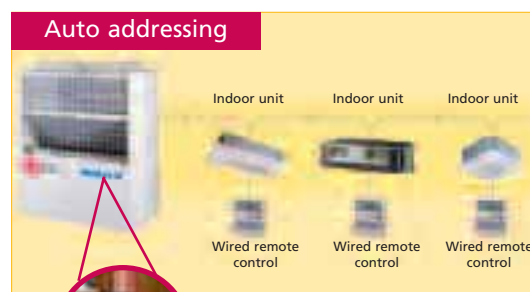
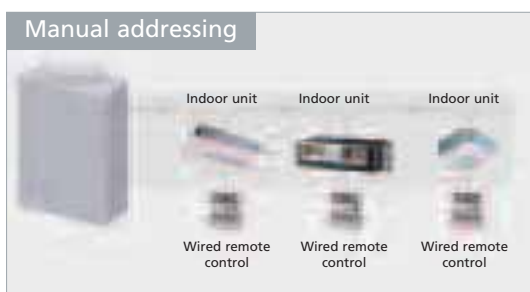

Non-polarised communication wiring

The communication wiring can be installed polarised, non-polarised, or a combination of the two, and the outdoor unit will sort out the mistakes during automatic addressing.

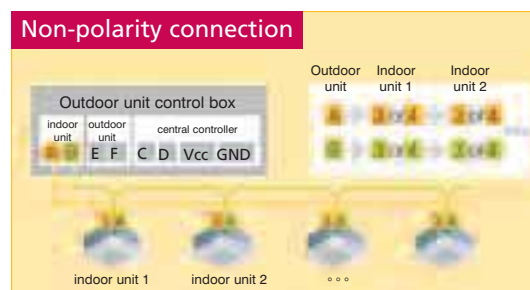
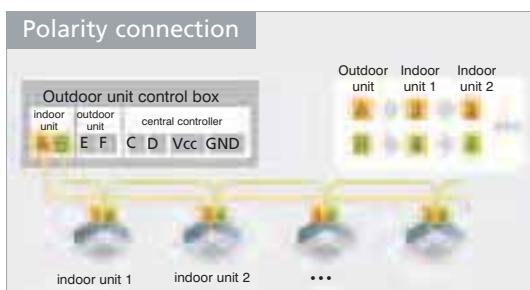

MULTI V™



MULTI V™

Pursuing the market needs of high energy efficiency and environmental friendliness.

■ Urethane coated PCB

- Protects PCB from oxidization
- Prevents errors that may be caused by moisture and dust
- Strengthens electrical insulation
- Keeps components stable from vibration.

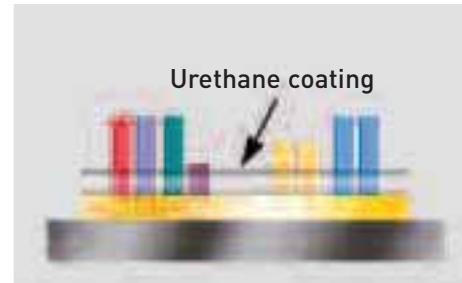

■ Indoor unit with interior concept

Indoor units with unique stylish designs blend in with refined interior.



Neo Plasma Air Purifying System (applied models only)

LG's unique NEO Plasma Air Purifying System is equipped with 7 specialized filters in 5 separate stages to enhance its cleaning power. It reduces fine dust and mold, unpleasant odors and cigarette smoke as air passes through each filter.

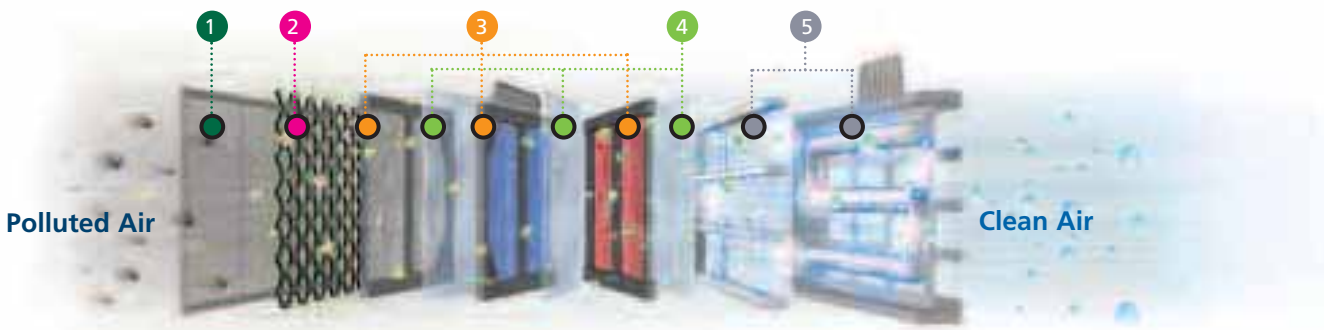

1. Pre Filter

The antibacterial pre-filter primarily reduces large dust, mold and quilt dust.

2. Nano Carbon Filter

Nano-size carbon filters removes fine odorous particles from the household air resulting in a more pleasant environment.

What is Nano Carbon Ball?

Microscopic sized (1/1000000000) filter to ensure optimal filtration of odors.

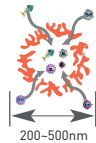

3. Triple Filter

The triple filter consists of three specialized filters to reduce the symptoms associated with various organic compounds including formaldehyde. It also has the ability to reduce unpleasant odors creating a more comfortable environment.



4. Nano Bio Fusion Filter

Nano bio fusion filters allow their nanosize bio enzymes to directly penetrate through cell walls of some bacteria and allergen to decompose its cell nuclei.

5. Plasma Filter

The PLASMA Air Purifying System developed uniquely by LG not only reduces microscopic contaminants and dust, but also reduces house mites, pollen, and pet fur to reduce allergy and asthma symptoms.

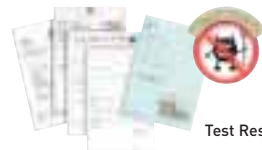

Test Result Certification

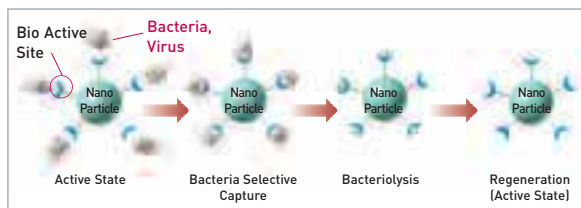

Distinctions from Conventional Filters

• Conventional



Simply inactivate bacteria

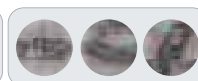

Destroy bacteria but allow part of them to survive

• Nano Bio Fusion Filter

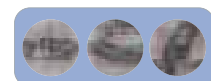

The bio enzyme destroys cell walls and nuclei of some bacteria and allergens.

MULTI V™ PLUS



Hotel



School



Office



Factory



Applications

- Hotel
- School
- Office
- Factory

Outdoor unit



What is **MULTI V™ PLUS**

MULTI V™ PLUS is a two pipe heat pump system, which is available from 5Hp (single module) up to 40Hp (combination multiple outdoor units together). Up to 40 indoor units can be connected to one system, reducing installation material cost, and installation time. Combined with the many control options on offer, the **MULTI V™ PLUS** system can offer a total building solution.

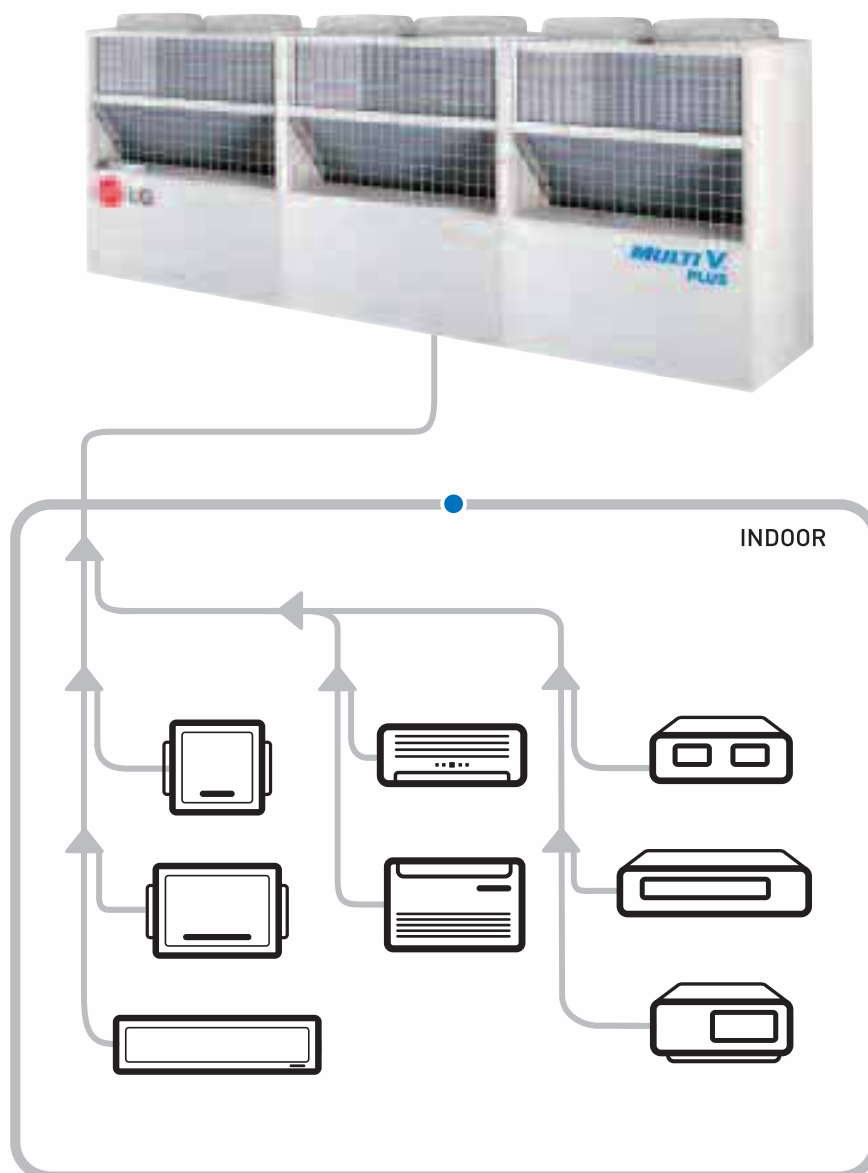

MULTI V PLUS



Installation Space

User satisfaction is further increased with **MULTI V PLUS**, by reducing the installation area through efficient utilisation of space assisted by the design of the outdoor unit.

High efficiency linear control

MULTI V PLUS allows capacity control in the range of 10-130% according to the indoor units load requirement. This is carried out by applying the optimised control algorithm using the inverter and constant speed compressors as the load increases/decreases. Combined with the outdoor unit inverter fan motors, this highly efficient inverter system also offers low noise operation, outstanding load response (quick and comfortable cooling and heating), and excellent energy reduction.

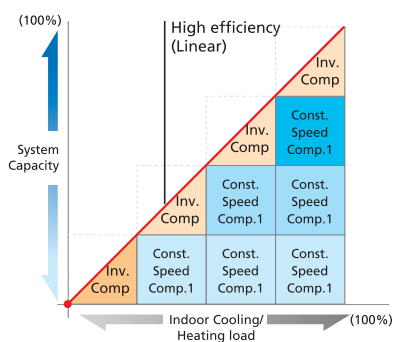
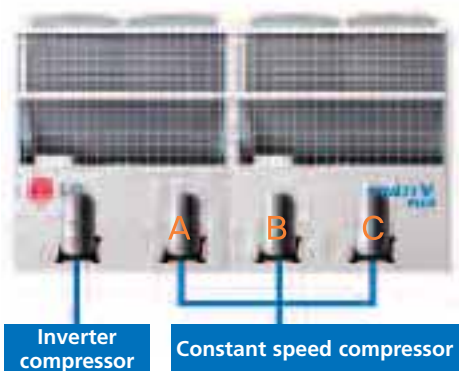

Highly efficiency linear control

Outstanding installation space utilisation

The two way air induction (front and rear), and top discharge structure, allows **MULTI V PLUS** outdoor units to be placed directly next to each other - offering reduced installation space, and reduced system footprint.



Installation of multiple outdoor units in this way can reduce installation by up to 30% compared to equivalent systems on the market (some of which use the 3 way air induction and top discharge method).

Economy

MULTI V PLUS ensures an economic life due to its high efficiency operation, reduced installation material usage, and therefore reduced installation cost.

■ Long and reduced field piping for flexible installation

MULTI V gives you the ability to connect multiple outdoor units together to form one system (therefore one set of pipes entering the building). This coupled with the long field piping runs makes the **MULTI V** system not only very flexible in the type of buildings where it can be installed, but can reduce installation costs and even reduce installation space (especially within the risers).

Conventional

Sets of existing 10HP outdoor units are separately installed.

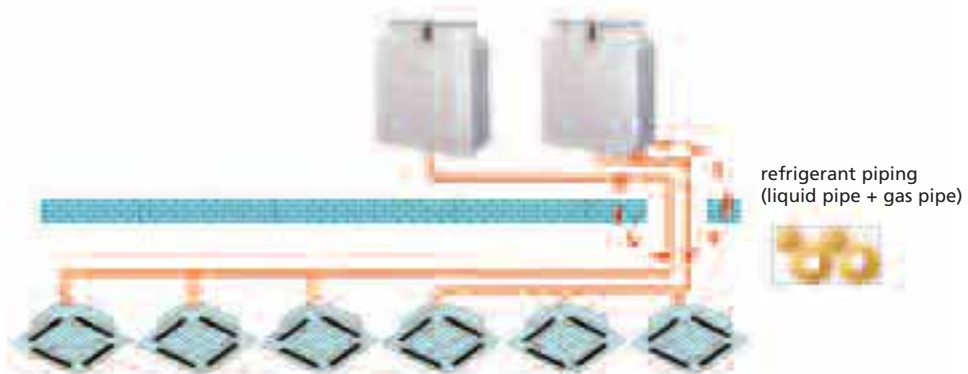

MULTI V PLUS

MULTI V PLUS

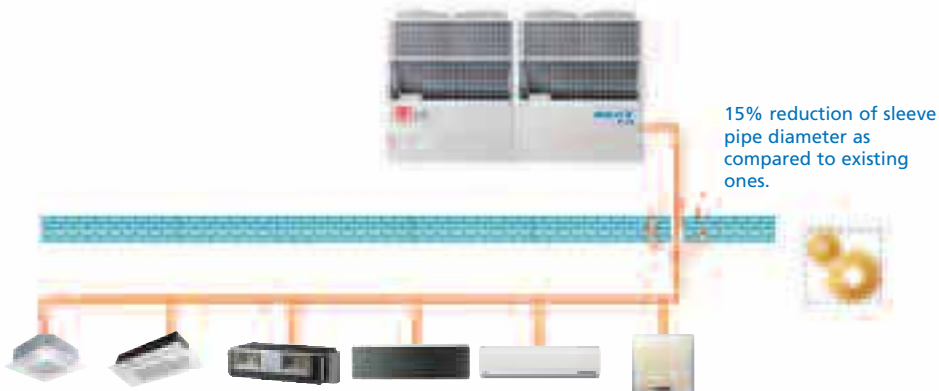

MULTI V™ PLUS



Efficiency

MULTI V™ PLUS uses the cutting edge artificial intelligence (known as 'fuzzy control') to obtain efficient operation and reduce noise.

■ Components fully protected from the elements

1. Electrical and mechanical parts are totally sealed in their enclosures.
2. Separated equipment space between compressors/control boxes, and heat exchangers.
3. Because the electrical and mechanical parts are sealed in their own enclosures, this makes them much more resistant to environment factors which can cause corrosion (such as dust and rain) - thus improving the lifetime of the outdoor unit.

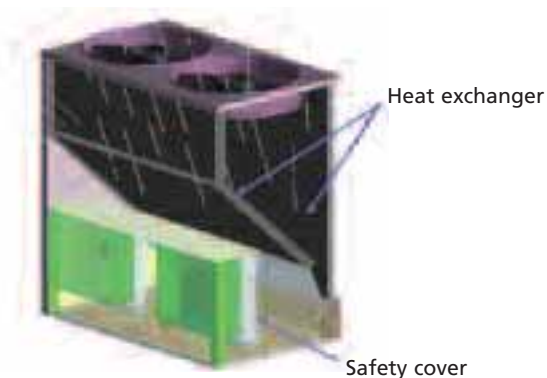

■ Alternate compressor cycling / back-up function

1. Duty-cycling function

MULTI V™ PLUS alternates several compressors conditionally to elongate product life span.

to meet diverse load in operation

1. inverter + constant speed 2 - inverter only
2. inverter + constant speed 3 - inverter only
3. inverter + constant speed 1 - inverter only

Normal running conditions

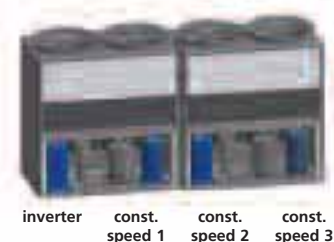

MULTI compressor system with longer life cycle for each compressor due to alternate operation

2. Back-up function

MULTI V™ PLUS can accommodate back up compressor operation when one compressor fails to raise product reliability.

to back up when constant speed compressor 2 is out of order

1. inverter + constant speed 2 (out of order)
2. inverter + constant speed 1 (back up operation)

Compressor failure situation



Alternative compressor starts to run

Subcooling circuit technology

The double tube heat exchanger (LG patent) improves heating and cooling capacity due to the advanced subcooling circuit.

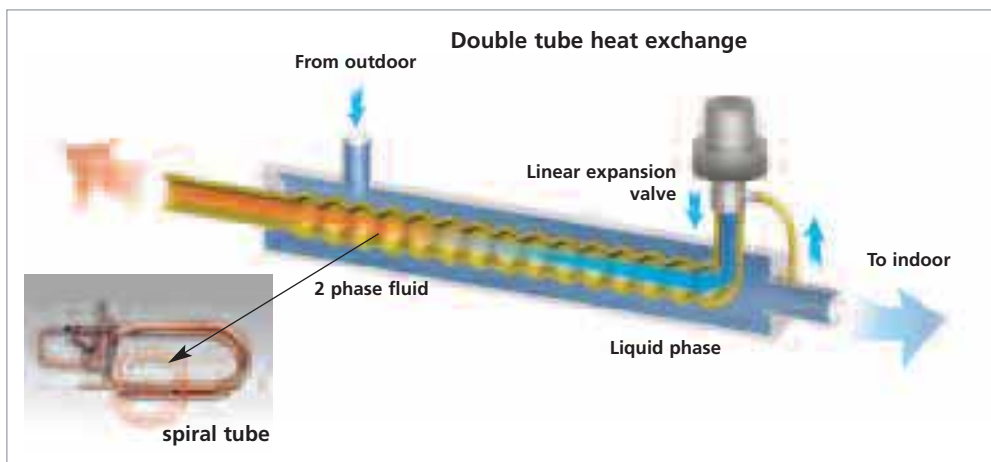

Fuzzy control system

The fuzzy control system enables optimum conditioning by quickly attaining and maintaining the desired temperature for a much more pleasant and comfortable environment.

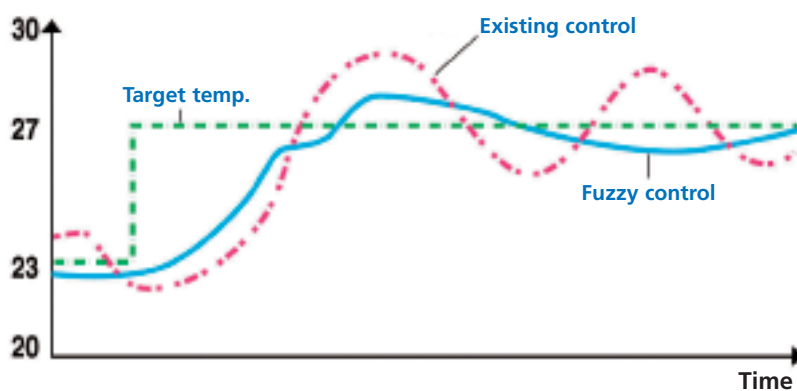

MULTI V™ PLUS



Longer piping, higher elevation

Reliability tests have proved that installations with piping length of 150m and elevation up to 50m are possible.

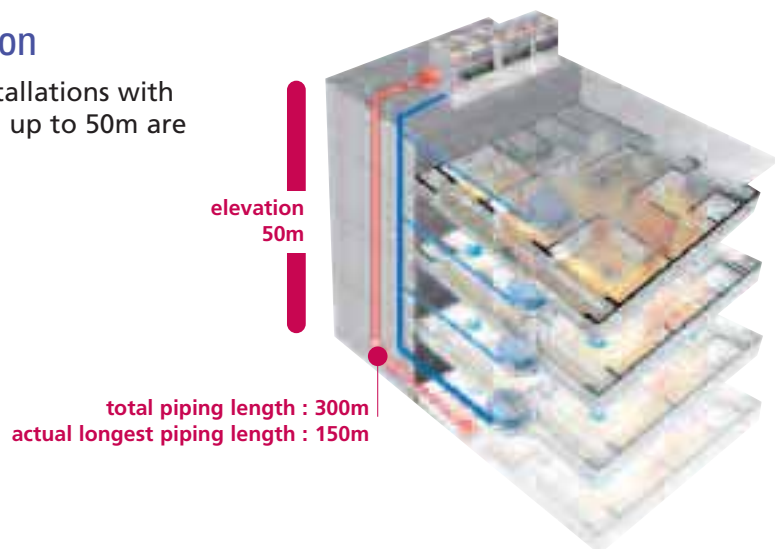

Wide operation range

Wide operation range

- Cooling mode : -5°C DB - 43°C DB
- Heating mode : -20°C WB - 24°C WB

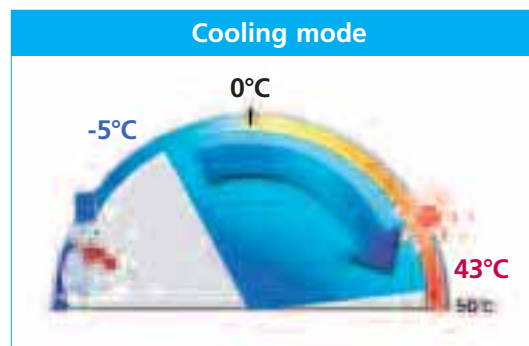
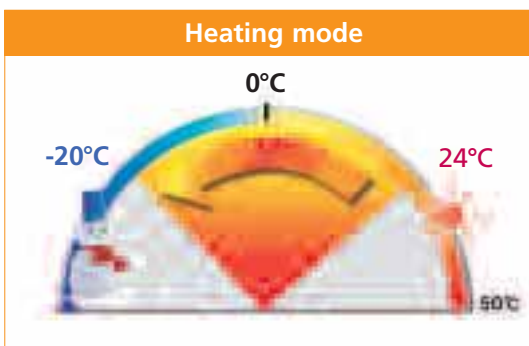

Convenience

From installation to maintenance and service, **MULTI V™ PLUS** adds convenience to cutting-edge technology.

Flexible pipe installation in 3 directions



Convenient swing doors/electrical component enclosures

The swing door design (using the electrical component enclosures) enables easy access to compressors and piping for service and maintenance purposes.



MULTI V™ PLUS is easy to load, un-load and move around

Sections cut into the base of the unit, for fork lift or pallet truck access. Enables easy loading for transportation, and easy moving when the unit is being installed/positioned.

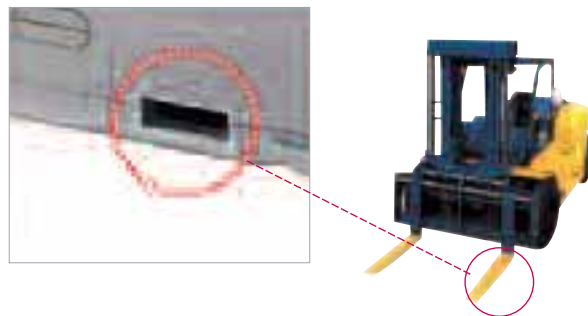

MULTI V™ PLUS



MULTI V™ PLUS

Outdoor unit specifications

Heat pump

* Outdoor Unit

HP			5	8	10	12	
Model			Combination Unit	ARUN508T1	ARUN808T1	ARUN1008T1	ARUN1208T1
			Independent Unit	ARUN508T1	ARUN808T1	ARUN1008T1	ARUN1208T1
Capacity	Cooling	kW	14.0	22.4	28.0	33.6	
		kcal/h	12,000	19,300	24,100	28,900	
		Btu/h	47,800	76,400	95,900	114,700	
	Heating	kW	15.8	25.2	31.5	37.8	
		kcal/h	13,600	21,700	27,100	32,500	
		Btu/h	53,900	86,000	107,500	129,000	
Power Input	Cooling	kW	4.5	6.8	8.5	10.6	
	Heating	kW	4.2	6.4	8.1	9.7	
COP	Cooling		3.11	3.29	3.29	3.17	
	Heating		3.76	3.94	3.89	3.90	
Power Supply		∅ / V / Hz	3/380-415/50				
Dimensions (W*H*D)		mm	806*1607*730	1280*1607*730	1280*1607*730	1280*1607*730	
Weight		kg	150	300	300	300	
Color			Warm Gray				
Sound pressure levels		dB(A) ± 3	56	58	58	58	
Fan	Type		Propeller Fan				
	Air flow rate [CMM]		105	190	190	190	
Compressor	Type		Scroll				
	Number of compressors		1	2	2	2	
Heat Exchanger			Gold Fin				
Refrigerant	Type		R410A				
	Charge	kg	4	8	8	8	
	Control		Electronic Expansion Valve				
Refrigerant oil	Type		FVC68D(PVE)				
	Charge	l	2.3	5.6	5.6	5.6	
Piping connections	Liquid (Flare)	mm(inch)	9.52(3/8)	9.52(3/8)	9.52(3/8)	12.7(1/2)	
	Gas (Brazing)	mm(inch)	15.88(5/8)	19.05(3/4)	22.2(7/8)	28.58(1 1/8)	
Number of outdoor units			1	1	1	1	
Number of maximum connectable indoor units			6	13	16	20	
Ratio of the connectable indoor units			50~130%				
Longest piping length / Elevation			150m / 50m				

Notes :

- Capacities are based on the following conditions
 Cooling-Indoor temp. 27°C[80.6°F]DB / 19°C[66.2°F]WB
 Outdoor temp. 35°C[95°F]DB / 24°C[75.2°F]WB
 Interconnecting Piping Length 7.5m
 Level Difference of Zero
 Heating-Indoor temp. 20°C[68°F]DB / 15°C[59°F]WB
 Outdoor temp. 7°C[44.6°F]DB / 6°C[42.8°F]WB
 Interconnecting Piping Length 7.5m
 Level Difference of Zero
- Capacities are net capacities
- Due to our policy of innovation some specifications may be changed without notification
- L.E.V.-Linear Expansion Valve

Conversion Formula

kcal/h = kW x 860
 Btu/h = kW x 3412
 cfm = m³/min x 35.3

Outdoor unit



Outdoor
unit



Heat pump

* Outdoor Unit

HP			14	16	18	20	22
Model	Combination Unit		ARUN1408T1	ARUN1608T1	ARUN1808T1	ARUN2008T1	ARUN2208T1
	Independent Unit		ARUN1408T1	ARUN808T1	ARUN1008T1	ARUN1008T1	ARUN1208T1
				ARUH808T1	ARUH808T1	ARUH1008T1	ARUH1008T1
Capacity	Cooling	kW	39.2	44.8	50.4	56.0	61.6
		kcal/h	33,700	38,500	43,300	48,200	53,000
		Btu/h	133,800	152,900	172,000	191,100	210,200
	Heating	kW	44.1	50.4	56.7	63.0	69.3
		kcal/h	37,900	43,300	48,800	54,200	59,600
		Btu/h	150,500	172,000	193,500	225,000	236,500
Power Input	Cooling	kW	12.8	13.6	15.3	17.0	19.1
	Heating	kW	11.5	12.8	14.5	16.2	17.8
COP	Cooling		3.06	3.29	3.29	3.29	3.23
	Heating		3.83	3.94	3.91	3.89	3.89
Power Supply		∅ / V / Hz	3/380~415/50				
Dimensions (W*H*D)		mm	1280*1607*730	2560*1607*730	2560*1607*730	2560*1607*730	2560*1607*730
Weight		kg	300	300*2	300*2	300*2	300*2
Color			Warm Gray				
Sound pressure levels		dB(A) ± 3	58	60	60	61	61
Fan	Type		Propeller Fan				
	Air flow rate	[CMM]	190	380	380	380	380
Compressor	Type		Scroll				
	Number of compressors		2	4	4	4	4
Heat Exchanger			Gold Fin				
Refrigerant	Type		R410A				
	Charge		8	16	16	16	16
	Control		Electronic Expansion Valve				
Refrigerant oil	Type		FVC68D(PVE)				
	Charge	l	5.6	5.6+5.6	5.6+5.6	5.6+5.6	5.6+5.6
Piping connections	Liquid (Flare)	mm(inch)	12.7(1/2)	12.7(1/2)	15.88(5/8)	15.88(5/8)	15.88(5/8)
	Gas (Brazing)	mm(inch)	28.58(1 1/8)	28.58(1 1/8)	28.58(1 1/8)	28.58(1 1/8)	28.58(1 1/8)
Number of outdoor units			1	2	2	2	2
Number of maximum connectable indoor units			20	20	20	20	22
Ratio of the connectable indoor units			50~130%				
Longest piping length / Elevation			150m / 50m				

Notes :

- Capacities are based on the following conditions
Cooling-Indoor temp. 27°C[80.6°F]DB / 19°C[66.2°F]WB
Outdoor temp. 35°C[95°F]DB / 24°C[75.2°F]WB
Interconnecting Piping Length 7.5m
Level Difference of Zero
- Capacities are net capacities
- Due to our policy of innovation some specifications may be changed without notification
- L.E.V. - Linear Expansion Valve

Heating-Indoor temp. 20°C[68°F]DB / 15°C[59°F]WB
Outdoor temp. 7°C[44.6°F]DB / 6°C[42.8°F]WB
Interconnecting Piping Length 7.5m
Level Difference of Zero

Conversion Formula

kcal/h = kW x 860
Btu/h = kW x 3412
cfm = m³/min x 35.3

MULTI V™ PLUS



MULTI V™ PLUS

Outdoor unit specifications

Heat pump

* Outdoor Unit

HP			24	26	28	30	32
Model	Combination Unit		ARUN2408T1	ARUN2608T1	ARUN2808T1	ARUN3008T1	ARUN3208T1
		Independent Unit	ARUN1208T1	ARUN1008T1	ARUN1008T1	ARUN1008T1	ARUN1208T1
		ARUH1208T1	ARUH808T1	ARUH1008T1	ARUH1008T1	ARUH1008T1	
			ARUH808T1	ARUH808T1	ARUH1008T1	ARUH1008T1	ARUH1008T1
Capacity	Cooling	kW	67.2	72.8	78.4	84.0	89.6
		kcal/h	57,800	62,600	67,400	72,200	77,100
		Btu/h	229,300	248,400	267,500	286,600	305,700
	Heating	kW	75.6	81.9	88.2	94.5	100.8
		kcal/h	65,000	70,400	75,900	81,300	86,700
		Btu/h	258,000	279,500	301,000	322,500	343,900
Power Input	Cooling	kW	21.2	22.1	23.8	25.5	27.6
	Heating	kW	19.4	20.9	22.6	24.3	25.9
COP	Cooling		3.17	3.29	3.29	3.29	3.25
	Heating		3.90	3.92	3.90	3.89	3.89
Power Supply	∅ / V / Hz	3/380~415/50					
Dimensions (W*H*D)	mm	2560*1607*730	3840*1607*730	3840*1607*730	3840*1607*730	3840*1607*730	
Weight	kg	300*2	300*3	300*3	300*3	300*3	
Color		Warm Gray					
Sound pressure levels	dB(A) ± 3	61	62	62	63	63	
Fan	Type	Propeller Fan					
	Air flow rate [CMM]	380	570	570	570	570	
Compressor	Type	Scroll					
	Number of compressors	4	6	6	6	6	
Heat Exchanger		Gold Fin					
Refrigerant	Type	R410A					
	Charge	16	24	24	24	24	
	Control	Electronic Expansion Valve					
Refrigerant oil	Type	FVC68D(PVE)					
	Charge l	5.6+5.6	5.6+5.6+5.6	5.6+5.6+5.6	5.6+5.6+5.6	5.6+5.6+5.6	
Piping connections	Liquid (Flare)	mm(inch)	15.88(5/8)	19.05(3/4)	19.05(3/4)	19.05(3/4)	19.05(3/4)
	Gas (Brazing)	mm(inch)	34.9(1 3/8)	34.9(1 3/8)	34.9(1 3/8)	34.9(1 3/8)	34.9(1 3/8)
Number of outdoor units		2	3	3	3	3	
Number of maximum connectable indoor units		24	32	32	32	32	
Ratio of the connectable indoor units		50~130%					
Longest piping length / Elevation		150m / 50m					

Notes :

- Capacities are based on the following conditions
 Cooling-Indoor temp. 27°C[80.6°F]DB / 19°C[66.2°F]WB
 Outdoor temp. 35°C[95°F]DB / 24°C[75.2°F]WB
 Interconnecting Piping Length 7.5m
 Level Difference of Zero
- Capacities are net capacities
- Due to our policy of innovation some specifications may be changed without notification
- L.E.V. -Linear Expansion Valve

Heating-Indoor temp. 20°C[68°F]DB / 15°C[59°F]WB
 Outdoor temp. 7°C[44.6°F]DB / 6°C[42.8°F]WB
 Interconnecting Piping Length 7.5m
 Level Difference of Zero

Conversion Formula
kcal/h = kW x 860
Btu/h = kW x 3412
cfm = m ³ /min x 35.3

Outdoor unit

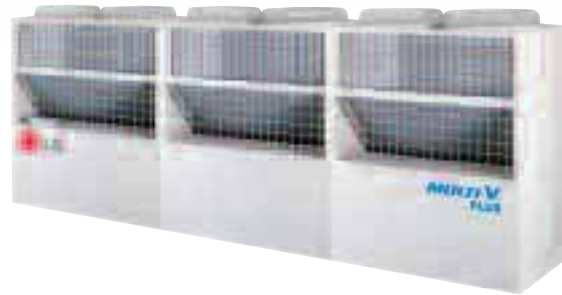
Outdoor
unit

Heat pump

* Outdoor Unit

HP			34	36	38	40
Model	Combination Unit		ARUN3408T1	ARUN3608T1	ARUN3808T1	ARUN4008T1
		Independent Unit	ARUN1208T1	ARUN1208T1	ARUN1408T1	ARUN1408T1
			ARUH1208T1	ARUH1208T1	ARUH1208T1	ARUH1408T1
			ARUH1008T1	ARUH1208T1	ARUH1208T1	ARUH1208T1
Capacity	Cooling	kW	95.2	100.8	106.4	112.0
		kcal/h	81,900	86,700	91,500	96,300
		Btu/h	324,800	343,900	363,100	382,200
	Heating	kW	107.1	113.4	119.7	126.0
		kcal/h	92,100	97,500	102,900	108,400
		Btu/h	365,400	386,900	408,400	429,900
Power Input	Cooling	kW	29.7	31.8	34.0	36.2
	Heating	kW	27.5	29.1	30.9	32.7
COP	Cooling		3.21	3.17	3.13	3.09
	Heating		3.89	3.90	3.87	3.85
Power Supply	Ø / V / Hz		3/380~415/50			
Dimensions (W*H*D)	mm		3840*1607*730	3840*1607*730	3840*1607*730	3840*1607*730
Weight	kg		300*3	300*3	300*3	300*3
Color	Warm Gray					
Sound pressure levels	dB(A) ± 3		63	63	63	63
Fan	Type		Propeller Fan			
	Air flow rate	[CMM]	570	570	570	570
Compressor	Type		Scroll			
	Number of compressors		6	6	6	6
Heat Exchanger	Gold Fin					
Refrigerant	Type		R410A			
	Charge		24	24	24	24
	Control		Electronic Expansion Valve			
Refrigerant oil	Type		FVC68D(PVE)			
	Charge	l	5.6+5.6+5.6	5.6+5.6+5.6	5.6+5.6+5.6	5.6+5.6+5.6
Piping connections	Liquid (Flare)	mm(inch)	19.05(3/4)	19.05(3/4)	19.05(3/4)	19.05(3/4)
	Gas (Brazing)	mm(inch)	34.9(1 3/8)	41.3(1 5/8)	41.3(1 5/8)	41.3(1 5/8)
Number of outdoor units			3	3	3	3
Number of maximum connectable indoor units			34	36	38	40
Ratio of the connectable indoor units			50~130%			
Longest piping length / Elevation			150m / 50m			

Notes :

- Capacities are based on the following conditions
 Cooling-Indoor temp. 27°C[80.6°F]DB / 19°C[66.2°F]WB Heating-Indoor temp. 20°C[68°F]DB / 15°C[59°F]WB
 Outdoor temp. 35°C[95°F]DB / 24°C[75.2°F]WB Outdoor temp. 7°C[44.6°F]DB / 6°C[42.8°F]WB
 Interconnecting Piping Length 7.5m Interconnecting Piping Length 7.5m
 Level Difference of Zero Level Difference of Zero
- Capacities are net capacities
- Due to our policy of innovation some specifications may be changed without notification
- L.E.V. -Linear Expansion Valve

Conversion Formula
kcal/h = kW x 860
Btu/h = kW x 3412
cfm = m ³ /min x 35.3

MULTI V™ SYNC



Outdoor unit



What is **MULTI VTM SYNC**

MULTI VTM SYNC is a three pipe heat recovery system, which means simultaneous cooling and heating is possible from one system. This is achieved using the three pipes from the outdoor unit in conjunction with heat recovery boxes. The heat recovery boxes (or HR boxes) are installed between the outdoor unit and indoor units, and the refrigerant is distributed to the indoor units in its required state (depending on whether or not cooling or heating is required). Heat that is removed from one room can be used elsewhere within the system where it is required, thus making the **MULTI VTM SYNC** even more efficient. The **MULTI VTM SYNC** is available from 8Hp (single module) up to 40Hp (combining multiple outdoor units together). Up to 40 indoor units can be connected to one system, reducing installation material cost, and installation time. Combined with the many control options on offer, the **MULTI VTM SYNC** system can offer a total building solution.

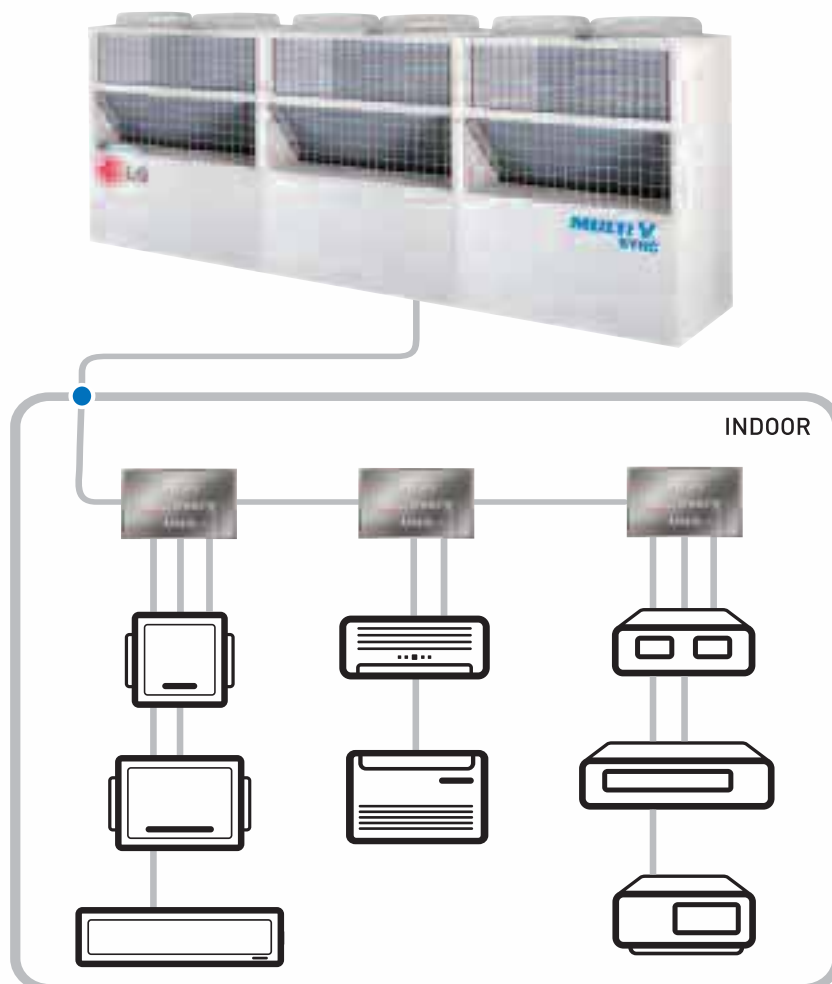

MULTI V™ SYNC



Technology

Simultaneous heating and cooling with one outdoor unit - **MULTI V™ SYNC**
 Your environment is ensured of optimum conditions regardless of season or space.

Technology

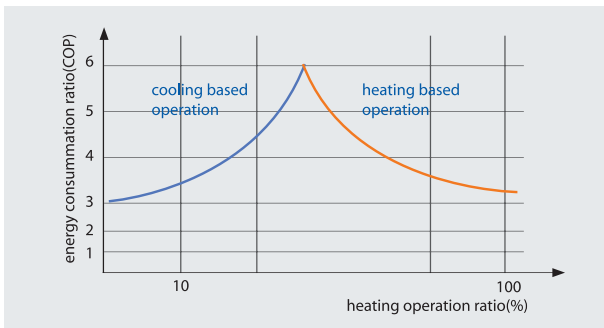
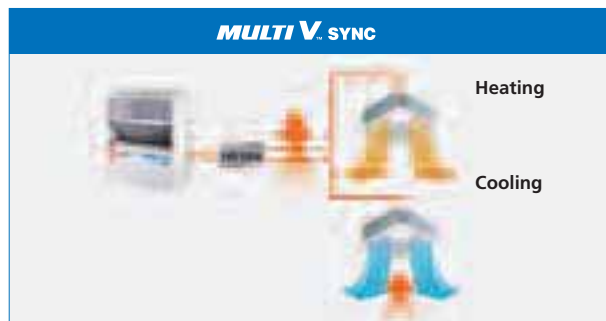
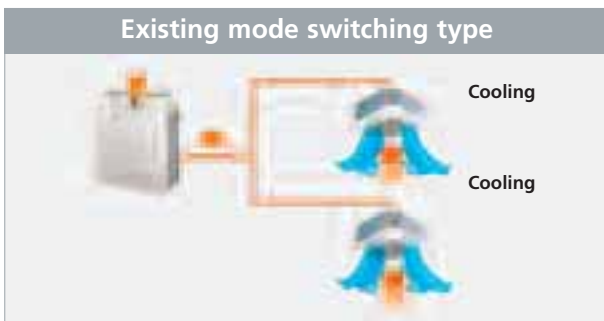

- Outdoor temperature: 7°C DB / 6°C WB
 - Indoor temperature : 20°C DB / 15°C WB

Heating based operation

: Many indoor units run in heating mode, a few run in cooling mode

Cooling based operation

: Many indoor units run in cooling mode, a few run in heating mode

Wide operation range

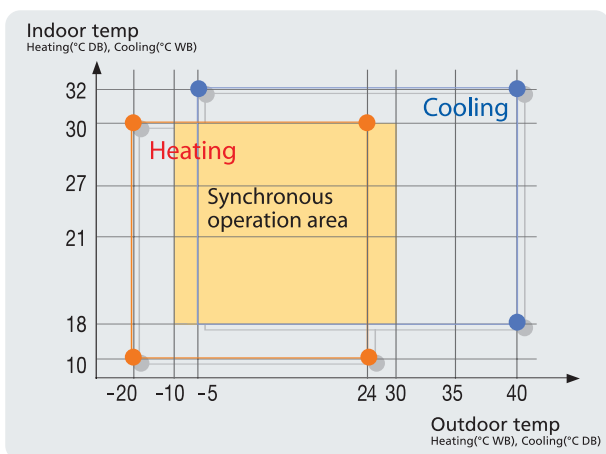

Wide operation range

- Cooling mode: -5°C WB to 43°C WB
- Heating mode: -20°C DB to 24°C DB
- Synchronous mode: -10°C DB to 30°C DB

Fuzzy control system

The fuzzy control system enables optimum conditioning by quickly attaining and maintaining the desired temperature for a much more pleasant and comfortable environment.

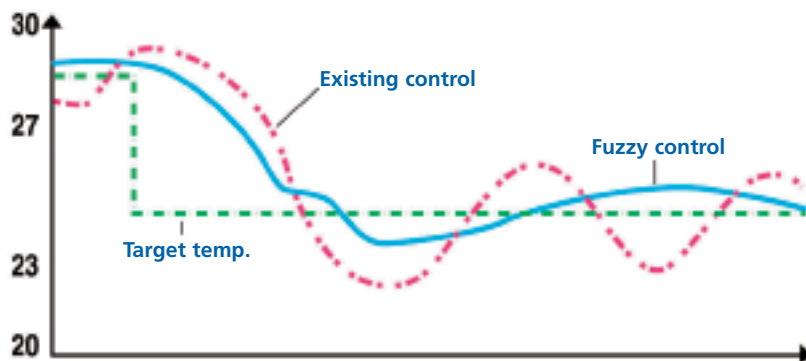

In a system that has non-linear characteristics, Fuzzy is a very effective control logic that quantifies a vague situation or condition.

MULTI V™ SYNC



AMC (Advanced Mode Change) control

AMC control provides an optimal operation under any conditions.

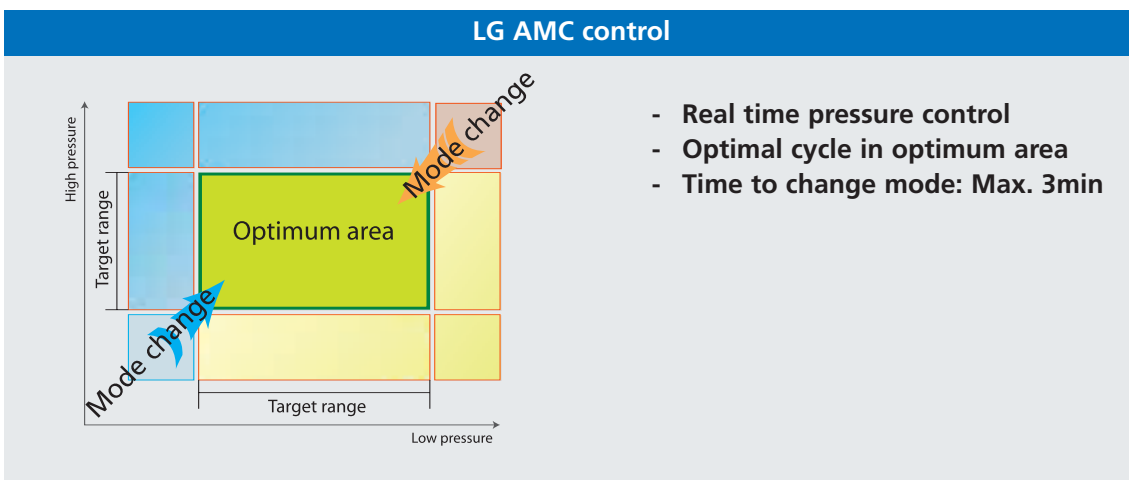
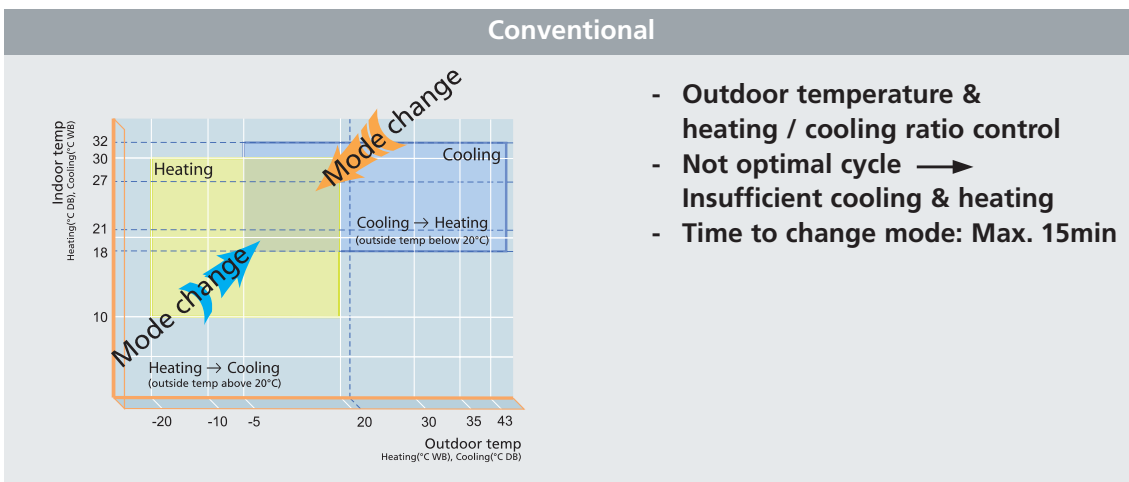

Outdoor unit

High efficiency heat recovery unit

- Max. 4 indoor units can be connected by module design.
- Due to the automatic search algorithm for piping detection, easy installation and effectiveness is improved.
- Subcooling cycle in HR unit results in the system running of maximum efficiency.

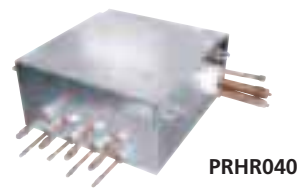
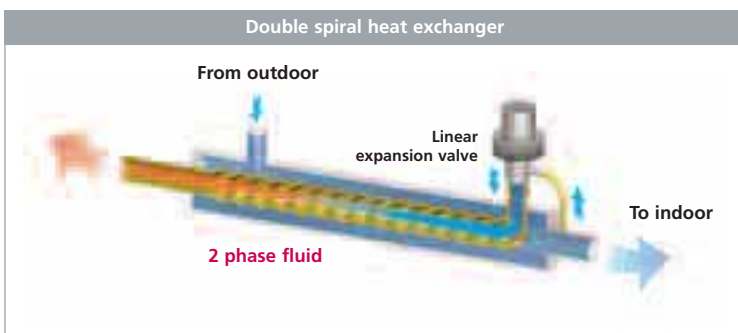

Flexible connection of HR unit

LG's heat recovery unit allows flexible connection both in series and in a row.

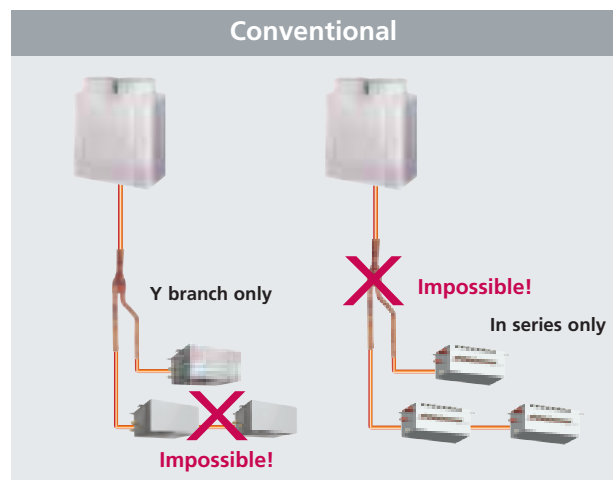
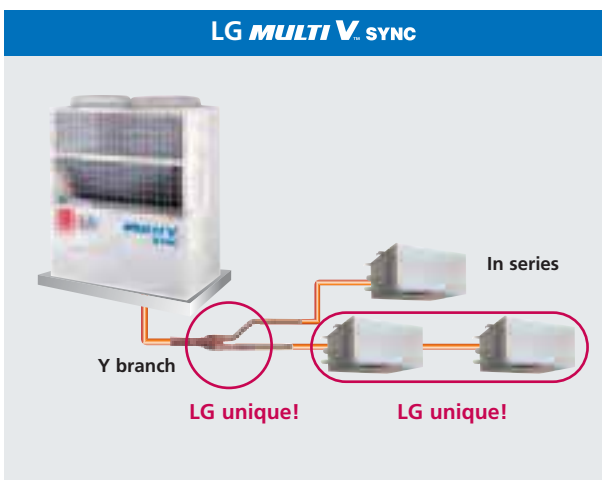

MULTI V™ SYNC



■ Reduced number of HR boxes required for same number of indoor units

The heat recovery box makes economical and convenient installation possible - less piping, and less units to install.

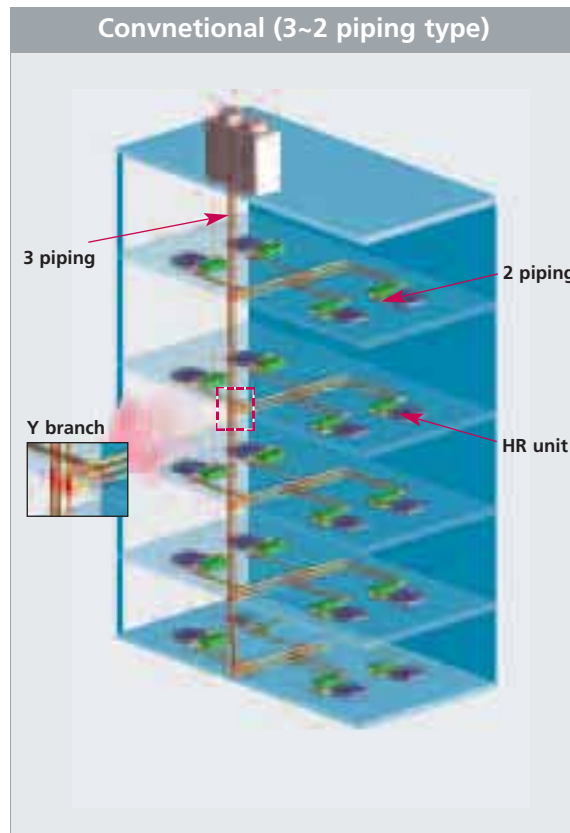
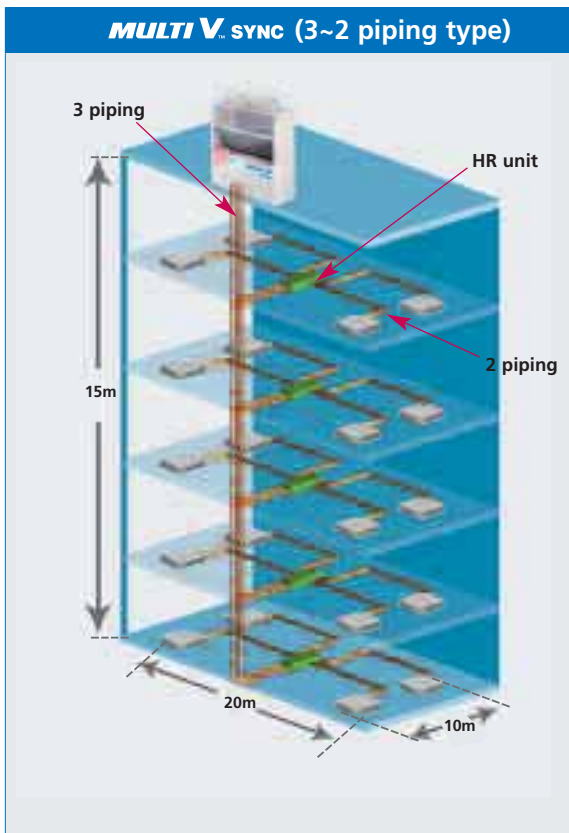

LG needs less installation cost than the conventional

	LG	Conventional
Y branch	12 unit	57 unit
HR unit	5 unit	20 unit
Total piping length	690 m	840 m

* Assumed with 5 stories building

■ Zoning after building alterations

Because each indoor unit has the ability to change mode whenever it chooses to do so, if the building layout changes (more partitions are installed), the indoor units will control individually as before. With conventional systems (designed only to the previous building layout), simultaneous heating and cooling may not always be possible.

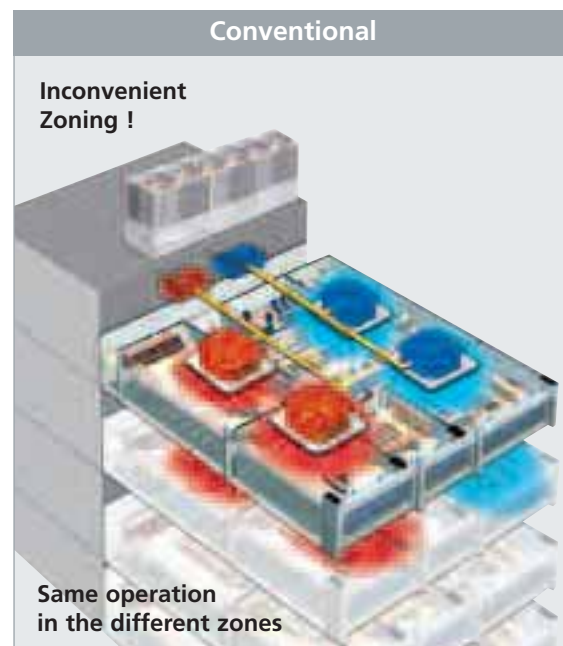

■ Fast mode change response

When the operating mode of an indoor unit is changed (i.e. from cooling to heating or visa versa), the response time of the mode change is fast compared to conventional systems. Not only is it fast for the room concerned, but also there is little or no capacity loss for all other units on the system. Therefore mode changes can happen comfortably and quickly for the entire system, regardless of seasonal conditions.

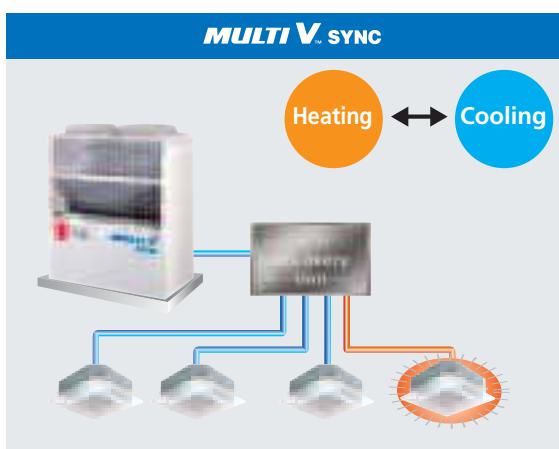

- Max. 3 minutes!

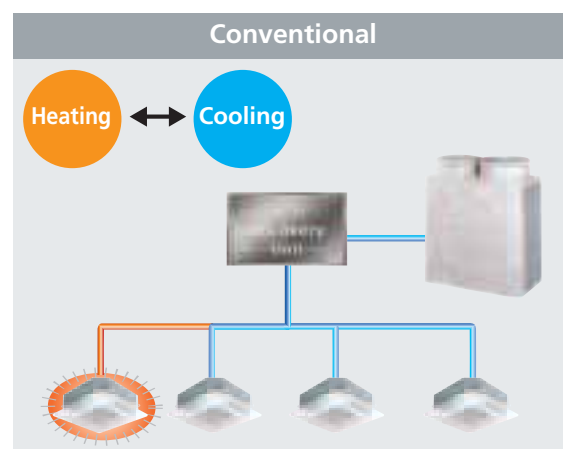

- About 20 minutes!

MULTI V™ SYNC



■ Applications

Some environments such as a computer room, mechanical room, hospital, restaurant, fitness centre, and sauna require cooling and heating at the same time.

Computer / mechanical room - because of excessive heat from the equipment, the computer and mechanical rooms need cooling even during the winter time.

Fitness centre - the exercise area may need different cooling or heating from the dressing room or rest area.

Restaurant - because of heat from the cooking equipment, the kitchen may need cooling even during the winter time.



Outdoor unit

Outdoor
unit

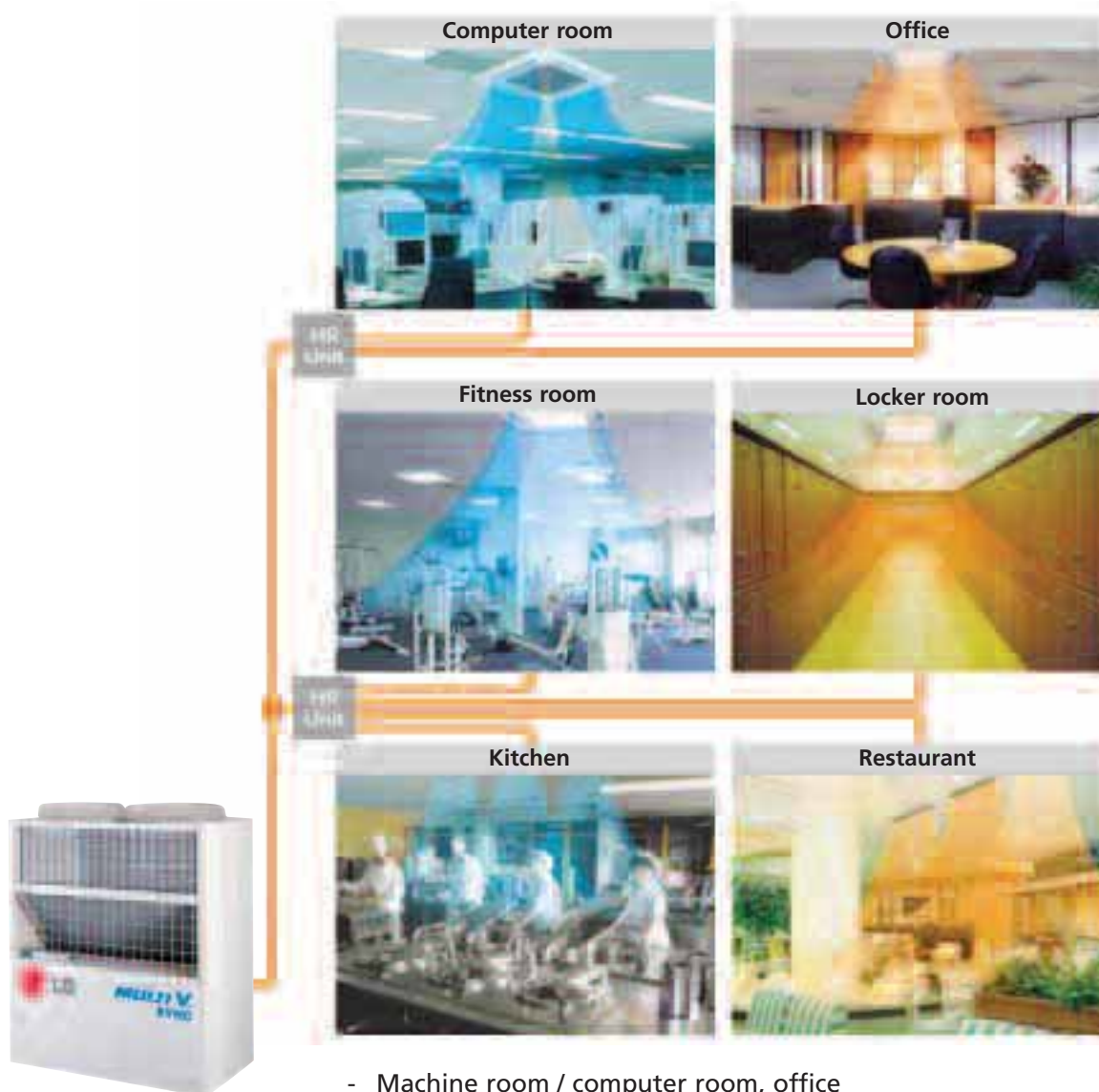

- Machine room / computer room, office
- Fitness room, locker room
- Kitchen, restaurant
- According to customer's need, heating & cooling may be required simultaneously. (hotel, office, etc.)

MULTI V™ SYNC



MULTI V™ SYNC

Outdoor unit specifications

Heat recovery

* Outdoor Unit

HP			8	10	12	14	16
Model	Combination Unit	ARUB808T1	ARUB1008T1	ARUB1208T1	ARUB1408T1	ARUB1608T1	
		Independent Unit	ARUB808T1	ARUB1008T1	ARUB1208T1	ARUB1408T1	ARUB808T1
						ARUS808T1	
Capacity	Cooling	kW	22.4	28.0	33.6	39.2	44.8
		kcal/h	19,300	24,100	28,900	33,700	38,500
		Btu/h	76,400	95,900	114,700	133,800	152,900
	Heating	kW	25.2	31.5	37.8	44.1	50.4
		kcal/h	21,700	27,100	32,500	37,900	43,300
		Btu/h	86,000	107,500	129,000	150,500	172,000
Power Input	Cooling	kW	6.8	8.5	10.6	12.8	13.6
	Heating	kW	6.4	8.1	9.7	11.5	12.8
COP	Cooling		3.29	3.29	3.17	3.06	3.29
	Heating		3.94	3.89	3.90	3.83	3.94
Power Supply	∅ / V / Hz	3/380-415/50					
Dimensions (W*H*D)	mm	1280*1607*730	1280*1607*730	1280*1607*730	1280*1607*730	2560*1607*730	
Weight	kg	300	300	300	300	300*2	
Color		Warm Gray					
Sound pressure levels	dB(A) ± 3	58	58	58	58	60	
Fan	Type	Propeller Fan					
	Air flow rate [CMM]	190	190	190	190	380	
Compressor	Type	Scroll					
	Number of compressors	2	2	2	2	4	
Heat Exchanger		Gold Fin					
Refrigerant	Type	R410A					
	Charge kg	8	8	8	8	16	
	Control	Electronic Expansion Valve					
Refrigerant oil	Type	FVC68D(PVE)					
	Charge l	5.6	5.6	5.6	5.6	5.6+5.6	
Piping connections	Liquid (Flare)	mm(inch)	9.52(3/8)	9.52(3/8)	12.7(1/2)	12.7(1/2)	12.7(1/2)
	Gas (Brazing)	mm(inch)	19.05(3/4)	22.2(7/8)	28.58(1 1/8)	28.58(1 1/8)	28.58(1 1/8)
	Discharge Gas (Brazing)	mm(inch)	15.88(5/8)	19.05(3/4)	19.05(3/4)	22.2(7/8)	22.2(7/8)
Number of outdoor units		1	1	1	1	2	
Number of maximum connectable indoor units		13	16	20	20	20	
Ratio of the connectable indoor units		50-130%					
Longest piping length / Elevation		150m / 50m					

Notes :

- Capacities are based on the following conditions
Cooling-Indoor temp. 27°C[80.6°F]DB / 19°C[66.2°F]WB
Outdoor temp. 35°C[95°F]DB / 24°C[75.2°F]WB
Interconnecting Piping Length 7.5m
Level Difference of Zero
- Capacities are net capacities
- Due to our policy of innovation some specifications may be changed without notification
- L.E.V. -Linear Expansion Valve

Heating-Indoor temp. 20°C[68°F]DB / 15°C[59°F]WB
Outdoor temp. 7°C[44.6°F]DB / 6°C[42.8°F]WB
Interconnecting Piping Length 7.5m
Level Difference of Zero

Conversion Formula
kcal/h = kW x 860
Btu/h = kW x 3412
cfm = m ³ /min x 35.3

Outdoor unit



Outdoor
unit

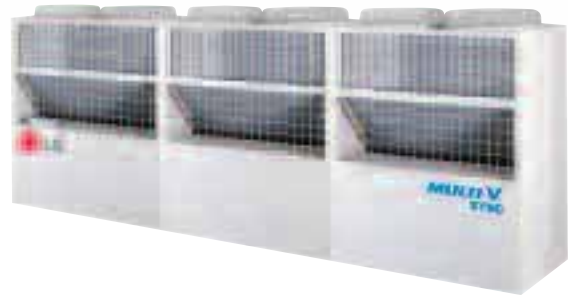

Heat recovery

* Outdoor Unit

HP			18	20	22	24	26
Model	Combination Unit		ARUB1808T1	ARUB2008T1	ARUB2208T1	ARUB2408T1	ARUB2608T1
	Independent Unit		ARUB1008T1	ARUB1008T1	ARUB1208T1	ARUB1208T1	ARUB1008T1
			ARUS808T1	ARUS1008T1	ARUS1008T1	ARUS1208T1	ARUS808T1
Capacity	Cooling	kW	50.4	56.0	61.6	67.2	72.8
		kcal/h	43,300	48,200	53,000	57,800	62,600
		Btu/h	172,000	191,100	210,200	229,300	248,400
	Heating	kW	56.7	63.0	69.3	75.6	81.9
		Kcal/h	48,800	54,200	59,600	65,000	70,400
		Btu/h	193,500	225,000	236,500	258,000	279,500
Power Input	Cooling	kW	15.3	17.0	19.1	21.2	22.1
	Heating	kW	14.5	16.2	17.8	19.4	20.9
COP	Cooling		3.29	3.29	3.23	3.17	3.29
	Heating		3.91	3.89	3.89	3.90	3.92
Power Supply	∅ / V / Hz	3/380~415/50					
Dimensions (W*H*D)	mm	2560*1607*730	2560*1607*730	2560*1607*730	2560*1607*730	3840*1607*730	
Weight	kg	300*2	300*2	300*2	300*2	300*3	
Color		Warm Gray					
Sound pressure levels	dB(A) ± 3	60	61	61	61	62	
Fan	Type	Propeller Fan					
	Air flow rate [CMM]	380	380	380	380	570	
Compressor	Type	Scroll					
	Number of compressors	4	4	4	4	6	
Heat Exchanger		Gold Fin					
Refrigerant	Type	R410A					
	Charge Kg	16	16	16	16	24	
	Control	Electronic Expansion Valve					
Refrigerant oil	Type	FVC68D(PVE)					
	Charge l	5.6+5.6	5.6+5.6	5.6+5.6	5.6+5.6	5.6+5.6+5.6	
Piping connections	Liquid (Flare)	mm(inch)	15.88(5/8)	15.88(5/8)	15.88(5/8)	15.88(5/8)	19.05(3/4)
	Gas (Brazeing)	mm(inch)	28.58(1 1/8)	28.58(1 1/8)	34.9(1 3/8)	34.9(1 3/8)	34.9(1 3/8)
	Discharge Gas (Brazeing)	mm(inch)	22.2(7/8)	22.2(7/8)	28.58(1 1/8)	28.58(1 1/8)	28.58(1 1/8)
Number of outdoor units		2	2	2	2	3	
Number of maximum connectable indoor units		20	20	22	24	32	
Ratio of the connectable indoor units		50~130%					
Longest piping length / Elevation		150m / 50m					

Notes :

- Capacities are based on the following conditions
Cooling-Indoor temp. 27°C[80.6°F]DB / 19°C[66.2°F]WB
Outdoor temp. 35°C[95°F]DB / 24°C[75.2°F]WB
Interconnecting Piping Length 7.5m
Level Difference of Zero
- Capacities are net capacities
- Due to our policy of innovation some specifications may be changed without notification
- L.E.V. -Linear Expansion Valve

Heating-Indoor temp. 20°C[68°F]DB / 15°C[59°F]WB
Outdoor temp. 7°C[44.6°F]DB / 6°C[42.8°F]WB
Interconnecting Piping Length 7.5m
Level Difference of Zero

Conversion Formula
kcal/h = kW x 860
Btu/h = kW x 3412
cfm = m ³ /min x 35.3

MULTI V™ SYNC



MULTI V™ SYNC

Outdoor unit specifications

Heat recovery

* Outdoor Unit

HP			28	30	32	34	36
Model	Combination Unit	ARUB2808T1	ARUB3008T1	ARUB3208T1	ARUB3408T1	ARUB3608T1	
		Independent Unit	ARUB1008T1	ARUB1008T1	ARUB1208T1	ARUB1208T1	ARUB1208T1
		ARUS1008T1	ARUS1008T1	ARUS1008T1	ARUS1208T1	ARUS1208T1	
		ARUS808T1	ARUS1008T1	ARUS1008T1	ARUS1008T1	ARUS1208T1	
Capacity	Cooling	kW	78.4	84.0	89.6	95.2	100.8
		kcal/h	67,400	72,200	77,100	81,900	86,700
		Btu/h	267,500	286,600	305,700	324,800	343,900
	Heating	kW	88.2	94.5	100.8	107.1	113.4
		kcal/h	75,900	81,300	86,700	92,100	97,500
		Btu/h	301,000	322,500	343,900	365,400	386,900
Power Input	Cooling	kW	23.8	25.5	27.6	29.7	31.8
	Heating	kW	22.6	24.3	25.9	27.5	29.1
COP	Cooling		3.29	3.29	3.25	3.21	3.17
	Heating		3.90	3.89	3.89	3.89	3.90
Power Supply	∅ / V / Hz		3/380~415/50				
Dimensions (W*H*D)	mm		3840*1607*730	3840*1607*730	3840*1607*730	3840*1607*730	3840*1607*730
Weight	kg		300*3	300*3	300*3	300*3	300*3
Color	Warm Gray						
Sound pressure levels	dB(A) ± 3		62	63	63	63	63
Fan	Type		Propeller Fan				
	Air flow rate	[CMM]	570	570	570	570	570
Compressor	Type		Scroll				
	Number of compressors		6	6	6	6	6
Heat Exchanger	Gold Fin						
Refrigerant	Type		R410A				
	Charge	kg	24	24	24	24	24
	Control		Electronic Expansion Valve				
Refrigerant oil	Type		FVC68D(PVE)				
	Charge	l	5.6+5.6+5.6	5.6+5.6+5.6	5.6+5.6+5.6	5.6+5.6+5.6	5.6+5.6+5.6
Piping connections	Liquid (Flare)	mm(inch)	19.05(3/4)	19.05(3/4)	19.05(3/4)	19.05(3/4)	19.05(3/4)
	Gas (Brazing)	mm(inch)	34.9(1 3/8)	34.9(1 3/8)	34.9(1 3/8)	34.9(1 3/8)	41.3(1 5/8)
	Discharge Gas (Brazing)	mm(inch)	28.58(1 1/8)	28.58(1 1/8)	28.58(1 1/8)	28.58(1 1/8)	28.58(1 1/8)
Number of outdoor units			3	3	3	3	3
Number of maximum connectable indoor units			32	32	32	34	36
Ratio of the connectable indoor units			50~130%				
Longest piping length / Elevation			150m / 50m				

Notes :

- Capacities are based on the following conditions
 Cooling-Indoor temp. 27°C[80.6°F]DB / 19°C[66.2°F]WB Heating-Indoor temp. 20°C[68°F]DB / 15°C[59°F]WB
 Outdoor temp. 35°C[95°F]DB / 24°C[75.2°F]WB Outdoor temp. 7°C[44.6°F]DB / 6°C[42.8°F]WB
 Interconnecting Piping Length 7.5m Interconnecting Piping Length 7.5m
 Level Difference of Zero Level Difference of Zero
- Capacities are net capacities
- Due to our policy of innovation some specifications may be changed without notification
- L.E.V. -Linear Expansion Valve

Conversion Formula

kcal/h = kW x 860
 Btu/h = kW x 3412
 cfm = m³/min x 35.3

Outdoor unit

Outdoor
unit
 Heat recovery

* Outdoor Unit

HP			38	40
Model	Combination Unit		ARUB3808T1	ARUB4008T1
		Independent Unit	ARUB1408T1	ARUB1408T1
			ARUS1208T1	ARUS1408T1
			ARUS1208T1	ARUS1208T1
Capacity	Cooling	kW	106.4	112.0
		kcal/h	91,500	96,300
		Btu/h	363,100	382,200
	Heating	kW	119.7	126.0
		kcal/h	102,900	108,400
		Btu/h	408,400	429,900
Power Input	Cooling	kW	34	36.2
	Heating	kW	30.9	32.7
COP	Cooling		3.13	3.09
	Heating		3.87	3.85
Power Supply	∅ / V / Hz	3/380-415/50		
Dimensions (W*H*D)	mm	3840*1607*730	3840*1607*730	
Weight	kg	300*3	300*3	
Color	Warm Gray			
Sound pressure levels	dB(A) ± 3		63	63
Fan	Type	Propeller Fan		
	Air flow rate [CMM]	570		570
Compressor	Type	Scroll		
	Number of compressors	6		6
Heat Exchanger	Gold Fin			
Refrigerant	Type	R410A		
	Charge	kg	24	24
	Control	Electronic Expansion Valve		
Refrigerant oil	Type	FVC68D(PVE)		
	Charge	l	5.6+5.6+5.6	5.6+5.6+5.6
Piping connections	Liquid (Flare)	mm(inch)	19.05(3/4)	19.05(3/4)
	Gas (Brazing)	mm(inch)	41.3(1 5/8)	41.3(1 5/8)
	Discharge Gas (Brazing)	mm(inch)	34.9(1 3/8)	34.9(1 3/8)
Number of outdoor units			3	3
Number of maximum connectable indoor units			38	40
Ratio of the connectable indoor units			50~130%	
Longest piping length / Elevation			150m / 50m	

Notes :

- Capacities are based on the following conditions
Cooling-Indoor temp. 27°C[80.6°F]DB / 19°C[66.2°F]WB
Outdoor temp. 35°C[95°F]DB / 24°C[75.2°F]WB
Interconnecting Piping Length 7.5m
Level Difference of Zero
- Capacities are net capacities
- Due to our policy of innovation some specifications may be changed without notification
- L.E.V.- Linear Expansion Valve

Heating-Indoor temp. 20°C[68°F]DB / 15°C[59°F]WB
Outdoor temp. 7°C[44.6°F]DB / 6°C[42.8°F]WB
Interconnecting Piping Length 7.5m
Level Difference of Zero

Conversion Formula

kcal/h = kW x 860
Btu/h = kW x 3412
cfm = m³/min x 35.3

MULTI V™ SPACE



Applications

- Flat
- Premium village
- High rise apartment
- Office

Outdoor unit

What is **MULTI V** SPACE

MULTI V SPACE is a two pipe heat pump system, specifically designed with internal installation in mind. The air induction and air discharge are located on the same side, which is ideal for installing against a louvered wall. **MULTI V** SPACE is available in 5Hp and 10Hp models, and up to 16 indoor units can be connected to one system. Combined with the many control options on offer, the **MULTI V** SPACE system can offer a total building solution.

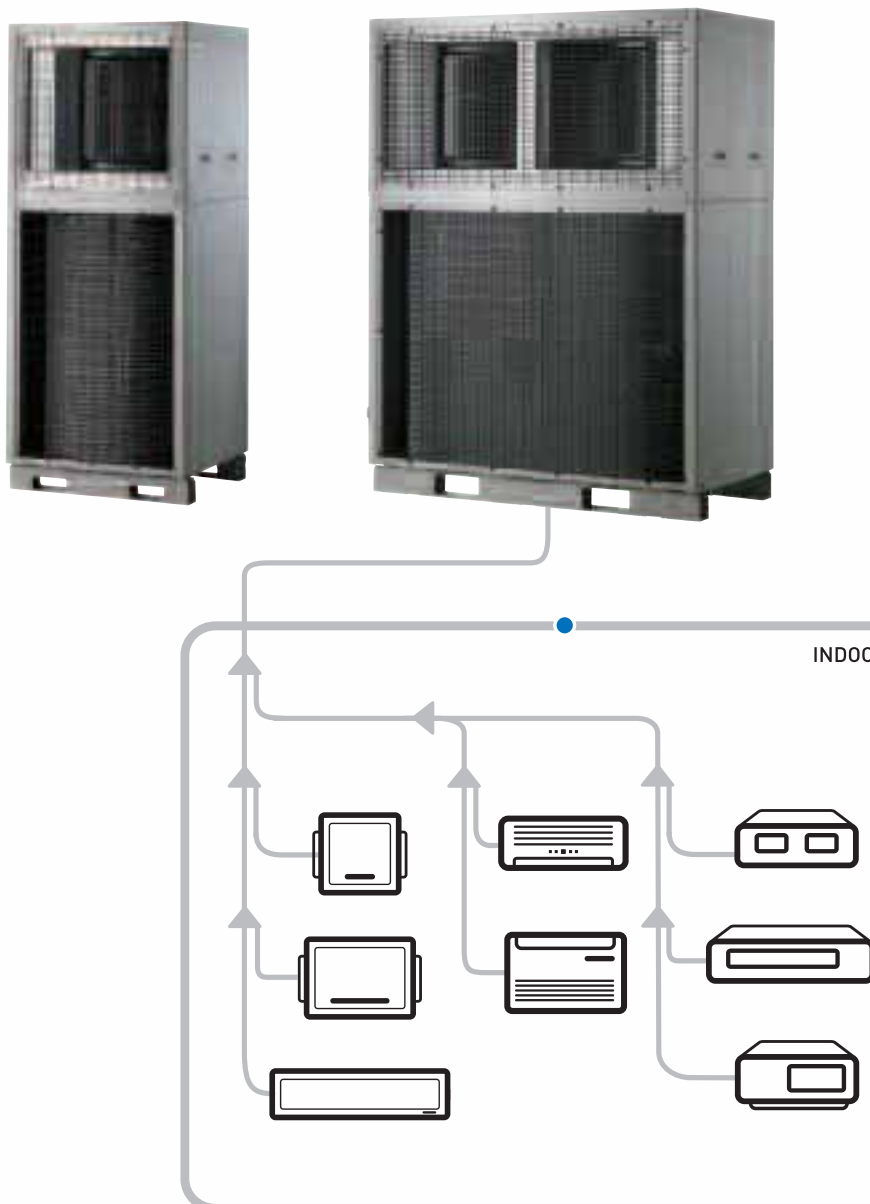

MULTI V™ SPACE



■ MULTI V™ SPACE has the following differentiating features

- Air induction and discharge is combined on the same side, allowing easy installation to a louvered wall without the need to install expensive and time consuming duct work.
- Powerful sirocco fans discharge the air to the left and right, preventing air short cycling between units installed next to each other and between floors.
- Fully inverter driven for higher efficiency and reduced operation noise.
- Piping can exit the unit from the left or right front panels, depending on installation requirements.
- Because of the design of **MULTI V. SPACE**, less area is actually required for the installation of the unit, compared to conventional systems installed in the same way.
- The External Static Pressure on the fans can be increased up to 140 pascals if ducting is required to be fitted to the outdoor unit. This is done by carrying out a setting on the main PCB.

■ Cutting edge technology and design set a new standard for outdoor units

Unlike existing units which are awkward when matched with internal installation applications (due to ducting configuration and the problems faced with three sided air induction), the **MULTI V. SPACE** design greatly reduces installation area requirement, meaning floor space can be retained for living/working area, rather than wasted as a plant room.



Interior

■ Various types of indoor unit help create a pleasant interior environment

The ceiling mounted indoor units save space and **ART COOL™** indoor units can be chosen to blend in nicely with existing décor - whether the application is residential or commercial.



MULTI V™ SPACE



Space Saving

The design of the **MULTI V™ SPACE** means that less area is actually required to install the unit, compared to equivalent types of system used in this type of application.

■ Retain useable floor space by reducing plant room size

Reduction of the required installation space by up to 50% over conventional systems, means more floor space can be retained as living/working space (depending on application). Or if the plant room size cannot be decreased, the remaining space inside it can be used to install more systems, or other equipment/services. Either way, this system gives floor space back to the end user.

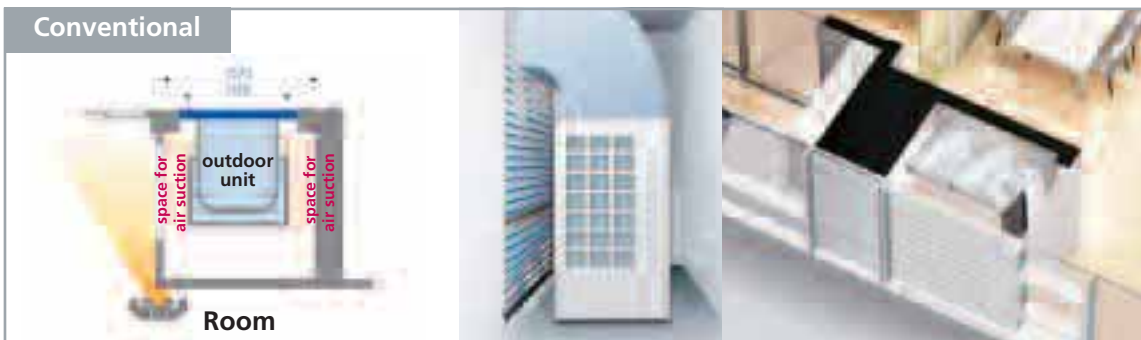

* based on heat pump 5HP

Economy

Cutting edge inverter system technology offers high efficiency and economical operation.

MULTI V[™] SPACE is a high efficiency inverter system

MULTI V[™] SPACE uses frequency controlled inverter compressor(s) and fan motor(s), to enable capacity control according to the indoor load. **MULTI V[™] SPACE** has a COP of 3.9 in cooling, and 4.1 in heating.

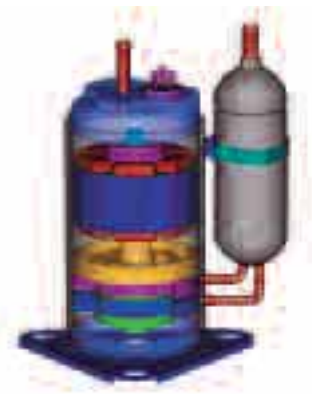

Precise inverter control ensures quick cooling and heating, with minimum temperature deviation

When the outside temperature is relatively stable, the compressor frequency is reduced, (it is not stopped) to ensure comfortable room temperatures. The desired temperature is obtained quickly by increasing the compressor frequency as the indoor unit load requires it to do so.

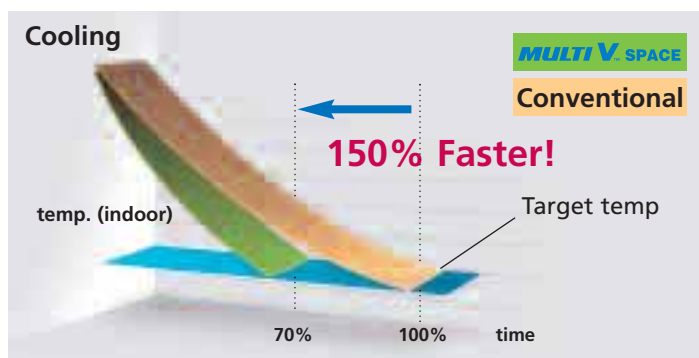
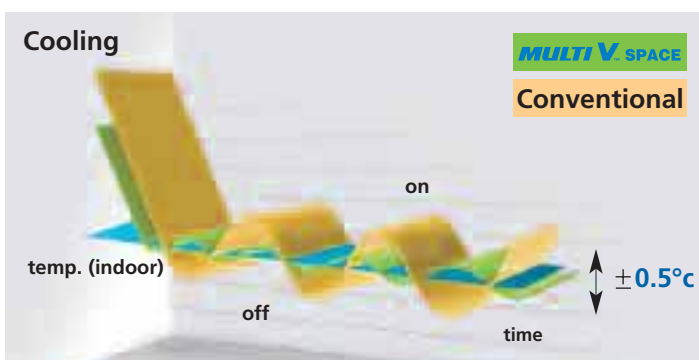

MULTI VTM SPACE



Design

MULTI VTM SPACE has applied frontal induction and discharge method for the first time on a VRF unit, therefore keeping the building interior safe from strong winds associated with high rise buildings.

■ Sirocco fans designed to withstand high building wind speeds

Building wind and reverse wind effect are stronger at higher floor levels, which can cause discharge air to short cycle back to the induction side affecting system control. It can also cause damage to the fans, which in turn will considerably reduce system performance. However, **MULTI VTM SPACE** is designed to generate very strong airflow (7m/s or more) to overcome this problem. This makes **MULTI VTM SPACE** ideal for use in such high rise applications.

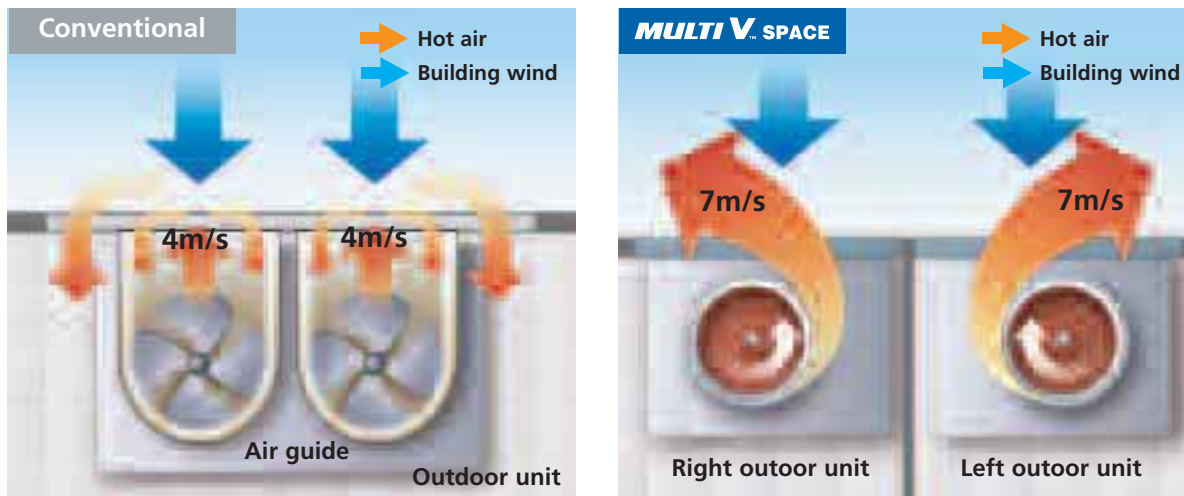

■ No interference from the discharge air between units or between floors

Because of the symmetrical design characteristics of conventional VRF systems, high rise installation is not always recommended (due to heat columns affecting system control on higher floors). **MULTI VTM SPACE** solves such installation problems using powerful left and right air discharge fans which throw the air outwards rather than upwards, allowing high rise installation with no control problems on the upper floors.

Sirocco fan



■ If ducting is installed, fan external static pressure can be increased

- Enhanced installation flexibility (doesn't just have to be installed against a louvered wall).
- No need to change the fan motor (jumper settings made on the main PCB).
- No capacity reduction, or increase in noise levels.

How to set up E.S.P (unit: mmAq)			
	10HP	5HP	
1)	0~3	0~2	○ ○ ○ ○ ○ ○ ○ ○
2)	3~6	2~3	○ ○ ○ ○ connector
3)	6~8	3~4	○ ○ connector ○ ○ ○ ○
4)	8~10	4~5	connector ○ ○ ○ ○ ○ ○
5)	10~12	5~6	○ ○ connector connector
6)	12~14	6~7	connector ○ ○ connector

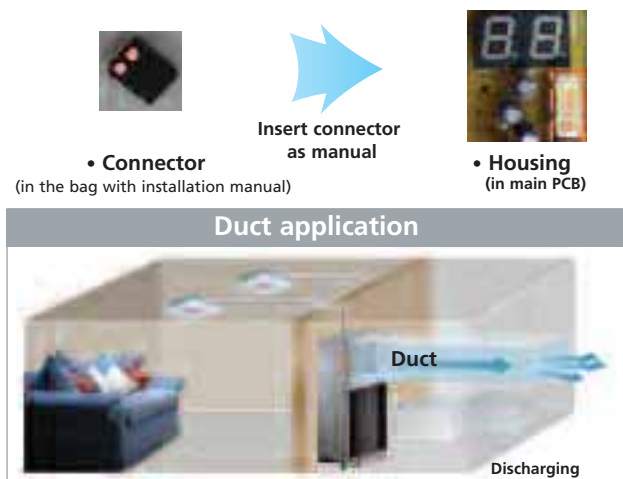

■ LG patent for **MULTI V™ SPACE**

All technologies in the **MULTI V™ SPACE** which make it a distinctive, unique unit has been applied for patents domestically and internationally. And, some of them have already been registered.

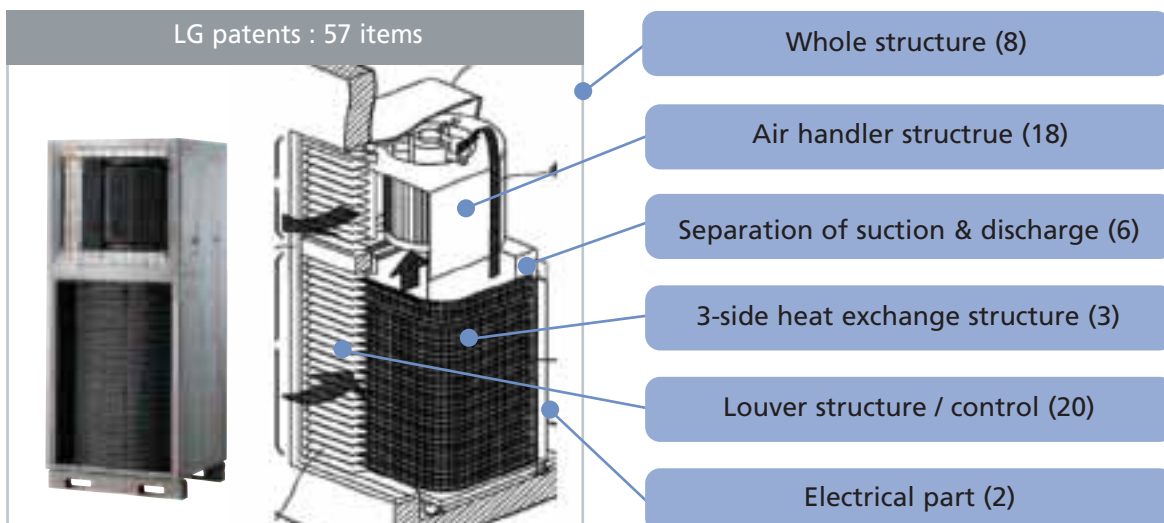

MULTI V™ SPACE



Comfort & Silence

When used in residential applications, **MULTI V. SPACE** can eliminate such problems caused by operational noise, vibration, and uncomfortable air drafts from discharge air (i.e. on a balcony).

■ The directional discharge air outlet eliminates hot air drafts

The sealed structure of the **MULTI V. SPACE**, coupled with the frontal air induction and discharge, reduces the need for extra space required for air induction, and eliminates the generation of hot air drafts, ensuring a comfortable environment i.e. for a balcony or decking/patio area.



■ Reduced noise and vibration

The other advantage of the sealed structure of the **MULTI V. SPACE** is drastic noise and vibration reduction. The noise is reduced due to the frontal air discharge design, and the fact that the sealed design reduces 'noise leakage' through the body of the unit. This means that the noise level indoors is very quiet indeed compared with conventional system used in this type of application.



The indoor noise level is maintained at 30~40dBA, as quiet as being in the library.

MULTI V™ SPACE

Outdoor unit specifications



* Outdoor Unit



HP			5	10
Model		Independent Unit	ARUN508RV0 (Right Discharge) ARUN508LV0 (Left Discharge)	ARUN1008F20
Capacity	Cooling	kW	14.0	28.0
		kcal/h	12,000	24,100
		Btu/h	47,800	95,900
	Heating	kW	16.0	31.5
		kcal/h	13,760	27,100
		Btu/h	54,592	107,500
Power Input	Cooling	kW	4.20	7.18
	Heating	kW	4.40	7.69
COP	Cooling		3.33	3.90
	Heating		3.64	4.10
Power Supply		∅ / V / Hz	3/380-415/50	
Dimensions (W*H*D)		mm	750*1790*650	1400*1790*650
Weight		kg	190	350
Color			Warm Gray	
Sound pressure levels		dB(A)	49	55
E.S.P range		mmAq	0~7	0~14
Fan	Type		Siroco Fan	
	Air flow rate	[CMM]	100	170
Compressor	Type		DC Inverter Rotary	
	Number of compressors		1	2
Heat Exchanger			Gold Fin	
Refrigerant	Type		R410A	
	Charge	kg	4.7	9.5
	Control		Electronic Expansion Valve	
Refrigerant oil	Type		FV50S	
	Charge	l	2.3	4.1
Piping connections	Liquid (Flare)	mm(inch)	9.52(3/8)	9.52(3/8)
	Gas (Brazing)	mm(inch)	15.88(5/8)	22.2(7/8)
Number of outdoor units			1	1
Number of maximum connectable indoor units			8	16
Ratio of the connectable indoor units			50~130%	
Longest piping length / Elevation			150m / 50m	

Notes :

















- Capacities are based on the following conditions
 Cooling-Indoor temp. 27°C(80.6°F)DB / 19°C(66.2°F)WB
 Outdoor temp. 35°C(95°F)DB / 24°C(75.2°F)WB
 Interconnecting Piping Length 7.5m
 Level Difference of Zero
 Heating-Indoor temp. 20°C(68°F)DB / 15°C(59°F)WB
 Outdoor temp. 7°C(44.6°F)DB / 6°C(42.8°F)WB
 Interconnecting Piping Length 7.5m
 Level Difference of Zero
- Capacities are net capacities
- Due to our policy of innovation some specifications may be changed without notification
- L.E.V. -Linear Expansion Valve

Conversion Formula

kcal/h = kW x 860
 Btu/h = kW x 3412
 cfm = m³/min x 35.3

MULTI V™ Indoor unit

If you need a highly efficient air conditioning system in your building, LG **MULTI V™** is the right choice for you.

-  **NEO Plasma Air Purifying System**
-  **Auto Cleaning**
-  **Jet Cool**
-  **Natural Wind By CHAOS Swing**
-  **Wireless Remote Controller (Accessory)**
-  **Sleep Mode Auto Operation (Wireless remote controller only)**
-  **Healthy Dehumidification**
-  **Auto Restart**
-  **Hot Start (Heat pump only)**
-  **4-Way Air Deflection**
-  **Child Lock Function (Wired remote controller only)**
-  **Auto Swing**
-  **Soft Dry Operation Mode**
-  **Weekly Program (Wired remote controller only)**
-  **Low Standby Power**
-  **Two Thermistor Control (Wired remote controller only)**
-  **Group Control (Wired remote controller only)**
-  **Changable Panel**

Ceiling Concealed Duct

Floor Standing



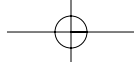

**ART COOL
Series**



**Wall Mounted
Ceiling Cassette**



**Ceiling & Floor
Ceiling Suspended**

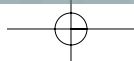
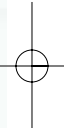
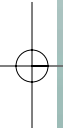



Indoor unit



ART COOL Gallery



ART COOL Mirror



ART COOL Wide



ART COOL Panel

ART COOL Series

LG's new stylish air conditioning unit is a work of art. Combine looks with efficiency and you have the ART COOL air conditioner. Looking nothing like a conventional wall mounted split system, LG has been able to create a design conscious air conditioning unit that compliments any interior decor.



ART COOL Series

■ Sophisticated design

An air conditioner once installed will always be with you.
You need a modern and simply designed air conditioner for your style and interior.
LG **ART COOL** is a sophisticated design for your style.

■ Ez - replaceable color panel

Available in a wide choice of six colors (mirror, metal, blue, cherry, wood and white wood),
the mirror display and classy interior curl-fit finish bring a cool and modern look.
You can also easily change the color panel.

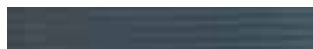

Mirror



Cherry



Metal



Wood



Blue



White wood

■ Neo Plasma Air Purifying System

LG's unique NEO Plasma Air Purifying System is equipped with 7 specialized filters in 5 separate stages to enhance its cleaning power. It reduces fine dust and mold, unpleasant odors and cigarette smoke as air passes through each filter.





■ 4 - Way auto swing

The LG air conditioning units can now automatically distribute the air 4 ways. This effectively eliminates hot and cold patches, keeping the room at a more stable temperature.



■ Digital air flow control

The air flow is controlled to provide comfort and convenience.



Normal
fast & even widely



Jet cool
speedy & powerful



Sleep mode
indirectly & softly

■ 3 - Dimensional air flow

Improving conventional air conditioners that expel air in one direction only, this powerful system pours out cool air from three sides.

■ Ultra thin

Technology mixed with a touch of art results in a super slim design.



137mm



ART COOL Series

ART COOL Gallery

ARNU07GSF11 / ARNU09GSF11 / ARNU12GSF11

■ How to replace the picture

LG is proud to introduce the ART COOL SF Series.

It boasts an unprecedented feature which allows you to use the front panel as a picture frame. Along with its simple and sleek design, ART COOL uses state-of-the-art technology for assuring customer satisfaction



Accessories

Wired remote controller



Deluxe type



Standard type



Simple type



Simple for hotel Type

Wireless remote controller



Indoor unit



Indoor unit

 Specifications

Model	Unit	ARNU07GSF11	ARNU09GSF11	ARNU12GSF11	
Capacity	Cooling	kW	2.2	2.8	3.6
		kcal/h	1,900	2,400	3,100
		Btu/h	7,500	9,600	12,300
	Heating	kW	2.5	3.2	4.0
		kcal/h	2,200	2,800	3,400
		Btu/h	8,500	10,900	13,600
Power	Cooling	W	30	30	30
Input	Heating	W	30	30	30
Power Supply	∅ / V / Hz	1/220-240/50			
Dimensions(W*D*H)	mm	600*146*600			
Weight	kg	15	15	15	
Sound pressure levels(H/M/L)	dBa±3	38/32/27	38/32/27	44/38/32	
Air flow rate	H/M/L	CMM	8.1/6.3/4.2	8.1/6.3/4.2	9.3/7.7/6.0
Neo Plasma air purifying filter		Basic	Basic	Basic	
Piping	Liquid	mm(inch)	6.35(1/4)	6.35(1/4)	6.35(1/4)
Connection	Gas	mm(inch)	12.7(1/2)	12.7(1/2)	12.7(1/2)
	Drain(OD/ID)	mm	16.2/12.2	16.2/12.2	16.2/12.2

Notes :

- Capacities are based on the following conditions
Cooling-Indoor temp. 27°C[80.6°F]DB / 19°C[66.2°F]WB
Outdoor temp. 35°C[95°F]DB / 24°C[75.2°F]WB
Interconnecting Piping Length 7.5m
Level Difference of Zero
- Capacities are net capacities
- Due to our policy of innovation some specifications may be changed without notification
- L.E.V. -Linear Expansion Valve

Heating-Indoor temp. 20°C[68°F]DB / 15°C[59°F]WB
Outdoor temp. 7°C[44.6°F]DB / 6°C[42.8°F]WB
Interconnecting Piping Length 7.5m
Level Difference of Zero

Conversion formula

kcal/h = kW x 860
Btu/h = kW x 3412
cfm = m³/min x 35.3

Accessories

Model	ARNU07GSF11	ARNU09GSF11	ARNU12GSF11
Wired	Deluxe	PQRCUS0* (- : White, B : Blue, S : Silver)	
remote control	Standard	PCRCUSZ0	
	Simple	PQRCUCA0	
	Simple (for hotel)	PQRCFCS0	
Wireless remote control		PQWRHSF0	
Dry contact	Without case	PQDSA	
	With case	PQDSB	

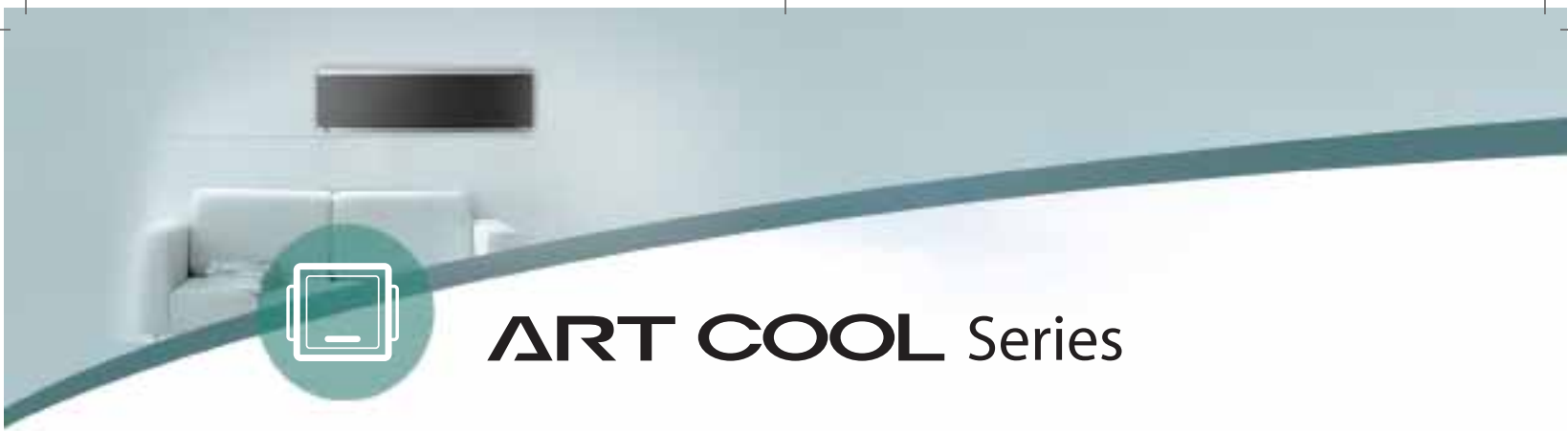

ART COOL Series

ART COOL Mirror

ARNU07GSE*1 / ARNU09GSE*1 / ARNU12GSE*1 / ARNU18GS3*1 / ARNU24GS3*1

*: R: Mirror, M: Metal, B: Blue, D: wood, W: White wood, C: Cherry, V: Silver

MIRROR



07/09/12GSER1

SILVER



07/09/12GSEV1

BLUE

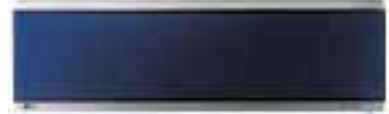

07/09/12GSEB1

MIRROR



18/24GS3R1

METAL



18/24GS3M1

BLUE



18/24GS3B1

WOOD



18/24GS3D1

WHITE WOOD



18/24GS3W1

CHERRY



18/24GS3C1

Accessories

Wired remote controller



Deluxe type



Standard type



Simple type



Simple for hotel Type

Wireless remote controller



Indoor unit



Indoor unit

Specifications



Model	Unit	ARNU07GSE*1	ARNU09GSE*1	ARNU12GSE*1	ARNU18GS3*1	ARNU24GS3*1	
Capacity	Cooling	kW	2.2	2.8	3.6	5.6	7.1
		kcal/h	1,900	2,400	3,100	4,800	6,100
		Btu/h	7,500	9,600	12,300	19,100	24,200
	Heating	kW	2.5	3.2	4.0	6.3	8.0
		kcal/h	2,200	2,800	3,400	5,400	6,900
		Btu/h	8,500	10,900	13,600	21,500	27,300
Power	Cooling	W	40	40	40	40	40
Input	Heating	W	40	40	40	40	40
Power Supply	∅ / V / Hz	1/220~240/50					
Dimensions(W*D*H)	mm	915*169*282			1170*173*315		
Weight	kg	9	9	9	13	13	
Sound pressure levels(H/M/L)	dB(A)±3	37/33/23	39/35/25	41/36/27	42/40/37	44/41/38	
Air flow rate	H/M/L	CMM	7/6/4	8/7/5	10/8/6	12.6/11.5/10	15/14/13
Neo Plasma air purifying filter		Basic	Basic	Basic	Basic	Basic	
Piping	Liquid	mm(inch)	6.35(1/4)	6.35(1/4)	6.35(1/4)	6.35(1/4)	9.52(3/8)
Connection	Gas	mm(inch)	12.7(1/2)	12.7(1/2)	12.7(1/2)	12.7(1/2)	15.88(5/8)
	Drain(OD/ID)	mm	20/16	20/16	20/16	20/16	20/16

Notes :

- Capacities are based on the following conditions
Cooling-Indoor temp. 27°C[80.6°F]DB / 19°C[66.2°F]WB
Outdoor temp. 35°C[95°F]DB / 24°C[75.2°F]WB
Interconnecting Piping Length 7.5m
Level Difference of Zero
- Capacities are net capacities
- Due to our policy of innovation some specifications may be changed without notification
- L.E.V. -Linear Expansion Valve

Heating-Indoor temp. 20°C[68°F]DB / 15°C[59°F]WB
Outdoor temp. 7°C[44.6°F]DB / 6°C[42.8°F]WB
Interconnecting Piping Length 7.5m
Level Difference of Zero

Conversion formula

kcal/h = kW x 860
Btu/h = kW x 3412
cfm = m³/min x 35.3

Accessories

Model	ARNU07GSE*1	ARNU09GSE*1	ARNU12GSE*1	ARNU18GS3*1	ARNU24GS3*1
Wired	Deluxe	PQRCUD50* (- : White, B : Blue, S : Silver)			
remote control	Standard	PCRCUSZ0			
	Simple	PQRCUCA0			
	Simple (for hotel)	PQRCFCS0			
Wireless remote control	PQWRHSF0				
Dry contact	Without case	PQDSA			
	With case	PQDSB			



ART COOL Panel

ARNU07GSP*1 / ARNU09GSP*1 / ARNU12GSP*1

* M: Metal, B: Blue, D: Wood, W: White wood



Specifications



Model	Unit	ARNU07GSP*1	ARNU09GSP*1	ARNU12GSP*1	
Capacity	Cooling	kW	2.2	2.8	3.6
		kcal/h	1,900	2,400	3,100
		Btu/h	7,500	9,600	12,300
	Heating	kW	2.5	3.2	4.0
		kcal/h	2,200	2,800	3,400
		Btu/h	8,500	10,900	13,600
Power	Cooling	W	30	30	30
Input	Heating	W	30	30	30
Power Supply	Ø / V / Hz	1/220~240/50			
Dimensions(W*D*H)	mm	570*137*568			
Weight	kg	12	12	12	
Sound pressure levels(H/M/L)	dBA±3	38/34/32	40/36/33	42/38/36	
Air flow rate	H/M/L	CMM	6/5.5/5	7/6.5/6	8.7/8.1/7.5
Neo Plasma air purifying filter		O	O	O	
Piping	Liquid	mm(inch)	6.35(1/4)	6.35(1/4)	6.35(1/4)
	Gas	mm(inch)	12.7(1/2)	12.7(1/2)	12.7(1/2)
Connection	Drain(OD/ID)	mm	16.2/12.2	16.2/12.2	16.2/12.2

Notes :

- Capacities are based on the following conditions
 Cooling-Indoor temp. 27°C[80.6°F]DB / 19°C[66.2°F]WB
 Outdoor temp. 35°C[95°F]DB / 24°C[75.2°F]WB
 Interconnecting Piping Length 7.5m
 Level Difference of Zero
- Capacities are net capacities
- Due to our policy of innovation some specifications may be changed without notification
- L.E.V. -Linear Expansion Valve

Conversion Formula
kcal/h = kW x 860
Btu/h = kW x 3412
cfm = m ³ /min x 35.3

Accessories

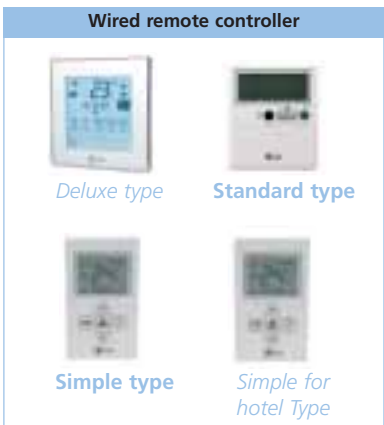

Accessories

Model	ARNU07GSP*1	ARNU09GSP*1	ARNU12GSP*1
Wired remote control	Deluxe	PQRCUDS0* (- : White, B :Blue, S :Silver)	
	Standard	PCRCUSZ0	
	Simple	PQRCUCA0	
	Simple (for hotel)	PQRCFCS0	
Wireless remote control	PQWRHSF0		
Dry Contact	Without case	PQDSA	
	With case	PQDSB	

ART COOL Wide

ARNU18GSV*1

* M: Metal , B: Blue, D: Wood, W: White Wood



Specifications

Model	Unit	ARNU18GSV*1	
Capacity	Cooling	kW	5.6
		kcal/h	4,800
		Btu/h	19,100
	Heating	kW	6.3
		kcal/h	5,400
		Btu/h	21,500
Power	Cooling	W	30
Input	Heating	W	30
Power Supply	∅ / V / Hz	1/220-240/50	
Dimensions(W*D*H)	mm	928*147*522	
Weight	kg	15	
Sound pressure levels(H/M/L)	dB(A)±3	44/39/34	
Air flow rate	H/M/L	CMM	13.5/11.4/10.4
Neo Plasma air purifying filter	Basic		
Piping	Liquid	mm(inch)	6.35(1/4)
	Gas	mm(inch)	12.7(1/2)
Connection	Drain(OD/ID)	mm	16.2/12.2

Notes :

- Capacities are based on the following conditions
 Cooling-Indoor temp. 27°C[80.6°F]DB / 19°C[66.2°F]WB
 Outdoor temp. 35°C[95°F]DB / 24°C[75.2°F]WB
 Interconnecting Piping Length 7.5m
 Level Difference of Zero
 Heating-Indoor temp. 20°C[68°F]DB / 15°C[59°F]WB
 Outdoor temp. 7°C[44.6°F]DB / 6°C[42.8°F]WB
 Interconnecting Piping Length 7.5m
 Level Difference of Zero
- Capacities are net capacities
- Due to our policy of innovation some specifications may be changed without notification
- L.E.V. -Linear Expansion Valve

Conversion formula
kcal/h = kW x 860
Btu/h = kW x 3412
cfm = m ³ /min x 35.3

Accessories



Accessories

Model	ARNU18GSV*1	
Wired remote control	Deluxe	PQRCUDS0* (- : White, B : Blue, S : Silver)
	Standard	PCRCUSZ0
	Simple	PQRCUCA0
	Simple (for hotel)	PQRCFC50
Wireless remote control	PQWRHSF0	
Dry contact	Without case	PQDSA
	With case	PQDSB

MULTI V™ Indoor unit

If you need a highly efficient air conditioning system in your building, LG **MULTI V** is the right choice for you.

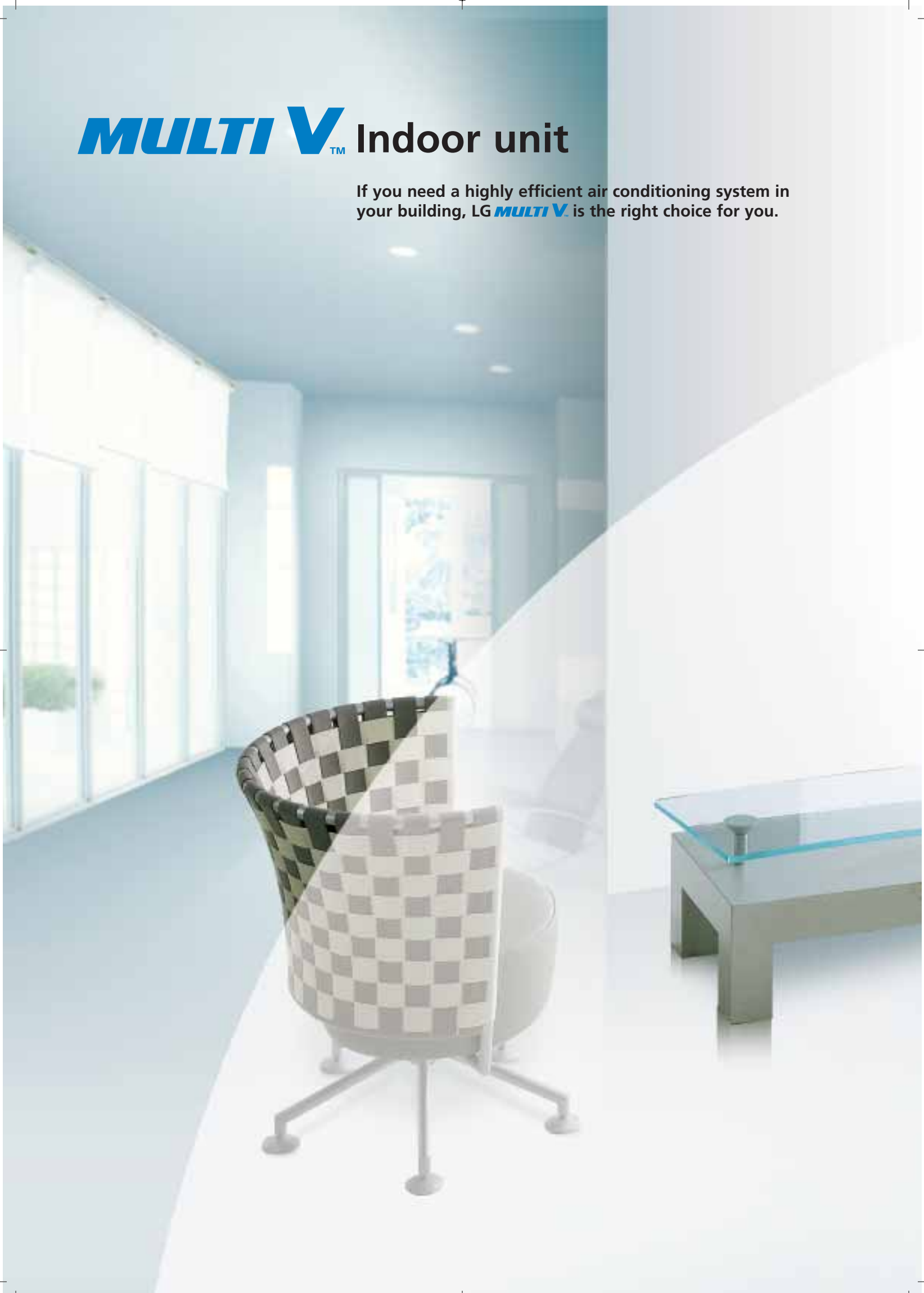

Indoor unit

Wall Mounted



Ceiling Cassette - 1way



Ceiling Cassette - 2way



Ceiling Cassette - 4way



Ceiling & Floor



Ceiling Suspended



Ceiling Concealed Duct - High Static



Ceiling Concealed Duct - Low Static



Ceiling Concealed Duct - Built-in



Floor Standing - With Case



Floor Standing - Without Case





Wall Mounted

■ Jet Cool™

Jet cool allows quick cooling. In this mode, strong, cool air is blown at high speed for 30 minutes, until the room temperature reaches 18°C.



Jet cool™ quick, strong and cool air is blown at high speed

■ Natural breeze by CHAOS swing™

The Chaos technology recreates the flow of natural air by controlling the angle speed and movement of the air vane. It also minimizes the temperature difference between high and low areas in the room, creating a more comfortably conditioned environment.

■ Auto restart function

In the event of sudden power failure, the auto start mechanism saves the current setting. It will restore the air conditioner to its previous setting when the power returns.

■ Neo Plasma Air Purifying System

LG's unique NEO Plasma Air Purifying System is equipped with 7 specialized filters in 5 separate stages to enhance its cleaning power. It reduces fine dust and mold, unpleasant odors and cigarette smoke as air passes through each filter.



Accessories

Wired remote controller



Deluxe type



Standard type



Simple type



Simple for hotel Type

Wireless remote controller



Indoor unit

Wall Mounted

ARNU07GSEL1 / ARNU09GSEL1
ARNU12GSEL1 / ARNU18GS5L1
ARNU24GS5L1



Indoor unit

 Specifications

Model		Unit	ARNU07GSEL1	ARNU09GSEL1	ARNU12GSEL1	ARNU18GS5L1	ARNU24GS5L1	
Capacity	Cooling	kW	2.2	2.8	3.6	5.6	7.1	
		kcal/h	1,900	2,400	3,100	4,800	6,100	
		Btu/h	7,500	9,600	12,300	19,100	24,200	
	Heating	kW	2.5	3.2	4.0	6.3	8.0	
		kcal/h	2,200	2,800	3,400	5,400	6,900	
		Btu/h	8,500	10,900	13,600	21,500	27,300	
Power	Cooling	W	40	40	40	40	40	
Input	Heating	W	40	40	40	40	40	
Power Supply		∅ / V / Hz	1/220-240/50					
Dimensions(W*D*H)		mm	895*165*282			1090*178*300		
Weight		kg	9	9	9	12	12	
Sound pressure levels(H/M/L)		dB \pm 3	37/33/23	39/35/25	41/36/27	44/40/36	46/41/38	
Air flow rate		H/M/L	CMM	5.6/5/4.6	7/6.5/6	9.5/9/8.5	12/10.5/9	16/13/11
Neo Plasma air purifying filter			Basic	Basic	Basic	Basic	Basic	
Piping	Liquid	mm(inch)	6.35(1/4)	6.35(1/4)	6.35(1/4)	6.35(1/4)	9.52(3/8)	
Connection	Gas	mm(inch)	12.7(1/2)	12.7(1/2)	12.7(1/2)	12.7(1/2)	15.88(5/8)	
	Drain(OD/ID)	mm	20/16	20/16	20/16	20/16	20/16	

Notes :

- Capacities are based on the following conditions
Cooling-Indoor temp. 27°C[80.6°F]DB / 19°C[66.2°F]WB Heating-Indoor temp. 20°C[68°F]DB / 15°C[59°F]WB
Outdoor temp. 35°C[95°F]DB / 24°C[75.2°F]WB Outdoor temp. 7°C[44.6°F]DB / 6°C[42.8°F]WB
Interconnecting Piping Length 7.5m Interconnecting Piping Length 7.5m
Level Difference of Zero Level Difference of Zero

- Capacities are net capacities
- Due to our policy of innovation some specifications may be changed without notification
- L.E.V. - Linear Expansion Valve

Conversion formula

kcal/h = kW x 860
Btu/h = kW x 3412
cfm = m³/min x 35.3

Accessories

Model		ARNU07GSEL1	ARNU09GSEL1	ARNU12GSEL1	ARNU18GS5L1	ARNU24GS5L1
Wired remote control	Deluxe	PQRCUDS0* (- : White, B : Blue, S : Silver)				
	Standard	PCRCUSZ0				
	Simple	PQRCUCA0				
	Simple (for hotel)	PQRCFC50				
Wireless remote control		PQWRHSF0				
Dry Contact	Without case	PQDSA				
	With case	PQDSB				



Ceiling Cassette - 1way

■ Function to control the air volume by ceiling height

Control of the air intensity has been made possible by employing a height-control algorithm for the interior fan.

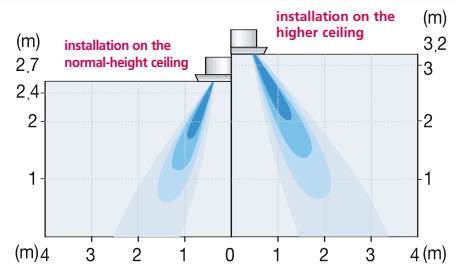

■ Airflow direction control

■ Group control (wired remote control)

When several products are linked, one specific control device can control a specific number of products.

■ Jet cool™

Jet cool allows quick cooling. In this mode, strong, cool air is blown at high speed for 30 minutes, until the room temperature reaches 18°C.

■ Drain pump

Built-in drain pump automatically drains water.

■ Auto restart function

In the event of sudden power failure, the auto start mechanism saves the current setting. It will restore the air conditioner to its previous setting when power returns.

■ Plasma filter

The PLASMA Air Purifying System developed uniquely by LG not only removes microscopic contaminants and dust, but also removes house mites, pollen, and pet fur to prevent allergic diseases like asthma.

Accessories



Ceiling Cassette - 1way

ARNU07GTJC1 / ARNU09GTJC1 / ARNU12GTJC1

 Specifications

Indoor unit

Model	Unit	ARNU07GTJC1	ARNU09GTJC1	ARNU12GTJC1	
Capacity	Cooling	kW	2.2	2.8	3.6
		kcal/h	1,900	2,400	3,100
		Btu/h	7,500	9,600	12,300
	Heating	kW	2.5	3.2	4.0
		kcal/h	2,200	2,800	3,400
		Btu/h	8,500	10,900	13,600
Power Input	Cooling	W	45	45	45
	Heating	W	40	40	40
Power Supply	φ/V / Hz	1/220~240/50			
Dimensions	Body	mm	860*410*138		
	Front Panel	mm	1070*480*20		
Weight	Body	kg	11.5	11.5	11.5
	Front Panel	kg	1.5	1.5	1.5
Panel Color		White			
Sound pressure levels(H/M/L)	dBA ± 3	40/38/37	40/38/37	41/39/37	
Air flow rate	H/M/L	CMM	7.5/6.5/6	7.5/6.5/6	8/7/6
Neo Plasma air purifying filter		Basic	Basic	Basic	
Drain Pump		O	O	O	
Piping	Liquid	mm(inch)	6.35(1/4)	6.35(1/4)	6.35(1/4)
Connection	Gas	mm(inch)	12.7(1/2)	12.7(1/2)	12.7(1/2)
	Drain(OD/ID)	mm	32/25	32/25	32/25

Notes :

- Capacities are based on the following conditions
 Cooling-Indoor temp. 27°C[80.6°F]DB / 19°C[66.2°F]WB Heating-Indoor temp. 20°C[68°F]DB / 15°C[59°F]WB
 Outdoor temp. 35°C[95°F]DB / 24°C[75.2°F]WB Outdoor temp. 7°C[44.6°F]DB / 6°C[42.8°F]WB
 Interconnecting Piping Length 7.5m Interconnecting Piping Length 7.5m
 Level Difference of Zero Level Difference of Zero
- Capacities are net capacities
- Due to our policy of innovation some specifications may be changed without notification
- L.E.V. -Linear Expansion Valve

Conversion formula

kcal/h = kW x 860
 Btu/h = kW x 3412
 cfm = m³/min x 35.3

Accessories

Model	ARNU07GTJC1	ARNU09GTJC1	ARNU12GTJC1
Wired	Deluxe	PQRCUDS0* (- : White, B : Blue, S : Silver)	
remote control	Standard	PCRCUSZ0	
	Simple	PQRCUCA0	
	Simple (for hotel)	PQRCFCS0	
Wireless remote control		PQWRHSF0	
Dry contact	Without case	PQDSA	
	With case	PQDSB	
Front panel		PT-HJC	



Ceiling Cassette - 2way

Function to control the air volume by ceiling height

Control of the air intensity has been made possible by employing a height-control algorithm for the interior fan.

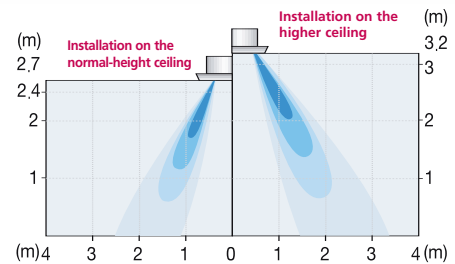

Airflow direction control

Group control (wired remote control)

When several products are linked, one specific control device can control a specific number of products.

Jet cool™

Jet cool allows quick cooling. In this mode, strong, cool air is blown at high speed for 30 minutes, until the room temperature reaches 18°C.

Drain pump

Built-in drain pump automatically drains water.

Auto restart function

In the event of sudden power failure, the auto start mechanism saves the current setting. It will restore the air conditioner to its previous setting when power returns.

Plasma filter

The PLASMA Air Purifying System developed uniquely by LG not only removes microscopic contaminants and dust, but also removes house mites, pollen, and pet fur to prevent allergic diseases like asthma.

Accessories



Ceiling Cassette - 2way

ARNU18GTLC1 / ARNU24GTLC1

 Specifications

Indoor unit

Model		Unit	ARNU18GTLC1	ARNU24GTLC1
Capacity	Cooling	kW	5.6	7.1
		kcal/h	4,800	6,100
		Btu/h	19,100	24,200
	Heating	kW	6.3	8.0
		kcal/h	5,400	6,900
		Btu/h	21,500	27,300
Power Input	Cooling	W	70	70
	Heating	W	66	66
Power Supply		∅/V / Hz	1/220~240/50	
Dimensions	Body	mm	830*550*225	
	Front Panel	mm	1050*640*28.5	
Weight	Body	kg	28	28
	Front Panel	kg	4	4
Panel Color			White	
Sound pressure levels(H/M/L)		dBA ±3	40/35/30	42/37/32
Air flow rate		H/M/L CMM	13/12/10	17/15/13
Neo Plasma air purifying filter			Basic	Basic
Drain Pump			O	O
Piping	Liquid	mm(inch)	6.35(1/4)	9.52(3/8)
Connection	Gas	mm(inch)	12.7(1/2)	15.88(5/8)
	Drain(OD/ID)	mm	32/25	32/25

Notes :

- Capacities are based on the following conditions
 Cooling-Indoor temp. 27°C[80.6°F]DB / 19°C[66.2°F]WB
 Outdoor temp. 35°C[95°F]DB / 24°C[75.2°F]WB
 Interconnecting Piping Length 7.5m
 Level Difference of Zero
 Heating-Indoor temp. 20°C[68°F]DB / 15°C[59°F]WB
 Outdoor temp. 7°C[44.6°F]DB / 6°C[42.8°F]WB
 Interconnecting Piping Length 7.5m
 Level Difference of Zero

- Capacities are net capacities
- Due to our policy of innovation some specifications may be changed without notification
- L.E.V. - Linear Expansion Valve

Conversion formula

kcal/h = kW x 860
 Btu/h = kW x 3412
 cfm = m³/min x 35.3

Accessories

Model		ARNU18GTLC1	ARNU24GTLC1
Wired remote control	Deluxe	PQRCUDS0* (- : White, B : Blue, S : Silver)	
	Standard	PCRCUSZ0	
	Simple	PQRCUCA0	
	Simple (for hotel)	PQRCFCS0	
Wireless remote control		PQWRHSF0	
Dry contact	Without case	PQDSA	
	With case	PQDSB	
Front panel		PT-HLC	



Ceiling Cassette - 4Way

■ Super slim

The indoor unit with one of the smallest and compact designs on the market based on a three-dimensional CAD and CAE computer system has successfully reduced the space it occupies and enabled installation in various spaces. (TH window frames)

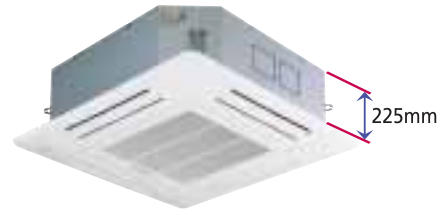

■ Function to control the air volume by ceiling height

Control of the air intensity has been made possible by employing a height-control algorithm for the interior fan.

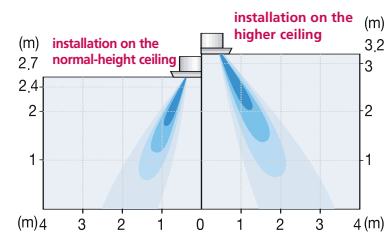

■ Airflow direction control

■ Jet cool™

Jet cool allows quick cooling. In this mode, strong, cool air is blown at high speed for 30 minutes, until the room temperature reaches 18°C.

■ Drain pump

Built-in drain pump automatically drains water.

■ Auto restart function

In the event of sudden power failure, the auto start mechanism saves the current setting. It will restore the air conditioner to its previous setting when power returns.

■ Plasma filter

The PLASMA Air Purifying System developed uniquely by LG not only removes microscopic contaminants and dust, but also removes house mites, pollen, and pet fur to prevent allergic diseases like asthma.

Accessories

Wired remote controller



Deluxe type



Standard type



Simple type



Simple for hotel Type

Wireless remote controller



Indoor unit

Ceiling Cassette - 4way

ARNU07GTEC1 / ARNU09GTEC1 / ARNU12GTEC1
 ARNU18GTEC1 / ARNU24GTHC1 / ARNU28GTHC1
 ARNU36GTDC1 / ARNU42GTDC1 / ARNU48GTDC1



Indoor unit

 Specifications

Model	Unit		ARNU07GTEC1	ARNU09GTEC1	ARNU12GTEC1	ARNU18GTEC1	ARNU24GTHC1	ARNU28GTHC1	ARNU36GTDC1	ARNU42GTDC1	ARNU48GTDC1
Capacity	Cooling	kW	2.2	2.8	3.6	5.6	7.1	8.2	10,6	12.3	14.1
		kcal/h	1,900	2,400	3,100	4,800	6,100	7,100	9,100	10,600	12,100
		Btu/h	7,500	9,600	12,300	19,100	24,200	28,000	36,200	42,000	48,100
	Heating	kW	2.5	3.2	4.0	6.3	8.0	9.2	11.9	13.8	15.9
		kcal/h	2,200	2,800	3,400	5,400	6,900	8,000	10,200	11,000	13,200
		Btu/h	8,500	10,900	13,600	21,500	27,300	31,500	40,600	43,800	51,200
Power Input	Cooling	W	40	40	40	40	33	33	144	144	144
	Heating	W	40	40	40	40	33	33	144	144	144
Power Supply	Ø/V/Hz		1/220~240/50								
Dimensions	Body	mm	570*570*269				840*840*225		840*840*288		
	(W*D*H)	Front Panel	670*670*30				950*950*30		950*950*30		
Weight	Body	kg	19	19	19	19	24	24	32	32	32
	Front Panel	kg	2.5	2.5	2.5	2.5	4.5	4.5	4.5	4.5	4.5
Panel Color			Morning Fog								
Sound pressure levels(H/M/L)	dBA ±3		40/38/37	40/38/37	41/35/32	43/37/35	38/35/31	39/38/32	43/40/39	47/44/42	48/47/45
Air flow rate	H/M/L	CMM	9/8/7	9/8/7	11/10/9	13/12/10	17/15/13	19/16/14	25/21/19	30/27/24	31/29/27
Neo Plasma air purifying filter			Basic	Basic	Basic	Basic	Basic	Basic	Basic	Basic	Basic
Drain Pump			○	○	○	○	○	○	○	○	○
Piping	Liquid	mm(inch)	6.35(1/4)	6.35(1/4)	6.35(1/4)	6.35(1/4)	9.52(3/8)	9.52(3/8)	9.52(3/8)	9.52(3/8)	9.52(3/8)
Connection	Gas	mm(inch)	12.7(1/2)	12.7(1/2)	12.7(1/2)	12.7(1/2)	15.88(5/8)	15.88(5/8)	15.88(5/8)	15.88(5/8)	15.88(5/8)
	Drain(OD/ID)	mm	32/25	32/25	32/25	32/25	32/25	32/25	32/25	32/25	32/25

Notes :

- Capacities are based on the following conditions
 Cooling-Indoor temp. 27°C[80.6°F]DB / 19°C[66.2°F]WB
 Outdoor temp. 35°C[95°F]DB / 24°C[75.2°F]WB
 Interconnecting Piping Length 7.5m
 Level Difference of Zero
- Heating-Indoor temp. 20°C[68°F]DB / 15°C[59°F]WB
 Outdoor temp. 7°C[44.6°F]DB / 6°C[42.8°F]WB
 Interconnecting Piping Length 7.5m
 Level Difference of Zero

Conversion formula
kcal/h = kW x 860
Btu/h = kW x 3412
cfm = m ³ /min x 35.3

- Capacities are net capacities
- Due to our policy of innovation some specifications may be changed without notification
- L.E.V. -Linear Expansion Valve

Accessories

Model		ARNU07GTEC1	ARNU09GTEC1	ARNU12GTEC1	ARNU18GTEC1	ARNU24GTHC1	ARNU28GTHC1	ARNU36GTDC1	ARNU42GTDC1	ARNU48GTDC1	
Wired remote control	Deluxe	PQRCUS0* (- : White, B : Blue, S : Silver)									
	Standard	PCRCUSZ0									
	Simple	PQRCUCA0									
	Simple (for hotel)	PQRCFCS0									
Wireless remote control		PQWRHSF0									
Dry contact	Without case	PQDSA									
	With case	PQDSB									
Front panel		PT-HEC1					PT-HDC1				



Ceiling & Floor

■ Natural breeze by CHAOS swing™

The Chaos technology recreates the flow of natural air by controlling the angle speed and movement of the air vane. It also minimizes the temperature difference between high and low areas in the room, creating a more comfortably conditioned environment.

■ Weekly program (wired remote control)

If necessary, an operator can make an on/off reservation of the product for a period of one week.

■ Auto restart function

In the event of sudden power failure, the auto start mechanism saves the current setting. It will restore the air conditioner to its previous setting when power returns.

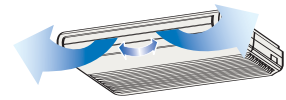

Airflow direction control
Horizontal airflow direction control, manual control

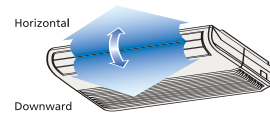

Vertical airflow direction control.
Airflow direction control
The airflow direction can be adjusted by using the remote control.

Accessories

Wired remote controller



Deluxe type



Standard type



Simple type



Simple for hotel Type

Wireless remote controller



Indoor unit

Ceiling & Floor

ARNU09GVEA1 / ARNU12GVEA1

 Specifications

Indoor unit

Model		Unit	ARNU09GVEA1	ARNU12GVEA1
Capacity	Cooling	kW	2.8	3.6
		kcal/h	2,400	3,100
		Btu/h	9,600	12,300
	Heating	kW	3.2	4.0
		kcal/h	2,800	3,400
		Btu/h	10,900	13,600
Power	Cooling	W	30	30
Input	Heating	W	30	30
Power Supply		∅/V/Hz	1/220~240/50	
Dimensions(W*D*H)		mm	900*200*490	
Weight		kg	12	12
Sound pressure levels(H/M/L)		dBA±3	36/32/28	38/36/30
Air flow rate		H/M/L CMM	7.6/6.9/6.2	9.2/7.6/6.9
Plasma air purifying filter			-	-
Piping	Liquid	mm(inch)	6.35(1/4)	6.35(1/4)
Connection	Gas	mm(inch)	12.7(1/2)	12.7(1/2)
	Drain(OD/ID)	mm	20/16	20/16

Notes :

- Capacities are based on the following conditions
 Cooling-Indoor temp. 27°C[80.6°F]DB / 19°C[66.2°F]WB
 Outdoor temp. 35°C[95°F]DB / 24°C[75.2°F]WB
 Interconnecting Piping Length 7.5m
 Level Difference of Zero
 Heating-Indoor temp. 20°C[68°F]DB / 15°C[59°F]WB
 Outdoor temp. 7°C[44.6°F]DB / 6°C[42.8°F]WB
 Interconnecting Piping Length 7.5m
 Level Difference of Zero

- Capacities are net capacities
- Due to our policy of innovation some specifications may be changed without notification
- L.E.V. -Linear Expansion Valve

Conversion formula
kcal/h = kW x 860
Btu/h = kW x 3412
cfm = m ³ /min x 35.3

Accessories

Model		ARNU09GVEA1	ARNU12GVEA1
Wired remote control	Deluxe	PQRCUS0* (- : White, B : Blue, S : Silver)	
	Standard	PCRCUSZ0	
	Simple	PQRCUCA0	
	Simple (for hotel)	PQRCFCS0	
Wireless remote control		PQWRHSF0	
Dry contact	Without case	PQDSA	
	With case	PQDSB	



Ceiling Suspended

■ Natural breeze by CHAOS swing™

The Chaos technology recreates the flow of natural air by controlling the angle speed and movement of the air vane. It also minimizes the temperature difference between high and low areas in the room, creating a more comfortably conditioned environment.

■ Weekly program (wired remote control)

If necessary, an operator can make an on/off reservation of the product for a period of one week.

■ Auto restart function

In the event of sudden power failure, the auto start mechanism saves the current setting. It will restore the air conditioner to its previous setting when power returns.

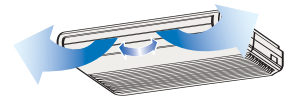

Airflow direction control
Horizontal airflow direction control, manual control

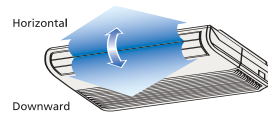

Vertical airflow direction control.
Airflow direction control
The airflow direction can be adjusted by using the remote control.

Accessories

Wired remote controller



Deluxe type



Standard type



Simple type



Simple for hotel Type

Wireless remote controller



Indoor unit

Ceiling Suspended

ARNU18GVJA1 / ARNU24GVJA1



Indoor unit

 Specifications

Model		Unit	ARNU18GVJA1	ARNU24GVJA1
Capacity	Cooling	kW	5.6	7.1
		kcal/h	4,800	6,100
		Btu/h	19,100	24,200
	Heating	kW	6.3	8.0
		kcal/h	5,400	6,900
		Btu/h	21,500	27,300
Power	Cooling	W	63	63
Input	Heating	W	63	63
Power Supply		ϕ/V/Hz	1/220-240/50	
Dimensions(W*D*H)		mm	950*220*650	
Weight		kg	15	15
Sound pressure level(H/M/L)		dB(A)±3	42/40/37	43/41/39
Air flow rate	H/M/L	CMM	16/14/12	18/16/14
Plasma air purifying filter			-	-
Piping	Liquid	mm(inch)	6.35(1/4)	9.52(3/8)
Connection	Gas	mm(inch)	12.7(1/2)	15.88(5/8)
	Drain(OD/ID)	mm	20/16	20/16

Notes :

- Capacities are based on the following conditions
 Cooling-Indoor temp. 27°C[80.6°F]DB / 19°C[66.2°F]WB
 Outdoor temp. 35°C[95°F]DB / 24°C[75.2°F]WB
 Interconnecting Piping Length 7.5m
 Level Difference of Zero
 Heating-Indoor temp. 20°C[68°F]DB / 15°C[59°F]WB
 Outdoor temp. 7°C[44.6°F]DB / 6°C[42.8°F]WB
 Interconnecting Piping Length 7.5m
 Level Difference of Zero
- Capacities are net capacities
- Due to our policy of innovation some specifications may be changed without notification
- L.E.V. -Linear Expansion Valve

Conversion formula
kcal/h = kW x 860
Btu/h = kW x 3412
cfm = m ³ /min x 35.3

Accessories

Model		ARNU18GVJA1	ARNU24GVJA1
Wired	Deluxe	PQRCUS0* (- : White, B : Blue, S : Silver)	
remote control	Standard	PCRCUSZ0	
	Simple	PQRCUCA0	
	Simple (for hotel)	PQRCFC0	
	Wireless remote control	PQWRHSF0	
Dry contact	Without case	PQDSA	
	With case	PQDSB	



Ceiling Concealed Duct - High Static

■ Linear

E.S.P (External Static Pressure) control

Air volume and noise level is always kept stable as initially designed regardless of external static pressure variation.

■ Drain pump

Built-in drain pump automatically drains water.

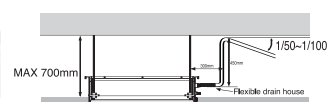

■ Weekly program (wired remote control)

If necessary, an operator can make an on/off reservation of the product for a period of one week.

■ Quiet operation & easy service

Innovative design for blower and housing system low noise! light weight!
easy serviceability plastic blower and housing

- Designed for low noise
- Designed to reduce weight.
- Designed for easy service with separated housing.

This product will guarantee you lower sound level and less service expenses.

Accessories

Wired remote controller				Wireless remote controller
				
Deluxe type	Standard type	Simple type	Simple for hotel Type	

If you want to use wireless remote control, have to need wired remote control (High static, Low static, Built-in, Floor Standing)

Indoor unit

Ceiling Concealed Duct - High Static

ARNU18GBHA1 / ARNU24GBHA1 / ARNU28GBGA1
ARNU36GBGA1 / ARNU42GBGA1 / ARNU48GBRA1

Indoor unit

 Specifications

Model	Unit	ARNU18GBHA1	ARNU24GBHA1	ARNU28GBGA1	ARNU36GBGA1	ARNU42GBGA1	ARNU48GBRA1	
Capacity	Cooling	kW	5.6	7.1	8.2	10.6	12.3	14.1
		kcal/h	4,800	6,100	7,100	9,100	10,600	12,100
		Btu/h	19,100	24,200	28,000	36,200	42,000	48,100
	Heating	kW	6.3	8.0	9.2	11.9	13.8	15.9
		kcal/h	5,400	6,900	8,000	10,200	11,000	13,200
		Btu/h	21,500	27,300	31,500	40,600	43,800	51,200
Power	Cooling	W	150	150	450	450	450	450
Input	Heating	W	150	150	430	430	430	430
Power Supply	ø/V/Hz	1/220~240/50						
Dimensions(W*D*H)	mm	882*450*260			1182*450*298		1230*590*380	
Weight	kg	34	35	38	38	38	53	
Sound pressure levels(H/M/L)	dBA±3	42.5/41/37	45/43/41	44/42/40	46/44/42	48/46/45	45/43/41	
E.S.P range	mmAq	4~12		6~12		6~13	7~18	
Air flow rate	H/M/L	CMM	15.5/13.5/12.4	18.3/16.9/15.5	25.9/24.1/21.8	32.3/29.0/25.3	34.5/32.3/30.7	44.8/40.6/33.3
Plasma air purifying filter		-	-	-	-	-	-	
Piping	Liquid	mm(inch)	6.35(1/4)	9.52(3/8)	9.52(3/8)	9.52(3/8)	9.52(3/8)	9.52(3/8)
Connection	Gas	mm(inch)	12.7(1/2)	15.88(5/8)	15.88(5/8)	15.88(5/8)	15.88(5/8)	15.88(5/8)
	Drain(OD/ID)	mm	32/25	32/25	32/25	32/25	32/25	32/25

Notes :

- Capacities are based on the following conditions
Cooling-Indoor temp. 27°C[80.6°F]DB / 19°C[66.2°F]WB
Outdoor temp. 35°C[95°F]DB / 24°C[75.2°F]WB
Interconnecting Piping Length 7.5m
Level Difference of Zero
Heating-Indoor temp. 20°C[68°F]DB / 15°C[59°F]WB
Outdoor temp. 7°C[44.6°F]DB / 6°C[42.8°F]WB
Interconnecting Piping Length 7.5m
Level Difference of Zero

- Capacities are net capacities
- Due to our policy of innovation some specifications may be changed without notification
- L.E.V. -Linear Expansion Valve

Conversion formula
kcal/h = kW x 860
Btu/h = kW x 3412
cfm = m ³ /min x 35.3

Accessories

Model	ARNU18GBHA1	ARNU24GBHA1	ARNU28GBGA1	ARNU36GBGA1	ARNU42GBGA1	ARNU48GBRA1
Wired remote control	Deluxe	PQRCU50* (- : White, B : Blue, S : Silver)				
	Standard	PDRCUSZ0				
	Simple	PQRUCA0				
	Simple (for hotel)	PQRCFCS0				
Wireless remote control	PQWRHSF0					
Dry contact	Without case	PQDSA				
	With case	PQDSB				



Ceiling Concealed Duct - Low Static

■ Linear

E.S.P (External Static Pressure) control

Air volume and noise level is always kept stable as initially designed regardless of external static pressure variation.

■ Group control (wired remote control)

When several products are linked, one specific control device can control a specific number of products.

■ Weekly program (wired remote control)

If necessary, an operator can make an On/Off reservation of the product for a period of one week.

■ Drain pump

Built-in drain pump automatically drains water.

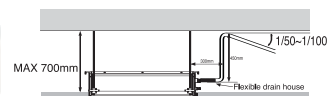

■ Super slim (190mm)

The indoor unit with one of the smallest and compact designs on the market based on a three-dimensional CAD and CAE computer system has successfully reduced the space it occupies and enabled installation in various spaces.

■ Quiet operation & easy service

Innovative design for blower and housing system low noise! light weight!
easy serviceability plastic blower and housing

- Designed for low noise
- Designed to reduce weight.
- Designed for easy service with separated housing.

This product will guarantee you lower sound level and less service expenses.

Accessories

Wired remote controller				Wireless remote controller
Deluxe type	Standard type	Simple type	Simple for hotel Type	

If you want to use wireless remote control, have to need wired remote control (High static, Low static, Built-in, Floor Standing)

Ceiling Concealed Duct - Low Static

ARNU07GB1G1 / ARNU09GB1G1 / ARNU12GB1G1
ARNU18GB2G1 / ARNU24GB2G1



Indoor unit

Specifications



Model	Unit	ARNU07GB1G1	ARNU09GB1G1	ARNU12GB1G1	ARNU18GB2G1	ARNU24GB2G1	
Capacity	Cooling	kW	2.2	2.8	3.6	5.6	7.1
		kcal/h	1,900	2,400	3,100	4,800	6,100
		Btu/h	7,500	9,600	12,300	19,100	24,200
	Heating	kW	2.5	3.2	4.0	6.3	8.0
		kcal/h	2,200	2,800	3,400	5,400	6,900
		Btu/h	8,500	10,900	13,600	21,500	27,300
Power	Cooling	W	30	30	30	80	80
Input	Heating	W	30	30	30	80	80
Power Supply	Ø/V/Hz	1/220-240/50					
Dimensions(W*D*H)	mm	820*575*190			1100*575*190		
Weight	kg	17	17	17	21	21	
Sound pressure levels(H/M/L)	dB(A)±3	35/33/31	36/34/32	37/35/33	40/37/34	43/40/37	
E.S.P range	mmAq	0-4					
Air flow rate	H/M/L	CMM	8.7/7.5/6.5	9.5/8.5/7.5	10.5/9.5/8.5	16/14/12	19/17/15
Plasma air purifying filter		-					
Piping	Liquid	mm(inch)	6.35(1/4)	6.35(1/4)	6.35(1/4)	6.35(1/4)	9.52(3/8)
Connection	Gas	mm(inch)	12.7(1/2)	12.7(1/2)	12.7(1/2)	12.7(1/2)	15.88(5/8)
	Drain(OD/ID)	mm	32/25	32/25	32/25	32/25	32/25

Notes :

- Capacities are based on the following conditions
Cooling-Indoor temp. 27°C[80.6°F]DB / 19°C[66.2°F]WB
Outdoor temp. 35°C[95°F]DB / 24°C[75.2°F]WB
Interconnecting Piping Length 7.5m
Level Difference of Zero
- Capacities are net capacities
- Due to our policy of innovation some specifications may be changed without notification
- L.E.V.-Linear Expansion Valve

Heating-Indoor temp. 20°C[68°F]DB / 15°C[59°F]WB
Outdoor temp. 7°C[44.6°F]DB / 6°C[42.8°F]WB
Interconnecting Piping Length 7.5m
Level Difference of Zero

Conversion formula

kcal/h = kW x 860
Btu/h = kW x 3412
cfm = m³/min x 35.3

Accessories

Model	ARNU07GB1G1	ARNU09GB1G1	ARNU12GB1G1	ARNU18GB2G1	ARNU24GB2G1
Wired	Deluxe	PQRCUS0* (- : White, B : Blue, S : Silver)			
remote control	Standard	PDRCUSZ0			
	Simple	PQRCUCA0			
	Simple (for hotel)	PQRCFCS0			
Wireless remote control	PQWRHSF0				
Dry contact	Without case	PQDSA			
	With case	PQDSB			



Ceiling Concealed Duct - Built-in

■ Linear

E.S.P (External Static Pressure) control

Air volume and noise level is always kept stable as initially designed regardless of external static pressure variation.

■ Group control (wired remote control)

When several products are linked, one specific control device can control a specific number of products.

■ Weekly program (wired remote control)

If necessary, an operator can make an On/Off reservation of the product for a period of one week.

■ Quiet operation & easy service

Innovative design for blower and housing system low noise! light weight!
easy serviceability plastic blower and housing

- Designed for low noise
- Designed to reduce weight.
- Designed for easy service with separated housing.

This product will guarantee you lower sound level and less service expenses.

■ Drain pump

Built-in drain pump automatically drains water.

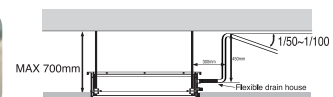

■ Installation scene

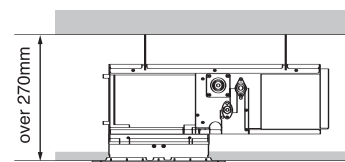
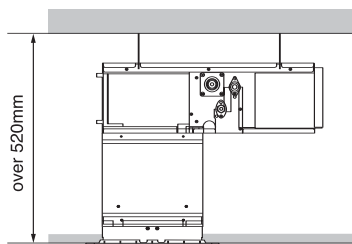
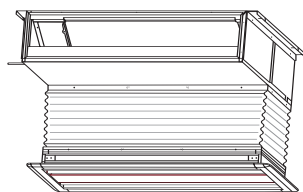

Accessories

Wired remote controller



Deluxe type



Standard type



Simple type



Simple for hotel Type

Wireless remote controller



If you want to use wireless remote control, have to need wired remote control (High static, Low static, Built-in, Floor Standing)

Ceiling Concealed Duct - Built-in

ARNU07GB3G1 / ARNU09GB3G1 / ARNU12GB3G1
ARNU18GB4G1 / ARNU24GB4G1



Indoor unit

Specifications



Model	Unit	ARNU07GB3G1	ARNU09GB3G1	ARNU12GB3G1	ARNU18GB4G1	ARNU24GB4G1	
Capacity	Cooling	kW	2.2	2.8	3.6	5.6	7.1
		kcal/h	1,900	2,400	3,100	4,800	6,100
		Btu/h	7,500	9,600	12,300	19,100	24,200
	Heating	kW	2.5	3.2	4.0	6.3	8.0
		kcal/h	2,200	2,800	3,400	5,400	6,900
		Btu/h	8,500	10,900	13,600	21,500	27,300
Power	Cooling	W	30	30	30	80	80
Input	Heating	W	30	30	30	80	80
Power Supply	Ø/V/Hz	1/220-240/50					
Dimensions (W*D*H)	mm	820*575*190			1100*575*190		
Suction grille (W*D*H)	mm	910*359*56			1188*359*56		
Suction canvas (W*D*H)	mm	821*274*(45~250)			1100*274*(45~250)		
Weight	kg	17	17	17	21	21	
Sound pressure levels(H/M/L)	dBA±3	37/34/33	39/35/34	40/37/34	43/40/37	46/43/37	
E.S.P range	mmAq	0~4					
Air flow rate	H/M/L	CMM	8/6.5/5.5	9/7.5/6	10/8.5/6.5	14/12/10	17/15/10
Plasma air purifying filter		-	-	-	-	-	
Piping	Liquid	mm(inch)	6.35(1/4)	6.35(1/4)	6.35(1/4)	6.35(1/4)	9.52(3/8)
Connection	Gas	mm(inch)	12.7(1/2)	12.7(1/2)	12.7(1/2)	12.7(1/2)	15.88(5/8)
	Drain(OD/ID)	mm	32/25	32/25	32/25	32/25	32/25

Notes :

- Capacities are based on the following conditions
Cooling-Indoor temp. 27°C[80.6°F]DB / 19°C[66.2°F]WB
Outdoor temp. 35°C[95°F]DB / 24°C[75.2°F]WB
Interconnecting Piping Length 7.5m
Level Difference of Zero
- Capacities are net capacities
- Due to our policy of innovation some specifications may be changed without notification
- L.E.V.-Linear Expansion Valve

Conversion formula

kcal/h = kW x 860
Btu/h = kW x 3412
cfm = m³/min x 35.3

Accessories

Model	ARNU07GB3G1	ARNU09GB3G1	ARNU12GB3G1	ARNU18GB4G1	ARNU24GB4G1
Wired remote control	Deluxe	PQRCUDS0* (- : White, B : Blue, S : Silver)			
remote control	Standard	PDRCUSZ0			
	Simple	PQRCUCA0			
	Simple (for hotel)	PQRCFCS0			
Wireless remote control	PQWRHSF0				
Dry contact	Without case	PQDSA			
	With case	PQDSB			
Suction grille	PBSGB30			PBSGB40	
Suction canvas	PBSC30			PBSC40	



Floor Standing - With Case

■ Weekly program (wired remote control)

If necessary, an operator can make an on/off reservation of the product for a period of one week.

■ Auto restart function

In the event of sudden power failure, the auto start mechanism saves the current setting. It will restore the air conditioner to its previous setting when power returns.

■ Child lock function

This function prevents the tampering of the control buttons on the unit allowing control via the remote controller only.

Accessories

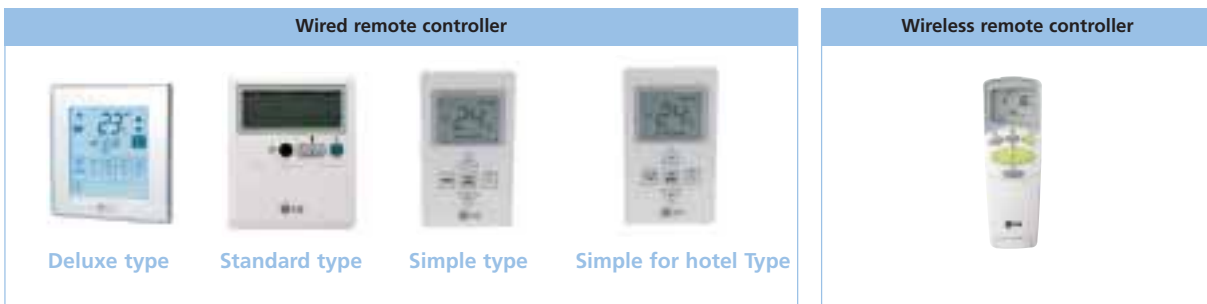

If you want to use wireless remote control, have to need wired remote control (High static, Low static, Built-in, Floor Standing)

Floor Standing- With Case

ARNU07GCEA1 / ARNU09GCEA1
ARNU12GCEA1 / ARNU18GCFA1
ARNU24GCFA1



Indoor unit

Specifications



Model		Unit	ARNU07GCEA1	ARNU09GCEA1	ARNU12GCEA1	ARNU18GCFA1	ARNU24GCFA1	
Capacity	Cooling	kW	2.2	2.8	3.6	5.6	7.1	
		kcal/h	1,900	2,400	3,100	4,800	6,100	
		Btu/h	7,500	9,600	12,300	19,100	24,200	
	Heating	kW	2.5	3.2	4.0	6.3	8.0	
		kcal/h	2,200	2,800	3,400	5,400	6,900	
		Btu/h	8,500	10,900	13,600	21,500	27,300	
Power	Cooling	W	30	30	30	80	80	
Input	Heating	W	30	30	30	80	80	
Power Supply		∅/V/Hz	1/220-240/50					
Dimensions(W*D*H)		mm	1067*203*635			1345*203*635		
Weight		kg	27	27	27	34	34	
Sound pressure levels(H/M/L)		dB \pm 3	35/33/31	36/34/32	37/35/33	40/37/34	43/40/37	
Air flow rate		H/M/L	CMM	8.5/7.5/6.5	9.5/8.5/7.5	10.5/9.5/8.5	16/14/12	18/16/14
Plasma air purifying filter			-	-	-	-	-	
Piping	Liquid	mm(inch)	6.35(1/4)	6.35(1/4)	6.35(1/4)	6.35(1/4)	9.52(3/8)	
Connection	Gas	mm(inch)	12.7(1/2)	12.7(1/2)	12.7(1/2)	12.7(1/2)	15.88(5/8)	
	Drain(OD/ID)	mm	16/12	16/12	16/12	16/12	16/12	

Notes :

- Capacities are based on the following conditions
Cooling-Indoor temp. 27 °C[80.6 °F]DB / 19 °C[66.2 °F]WB
Outdoor temp. 35 °C[95 °F]DB / 24 °C[75.2 °F]WB
Interconnecting Piping Length 7.5m
Level Difference of Zero
- Heating-Indoor temp. 20 °C[68 °F]DB / 15 °C[59 °F]WB
Outdoor temp. 7 °C[44.6 °F]DB / 6 °C[42.8 °F]WB
Interconnecting Piping Length 7.5m
Level Difference of Zero
- Capacities are net capacities
- Due to our policy of innovation some specifications may be changed without notification
- L.E.V. - Linear Expansion Valve

Conversion formula
Kcal/h = kW x 860
Btu/h = kW x 3412
cfm = m ³ /min x 35.3

Accessories

Model		ARNU07GCEA1	ARNU09GCEA1	ARNU12GCEA1	ARNU18GCFA1	ARNU24GCFA1
remote control	Deluxe	PQRCUDS0 * (- : White, B : Blue, S : Silver)				
	Standard	PDRCUSZ0				
	Simple	PQRCUCA0				
	Simple (for hotel)	PQRCFCS0				
Wireless remote control		PQWRHSF0				
Dry contact	Without case	PQDSA				
	With case	PQDSB				



Floor Standing - Without Case

■ Weekly program (wired remote control)

If necessary, an operator can make an on/off reservation of the product for a period of one week.

■ Auto restart function

In the event of sudden power failure, the auto start mechanism saves the current setting. It will restore the air conditioner to its previous setting when power returns.

■ Child lock function

This function prevents the tampering of the control buttons on the unit allowing control via the remote controller only.

Accessories

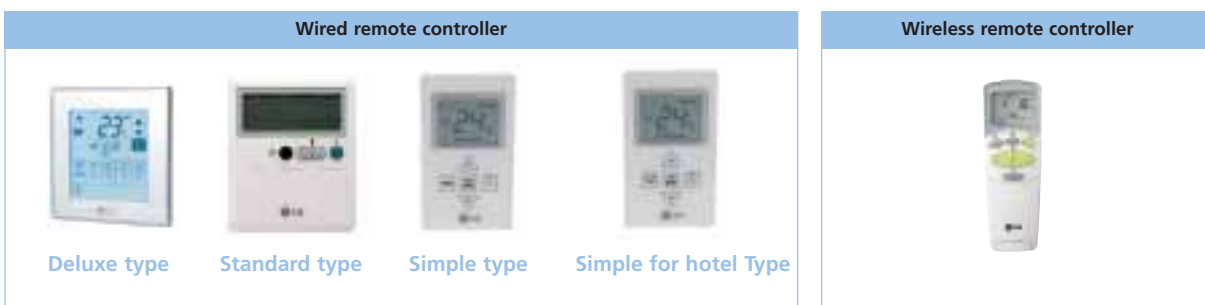

If you want to use wireless remote control, have to need wired remote control (High static, Low static, Built-in, Floor Standing)

Floor Standing- Without Case

ARNU07GCEU1 / ARNU09GCEU1
ARNU12GCEU1 / ARNU18GCFU1
ARNU24GCFU1



Indoor unit

Specifications



Model	Unit	ARNU07GCEU1	ARNU09GCEU1	ARNU12GCEU1	ARNU18GCFU1	ARNU24GCFU1	
Capacity	Cooling	kW	2.2	2.8	3.6	5.6	7.1
		kcal/h	1,900	2,400	3,100	4,800	6,100
		Btu/h	7,500	9,600	12,300	19,100	24,200
	Heating	kW	2.5	3.2	4.0	6.3	8.0
		kcal/h	2,200	2,800	3,400	5,400	6,900
		Btu/h	8,500	10,900	13,600	21,500	27,300
Power	Cooling	W	30	30	30	80	80
Input	Heating	W	30	30	30	80	80
Power Supply	∅/V/Hz	1/220~240/50					
Dimensions(W*D*H)	mm	978*190*639			1256*190*639		
Weight	kg	19	19	19	27	27	
Sound pressure levels(H/M/L)	dB _A ±3	35/33/31	36/34/32	37/35/33	40/37/34	43/40/37	
Air flow rate	H/M/L	CMM	8.5/7.5/6.5	9.5/8.5/7.5	10.5/9.5/8.5	16/14/12	18/16/14
Plasma air purifying filter		-	-	-	-	-	
Piping	Liquid	mm(inch)	6.35(1/4)	6.35(1/4)	6.35(1/4)	6.35(1/4)	9.52(3/8)
Connection	Gas	mm(inch)	12.7(1/2)	12.7(1/2)	12.7(1/2)	12.7(1/2)	15.88(5/8)
	Drain(OD/ID)	mm	16/12	6/12	6/12	6/12	6/12

Notes :

- Capacities are based on the following conditions
Cooling-Indoor temp. 27°C[80.6°F]DB / 19°C[66.2°F]WB
Outdoor temp. 35°C[95°F]DB / 24°C[75.2°F]WB
Interconnecting Piping Length 7.5m
Level Difference of Zero
- Capacities are net capacities
- Due to our policy of innovation some specifications may be changed without notification
- L.E.V. -Linear Expansion Valve

Heating-Indoor temp. 20°C[68°F]DB / 15°C[59°F]WB
Outdoor temp. 7°C[44.6°F]DB / 6°C[42.8°F]WB
Interconnecting Piping Length 7.5m
Level Difference of Zero

Conversion formula
kcal/h = kW x 860
Btu/h = kW x 3412
cfm = m ³ /min x 35.3

Accessories

Model	ARNU07GCEU1	ARNU09GCEU1	ARNU12GCEU1	ARNU18GCFU1	ARNU24GCFU1
Wired	Deluxe	PQRCUDS0* (- : White, B : Blue, S : Silver)			
remote control	Standard	PDRCUSZ0			
	Simple	PQRCUCA0			
	Simple (for hotel)	PQRCFCS0			
Wireless remote control	PQWRHSF0				
Dry contact	Without case	PQDSA			
	With case	PQDSB			

MULTI V™ Network solution & Accessories



1. Individual controller

- Standard
- Deluxe
- Simple / Simple (for hotel)
- Wireless remote controller

2. Simple central controller

3. Deluxe central controller

4. PC based central controller



5. Power Distribution Indicator

6. BNU-LW

7. BNU-BN



8. Accessories

- CNU / PI485 / Dry contact module
- Remote temperature sensor / Air guide
- Heat recovery unit / Branch

Network Solution

1. Individual controller

Description		Reference						
ITEM		ARTCOOL	Wall Mounted	Cassette	Ceiling & Floor	Ceiling Suspended	Duct	Floor standing
Wired remote control	Standard	PCRCUSZ0					PDRCUSZ0	
	Deluxe	PQRCUDS0 / PQRCUDS0B / PQRCUDS0S (White / Blue / Silver)						
	Simple	PQRCUCA0						
	Simple(for hotel)	PQRCFC50						
Wireless remote control		PQWRHSF0						

2. Simple central controller

Description	Reference	Comment
Simple Central Control	PQCSB10150	16 Indoors
Function Controller	PQCSC10150	Max. 8 SCC

3. Deluxe central controller

Description	Reference	Comment
Deluxe Central Control	PQCSW502A2	Control/Monitoring, Schedule, Max 256 Indoors

4. PC Based central controller

Description	Reference	Comment
Software	PQCSS513A0	Control/Monitoring, Schedule, Ventilator control, Peak Control, PDI monitoring

5. Power Distribution Indicator

Description	Reference	Comment
Power Distribution Indicator	PQNUD1500	Max 48 Indoors, 1 PDI / 1 Outdoor
Watt Hour Meter	Local purchasing	Pulse output/40-500msec, 1, 2, 4, 6, 8, 10W/Pluse

6. BNU-LW

Description	Reference	Comment
LONWORKS network compatible gateway	PQNFB16A1	Max 64 indoors, Compatible ventilator

7. BNU-BN

Description	Reference	Comment
BACnet network compatible gateway	PQNFB17B0	Max 256 indoors, Compatible ventilator

8. Accessories

Description	Reference	Comment
CNU	PQNGF14B0	1 CNU / 1 DCC, 16 CNU / 1PCC
Interface Unit(PI485)	PMNFP14A0	For 1 Outdoor with max 16 Indoors, 8 PI485 / 1 CNU
	PMNFP14A1	For 1 Outdoor with max 48 Indoors, 8 PI485 / 1 CNU
Dry_Contact without case	PQDSA	Using contact, On_Off control, operating / Error monitoring
Dry_Contact with case	PQDSB	Using contact, On_Off control, operating / Error monitoring
Remote temperature sensor	PQRSTA0	Detecting the exact room temperature
HR unit	PRHR020	2 Pipe-Connection
	PRHR030	3 Pipe-Connection
	PRHR040	4 Pipe-Connection

* DCC : Deluxe central controller

* SCC : Simple central controller

* PCC : PC central controller



Individual controller

■ Wired remote control

PCRCUSZ0 (Standard)



Features

- On_Off / fan speed / mode / temp
- Room temp
- Fan / plasma / swirl swing / heater
- Vane control
- Weekly reservation
- Simple reservation
- Timer function
- Auto swing / child lock
- Electric failure compensation (Max. 2 hours)
- On_Off LED

Characteristics

- Full function

PDRCUSZ0 (Standard)



Features

- On_Off / fan speed / mode / temp
- Room temp
- Fan / plasma / humidification / heater
- Fan auto
- Vane control
- E.S.P function
- Weekly reservation
- Simple reservation
- Timer function
- Auto swing / child lock
- Wireless remote receiver
- Electric failure compensation (Max. 2 hours)
- On_Off LED

Characteristics

- Full function / Wireless remote receive function

- PQRCUDS0 (Deluxe, White)
- PQRCUDS0B (Deluxe, Blue)
- PQRCUDS0S (Deluxe, Silver)



Features

- On_Off / fan speed / mode / temp
- Room temp
- Fan / plasma / swirl swing / heater
- Vane control
- E.S.P function
- Reservation (simple weekly)
- Simple reservation
- Timer function
- Auto swing / child lock

Characteristics

- Touch screen / LCD back_light

PQRCUCA0 (Simple)**Features**

- On_Off
- Fan speed
- Mode
- Set temperature
- Room temp
- Plasma
- Auto swing / Child lock

Characteristics

- Simple function

Network
solution**PQRCFCS0 (Simple for hotel)****Features**

- On_Off
- Fan speed
- Set temperature
- Room temp
- Plasma
- Auto swing / Child lock

Characteristics

- Simple function / Mode change impossible for hotel use

■ Wireless remote control**PQWRHSF0****Functions**

Functions	Standard
Air circulation / fan operation	•
Room temperature checking	•
Sleep mode operation	•
Temperature settings	•
Operation mode selection	•
Air-swing & jet cool (cassette only)	•
On_Off timer settings	•



Simple central controller

Simple central controller

- A central controller for managing small sites
- Control maximum 16 indoor units



PQCSB10150

Features

- Individual operation (one button one A/C)
 - On operation (Max. 16 indoors)
 - Off operation (Max. 16 indoors)
 - Individual lock function (1 unit)
- Group operation
 - Group On_Off
 - Group lock function (16 units)
- Sequential starting to protect over current
- Diagnostic function (LED blinking)



Additional accessory

- Interface unit (PI485) : PMNFP14A0 (for 1 outdoor with max 16 indoors, 1 PI485/1 outdoor)
- PMNFP14A1 (for 1 outdoor with max 48 indoors, 1 PI485/1 outdoor)

Function central controller (PQCSC101S0)

- Control & monitor the operation status of indoor units in company with a simple central controller (PQCSB10150)



PQCSB10150 / PQCSC101S0

Features

- Mode / fan speed / temperature control
- Indoor error display
- Total cycling status indication via LCD
- Max. 8 groups with 128 units in group control

1 Function controller
combined max 8 simple central controller

Wiring

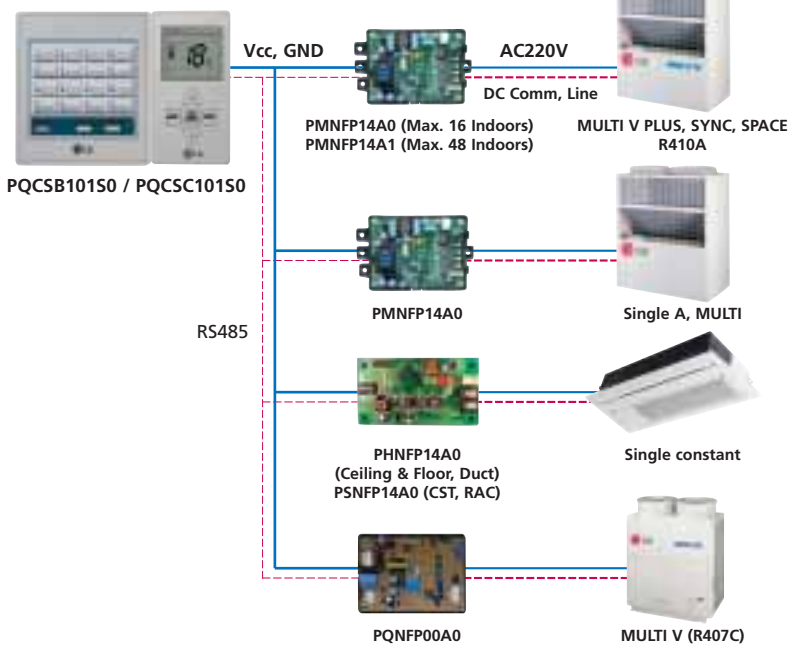

Deluxe central controller

Deluxe central controller

- A central controller for managing large sites
 - Deluxe central controller can control max 256 indoor units



PQCSW502A2

Features

- 7 inch LCD panel
- Individual/integrated operation/monitoring (Max. 256 indoor units)
- Group management
- Self-diagnosis function
- Semi-permanent life / convenient maintenance
- Easy update
- Management cost down
- Convenient GUI / touch screen
- Schedule automatic operation management

• Additional accessory

- Interface unit(CNU) : PQNFG14B0 (2 CNU / 1 DCC)
 Interface unit(PI485) : PMNFP14A0 (For 1 outdoor with max 16 indoors, 16 PI485 / 1 CNU)
 PMNFP14A1 (For 1 outdoor with max 48 indoors, 16 PI485 / 1 CNU)

• Wiring

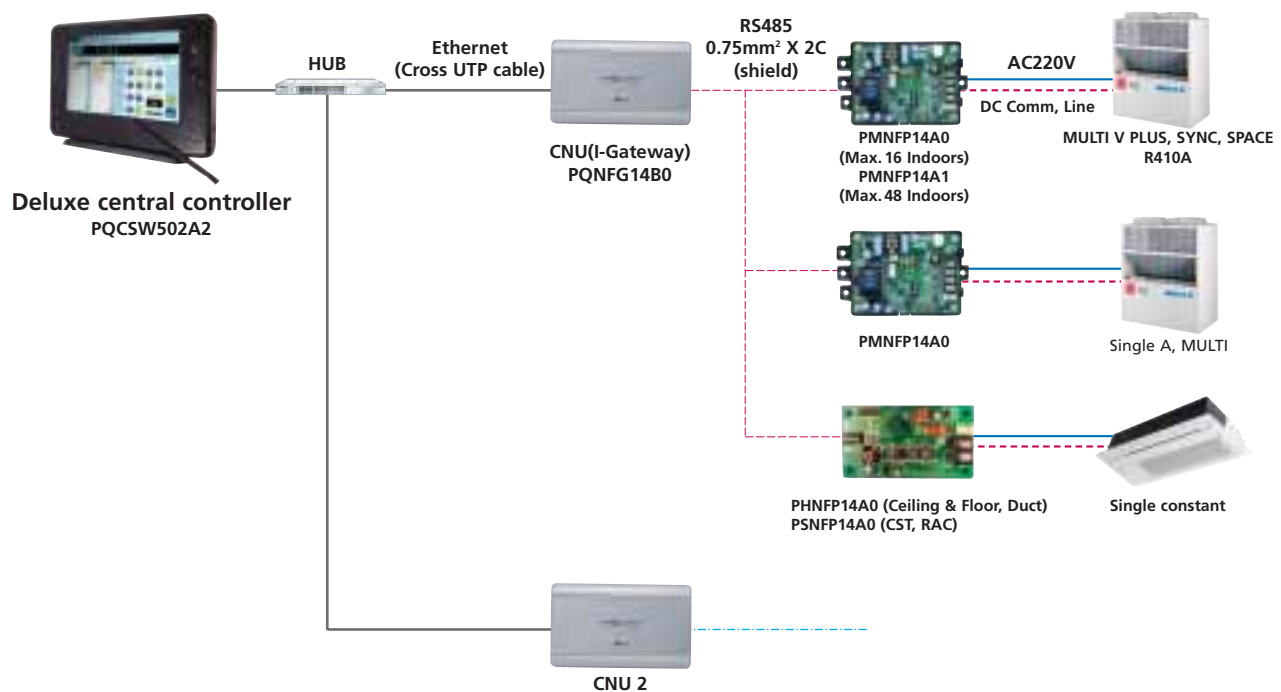

Network
solution



PC Based central controller

■ PC Based centroller

- A central controller for managing huge sites
- PC Based central controller can control Max. 2048 Indoor units



PC Based central controller
PQCSS513A0

Classification	PQCSS513A0
Configuration	User S.W engine
Program installation	Install with CD
Program installation maximum number of system to control	2,048
CNU	PQNFG14B0
Internet remote control	✓
System configuration	✓
Control/monitoring	✓
User lock function	✓
Schedule management	✓
Peak Control	✓
PDI monitoring	✓
Ventilation control&monitoring	✓

• **Additional accessory**

- Interface unit (CNU) : PQNFG14B0 (16 CNU / 1 PCC)
- Interface unit (PI485) : PMNFP14A0 (For 1 outdoor with Max. 16 Indoors, 8 PI485 / 1 CNU)
- PMNFP14A1 (For 1 outdoor with Max. 48 Indoors, 8 PI485 / 1 CNU)

• Wiring

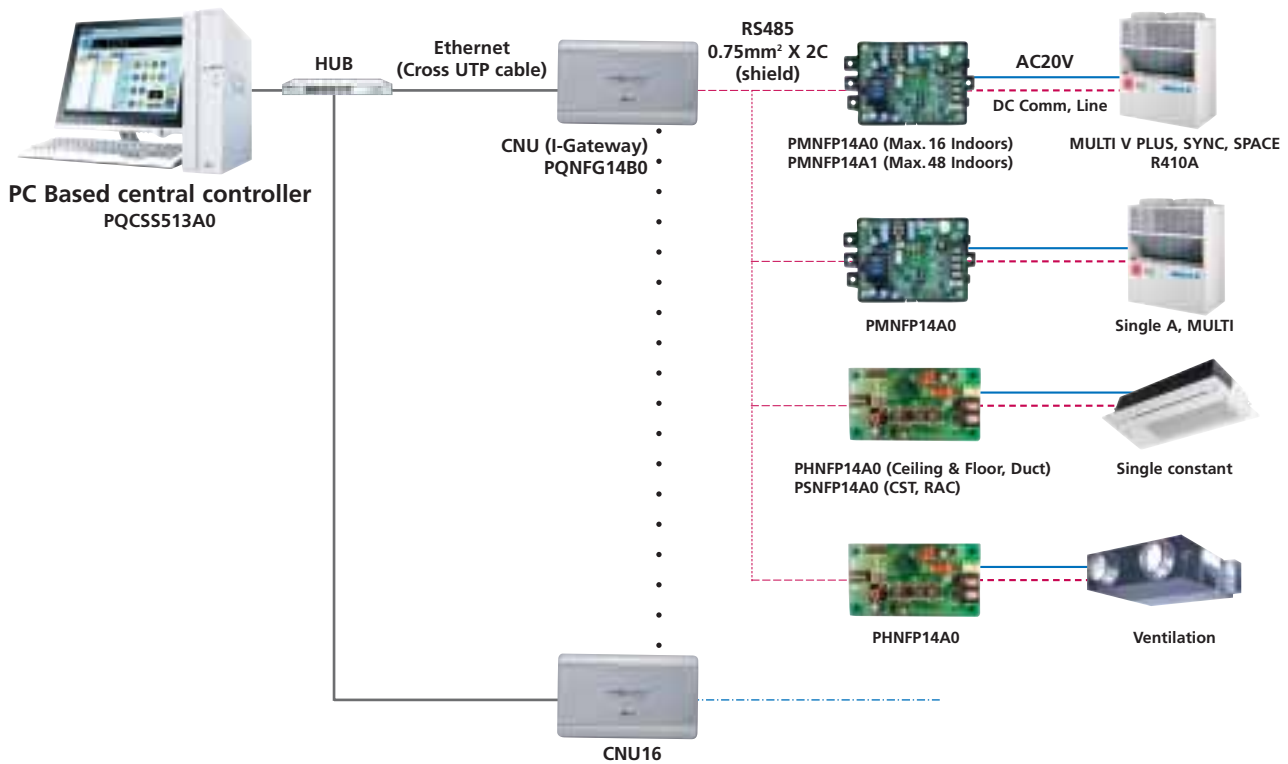

PDI (Power Distribution Indicator)

■ PDI (Power Distribution Indicator)

- This device is an indicator for power consumption of the multi type Air-conditioner used for common power line.



PQNUD1500

Features

- Indicates power consumption of every indoor unit
- Accumulated total power consumption
- Accumulated / current power consumption of each indoor unit
- Period accumulated power consumption
- Data back-up on EEPROM even if power turns Off
- Max 48 indoor units
- Connectable to PCC
- Applied products : MULTI V PLUS & MULTI

• Additional accessory

Interface unit (PI485): PMNFP14A0 (for 1 outdoor with Max. 16 Indoors)
PMNFP14A1 (for 1 outdoor with Max. 48 Indoors)

• Wiring

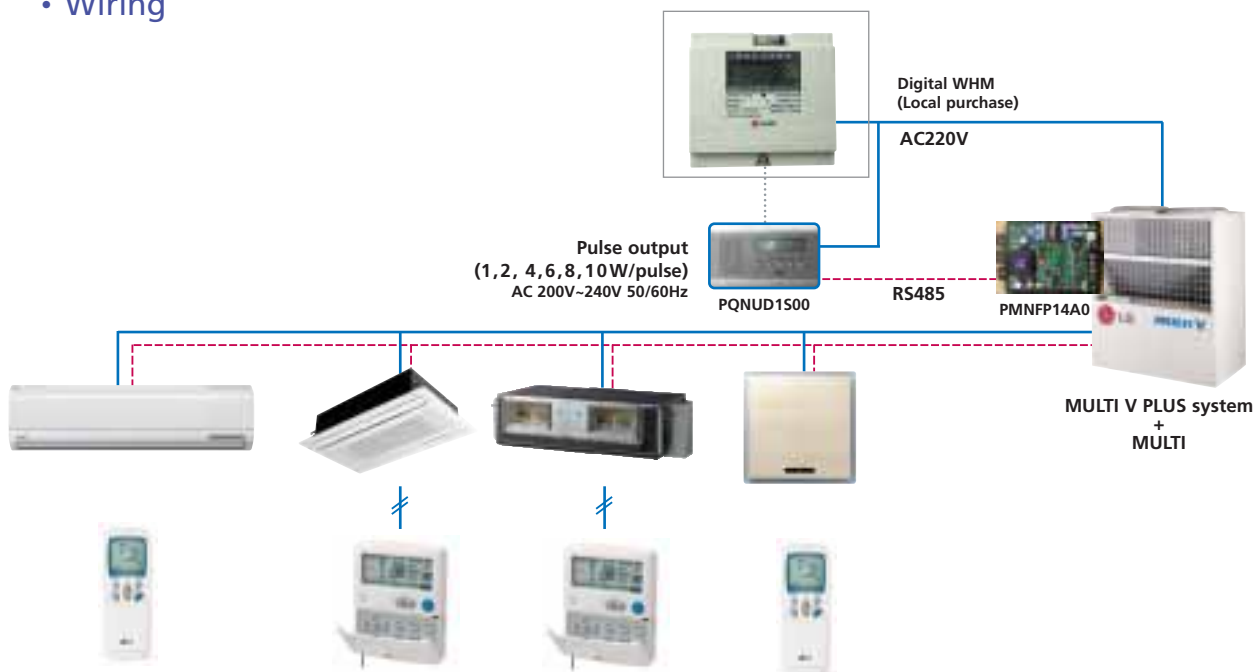



BNU-LW (Building network unit-LONWORKS®)

■ BNU-LW (for the use in LONWORKS®)



<LonMark certification version 3.3>

- Easy interface between BMS and LG air conditioner
 - Independence of BMS under the standard BMS : Operation system based on LNS (LONWORKS® network service)
 - No network installation needed
 - Very widely applicable protocol (LONWORKS®)



PQNFB16A1

Features

- Connection to LONWORKS® using LONWORKS® protocol and LG Air-conditioner protocol
- Process ability
 - 64 units(including indoors and ventilators)
 - valid address for each unit : 0x00 ~ 0x3F
- Self installation verification function using internet (web server included)
 - setting gateway
 - diagnosis of communication status on LG Air-conditioner network
- Connection to remote total management System (LG system)
- LonMark certification (version 3.3)

Controlling	Monitoring items
On/Off command	On/Off status report
Operation mode setting	Operation mode status report
Fan Speed setting	Fan Speed status report
Lock setting	Lock status report
Air flow setting	Air flow status report
Set temp. setting	Set temp. status report
User mode setting (for only ventilator)	Current Space temp. status report
	Error status report
	User mode status report (for only ventilator)

- Additional accessory
 - Interface unit (PI485) : PMNFP14A0 (for 1 outdoor with Max. 16 Indoors)
 - PMNFP14A1 (for 1 outdoor with Max. 48 Indoors)

• Wiring

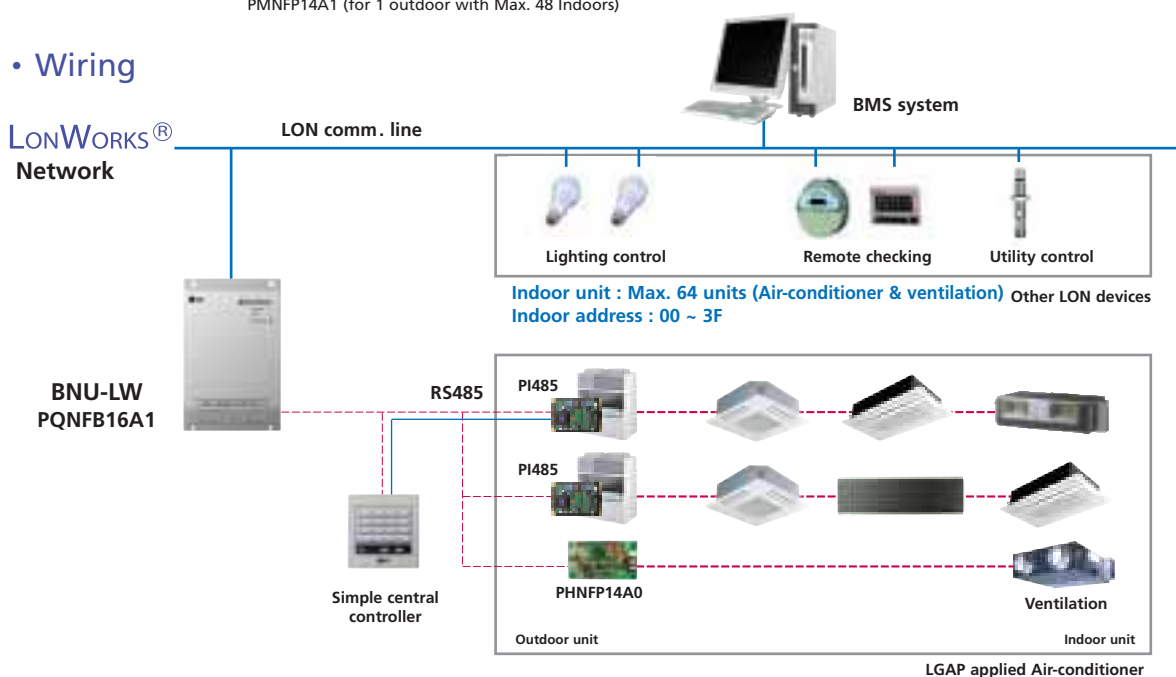

BNU-BN (Building network unit- BACnet)

■ BNU-BN (for the use in BACnet)



Features

- Through embedded web control function in BACnet one can access the airconditioner and external devices through internet.
- It can control 256 indoor units. (A/C or Ventilator)
- External devices such as fire alarm, motion detector can be connected to gateway and their function can be interlinked with airconditioner operation.

Controlling	Monitoring items
On/Off command	On/Off status report
Operation mode setting	Operation mode status report
Fan Speed setting	Fan Speed status report
Lock setting	Lock status report
Air flow setting	Air flow status report
Set temp. setting	Set temp. status report
User mode setting (for only ventilator)	Current Space temp. status report
	Error status report
	User mode status report (for only ventilator)

PQNFB17B0

Network solution

- **Additional accessory**
 Interface unit (PI485) : PMNFP14A0 (for 1 outdoor with Max. 16 Indoors)
 PMNFP14A1 (for 1 outdoor with Max. 48 Indoors)

• Wiring

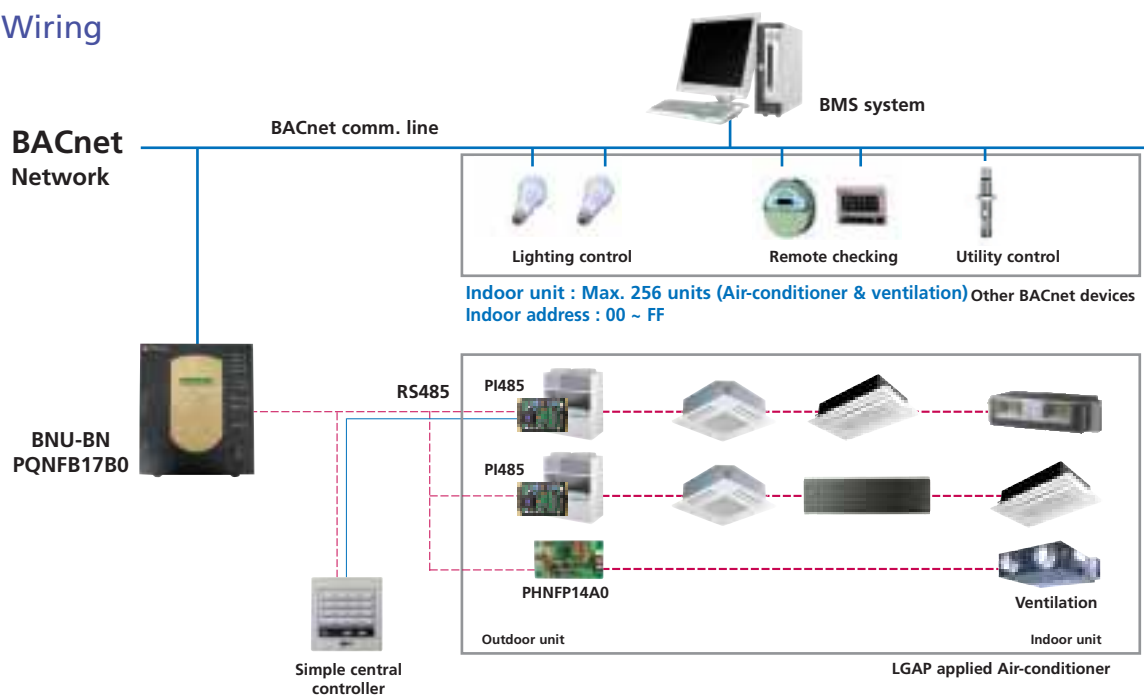



CNU (I-Gateway) / PI485

■ CNU (I-Gateway)



PQNFG14B0

Features

- CNU converts the ethernet protocol into RS 485 protocol and vice versa.
- Used with deluxe and P/C based central controllers.

• Part description

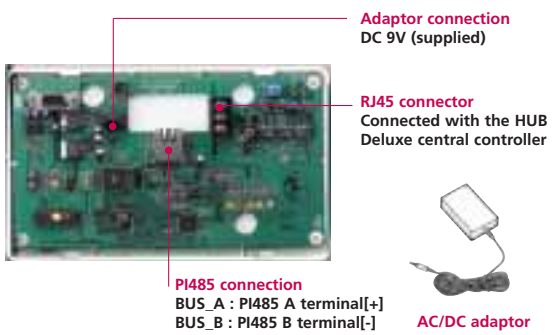

• Wiring diagram

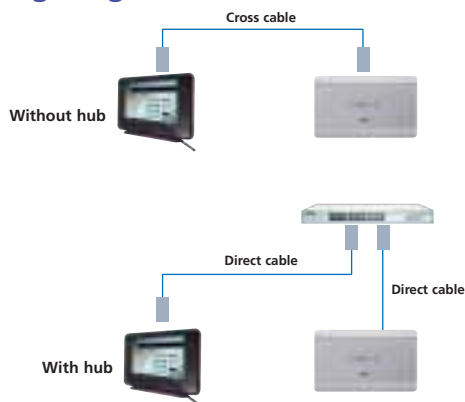

■ PI485



PMNFP14A0



PMNFP14A1

Features

PI485 converts the protocol of air-conditioner to the 485 protocol for central controller.

- Device for simple/deluxe/PC controllers.
- Supports communication wires length flexibility up to 1km.
- Different types of PCB for different products.
- Option select (LGAP, CAC, RAC)
- LED display (Communication state)
- Four different types
- Available Max. 16 Indoor units : PMNFP14A0
- Available Max. 48 Indoor units : PMNFP14A1

• Wiring diagram

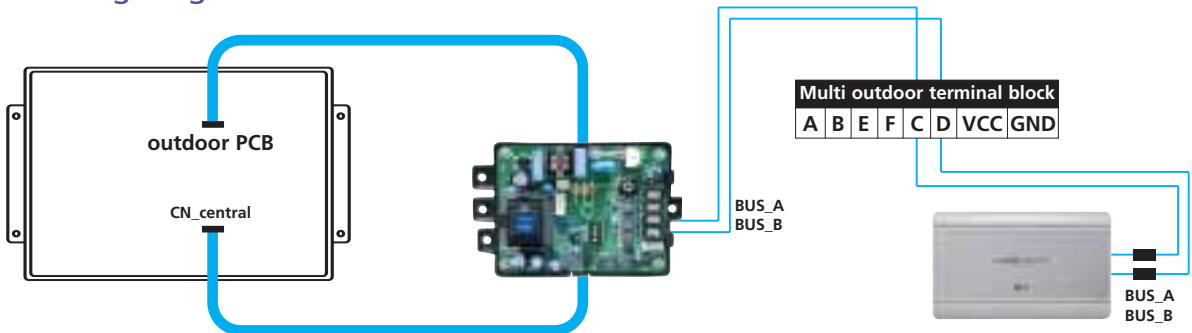

Dry contact module

Remote Temperature Sensor

■ Dry contact module



PQDSA



PQDSB

Features

Several kinds of devices can control & monitor our air-conditioner by using dry contact very easily.

- On_Off control by contact for example
 - Motion detector sensors in the room
 - Timer function
 - Hotel key switch
- Operation state monitor
- Error state monitor

• Function

Two modes of dry contact are automatic operation and manual operation. Automatic operation and manual operation can be changed by pressing the reservation cancel button of the wireless remote controller in a series of 3 times within 3 minutes.

• Function

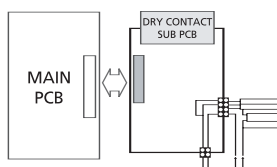

■ Remote Temperature Sensor



PQRSTA0

Features

It can help to detect the exact room temperature at the optimal position.

- Model applied to Cassette, Duct type.
- Part supplied
 - Remote temperature sensor
 - Cable (15m)
 - Manual

• Wiring diagram

1. Wire to the control box in the indoor unit by removing the existing thermistor and connect the extension cable its place.
2. Cut the extension cable to the appropriate length and connect the screw terminal of the remote sensor.
3. In the case of wired remote controller installed, set the temperature sensing slide s/w at MAIN mode.

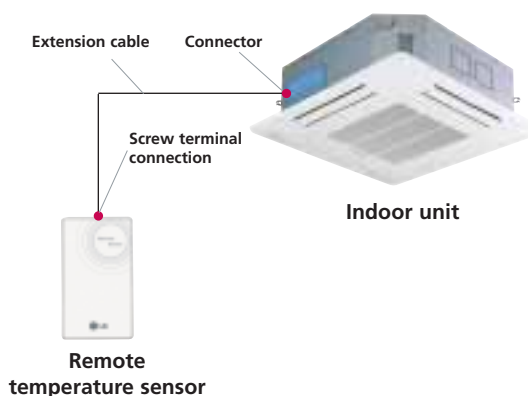



Heat recovery unit

■ Heat recovery unit (Applied to **MULTI V™ SYNC** R410A)

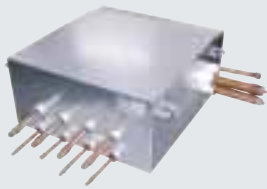

PRHR040

- Max. 4 indoor units can be connected by module design.
- Due to the automatic search algorithm for piping detection, easy installation and effectiveness is improved.
- Subcooling cycle in HR unit makes the system efficiency maximum.

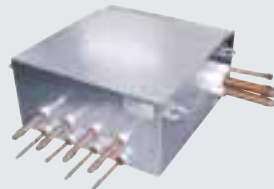

PRHR040
(4 Pipe-connection)

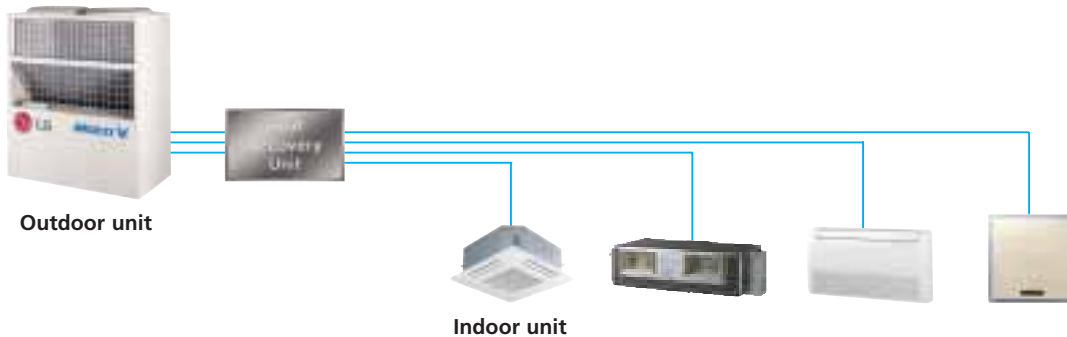

Model			PRHR040	
Max. connectable number of indoor units			4	
Max. connectable capacity of indoor units (Per port/unit)			14.1 / 47	
Nominal Input	cooling	kW	40	
	heating	kW	40	
Net. weight		kg	21	
Dimensions (WxHxD)		mm	801x218x617	
Piping connections	Indoor unit	liquid	mm(inch)	9.52 (3/8)
		gas	mm(inch)	15.88 (5/8)
	Outdoor unit	liquid	mm(inch)	12.7 (1/2)
		low pressure	mm(inch)	28.58 (1 1/8)
		high Pressure	mm(inch)	22.2 (7/8)
Power supply		ø /V/Hz	1/220 ~ 240/50	

Branch

Connection of liquid (Gas) pipe in outdoor units

Header

Multi V PLUS, Multi V SPACE		
Header	Gas pipe	Liquid pipe
		4 branch ARBL054
		7 branch ARBL057
		4 branch ARBL104
		7 branch ARBL107
		10 branch ARBL107
		10 branch ARBL2010

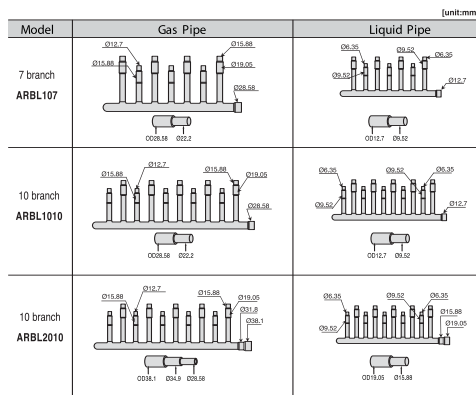
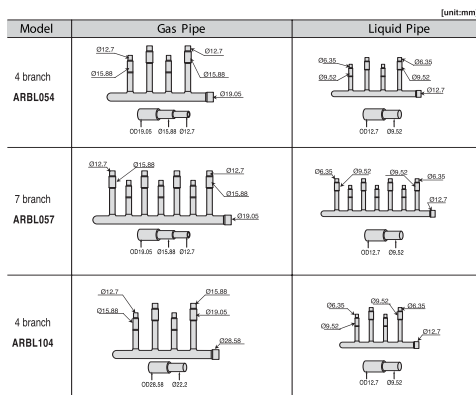

Accessories

Connection of liquid(gas) pipe in outdoor units & Y branch

	Multi V PLUS		Multi V SYNC			Multi V SPACE	
	Gas pipe	Liquid pipe	Low Pressure Gas Pipe	Liquid Pipe	Hige Pressure Gas Pipe	Gas pipe	Liquid pipe
2 Outdoor Unit	ARCNN20		ARCNB20			-	
3 Outdoor Unit	ARCNN20 ARCNN30		ARCNB20 ARCNB30			-	
Y Branch	ARBLN01620 ~ under 16.0kW ARBLN03320 ~ under 33.0kW ARBLN07120 ~ under 71.0kW ARBLN14520 71.0kW or more ~		ARBLB1620 ~ under 16.0kW ARBLB03320 ~ under 33.0kW ARBLB07120 ~ under 71.0kW ARBLB14520 71.0kW or more ~			ARBLN01620 ~ under 16.0kW ARBLN03320 ~ under 33.0kW	

MULTI V PLUS Y Branch (2 Outdoor units)

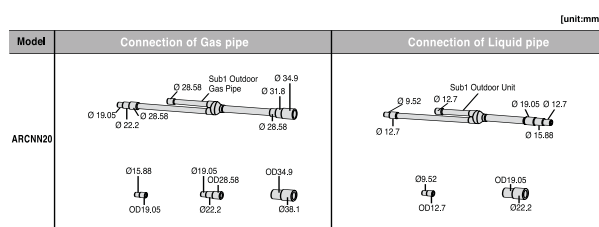

MULTI V PLUS Y Branch (3 Outdoor units)

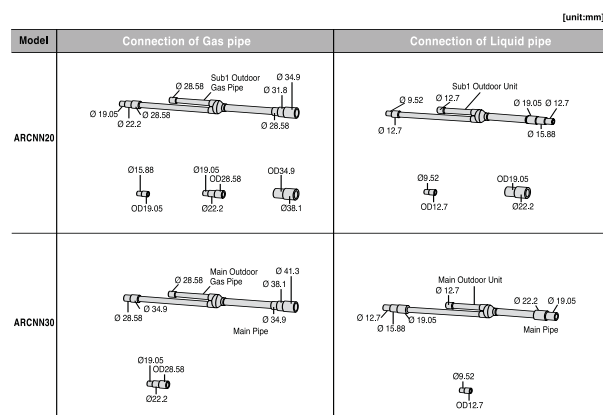



MULTI V™ PLUS Y Branch (Indoor unit)
MULTI V™ SPACE

Models	Gas pipe	Liquid pipe
ARBLN01620		
ARBLN03320		

Models	Gas pipe	Liquid pipe
ARBLN07120		
ARBLN14520		

MULTI V™ SYNC Y Branch (2 Outdoor units)

Model	Low Pressure Gas Pipe	Liquid Pipe	High Pressure Gas Pipe
ARCNB20			

MULTI V™ SYNC Y Branch (3 Outdoor units)

Model	Low Pressure Gas Pipe	Liquid Pipe	High Pressure Gas Pipe
ARCNB20			
ARCNB30			

MULTI V™ SYNC Y Branch (Indoor unit)

Models	Low Pressure Gas pipe	Liquid pipe	High Pressure Gas pipe
ARBLB01620			
ARBLB03320			
ARBLB07120			
ARBLB14520			

Accessories

Accessories

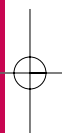
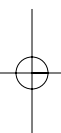
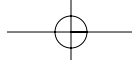

LG Electronics Inc.

Air Conditioner

20 Yeouido-dong, Yeongdeungpo-gu,
Yeouido P.O.Box 335 Seoul, 150-721, Korea.
Phone : +82-2-3777-7985
Fax : +82-2-3777-5136

<http://www.lge.com>

Distributed by

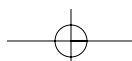

Free Manuals Download Website

<http://myh66.com>

<http://usermanuals.us>

<http://www.somanuals.com>

<http://www.4manuals.cc>

<http://www.manual-lib.com>

<http://www.404manual.com>

<http://www.luxmanual.com>

<http://aubethermostatmanual.com>

Golf course search by state

<http://golfingnear.com>

Email search by domain

<http://emailbydomain.com>

Auto manuals search

<http://auto.somanuals.com>

TV manuals search

<http://tv.somanuals.com>