



# Room Air Conditioner (Window Type)

## OWNER'S MANUAL

ENGLISH

ESPAÑOL

### WINDOW TYPE ROOM AIR CONDITIONER

- Please read carefully and thoroughly this manual before operating this unit.
- Contact the authorized SVC man for repair or maintenance of this unit.
- Contact the installer for installation of this unit.
- The appliance is not intended for use by young children or infirm persons without supervision.
- Young children should be supervised to ensure that they do not play with the appliance.

**MODELS:** W091CA TSG0

**(MODELOS)** W092CA TSG0

W121CA TSC2

W122CA TSC0

W182CA TSN0

W242CM TSN0



W182CM TSN0

W242CA TSN0

Antes de usar su aire acondicionado, lea este manual cuidadosamente y manténgalo para futura referencia.

Aire Acondicionado  
(Tipo de Ventana)

MANUAL DEL USUARIO

REGISTERED VERSION  
REGISTERED  
VERSION  
ADDS NO  
WATERMARK  
www.print-driver.com

# TABLE OF CONTENTS

**1. Safety Precautions**

**2. Operating Instructions**

**3. Care and Maintenance**

**4. Hardware Installation**

**5. Common Issues**



## FOR YOUR RECORDS

Write the model and serial numbers here:

**Model #** \_\_\_\_\_

**Serial #** \_\_\_\_\_

You can find them on a label on the side of each unit.

**Dealer's Name** \_\_\_\_\_

**Date Purchased** \_\_\_\_\_

- Staple your receipt to this page in the event you need it to prove date of purchase or for warranty issues.



## READ THIS MANUAL

Inside you will find many helpful hints on how to use and maintain your air conditioner properly. Just a little preventive care on your part can save you a great deal of time and money over the life of your air conditioner.

You'll find many answers to common problems in the chart of troubleshooting tips. If you review our chart of

**Troubleshooting Tips** first, you may not need to call for service at all.



## PRECAUTION

- Contact the authorized service technician for repair or maintenance of this unit.
- Contact the installer for installation of this unit.
- The air conditioner is not intended for use by young children or invalids without supervision.
- Young children should be supervised to ensure that they do not play with the air conditioner.
- When the power cord is to be replaced, replacement work shall be performed by authorized personnel only using only genuine replacement parts.
- Installation work must be performed in accordance with the National Electric Code by qualified and authorized personnel only.



To prevent injury to the user or other people and property damage, the following instructions must be followed.

- Incorrect operation due to ignoring instruction will cause harm or damage. The seriousness is classified by the following indications.

**⚠ WARNING** This symbol indicates the possibility of death or serious injury.

**⚠ CAUTION** This symbol indicates the possibility of injury or damage to properties only.

- Meanings of symbols used in this manual are as shown below.

	<b>Be sure not to do.</b>
	<b>Be sure to follow the instruction.</b>

**⚠ WARNING**

■ **Installation**

**Always install the expansion panel(s).**

- No installation may cause fire and electric shock accident.

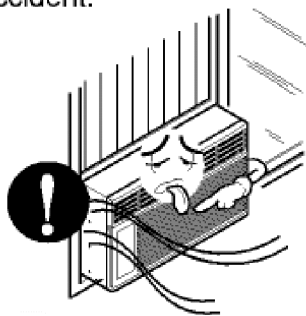

**Do not place the power cord near a heater.**

- It may cause fire and electric shock.

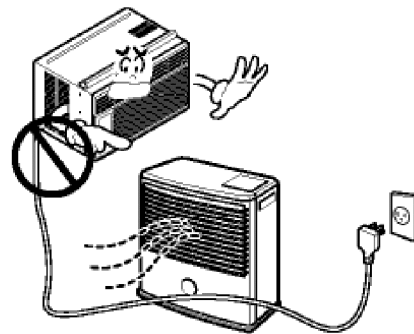

**Do not use the power cord near flammable gas or combustibles such as gasoline, benzene, thinner, etc.**

- It may cause explosion or fire.

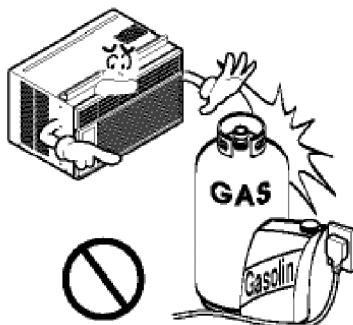

**Do not disassemble or modify products.**

- It may cause failure and electric shock.



## ■ Operation

### Plug in the power plug properly.

- Otherwise, it will cause electric shock or fire due to heat generation or electric shock.

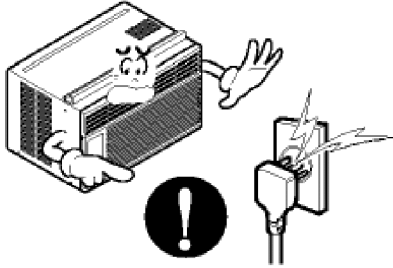

### Do not operate or stop the unit by inserting or pulling out the power plug.

- It will cause electric shock or fire due to heat generation.

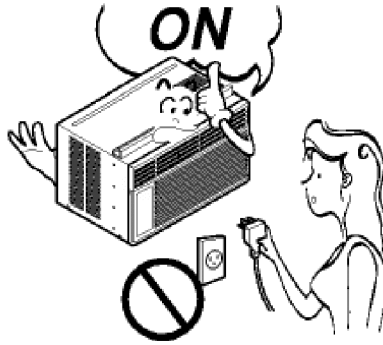

### Do not damage or use an unspecified power cord.

- It will cause electric shock or fire.

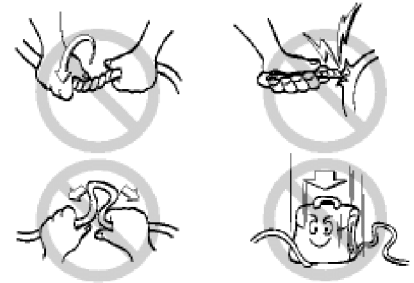

### Do not modify power cord length.

- It will cause electric shock or fire due to heat generation.

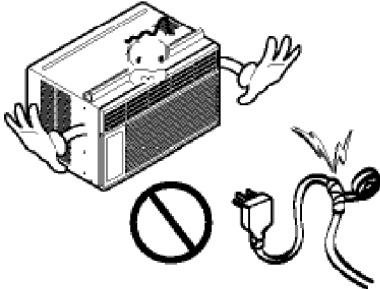

### Do not share the outlet with other appliances.

- It will cause electric shock or fire due to heat generation.

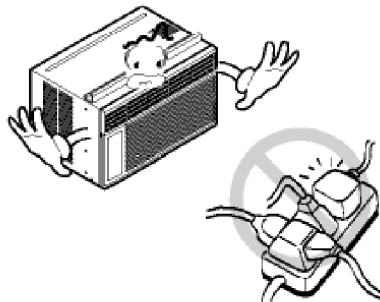

### Always plug into a grounded outlet.

- No grounding may cause electric shock (See Installation Manual).

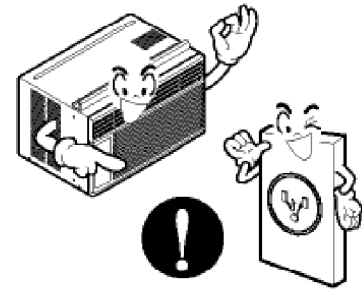

### Unplug the unit if strange sounds, odors, or smoke come from it.

- Otherwise it may cause fire and electric shock accident.



### Do not use the socket if it is loose or damaged.

- It may cause fire and electric shock.

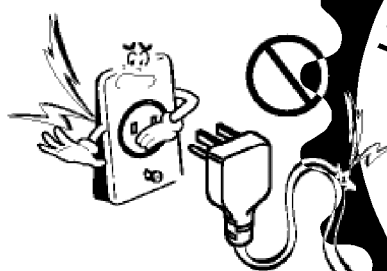

### Do not operate with wet hands or in damp environment.

- It will cause electric shock.



UNREGISTERED VERSION  
REGISTERED  
VERSION  
DOES NOT  
WATERMARK  
www.print-driver.com

**Do not allow water to run into electric parts.**

- It will cause failure of machine or electric shock.

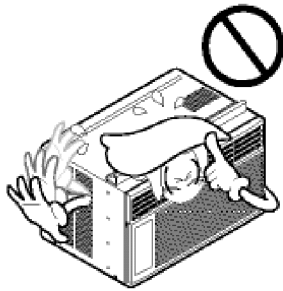

**Leave the door closed while the air conditioner is running.**

- It is not designed to cool the entire house.

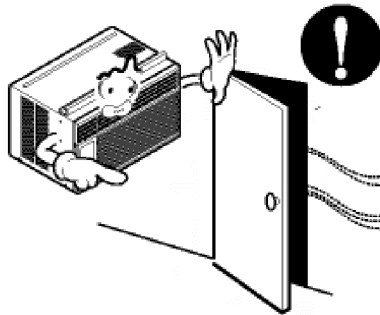

**Ventilate before operating air conditioner when gas goes out.**

- It may cause explosion, fire, and burn.

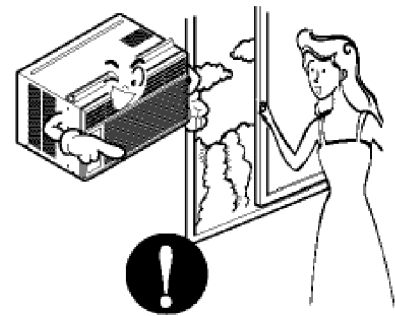

**CAUTION**

**Installation**

**Never touch the metal parts of the unit when removing the filter.**

- They are sharp and may cause injury.

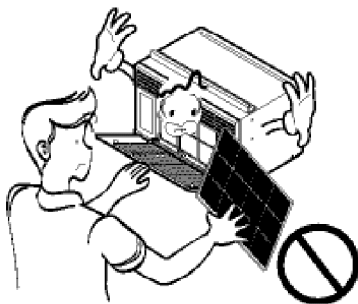

**Do not block the inlet or outlet.**

- It may cause failure of appliance or accident.

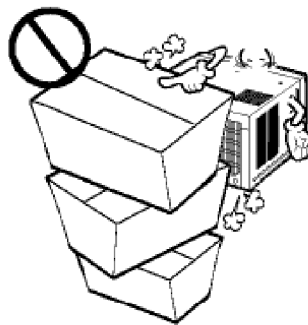

**Ensure that the outer case is not damaged by age or wear.**

- If leaving appliance damaged, there is concern of damage due to the falling of product.



**Operation**

**Be cautious not to touch the sharp edges when installing.**

- It may cause injury.

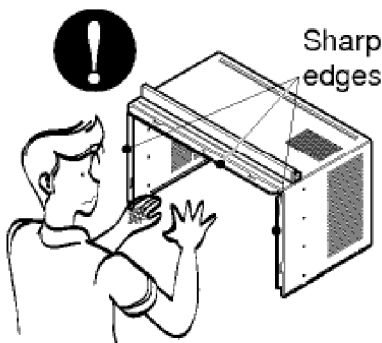

**Hold the plug by the head when taking it out.**

- It may cause electric shock and damage.

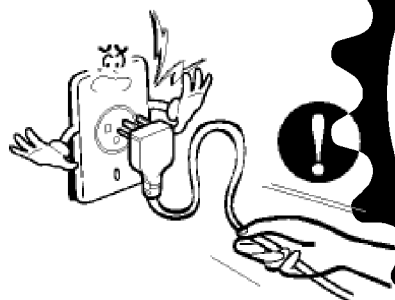

**Turn off the main power switch when not using it for a long time.**

- Prevent accidental startup and the possibility of injury.





**Do not place heavy object on the power cord and take care so that the cord should not be pressed.**

- There is danger of fire or electric shock.

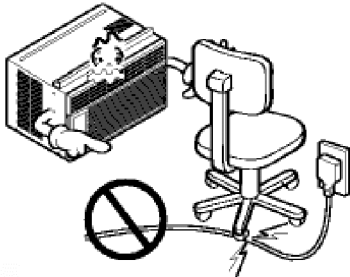

**If water enters the product, turn off the the power switch of the main body of appliance. Contact service center after taking the power-plug out from the socket.**



**Do not clean the air conditioner with water.**

- Water may enter the unit and degrade the insulation. It may cause an electric shock.

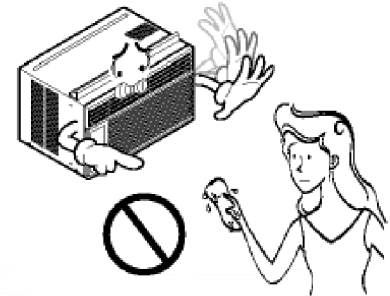

**Turn off the power and breaker firstly when cleansing the unit.**

- Since the fan rotates at high speed during operation, it may cause injury.

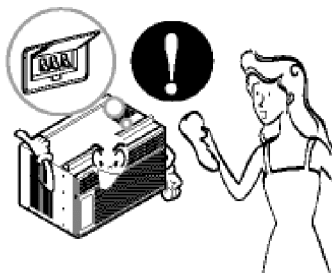

**Do not put a pet or house plant where it will be exposed to direct air flow.**

- This could injure the pet or plant.



**Do not use this appliance for special purposes such as pets, foods, precision machinery, or objects of art.**

- It is an air conditioner, not a precision refrigeration system.

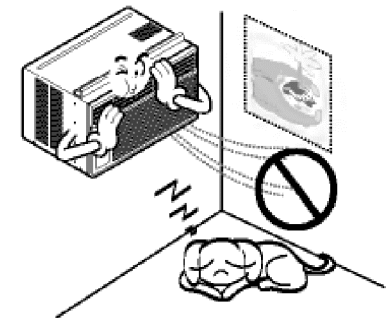

**Always insert the filter securely. Clean it every two weeks.**

- Operation without filters will cause failure.

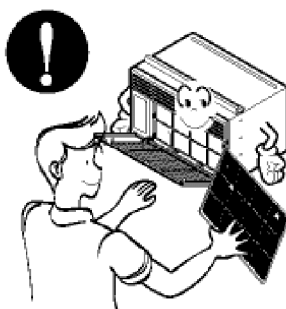

**Use a soft cloth to clean. Do not use wax, thinner, or a strong detergent.**

- The appearance of the air conditioner may deteriorate, change color, or develop surface flaws.

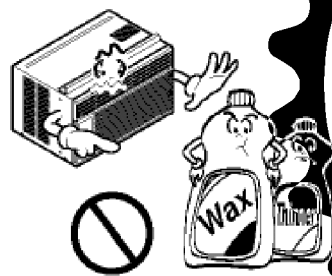

**Do not drink water drained from air conditioner. / Do not direct airflow at room occupants only.**

- It contains contaminants and will make you sick. / This could damage your health.



Controls

The controls will look like one of the following.

**NOTICE**  : Optional

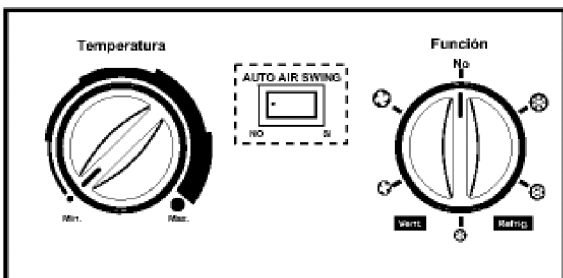
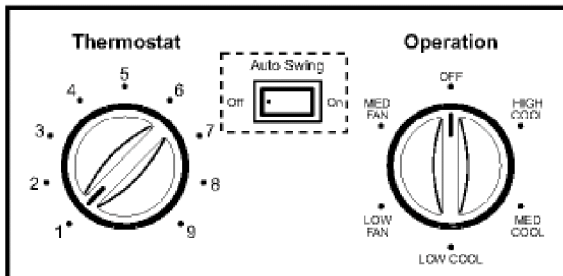
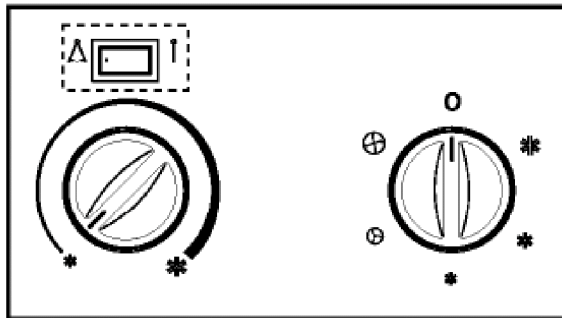
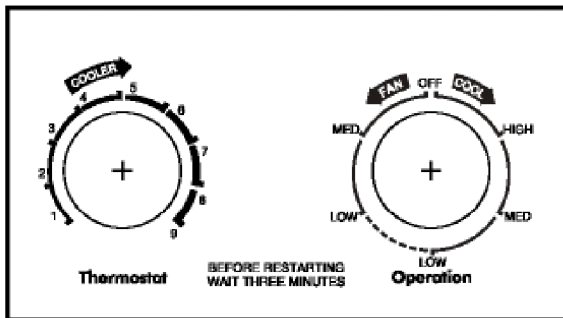
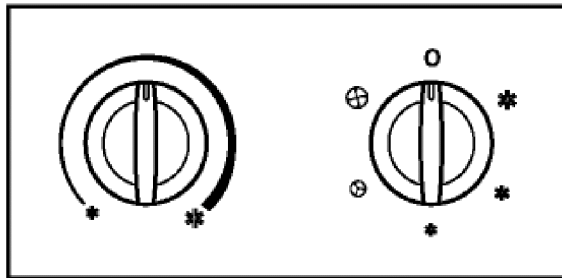
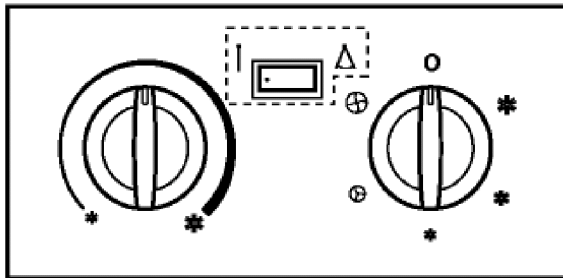
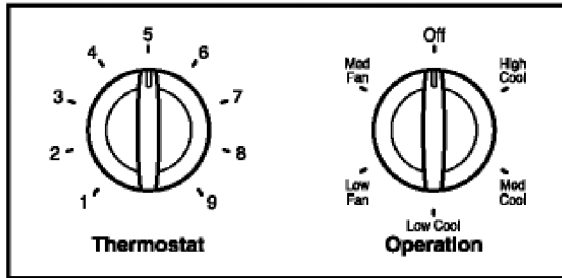
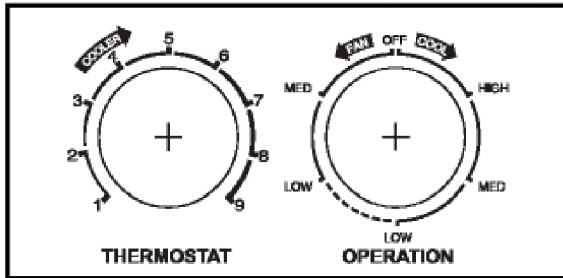

## ■ OPERATION

High Cool ( ❄ ), Med Cool ( ❄ ) and

Low Cool ( ❄ ) provide cooling with different fan speeds. Med Fan ( ⌚ ) or Low Fan ( ⌚ ) provides air circulation and filtering without cooling. Off ( ○ ) turns the air conditioner off.

**NOTICE** : If you move the switch from a cool setting to off or to a fan setting, wait at least 3 minutes before switching back to a cool setting.

### **Cooling Descriptions**

**For Normal Cooling-** Select High Cool or Med Cool with the Operation knob at the midpoint of Thermostat knob.

**For Maximum Cooling-** Select High Cool with the Operation knob at the highest number available on your Thermostat knob.

**For Quieter & Nighttime Cooling-** Select Low Cool with the Operation knob at the midpoint of Thermostat knob.

## ■ THERMOSTAT

The THERMOSTAT is used to maintain the room temperature. The compressor will cycle on and off to keep the room at the same level of comfort. When you turn the knob to a higher number(the right side) and the indoor air will become cooler.

The 5 or 6 position (the middle position of arc) is a normal setting for average conditions.

## ■ AUTO SWING (Optional)

Auto swing switch controls the horizontal air direction by air swing system (not on all models).

ON ( ⚠ ) : Auto swing is operated.

OFF ( ↑ ) : Auto swing is not operated.

**CAUTION:** When the air conditioner has been performed its cooling operation and is turned off or set to the fan position, wait at least 3 minutes before resetting to the cooling operation again.





## Controls

The controls will look like one of the following.

**NOTICE** [ ] : Optional

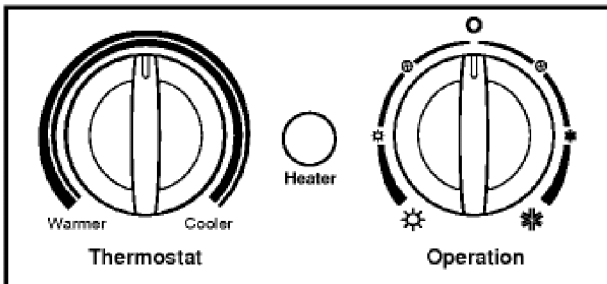
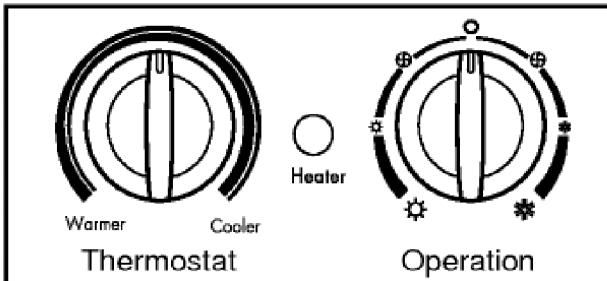
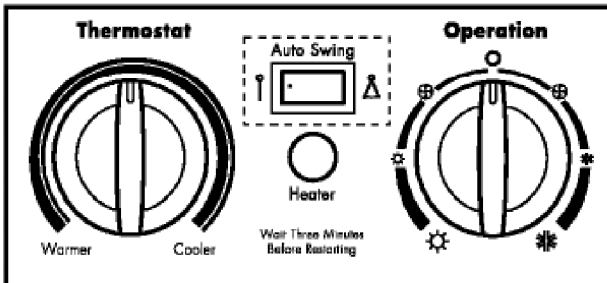
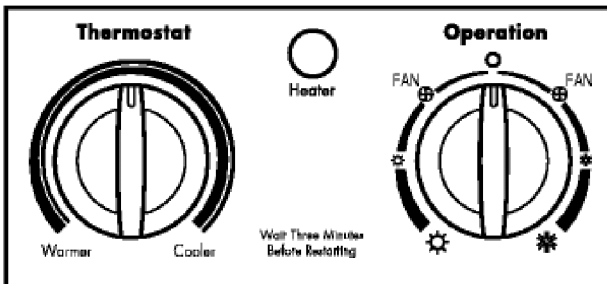

### ■ AUTO SWING (Optional)

ON (  $\Delta$  ) : Air swing is operated while OPERATION knob is set to the COOL or HEAT position.

OFF (  $\uparrow$  ) : Stops the operation of air swing.

### ■ THERMOSTAT

Turn the thermostat control to the desired setting. The control position is a normal setting for average conditions. You can change this setting, if necessary, in accordance with your temperature preference.

The thermostat automatically controls cooling or heating, but the fan runs continuously whenever the air conditioner is in operation. If the room is too warm, turn the thermostat control clockwise. If the room is too cool, turn the thermostat control counterclockwise.

### ■ HEATER ( $\odot$ ) LAMP

When the unit sets heating operation condition, the green lamp is lighted.

When the frost settles on the heat exchanger of the outside, defrosting is made automatically and the green lamp is turned off.

The unit may give a "hiss" and the fan motor stops for 1 to 10 minutes.

This should not be regarded as a problem.

After defrosting, the heating operation begins again.

### ■ OPERATION

OFF (  $\circ$  ) : Turns the air conditioner off.

LOW FAN (  $\otimes$  ) : Permits the low fan speed operation without cooling (heating).

LOW COOL (  $\ast$  ) : Permits cooling with the low fan speed operation.

HIGH COOL (  $\ast$  ) : Permits cooling with the high fan speed operation.

LOW HEAT (  $\odot$  ) : Permits heating with the low fan speed operation.

HIGH HEAT (  $\odot$  ) : Permits heating with the high fan speed operation.

**CAUTION** : When the air conditioner has been performed its cooling operation and is turned off, or set to the fan position, wait at least 3 minutes before resetting to the cooling operation again.

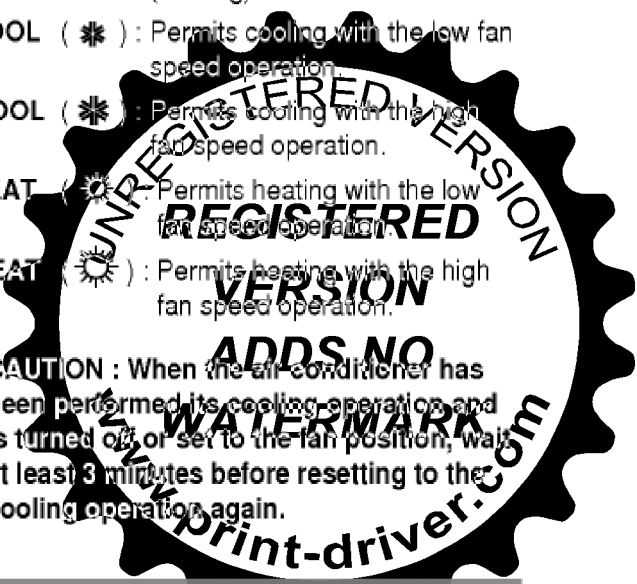

The controls will look like one of the following.

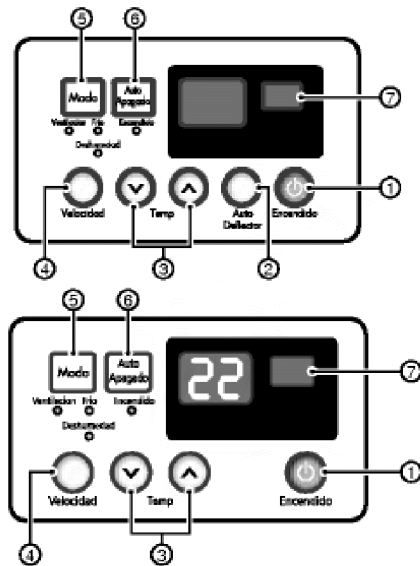

## REMOTE CONTROL

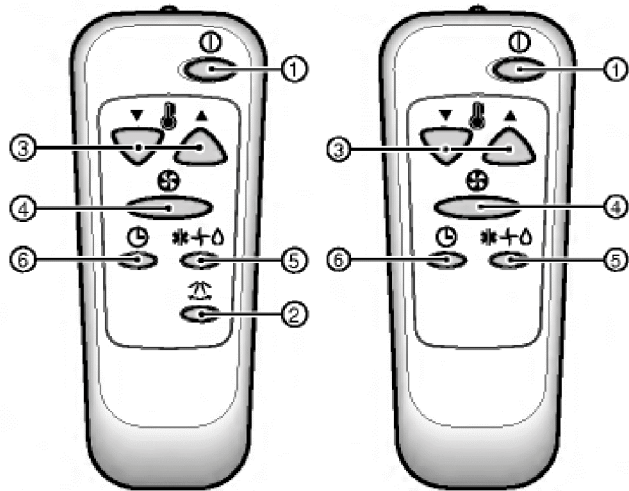

## Controls



**CAUTION:** The Remote Control unit will not function properly if strong light strikes the sensor window of the air conditioner or if there are obstacles between the Remote Control unit and the air conditioner.

### 1. POWER BUTTON

Operation starts, when this button is pressed and stops when you press the button again.

### 2. AUTO SWING (Optional)

The vertical louver swings horizontally by the automatic system and stops when you press the button again.

### 3. ROOM TEMPERATURE SETTING BUTTON

Control the room temperature within a range of 16°C to 30°C.

### 4. FAN SPEED SELECTOR

Select the fan speed in three steps {High[F3] → Low[F1] → Med[F2] → High[F3]...}.

### 5. OPERATION MODE SELECTION BUTTON

Select Cooling, Fan, or Dehumidification mode with this button.

### 6. ON/OFF TIMER BUTTON

Set the time of starting and stopping operation. The timer is set by 1 hour.

### 7. SIGNAL RECEIVER

#### AUTO RESTART

In failure of electric power, the unit runs as previous setting operation.

## How to Insert the Batteries

1. Remove the cover from the back of the remote controller.
2. Insert the two batteries.
3. Re-attach the cover.

- Do not use rechargeable batteries, such batteries differ from standard dry cells in shape, dimensions, and performance.
- Remove the batteries from the remote controller if the air conditioner is not going to be used for an extended length of time.

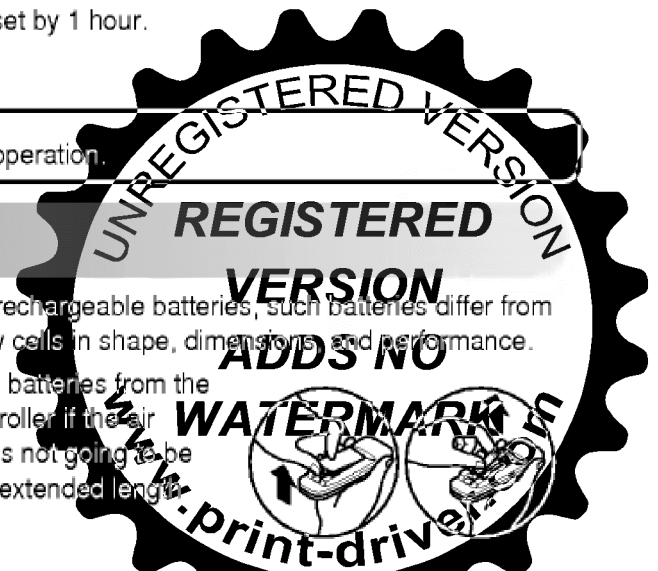

Additional controls and important information.

## Ventilation

The ventilation lever must be in the CLOSE position in order to maintain the best cooling conditions. When fresh air is necessary in the room, set the ventilation lever to the OPEN position. The damper is opened and room air is drawn out.

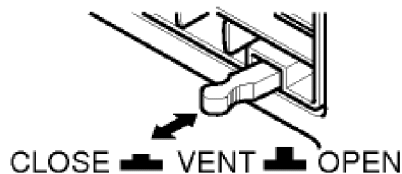

**NOTICE** : Before using the ventilation feature, position the lever, as shown. First, pull down part ① to horizontal line with part ②.

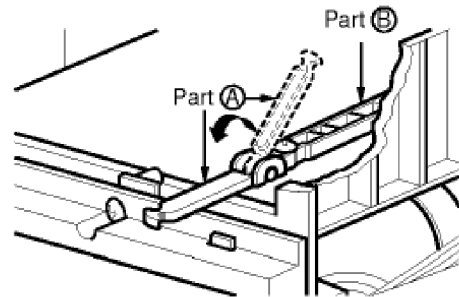

## Air Direction

The direction of air can be controlled whenever you want to cool by adjusting the horizontal louver and the vertical louver.

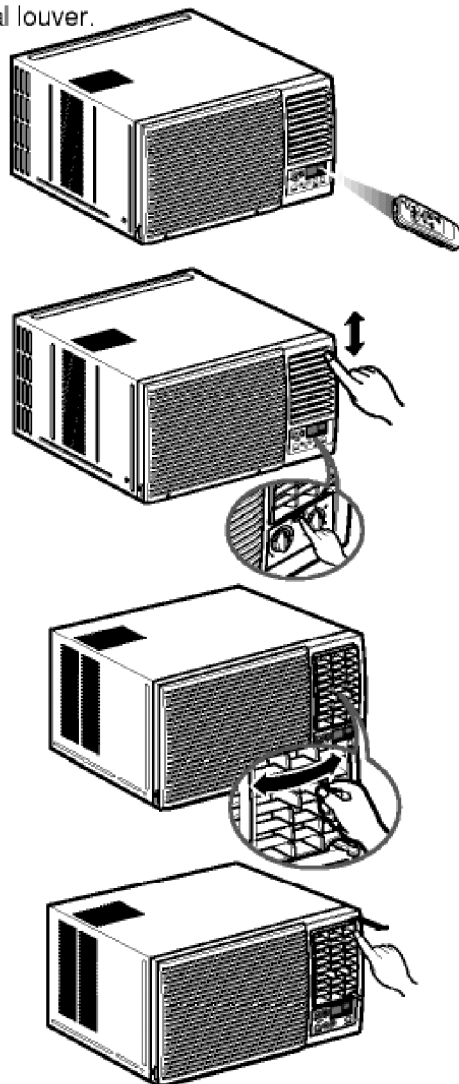

- **HORIZONTAL AIR DIRECTION CONTROL**

To control horizontal direction of air flow, press the air flow direction control button and the air flow will be swept horizontally by the automatic air-swing system.

If you want to stop the air flow from moving, press the button again at the desired position of the vane.

- **VERTICAL AIR-DIRECTION CONTROL**

The vertical air direction is adjusted by moving the horizontal louver.

- **Auto Swing Models**

The horizontal air direction is automatically controlled by setting the AUTO SWING switch to the ON position.



## How to Attach Drain Pan (Some Models)

The air conditioner employs a proper drain method whereby the condensed water (moisture removed from the air) is drained to the outside.

In very humid weather, (and for reverse cycle models in the reverse mode) excessive condensate water removed from the air may cause some water to collect. To remove this excess water you can install the drain pan as detailed below.

1. Take the drain pan which is located in the air discharge.
2. Remove the hole rubber from the base-pan (for some models).
3. Install the drain pan to the right corner of the cabinet with 4 (or 2) screws.
4. Connect the drain hose to the outlet located at the bottom of the drain pan. You can purchase the drain hose or tubing locally to satisfy your particular needs. (Drain hose is not supplied).

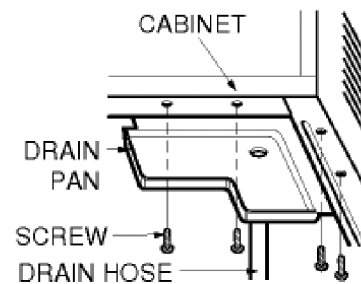

## How to Connect a Drain Hose

A drain hole is provided at the rear of the air conditioner unit.

Select a drain method according to the following.

1. Remove the hole rubber from the base-pan. (for some models)
2. Connect a drain hose to the drain pipe as shown in Fig. 1.
3. Or connect a pipe elbow to the drain pipe, then connect a drain hose to the pipe elbow as shown in Fig. 2.

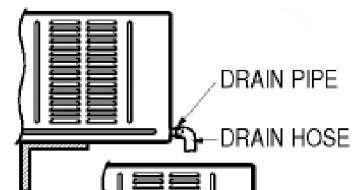

Fig. 1

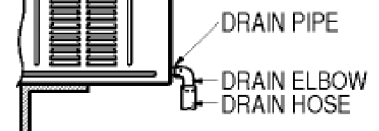

Fig. 2

## Operating Instructions

## Adjusting the Air Flow Direction

TURN THE AIR CONDITIONER OFF AND REMOVE THE PLUG FROM THE POWER OUTLET.

## Outdoor Coils

The coils on the outdoor side of the air conditioner should be checked regularly. If they are clogged with dirt or soot they may be professionally steam cleaned, a service available through a dealer.

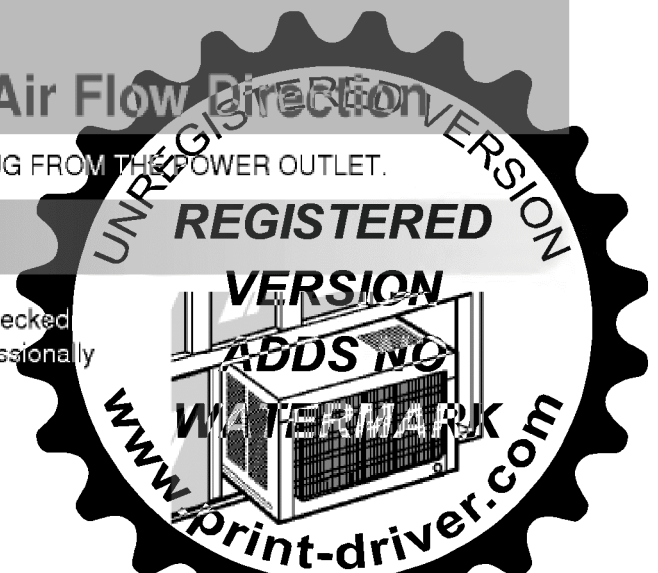



## Air Filter Cleaning

The air filter should be checked at least twice a month to see if cleaning is necessary. Trapped particles in the filter will build up and block the airflow. This reduces the cooling capacity and also causes an accumulation of frost on the cooling coils.

1. Open the inlet grille upward by pulling out the bottom of the inlet grille.(a)  
In another case, you can open the inlet grille downward by pulling out the top of the inlet grille.(b)
2. Remove the air filter from the front grille assembly by pulling the air filter up or down slightly.
3. Wash the filter using lukewarm water below 40°C (104°F).(c)
4. Gently shake the excess water from the filter completely. Replace the filter.

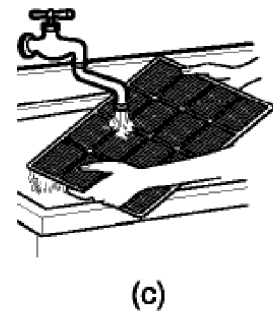
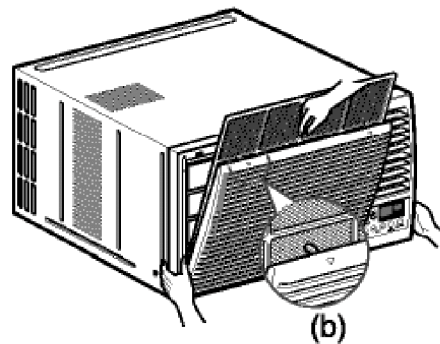
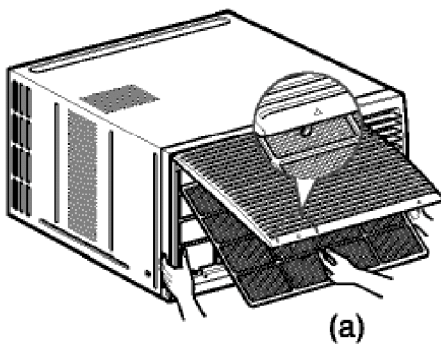

**NOTICE** : Mark Δ of inlet grille means opening direction.



**CAUTION: DO NOT** operate the air conditioner without a filter because dirt and lint will clog it and reduce performance.

## How to Attach Front Grille to Cabinet

1. Pull down front grille from the cabinet top.
2. Push front grille's tips toward the cabinet in order to insert front grille's tabs into the cabinet.
3. Open the inlet grille.
4. Tighten the screw through the front grille into the plate of the evaporator.
5. Close inlet grille.

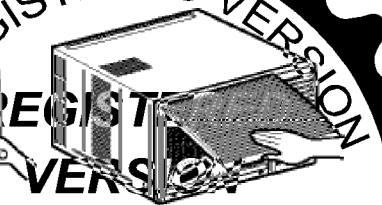
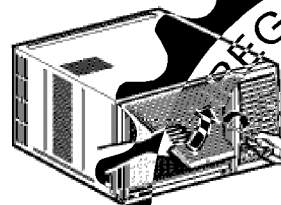
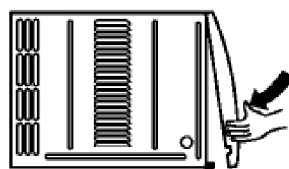
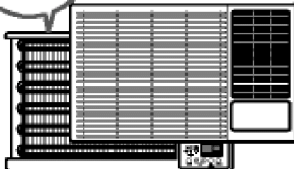

REGISTERED VERSION  
 REGIST  
 VERSI  
 ADDS NO  
 WATERMARK  
 www.print-driver.com

Learning parts name prior to installation will help you understanding the installation procedure.

## Features

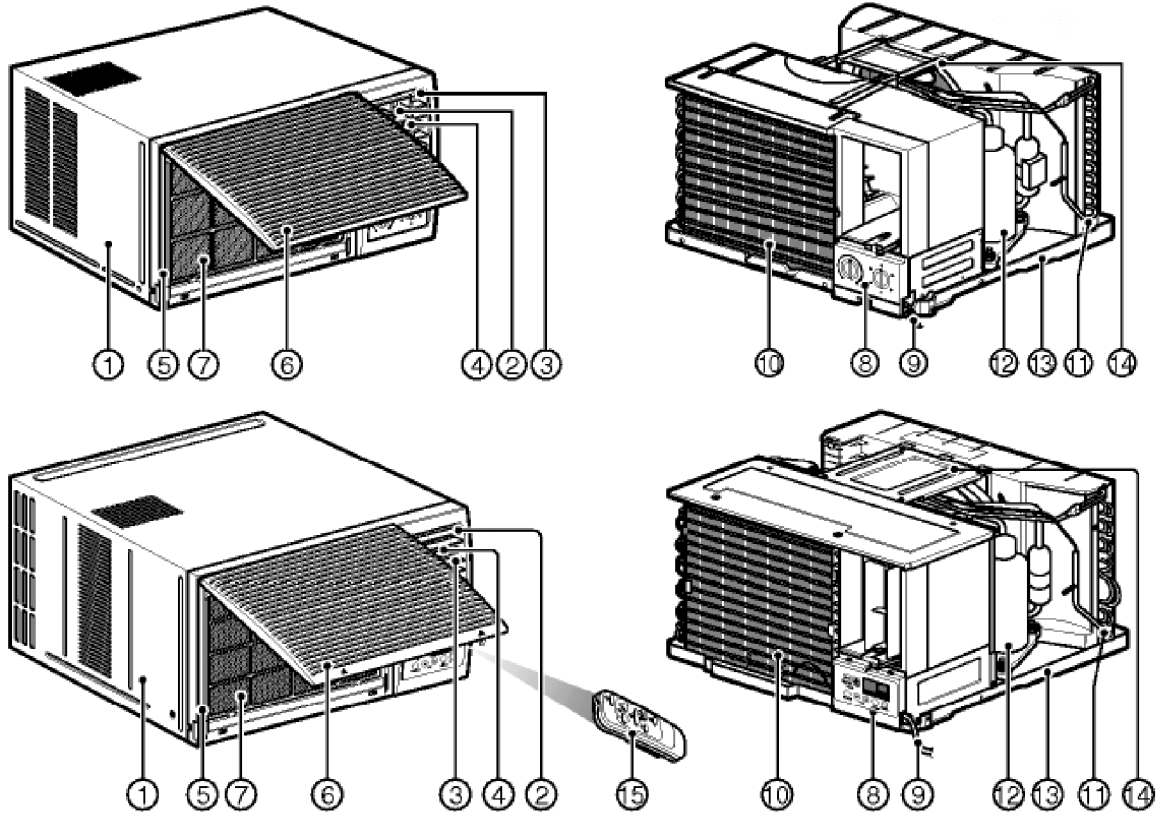

- |   |                             |                       |
|---|-----------------------------|-----------------------|
| 1. CABINET                                    | 4. AIR DISCHARGE            | 10. EVAPORATOR        |
| 2. HORIZONTAL AIR DEFLECTOR (VERTICAL LOUVER) | 5. FRONT GRILLE             | 11. CONDENSER         |
| 3. VERTICAL AIR DEFLECTOR (HORIZONTAL LOUVER) | 6. AIR INTAKE(INLET GRILLE) | 12. COMPRESSOR        |
|   | 7. AIR FILTER               | 13. BASE PAN          |
|   | 8. CONTROL BOARD            | 14. BRACE             |
|   | 9. POWER CORD               | 15. REMOTE CONTROLLER |

## Installation Hardware

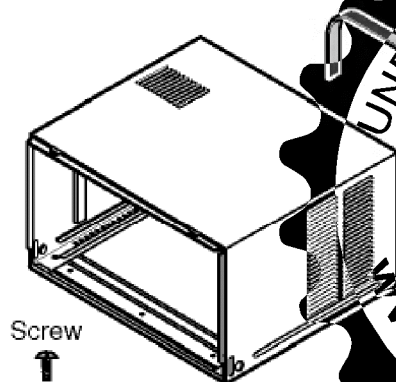

Screw  
↑





Read completely, then follow step-by step.

- The appliance shall be installed in accordance with national wiring regulation.
- If a power plug isn't to be used, provide a circuit breaker between power source and the unit, as following picture.

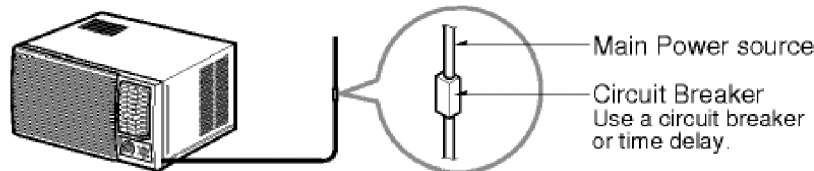

## Select the Best Location

1. To prevent vibration and noise, make sure the unit is installed securely and firmly.
2. Install the unit where the sunlight does not shine directly on the unit.
3. There should be no obstacle, such as a fence or wall, within 50cm from the back of the cabinet because it will prevent heat radiation of the condenser. Restriction of outside air will greatly reduce the cooling efficiency of the air conditioner.
4. Install the unit a little obliquely outward not to leak the condensed water into the room (about 10 ~ 15mm or 1/4 bubble with level).

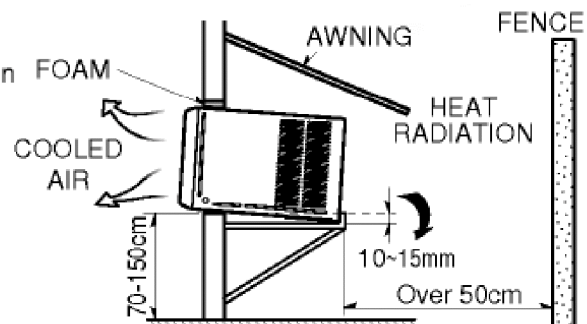

**CAUTION:** All side louvers of the cabinet must remain exposed to the outside of the structure.

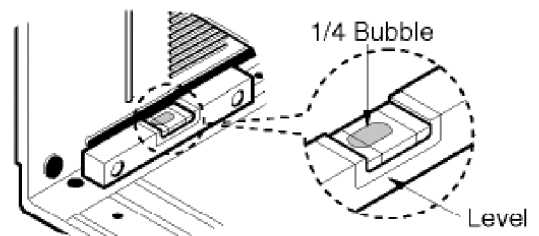

## Remove the Air Conditioner From the Case

1. Remove the 2 shipping screws from the back of the case.
2. Remove the 2 screws on each side of the case. Keep these for later use.
3. Slide the air conditioner from the case by gripping the base pan handle and pulling forward while bracing the case.
4. Before installing the Air Conditioner back into the case, remove the white styrofoam shipping block from the compressor (Applicable for some models).

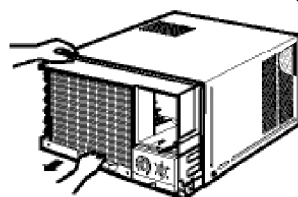
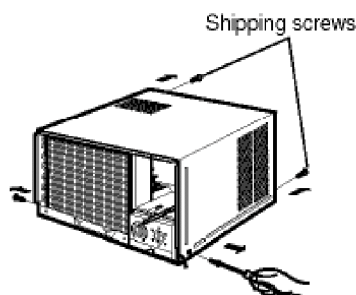

## Install the Air Conditioner in the Case

- Slide the air conditioner into the case.  
Reinstall the 2 screws removed earlier on each side of the case.

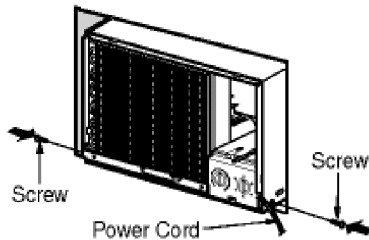

**CAUTION:** The power cord must be connected to an independent circuit. The green wire must be grounded.

- Stuff the foam between the top of the unit and the wall to prevent air and insects from getting into the room.

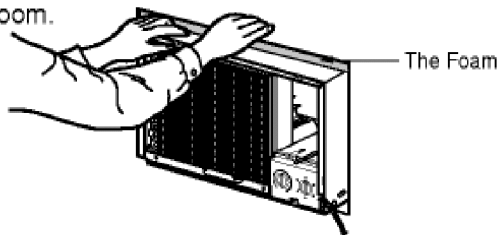

- Before installing the front grille, pull out the vent control lever located above the unit control knobs, as shown.

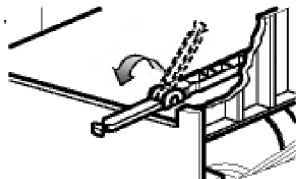

- Attach the front grille to the case by inserting the tabs on the grille into the slots on the front of the case. Push the grille in until it snaps into place.

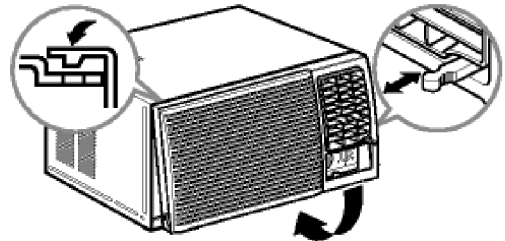

When you detach the front grille from the case, push the grille to your right side and pull it toward you.

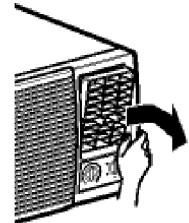

- Lift the inlet grille and secure the front grille with a screw. Lower the inlet grille into place.

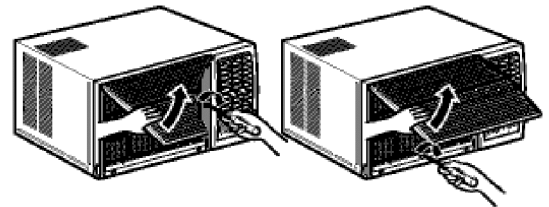

## Use the Reversible Inlet Grille

- If you want to pull out the filter upward, open the inlet grille slightly.  
Turn inside out the front grille.  
Disassemble the inlet grille from the front grille with separating the hinged part by inserting a "—" type screw-driver tip.  
Rotate the inlet grille 180 degrees and insert the hooks into the lower holes of front grille.  
Then, insert the filter
- If you want to pull out the filter downward, use the reversible inlet grille without change. (The grille is already assembled for that way.)



**Troubleshooting Tips**

Save time and money! Review the chart below first and you may not need to call for service.

**Normal Operation**

- You may hear a pinging noise caused by water being picked up and thrown against the condenser on rainy days or when the humidity is high. This design feature helps remove moisture and improve efficiency.
- You may hear the thermostat click when the compressor cycles on and off.
- Water will collect in the base pan during high humidity or on rainy days. The water may overflow and drip from the outdoor side of the unit.
- The fan may run even when the compressor does not.

**Abnormal Operation**

<i>Problem</i>	<i>Possible Causes</i>	<i>What To Do</i>
<b>Air conditioner does not start</b>	■ The air conditioner is unplugged.	• Make sure the air conditioner plug is pushed completely into the outlet.
	■ The fuse is blown/circuit breaker is tripped.	• Check the house fuse/circuit breaker box and replace the fuse or reset the breaker.
	■ Power failure.	• If power failure occurs, push power button to <b>OFF</b> . When power is restored, wait 3 minutes to restart the air conditioner to prevent tripping of the compressor overload.
<b>Air conditioner does not cool as it should</b>	■ Airflow is restricted.	• Make sure there are no curtains, blinds, or furniture blocking the front of the air conditioner.
	■ The thermostat may not be set high enough.	• Turn the knob to a higher setting. The highest setting provides maximum cooling.
	■ TEMP Control set too higher number.	• Set the TEMP control to a lower number.
	■ The air filter is dirty.	• Clean the filter at least every 2 weeks. See the operating instructions section.
	■ The room may have been hot.	• When the air conditioner is first turned on you need to allow time for the room to cool down.
	■ Cold air is escaping.	• Check for open furnace floor registers and cold air returns. • Set the air conditioner's vent to the closed position.
<b>Air conditioner freezing up</b>	■ Cooling coils have iced up.	• See Air Conditioner Freezing Up below.
	■ Ice blocks the air flow and stops the air conditioner from cooling the room.	• Set the mode control at <b>MED</b> fan or high cool with the thermostat at 1 or 2 (Left side) • Set the mode control at <b>HIGH</b> fan or high cool with the high temperature



# Nota





P/No.: 3828A20877B

Printed in China

After reading this manual, keep it in a place easily accessible to the user for future reference.

## Free Manuals Download Website

<http://myh66.com>

<http://usermanuals.us>

<http://www.somanuals.com>

<http://www.4manuals.cc>

<http://www.manual-lib.com>

<http://www.404manual.com>

<http://www.luxmanual.com>

<http://aubethermostatmanual.com>

Golf course search by state

<http://golfingnear.com>

Email search by domain

<http://emailbydomain.com>

Auto manuals search

<http://auto.somanuals.com>

TV manuals search

<http://tv.somanuals.com>