



LG

Life's Good

USB Plus

(Go to page 8)

XTS & XTS Pro

(Go to page 15)

Virtual Sound

(Go to page 15)

FM & AM Tuner Function

(Go to page 19)

DVD/CD RECEIVER OWNER'S MANUAL

Model : HT302SD, HT302SD-A8
SH32SD-SZ, SH32SD-WZ



Before connecting, operating or adjusting this product,
please read this instruction booklet carefully and completely.

P/No. : MFL62665902(00)

Dear Customer

Thank You for Purchasing the LG DVD Player. After going through the instruction manual , you will be able to enjoy all the features and functions of the Product .



CAUTION : TO REDUCE THE RISK OF ELECTRIC SHOCK DO NOT REMOVE COVER (OR BACK) NO USER-SERVICEABLE PARTS INSIDE REFER SERVICING TO QUALIFIED SERVICE PERSONNEL.

 This lightning flash with arrowhead symbol within an equilateral triangle is intended to alert the user to the presence of uninsulated dangerous voltage within the product's enclosure that may be of sufficient magnitude to constitute a risk of electric shock to persons.

 The exclamation point within an equilateral triangle is intended to alert the user to the presence of important operating and maintenance (servicing) instructions in the literature accompanying the product.

WARNING : TO PREVENT FIRE OR ELECTRIC SHOCK HAZARD, DO NOT EXPOSE THIS PRODUCT TO RAIN OR MOISTURE.

WARNING : Do not install this equipment in a confined space such as a book case or similar unit.

CAUTION: Do not block any ventilation openings. Install in accordance with the manufacturer's instructions.

Slots and openings in the cabinet are provided for ventilation and to ensure reliable operation of the product and to protect it from over heating.

The openings should be never be blocked by placing the product on a bed, sofa, rug or other similar surface. This product should not be placed in a built-in installation such as a bookcase or rack unless proper ventilation is provided or the manufacturer's instruction has been adhered to.

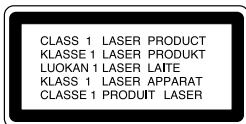

CAUTION : This product employs a Laser System.

To ensure proper use of this product, please read this owner's manual carefully and retain it for future reference. Shall the unit require maintenance, contact an authorized service center.

Use of controls, adjustments or the performance of procedures other than those specified herein may result in hazardous radiation exposure.

To prevent direct exposure to laser beam, do not try to open the enclosure. Visible laser radiation when open. **DO NOT STARE INTO BEAM.**

CAUTION : The apparatus shall not be exposed to water (dripping or splashing) and no objects filled with liquids, such as vases, shall be placed on the apparatus.

CAUTION : concerning the Power Cord

Most appliances recommend they be placed upon a dedicated circuit ; That is, a single outlet circuit which powers only that appliance and has no additional outlets or branch circuits. Check the specification page of this owner's manual to be certain.

Do not overload wall outlets. Overloaded wall outlets, loose or damaged wall outlets, extension cords, frayed power cords, or damaged or cracked wire insulation are dangerous. Any of these conditions could result in electric shock or fire. Periodically examine the cord of your appliance, and if its appearance indicates damage or deterioration, unplug it, discontinue use of the appliance, and have the cord replaced with an exact replacement part by an authorized service center.

Protect the power cord from physical or mechanical abuse, such as being twisted, kinked, pinched, closed in a door, or walked upon. Pay particular attention to plugs, wall outlets, and the point where the cord exits the appliance.

To disconnect power from the mains, pull out the mains cord plug. When installing the product, ensure that the plug is easily accessible.

Note: The marking of product shall be on the exterior of the apparatus.

Welcome to your new DVD Receiver

Contents



Introduction	5
Maintenance & Service	5
Main Unit	6
Remote Control	7
Hooking up the Unit (Audio & Video)	8
USB Equipment Connection	8
Antenna Connection	9
5.1 Channel Speaker System Configuration	9
Initial Settings	10
Language	10
Display	10
Audio	11
Lock (Parental Control)	11
Others	14



Displaying Disc Information	12
Operations	13
Equalizer Effect	15
XTS/XTS Pro	15
Virtual Sound	15
Sound Mode	15
Other Operations	15
Playing a Disc or File	16
Playing a DivX Movie File	17
Programmed Playback	18
Viewing a JPEG File	18
Listening to Music from External Device	19
Presetting the Radio Stations	19
Listening to the Radio	19
Using an USB Device	20
Types of Playable Discs	21



Troubleshooting	12-13
Language Codes	22
Area Codes	22
Specifications	22

Introduction

Before Use

To ensure proper use of this product, please read this owner's manual carefully and retain it for future reference.

This manual provides information on the operation and maintenance of your DVD player. Should the unit require service, contact an authorized service location.

About the Symbol Display

"" may appear on your TV display during operation and indicates that the function explained in this owner's manual is not available on that specific DVD video disc.

Symbol Used in this Manual

 The lightning flash symbol alerts you to the presence of dangerous voltage within the product enclosure that may constitute a risk of electric shock.

 The exclamation point alerts you to the presence of important operating and maintenance / servicing instructions.

 Indicates hazards likely to cause harm to the unit itself or other material damage.









Note :

Indicates special notes and operating features.

Tip :

Indicates tips and hints for making the task easier.

A section whose title has one of the following symbols is applicable only to the disc represented by the symbol.

-  All discs listed below
-  DVD and finalized DVD \pm R/RW
-  Video CDs
-  Audio CDs
-  MP3 files
-  WMA files
-  DivX files
-  CD-G Discs

Notes on Discs

Handling Discs

Do not touch the playback side of the disc. Hold the disc by the edges so that fingerprints do not get on the surface. Never stick paper or tape on the disc.



" Always keep a disc inside the Receiver to prevent optical lens damage due to dust "

Storing Discs

After playing, store the disc in its case. Do not expose the disc to direct sunlight or sources of heat and never leave it in a parked car exposed to direct sunlight.

Cleaning Discs

Fingerprints and dust on the disc can cause poor picture quality and sound distortion. Before playing, clean the disc with a clean cloth. Wipe the disc from the center out.

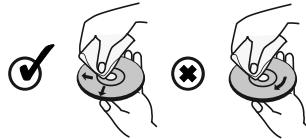

Do not use strong solvents such as alcohol, benzene, thinner, commercially available cleaners, or anti-static spray intended for older vinyl records.

Maintenance and Service

Refer to the information in this chapter before contacting a service technician.

Handling the Unit

When shipping the unit

Please save the original shipping carton and packing materials. If you need to ship the unit, for maximum protection, re-pack the unit as it was originally packed at the factory. It is recommended to remove any disc from the player while moving the set

Keeping the exterior surfaces clean

- Do not use volatile liquids such as insecticide spray near the unit.
- Do not leave rubber or plastic products in contact with the unit for a long period of time. since they leave marks on the surface.

Cleaning the unit

To clean the player, use a soft, dry cloth. If the surfaces are extremely dirty, use a soft cloth lightly moistened with a mild detergent solution.

Do not use strong solvents such as alcohol, benzene, or thinner, as these might damage the surface of the unit.

Maintaining the Unit

The DVD /CD Receiver is a high-tech, precision device. If the optical pick-up lens and disc drive parts are dirty or worn, the picture quality could be diminished.

Depending on the operating environment, regular inspection and maintenance are recommended after every 1,000 hours of use.

For details, please contact your nearest authorized service center.

Front Panel/Rear Panel

MIC

Connect a microphone to MIC Port.

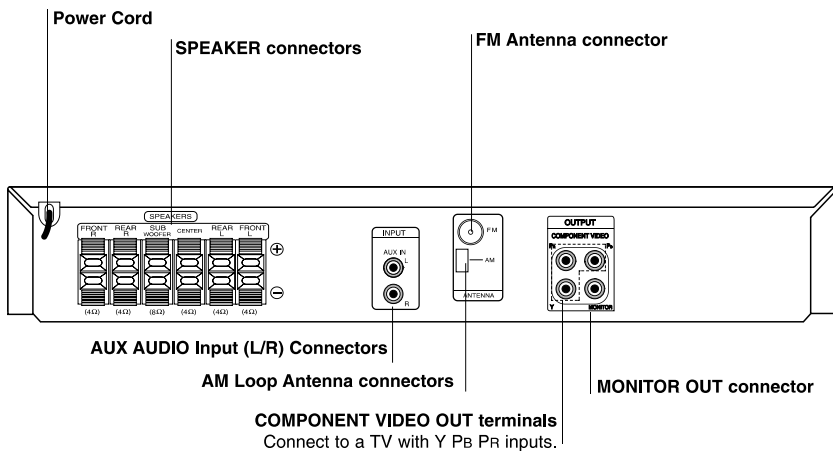
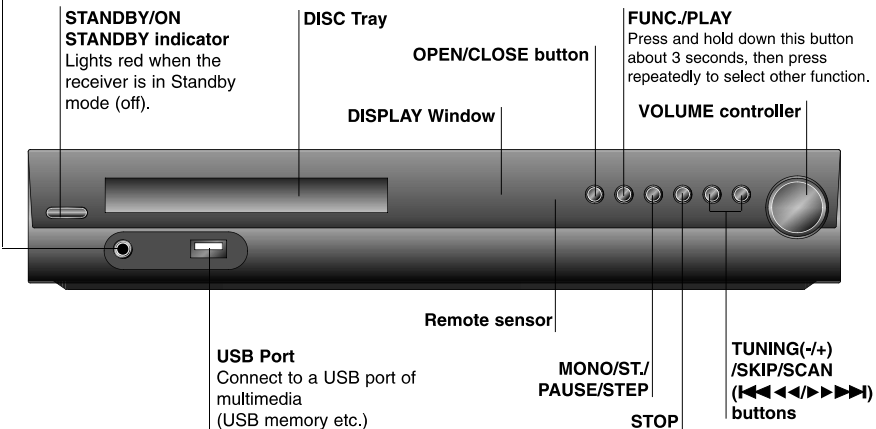

Do not touch the inner pins of the jacks on the rear panel. Electrostatic discharge may cause permanent damage to the unit.

Remote Control

- POWER DVD**
Selects the output source (CD/DVD)
- BAND**
Selects the System's tuner (FM and AM bands)
- 0-9 numerical buttons**
Selects a service, programme number directly or selects numbered options in a menu.
- XTS Pro**
Supplies more natural and realistic sound.
- RETURN**
Supplies great sound effect.
- RETURN**
Removes the setup menu.
- AUDIO**
Selects an audio language (DVD) or an audio channel (CD).
- SOUND**
Selects the sound mode.
- SETUP**
Accesses or removes setup menu .
- MENU**
Accesses the menu on a DVD disc.
- SCAN/SLOW(◀◀▶▶)**
Searches backward or forward.
Reverse/ Forward slow playback.
- REVERSE/FORWARD SKIP**
(◀◀▶▶)
- STOP (■)**
- PAUSE/STEP (||)**
- PLAY (▶)**
- REPEAT**
Repeats chapter, track, title, all
- REPEAT A-B**
Repeats sequence.
- ECHO VOL.(▼/▲)**
Adjusts echo volume
- MIC VOL.(▼/▲)**
Adjusts microphone volume

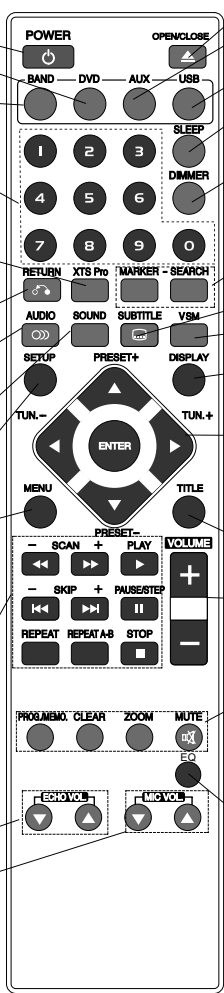

- OPEN/CLOSE (⏏)**
Opens and closes the disc tray.
- AUX**
Selects input source.
- USB**
Plays the multimedia files.
- SLEEP**
Sets the System to turn off automatically at a specified time.
- DIMMER**
Changes brightness of the display window on the front panel during in power-on status.
- MARKER**
Marks a point during playback.
- SEARCH**
Displays MARKER SEARCH menu.
- SUBTITLE**
Selects a subtitle language (DVD).
- VSM**
Selects the VIRTUAL sound
- DISPLAY**
Accesses On-Screen display.
- ◀▶▲▼ (left/right/up/down)**
Selects an option in the menu.
- ENTER**
Acknowledges the menu selection.
- PRESET(▲▼):**
Selects programme of Radio.
- TUN.(-/+)** (◀▶):
Tunes in the desired radio station.
- TITLE**
Displays the disc's Title menu, if available.
- VOLUME (+/-)**
Adjusts speaker volume.
- PROG.**
Accesses or removes Program menu.
- MEMO.**
Enter a radio station's frequency into the tuner.
- CLEAR**
Removes a track number on the program menu or a mark on the MARKER SEARCH menu.
- MUTE**
- ZOOM**
- EQ**
You Can Choose 8 Fixed Sound Impressions.

Remote Control Operation Range

- Point the remote control at the remote sensor and press the buttons.
- **Distance:** About 23 ft (7 m) from the front of the remote sensor
- **Angle:** About 30° in each direction in front of the remote sensor

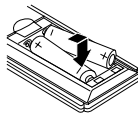

Remote control battery installation

Remove the battery cover on the rear of the remote control, and insert two R03 (size AAA) batteries with + and - aligned correctly.

⚠ Caution

Do not mix old and new batteries. Never mix different types of batteries (standard, alkaline, etc.).

Hooking up the unit

- 1** Connect jacks on the unit and your TV (DVD player or Digital Device etc.) using the cables. Check the jacks of your TV, and choose the **A**, **B** or **C** connection. Picture quality improves in order from **A** to **B**.

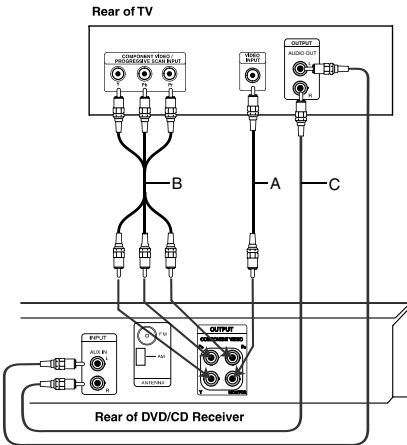
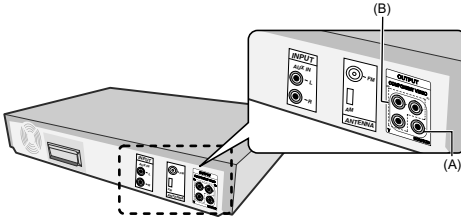

Video Out connection (A)

Connect the VIDEO OUTPUT (MONITOR) jack on the unit to the corresponding input jack on your TV using a Video cable.

Component Video connection (B)

Connect the COMPONENT VIDEO (PROGRESSIVE SCAN) OUTPUT jacks on the unit to the corresponding input jacks on your TV using a Y PB PR cable.

Audio In connection

The unit's Audio jacks are colour coded (red for right audio and white for left audio). If your TV has only one output for audio (mono), connect it to the left (white) audio jack on the unit.

AM FM connection

AM - Connect the AM loop aerial to the DVD receiver. FM - Connect the FM aerial. The reception will be its best when the two loose ends of the aerial are in a straight and horizontal line.

USB Equipment Connection

Connect the USB port of a USB Memory (or MP3 player, etc.) to the USB port on the front of the unit.

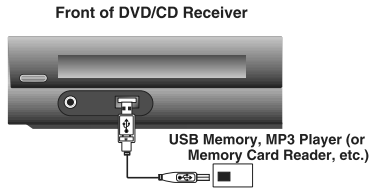

Removing the USB Device from the unit

1. Choose a different function mode or press STOP (■) twice in a row.
2. Remove the USB device from the unit.

Notes:

- Don't extract the USB device while operating.
- Music files (MP3/WMA), image files (JPEG) and Video files (.avi) can be played.
- This unit can not use a USB HUB.

Antenna Connection

Connect the supplied FM/AM antenna for listening to the radio.

- Connect the AM Loop aerial to the AM aerial connector.
- Connect the FM Wire aerial to the FM aerial connector.

Notes:

- To prevent noise pickup, keep the AM Loop aerial away from the DVD/CD Receiver and other components.
- Be sure to fully extend the FM wire aerial.
- After connecting the FM Wire aerial, keep it as horizontal as possible.

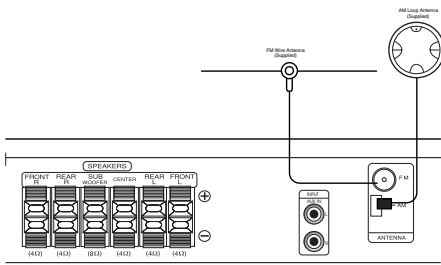

5.1 Channel Speaker System Configuration

Assuming you are centered in the middle of your couch, facing your TV display and center-channel speaker at 0 degree, then your left and right main front speakers should be within a 22 to 30 degree angle to each side, viewed from your seat.

The main left and right surrounds should be to the respective sides of the listening area, above ear level if possible (ideally 2 feet or more) at an angle of 90 to 110 degrees from the front center.

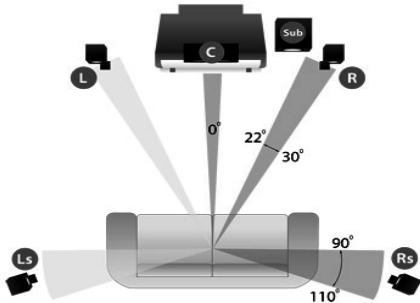

Function Selection

You can select the different functions by pressing the different function keys in the remote as follows:

Band (for FM & AM), DVD/CD, AUX, USB)

Speaker System Connection

Connect the speaker cords to the speaker terminals. To obtain the best possible surround sound, adjust the speaker parameters (volume, distance, etc.).

- Be sure to match the speaker cable to the appropriate terminal on the components: + to + and - to -. If the cables are reversed, the sound will be distorted and will lack base.
- If you use front speakers with low maximum input rating, adjust the volume carefully to avoid excessive output on the speakers.

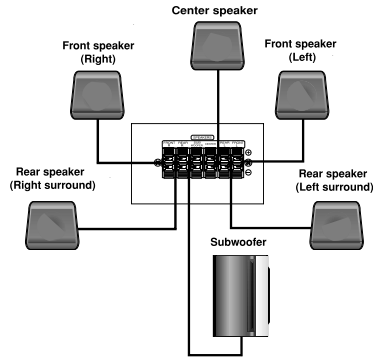

Be careful of the following

Be careful to make sure children do not put their hands or any objects into the *speaker duct.

*Speaker duct: A hall for plentiful bass sound on speaker cabinet(enclosure). Use the rear speaker at least 30 CM away from either TV screen or PC monitor.

Initial Settings

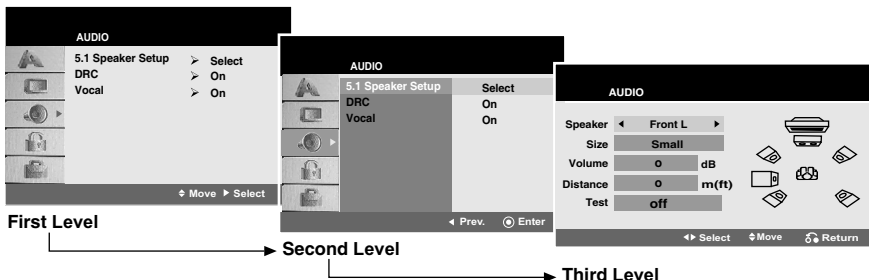

Initial Settings

By using the Setup menu, you can make various adjustments to items such as picture and sound. You can also set a language for the subtitles and the Setup menu, among other things. For details on each Setup menu item, see the pages 9 to 15.

To display and exit the Menu :

Press **SETUP** to display the menu. A second press of **SETUP** will take you back to initial screen.

To go to the next level :

Press **▶** on the remote control.

To go back to the previous level :

Press **◀** on the remote control.

General Operation

Adjust the settings

	ON REMOTE
1 Display setup menu:	SETUP
2 Select a desired option on the first level:	▲▼
3 Move to second level:	▶
4 Select a desired option on the second level:	▲▼
5 Move to third level:	▶
6 Change the setting:	▲▼ / ENTER

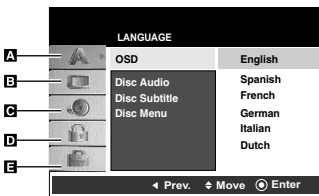

A LANGUAGE

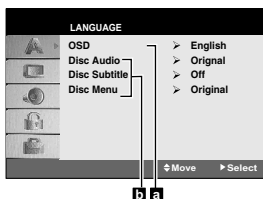

a OSD

Select a language for the Setup menu and then on-screen display.

b Disc Audio / Subtitle / Menu

Select the language you prefer for the audio track (disc audio), subtitles, and the disc menu.

Original - Refers to the original language in which the disc was recorded.

Other - To select another language, press numeric buttons and then **ENTER** to enter the corresponding 4-digit number according to the language code list on the page 23. If you enter the wrong language code, press **CLEAR**.

Disc Subtitle - Refer to the turn ON/OFF subtitle.

B DISPLAY

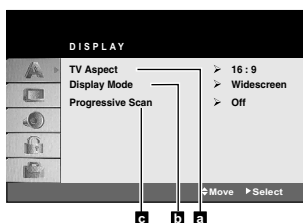

a TV Aspect

4:3 - Select when a standard 4:3 TV is connected.

16:9 - Select when a 16:9 wide TV is connected.

b Display Mode

The Display Mode setting works only when the TV Aspect mode is set to "4:3".

Letterbox - Displays a wide picture with black bands on the upper and lower portions of the screen.

Panscan - Automatically displays the wide picture on the entire screen and cuts off the portions that do not fit.

c Progressive Scan

Progressive Scan Video provides the highest quality pictures with less flickering.

If you are using the **COMPONENT VIDEO** OUT jacks, but are connecting the receiver to a standard (analog) television, set Progressive Scan to Off.

If you are using the Component Video jacks for connection to a TV or monitor that is compatible with a progressive scan signal, set Progressive Scan to On.

To Turn ON progressive scan:

Connect component out of the DVD/CD Receiver to the input of your monitor / television, set your television or monitor to Component Input.

1. Select "Progressive Scan" on the DISPLAY menu then press **▶**.
2. Select "On" using the **▲/▼** buttons.
3. Pressing ENTER will set the player to Progressive scan mode.

Caution:

Once the setting for progressive scan output is entered, an image will only be visible on a progressive scan compatible TV or monitor. If you set Progressive Scan to On in error, you must reset the unit. First, remove the disc in the DVD/CD Receiver. Next, press STOP on the remote control (■) and hold it for five seconds before releasing it. The video output will be restored to the standard setting, and a picture will once again be visible on a conventional analog TV or monitor

C AUDIO

Each DVD disc has a variety of audio output options. Set the player's AUDIO options according to the type of audio system you use.

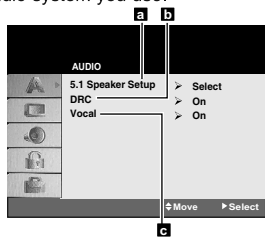

5.1 Speaker Setup

Make the following settings for the built-in 5.1 channel surround decoder.

1. Press ENTER and 5.1 Speaker Setup menu appears.
2. Use **◀/▶** to select the desired speaker.
3. Adjust options using **▲/▼/◀/▶** buttons.
4. Press ENTER to confirm your selection. Returns to the previous menu.

Speaker Selection

Speaker selection Select a speaker that you want to adjust. [Front speaker (Front L), Front speaker (Front R), Center Speaker (Center), Subwoofer (SubWoof), Rear speaker (Rear L), Rear speaker (Rear R)]

Note:

Certain speaker settings are prohibited by the DolbyDigital licensing agreement.

Size

Since the speaker settings are fixed, you cannot change the settings.

Volume

Press **◀/▶** to adjust the output level of the selected speaker. (-5dB ~ 5dB)

Distance

If you connected speakers to your DVD/CD Receiver, setting the Distance lets the speakers know how far the sound has to travel to reach your set listening point. This allows the sound from each speaker to reach the listener at the same time.

Press **◀/▶** to adjust the Distance of the selected speaker. (You can't adjust front/Woofers speakers)

Test

Press **◀/▶** to test the signals of each speaker. Adjust the volume to match the volume of test signals memorized in the system.

Front Left (L) Center Front Right (R)
Rear Right (R) Rear Left

DRC (Dynamic Range Control)

With the DVD*1 format, you can hear a program's sound track in the most accurate and realistic presentation, thanks to digital audio technology. However, you may wish to compress the dynamic range of the audio output (the difference between the loudest sounds and the quietest ones). Then, you may listen to a movie at a lower volume without losing clarity of sound. Set DRC to On for this effect. *1:Dolby Digital only

Vocal

Set to On only when a multi-channel karaoke DVD is playing. The karaoke channels on the disc mix into normal stereo sound.

D LOCK(Parental Control)

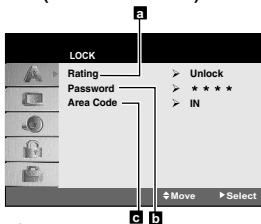

Rating

Blocks playback of rated DVDs based on their contents. Not all discs are rated.

1. Select "Rating" on the LOCK menu then press **▶**.
2. To access the LOCK options, you must input the password you have created. If you have not yet entered password, you are prompted to do so. Input a password and press ENTER. Enter it again and press ENTER to verify. If you make a mistake before pressing ENTER, press CLEAR.
3. Select a rating from 1 to 8 using the **▲/▼** buttons.

Rating 1-8: Rating one (1) has the most restrictions and rating eight (8) is the least restrictive.

Continued on page No. 15

OSD Initial language settings

During the first use of this unit, the initial language setup menu appears on your TV screen. You must complete initial language selection before using the unit. English will be selected as the initial language.

	ON REMOTE
1 Turn the power on : The language list appears	POWER
2 Select the language :	▲ ▼ < >
3 Press :	ENTER
4 To confirm press :	< > and ENTER

Displaying Disc Information on-screen

Displaying Disc Information

	ON REMOTE
1 Press DISPLAY:	DISPLAY
2 Select a item:	▲ ▼
3 Adjust the Display menu settings:	◀ ▶ / ENTER
4 To return the exit:	DISPLAY

Displaying Disc Information - more you can do

You can select an item by pressing pressing < >.

188 # Current title (or track/ file) number/ total number of titles (or tracks/ files)	Playback Status/ Restrictions	Title Repeat title
426 # Current chapter number/ total number of chapters	A • B Repeat sequence	1 / 0 Enter a Marker
-1:11-- Elapsed playing time	MARKER SEARCH Marker Search menu	Resume play from this point
1 ENG DDD 3/2,1CH Selected audio language or channel	Action prohibited or not available	
1 KOR Selected subtitle		
10 Selected angle/ total number of angles		
NORMAL Selected sound mode		

Playing a Disc or file

	ON REMOTE
1 Insert a disc on unit :	▲ OPEN/CLOSE
2 Select a DVD/CD :	FUNCTION
3 Adjust the menu settings : or Select a file from the menu :	▲ ▼ < > ▲ ▼
4 Start the Disc playing :	▶ PLAY
5 To stop the Disc playing :	■ STOP

Example: On-Screen Display during playing DVD Video

Items	Selection Method
Title Number 1 / 3 >	◀ / ▶, Numbers ENTER
Chapter Number 1 / 12 >	◀ / ▶, Numbers ENTER
Time search 0:20:09	Numbers, ENTER
Audio language and Digital Audio Output mode 1 ENG DDD 3/2,1CH	◀ / ▶ or AUDIO
Subtitle language 1 ENG	◀ / ▶ or SUBTITLE
Angle 1 / 3 >	◀ / ▶ or ANGLE

Example: On-Screen Display during playing VCD

Items	Selection Method
Track Number (or PBC mode) 1 / 3 >	◀ / ▶, Numbers ENTER
Time search 0:20:09	Numbers ENTER
Audio Channel Stereo	◀ / ▶ or AUDIO

Example: On-Screen Display during playing divx movie disc*

Items	Selection Method
Track Number 1 / 3 >	◀ / ▶, Numbers ENTER
Time search 0:20:09	Numbers, ENTER
Audio Language and Digital Audio Output mode 1 ENG 2/0 CH	◀ / ▶ or AUDIO
Subtitle language 1 ENG	◀ / ▶ or SUBTITLE

Symptom

No power	The power cord is disconnected.
The power is on, but the DVD/CD Receiver does not work.	No disc is inserted.
No Picture	The TV is not set to receive DVD signal output. The video cable is not connected securely. The connected TV power is turned off.
There is no sound or only a very low-level sound is heard.	The equipment connected with the audio cable is not set to receive DVD signal output The audio cables are not connected securely. The Power of the equipment connected with the audio cable is turned off. The audio connecting cable is damaged.
The Playback picture is poor.	The disc is dirty.
The DVD/CD Receiver does not start playback.	No disc is inserted. An unplayable disc is inserted. The disc is placed upside down. The disc is not Placed within the guide. The disc is dirty. A menu is on the TV screen. The Rating level is set. The disc is dirty.
Loud hum or noise is heard.	The speakers and components are connected poorly. The DVD/CD Receiver is located too close to the TV.
Radio Stations cannot be tuned in.	The antenna is positioned or connected poorly. The signal strength of the stations is too weak (when tuning in with automatic tuning). No stations have been preset or preset stations have been cleared (when tuning by scanning preset stations).
The Remote control does not work properly	The remote control is not pointed at the remote sensor of the DVD/CD Receiver. The remote control is too far from the DVD/CD Receiver. There is an obstacle in the path of the remote control and the DVD/CD Receiver. The batteries in the remote control are flat.
The front panel display is too dim.	Nothing is displayed on the front panel display.

Cause

Operations

General features

Buttons	Operations	Discs
OPEN / CLOSE (▲)	Opens or closes the disc tray.	ALL
PAUSE ()	During playback, press to pause playback. Press repeatedly to play Frame-by-Frame.	ALL DVD VCD DivX
SKIP (I◀◀ / ▶▶I)	During playback, press SKIP (I◀◀ or ▶▶I) to go to the next chapter/track or to return to the beginning of the current chapter/track. Press SKIP I◀◀ twice briefly to step back to the previous chapter/track.	ALL
SCAN (◀◀ / ▶▶)	During playback, press SCAN (◀◀ or ▶▶) repeatedly to select the required scan speed. DVD, Divx disc: 6 steps, Video CD: 5 steps, MP3, WMA, Audio CD, 3 steps	ALL
REPEAT	During playback, press REPEAT repeatedly to select a desired repeat mode. DVD Video discs: Chapter/Title/Off Video CD, Audio CD, DivX/MP3/WMA discs: Track/All/Off	ALL
RETURN (↶)	Press to move backwards in the menu or exit the menu.	
TITLE	If the current DVD title has a menu, the title menu appears on the screen. Otherwise, the disc menu may appear.	DVD
DVD MENU	The disc menu appears on the screen.	DVD
(SUBTITLE)	During playback, press SUBTITLE repeatedly to select a desired subtitle language.	DVD DivX
REPEAT A-B	During playback, press REPEAT A-B to select a point A and a point B and repeats a sequence from point A(Starting point) to point B (End point).	DVD VCD
SLOW	In the pause mode, press SLOW (◀◀ or ▶▶) to select required speed. DVD : ◀◀ (1/2, 1/4, 1/8, 1/16) or ▶▶ (1/2, 1/4, 1/8, 1/16) Video CD : ▶▶ (1/2, 1/4, 1/8, 1/16)	DVD VCD

Correction

- Plug the power cord securely into the wall outlet.
- Insert a disc. (Check that the DVD or, audio CD Indicator in the DVD display is lit.)
- Connect the video cables securely to both the TV and DVD Receiver.
- Select the appropriate video input mode on the TV so the picture from the DVD/CD Receiver appears on the TV Screen.
- Connect the video cable into the jacks securely.
- Turn on the TV.
- Select the Correct input mode of the audio receiver so you can hear the sound from the DVD/CD Receiver.
- Connect the audio cable into the jacks securely.
- Turn on the equipment connected with the audio cable.
- Replace it with new one.
- Clean the Disc.
- Insert a disc. (Check that the DVD, or audio CD indicator in the DVD display is lit.)
- Insert a playable disc. (Check the disc type, colour system and Regional code.)
- Place the disc with the playback side down.
- Place the disc on the disc tray correctly inside the guide.
- Clean the disc.
- Press the SETUP button to turn off the menu screen.
- Cancel the Rating function or change the rating level.
- Clean the disc.
- Connect the Speakers and components securely.
- Move your TV away from the audio components.
- Connect the antenna securely
- Adjust the antennas and connect an external antenna if necessary.
- Tune in the station manually.
- Preset the stations (page 19).
- Point the remote control at the remote sensor of the DVD/CD Receiver.
- Use the remote control within about 23 ft (7 m).
- Remove the obstacle.
- Replace the batteries with new ones.
- Press DIMMER on the remote control.

Unlock

If you select unlock, parental control is not active and the disc plays in full.

Notes:

If you set a rating for the player, all disc scenes with the same rating or lower are played. Higher rated scenes are not played unless an alternate scene is available on the disc. The alternative must have the same rating or a lower one. If no suitable alternative is found, playback stops. You must enter the 4-digit password or change the rating level in order to play the disc.

- Press ENTER to confirm your rating selection, then press SETUP to exit the menu.

b Password

You can enter or change password.

- Select Password on the LOCK menu and then press ►.

- To make a new password:

Press ENTER when the "New" option is highlighted. Enter a new four digit password using the numerical buttons then press ENTER. Enter the password again to verify.

To change the password:

Press ENTER when the "Change" option is highlighted. Enter a current password using the numbered buttons then press ENTER. Enter a new password using the numbered buttons then press ENTER. Enter the password again to verify.

- Press SETUP to exit the menu.

If you forget your password

If you forget your password, you can clear it using the following steps:

- Press SETUP to display the Setup menu.
- Input the 6-digit number "210499" and the security code is cleared.

c Area Code

Enter the code of the area whose standards were used to rate the DVD video disc, based on the list on page 23.

- Select "Area Code" on the LOCK menu then press ►.
- Follow the step 2 as shown on page No 10 (Rating).
- Select the first character using ▼/▲ buttons.
- Press ENTER and select the second character using ▼/▲ buttons.
- Press ENTER to confirm your Area code selection.

E OTHERS

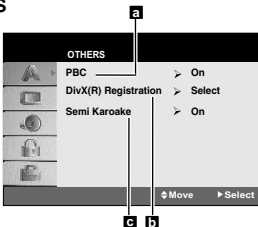

a PBC

Set Playback Control (PBC) to On or Off.

On: Video CDs with PBC are played according to the PBC.

Off: Video CDs with PBC are played in the same way as Audio CDs.

b DivX(R) DivX

We provide you the DivX® VOD (Video On Demand) registration code that allows you to rent and purchase videos based on the DivX® VOD service. For more information, visit www.divx.com/vod.

- Select "DivX(R) VOD" option and then press ►.
- Press ENTER while "Select" is selected and the registration code will appear.
Use the registration code to purchase or rent the videos from DivX® VOD service at www.divx.com/vod. Follow the instructions and download the video onto a disc for playback on this unit.
- Press ENTER to exit.



The Registration code is used for VOD (Video-On-Demand) service agent. You can purchase or rent an encrypt movie file.

Notes:

If you rent the DivX VOD file, it has several options of viewing limits as shown below.

- Display the number which you can watch the file.

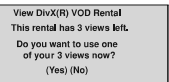

- The rental has been expired.



- Display the authorization error.

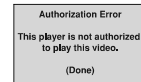

b Semi Karaoke

When a chapter/ title / track is fully finished, this function shows the score in the screen with a fanfare sound.

Semi Karaoke on :

- Turn the "Semi Karaoke" function on.
When you finished singing a score will appear on the screen.

Semi Karaoke off :

- Turn the "Semi Karaoke" function off. Fanfare and score do not appears on the screen

Available discs for the Semi Karaoke function:

- DVD discs
- DVD Karaoke Discs
- VCD discs with more than 2 tracks

Notes :

- This function operate on the DVD/CD mode.
- The Semi Karaoke function is available only when a micro phone is connected.
- Watching movies, "off" the Semi Karaoke or enjoy it without connecting the MIC at the SETUP menu if the fanfare or score appears during changing a chapter.

EQUALIZER EFFECT

You can choose 8 fixed sound impressions and adjust the Bass, MIDDLE and TREBLE.

- You can select a desired sound mode by using EQ button on the remote control.

When you want to change a sound mode press the EQ button repeatedly with in 3 seconds.

Each time you press the button the setting changes in the display window as shown below.

NORMAL (NORMAL) → India (INDIA) → USr EQ (User EQ) → POP (POP) → CLASS (CLASSIC) → ROCK (ROCK) → DRAMA (DRAMA) → JAZZ (JAZZ) → NORMAL (NORMAL)...

- You can set the BASS, Middle and TREBLE on the USER EQ mode.

1. Select the USER EQ mode by using EQ button. "USr EQ (USER EQ)" will be displayed in the display window.
2. Press the ENTER button on the remote control when "USr EQ (USER EQ)" is displayed in the display window. "U_B0 (BASS 0)" will be displayed in the display window.
3. Select the BASS, MIDDLE OR TREBLE on you want by pressing the TUN. (-/+) buttons on the remote control.
4. Press the PRESET (+/-) button on the remote control to set the sound level you want. (-5~+5, MAX steps)
- 5- Repeat the 3-4 steps as above.
- 6- When the sound level is completed, press the ENTER button on the remote control.

XTS/XTS Pro

Each time you press **XTS Pro** the setting changes in the following order.

On (XTS) → NORMAL → Pro (XTS-P)...

- XTS-P
The unique sound quality of the LG Technology creates the optimum sound for you to play the perfect playback of the original sound and to feel the living sound source.
 - XTS
When playing the movie with the weak bass sound relatively to the general music, it enforces the sense of sound at woofer for you to satisfy with. In the mode of 2 CH BYPASS, It creates the high display effect by playing the sound source via the rear speakers same as the front speakers.
- Note:**
The XTS mode is temporarily disabled when changing from 2.1 CH to 5.1 CH and it is enabled when changing it to 2.1 CH.
- NORMAL
XTS-P and XTS modes turn off.

VIRTUAL sound

Press **VSM** to set the VIRTUAL sound.

Source	Display	Effect
2.1 ch.	vir	3D STEREO
5.1 ch	vir	Multichannel sound

● 3D STEREO

Realtime 3D positioned sound rendering technology with stereo sources, optimized for stereo speakers. Listeners may experience amazing virtual surround effects with their own multimedia players.

● Multichannel sound

The Multichannel sound changes the sound in 5.1 ch into a virtual one in the 10.1 ch so that it provides such a feeling that you listen to the sound simultaneously from the right and left speakers and center speaker.

Sound Mode

You can enjoy surround sound simply by selecting one of the pre-programmed sound fields according to the program you want to listen to (2 ch. sound only).

Press SOUND button repeatedly.

bPASS(BYPASS) → OnStr(ON STAGE)
→STU(STUDIO) → CLUb(CLUB) → HALL(HALL) → THEA(THEATER1) → Chur(CHURCH) → PL II-1(MOVIE) → PL II-2(MUSIC) → PL II-3(MTRX) → bPASS(BYPASS)...

Note:

Initial sound mode is BYPASS.

Other operations

Sleep Timer Setting

You can set the DVD/CD Receiver to turn off automatically at a specified time.

1. Press SLEEP to set the desired sleep time.

The SL indicator and the sleep time appears in the display window.

2. Each time you press SLEEP the setting

SL180 150 120 90 80 70 60 50 40
30 20 10 0 FF

DIMMER

This function will change the brightness of the display window on the front panel during in power-on status. Press the DIMMER repeatedly.

Screen Saver

The screen saver appears when you leave the unit in Stop mode for about five minutes.

System Select

You must select an appropriate system mode for your TV system. If NO DISC appears in the display window, press and hold P./STEP on the front panel or remote control for more than 5 seconds to be able to select a system (PAL, NTSC or AUTO).

- When the selected system is not compatible with the system of your TV, normal colour picture may not be displayed.

NTSC : Select when DVD/CD Receiver is connected with NTSC-TV.

PAL : Select when DVD/CD Receiver is connected with PAL-TV.

AUTO : Select when DVD/CD Receiver is connected with Multi system TV.

Playing a Disc or file - more you can do

Playing a DVD that has a menu **DVD**

Most DVDs now have menus which load first before the film begins to play. You can navigate these menus using **Λ V < >** to highlight an option. Press **PLAY (▶)** to select.

Skipping to the next/ previous chapter/ track/ file **ALL**

Press **SKIP (▶▶)** to move to the next chapter/ track/ file.

Press **SKIP (I◀◀)** to return to the beginning of the current chapter/ track/ file.

Press **SKIP (I◀◀)** twice briefly to step back to the previous chapter/ track/ file.

Pausing playback **ALL**

Press **PAUSE/STEP (II)** to pause playback. Press **PLAY (▶)** to continue playback.

Frame-by-Frame playback **DVD DivX**

Press **PAUSE/STEP (II)** repeatedly to play title Frame-by-Frame.

Playing repeatedly **ALL**

Press **REPEAT** key repeatedly, and the current title, chapter or all tracks will be played back repeatedly. To return to normal playback, press **REPEAT** repeatedly.

Fast forward or fast reverse **ALL**

Press **SCAN (◀◀ or ▶▶)** to play fast forward or fast reverse during playback. You can change the playback speed by pressing **SCAN (◀◀ or ▶▶)** repeatedly. Press **PLAY (▶)** to continue play at normal speed.

Selecting a subtitle language **DVD DivX**

During playback, press **SUBTITLE (☐)** repeatedly to select a desired subtitle language.

Slow down the playing speed **DVD DivX**

While playback is paused, press **SCAN (◀◀ or ▶▶)** to slow down forward or reverse playback. You can change the various playback speed by pressing **SCAN (◀◀ or ▶▶)** repeatedly. Press **PLAY (▶)** to continue play at normal speed. The DivX file cannot be slow down reverse playback.

1.5 speed playback **DVD VCD MP3 WMA**

You can quickly enjoy a music and movie. The 1.5 speed allows you to watch the pictures and listen to the sound quicker than playing at a normal speed on the disc.

1. Press the **PLAY** button during the normal play back. The screen will appear at 1.5 speed with sound.
2. To return to the normal **PLAY**, press **PLAY**.

Viewing the Title menu **DVD**

Press **TITLE** to display the disc's title menu, if available.

Starting play from selected time **DVD DivX**

Searches for the starting point of entered time code. Press **DISPLAY** then select clock icon. Enter a time then press **ENTER**. For example, to find a scene at 1 hour, 10 minutes, and 20 seconds, enter "11020" by using numerical buttons and press **ENTER**. If you enter the wrong number, press **CLEAR** to enter again.

Last Scene Memory **DVD**

This unit memorizes the last scene from the last disc that is viewed. The last scene remains in memory even if you remove the disc from the player or switch off (Stand-by mode) the unit. If you load a disc that has the scene memorized, the scene is automatically recalled.

Note :

This receiver does not memorize the scene of a disc if you switch off the receiver before commencing to play the disc.

Mixed disc or USB Flash Drive – DivX, MP3/ WMA and JPEG

When playing a mixed disc or USB Flash Drive containing with DivX, MP3/ WMA and JPEG files together, you can select menu of files which you would like to play by pressing **Title** key. If "This file has the non-supported type on the Player" pops up, then press **Enter** key to come back

Viewing the DVD MENU **DVD**

Press **MENU** to display the disc menu, if available.

Changing the character set to display DivX® subtitle correctly **DivX**

If the subtitle does not display properly during playback, press and hold **SUBTITLE** for about 3 seconds then press **< >** or **SUBTITLE** to select another language code until the subtitle is displayed properly and then press **ENTER**.

Playing a DivX Movie file

Using this DVD/CD Receiver you can play DivX disc.

1. Insert a disc and close the tray. The MOVIE menu appears on the TV screen.



2. Press **▲ / ▼** to select a folder and then press **ENTER**. A list of files in the folder appears. If you are in a file list and want to return to the Folder list, use the **▲ / ▼** buttons on the remote to highlight **FL** and press **ENTER**.
3. If you want to view a particular file, press **▲ / ▼** to highlight a file and press **ENTER** or **PLAY**.
4. Press **STOP** to exit.

Tips:

- Press **MENU** to move to the next page.
- On a CD with MP3/WMA, JPEG and MOVIE file, you can switch **MUSIC**, **PHOTO** and **MOVIE** menu. Press **TITLE** and **MUSIC**, **PHOTO** and **MOVIE** word on top of the menu is highlighted.

Notes:

- Be sure to select "SUBTITLE ON" mode by pressing the subtitle file every time before playing a DivX file .
- When the subtitle has more than two languages in the file, original subtitle is only available.
- The microphone does not work during playing a DivX file.
- You can not adjust sound mode and **VIRTUAL** sound during the DivX file playing.

Notice for displaying the Divx subtitle

If the subtitle does not display properly during playback, press and hold **S-TITLE** for about 3 seconds then press **S-TITLE** to select another language code until the subtitle is displayed properly

DivX file requirement **DivX**

DivX disc compatibility with this player is limited as follows:

- Available resolution size of the DivX file is under 800x600 (W x H) pixel.
- The file name of the DivX subtitle is available by 45 characters.
- If there is impossible code to express in the DivX file, it may be displayed as " _ " mark on the display.
- **If the number of the screen frame is over 30 per 1 second, this unit may not operate normally.**
- **If the video and audio structure of recorded files is not interleaved, either video or audio is outputted.**

Playable DivX file

- ".avi ", ".mpg ", ".mpeg ", ".divx"

Playable Subtitle format

SubRip(*.srt/* .txt)
SAM1(*.smi)
SubStation Alpha(*.ssa/* .txt)
MicroDVD(*.sub/* .txt)
SubViewer 2.0(*.sub/* .txt)
VobSub(*.sub)

Playable Codec format

- "DIVX3.xx ", "DIVX4.xx ", "DIVX5.xx ", "MP43 ", "3IVX "

Playable Audio format

- "AC3 ", "DTS ", "PCM ", "MP3 ", "WMA ".
 - Sampling frequency: within 32 - 48 kHz (MP3), within 24 - 48kHz (WMA)
 - Bit rate: within 32 - 320kbps (MP3), 40 - 192kbps (WMA)

Programmed Playback

The program function enables you to store your favorite tracks from any disc in the receiver memory. A program can contain 300 tracks.

1. Insert a disc.
Audio CD and MP3/WMA Discs:
2. Select a track on the "List", and then press PROG. or select "➕" (Add) icon and then press ENTER to place the selected track on the "Program" list. Repeat to place additional tracks on the list.

Note:

You can add all tracks in the disc. Select "⏏" (Add All) icon then press ENTER.

3. Select the track you want to start playing on the "Program" list. Press MENU to move to the next page.
4. Press PLAY or ENTER to start. Playback begins in the order in which you programmed the tracks. Playback stops after all of the tracks on the "Program" list have played once.
5. To resume normal playback from programmed playback, select a track of AUDIO CD (or MP3/WMA) list and then press PLAY.

Repeat Programmed Tracks

1. Press REPEAT when playing a disc. The repeat icon appears.
2. Press REPEAT to select a desired repeat mode.
 - TRACK: repeats the current track
 - ALL: repeats all the tracks on programmed list.
 - Off (No display): does not play repeatedly.

Erasing a Track from "Program" List

1. Use ▲▼ to select the track that you wish to erase from the Program list.
2. Press CLEAR. Alternatively, select "⊖" (Delete) icon then press ENTER to place the selected track on the Program list. Repeat to erase additional tracks on the list.

Erasing the Complete Program List

Use ▲/▼ to select "⊖" (Del all)" and then press ENTER.

Note:

The programs are also cleared when the disc is removed.

Viewing a JPEG file **JPEG**

This unit can play discs with JPEG files. Before playing JPEG recordings, read the notes on JPEG Recordings on the right.

1. Insert a disc and close the tray.
The PHOTO menu appears on the TV screen.

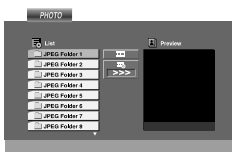

2. Press ▲/▼ to select a folder, and then press ENTER. A list of files in the folder appears. If you are in a file list and want to return to the previous Folder list, use the ▲/▼ buttons on the remote to highlight ⊞ and press ENTER.
3. If you want to view a particular file, press ▲/▼ to highlight a file and press ENTER or PLAY. While viewing a file, you can press STOP to move to the previous menu (JPEG menu).

Tips:

- There are four Slide Speed options  :> (Slow), >> (Normal), >>> (Fast) and II (off). Use ▲/▼/◀/▶ to highlight the Speed. Then, use ◀/▶ to select the option you want to use and then press ENTER.
- If you set Speed option to Off, the slide is not active.

Slide Show

Use ▲▼◀▶ to highlight the  (Slide Show) then press ENTER.

Still Picture

1. Press PAUSE/STEP during the slide show. The DVD/CD Receiver will now go into the PAUSE mode.
2. To return to the slide show, press PLAY or press PAUSE/STEP again.

Moving to another File

Press SKIP (◀◀ or ▶▶) once during viewing a picture to advance to the next or previous file.

Rotating the picture

Press ▲/▼/◀/▶ during showing a picture to rotate the picture clockwise or counter-clockwise.

Zoom

Each time press ZOOM the setting change in the following order.

Zoom on ↔ Zoom off

Press ▲/▶/▶▶ to enlarge the video image.

Press ▼/◀/◀◀ to reduce the video image.

JPEG disc compatibility with this player is limited as follows:

- Depending upon the size and the number of JPEG files, it could take a long time for the DVD/CD Receiver to read the disc's contents. If you don't see an on-screen display after several minutes, some of the files may be too large — reduce the resolution of the JPEG files to less than 2M pixels as 2760 x 2048 pixels and burn another disc.
- The total number of files and folders on the disc should be less than 999.
- Some discs may not operate due to a different recording format or the condition of disc.
- Ensure that all the selected files have the ".jpg" extensions when copying into the CD layout.
- If the files have ".jpe" or ".jpeg" extensions, please rename them as ".jpg" file.
- File names without ".jpg" extension will not be able to be read by this DVD/CD Receiver. Even though the files are shown as JPEG image files in Windows Explorer.

Listening to music from external device

The unit can be used to play the music from external device

Connect the external device to the **AUX** connector of the unit.

> If your TV has only one output for audio(MONO), connect it to the left(white) audio jack on the unit.

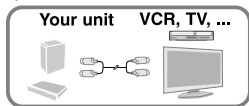

	ON REMOTE
2 Turn the power on	POWER
3 Select the AUX function	FUNCTION
4 Turn the external device and start it playing	.

Presetting the Radio Stations

You can preset 50 stations for FM and AM (MW). Before presetting, make sure that you have turned down the volume.

1. Press BAND on the remote control until FM or AM (MW) appears in the display window.
2. And then every time you press BAND, FM and AM (MW) changes alternately.
3. Press and hold TUN.(+/+) for about two seconds until the frequency indication starts to change, then release.
Scanning stops when the DVD/CD Receiver tunes in a station.
4. Press PROG./MEMO. on the remote control. A preset number will flash in the display window.
5. Press PRESET +/- on the remote control to select the preset number you want.
6. Press PROG./MEMO on the remote control again. The station is stored.
7. Repeat steps 3 to 6 to store other stations.

To tune in a station with a weak signal

Press TUN.(+/+) repeatedly in step 3 to tune in the station manually.

To clear all the stored stations

Press and hold PROG./MEMO. for about two seconds and "ERASE" is appeared in the display window and then press PROG./MEMO. again, the stations are cleared.

- If you have accidentally entered into the "ERASE" mode and you do not wish to clear the memory, do not press any key. After a few seconds, the "ERASE" will go off by itself and change to normal mode.

Note:

If all stations have already been entered, the FULL message will appear in the display window for a moment and then a preset number will flash.

To change the preset number, follow the steps 5-6 as above.

Listening to the Radio

Preset radio stations in the DVD/CD Receiver's memory first (see "Presetting radio stations" on the left).

1. Press BAND until FM or AM (MW) appears in the display window.
The last received station is tuned in.

- Press PRESET +/- repeatedly on the remote control to select the preset station you want. Each time you press the button, the DVD/CD Receiver tunes in one preset station at a time.
- Adjust the volume by rotating VOLUME on the front panel or by pressing VOLUME + or - on the remote control repeatedly.

To turn off the radio

Press POWER to turn the DVD/CD Receiver off or select another function mode (DVD/CD, AUX, USB).

To listen to non-preset radio stations

- Use manual or automatic tuning in the step 2.
- For manual tuning, press TUN. (-/+) repeatedly.
- For automatic tuning, press and hold TUN. (-/+) for about two seconds on the front panel.

To select a preset radio station directly

You can use the number buttons on the remote control to select a preset radio station directly. For example, to listen to the preset station 4, press 4 on the remote control. To listen to the preset station 19, press 1 and then 9 (within 3 seconds).

For your reference

● If an FM program is noisy

Press MONO/ST. on the front panel to make "ST." disappear in the display window. There will be no stereo effect, but the reception will improve. Press the button again to restore the stereo effect.

● To improve reception

Reorient the supplied antennas.

Using an USB device

You can enjoy media files saved on an USB device by connecting the USB device to the USB port of the unit. If you want to operate other function, see the CD playback section.

	ON REMOTE
1 Connect the USB device to the USB port of the unit.	-
2. Select the USB function	USB
3 Select a file you want to play	^ v
4 Start your media playing	▶ PLAY
5 To stop, press	■ STOP
6 Before disconnecting the portable USB device, change to any other function.	BAND / DVD / AUX

Compatible USB Devices

- MP3 Player : Flash type MP3 player.
- USB Flash Drive : Devices that support USB2.0 or USB1.1.
- The USB function of this unit does not support all USB devices.







USB device requirement

- Devices which require additional program installation when you have connected it to a computer, are not supported.

Look out for the follows.

- Do not extract the USB device while in operation.
- For a large capacity USB, it may take longer than a few minute to be searched
- To prevent data loss, back up all data.
- If you use a USB extension cable or USB hub, the USB device is not recognized.
- Using NTFS file system is not supported. (Only FAT(16/32) file system is supported.
- This unit is not supported when the total number of files is 1000 or more.
- External HDD, Card readers, Locked devices, or hard type usb devices are not supported.
- USB port of the unit cannot be connected to PC. The unit can not be used as a storage device.
- Digital Cameras & Mobile Phones are not supported.

Types of Playable Discs

Type	Logo
DVD-VIDEO: Discs such as movies that can be purchased or rented.	
DVD-R: Video mode and finalized only	
DVD-RW: VR mode, Video mode and finalized only	
DVD+R: Video mode only	
DVD+RW: Video mode only	
Audio CD: Music CDs or CD-R/CD-RW in music CD format that can be purchased.	

This unit plays DVD±R/RW and CD-R/RW that contains audio titles, DivX, MP3, WMA and/or JPEG files. Some DVD±R/DVD±R or CD-RW/CD-R cannot be played on this unit due to the recording quality or physical condition of the disc, or the characteristics of the recording device and authoring software.

- Do not attach any seal or label to either side (the labeled side or the recorded side) of a disc.
- Do not use irregularly shaped CDs (e.g., heart-shaped or octagonal). It may result in malfunctions.

Regional Codes

This unit has a regional code printed on the rear of the unit. This unit can play only DVD discs labeled same as the rear of the unit or "ALL".

- Most DVD discs have a globe with one or more numbers in it clearly visible on the cover. This number must match your unit's regional code or the disc cannot play.
- If you try to play a DVD with a different regional code from your player, the message "Check Regional Code" appears on the TV screen.

Manufactured under license from Dolby Laboratories. "Dolby", "Pro Logic", and the double-D symbol are trade marks of Dolby Laboratories. Confidential Unpublished works. Copyright 1992-1997 Dolby Laboratories. All rights reserved.

Manufactured under license from Digital Theater Systems, Inc. U.S. Pat. No.'s. 5,451,942; 5,956,674; 5,974,380; 5,978,762; 6,226,616; 6,487,535 and other U.S. and world-wide patents issued and pending. "DTS" and "DTS DigitalSurround" are registered trademarks of Digital TheaterSystems, Inc. Copyright 1996, 2003 Digital TheaterSystems, Inc. All Rights Reserved."

About the Symbol Display

 may appear on your TV display during operation and indicates that the function explained in this owner's manual is not available on that specific DVD video disc.

Disc-related terms

DVD ±R / DVD ±RW

DVD -R and DVD +R are two different standards for recordable DVD drives and discs. This format allows information to be recorded onto the DVD disc only once. DVD +RW and DVD -RW are two standards for re-writable media, meaning the DVD content can be erased and re-recorded.

VCD (Video CD)

A VCD holds up to 74 minutes (650 MB disc) or 80 minutes (700 MB disc) of MPEG-1 full-motion video along with quality stereo sound.

MPEG

MPEG is an international standard for video and audio compression. MPEG-1 is used in encoding video for VCD and provides for multichannel surround sound coding such as PCM, Dolby Digital, DTS and MPEG audio.

MP3

MP3 is a popular compression format used for digital audio files that yields very high near-CD quality.

WMA

Windows media audio file. A type of coding / decoding developed by Microsoft Corp.

JPEG

Joint Pictures Expert Group. JPEG is a compressed file format that allows you to save images with no limit on the number of colors.

DivX

DivX is the name of a revolutionary new video codec which is based on the new MPEG-4 (MP-4) compression standard for video. You will be able to play DivX movies using this DVD player.

Note: This player does not support all MP4 formats.

PBC: Playback Control (Video CD only)

Playback control is available for Video CD (VCD) version 2.0 disc formats. PBC allows you to interact with the system via menus, search functions, or other typical computer-like operations. Moreover, still pictures of high resolution can be played if they are included in the disc. Video CDs not equipped with PBC (Version 1.1) operate in the same way as audio CDs.

Title (DVD video discs only)

A title is generally a distinct section of a DVD disc. For example the main feature could be title 1, a documentary describing how the film was made could be title 2, and cast interviews could be title 3. Each title is assigned a reference number enabling you to locate it easily.

Chapter (DVD video discs only)

A chapter is a segment of a title such as a scene in a film or one interview in a series. Each chapter is assigned a chapter number, enabling you to locate the chapter you want. Depending on the disc, chapters may not be recorded.

Scene (VCD)

On a video CD with PBC (playback control) functions, moving pictures and still pictures are divided into sections called "scenes". Each scene is displayed in the menu screen and assigned a scene number, enabling you to locate the scene you want. A scene is composed of one or several tracks.

Track

A distinct element of audiovisual information, such as the picture or sound track for a specific language (DVD), or a musical piece on a video or audio CD. Each track is assigned a track number, enabling you to locate the track you want. DVD discs allow one track of video (with multiple angles) and several tracks of audio.

Language Codes

Use this list to input your desired language for the following initial settings: Disc Audio, Disc Subtitle, Disc Menu.

Language	Code	Language	Code	Language	Code	Language	Code	Language	Code		
Afar	6565	Croatian	7282	Hausa	7265	Lingala	7678	Quechua	8185	Tajik	8471
Afrikaans	6570	Czech	6783	Hebrew	7387	Lithuanian	7884	Rhaeto-Romance	8277	Tamil	8465
Albanian	8381	Danish	6865	Hindi	7273	Macedonian	7775	Rumanian	8279	Telugu	8469
Ameharic	6577	Dutch	7876	Hungarian	7285	Malagasy	7771	Russian	8285	Thai	8472
Arabic	6582	English	6978	Icelandic	7383	Malay	7783	Samoan	8377	Tonga	8479
Armenian	7289	Esperanto	6979	Indonesian	7378	Malayalam	7776	Sanskrit	8365	Turkish	8482
Assamese	6583	Estonian	6984	Interlingua	7365	Maori	7773	Scots Gaelic	7168	Turkmen	8475
Aymara	6588	Faroese	7079	Irish	7165	Marathi	7782	Serbian	8382	Twi	8487
Azerbaijani	6590	Fiji	7074	Italian	7384	Moldavian	7779	Serbo-Croatian	8372	Ukrainian	8575
Bashkir	6655	Finnish	7073	Javanese	7487	Mongolian	7778	Shona	8378	Urdu	8582
Basque	6985	French	7082	Kannada	7578	Nauru	7865	Sindhi	8368	Uzbek	8590
Bengali, Bangla	6678	Frisian	7089	Kashmiri	7583	Nepali	7869	Singhalese	8373	Vietnamese	8673
Bhutani	6890	Galloian	7176	Kazakh	7575	Norwegian	7879	Slovak	8375	Volapuk	8679
Bihari	6672	Georgian	7585	Kirgiz	7589	Oriya	7982	Slovenian	8376	Welsh	8789
Breton	6682	German	6869	Korean	7579	Paniabi	8065	Spanish	6983	Wolof	6779
Bulgarian	6671	Greek	6976	Kurdish	7585	Pashto, Pushto	8083	Sudanese	8385	Xhosa	8872
Burmese	7789	Greenlandic	7576	Laotian	7679	Persian	7065	Swahili	8387	Yiddish	7473
Byelorussian	6669	Guarani	7178	Latin	7665	Polish	8076	Swedish	8386	Yoruba	8979
Chinese	9072	Gujarati	7185	Latvian, Lettish	7686	Portuguese	8084	Tagalog	8476	Zulu	9085

Area Codes

Choose a area code from this list.

Area	Code	Area	Code	Area	Code	Area	Code	Area	Code		
Afghanistan	AF	Costa Rica	CR	Greenland	GL	Maldives	MV	Paraguay	PY	Sri Lanka	LK
Argentina	AR	Croatia	HR	Hong Kong	HK	Mexico	MX	Philippines	PH	Sweden	SE
Australia	AU	Czech Republic	CZ	Hungary	HU	Monaco	MC	Poland	PL	Switzerland	CH
Austria	AT	Denmark	DK	India	IN	Mongolia	MN	Portugal	PT	Taiwan	TW
Belgium	BE	Ecuador	EC	Indonesia	ID	Morocco	MA	Romania	RO	Thailand	TH
Bhutan	BT	Egypt	EG	Israel	IL	Nepal	NP	Russian Federation	RU	Turkey	TR
Bolivia	BO	El Salvador	SV	Italy	IT	Netherlands	NL	Saudi Arabia	SA	Uganda	UG
Brazil	BR	Ethiopia	ET	Jamaica	JM	Netherlands Antilles	AN	Senegal	SN	Ukraine	UA
Cambodia	KH	Fiji	FJ	Japan	JP	New Zealand	NZ	Singapore	SG	United States	US
Canada	CA	Finland	FI	Kenya	KE	Nigeria	NG	Slovak Republic	SK	Uruguay	UY
Chile	CL	France	FR	Kuwait	KW	Norway	NO	Slovenia	SI	Uzbekistan	UZ
China	CN	Germany	DE	Libya	LY	Oman	OM	South Africa	ZA	Vietnam	VN
Colombia	CO	Great Britain	GB	Luxembourg	LU	Pakistan	PK	South Korea	KR	Zimbabwe	ZW
Congo	CG	Greece	GR	Malaysia	MY	Panama	PA	Spain	ES		

Specifications

General

Power Supply	Refer to main label
Power consumption	Refer to main label
External dimensions (W x H x D)	360 x 63 x 307 mm
Net Weight (Approx.)	2.4 kg
Operating temperature:	5 °C to 35 °C, Operation status: Horizontal
Operating humidity	5 % to 85 %

Tuner FM

FM Tuning Range	87.5 - 108.0 MHz or 65.0 - 74.0 MHz, 87.5 - 108.0 MHz
FM Intermediate Frequency	10.7 MHz
AM Tuning Range	522 - 1,620 kHz or 520 - 1,720 kHz
AM Intermediate Frequency	450 kHz

Amplifier

Stereo mode	45W + 45W (Rated Output Power 30W, 4Qat 1 kHz, THD 10 %)
Surround mode	Front: 45W + 45W (Rated Output Power 30W, THD 10 %)
Center*	45W
Surround*	45W + 45W (Rated Output Power 30W, 4Qat 1 kHz, THD 10 %)

Speaker

	Front/Rear/Center speaker (SH32SD-SZ)	Passive Subwoofer (SH32SD-WZ)
Type	1 Way 1 Speaker	1Way1Speaker
Impedance	4 Ω	8 Ω
Frequency Response	160 - 20, 000 Hz	65 - 1, 500 Hz
Sound Pressure Level	82 dB/W (1m)	80 dB/W (1m)
Rated Input Power	45 W	75 W
Max. Input Power	90 W	150 W
Net Dimensions (W x H x D)	98 x 101 x 105mm	181 x 351 x 278mm
Net Weight	0.52kg	3.4kg

* Designs and specifications are subject to change without prior notice.



Free Manuals Download Website

<http://myh66.com>

<http://usermanuals.us>

<http://www.somanuals.com>

<http://www.4manuals.cc>

<http://www.manual-lib.com>

<http://www.404manual.com>

<http://www.luxmanual.com>

<http://aubethermostatmanual.com>

Golf course search by state

<http://golfingnear.com>

Email search by domain

<http://emailbydomain.com>

Auto manuals search

<http://auto.somanuals.com>

TV manuals search

<http://tv.somanuals.com>