



**42LQ640H**

**Hospital TVs**

---

# Commercial Mode Setup Guide

Note: Selected features shown within this guide may not be available on all models.

## EXPERIENCED INSTALLER

Express Script Installer Menu Wizard  
pages 10–14

Custom Master TV Setup  
pages 25–28

FTG Mode of Operation  
pages 43–49

For Customer Support/Service, please call:  
**1-888-865-3026**

The latest product information and documentation is available online at:

**www.LGSolutions.com**

MODEL and SERIAL NUMBER

The model and serial numbers of this TV are located on the back of the cabinet. For future reference, LG suggests that you record those numbers here:

Model No. \_\_\_\_\_ Serial No. \_\_\_\_\_



**WARNING:**

TO REDUCE THE RISK OF ELECTRIC SHOCK DO NOT REMOVE COVER (OR BACK). NO USER-SERVICEABLE PARTS INSIDE. REFER TO QUALIFIED SERVICE PERSONNEL.



The lightning flash with arrowhead symbol, within an equilateral triangle, is intended to alert the user to the presence of uninsulated “dangerous voltage” within the product’s enclosure that may be of sufficient magnitude to constitute a risk of electric shock to persons.



The exclamation point within an equilateral triangle is intended to alert the user to the presence of important operating and maintenance (servicing) instructions in the literature accompanying the appliance.

**WARNING:**

TO PREVENT FIRE OR SHOCK HAZARDS, DO NOT EXPOSE THIS PRODUCT TO RAIN OR MOISTURE.

**POWER CORD POLARIZATION:**

This product is equipped with a 3-wire grounding-type alternating current power plug. This plug will fit into the power outlet only one way. This is a safety feature. If you are unable to insert the plug fully into the outlet, contact your electrician to replace your obsolete outlet. Do not defeat the safety purpose of the 3-wire grounding-type plug.

**NOTE TO CABLE/TV INSTALLER:**

This reminder is provided to call the cable TV system installer’s attention to Article 820-40 of the National Electrical Code (U.S.A.). The code provides guidelines for proper grounding and, in particular, specifies that the cable ground shall be connected to the grounding system of the building, as close to the point of the cable entry as practical.

**REGULATORY INFORMATION:**

This equipment has been tested and found to comply with the limits for a Class B digital device, pursuant to Part 15 of the FCC Rules. These limits are designed to provide reasonable protection against harmful interference when the equipment is operated in a residential installation. This equipment generates, uses and can radiate radio frequency energy and, if not installed and used in accordance with the instruction manual, may cause harmful interference to radio communications. However, there is no guarantee that interference will not occur in a particular installation. If this equipment does cause harmful interference to radio or television reception, which can be determined by turning the equipment off and on, the user is encouraged to try to correct the interference by one or more of the following measures:

- Reorient or relocate the receiving antenna.
- Increase the separation between the equipment and receiver.
- Connect the equipment to an outlet on a circuit different from that to which the receiver is connected.
- Consult the dealer or an experienced radio/TV technician for help.

**CAUTION:**

Do not attempt to modify this product in any way without written authorization from LG Electronics U.S.A., Inc. Unauthorized modification could void the user’s authority to operate this product.

**COMPLIANCE:**

The responsible party for this product’s compliance is: LG Electronics U.S.A., Inc.  
1000 Sylvan Avenue, Englewood Cliffs, NJ 07632, USA • Phone: 1-201-816-2000

Marketed and Distributed in the United States by LG Electronics U.S.A., Inc.  
1000 Sylvan Avenue, Englewood Cliffs, NJ 07632

# IMPORTANT SAFETY INSTRUCTIONS

1. Read these instructions.
2. Keep these instructions.
3. Heed all warnings.
4. Follow all instructions.
5. Do not use this apparatus near water.
6. Clean only with dry cloth.
7. Do not block any ventilation openings. Install in accordance with the manufacturer's instructions.
8. Do not install near any heat sources, such as radiators, heat registers, stoves, or other apparatus (including amplifiers) that produce heat.
9. Do not defeat the safety purpose of the polarized or grounding-type plug. A polarized plug has two blades with one wider than the other. A grounding-type plug has two blades and a third grounding prong. The wide blade or the third prong are provided for your safety. If the provided plug does not fit into your outlet, consult an electrician for replacement of the obsolete outlet.
10. Protect the power cord from being walked on or pinched, particularly at plugs, convenience receptacles, and the point where it exits from the apparatus.
11. Only use attachments/accessories specified by the manufacturer.
12. Use only with the cart, stand, tripod, bracket, or table specified by the manufacturer or sold with the apparatus. When a cart is used, use caution when moving the cart/apparatus combination in order to avoid injury from tip-over.



PORTABLE CART WARNING

13. Refer all servicing to qualified service personnel. Servicing is required when the apparatus has been damaged in any way, such as power-supply cord or plug is damaged, liquid has been spilled or objects have fallen into the apparatus, the apparatus has been exposed to rain or moisture, does not operate normally, or has been dropped.
14. Never touch this apparatus or antenna during a thunder or lightning storm.
15. When mounting a TV on the wall, make sure not to install the TV by the hanging power and signal cables on the back of the TV.
16. Do not allow an impact shock or any objects to fall into the product, and do not drop objects onto the screen.

## 17. Power Cord

**Caution: It is recommended that appliances be placed upon a dedicated circuit; that is, a single outlet circuit which powers only that appliance and has no additional outlets or branch circuits. Check the specification page in the Owner's Manual to be certain.**

Periodically examine the cord of your appliance, and if its appearance indicates damage or deterioration, unplug it, discontinue use of the appliance, and have the cord replaced with an exact replacement part by an authorized servicer. Protect the power cord from physical or mechanical abuse, such as twisting, kinking, or pinching or being closed in a door or walked upon. Pay particular attention to plugs, wall outlets, and the point where the cord exits the appliance.

Do not use a damaged or loose power cord. Be sure to grasp the plug when unplugging the power cord. Do not pull on the power cord to unplug the TV.

## 18. Overloading

Do not connect too many appliances to the same AC power outlet as this could result in fire or electric shock. Do not overload wall outlets. Overloaded wall outlets, loose or damaged wall outlets, extension cords, frayed power cords, or damaged or cracked wire insulation are dangerous. Any of these conditions could result in fire or electric shock.

## 19. Outdoor Use/Wet Location



**Warning: To reduce the risk of fire or electrical shock, do not expose this product to rain, moisture or other liquids.**

Do not touch the TV with wet hands. Do not install this product near flammable objects such as gasoline or candles or expose the TV to direct air conditioning.

Do not expose to dripping or splashing and do not place objects filled with liquids, such as vases, cups, etc., on or over the apparatus (e.g., on shelves above the unit).

## 20. Grounding

Ensure that you connect the earth ground wire to prevent possible electric shock (i.e., a TV with a three-prong grounded AC plug must be connected to a three-prong grounded AC outlet). If grounding methods are not possible, have a qualified electrician install a separate circuit breaker. Do not try to ground the unit by connecting it to telephone wires, lightning rods, or gas pipes.

## 21. Disconnect Device

The mains plug is the disconnecting device. The plug must remain readily operable.

As long as this unit is connected to the AC wall outlet, it is not disconnected from the AC power source even if you turn off this unit by SWITCH.

(Continued on next page)

# IMPORTANT SAFETY INSTRUCTIONS

(Continued from previous page)

## 22. Outdoor Antenna Grounding

If an outside antenna or cable system is connected to the product, follow the precautions below.

An outdoor antenna system should not be located in the vicinity of overhead power lines or other electric light or power circuits or where it can come into contact with such power lines or circuits as death or serious injury can occur.

Be sure the antenna system is grounded so as to provide some protection against voltage surges and built-up static charges.

Article 810 of the National Electrical Code (NEC) in the U.S.A. provides information with respect to proper grounding of the mast and supporting structure, grounding of the lead-in wire to an antenna-discharge unit, size of grounding conductors, location of antenna-discharge unit, connection to grounding electrodes, and requirements for the grounding electrode.

### Antenna Grounding According to NEC, ANSI/NFPA 70

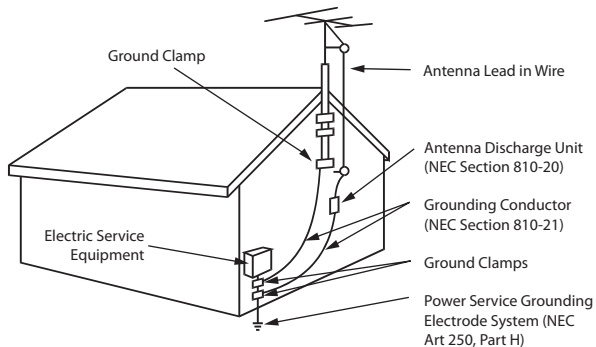

## 23. Cleaning

When cleaning, unplug the power cord and wipe gently with a soft cloth to prevent scratching. Do not spray water or other liquids directly on the TV as electric shock may occur. Do not clean with chemicals such as alcohol, thinners or benzene.

## 24. Transporting Product

Make sure the TV is turned Off and unplugged and that all cables have been removed. It may take two or more people to carry larger TVs. Do not press against or put stress on the front panel of the TV during transport.

## 25. Ventilation

Install the TV where there is proper ventilation. Do not install in a confined space such as a bookcase. Do not cover the TV with cloth or other materials (e.g., plastic) while it is plugged in. Do not install in excessively dusty places.

26. Do not touch the ventilation openings, as they may become hot while the TV is operating.
27. If you smell smoke or other odors coming from the TV or hear strange sounds, unplug the power cord, and contact an authorized service center.
28. Do not press against the front panel of the TV with your hand or a sharp object (e.g., a nail, pencil, or pen) or make a scratch on it.
29. Keep the product away from direct sunlight.

## 30. Dot Defect

The LCD panel is a high technology product with resolution of two million to six million pixels. In a very few cases, you could see fine dots on the screen while you are viewing the TV. Those dots are deactivated pixels and do not affect the performance and reliability of the TV.

## 31. Generated Sound

“Cracking”: A cracking noise that occurs while the TV is On or when it is turned Off is generated by plastic thermal contraction due to temperature and humidity. This noise is common for products where thermal deformation is required.

Electrical circuit humming/panel buzzing: A low level noise is generated from a high-speed switching circuit, which supplies a large amount of current to operate a product. It varies depending on the product. This generated sound does not affect the performance and reliability of the product.

## 32. For LCD TV

If the TV feels cold to the touch, there may be a small “flicker” when it is turned On. This is normal; there is nothing wrong with the TV. Some minute dot defects may be visible on the screen, appearing as tiny red, green, or blue spots. However, they have no adverse effect on the TV’s performance. Avoid touching the LCD screen or holding your finger(s) against it for long periods of time. Doing so may produce some temporary distortion effects on the screen.

# Table of Contents

---

Safety Warnings . . . . .	2	Creating an FTG Configuration File using the FTG File Manager . . . . .	45
Important Safety Instructions . . . . .	3–4	Teaching FTG Configuration to a TV . . . . .	47
Table of Contents . . . . .	5	Learning FTG Configuration from a TV . . . . .	48
<b>Commercial Mode Overview</b> . . . . .	6–8	Optional Manual Configuration / TV Setup . . . . .	49
Setup Checklist . . . . .	6	<b>FTG File Manager Utilities Overview</b> . . . . .	50–53
Pass-through Mode . . . . .	6	FTG File Manager Main Screen . . . . .	50
FTG Mode . . . . .	7	FTG Channel Map Configuration Utility . . . . .	51
Remote Management in FTG Mode . . . . .	7	FTG Channel Map Editor . . . . .	52
<b>Pro:Centric Operation</b> . . . . .	8–9	FTG Installer Menu Configuration Utility . . . . .	53
Pro:Centric TV Interactive Menu Features . . . . .	8	<b>References</b>	
Pro:Centric Interactive Menu Navigation . . . . .	8	Upgrading TV/PTC Software using a USB Memory Device . . . . .	54
Pro:Centric Setup . . . . .	9	Downloading a Splash Screen using a USB Memory Device . . . . .	55
<b>Express Script Installer Menu Wizard</b> . . . . .	10–14	Power Consumption Settings . . . . .	56
<b>Installer Menu</b> . . . . .	15–24	TV Aux Input Configuration . . . . .	57
Accessing the Installer Menu . . . . .	15	Auto Input(s) Sensing Feature . . . . .	58–59
Using the Installer Menu . . . . .	16	42LQ640H Hospital Operations . . . . .	60–61
Exiting the Installer Menu and Activating Settings . . . . .	16	Using the TV Zoning Feature . . . . .	62–63
<b>Custom Master TV Setup</b> . . . . .	25–28	Restoring Factory Defaults on the TV(s) . . . . .	64
Before You Begin . . . . .	25	42LQ640H Rear and Side Jack Panels . . . . .	65
Cloning Methods . . . . .	25	External Stereo Speaker Setup . . . . .	66
Clonable TV Setup Menu Features . . . . .	25	Pillow Speaker Setup . . . . .	67
Custom Master TV Setup Procedure . . . . .	26	Installer Remote Control Typical Key Functions . . . . .	68
<b>Channel Icons / Custom Text Labels (2-5-4+ MENU Mode)</b> . . . . .	29	USB Media Navigation using Pro:Centric Pillow Speaker . . . . .	69
<b>Channel Banks Setup</b> . . . . .	30–32	VESA Standard TV Mounts . . . . .	70
Channel Banks Worksheet . . . . .	33	Troubleshooting . . . . .	71–74
<b>Cloning Overview</b> . . . . .	34	General Troubleshooting . . . . .	71
<b>USB Cloning Procedures</b> . . . . .	35–38	Commercial Mode Check / FTG Operation Troubleshooting . . . . .	72
Learning / Teaching a Master TV Setup using a USB Memory Device / .tlx File . . . . .	35	Clone Programmer Troubleshooting . . . . .	73
Learning / Teaching a Master TV Setup using a USB Memory Device / .tll File . . . . .	37	Channel Banks Setup Troubleshooting . . . . .	74
<b>Clone Programmer Cloning Procedures</b> . . . . .	39–42	Glossary of Terms . . . . .	75
Learning / Teaching a Master TV Setup using a TLL-1100A Clone Programmer . . . . .	39	Document Revision History / Open Source Software Notice . . . . .	76
Learning / Teaching a Master TV Setup using an LT2002 Clone Programmer . . . . .	41	Back Cover . . . . .	77
<b>FTG Mode of Operation</b> . . . . .	43–49		
FTG Mode Overview . . . . .	43		
Determining the TV Operating Mode . . . . .	44		

---

## Notes

- Installer Menu content is intended for use primarily by qualified TV electronics technicians.
- Refer to the applicable Owner's Manual for additional information on TV installation, specifications, maintenance, and safety instructions.
- Design and specifications subject to change without prior notice. This document provides examples of typical TV displays. Your displays may vary from those shown in this document.

# Commercial Mode Overview

---

This document describes how to set up 42LQ640H Pro:Centric® TVs for Commercial Mode operation. LG commercial TV functionality is based on “ownership” of the Channel Map; that is, the Channel Map resides in the TV’s CPU or Protocol Translator Card (PTC), or it resides externally from the TV (i.e., in a device from the solution provider).

Each of these TV models is capable of Free-To-Guest (FTG) Mode operation via the TV CPU. Alternatively, the TV can be configured either for Pass-through Mode (default). When in Pass-through Mode, these TV models also allow external control via the TV’s MPI port.

## Setup Checklist

**Note:** This document provides information specific to Commercial Mode operation. Refer to the Owner’s Manual for information on TV installation and hardware and cable connections.

### Installation

- Unpack TV and all accessories.
  - Install batteries in the Installer Remote.
  - Install TV on VESA mount or stand.
- Note:** It may be advisable to make all cable connections before installing on VESA mount or stand, as appropriate.

### Cable Connections

- Make all rear jack panel and MPI card slot connections, as appropriate.

### Commercial Mode Setup

- Complete appropriate procedures as described in this document for Commercial Mode operation.

### Hardware Connections

- Install any additional hardware as appropriate to your institution, LAN, etc.

## Pass-through Mode

This mode allows you to configure stand-alone TVs and/or create a Master TV Setup for cloning purposes for TVs that are to remain in Pass-through Mode. This mode also allows external control via the MPI port on the TV rear jack panel.

There are two methods for configuring stand-alone TVs in Pass-through Mode: either using the Express Script Installer Menu Wizard or the Custom Master TV Setup procedure as described in this document.

### Express Script Installer Menu Wizard

The Express Script Installer Menu Wizard guides you through the process of setting up the TVs, limiting the customization of TV features and Installer Menu items to those that are essential to most hospital TV viewing applications. See “Express Script Installer Menu Wizard” on pages 10 to 14 for detailed information.

**Note:** While the Express Script Installer Menu Wizard enables you to set up TVs in lieu of cloning, you can also use an Express Script TV Setup for cloning purposes, if desired. However, note that TV setup menu customization via the Express Script Installer Menu Wizard is limited to Channel Menu options.

### Custom Master TV Setup

Unlike the guided process above, the Custom Master TV Setup procedure enables you to create a customized Master TV Setup for cloning purposes. Configure Installer Menu items as required for TV operation and set up TV features (Channel, Picture, Audio, etc.). See “Custom Master TV Setup” on pages 25 to 28 for detailed information.

### Installer Menu

To create a customized Master TV Setup, you will need to know how to access the commercial controller (PTC) Installer Menu and make changes to the default values as required. If necessary, familiarize yourself with the Installer Menu and how to make and save changes. Refer to pages 15 to 24 for information on accessing the Installer Menu and for detailed descriptions of the Installer Menu items.

### TV Setup Menus

On-screen setup menus control the features of the TV. Use the Installer Remote to access the TV setup menus, and set the TV features to the desired configuration for the end user. Refer to the Owner's Manual for detailed information on the TV setup menus.

### Cloning

Cloning refers to the process of capturing a Master TV Setup and transferring it to a Target TV. Both TVs must be in Pass-through Mode and both TVs must be identical models. The Master TV's clonable setup menu features should be configured as part of the Master TV Setup. If there are features in the Master TV's setup—channel icons or labels, digital font options, etc.—that are not set or that are set incorrectly, those features also will not be set or will be set incorrectly in the Target TVs. Refer to pages 34 to 42 for detailed information on cloning requirements and procedures.

**Note:** If desired, an Express Script TV Setup also may be used for cloning purposes.

### External MPI Control

To control the TV using an external MPI control device, you must use the TV's MPI port for communication purposes.

**Note:** These TV models are not equipped with MPI card slots.

### FTG Mode

This mode enables Pro:Idiom® decryption and also allows logical channel mapping of physical channels to remove the need for dash tuning. When the TV CPU is configured with an FTG Channel Map, the CPU controls the operation of the TV.

Configuration of the CPU requires the LG FTG File Manager PC application. The FTG File Manager provides utilities that enable you to create/edit an FTG Channel Map and configure Installer Menu settings. See pages 43 to 49 for further information on FTG Mode operation and configuration.

### Remote Management in FTG Mode

When the TV is configured for FTG Mode, remote management of the FTG Channel Map and FTG Installer Menu settings is provided by a Pro:Centric server. Refer to the **Pro:Centric Server Admin Client User Guide** for further information.

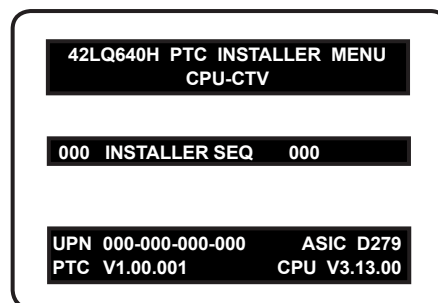

Typical Installer Menu

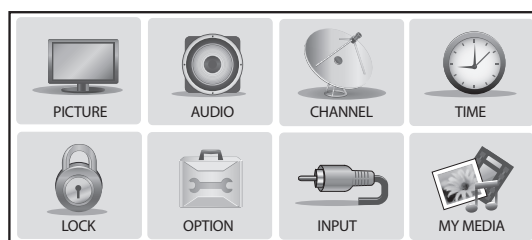

TV Setup Menus

# Pro:Centric Operation

---

## Pro:Centric TV Interactive Menu Features

When running the Pro:Centric application, the interactive Pro:Centric TV enables patients and visitors to locate and select television entertainment using an interactive channel guide, check the daily weather, and view hospital and surrounding amenities via custom billboards and points-of-interest maps.

Pro:Centric application features include:

- Portal and information screens/pages (including a “Welcome” page) that include branding logos.
- An optional customized user interface (custom “skins”).
- Billboards and points-of-interest maps, which can be customized to focus on hospital amenities, local attractions and businesses, hotels, restaurants, news, events, etc.
- An optional Weather billboard that includes a local radar map, current conditions, and a four day forecast.
- An interactive channel guide that provides a channel list with channel icons. An electronic program guide (EPG) is an optional feature that displays up to three days of programming information viewable by channel and time.
- Video spooling that enables the hospital to deliver a video file to patient and visitor TVs for promotion and information purposes.

The Pro:Centric server Admin Client web editor/content wizard is provided for customer configuration of portal messages and billboards/maps.

**Note:** Customized content is typically defined by the service integrator and/or hospital administrators. LG does not provide hospital-specific content.

## Pro:Centric Interactive Menu Navigation

Use the Pro:Centric pillow speaker to operate both interactive menus and regular TV features. Press **PORTAL** on the Pro:Centric pillow speaker to access the interactive menus.

**Note:** Interactive menu options may vary, depending on Pro:Centric features enabled for the site. The following are default interactive menus.



### Channel Guide

Shows available TV networks and logical channels. When available, EPG data provides additional channel and program information.

### Information

Typically displays information on hospital and nearby amenities, for example, restaurants, cafeterias, facilities, etc., as well as information on local weather.

### Help

Provides help for navigating the interactive menus.

### Watch TV

Removes the interactive menu from the screen and returns to the previously tuned TV channel.



## Pro:Centric Setup

Administration and management options for the Pro:Centric server are described in detail in the *Pro:Centric Server Admin Client User Guide*. This document describes only those settings that must be specified on the TVs.

On the TVs, the Data Channel must be set appropriately to enable Pro:Centric remote management/administration facilities, while the Pro:Centric Application Mode must be set appropriately to enable the Pro:Centric application.

- Remote management/administration (TV E-Z Installation): The Pro:Centric server Admin Client provides remote management/administration facilities for downloading splash screens and software/firmware updates as well as facilities for downloading the FTG Channel Map and FTG Installer Menu settings for TVs that are in FTG Mode via CPU.
- Pro:Centric application: The application, which operates in conjunction with FTG and PPV Modes, comprises the Pro:Centric interactive menus/features described on the previous page. Pro:Centric application settings are managed via the Pro:Centric server Admin Client.

The Data Channel and Pro:Centric Application Mode can be set using one of the following methods:

- If the TV is in Pass-through Mode, set Installer Menu items 098 PRO:CENTRIC and 119 DATA CHANNEL to the appropriate values. Refer to “Installer Menu” information on pages 15 to 24 for further details. Also, as necessary, refer to “Custom Master TV Setup” information on pages 25 to 28 and/or cloning information on pages 34 to 42.

**Note:** When the TV is in either Pass-through or FTG Mode, you can also leave Installer Menu item 119 DATA CHANNEL set to its default value (255) to enable the TV’s Data Channel Auto Search feature to set the DATA CHANNEL value. See item 119 description on page 24 for additional information.

- If the TV is in FTG Mode, use the FTG File Manager to update the Pro:Centric and Data Channel Installer Menu items. Then, transfer the FTG Installer Menu settings to the TV. Refer to FTG Mode information on pages 43 to 49 for further details. Also, see note above regarding the option to use the TV’s Data Channel Auto Search feature to set the DATA CHANNEL value.

**Note:** If using a Pro:Centric pillow speaker, also set Installer Menu item 027 HOSPITAL MODE to the required value.

# Express Script Installer Menu Wizard

---

The Express Script Installer Menu Wizard guides you through the process of setting up the essential items for most hospital TV viewing applications and also enables you to configure the Pro:Centric settings on the TV. The wizard will appear on the screen each time the TV is turned ON, until configuration is completed or the wizard is exited. Use the Installer Remote to make selections and complete each step.

**Note:** If it has been completed or exited and therefore does not display, the Express Script Installer Menu Wizard can be re-activated; however, this requires that factory defaults be restored on the TV(s). Refer to Reference section, “Restoring Factory Defaults on the TV(s),” for further information.

**Note:** If you plan to create a customized Master TV Setup using the procedure described on pages 25 to 28, transfer (Teach) a Master TV Setup to a Target TV, or configure a TV for FTG Mode of operation, be sure to exit the Express Script in order to avoid setup conflicts that may cause the TV to malfunction.

 **Note: If you bypass the Express Script, pillow speaker functionality will not be enabled unless you set Installer Menu item 027 HOSPITAL MODE appropriately. See the “Installer Menu” section of this document for further information.**

 **Note: If you press CC or ⏪ on the Installer Remote to exit the Express Script Installer Menu Wizard at any time while it is in progress, any settings made will not be retained.**

## Initiate Configuration or Exit the Express Script Installer Menu Wizard

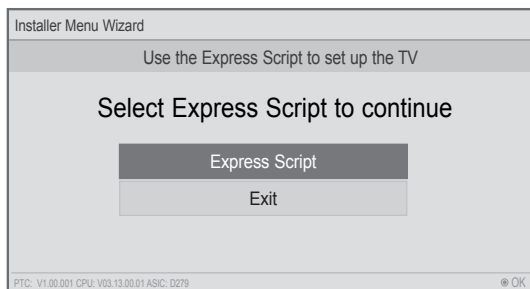

From the Express Script launch screen, you have the following options:

- To proceed with the Express Script Installer Menu Wizard, use the Up/Down arrow keys on the Installer Remote to select/highlight **Express Script**. Then, press **OK** on the Installer Remote.

**Note:** You can select the “Express Script” option if you want to configure Pro:Centric settings on this TV, even if you do not intend to complete the TV configuration using the Express Script. After you configure the Pro:Centric settings, you will have the option to exit the remainder of the wizard, if desired.

- To exit the wizard without completing any configuration, use the Up/Down arrow keys on the Installer Remote to select/highlight **Exit** and press **OK**.

## Configure Pro:Centric Settings

The next wizard screen enables you to set up the Pro:Centric feature of the TV. By default, the Data Channel is configured for Auto Search, which enables the TV’s Data Channel Auto Search feature to set the Data Channel value. See item 119 DATA CHANNEL description on page 24 for further information on the Data Channel Auto Search feature. The Pro:Centric Mode default setting is “Configuration Only,” which enables remote management only. That is, the TV will search for TV E-Z Installation data downloads; however, Pro:Centric application data will not be downloaded, i.e., Installer Menu item 098 PRO:CENTRIC will be set to 0.

## Express Script Installer Menu Wizard (Cont.)

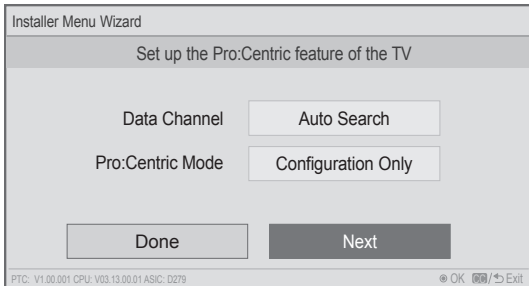

If you wish to proceed with the wizard without changing the Data Channel and Pro:Centric Mode default values, you can simply select **Next** and press **OK** on the Installer Remote. Or, if you wish to exit the wizard while retaining the Data Channel and Pro:Centric Mode default values, use the arrow keys on the Installer Remote to select **Done**, and then press **OK**.

If you already know the Data Channel and Pro:Centric Mode settings that need to be configured in order for the TV to connect to the Pro:Centric server and/or if the Pro:Centric server is not yet installed, follow the procedure below to expedite the setup process. Use the Up/Down arrow keys on the Installer Remote to navigate between the fields.

**Note:** If you wish to disable the Pro:Centric feature of the TV, select the Data Channel field, and then use the Left/Right arrow keys on the Installer Remote to select **Disabled**. From here, you may opt to proceed with the wizard (select **Next**) or save this setting and exit the wizard (select **Done**). See also step 3 below.

1. In the Data Channel field: Either key in or use the Left/Right arrow keys on the Installer Remote to select the RF channel number that will be used by the Pro:Centric server as its data channel. The Data Channel can be set from 1 to 135. \*
2. In the Pro:Centric Mode field, use the Left/Right arrow keys on the Installer Remote to select the appropriate Pro:Centric Application Mode—GEM, FLASH, or Configuration Only.
3. Once the fields are completed as required, you have two options:
  - To proceed with TV configuration via the wizard, select **Next** and press **OK** on the Installer Remote. See also “Complete the TV Configuration” on the following page.
  - To save the data entered and exit the wizard, select **Done** and press **OK** on the Installer Remote. Remember, however, that if you bypass the Express Script, pillow speaker functionality will not be enabled unless you set Installer Menu item 027 HOSPITAL MODE appropriately. See the “Installer Menu” section of this document for further information.

**Note:** These TV models support the optional TV Zoning feature that enables location-specific configuration. In order to use the TV Zoning feature on this TV, you **MUST** assign the TV Zone # in the TV while the TV is in Pass-through Mode. Thus, if you plan eventually to configure the TV for FTG Mode and you wish to assign a TV Zone # for the TV, do so immediately after you complete or exit the Express Script, while you still have access to the TV setup menus (as opposed to the Function Menu available in FTG Mode). See Reference section, “Using the TV Zoning Feature,” for further information.

\* PCS150R and later Pro:Centric servers do not support HRC or IRC cable channel frequencies.

# Express Script Installer Menu Wizard (Cont.)

## Complete the TV Configuration

The following procedure describes the remaining Express Script Installer Menu Wizard steps. You can select the “Back” button, where available, to check previous settings, as necessary.

### 1. Select the tuning band.

Use the Up/Down arrow keys on the Installer Remote to select the tuning band field, and then use the Left/Right arrow keys to select the appropriate tuning band: Cable Standard (default), Cable HRC, Cable IRC, or Air. When you have made your selection, use the arrow keys to select **Next**, and then press **OK**.

### 2. Select the Aux inputs.

If you simply select **Next** and press **OK** in this step, default values will be used. Otherwise, use the Up/Down arrow keys on the Installer Remote to select the desired Aux input option(s).

- To customize settings, select **Customize Inputs** and press **OK**. Aux input options are displayed in a pop-up window. Use the arrow keys to select the input(s) to enable or disable. When you are finished, press **OK** on the Installer Remote. Then, continue with step 3.

**Note:** If you would like to return to the Aux Input screen, press **MENU** to close the pop-up window.

- To use default values, select **Use Default Values** and press **OK**. Then, continue with step 3.

### 3. Select the speaker configuration.

Use the Up/Down arrow keys on the Installer Remote to select the speaker configuration field, and then use the Left/Right arrow keys to select the appropriate speaker: Pillow Only (default), TV Only, or Pillow & TV. When you have made your selection, use the arrow keys to select **Next**, and then press **OK**.

### 4. Select the pillow speaker code.

If using a Pro:Centric pillow speaker (LG IR codes) or a pillow speaker with Zenith IR codes, you can simply select **Next** and press **OK** on the Installer Remote to accept the Zenith pillow speaker code default.

Otherwise, use the Up/Down arrow keys on the Installer Remote to select the pillow speaker code field, and use the Left/Right arrow keys to select the appropriate option. When you have made your selection, use the arrow keys to select **Next**, and then press **OK**.

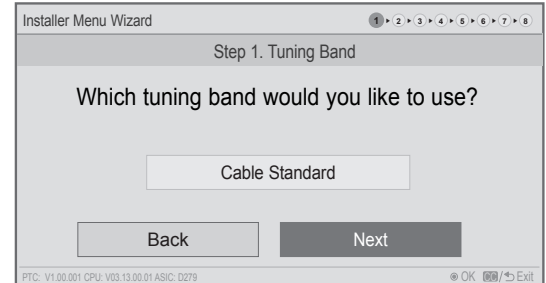

**Note:** Typically, if you do not modify the default settings, the “Next” option is automatically selected when you proceed forward within the wizard. Where appropriate, you can simply press **OK** on the Installer Remote to proceed to the next step if the default value(s) for the TV parameter(s) in question are applicable for your installation.

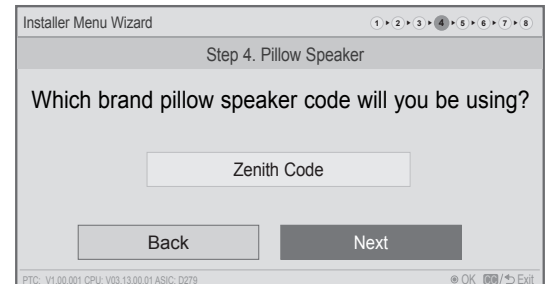
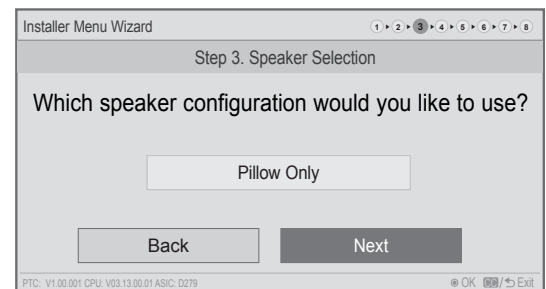
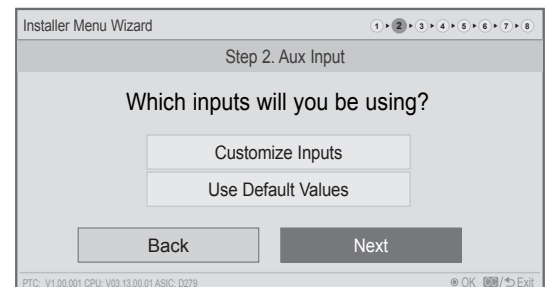

(Continued on next page)

# Express Script Installer Menu Wizard (Cont.)

(Continued from previous page)

## 5. Choose whether to allow access to channels outside the channel lineup.

To allow direct access to channels outside the channel lineup (default: Yes), you can simply select **Next** and press **OK** on the Installer Remote. To limit access to only the channel lineup (after the Express Script is complete) and restrict access to the TV setup menus, use the Up/Down arrow keys on the Installer Remote to select the channel access field, and then use the Left/Right arrow keys to select "No."

When you have made your selection, use the arrow keys to select **Next**, and then press **OK**.

**Note:** It is recommended that you select "No" to limit access to the channel lineup and prevent end users from accessing channel settings; i.e., the Channel Menu will be inaccessible/grayed out.

## 6. Run the Auto Search (Auto Tuning).

Select **Execute Auto Search** and press **OK** on the Installer Remote to start the channel scan (searches for all available analog and digital channels). The system will display progress of the channel scan in a pop-up window. The scan typically takes a few minutes.

When the channel scan is complete, press **OK** on the Installer Remote to close the pop-up window. Then, continue with step 7.

**Note:** If you do not want to run the Auto Search (for example, if you intend to manually add only a small number of channels and/or if the TV will eventually be configured for FTG Mode via CPU with Pro:Centric server downloads), use the arrow keys on the Installer Remote to select **Next**, and then press **OK**. Then, continue with step 7.

 **Note: You MUST select Execute Auto Search and press OK in order to run the channel scan. If you move on to the next step without running the Auto Search, there will be no channels in the channel lineup (Channel Map).**

## 7. Edit the Channel Map.

This option enables you to add/delete channels, select channel icons, add channel labels, and/or set up channel banks before the Channel Map is transferred to the commercial controller (PTC) in step 8.

 **Note: The maximum number of channels (analog, digital, and Aux inputs) that can be transferred to the PTC is 141. An attempt to transfer more than 141 channels of any combination will result in a PTC Channel Map of exactly 141 channels; any extra channels will not be available in the PTC Channel Map. For example, if you enabled three Aux inputs in step 2 and Auto Tuning found 141 channels, you must edit the Channel Map to decrease the number of analog/digital channels to (at most) 138 in order to accommodate the Aux inputs in the PTC Channel Map.**

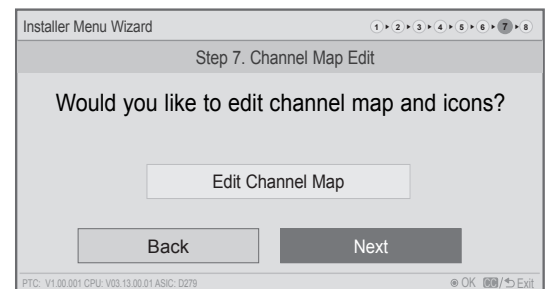
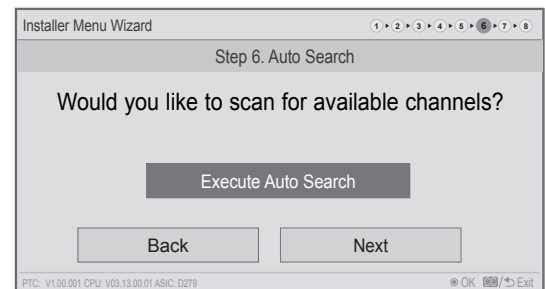
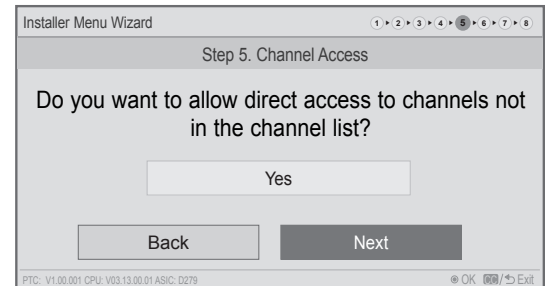

(Continued on next page)

## Express Script Installer Menu Wizard (Cont.)

(Continued from previous page)

Select **Edit Channel Map** and press **OK** on the Installer Remote to edit the Channel Map, as necessary. Channel edit options will be displayed in a pop-up window (see example at right). Use the Up/Down arrow keys to navigate between fields:

- **CH \ Input:** Edit the channel lineup, as necessary, to include only free to guest (non-encrypted) channels. Use the Left/Right arrow keys on the Installer Remote to select channels, and press **OK** to add/delete channels per your system requirements.
- **Icon:** Use the Left/Right arrow keys or key in the icon number to select the appropriate trademark/icon for each channel's Channel-Time on-screen display. Icons are available for familiar channels, such as ABC, CBS, NBC, etc. Identifiable icons should enable the end user to readily know what common networks are available.
- **Label:** Press **OK** to display the alphanumeric keypad, and add custom text labels for each channel, as desired. Added custom labels will be displayed above the Label/Keypad field for each channel, as applicable.
- **Bank:** Use the arrow keys to define channel banks, as desired. See pages 30 to 33 for further information on channel banks.

When you are finished, press **MENU** to close the pop-up window. Use the arrow keys to select **Next**, and then press **OK**.

### 8. Completion.

In the final step, the TV saves your settings and transfers the setup to the commercial controller (PTC). (This is similar to 2-5-5 + MENU Mode during Custom Master TV Setup.) When this step is complete, the Express Script Installer Menu Wizard closes.

**Note:** If desired, you can copy the TV Setup created using the Express Script to a cloning tool—a USB memory device or a clone programmer—for transfer to Target TVs. See cloning procedures in this document.

**Note:** If access to the channel lineup has been limited at the completion of the Express Script (see step 5) and you would like to set up channel banks at a later time, you will need to set Installer Menu item 028 CH.OVERRIDE to 1 to enable access to the Channel Preview/Banks Setup Menu. See pages 30 to 33 for further information on channel banks.

**Note:** You can also edit/add channel icons and/or custom text labels in 2-5-4 + MENU Mode after the Express Script is completed, if necessary. See page 29 for further information.

**Note:** If the TV eventually will be configured for FTG Mode via CPU with Pro:Centric server downloads, and you wish to assign a TV Zone # for the TV, do so immediately following this procedure, while you still have access to the TV setup menus (as opposed to the Function Menu available in FTG Mode). See Reference section, "Using the TV Zoning Feature," for further information.

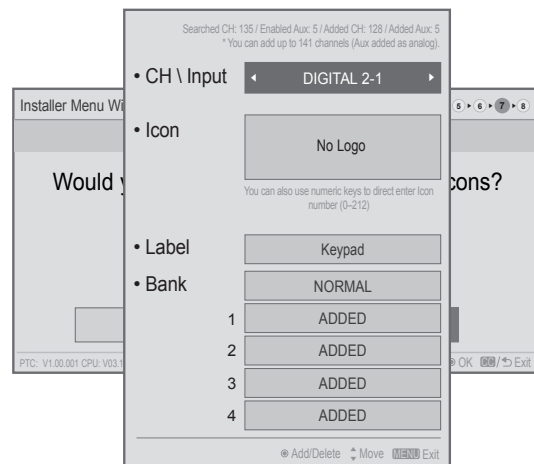

**Note:** The total number of channels found ("Searched") during Auto Tuning is indicated at the top of the display.

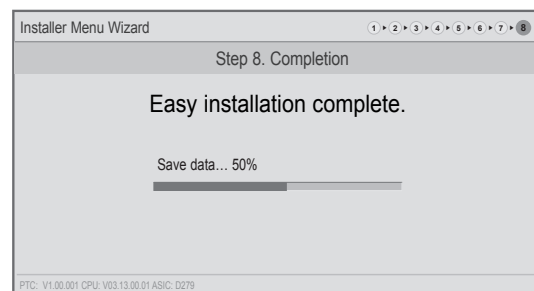

Use the Installer Menu to set up, change, or view operational settings. This section describes how to access, use, and exit the Installer Menu from the TV itself; however, you should also refer to the Installer Menu descriptions in this document if you are configuring the TV using LG's FTG configuration software.

Refer to the table on pages 17 and 18 for brief descriptions of Installer Menu items. More detailed descriptions follow the table listing.

## Accessing the Installer Menu

1. Turn ON the TV.

If the Express Script Installer Menu Wizard appears on the screen when you turn ON the TV, use the Up/Down arrow keys on the Installer Remote to select **Exit**, and then press **OK** to exit the wizard.

2. Using an Installer Remote, press **MENU** repeatedly until the on-screen display of the TV setup menus (if the TV is in Pass-through Mode) or the Function Menu (if the TV is not in Pass-through Mode) no longer toggles, and then press the Installer Menu entry sequence (e.g., **9-8-7-6**) + **OK** to access the Installer Menu.

**Note:** The default Installer Menu entry sequence is "9876"; however, if Installer Menu item 000 INSTALLER SEQUENCE has been modified, the entry sequence may be one of three additional options. See Installer Menu detailed descriptions for further information.

The Installer Menu opens with item 000 INSTALLER SEQ 000.

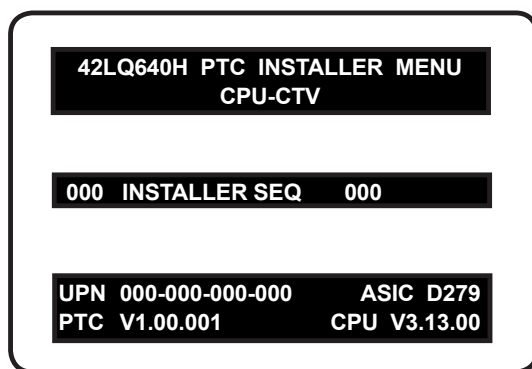

Typical Installer Menu

**Note:** If the password (entry sequence) is not entered or registered correctly, you will see the message "ENTER PASSWORD 0000" at the top of the screen instead of the Installer Menu header. Once you re-enter the correct password (e.g., press 9-8-7-6 + OK), the Installer Menu will display.

**Note:** If the TV is not in Pass-through Mode, the Installer Menu is accessible as read-only. Also, the TV Zone # will be indicated in the Installer Menu header under the configuration mode indicator described on the following page.

## Installer Menu (Cont.)

---

As part of the Installer Menu header (in all modes), two 3-character acronyms are displayed to indicate the TV's current configuration mode. The table below lists all possible mode identifiers for these TV models.

Acronym	Description
CPU-CTV	Pass-through Mode with Channel Map in CPU
CPU-FTG	FTG Mode via CPU
CPU-P:C	Application Tuning Mode via CPU
MPI-EXT	External MPI Control
PTC-CTV	Pass-through Mode with Channel Map in PTC

### Using the Installer Menu

Refer to the table starting on the next page for an overview of the available Installer Menu items, including their item numbers, functions, value ranges, and default values.

Installer Menu items not relevant to these TV series are not present in the Installer Menu; therefore, some numbers are missing. For example, item 006 will not appear. In addition, items that are dependent on other Installer Menu item settings will not be initially accessible. For example, item 046 STRT AUX SRCE will not display in the Installer Menu unless item 004 STRT CHANNEL is set to 0.

### Navigation within the Installer Menu

Use the Up/Down arrow keys on the Installer Remote to sequence through the available menu items, or access an item directly by keying in the item number and then pressing **MENU**. For example, to access the SLEEP TIMER option, which is item 015, press 0-1-5 + MENU.

### Changing Installer Menu Settings

To change an Installer Menu item value, use the Left/Right arrow keys on the Installer Remote, or enter a valid value directly. To save the new setting, press **OK**, or use the Up/Down arrow keys to navigate to a new Installer Menu item if you have additional items to edit. Note that invalid values will not be saved.

### Exiting the Installer Menu and Activating Settings

After you have adjusted all Installer Menu item settings as required, press **OK** once on the Installer Remote to save your changes; then, press **OK** again to exit the Installer Menu. Any changes you make will be stored in non-volatile memory.

**Note:** Each time you exit the Installer Menu in Pass-through Mode, all V-Chip (Parental Control) settings in the TV are reset to their default values; that is, the Lock System, if previously enabled from the Lock setup menu (see the Owner's Manual for additional information), will now be disabled, and the individual Parental Control settings will be restored to default values.



**Caution: Installer Menu settings may affect options available from the TV setup menus or the Function Menu.**



# Installer Menu (Cont.)

## Installer Menu Items 000 through 069

Menu Item	Function	Value Range	Default Value	Brief Description of Function
000	INSTALLER SEQ	0 ~ 3	0	Leave default set to 0.
001	POWER MANAGE	0 ~ 7	0	Sets number of hours of no activity before automatic shutoff.
002	AC ON	0 / 1	0	Set to 1 to enable TV to turn ON when AC power is applied.
003	BAND/AFC	0 ~ 3	1	Selects Tuning Band: 0=Broadcast, 1=CATV, 2=HRC, 3=IRC
004	STRT CHANNEL	0 ~ 127, 255	255	Channel tuned when TV is turned ON. (Set to 255 to tune to channel tuned before TV turned OFF.)
005	CHAN LOCK	0 / 1	0	If set to 1, cannot tune from current channel.
007	STRT VOLUME	0 ~ 63, 255	255	Volume level when TV is turned ON. (Set to 255 to use volume level before TV turned OFF.)
008	MIN VOLUME	0 ~ 63	0	Sets minimum allowable volume setting.
009	MAX VOLUME	0 ~ 63	63	Sets maximum allowable volume setting.
010	MUTE DISABLE	0 / 1	0	Set to 1 to disable Mute Function.
011	KEY DEFEAT	0 / 1	1	If set to 1, menu navigation buttons on display panel are not functional.
012	IR BANKS EN.	0 / 1	0	Set to 1 to enable TV to respond to bank discrete IR codes.
013	SCAN MODE	0 / 1	1	Set to 1 to allow Channel Up/Down to turn ON TV. (See detailed descriptions.)
014	STRT CH IN SM	0 / 1	0	Set to 1 to use the Start Channel for the Channel Map pivot point in Scan Mode.
015	SLEEP TIMER	0 / 1	1	Set to 1 to enable Sleep Timer.
016	EN TIMER	0 / 1	1	Set to 1 to enable On/Off Timers.
017	ALARM	0 / 1	1	Set to 1 to enable Alarm.
020	FEATURE LEVEL	0 ~ 1, 16 ~ 24, 64 ~ 65	1	Determines an additional IR code scheme to which the TV will respond.
021	V-CHIP	0 / 1	1	Set to 1 to enable V-Chip (Parental Control) functions.
022	MAX BLK HRS	0 ~ 99	12	Sets number of V-Chip blocking hours.
023	CAPTION LOCK	0 / 1	0	Set to 1 to retain caption setting before TV turned Off.
025	FUNCTION PRE.	0 ~ 1	1	Set to 1 to allow Channel Preview/Banks Setup Menu access via CH PREVIEW key on Installer Remote.
027	HOSPITAL MODE	0 ~ 162, 254	254	Set according to the speaker selection, the pillow speaker code/supply voltage, and the hospital IR code. See detailed instructions.
028	CH. OVERRIDE	0 / 1	1	If set to 0, limits direct access to favorite channels.
029	OLD OCV	0 / 1	0	Set to 1 to change MPI operation to OCV.
030	ACK MASK	0 / 1	0	If set to 1, enables ACK feature of MPI.
031	POLL RATE	20 ~ 169	94	Selects poll rate for MPI.
032	TIMING PULSE	186 ~ 227	207	Sets baud rate for MPI.
035	HDMI1 ENABLE	0 ~ 2	1	Set to 0 to disable HDMI 1. Set to 1 (DTV Mode) or 2 (PC Mode), as applicable, to enable HDMI 1.
039	REAR AUX EN	0 / 1	1	Set to 1 to enable display panel Video 1 input jack.
041	SIMPLINK EN	0 ~ 3	0	Determines the status of the SIMPLINK feature. (See detailed descriptions.)
042	AUTO INPUTS	0 ~ 255	0	Determines the Aux inputs for which auto-sensing is enabled. (See detailed descriptions.)
046	STRT AUX SRCE	1, 3 ~ 5, 7, 255	255	Sets the starting Aux source (if item 004 STRT CHANNEL is set to 0).
047	AUX STATUS	0 / 1	0	Set to 1 for MPI Aux source to be reported as a channel number instead of Channel 0.
053	DIS. CH-TIME	0 / 1	0	Set to 1 to disable Channel-Time display.
069	EN. CH-T COL.	0 / 1	1	Set to 1 to enable custom color for the Channel-Time display.

# Installer Menu (Cont.)

## Installer Menu Items 070 through 122

Menu Item	Function	Value Range	Default Value	Brief Description of Function
070	FOR. CH-TIME	0 ~ 7	2	Chooses custom foreground color for the Channel-Time display.
071	BCK. CH-TIME	0 ~ 7	2	Chooses custom background color for the Channel-Time display.
073	CH NOT AVBLE	0 / 1	0	If set to 1 and item 028 CH. OVERRIDE is set to 0, "NOT AVAILABLE" message is displayed if user direct tunes a channel that is not in the favorite channel list.
075	REVERT CH	0 / 1	0	If set to 1 and loss of MPI communication occurs, TV tunes to Start Channel.
077	QUICK SHUTOFF	0 ~ 17	0	Allows TV to be turned OFF with press and hold of pillow speaker channel buttons. Set to 0 to disable. Set from 1 to 17 to define hold time. (See detailed descriptions.)
078	UPN MSB	0 ~ 255	255	User programmable number, most significant byte.
079	UPN MSB-1	0 ~ 255	255	User programmable number, most significant byte - 1.
080	UPN MSB-2	0 ~ 255	255	User programmable number, most significant byte - 2.
081	UPN LSB	0 ~ 255	255	User programmable number, least significant byte.
082	CHKSM ERROR	0 / 1	1	If set to 1, enforces rigid MPI checksum.
083	HANDSHK TIME	0 ~ 5	5	Relaxes MPI timing to be compatible with PC-based Windows-controlled systems.
084	PERMANENT BLK	0 / 1	0	Removes block hours setting for Parental Control and makes block permanent.
087	REAR RGB EN.	0, 1, 17	1	Set to 0 to disable RGB input. Set to 1 to enable RGB input. Set to 17 for Auto Configure.
088	EN NOISE MUTE	0 / 1	1	If set to 1, audio is muted if no signal is present.
090	KEY LOCK	0 / 1	0	If set to 1, display panel buttons are locked. IR is still functional.
091	HDMI2 ENABLE	0 ~ 2	1	Set to 0 to disable HDMI 2. Set to 1 (DTV Mode) or 2 (PC Mode), as applicable, to enable HDMI 2.
092	HDMI3 ENABLE	0 ~ 2	1	Set to 0 to disable HDMI 3. Set to 1 (DTV Mode) or 2 (PC Mode), as applicable, to enable HDMI 3.
094	SAP MENU EN	0 / 1	1	Set to 0 to disable feature on Function Menu. Set to 1 to enable feature on Function Menu.
096	DEF. ASP. RATIO	0 ~ 4	2	Sets default aspect ratio at power up. See detailed descriptions and item 106.
097	AUDIO OUTPUT	0 ~ 9	7	Set as required in accordance with external audio equipment connected to the TV. See detailed descriptions.
098	PRO:CENTRIC	0 ~ 2	0	Set to 0 to disable Pro:Centric operation. Set to 1 for Flash Mode. Set to 2 for GEM (Java Application) Mode.
099	BACK LIGHTING	1 ~ 200, 255	255	Sets the level of the TV picture back lighting. (See detailed descriptions.)
102	ATSC BAND	0 ~ 4	4	Selects ATSC band.
103	ATSC TUNE MODE	0 / 1	1	Set to 1 (default) for Physical Channel scan. Set to 0 for Virtual Channel scan.
104	START MINOR CH	0 ~ 255	0	Selects Minor Start Channel. Set to 0 for NTSC.
106	ASP RATIO LOCK	0 / 1	0	To retain set aspect ratio on power cycle, set to 1. Set to 0 for default ratio on power cycle.
116	VIDEO MUTE EN	0 / 1	0	Set to 0 for Normal. Set to 1 for Blank.
117	FACT DEFAULT	0 / 1	0	Set to 0 for Normal. Set to 1 to load presets for all Installer Menu settings.
119	DATA CHANNEL	0 ~ 135, 255	255	Set to 0 to disable. Set from 1 to 135 to match the RF channel number used by the Pro:Centric server as its data channel. Set to 255 to use Auto Search to find the Pro:Centric RF channel. (See detailed descriptions.)
121	P:C RF WAKE HR	0 ~ 23, 128	128	Sets the hour for Wake On RF. The value "128" is displayed as "OFF." Directly entering 128 turns the Wake On RF feature OFF.
122	P:C RF WAKE MN	0 ~ 59	0	Sets the minute for Wake On RF.

## Detailed Descriptions of Installer Menu Items

### 000 - INSTALLER SEQUENCE

Specifies entry sequence to the Installer Menu.

0 = 9876                      1 = 4321  
2 = 1478                      3 = 3698

### 001 - POWER MANAGE (Power Management)

Determines hours of no activity before automatic shutoff. The Power Management function is for saving energy. If set to 0, Power Management is Off. Settings range from 0 ~ 7, with 1 ~ 7 representing the hours that the unit will remain ON, unless there has been activity from either the control panel or remote control.

### 002 - AC ON (AC Power Switchable)

If set to 1, this allows the TV to turn ON when AC power is applied. Pressing the POWER button is not necessary. This is desirable if the TV is plugged into a switched AC outlet (i.e., a set-top box). Set to 0 (default) for standard TV turn ON/OFF operation.

**Note:** If set to 1, the TV does not respond to ON/OFF commands from either the remote or the display panel, and the SLEEP TIMER is also nonfunctional.

### 003 - BAND/AFC (Band/Automatic Frequency Control)

There are four possible settings for this option:

0 = Broadcast                      1 = CATV (default)  
2 = HRC                              3 = IRC

If some channels were not found by Auto Tuning (Channel Search), select the appropriate Band setting here, and add the channels using the Channel Edit option in the Channel Menu.

### 004 - STRT CHANNEL (Start Channel)

If active, this function allows you to determine the initial Major Start Channel number when the TV is turned ON. This feature is useful for an in-house information channel, since the TV would always select that channel when it is turned ON. If set to 255, the last channel tuned before the TV was turned OFF will be the channel tuned when the TV is turned ON again.

0 = Aux                                      127 = Map to Major CH 4  
1 ~ 125 = Major CH #                      255 = Last Channel  
126 = Map to Major CH 3

**Note:** For a digital Start Channel, always remember to set item 104 to the Minor Start Channel number.

**Note:** 126 and 127 are mapped only in LodgeNet PPV Mode.

### 005 - CHAN LOCK (Channel Lock)

Channel Lock is ideal if the system must always be on the same channel. Changing channels with the Channel Up/Down or keypad numbers is impossible. Channel Lock is inactive if set to 0 (default).

Generally, this feature is used in connection with item 004 STRT CHANNEL where the Start Channel may, for example, be set to 3 or 4. If the Start Channel is 3, then the TV will remain locked on channel 3.

**NOTE:** For items 007, 008, and 009

For legacy reasons, the scale used is 0 - 63. The PTC software will translate this to the 0 - 100 scale used by the TV.

To translate a TV volume level to the Installer Menu value, use the following formula:

$$\text{Installer Value} = \frac{\text{TV Value} \times 63}{100}$$

Enter only the whole number (disregard fractions).

### 007 - STRT VOLUME (Start Volume)

This function allows the Installer to determine the initial volume level setting when the TV is turned ON. This feature is useful for an in-house information channel, since the TV will always select that volume level when it is turned ON. The range of values is 0 to 63, 255. If set to 255, the last volume level before the TV was turned OFF will be the current volume level when the TV is turned ON again.

### 008 - MIN VOLUME (Minimum Volume)

This function determines the minimum volume level allowable with the Volume (VOL) Up/Down control. In this way, for example, someone cannot set the volume too low to hear. The value range is from 0 to 63. The factory default is 0, which provides the full range of volume control, if item 009 MAX VOLUME is set to 63. It is recommended to set the same value on every TV.

**Note:** The minimum volume level cannot have a value setting higher than the maximum volume level (described below).

### 009 - MAX VOLUME (Maximum Volume)

This function determines the maximum volume level allowable with the Volume (VOL) Up/Down control. In this way, for example, someone cannot set the volume level high enough to disturb others. The value range is 0 to 63, with 63 as the default, which gives the user the full range of volume control, if item 008 MIN VOLUME is set to 0. It is recommended to set the same value on every TV.

**Note:** The maximum volume level cannot have a value setting lower than the minimum volume level (described above).

### 010 - MUTE DISABLE

Enables or disables sound mute function. If set to 1, sound cannot be muted. If set to 0, sound can be muted.

### 011 - KEY DEFEAT

If set to 1, Key Defeat is enabled, which means that end users cannot navigate within the on-screen menu(s) from the display panel, i.e., menu navigation buttons on the display panel will not function. Set to 0 to disable Key Defeat. Note that all IR features remain functional regardless of this setting.

# Installer Menu (Cont.)

## 012 - IR BANKS EN (IR Banks Enable)

For direct access to a particular channel bank. When enabled, you can access a channel bank by inputting the discrete IR code for that bank.

**Note:** This item is not available in the Installer Menu when item 027 HOSPITAL MODE is set to 0.

## 013 - SCAN MODE (Functional after 2-5-5 + MENU transfer of Channel Map)

When set to 1 (default), allows TV to be turned ON when Channel Up/Down buttons are pressed on pillow speaker. Also, TV will turn OFF when Channel Up/Down key is used to tune above or below Channel Map pivot point. By default, Channel Map pivot point is between the highest and lowest channel in the Channel Map (also see item 014 STRT CH IN SM). Set to 0 to disable.

## 014 - STRT CH IN SM (Start Channel in Scan Mode)

Only valid when item 013 SCAN MODE is set to 1 (enabled). When set to 1, forces Channel Map pivot point to be between the RF channel designated in item 004 STRT CHANNEL and next lower channel in the Channel Map. Set to 0 to disable (default).

**Note:** This item is not available in the Installer Menu when item 013 SCAN MODE is set to 0.

## 015 - SLEEP TIMER

If set to 1, the Sleep Timer feature may be used. If set to 0, the Sleep Timer is not available.

## 016 - EN TIMER (Enable On/Off Timers)

If set to 1, the Timer function is available to the end user and enabled continuously. Set to 0 to disable On/Off timers.

**Note:** The TV clock must be set in order for timers to be used.

## 017 - ALARM

Gives the installer the option of making the Alarm function available to the end user. If set to 1, the Alarm function is available to the end user. Set to 0 to disable the Alarm function.

**Note:** The TV clock must be set before the Alarm function will work.

## 020 - FEATURE LEVEL

This function determines an additional IR code scheme to which the TV will respond, allowing for the use of unique IR codes based on "bed number" in a multi-TV single room installation. First determine the IR mode; then select the bed number.

**Note:** Item 027 HOSPITAL MODE must be set to 0 to enable Legacy Zenith Bed 1 or Bed 2 IR codes and Speaker selections.

Values	IR Mode	Bed #	Speaker
0 – 1	Legacy Zenith (Hospital)	1 – 2	TV
16 – 24	Multi-code Remote	1 – 9	TV
64 – 65	Legacy Zenith (Hospital)	1 – 2	Pillow

**Note:** For further information, see documentation for the accessory package that includes the multi-code remote.

## 021 - V-CHIP (Parental Control)

Set to 1 to activate V-Chip (Parental Control) and have it available to the end user to filter and control or otherwise restrict programming content that can appear. Set to 0 to turn the V-Chip feature Off (not available to user); no programming restrictions can be set.

## 022 - MAX BLK HRS (Maximum Block Hours)

Sets hours from 0 to 99 for the maximum V-Chip (Parental Control) block hours. Default setting is for 12 blocking hours.

**Note:** This item is not available in the Installer Menu when item 084 PERMANENT BLK is set to 1.

## 023 - CAPTION LOCK

If set to 0, captions are OFF when the TV is turned ON. Set to 1 to use the caption setting configured before the TV was turned OFF when the TV is turned ON.

## 025 - FUNCTION PRE (Function Preview)

Set to 1 to allow access to the Channel Preview/Banks Setup Menu via the CH PREVIEW key on Installer Remote. Set to 0 to disable access to the Channel Preview/Banks Setup Menu.

## 027 - HOSPITAL MODE

Set according to the speaker selection, the pillow speaker code/ supply voltage and the hospital IR code. If using a Pro:Centric pillow speaker, select one of the Zenith codes in accordance with the desired speaker selection. See table below.

Value	Speaker	Pillow Speaker Code/Voltage	Hospital IR Code
000	Determined by item 020 setting	Zenith (+12v)	Determined by item 020 setting
001	Pillow Only	Zenith (+12v)	Zenith Bed #1
002	Pillow Only	Zenith (+12v)	Zenith Bed #2
017	Pillow Only	Philips (+5v)	Zenith Bed #1
018	Pillow Only	Philips (+5v)	Zenith Bed #2
033	Pillow Only	RCA (-5v)	Zenith Bed #1
034	Pillow Only	RCA (-5v)	Zenith Bed #2
065	TV Only	Zenith (+12v)	Zenith Bed #1
066	TV Only	Zenith (+12v)	Zenith Bed #2
081	TV Only	Philips (+5v)	Zenith Bed #1
082	TV Only	Philips (+5v)	Zenith Bed #2
097	TV Only	RCA (-5v)	Zenith Bed #1
098	TV Only	RCA (-5v)	Zenith Bed #2
129	Both Pillow & TV	Zenith (+12v)	Zenith Bed #1
130	Both Pillow & TV	Zenith (+12v)	Zenith Bed #2
145	Both Pillow & TV	Philips (+5v)	Zenith Bed #1
146	Both Pillow & TV	Philips (+5v)	Zenith Bed #2
161	Both Pillow & TV	RCA (-5v)	Zenith Bed #1
162	Both Pillow & TV	RCA (-5v)	Zenith Bed #2
254	TV Only	Disabled (0v)	Zenith Bed #2

When Hospital Mode is enabled and the TV is in Pass-through Mode, channel banks are also available. Refer to channel banks information in this document for further details.

Channel banks are not supported if Hospital Mode is set to 0 or on TVs that are configured for FTG Mode operation.

When Hospital Mode is set to 0 (disabled), both the IR code that will control the TV and the speaker selection depend on the Installer Menu item 020 FEATURE LEVEL setting.

**Note:** The default setting (254) is not selectable in the Installer Menu. If you ever need to restore the default setting, you must set item 117 FACT DEFAULT to 1 to reload the factory default settings. See item 117 description for further information.

**Note:** In the Installer Menu, an informational code is displayed at the right of each Hospital Mode value. Each code consists of three characters. The first character—T, P, or B—identifies the speaker: TV, Pillow, or Both. The second character—Z, P, R, or D—identifies the pillow speaker code: Zenith, Philips, RCA, or Disabled. The third character—1 or 2—identifies the bed number. In the table on the previous page, each bolded character represents an element of the Hospital Mode code.

## 028 - CH. OVERRIDE (Channel Override)

If set to 1, the user can select channels with either Channel Up/Down or by direct keypad entry. If set to 0, only those channels that are active in the TV's memory can be selected.

## 029 - OLD OCV (On Command Video™)

Set to 1 to remap the PTC's direct tune channels for Aux inputs from 13x to 9x. This allows 2-digit only tuning systems (i.e., legacy OCV) to direct tune Aux inputs. See also Reference section, "TV Aux Input Configuration."

## 030 - ACK MASK

MPI Communication Parameter. When set to 1, enables ACK feature of MPI.

## 031 - POLL RATE

MPI Communication Parameter. Selects poll rate for MPI. Step size of 16 ms. Changing from default may affect communication via MPI.

## 032 - TIMING PULSE

MPI Communication Parameter. Sets baud rate for MPI. Step size of 4.3 uS. Changing from default may affect communication via MPI.

## 035 - HDMI1 ENABLE

Set to 1 to enable HDMI 1 input in DTV Mode. Set to 2 to enable HDMI 1 input in PC Mode. Set to 0 to disable display panel HDMI 1 input.

## 039 - REAR AUX EN. (Rear Aux Enable)

Set to 1 to enable display panel rear Aux (Video 1) input. Set to 0 to disable display panel rear Aux (Video 1) input.

## 041 - SIMPLINK EN

Set to 0 to disable the SIMPLINK feature. Set to 1 to enable SIMPLINK functionality without enabling remote control access to the SIMPLINK Menu. Set to 2 to enable both SIMPLINK functionality and SIMPLINK Menu access, though note that the Speaker menu option will be inaccessible/grayed out. Set to 3 to enable all aspects of SIMPLINK feature and SIMPLINK Menu. If a home theater device is connected to the TV, users can select either the TV or HT (home theater) speaker.

**Note:** When both this item *and* item 042 AUTO INPUTS are enabled in the Installer Menu, HDMI inputs will be detected by SIMPLINK, but the Auto Input(s) Sensing Feature will not function.

**Note:** Use of the SIMPLINK feature requires a compatible remote.

## 042 - AUTO INPUTS

Determines the Aux inputs for which auto-sensing is enabled. Set to 0 to disable auto-sensing for all available inputs. Set to 255 to enable auto-sensing for all available inputs. For information on options for individual input settings, refer to Reference section, "Auto Input(s) Sensing Feature."

**Note:** In order for auto-sensing to be enabled for an input, that input must also be enabled in the Installer Menu. For example, to enable auto-sensing for HDMI 1, item 035 HDMI1 ENABLE must also be set to 1 or 2. Also, see note above regarding TV operation when both this item and item 041 SIMPLINK EN are enabled.

## 046 - STRT AUX SRCE (Start Aux Source)

Sets the starting Aux source. When turned ON, the TV will tune to starting Aux source if item 004 STRT CHANNEL is set to 0.

1 = Video 1      4 = RGB      7 = HDMI 3  
3 = HDMI 1      5 = HDMI 2      255 = Last Aux

**Note:** Above is applicable only if all Aux sources are enabled.

**Note:** This item is not available in the Installer Menu unless item 004 STRT CHANNEL is set to 0.

## 047 - AUX STATUS

Set to 1 for MPI Aux source to be reported as a channel number instead of channel 0. Set to 0 to disable Aux identification change. Controls MPI status channel response for Aux inputs.

## 053 - DIS. CH-TIME (Disable Channel-Time)

Set to 1 to disable the Channel-Time display; Channel-Time display will not appear. Set to 0 to enable the Channel-Time display.

## 069 - EN. CH-T COL. (Enable Channel-Time Custom Color)

Set to 1 to enable custom color for the Channel-Time display. Set to 0 to disable custom color for the Channel-Time display.

# Installer Menu (Cont.)

---

## **070 - FOR. CH-TIME (Channel-Time Display Foreground Color)**

Set according to Color Chart:

0 = Black	3 = Cyan	6 = Yellow
1 = Blue	4 = Red	7 = White
2 = Green	5 = Violet	

**Note:** If foreground color and background color are the same, the menu background will be transparent.

**Note:** Applies only to “Channel Not Available” message if item 073 CH NOT AVBLE is set to 1 (enabled). Also, items 070 FOR. CH-TIME and 071 BCK. CH-TIME are not available in the Installer Menu when item 069 EN. CH-T COL. is set to 0.

## **071 - BCK. CH-TIME (Channel-Time Display Background Color)**

See description for item 070 FOR. CH-TIME above. The color chart is the same for both items.

## **073 - CH NOT AVBLE (Channel Not Available)**

If set to 1 and item 028 CH. OVERRIDE is set to 0, a “NOT AVAILABLE” message is displayed when a user direct tunes a channel that is not in the channel scan list available in memory.

**Note:** This item is not available in the Installer Menu when item 028 CH. OVERRIDE is set to 1.

## **075 - REVERT CH (Revert to Start Channel)**

If set to 1 and loss of MPI communication occurs, TV automatically tunes to the specified Start Channel.

**Note:** This item is not available in the Installer Menu when item 004 STRT CHANNEL is set to 255.

## **077 - QUICK SHUTOFF**

Allows end user (patient) to turn OFF TV using mechanical (analog) Pillow Speaker Channel Up/Down buttons. Patient needs to press and hold either channel button for time determined by value set. Set to 0 to disable. Set from 1 to 17 to establish required hold time of button—from 2 seconds to 10 seconds in half-second increments.

**Note:** This item is not available in the Installer Menu when item 013 SCAN MODE is set to 0.

## **078 - UPN MSB (UPN Most Significant Byte)**

User programmable number, most significant byte readable by MPI command. Note: Not linked to serial number.

## **079 - UPN MSB-1 (UPN Most Significant Byte-1)**

User programmable number, most significant byte-1 readable by MPI command. Note: Not linked to serial number.

## **080 - UPN MSB-2 (UPN Most Significant Byte-2)**

User programmable number, most significant byte-2 readable by MPI command. Note: Not linked to serial number.

## **081 - UPN LSB (UPN Least Significant Byte)**

User programmable number, least significant byte readable by MPI command. Note: Not linked to serial number.

## **082 - CHKSM ERROR (Checksum Error)**

Enforces rigid MPI checksum validation. Set to 1 for validation. Set to 0 to disable (does not check checksum on MPI async port). SPI is always checked.

## **083 - HANDSHK TIME (Handshake Time)**

Adds an additional delay to the handshake time which is 64 msec, thus relaxing MPI timing requirements to be compatible with PC-based Windows controlled systems. Range is 0 - 5. (Timeout = 25.5MS + [25.5 MS\* Handshake time].)

## **084 - PERMANENT BLK (Permanent Block)**

Allows Lock (Parental Control) blocking schemes to be permanent by disabling the blocking hours function. Set to 1 to install Parental Control restrictions permanently. Set to 0 for user-specified hours control of blocking schemes.

## **087 - REAR RGB EN. (Rear RGB Enable)**

Controls access to rear RGB input on TV. Set to 0 to disable RGB input. Set to 1 to enable RGB input. Set to 17 to initiate a one-time automatic configuration after an AC power cycle; otherwise, automatic adjustment will be performed each time the RGB input is accessed.

## **088 - EN NOISE MUTE (Enable Noise Mute)**

If set to 1, audio mutes when no signal is present.

## **090 - KEY LOCK**

If set to 1, Key Lock is enabled, which means that all display panel buttons will be locked, i.e., non-functional. Set to 0 to disable Key Lock. Note that all IR features remain functional regardless of this setting.

## **091 - HDMI2 ENABLE**

Set to 1 to enable HDMI 2 input in DTV Mode. Set to 2 to enable HDMI 2 input in PC Mode. Set to 0 to disable display panel HDMI 2 input.

## **092 - HDMI3 ENABLE**

Set to 1 to enable HDMI 3 input in DTV Mode. Set to 2 to enable HDMI 3 input in PC Mode. Set to 0 to disable display panel HDMI 3 input.

## **094 - SAP MENU EN (2nd Audio Program)**

Set to 1 to enable SAP feature on Function menu, if Function Menu is available (i.e., the TV is not in Pass-through Mode). Set to 0 to disable SAP feature on Function Menu, if Function Menu is available.

## 096 - DEF. ASP. RATIO (Default Aspect Ratio)

Selects default aspect ratio at power up.

- Set to 0 for Set By System.
- Set to 1 for 4:3.
- Set to 2 for 16:9 (default).
- Set to 3 for Just Scan.
- Set to 4 for Zoom.

**Note:** This item is not available in the Installer Menu unless item 106 ASP RATIO LOCK is set to 0.

## 097 - AUDIO OUTPUT

Determines availability and signal type/level (fixed speaker, variable speaker, or fixed line level [amplifier]) of the audio output to be used by external audio equipment connected to the Speaker Out jack on the TV. Set to 0 to disable audio output. Otherwise, see the table below and set as required in accordance with audio equipment.

	Value	Status
Speaker Output	1	Fixed 0.01 Watts
	2	Fixed 0.03 Watts
	3	Fixed 0.05 Watts
	4	Fixed 0.10 Watts
	5	Fixed 0.20 Watts
	6	Fixed 0.50 Watts
	7	Fixed 1.00 Watt (default)
	8	Control with volume
Line Output	9	Fixed line level (typically 400 mVrms ± 100 mVrms @10KΩ) output

See also Reference section, “External Stereo Speaker Setup.”

## 098 - PRO:CENTRIC

Selects the Pro:Centric Application Mode. Set to 0 (default) to disable Pro:Centric operation. Set to 1 for Flash Mode. Set to 2 for GEM (Java Application) Mode.

The TV must be turned OFF for a few seconds to initiate the Pro:Centric application download. When it is turned OFF for a second time, the TV will load the Pro:Centric application.

**Note:** This item is not available in the Installer Menu when item 119 DATA CHANNEL is set to 0.

## 099 - BACK LIGHTING

Sets the TV screen brightness at power up. Default setting is 255.

- 1 - 100 Static Back Lighting  
(1 = Dimmest picture, 100 = Brightest picture)
- 101 - 200 Dynamic Back Lighting  
(101 = Dimmest picture, 200 = Brightest picture)

If set between 101 and 200, the TV automatically controls back lighting depending upon the picture level of the current program. If set to 255, back lighting is controlled via the Picture settings in the TV's setup menus.

## 102 - ATSC BAND

Sets up TV to receive different types of incoming signals:

0 = Broadcast, 1 = CATV, 2 = HRC, 3 = IRC, 4 = Same as NTSC.

## 103 - ATSC TUNE MODE

Sets ATSC tuning mode: Default set to 1 for Physical Channel scan. Set to 0 for Virtual Channel scan.

## 104 - START MINOR CHANNEL

Sets Minor Start Channel number at power up. 0 = NTSC. If not 0, number selected is the digital channel's Minor Start Channel number.

**Note:** This item is not available in the Installer Menu when item 004 STRT CHANNEL is set to 0 or 255.

## 106 - ASP RATIO LOCK (Aspect Ratio Lock)

Set to 1 to retain previous aspect ratio with power off. Set to 0 to retain default aspect ratio with power off. See item 096 DEF. ASP. RATIO above.

## 116 - VIDEO MUTE EN (Video Mute Enable)

Set to 0 for Normal. Set to 1 for Blank.

## 117 - FACT DEFAULT (Factory Default)

Set to 0 for normal. Set to 1 to restore the factory default settings of all Installer Menu items. The restoring of factory defaults will also re-activate the Express Script Installer Menu Wizard (see pages 10 to 14).



**Caution: If set to 1, this will restore the factory defaults and clear the channel lineup, including any assigned channel icons and custom text labels.**

**Note:** See also Reference section, “Restoring Factory Defaults on the TV(s),” for further information.

## Installer Menu (Cont.)

---

### 119 - DATA CHANNEL

Set to 0 to disable. Set from 1 to 135 to match the RF channel number that will be used by the Pro:Centric server as its data channel. If left at the default value (255), the TV's Data Channel Auto Search feature will be enabled (see additional information below).\*

Data Channel Auto Search feature: When this item is set to 255 (default), once every 24 hours, the TV will initiate a search of 10 predefined channels (10, 20, 30, ... 100) and then, if necessary, perform a complete search of the RF channels (1 to 135) in an attempt to find the RF channel used by the Pro:Centric server as its data channel. If the Pro:Centric RF channel is found, the DATA CHANNEL value will be changed from 255 to match the server's RF channel number. The time at which the Auto Search occurs depends on the setting of item 121 P:C RF WAKE HR. See item 121 description for further information.

**Note:** Pro:Centric updates are downloaded from the Pro:Centric server to the TV when the TV is turned OFF. While Pro:Centric updates are in progress, it is not possible to turn ON the TV.

### 121 - P:C RF WAKE HR

Set the Wake On RF hour from 0 to 23. This item uses the 24-hour clock format. The value "128" is displayed as "OFF." Directly entering 128 turns the Wake On RF feature OFF.

The Wake On RF feature uses a timer, based on the settings of this item and item 122 P:C RF WAKE MN, to wake the TV to check for and, if applicable, download updates.

If Wake On RF is OFF, the time at which a Data Channel Auto Search (item 119 set to 255) occurs is determined as follows: The TV will initiate the search at 2:00 PM (if the TV clock is set) or at 14 hours of elapsed time from when AC power was applied (if the TV clock is not set). If the TV display is ON when the Auto Search is due to occur, the Auto Search will take place the next time the TV is turned OFF.

**Note:** This item is not available in the Installer Menu when item 119 DATA CHANNEL is set to 0.

**Note:** The TV clock must be set in order for a Wake On RF event to occur at the precise time of day in accordance with item 121 and item 122 settings.

### 122 - P:C RF WAKE MN

Set the Wake On RF minute from 0 to 59. See also description for item 121 P:C RF WAKE HR above.

**Note:** This item is not available in the Installer Menu unless item 121 P:C RF WAKE HR is set from 0 to 23.

**Note:** The TV clock must be set in order for a Wake On RF event to occur at the precise time of day in accordance with item 121 and item 122 settings.

\* PCS150R and later Pro:Centric servers do not support HRC or IRC cable channel frequencies.



This section describes how to create a customized Master TV Setup for cloning purposes when the TV is in Pass-through Mode.

**Note:** Cloning requirements and procedures are described in detail on pages 34 to 42. Refer to FTG Mode information on pages 43 to 49 for details on entering FTG Mode and configuring/editing the FTG Channel Map and FTG Installer Menu settings.

## Before You Begin

- It is recommended that you disconnect all Aux inputs if you intend to run Auto Tuning (Channel Search). Under certain conditions, Auto Tuning is disabled if there is an Aux input active.
- If not disabled in the Installer Menu, Aux sources will appear in the channel scan between analog and digital channels after the TV setup is transferred to the commercial controller (PTC).
- Determine which cloning tool—USB memory device or clone programmer—is appropriate for your application; several of the Master TV Setup procedure steps are dependent on the cloning tool to be used. See “Cloning Methods” at right for further information.
- If you intend to use a USB memory device, determine the type of file—either the new “.tlx” file format or the legacy “.tll” file format—to use for cloning purposes; several of the Master TV Setup procedure steps are dependent on the desired file type. See “Cloning Methods” at right for further information.
- If the Express Script Installer Menu Wizard appears on the screen, exit the Express Script before beginning/continuing the Custom Master TV Setup procedure.

## Cloning Methods

See also “Clonable TV Setup Menu Features” list below.

### Using a USB Memory Device / .tlx File

- The .tlx file format clones Installer Menu settings and all TV sources’ (analog, digital, AV1, HDMI, etc.) clonable setup menu settings.
- Not intended for cloning an auto-tuned/edited Channel Map, as the channel lineup is converted to a logical FTG Channel Map when saved (Learned) from a TV to a .tlx file. If the .tlx file with the FTG Channel Map is then used for Teaching purposes, all Target TVs will be configured for FTG Mode via CPU.

### Using a USB Memory Device / .tll File

The .tll file format clones the contents of the commercial controller (PTC) memory, including an auto-tuned/edited Channel Map, Installer Menu settings, and one TV source’s (analog, digital, or Aux) clonable setup menu settings.

### Using a Clone Programmer (TLL-1100A or LT2002)

Both the TLL-1100A and LT2002 clone the contents of the commercial controller (PTC) memory, including an auto-tuned/edited Channel Map, Installer Menu settings, and one TV source’s (analog or Aux) clonable setup menu settings.

## Clonable TV Setup Menu Features

<b>Channel</b>	<b>Audio</b>	<b>Time</b>
Auto Tuning (Channel Lineup)	Auto Volume	Clock Mode (Auto/Manual) *
Manual Tuning	Clear Voice	Time Zone
Channel Edit	Balance	Auto Off
Channel Label	Sound Mode	<b>Option</b>
<b>Picture</b>	AV Sync. Adjust *	Language
Picture Mode *		Caption
		Standby Light

\* Advanced Control (Picture Mode), AV Sync. Adjust, and DST (Clock Mode) settings are cloned via .tlx file only.

### Notes:

- Some menu options vary between analog and digital channels and Aux inputs.
- The end user only has access to features that are available on the pillow speaker or the user remote control if provided by the institution.

# Custom Master TV Setup (Cont.)

## Custom Master TV Setup Procedure

### 1. Turn ON the TV.

If the Express Script Installer Menu Wizard appears on the screen when you turn ON the TV, use the Up/Down arrow keys on the Installer Remote to select **Exit**, and then press **OK** to exit the wizard.

### 2. Set Installer Menu items.

This step provides specific instruction only on the Installer Menu items that should be set on a Master TV. Refer to pages 15 to 24 for detailed information on all Installer Menu items.

- a) Use the Installer Remote to access the PTC Installer Menu (see “Accessing the Installer Menu” on page 15 for further information).

The next step depends on whether the Express Script Installer Menu Wizard appeared when you turned ON the TV:

- If the wizard did appear, the TV is in a factory default state, and you can proceed to set Installer Menu items. Go to step (c).
- If the wizard did not appear, go to step (b).

- b) Set Installer Menu item **117 FACT DEFAULT** to **1** and press **OK** on the Installer Remote.

This clears all Installer Menu custom settings, channel lineup, etc. and restores the factory default settings. The value will change back to 0 after the PTC has been restored to factory default condition. This step ensures that the TV Channel Memory will be the active channel lineup.

- c) Set Installer Menu item **003 BAND/AFC**, as appropriate.

- Broadcast: Set to 0.
- HRC: Set to 2.
- CATV: Set to 1 (default).
- IRC: Set to 3.

- d) Set Installer Menu item **027 HOSPITAL MODE**, as appropriate, to select the speaker configuration.

- e) Set any other Installer Menu items that affect your TV programming network to the required configuration. For example, enable/disable Aux inputs, set a Start Channel, etc.

- f) After you have adjusted all Installer Menu item settings as required, press **OK** once on the Installer Remote to save your changes; then, press **OK** again to exit the menu.

**Note:** If you performed step (b) above to restore factory defaults, the Express Script Installer Menu Wizard will re-activate as soon as you exit the Installer Menu. Exit the wizard (see step 1), and then continue with step 3.

### 3. Set up TV features.

On-screen setup menus control the features of the TV. Press **MENU** on the Installer Remote to access the TV setup menus, and then set Channel, Picture, Audio, Time, etc. options to the desired configurations. See “Clonable TV Setup Menu Features” list on previous page and also notes on the following page.

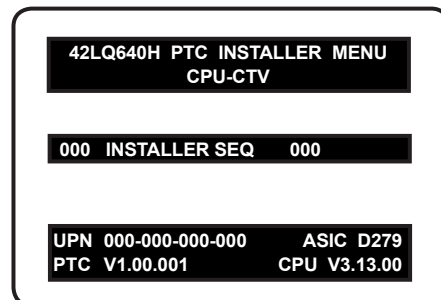

Typical Installer Menu

Note: The Installer Menu header will vary depending on the TV you are setting up.

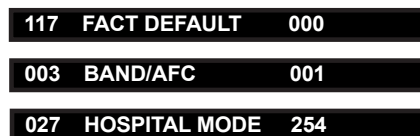

Adjust the values for these Installer Menu items.

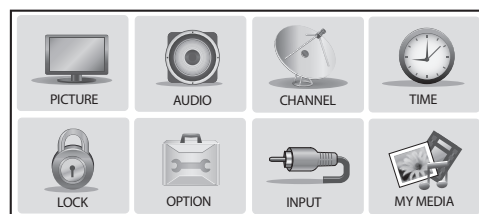

Use the TV setup menus to set the TV features to the desired configuration for the end user.

**Audio Menu Note:** Audio Menu options are inaccessible (grayed out) if TV Speaker is not selected (i.e., Pillow Only is selected).

(Continued on next page)

(Continued from previous page)

**Note:** If you intend to use a USB memory device / .tlx file for cloning purposes, and you wish to use the TV Zoning feature, make sure to assign a TV Zone # at this time as described in Reference section, “Using the TV Zoning Feature.”

**Note:** If you intend to clone the PTC, remember that only one TV source’s clonable setup menu settings will be cloned. Thus, for a clone programmer, the TV setup menu settings should be applicable to either an analog channel or Aux input, while for a USB device / .tll file, the TV setup menu settings should be applicable to the analog or digital channel or Aux input to which the Target TV will be set during the Teaching process.

**Note:** If desired and if appropriate depending on the cloning method to be used (see “Cloning Methods” on page 25), you can run Auto Tuning (see step 4) prior to completing this step.



**Note: The next three steps (4 to 6) are applicable for PTC cloning only (i.e., cloning using a USB memory device / .tll file or clone programmer). If you intend to use a USB memory device / .tlx file for cloning purposes, proceed directly to step 7 to verify the TV setup.**

#### 4. (PTC cloning only / Optional) Run Auto Tuning.

**Note:** If you run Auto Tuning with the intention to clone the resulting Channel Map, you MUST use a USB memory device / .tll file or a clone programmer for this cloning purpose. If you Teach a .tlx file with an auto-tuned/edited Channel Map to a Target TV, this will put the Target TV in FTG Mode via CPU.

- a) To search for all available analog and digital channels, go to the Channel Menu, select the **Auto Tuning** option, and follow the on-screen instructions.
- b) Use the **Channel Edit** option in the Channel Menu to edit the channel lineup, as necessary, to include only free to guest (non-encrypted) channels.
  - Add/delete channels per your system requirements.
  - Use the **Channel Label** option in the Channel Menu to select the appropriate trademark/icon for each channel’s Channel-Time on-screen display. Icons are available for familiar channels, such as ABC, CBS, NBC, etc. Identifiable labels (icons) should enable the end user to readily know what common networks are available.

**Note:** If Installer Menu item 103 ATSC TUNE MODE is set for Physical Channel tuning (default and recommended setting), channels with minor channel numbers higher than 255 will not transfer correctly in step 5. If item 103 is set for Virtual Channel tuning and either the major or minor channel numbers are higher than 255, the channel(s) will not transfer correctly in step 5.

**Note:** You can add the channel icons in this step or as described in step 6. Also in step 6, you can add custom text labels for channels without icons.

#### 5. (PTC cloning only) Transfer the TV setup menu settings to the commercial controller (PTC): 2-5-5 + MENU Mode



**Note: This step is essential for successful cloning using a USB memory device / .tll file or a clone programmer. Without this step, the PTC will not contain any of the TV setup menu settings.**



(Optional) Use Channel Menu options to run Auto Tuning, edit channels, and select channel icons.

# Custom Master TV Setup (Cont.)

(Continued from previous page)



**Note:** The maximum number of channels (analog, digital, and Aux inputs) that can be transferred to the PTC is 141. An attempt to transfer more than 141 channels of any combination will result in a PTC Channel Map of exactly 141 channels; any extra channels will not be available in the PTC Channel Map. For example, if you enabled three Aux inputs in the Installer Menu and Auto Tuning found 141 channels, you must edit the TV channel lineup to decrease the number of analog/digital channels to (at most) 138 in order to accommodate the Aux inputs in the PTC Channel Map.

- a) After the TV channel lineup has been edited and channel label icons added, tune to the channel (source) for which you wish to transfer TV setup menu settings.  
**Note:** If you intend to use a clone programmer for cloning purposes, this must be either an analog channel or Aux input.
- b) Access the Installer Menu, and press **2-5-5 + MENU** on the Installer Remote to initiate the transfer of the Master TV Setup to the PTC. The TV exits the Installer Menu and then tunes through the channels in the channel lineup during the transfer. When the transfer is complete, the TV tunes back to the channel that was tuned before the transfer began.

**Note:** Scan Mode is not functional until the TV setup is transferred.

## 6. (PTC cloning only / Optional) Add Custom Channel and Aux Input

**Labels: 2-5-4 + MENU Mode**

**Note:** 2-5-4 + MENU Mode enables you to add/edit channel icons and custom text labels in the PTC once the Master TV Setup has been transferred as described in the previous step.

Access the Installer Menu, and press **2-5-4 + MENU** on the Installer Remote. Add/edit custom text labels and/or change icons for the Channel-Time on-screen displays (see 2-5-4 + MENU procedural information on page 29). Note that broadcast digital channels often already have a broadcaster generated label. When you are finished, press **MENU** to exit 2-5-4 + MENU Mode.

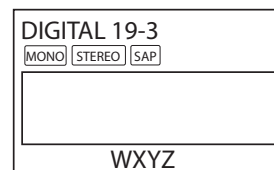

Custom Text Label "WXYZ" created in 2-5-4 + MENU Mode.

## 7. Verify the TV setup.

Make sure the TV features are set per your requirements. Also, if cloning the PTC, verify that the channel lineup, channel icons, and custom text labels are correct.

## 8. Set up channel banks.

Set up channel banks, as desired (see pages 30 to 33).

**Note:** When you lock the channel lineup (see next step), the Channel Preview/Banks Setup Menu is no longer accessible via the Installer Remote. If you wish to set up channel banks at a later time, you will need to set Installer Menu item 028 CH. OVERRIDE to 1 to enable access to the Channel Preview/Banks Setup Menu.

## 9. (Recommended) Lock the channel lineup.

Access the Installer Menu. Set item **028 CH. OVERRIDE** to **0** and press **OK** to lock the channel lineup and restrict access to the TV setup menus. Press **OK** again to save your changes and exit the Installer Menu. \*

The Master TV Setup is now ready to be copied to the predetermined cloning tool—a USB memory device or a clone programmer. See cloning procedures in this document.

**028 CH. OVERRIDE 000**

After verifying the TV Setup, set Installer Menu item 028 CH. OVERRIDE to 0.\*

\* This step prevents end users from accessing channel settings (i.e., the Channel Menu will be inaccessible/grayed out).

# Channel Icons / Custom Text Labels (2-5-4 + MENU Mode)

## Changing Channel Icons and/or Adding or Editing Custom Text Labels in the Channel-Time Display

If there is no pre-assigned icon for a channel, you can add a custom text label of up to seven (7) characters to help identify the channel or network. Also, if desired, a custom text label can be added to the Channel-Time display in addition to a pre-assigned icon. You may also add text labels for the Aux input sources to clearly identify the devices that are connected to the Aux inputs.

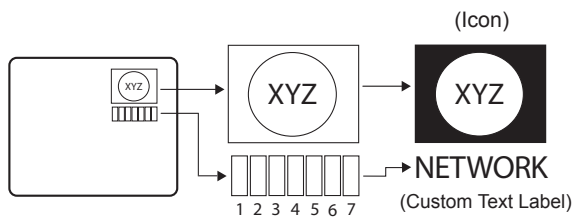

Changing icons and/or adding or editing custom text labels can only be done if there are channels that have been transferred to the TV's PTC either during the Express Script/Custom Master TV Setup (see pages 10 to 14 or pages 25 to 28, respectively) or by cloning (USB memory device / .tll file or clone programmer only).

**Note:** A blank letter space is available between "Z" and "!".

### To perform channel editing/labeling:

1. Use the Installer Remote to access the TV Installer Menu (see "Accessing the Installer Menu" on page 15 for further information).
2. Press **2-5-4 + MENU** on the Installer Remote to access the Channel Label Editing Menu.
3. Change channel icons and/or add or edit custom text labels as described in the procedures below. (You can do this more than once.)
4. To exit the menu when you are done, press **MENU**.

## Changing a Channel's Icon on the Master TV

1. Use Channel Up/Down to select the desired channel.
2. Use the Left/Right arrow keys to select the thin letter "I" on the Channel-Time display.
3. Use the Up/Down arrow keys to select the icon with which you want to identify the channel. (If you know the icon number, enter the number, and press **OK**.)
4. Proceed to add/edit custom text labels, or go to the next channel.

## Adding/Editing Channel Labels on the Master TV

1. Use Channel Up/Down to select the desired channel.
2. Press the Left or Right arrow repeatedly until the numbers 1 to 7 appear on the display. The number shows the position of the character that can be changed. Number 1 is the first character, number 2 the second character, etc.
3. Use the Up/Down arrow keys to select the desired character.
4. Proceed to the next number position, or go to the next channel.

## Adding/Editing Source Labels on the Master TV

1. Press **BANK** to select the desired Aux input source: AV1, RGB, HDMI1, HDMI2, or HDMI3.
2. Press the Left or Right arrow repeatedly until the numbers 0 to 9 appear on the display. The number shows the position of the character that can be changed.
3. Use the Up/Down arrow keys to select the desired character.
4. Press **BANK** for the next Aux input, or use Channel Up/Down to return to channels.

## Installer Remote Control Key Functions for Master TV Channel Label Editing Menu

- **Channel Up/Down:** Tunes to the next channel in scan.
- **Left/Right Arrows:** Select the item to change. If "I" is shown, the icon can be changed. If a number is shown, it indicates the position of the character that can be changed.
- **Up/Down Arrows:** Select the icon or the character to be displayed. Tip: Arrows can be held down for fast scrolling.
- **0 – 9:** Use to enter the index number of the icon, if known.
- **OK:** Changes the icon after the icon number has been entered.
- **BANK:** Use to select Aux inputs.
- **MENU:** Exits the editing process.

# Channel Banks Setup

## Channel Banks Overview

Channel Banks enable institution administrators to create tiered channel programming on patient in-room TVs. Each channel bank may offer a custom channel lineup for a pre-determined fee. 42LQ640H TVs are configured with four channel banks, i.e., Channel Banks 1, 2, 3, and 4. The top tier generally contains the most programming (premium, etc.), 2nd tier = lesser programming, 3rd tier = basic programming, etc. It is also possible to create an Inactive TV display with Channel Bank 4, so that an “Inactive TV Call Attendant” message appears when the TV is turned ON. In this case, an administrator can then select another channel bank on the patient’s in-room TV depending on the programming tier requested by the patient.

All channels found during Auto Tuning automatically will be “ADDED” to all four channel banks, and the default is for all channels to be active (NORMAL) in Channel Banks 1, 2, 3, and 4.

 **Note: Channel banks are not supported on TVs that are configured for FTG Mode operation.**

## Before You Begin

- Run the Express Script Installer Menu Wizard or complete the Custom Master TV Setup procedure (see pages 10 to 14 or pages 25 to 28, respectively).

**Note:** Channel banks can be defined as part of the Express Script Installer Menu Wizard, if desired. However, if you are setting up channel banks after completing the Express Script or if you are creating a customized Master TV Setup, use the Channel Preview/Banks Setup Menu as described below.

- Installer Menu item 028 CH. OVERRIDE must be set to 1 to allow access for channel banks setup.

## Accessing the Channel Preview/Banks Setup Menu

1. To select a channel bank, press **BANK** on the Installer Remote. The first time you press the BANK key, the TV display will show the currently active channel bank. Press **BANK** repeatedly until the desired channel bank is selected.
2. After the desired channel bank is selected, press **CH PREVIEW** on the Installer Remote to display the Channel Preview/Banks Setup Menu (see below).

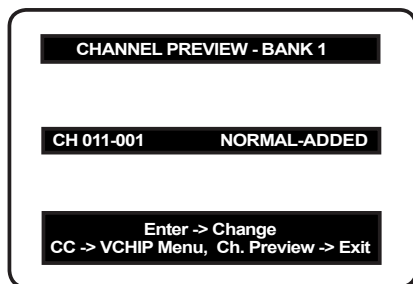

Typical Channel Preview/Banks Setup Menu

**Note:** In the Installer Menu, all available Aux inputs are enabled by default. The Aux inputs will appear between the highest analog and lowest digital channel number in the channel lineup when Channel Up/Down is used on the Installer Remote. If an Aux input will not be used, it is advisable to disable it. If using the Express Script, customize the Aux inputs as appropriate in the Aux Input screen (step 2). If performing the Custom Master TV Setup procedure, ensure Installer Menu items 035, 039, 087, 091, and 092 are set as required before performing the 2-5-5 + MENU operation (step 5). After the TV setup is transferred to the PTC, the only way to remove Aux inputs from the channel lineup is to go to the Channel Preview/Banks Setup Menu and select NORMAL-DELETED.

## Channel Status Options for Channel Banks

In the Channel Preview/Banks Setup Menu, use the Channel Up/Down arrows on the Installer Remote to navigate to a channel and the Left/Right arrows to select the channel status.

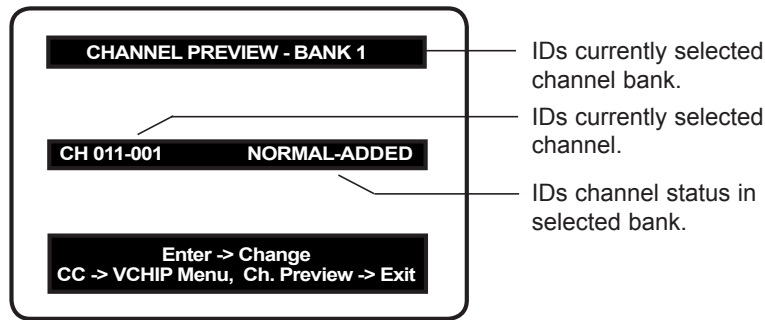

Typical Channel Preview/Banks Setup Menu

### Channel Status Options

- **NORMAL-ADDED:** Channel will appear in channel lineup of currently selected channel bank.
- **NORMAL-DELETED:** Channel will not appear in channel lineup of currently selected channel bank.
- **BLANK-ADDED:** Channel will appear in all channel banks, with standard audible audio; however, video will be black (no picture).
- **BLANK-DELETED:** Channel will not appear in channel lineup of currently selected channel bank, and in all other channel banks, channel will be assigned BLANK-ADDED status.

### Adding / Deleting / Blanking Channels

It is best to complete ADD / DELETE customization before assigning BLANK status. All channels found during Auto Tuning are automatically assigned NORMAL-ADDED status in Channel Banks 1, 2, 3, and 4. NORMAL-ADDED and NORMAL-DELETED status can be assigned independently for Channel Banks 1, 2, 3, and 4. However, a channel blanked, is blanked in all channel banks.

**Note:** Auto Tuning removes any channels previously customized with ADD / DELETE / BLANK.

**Note:** On individual TVs, if a channel was not found during Auto Tuning (and was not added during Express Script/Custom Master TV Setup procedures), it can be added using the Manual Tuning option in the Channel Menu.

### Selecting Deleted Channels

To tune to a NORMAL-DELETED channel:

1. Select a channel bank where the channel's status is NORMAL-ADDED.
2. Navigate to or direct enter the channel number.
3. Select the channel bank where the channel's status is "NORMAL-DELETED," and reconfigure the channel status in the Channel Preview/Banks Setup Menu.

# Channel Banks Setup (Cont.)

## Inactive TV Setup

There are two options for creating an inactive TV display on Channel Bank 4. Either:

- Select **NORMAL-DELETED** for each channel in Channel Bank 4, or
- Press **BANK** on the Installer Remote until Channel Bank 4 is selected, and then press **CH PREVIEW** to display the Channel Preview/Banks Setup Menu. Then, press the **SAP** key on the Installer Remote to automatically delete all channels in Channel Bank 4.

When the TV is turned ON by the patient, an “Inactive TV Call Attendant” message will appear on the screen, and after a few moments the TV will turn itself OFF. This will prompt the patient to arrange for an available programming package on Channel Bank 1, 2, or 3. Using the Installer Remote, the administrator can select Channel Bank 1, 2, or 3 depending on the entertainment programming tier selected by the patient. When the patient leaves the hospital, the administrator can then select Channel Bank 4 to reinstate the “Inactive TV” message.

## Channel Banks Worksheets

Use Channel Banks Worksheets (see following page) to create channel status charts as part of the setup process. On the channel status charts, show the status for each channel in all channel banks. This then becomes the patient entertainment programming offerings plan.

The following examples show “before-and-after-customization” portions of channel status charts with analog channels, Aux inputs, and digital channels.

*Example: Channel Banks After Auto Tuning*

BANK	Analog			Aux			Digital														
	2	5	7	AVI	RGB	HDM1	4-1	6-1	13-1	20-5	20-6	30-1	32-1	40-1	40-11	44-1	44-11	45-1	45-11		
1	A	A	A	A	A	A	A	A	A	A	A	A	A	A	A	A	A	A	A	A	
2	A	A	A	A	A	A	A	A	A	A	A	A	A	A	A	A	A	A	A	A	
3	A	A	A	A	A	A	A	A	A	A	A	A	A	A	A	A	A	A	A	A	
4	A	A	A	A	A	A	A	A	A	A	A	A	A	A	A	A	A	A	A	A	

A = Active (channel found during Auto Tuning and automatically assigned NORMAL-ADDED status)

*Example: Channel Banks After Auto Tuning and Customization with Add/Del/Blink Options*

BANK	Analog			Aux			Digital														
	2	5	7	AVI	RGB	HDM1	4-1	6-1	13-1	20-5	20-6	30-1	32-1	40-1	40-11	44-1	44-11	45-1	45-11		
1	BA	A	A	A	A	A	A	A	A	A	A	A	A	A	A	A	A	A	A	A	
2	BA	A	A	A	A	A	A	D	D	A	A	A	A	A	A	D	D	D	D	D	
3	BD	D	D	A	A	D	A	A	D	D	A	A	A	D	D	D	D	D	D	D	
4	D	D	D	D	D	D	D	D	D	D	D	D	D	D	D	D	D	D	D	D	

A = Active channel (channel found during Auto Tuning and retains NORMAL-ADDED status)

D = Deleted channel (channel assigned NORMAL-DELETED status in the Channel Preview/Banks Setup Menu)

BA = Channel assigned BLANK-ADDED status in the Channel Preview/Banks Setup Menu

BD = Channel assigned BLANK-DELETED status in the Channel Preview/Banks Setup Menu



# Channel Banks Worksheet

Use this worksheet to plan your program packages. (Photocopy additional worksheets as needed.)

B A N K	Channel Number																			
	1																			
	2																			
	3																			

B A N K	Channel Number																			
	1																			
	2																			
	3																			

B A N K	Channel Number																			
	1																			
	2																			
	3																			

B A N K	Channel Number																			
	1																			
	2																			
	3																			

B A N K	Channel Number																			
	1																			
	2																			
	3																			

Date \_\_\_\_\_ Installer \_\_\_\_\_ Page \_\_\_ of \_\_\_  
 Location \_\_\_\_\_

# Cloning Overview

---

## IMPORTANT CLONING INFORMATION

There are four different procedures for cloning a Master TV Setup (including a TV that has been set up using the Express Script Installer Menu Wizard), each with its own advantages and limitations (see also “Cloning Methods” on page 25):

- Using a USB memory device / .tlx file
- Using a USB memory device / .tll file
- Using a TLL-1100A clone programmer
- Using a LT2002 clone programmer

Each cloning method is described in further detail on the pages that follow. As you perform cloning procedures, be sure to complete each task as indicated. If a procedure or step is omitted or not performed completely, cloning may not work. At each step, pay attention to ensure the TV screen shows the proper message when cloning. If the message indicated does not appear, there is a problem with that step, and cloning may not be successful.



**Caution: Copying a blank or incorrect memory into a TV from a clone programmer will cause the TV to operate erratically or become inoperable.**

### Before you begin cloning:

- Complete the Custom Master TV Setup procedure or run the Express Script Installer Menu Wizard (see pages 25 to 28 or pages 10 to 14, respectively).
- All equipment should be connected to power and turned ON.
- Both the Master and Target TVs must be in Pass-through Mode (i.e., the TV setup menus should be displayed when you press **MENU** on the Installer Remote).
- Learning and Teaching is only possible between identical model TVs.
- If using a USB memory device, ensure the USB device has been formatted with FAT format.
- If using a USB memory device / .tlx file, ensure that the Master TV Setup does not contain a Channel Map; otherwise, Teaching will result in the Target TV(s) being configured for FTG Mode via CPU.
- For both Master and Target TVs—If using a clone programmer, ensure the TV is tuned to either an Aux input or an analog (not a digital) channel.
- LT2002 only—Make sure the batteries in the clone programmer are fresh. If batteries are removed, the clone programmer clock time (if set) will be lost (see page 42 for information on the clone programmer clock).



**Caution: Do not unplug the TV power cord or remove/disconnect the USB memory device/ clone programmer while Learning or Teaching, as doing so may cause the TV to malfunction or harm the USB device/clone programmer, respectively.**

## Learning / Teaching a Master TV Setup using a USB Memory Device / .tlx File

### USB Cloning Notes

- Read the IMPORTANT CLONING INFORMATION on page 34 before beginning any cloning procedures. In particular, ensure that the Master TV Setup does not contain a Channel Map; otherwise, Teaching will result in the Target TV(s) being configured for FTG Mode via CPU.
- If a TV Zone # (for location-specific configuration) has been set in the Master TV before the Learning process is initiated, the Zone designation will be used during the subsequent Teaching process(es). This means that in order for the “Learned” clone data with the TV Zone assignment to be applied, any Target TVs will need to be assigned the same Zone designation BEFORE Teaching is performed. Refer to Reference section, “Using the TV Zoning Feature,” for further information. See also bullet below.
- If you intend to use the TV Zoning feature, make sure to assign a TV Zone # as described in Reference section, “Using the TV Zoning Feature,” BEFORE continuing with the Learning procedure below. See also bullet above.
- You may edit the filename as part of the Learning procedure; however, a file with edited contents will not be recognized.
- It is not possible to clone a Master TV’s clock using a USB memory device. Either set a Target TV’s clock manually, or use the Auto Clock setting in the TV setup menus.

### Learn Setup from Master TV

1. Ensure the Master TV is set up completely and in Pass-through Mode.
2. Insert the USB memory device into the USB IN port on the Master TV.
3. Press **MENU** on the Installer Remote to display the TV setup menus. Use the arrow navigation keys to select/highlight the **Option** menu icon, and then press the number “7” key a total of seven times to display the USB Download Menu.
4. To gain access to the “Learn From TV” option in the USB Download Menu, key in the password used to access the Installer Menu (Example: Press **9-8-7-6**).
5. Use the Up/Down arrow keys to select **Learn From TV (TLX)**, and then press **OK**.
6. To differentiate this .tlx file from others, you can use the Up/Down arrow keys to change the last five digits of the filename. Press **OK** when you are ready to initiate Learning.  
Learning status will be shown on a progress bar in a new window. When the Learning process is complete, the USB Download Menu will reappear on the screen.
7. When Learning is done, press **CC** on the Installer Remote to exit the USB Download Menu, and remove the USB memory device from the Master TV.

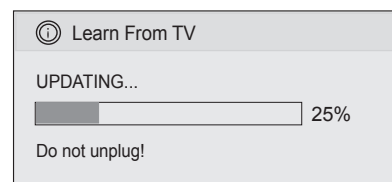
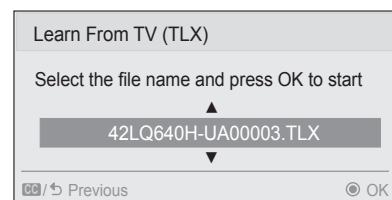
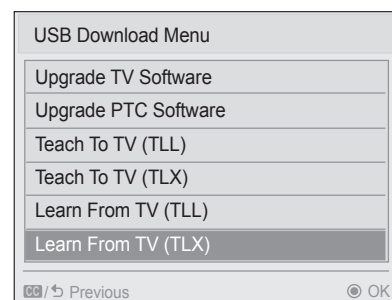

# USB Cloning Procedures (Cont.)

## Teach Master TV Setup to Target TV

1. Turn ON the Target TV.

The next step depends on whether the Express Script Installer Menu Wizard appears on the screen:

- If the wizard is displayed, the TV is in the required factory default state. Use the Up/Down arrow keys on the Installer Remote to select **Exit**, and then press **OK** to exit the wizard. Then, go to step 3.
- Otherwise, ensure the Target TV is in Pass-through Mode, and then continue with step 2.

 **Note: If the Master TV Setup contains a TV Zone # assignment, in order for the proper location-specific TV Zone profile data to be applied, you will need to assign the same Zone designation in the Target TV(s) BEFORE Teaching is performed. Refer to Reference section, “Using the TV Zoning Feature,” for further information.**

2. Use the Installer Remote to access the Target TV Installer Menu (see “Accessing the Installer Menu” on page 15 for further information). Set Installer Menu item **117 FACT DEFAULT** to **1**, and press **OK**. When the value changes back to 0, press **OK** again to exit the Installer Menu.  
**Note:** This step restores factory default settings on the TV, which will in turn re-activate the Express Script. Exit the wizard (see step 1); if applicable, set the TV Zone # (see note above); and then continue with step 3.
3. Insert the USB memory device with the .tlx file into the Target TV USB IN port.
4. Press **MENU** on the Installer Remote to display the TV setup menus. Use the arrow navigation keys to select/highlight the **Option** menu icon, and then press the number “7” key a total of seven times to display the USB Download Menu.
5. Use the Up/Down arrow keys to select **Teach To TV (TLX)**, and then press **OK**.
6. Use the Up/Down arrow keys to select the Master TV Setup you want to install, and then press **OK**. Note: Filenames identify the TV and the TLX version (see example at right).

Teaching status will be shown on a progress bar in a new window. When the Teaching process is complete, the TV will briefly display a “Teaching Completed” window and then exit the USB Download Menu.

7. Remove the USB memory device from the Target TV, and verify that the Master TV Setup is now resident on the Target TV.

**Note:** After the Teaching process is complete, the TV tunes according to the setting of Installer Menu item 004 STRT CHANNEL (Start Channel). If a Start Channel is specified, the TV will tune to that channel; otherwise, the TV will return to the last channel tuned.

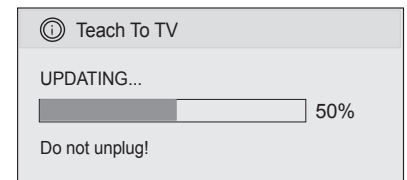
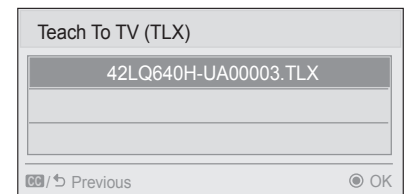
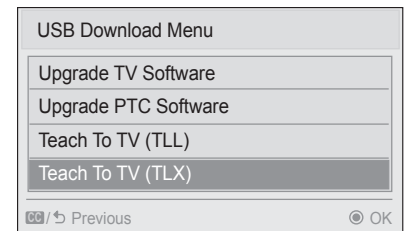

## Learning / Teaching a Master TV Setup using a USB Memory Device / .tll File

### USB Cloning Notes

- Read the IMPORTANT CLONING INFORMATION on page 34 before beginning any cloning procedures.
- You may edit a filename as part of the Learning procedure; however, a file with edited contents will not be recognized.
- It is not possible to clone a Master TV's clock using a USB memory device. Either set a Target TV's clock manually or use the Auto Clock setting in the TV setup menus.

### Learn Setup from Master TV

1. Ensure the Master TV is set up completely and in Pass-through Mode.
2. Insert the USB memory device into the USB IN port on the Master TV.
3. Press **MENU** on the Installer Remote to display the TV setup menus, use the arrow navigation keys to select/highlight the **Option** menu icon, and then press the number **"7"** key a total of seven times to display the USB Download Menu.
4. To gain access to the "Learn From TV" option in the USB Download Menu, key in the password used to access the Installer Menu (Example: Press **9-8-7-6**).
5. Use the Up/Down arrow keys to select **Learn From TV (TLL)**, and then press **OK**.
6. To differentiate this .tll file from others, you can use the Up/Down arrow keys to change the last five digits of the filename. Press **OK** when you are ready to initiate Learning.  
Learning status will be shown on a progress bar in a new window. When the Learning process is complete, the USB Download Menu will reappear on the screen.
7. When Learning is done, press **CC** on the Installer Remote to exit the USB Download Menu, and remove the USB memory device from the Master TV.

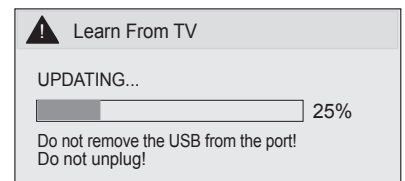
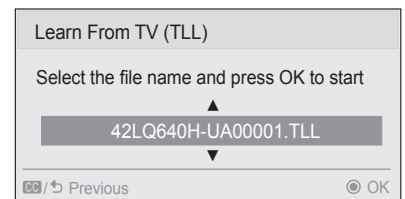
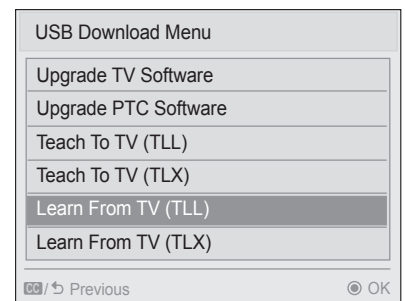

# USB Cloning Procedures (Cont.)

## Teach Master TV Setup to Target TV

1. Turn ON the Target TV.

The next step depends on whether the Express Script Installer Menu Wizard appears on the screen:

- If the wizard is displayed, the TV is in the required factory default state. Use the Up/Down arrow keys on the Installer Remote to select **Exit**, and then press **OK** to exit the wizard. Then, go to step 3.
- Otherwise, ensure the Target TV is in Pass-through Mode, and then continue with step 2.

2. Use the Installer Remote to access the Target TV Installer Menu (see “Accessing the Installer Menu” on page 15 for further information). Set Installer Menu item **117 FACT DEFAULT** to **1**, and press **OK**. When the value changes back to 0, press **OK** again to exit the Installer Menu.

**Note:** This step restores factory default settings on the TV, which will in turn re-activate the Express Script. Exit the wizard (see step 1), and then continue with step 3.

3. Tune/set the TV to an analog or digital channel or Aux input (ideally the same source tuned for 2-5-5 + MENU Mode during the Custom Master TV Setup procedure, if applicable).
4. Insert the USB memory device with the .tll file into the Target TV USB IN port.
5. Press **MENU** on the Installer Remote to display the TV setup menus, use the arrow navigation keys to select/highlight the **Option** menu icon, and then press the number “7” key a total of seven times to display the USB Download Menu.

6. Use the Up/Down arrow keys to select **Teach To TV (TLL)**, and then press **OK**.

7. Use the Up/Down arrow keys to select the Master TV Setup you want to install, and then press **OK**. Note: Filenames identify the TV and the TLL version (see example at right).

Teaching status will be shown on a progress bar in a new window. When the Teaching process is complete, the USB Download Menu will reappear on the screen.

8. When Teaching is done, press **CC** on the Installer Remote to exit the USB Download Menu, remove the USB memory device from the Target TV, and turn OFF the TV.

9. After a few seconds, turn ON the TV, and verify that the Master TV Setup is now resident on the Target TV.

**Note:** When you turn it back ON, the TV will tune according to the setting of Installer Menu item 004 STRT CHANNEL (Start Channel). If a Start Channel is specified, the TV will tune to that channel; otherwise, the TV will return to the last channel tuned.

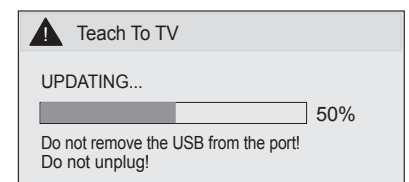
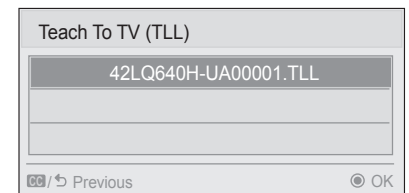
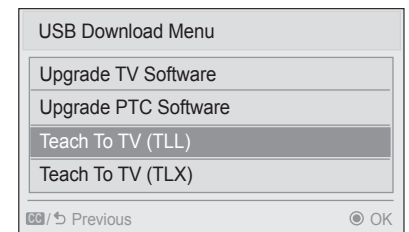

# Clone Programmer Cloning Procedures

## Learning / Teaching a Master TV Setup using a TLL-1100A Clone Programmer

Cloning is accomplished using the TV/clone programmer MPI ports for communication (see figure).

### TLL-1100A Cloning Notes

- Read the IMPORTANT CLONING INFORMATION on page 34 before beginning any cloning procedures.
- Ensure the TLL-1100A is either fully charged or connected to AC power.
- Learning and Teaching is only possible between identical model TVs; however, the TLL-1100A can store up to eight different Master TV Setups.

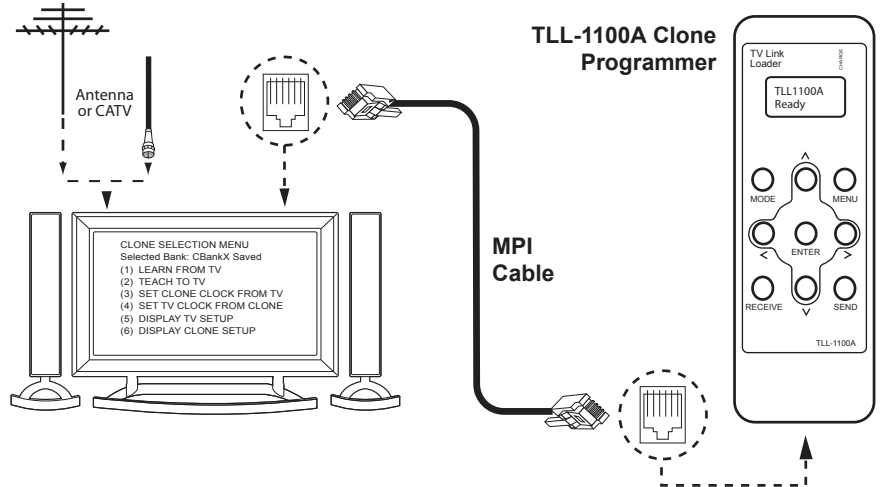

### Learn Setup from Master TV

1. Ensure the Master TV is set up completely and in Pass-through Mode.
2. Tune/set the TV to an analog channel or Aux input, and then plug one end of the MPI cable into the TV MPI port.
3. Turn ON the TLL-1100A.
4. Use the **MODE** button on the TLL-1100A to select **Clone Mode**.
5. Use the Left/Right arrows on the TLL-1100A to select the Memory CBank (1 to 8) in which to store the Master TV Setup.
6. Plug the other end of the MPI cable into the MPI port on the bottom of the TLL-1100A. The Clone Selection Menu will display on the TV screen.
7. Press **1** on the Installer Remote to select **LEARN FROM TV** from the Clone Selection Menu. Then, press **OK** to transfer the Master TV Setup into CBankX on the TLL-1100A.

Learning usually takes about 90 seconds. "LEARNING IN PROGRESS" will be displayed on the screen while the TLL-1100A copies the Master Setup. When the Learning process is complete, a "LEARNING COMPLETE" message will be displayed.

8. When Learning is complete, disconnect the MPI cable from the Master TV.

CLONE SELECTION MENU  
Selected Bank: CBankX Saved  
(1) LEARN FROM TV  
(2) TEACH TO TV  
(3) SET CLONE CLOCK FROM TV  
(4) SET TV CLOCK FROM CLONE  
(5) DISPLAY TV SETUP  
(6) DISPLAY CLONE SETUP

CLONE CLOCK = XX:XX  
TV CLOCK = XX:XX  
THE CLONE IS VERSION VX.X.X  
- To change menu items, press channel keys or digits.  
- To execute item, press Enter.

# Clone Programmer Cloning Procedures (Cont.)

## (Optional) Set the Clock

Set the time on a Master TV's clock. (If the time has already been copied from a TV into the TLL-1100A clone programmer, you can set the Master TV's clock by copying the time from the clone programmer.) The TLL-1100A can copy the current time to both a Master TV and to the clone's internal clock—accurate to within one minute.

Since the TLL-1100A's time cannot be set directly, the current time needs to be copied from an LG TV equipped with an enabled MPI port.

After the time is copied to the TLL-1100A clone programmer, the current time will be maintained and can then be transferred to another TV. (This can be a Master TV or another TV which has already had the features set up.)

## Teach Master TV Setup to Target TV

1. Turn ON the Target TV.

The next step depends on whether the Express Script Installer Menu Wizard appears on the screen:

- If the wizard is displayed, the TV is in the required factory default state. Use the Up/Down arrow keys on the Installer Remote to select **Exit**, and then press **OK** to exit the wizard. Then, go to step 3.
- Otherwise, ensure the Target TV is in Pass-through Mode, and then continue with step 2.

2. Use the Installer Remote to access the Target TV Installer Menu (see "Accessing the Installer Menu" on page 15 for further information). Set Installer Menu item **117 FACT DEFAULT** to **1**, and press **OK**. When the value changes back to 0, press **OK** again to exit the Installer Menu.  
**Note:** This step restores factory default settings on the TV, which will in turn re-activate the Express Script. Exit the wizard as described in step 1.
3. Tune/set the TV to an analog channel or Aux input (ideally the same source tuned for 2-5-5 + MENU Mode during the Custom Master TV Setup procedure, if applicable), and then connect the MPI cable to the MPI port on the Target TV. The Clone Selection Menu will display on the TV screen.
4. Ensure the correct Memory CBank(X) is selected on the TLL-1100A.
5. Press **2** on the Installer Remote to select **TEACH TO TV** from the Clone Selection Menu. Then, press **OK** to transfer the Master TV Setup to the Target TV.  
Teaching usually takes 3 to 4 minutes. "TEACHING IN PROGRESS" will be displayed on the screen during Teaching. When the Teaching process is complete, a "TEACHING COMPLETE" message will be displayed.
6. When Teaching is done, disconnect the MPI cable from the Target TV, and turn OFF the TV.
7. After a few seconds, turn ON the TV, and verify that the Master TV Setup is now resident on the Target TV.

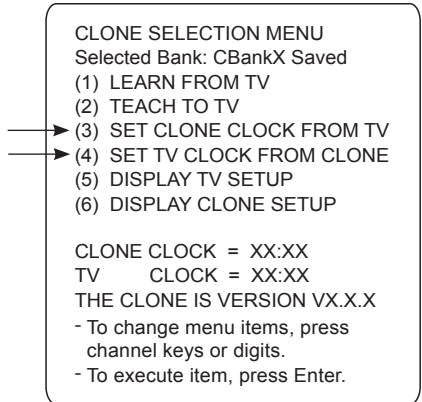

```
CLONE SELECTION MENU
Selected Bank: CBankX Saved
(1) LEARN FROM TV
(2) TEACH TO TV
(3) SET CLONE CLOCK FROM TV
(4) SET TV CLOCK FROM CLONE
(5) DISPLAY TV SETUP
(6) DISPLAY CLONE SETUP
```

```
CLONE CLOCK = XX:XX
TV    CLOCK = XX:XX
THE CLONE IS VERSION VX.X.X
- To change menu items, press
  channel keys or digits.
- To execute item, press Enter.
```

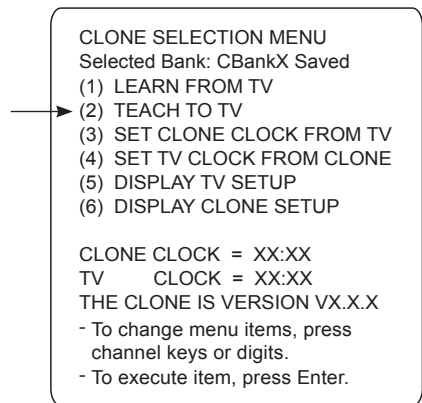

```
CLONE SELECTION MENU
Selected Bank: CBankX Saved
(1) LEARN FROM TV
(2) TEACH TO TV
(3) SET CLONE CLOCK FROM TV
(4) SET TV CLOCK FROM CLONE
(5) DISPLAY TV SETUP
(6) DISPLAY CLONE SETUP
```

```
CLONE CLOCK = XX:XX
TV    CLOCK = XX:XX
THE CLONE IS VERSION VX.X.X
- To change menu items, press
  channel keys or digits.
- To execute item, press Enter.
```



# Clone Programmer Cloning Procedures (Cont.)

## Learning / Teaching a Master TV Setup using an LT2002 Clone Programmer

Cloning is accomplished using the TV/clone programmer MPI ports for communication (see figure).

### LT2002 Cloning Notes

- Read the IMPORTANT CLONING INFORMATION on page 34 before beginning any cloning procedures.
- A slow flashing green light indicates that there are communication problems between the TV and the LT2002. If this is the case, check for a damaged cable, poor contacts, or other connection troubles.
- If the status indicator is red, the LT2002 batteries are low and should be replaced. Install four (4) high-quality alkaline AA batteries.
- Learning and Teaching is only possible between identical model TVs; however, the LT2002 can store up to three different Master TV Setups.

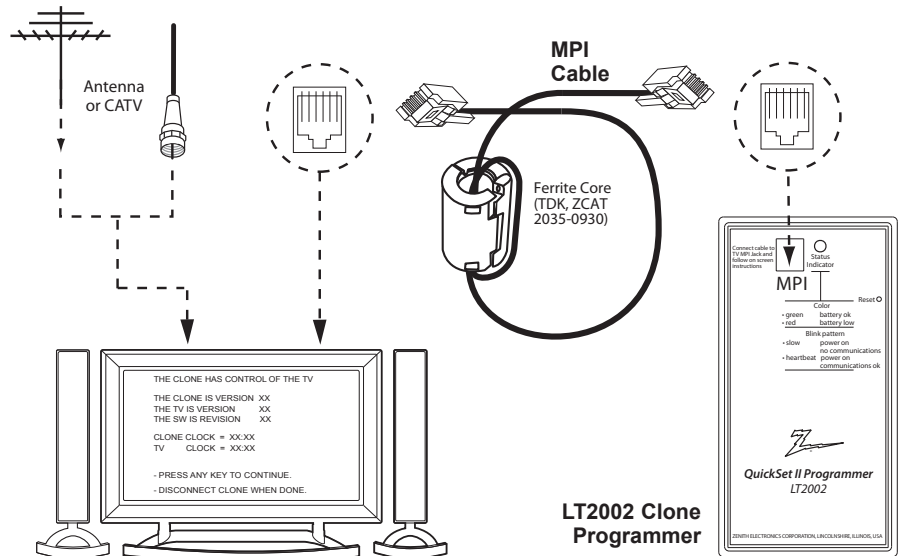

### Learn Setup from Master TV

1. Ensure the Master TV is set up completely and in Pass-through Mode.
2. Tune/set the TV to an analog channel or Aux input, and then plug one end of the MPI cable into the TV MPI port.
3. If there is a good connection after the LT2002 is connected to the TV MPI port, "THE CLONE HAS CONTROL OF THE TV" message will appear on the TV screen. Press any key on the Installer Remote to access the LT2002 Clone Selection Menu.
4. Press **1** on the Installer Remote to select **LEARN FROM TV** from the Clone Selection Menu; then press **OK** to proceed to the Memory Bank Selection Menu.
5. Press 1, 2, or 3 on the Installer Remote to select the clone Memory Bank in which to store the Master Setup. Then, press **OK**.
 

**Note:** If you choose a Memory Bank that already has a Master device's setup programmed into it, that setup will be overwritten by the new Master TV Setup.
6. Verify the Learning setup information on the next screen, and then press **POWER** to transfer the Master TV Setup into the selected Memory Bank on the LT2002.
 

Learning usually takes about 90 seconds. "LEARNING IN PROGRESS" will be displayed on the screen while the LT2002 copies the Master Setup. When the Learning process is complete, a "LEARNING COMPLETE" message will be displayed.
7. When Learning is complete, disconnect the MPI cable from the Master TV.

CLONE SELECTION MENU

- (1) LEARN FROM TV
- (2) TEACH TO TV
- (3) SET CLONE CLOCK FROM TV
- (4) SET TV CLOCK FROM CLONE
- (5) DISPLAY TV SETUP
- (6) DISPLAY CLONE SETUP

- TO CHANGE MENU ITEMS, PRESS CHANNEL KEYS OR DIGITS.

- TO EXECUTE ITEM, PRESS ON/OFF, POWER, OR ENTER.

SAVE TV SETUP IN SELECTED CLONE MEMORY

- (1) MEMORY 1 VER XX REV XX
- (2) MEMORY 2 VER XX REV XX
- (3) MEMORY 3 VER XX REV XX
- (4) RETURN TO CLONE MENU

- TO CHANGE MENU ITEMS, PRESS CHANNEL KEYS OR DIGITS.

- TO EXECUTE ITEM, PRESS ON/OFF, POWER, OR ENTER.

# Clone Programmer Cloning Procedures (Cont.)

## (Optional) Set the Clock

Set the time on a Master TV's clock. (If the time has already been copied from a TV into the LT2002 clone programmer, you can set the Master TV's clock by copying the time from the clone programmer.) The LT2002 can copy the current time to both a Master TV and to the clone's internal clock—accurate to within one minute. (Another reason that the LT2002 should be equipped with fresh, high-quality alkaline batteries, is for it to keep the time as accurately as possible.)

Since the LT2002's time cannot be set directly, the current time needs to be copied from an LG TV equipped with an enabled MPI port.

After the time is copied to the LT2002 clone programmer, the current time will be maintained and can then be transferred to another TV. (This can be a Master TV or another TV which has already had the features set up.)

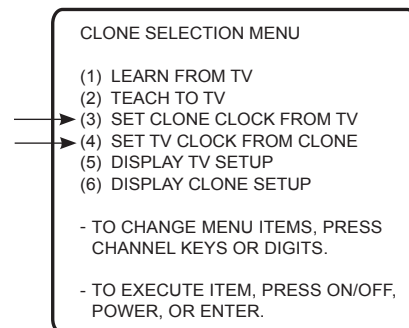

## Teach Master TV Setup to Target TV

1. Turn ON the Target TV.

The next step depends on whether the Express Script Installer Menu Wizard appears on the screen:

- If the wizard is displayed, the TV is in the required factory default state. Use the Up/Down arrow keys on the Installer Remote to select **Exit**, and then press **OK** to exit the wizard. Then, go to step 3.
- Otherwise, ensure the Target TV is in Pass-through Mode, and then continue with step 2.

2. Use the Installer Remote to access the Target TV Installer Menu (see “Accessing the Installer Menu” on page 15 for further information). Set Installer Menu item **117 FACT DEFAULT** to **1**, and press **OK**. When the value changes back to 0, press **OK** again to exit the Installer Menu.

**Note:** This step restores factory default settings on the TV, which will in turn re-activate the Express Script. Exit the wizard as described in step 1.

3. Tune/set the TV to an analog channel or Aux input (ideally the same source tuned for 2-5-5 + MENU Mode during the Custom Master TV Setup procedure, if applicable), and then connect the MPI cable to the MPI port on the Target TV.
4. With “THE CLONE HAS CONTROL OF TV” message on display, press **2** on the Installer Remote to select **TEACH TO TV** from the LT2002 Clone Selection Menu. Then, press **OK**.
5. Select the LT2002 Memory Bank in which the new Master TV Setup is located, and press **OK**.
6. Verify the Teaching setup information on the next screen, and then press **POWER** to transfer the Master TV Setup to the Target TV.  
Teaching usually takes 3 to 4 minutes. “TEACHING IN PROGRESS” will be displayed on the screen during Teaching. When the Teaching process is complete, a “TEACHING COMPLETE” message will be displayed.
7. When Teaching is done, disconnect the MPI cable from the Target TV, and turn OFF the TV.
8. After a few seconds, turn ON the TV, and verify that the Master TV Setup is now resident on the Target TV.

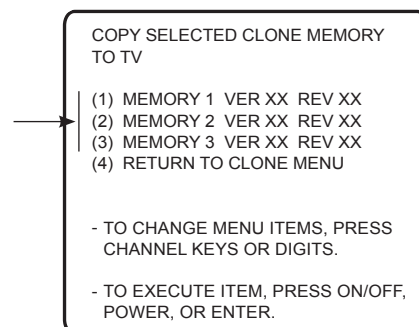
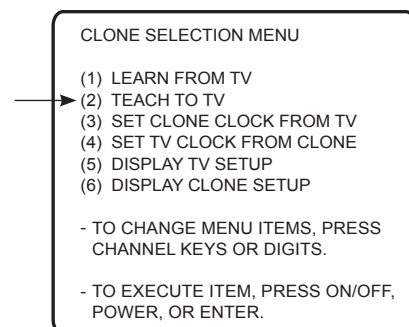

## FTG Mode Overview

FTG Mode enables Pro:Idiom decryption and also allows logical channel mapping of physical channels. This mode provides the following features:

- Logical channels mapped to RF delivered content.
- Digital RF channel minor (program) numbers up to 999.
- FTG Channel Map of up to 600 logical channels.
- Start Channel set for RF or Aux input delivered content.
- Pro:Centric data delivery over RF.
- TV Zoning option for location-specific configuration.

FTG Mode requires that you use LG FTG File Manager PC software to create an FTG Configuration (.tlx) file, which will in turn be used to configure the CPU. In this mode, the CPU is the owner of the FTG Channel Map and must be configured with an FTG Channel Map and FTG Installer Menu settings using one of the following processes:

- Local: Configure an individual 42LQ640H TV via its USB port using an FTG Configuration (.tlx) file on a USB memory device. The “Teach to TV (TLX)” process, along with associated procedures, is described on pages 45 to 49.
- Remote: Configure all 42LQ640H TVs at the site using a Pro:Centric server (Example: PCS150R). Load an FTG Configuration (.tlx) file on the Pro:Centric server using the TV E-Z Installation “Configuration” option in the Pro:Centric server Admin Client. Refer to the ***Pro:Centric Server Admin Client User Guide*** for further information.

While the TV is in FTG Mode:

- Users can still access the Installer Menu using an LG Installer Remote; however, all Installer Menu items will be read-only.
- Any FTG configuration changes must be made using the FTG File Manager. FTG Channel Map Configuration and FTG Installer Menu Configuration Utilities enable you to make changes, respectively, to the FTG Channel Map and FTG Installer Menu settings as necessary. See information on local configuration in this document or refer to documentation for the head end device/server for information on remote management.
- If it becomes necessary to restore the TV to Pass-through Mode, there are several options that will enable you to do so. Refer to Reference section, “Restoring Factory Defaults on the TV(s),” for further information.

Pages 50 to 53 provide overviews of the utilities that comprise the FTG File Manager. Refer to the ***Free-To-Guest (FTG) File Manager User Guide*** for further information on the FTG File Manager.

# FTG Mode of Operation (Cont.)

---

## Determining the TV Operating Mode

To determine the operating mode of the TV, press **MENU** on the Installer Remote. The menu displayed depends on the operating mode. See examples below.

If the Function Menu appears, the TV is in a mode (FTG, PPV, etc.) that does not allow the end user to change the fundamental TV setup. If the TV setup menus appear, the TV is in Pass-through Mode.

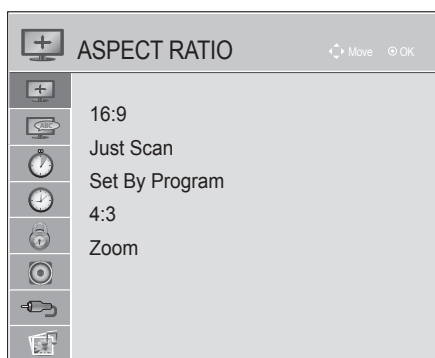

### Function Menu

Indicates the TV is not in Pass-through Mode. While the TV is in this mode, Installer Menu settings can be accessed as read-only.

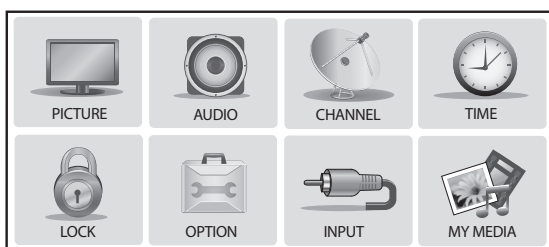

### TV Setup Menus

Shows that the TV is in Pass-through Mode.

### Creating an FTG Configuration File using the FTG File Manager

This section describes how to create an FTG Configuration (.tlx) file that can be saved to a USB memory device. In order to enable Pro:Idiom decryption, it is recommended that you create an FTG Configuration file using the FTG File Manager.

Before you begin, note the following:

- FTG File Manager software is available online at: [www.LGolutions.com/ftgsoftware](http://www.LGolutions.com/ftgsoftware).
- There is also an option to save (Learn) an FTG Configuration file from a TV, which may be desirable or required in either of the following situations:
  - If you want to save customized TV setup menu settings to the FTG Configuration file (in addition to the FTG Channel Map and FTG Installer Menu settings).
  - If you do not know the RF channels at the site.

See “Learning FTG Configuration from a TV” on page 48 for further information. However, if you use this option to save an FTG Configuration file, it is still highly recommended that you open the saved FTG Configuration file in the FTG File Manager to verify the file contents/settings and to enable Pro:Idiom decryption by marking Encrypted channels using the FTG Channel Map Editor.

The procedure below provides an overview of the steps required to create an FTG Configuration (.tlx) file. Refer to the **Free-To-Guest (FTG) File Manager User Guide** for further information. See also FTG File Manager sample screens on pages 50 to 53.

1. Install (if necessary) and launch the FTG File Manager (v1.1.0 or higher) on the PC that will be used to create the FTG Configuration (.tlx) file.
2. You have several options at this time:
  - To view and/or base a new FTG Configuration file on an existing FTG Configuration (.tlx) file, click the **Open** button in the TLX File command section of the FTG File Manager main screen, and select the desired (.tlx) file.

A list of the file’s contents will be displayed in the TLX File Contents window. Either double-click on an individual item to copy it or click the **Copy All** button directly above the TLX File Contents window to automatically copy all the contents of the opened .tlx file to the FTG Configuration List and, if applicable, TV Setup Menu List. Note, though, that while TV setup menu settings can be included in the new FTG Configuration file, the TV setup menu settings are not available for editing.

Edit the configuration of the items in the FTG Configuration List as well as the FTG Configuration List itself and/or the TV Setup Menu List, as necessary, to create a new file. Then, proceed to step 3 when you are ready to continue.
  - To open an existing FTG Configuration (.rml) file created in the FTG Device Configuration Application to use its FTG Channel Map and/or FTG Installer Menu settings, click **File** and then **Open** from the FTG File Manager menu bar, and select/double-click on the desired “.rml” file.

Edit channels and/or settings as necessary, and then proceed to step 3 when you are ready to continue.
  - Create a new FTG Channel Map using the FTG Channel Map Editor in the FTG Channel Map Configuration Utility. Up to 600 logical channels can be defined in the FTG Channel Map.

When you are ready to continue, click **Configure** and then **FTG File Manager** from the FTG File Manager menu bar to return to the FTG File Manager main screen, and then proceed to step 3.

(Continued on next page)

## FTG Mode of Operation (Cont.)

---

(Continued from previous page)

**Note:** To remove an individual item from the FTG Configuration List or the TV Setup Menu List, click on/highlight the item to be removed, and then click the **Remove Item** button directly above the applicable “List” window. To clear both the current FTG Configuration List and TV Setup Menu List contents, click the Clear button in the List command section of the FTG File Manager main screen.

**Note:** To clear the current TLX File Contents, click the **New** button in the TLX File command section of the FTG File Manager main screen (above the TLX File Contents window).

3. To add an FTG Channel Map to the FTG Configuration List, click **>>** under FTG Channel Map. This will copy the current mapped channels to the FTG Configuration List.

**Note:** If you make any change(s) in the FTG Channel Map Configuration Utility to the current data to be included in the FTG Configuration List, you will need to recopy the FTG Channel Map to the FTG Configuration List.

4. (Optional) Load default FTG Installer Menu settings for the TV:

- Click the down arrow at the right of the Chassis field in the Installer Menu Templates section of the FTG File Manager main screen, and select the appropriate chassis (42LQ640H) from the drop-down list of available models.
- Click the **Load** button.
- Use the FTG Installer Menu Configuration Utility to modify settings, if necessary. Then, return to the FTG File Manager main screen.

5. If you wish to assign a Zone designation for the current FTG Installer Menu settings, click on the down arrow at the right of the Zone field (below the FTG Installer Menu Settings field), and select the appropriate Zone (1–8).

**Note:** See Reference section, “Using the TV Zoning Feature,” for further information on the TV Zoning feature and setting the TV Zone # in the TV(s).

6. To add FTG Installer Menu settings to the FTG Configuration List, click **>>>** under FTG Installer Menu Settings. This will copy the selected model settings to the FTG Configuration List.

**Note:** If you make any change(s) in the FTG Installer Menu Configuration Utility to the current data to be included in the FTG Configuration List, you will need to recopy the FTG Installer Menu settings to the FTG Configuration List.

**Note:** At the top of both the FTG Configuration List and TV Setup Menu List windows, an Edit Zone field enables you to change the Zone assignment for each 42LQ640H Installer Menu and/or TV Setup Menu profile, if desired. Select/highlight the desired profile, and then click on the down arrow at the right of the applicable Edit Zone field to select the appropriate Zone.

7. Click the **Save** button in the List command section of the FTG File Manager main screen to save the FTG Configuration List and, if present, TV Setup Menu List contents to an FTG Configuration (.tlx) file on the PC’s hard drive for later use.

In the Save As pop-up window, name the file, and click **Save**. The default folder path is C:\Program Files\Zenith\FTG\TLX. Note that the FTG Configuration file will have a “.tlx” extension.

**Note:** To remove an individual item from the FTG Configuration List or the TV Setup Menu List before saving the new file, click on/highlight the item to be removed, and then click the **Remove Item** button directly above the applicable window. To clear both the current FTG Configuration List and TV Setup Menu List contents, click the **Clear** button in the List command section of the FTG File Manager main screen.

8. Transfer the FTG Configuration (.tlx) file to a USB memory device, and proceed to “Teaching FTG Configuration to a TV” on the following page to transfer the FTG Configuration file to a 42LQ640H TV.

## Teaching FTG Configuration to a TV

This procedure describes how to “Teach” an FTG Configuration file from a USB memory device to a TV. Ensure you have completed the procedure on the previous page to create the FTG Configuration file before proceeding with the steps below.

**Note:** If the TV is currently in Pass-through Mode and you intend to use the TV Zoning feature, make sure to assign a TV Zone # as described in Reference section, “Using the TV Zoning Feature,” BEFORE continuing with the procedure below.

1. Turn ON the Target 42LQ640H TV.  
If the Express Script Installer Menu wizard appears on the screen when you turn ON the TV, use the Up/Down arrow keys on the Installer Remote to select **Exit**, and press **OK**.
2. Insert the USB memory device that contains the FTG Configuration file into the TV’s USB IN port.
3. Press **MENU** on the Installer Remote to display the TV setup menus (TV is in Pass-through Mode) or the Function Menu (TV is already in FTG Mode).
4. Use the arrow navigation keys to select/highlight either the **Option** menu icon from the TV setup menus or the **Lock** menu icon from the Function Menu. Then, press the number “7” key a total of seven times to display the USB Download Menu.
5. Use the Up/Down arrow keys to select **Teach To TV (TLX)**, and then press **OK**.
6. Use the Up/Down arrow keys to select the FTG Configuration file you want to install, and then press **OK**.  
Teaching status will be shown on a progress bar in a new window. Do NOT remove the USB device until Teaching is complete. When the Teaching process is complete, the TV will briefly display a “Teaching Completed” window and then exit the USB Download Menu.
7. Remove the USB memory device from the Target TV, and verify that the FTG Configuration is now resident on the Target TV.

The Target TV CPU is now in FTG Mode (if it was previously in Pass-through Mode).

**Note:** After the Teaching process is complete, the TV tunes according to the Start Channel setting in the Installer Menu. If a Start Channel is specified, the TV will tune to that channel; otherwise, the TV will tune to the lowest logical channel in the FTG Channel Map.

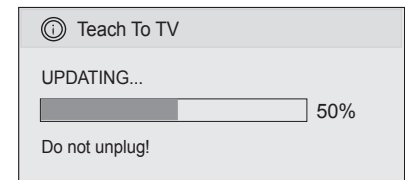
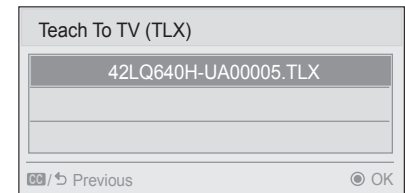
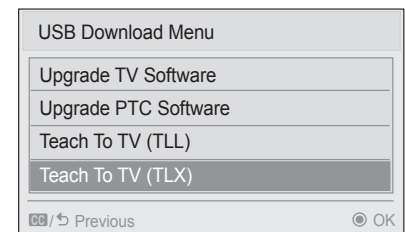

# FTG Mode of Operation (Cont.)

## Learning FTG Configuration from a TV

To ensure that Pro:Idiom decryption is enabled, it is recommended that you create an FTG Configuration file using the FTG File Manager as described on pages 45 to 46. However, if necessary, this option enables you to save (Learn) an FTG Configuration file from a 42LQ640H TV to a USB memory device.

The option to save (Learn) an FTG Configuration file from a TV may be desirable or required in either of the following situations:

- If you want to save customized TV setup menu settings to the FTG Configuration file (in addition to the FTG Channel Map and FTG Installer Menu settings).
- If you do not know the RF channels at the site.

**Note:** If the TV is NOT already in FTG Mode, you may need to perform some manual configuration on the TV before you start this procedure (see “Optional Manual Configuration / TV Setup” on next page).

**Note:** If you intend to use the TV Zoning feature, make sure to assign a TV Zone # as described in Reference section, “Using the TV Zoning Feature,” BEFORE continuing with the procedure below.

1. Turn ON the TV, and then insert a USB memory device into the USB IN port on the TV.
2. Press **MENU** on the Installer Remote to display the TV setup menus (TV is in Pass-through Mode) or the Function Menu (TV is already in FTG Mode).
3. Use the arrow navigation keys to select/highlight either the **Option** menu icon from the TV setup menus or the **Lock** menu icon from the Function Menu. Then, press the number “7” key a total of seven times to display the USB Download Menu.
4. To gain access to the Learn From TV options in the USB Download Menu, key in the password used to access the Installer Menu (Example: Press **9-8-7-6**).
5. Use the Up/Down arrow keys to select **Learn From TV (TLX)**, and then press **OK**.
6. To differentiate this .tlx file from others, you can use the Up/Down arrow keys to change the last five digits of the filename. Press **OK** when you are ready to initiate Learning.

Learning status will be shown on a progress bar in a new window. Do NOT remove the USB device until Learning is complete. When the Learning process is complete, the USB Download Menu will reappear on the screen.

7. When Learning is done, press **CC** on the Installer Remote to exit the USB Download Menu, and remove the USB memory device.

 **Note:** It is highly recommended that you open this FTG Configuration file in the FTG File Manager—BEFORE transferring (Teaching) the file to any TVs—to verify FTG Channel Map and FTG Installer Menu settings and enable Pro:Idiom decryption by marking Encrypted channels. This will also enable you to confirm channels and add channel attributes, labels, etc.

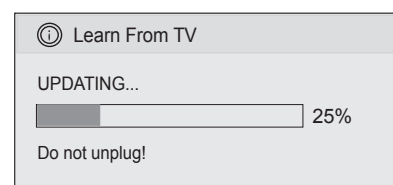
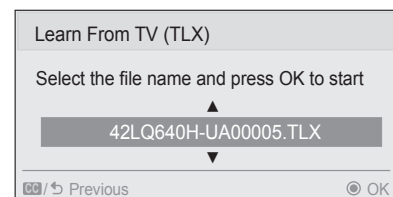
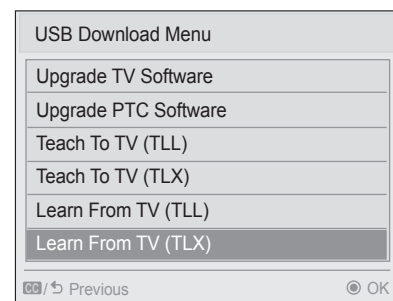



## Optional Manual Configuration / TV Setup

The manual configuration procedures below should only be performed if you do not know the RF channels at the site and need to “Learn” FTG Configuration from a 42LQ640H TV as described on the previous page. Ensure the TV is in Pass-through Mode before you begin.

**Note:** These configuration procedures parallel the initial steps required for creating a custom Master TV Setup. See also screen examples on pages 26 to 27.

### Set Installer Menu Items

These steps provide specific instruction only on the Installer Menu items that should be set on a 42LQ640H TV. Refer to pages 15 to 24 for detailed information on all Installer Menu items.

1. Turn ON the TV.\* Then, use the Installer Remote to access the Installer Menu (see “Accessing the Installer Menu” on page 15 for further information).
2. Set Installer Menu item **117 FACT DEFAULT** to **1** and press **OK** on the Installer Remote.  
This clears all Installer Menu custom settings, the channel lineup, etc. and restores the factory default settings. The value will change back to 0 after the commercial controller (PTC) has been restored to factory default condition. This step ensures that the TV Channel Memory will be the active channel lineup.
3. Set Installer Menu item **003 BAND/AFC**, as appropriate.
  - Broadcast: Set to 0.
  - CATV: Set to 1 (default).
  - HRC: Set to 2.
  - IRC: Set to 3.
4. Set Installer Menu item **027 HOSPITAL MODE**, as appropriate, to select the speaker configuration. Also, set any other Installer Menu items that affect your TV programming network to the required configuration. For example, enable/disable Aux inputs, set a Start Channel, etc.
5. After you have adjusted all Installer Menu item settings as required, press **OK** once on the Installer Remote to save your changes; then, press **OK** again to exit the menu.

### Set Up TV Features

On-screen setup menus control the features of the TV. Press **MENU** on the Installer Remote to access the TV setup menus, and then set Channel, Picture, Audio, Time, etc. options to the desired configurations. In particular, if you intend to use the TV Zoning feature, make sure to assign a TV Zone # in this TV as described in Reference section, “Using the TV Zoning Feature.”

### Run Auto Tuning (Channel Search)

**Note:** In the FTG Configuration file, Logical Channel numbers will automatically be assigned in ascending order, starting with 0 (zero), to the Physical Channels from the TV Channel Map.

**Note:** Pro:Idiom decryption for encrypted channels will not be enabled unless you use the FTG File Manager to set the channel attributes.

1. Search for all available analog and digital channels: Use the Installer Remote to go to the Channel Menu, select the **Auto Tuning** option, and follow the on-screen instructions.
2. Use the **Channel Edit** option in the Channel Menu to edit the channel lineup, as necessary, to include free to guest channels only. Add/delete channels per your system requirements.

Once you have completed these procedures, return to “Learning FTG Configuration from a TV” on the previous page to complete the Learn sequence.

\* If the Express Script Installer Menu Wizard appears on the screen when you turn ON the TV, use the Up/Down arrow keys on the Installer Remote to select **Exit**, and press **OK**. Note that in this case, you will not need to perform step 2 because the TV is already in a factory default state.

# FTG File Manager Utilities Overview

## FTG File Manager Main Screen

The FTG File Manager main screen enables you to compile, modify, and save FTG Configuration (.tlx) files. It also allows you to assign a Zone designation to each Installer Menu profile, if desired (see Reference section, "Using the TV Zoning Feature," for further information).

The screenshot shows the FTG File Manager interface with several callouts:

- FTG CONFIGURATION LIST**: Data to be saved in FTG Configuration (.tlx) file.
- CLEAR/SAVE**: FTG Configuration and TV Setup Menu List options.
- NEW/OPEN**: TLX File options.
- Filename of opened FTG Configuration (.rml) file created using FTG Device Configuration Application.**: Points to the FTG File input field.
- Copy FTG Channel Map to and from FTG Configuration List.**: Points to the FTG Channel Map section.
- Copy FTG Installer Menu settings to and from FTG Configuration List. Assign Zone as applicable.**: Points to the FTG Installer Menu Settings section.
- Load default FTG Installer Menu for 42LQ640H chassis.**: Points to the Installer Menu Templates section.
- TV SETUP MENU LIST**: Data to be saved in FTG Configuration file.
- TLX FILE CONTENTS**: Data contained in opened FTG Configuration (.tlx) file.



**Note:** The data referenced in the FTG Configuration List is only a snapshot of the current FTG Channel Map and FTG Installer Menu settings when copied to the list. If you make any change(s) to the current data to be included in the FTG Configuration List, you will need to recopy Channel Map and Installer Menu settings to the FTG Configuration List.



# FTG File Manager Utilities Overview (Cont.)

## FTG Channel Map Editor

The FTG Channel Map Editor shows a single Logical Channel's data and the FTG Channel Map.

### LOGICAL CHANNEL MAPPING

Select a Logical Channel number. Then, assign it the RF, Major, and Minor channel numbers to complete the mapping.

### CUSTOM CHANNEL LABELS/ICONS

Enter custom labels and select icons by name on menu or by number.

### SET CHANNEL ATTRIBUTES

Check/select Encrypted, OSD, or Blank Video.

Logical	RF	Major	Minor	Label	ICON	Attribute	Restricted
2	2	2	0	WBBM-TV	14 - CBS	0	
5	5	5	0	WMAQ-TV	15 - NBC	0	
7	7	7	0	WLS-TV	13 - ABC	0	
9	9	9	0	WGN-TV	89 - WGN	0	
11	11	11	0	WTTW	17 - PBS	0	
14	31	31	3	FOX	16 - FOX	0	
15	19	19	3	WGN	89 - WGN	0	
16	47	47	4	KIDS	133 - PBS Kids	0	
17	27	27	3	THE U	174 - UPN	0	
40	65	65	1	HBO-HD	12 - HBO	EO	
41	65	65	11	ESPN-HD	2 - ESPN	EO	
42	67	67	1	ESPN2HD	21 - ESPN2	EO	

### ZONE RESTRICTION

Select Zone restriction for channel. See Reference section, "Using the TV Zoning Feature," for further information.

### ADD

After defining a new Logical Channel, click to add channel to the FTG Channel Map.

### EXIT

Click to exit editor and return to FTG Channel Map Configuration Utility.

### UPDATE

After editing an existing Logical Channel's data, click to commit the changes in the FTG Channel Map.

### DELETE

Click to remove highlighted channel from FTG Channel Map.

## FTG Installer Menu Configuration Utility

### CONFIGURATION SETTINGS

Select tabs for categories of Installer Menu items to set up TV.

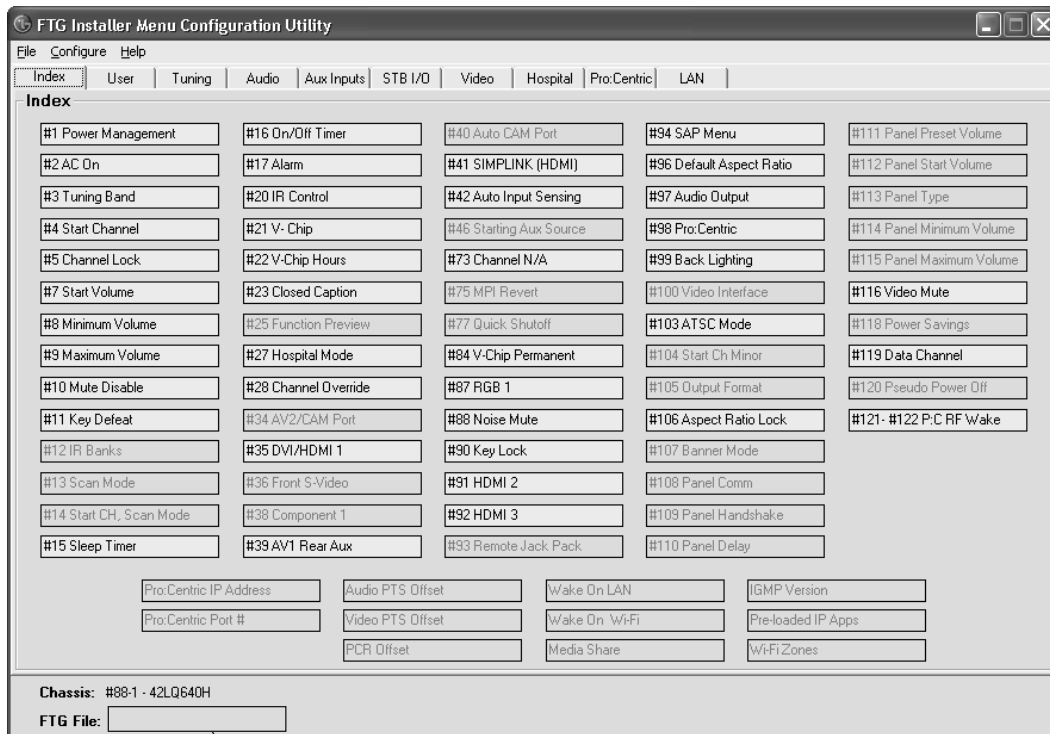

Filename of opened FTG Configuration (.rml) file created using FTG Device Configuration Application.

**Note:** The Pro:Centric tab enables you to set up Pro:Centric-specific parameters. Refer to the **Free-To-Guest (FTG) File Manager User Guide** for further information.

# Reference: Upgrading TV/PTC Software using a USB Memory Device

## Checking the Software Versions

You can check the software versions of the TV by accessing the Installer Menu with the Installer Remote (see “Accessing the Installer Menu” on page 15 for further information).

When you are finished, press **OK** again to exit the Installer Menu.

Typical Installer Menu Footer

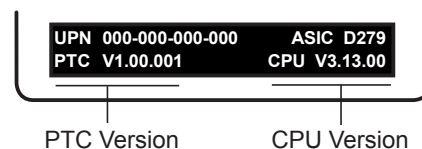

## Upgrading TV/PTC Software

Before you begin, note that the software upgrade files must be stored in a folder named “LG\_DTV” in the root directory of the USB memory device. Also, ensure the USB device has been formatted with FAT format.

**Note for TV Software Upgrade only:** If the TV detects a later version of software on the USB device, it will automatically display a dialog from which you can start the software upgrade immediately. Otherwise, you can close the dialog, and access the USB Download Menu as described below.

1. Turn ON the TV, and then insert the USB memory device into the USB IN port on the TV.
2. Press **MENU** on the Installer Remote to display the TV setup menus (TV is in Pass-through Mode) or the Function Menu (TV is not in Pass-through Mode).
3. Use the arrow navigation keys to select/highlight either the **Option** menu icon from the TV setup menus or the **Lock** menu icon from the Function Menu. Then, press the number “7” key a total of seven times to display the USB Download Menu.
4. Use the Up/Down arrow keys to select **Upgrade TV Software** or **Upgrade PTC Software**, as applicable, and then press **OK**.
5. Select the appropriate option(s), depending on the type of upgrade:
  - TV Software Upgrade: (See screen samples at right.) Select **TV Software Update** from the first TV Software Update window. In the second TV Software Update window, select/highlight the update file to install and press **OK**.  
**Note:** Do not select Forced Update options unless you have been specifically instructed to do so or have previous experience with Expert Software Updates.
  - PTC Software Upgrade: In the PTC Software Update window, select/highlight the update file to install and press **OK**.  
**Note:** The PTC Software Update window is similar to the second TV Software Update window. Current software version information is shown at the top and update files on the USB device are listed at the bottom of the window.

The TV will show update completion progress in a new window. Do NOT remove the USB device until the software upgrade is complete. When a TV software upgrade is complete, the TV will reset itself with an automatic restart. When a PTC upgrade is complete, the TV will turn OFF.

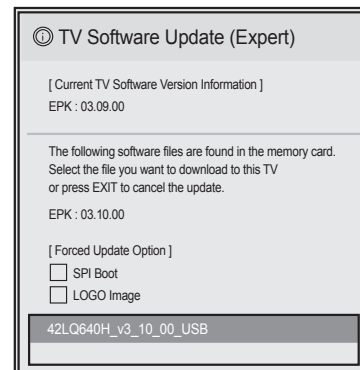
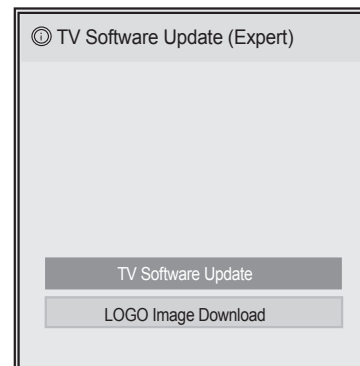
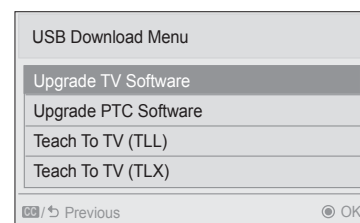

# Reference: Downloading a Splash Screen using a USB Memory Device

## Splash Screen Image File Guidelines

- The splash screen image must be a baseline (not progressive) 24-bit JPEG.
- The image should be no larger than 1 MB.
- The maximum resolution allowed for a 42LQ640H splash screen image is 1920 x 1080 pixels (FHD).
- Avoid using special characters, such as ?, -, etc., in the splash screen image file name.

## Downloading a Splash Screen Image

Before you begin this procedure, note that the splash screen image file must be stored in a folder named “LG\_DTV” in the root directory of the USB memory device. Also, ensure the USB device has been formatted with FAT format.

1. Turn ON the TV, and then insert the USB memory device into the USB IN port on the TV.
2. Press **MENU** on the Installer Remote to display the TV setup menus (TV is in Pass-through Mode) or the Function Menu (TV is not in Pass-through Mode).
3. Use the arrow navigation keys to select/highlight either the **Option** menu icon from the TV setup menus or the **Lock** menu icon from the Function Menu. Then, press the number “7” key a total of seven times to display the USB Download Menu.
4. Use the Up/Down arrow keys to select **Upgrade TV Software**, and then press **OK**.
5. Select **LOGO Image Download** from the first TV Software Update window.
6. In the second TV Software Update window, use the Up/Down arrow keys to select the image file to download, and then press **OK**.

The TV will show download completion progress in a new window. Do NOT remove the USB device until the image download is complete. When the image download is complete, the TV will reset itself with an automatic restart. Upon the restart, you should see the new splash screen.

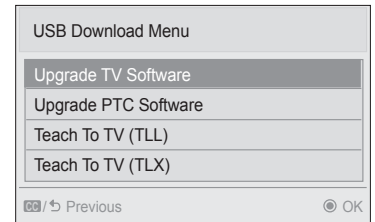

## Reference: Power Consumption Settings

The following tables assume Installer Menu item 099 BACK LIGHTING is set as shown below (default value is 255).

Item 099 Back Lighting (Static)	42LQ640H	
	Power Consumption (Watts)	Percent Savings
100	67.0	0.0%
90	63.3	5.5%
80	60.4	9.9%
70	58.2	13.1%
60	56.8	15.3%
50	54.5	18.7%
40	51.9	22.5%
30	46.0	31.3%
20	40.5	39.6%
10	34.6	48.4%
1	29.2	56.4%

Item 099 Back Lighting (Dynamic)	42LQ640H	
	Power Consumption (Watts)	Percent Savings
200	67.0	0.0%
190	63.3	5.5%
180	60.4	9.9%
170	58.3	13.0%
160	56.8	15.3%
150	54.5	18.7%
140	52.0	22.4%
130	46.0	31.3%
120	40.5	39.6%
110	34.6	48.4%
101	29.1	56.6%

Note: Values are results of controlled experiments under laboratory conditions.



# Reference: TV Aux Input Configuration

DIRECT ACCESS Tuning *		TV		ENABLE					MPI DATA				Installer Menu Item 046 START AUX SRCE (Start Aux Source) Value
				Installer Menu			MPI DATA STATUS TYPE 0x41 SOURCES ENABLED (R/W)		DATA STATUS TYPE 0xD2 CURRENT AV SOURCE (R)		DATA STATUS TYPE 0x0D AUX SOURCE (R)		
Installer Menu Item 029 OLD OCV = 0	Installer Menu Item 029 OLD OCV = 1	Aux Input	Input Mode	Item	Function	Value	Enable Bit	Label	Value	Value	Description		
131	91	Video1 (Rear)	CV	39	REAR AUX EN	1	1	Rear Video (Aux)	1	0	VIDEO	1	
132	92	HDMI2	DTV	91	HDMI2 ENABLE	1	2	S-Video Rear	2	0	VIDEO	5	
			PC			2				2	COMPUTER		
133	93	HDMI1/ DVI	DTV	35	HDMI1 ENABLE	1	3	Front Computer	3	0	VIDEO	3	
			PC			2				2	COMPUTER		
134	94	RGB	PC	87	REAR RGB EN	1	5	SVGA Rear Computer	4	2	COMPUTER	4	
135	95	HDMI3	DTV	92	HDMI3 ENABLE	1	6	NTSC Rear Computer	5	0	VIDEO	7	
			PC			2				2	COMPUTER		

\* Use Installer Remote to enter channel number indicated based on OLD OCV Installer Menu setting.

# Reference: 42LQ640H Hospital Operations

## Hospital Features

The following table identifies when and how the 42LQ640H hospital features are supported in three different TV configurations. As indicated in the introduction to this document, LG commercial TV functionality is based on “ownership” of the Channel Map. For the purposes of this table, “CPU” indicates that the TV is in Pass-through Mode with the Channel Map in the CPU (i.e., auto-tuned/edited Channel Map) and “PTC” indicates that the TV is in Pass-through Mode with the Channel Map in the PTC (i.e., after 2-5-5 + MENU).

**Note:** Even if Scan Mode is enabled, the front panel channel keys cannot be used to turn ON the TV.

Hospital Mode State	Item	CPU		PTC		FTG/PPV Mode	
		Disabled	Enabled	Disabled	Enabled	Disabled	Enabled
Installer Menu	Item						
IR Banks Enable	012				X		
Scan Mode	013	(a)	(a)	X	X		
Start Channel in Scan Mode	014			X	X		
Feature Level	020						
Bed 1/Bed 2	020	X		X		X	
Multi-code IR	020	X	X	X	X	X	X
Speaker	020			X		X	
Function Preview	025			X	X		
Hospital Mode	027						
Bed 1/Bed 2	027		X		X		X
Pillow Speaker Voltage	027	(b)	X	(b)	X	(b)	X
Speaker	027	X	X		X		X
Quick Shutoff	077	(c)	(c)	(c)	(c)		
<b>Channel Banks</b>							
Number of Banks Enabled				1	4		
Channel Preview/Banks Setup Menu				X	X		
Blanked Channel				X	X	X	X
Inactive TV					X		
SAP Key					X		
<b>Aux Input Sources</b>							
Input List Menu		X	X	X		X	X
Aux in Scan List				X	X	(d)	(d)
<b>TV Setup Menus</b>							
Audio (TV Speaker)		(e)	(e)	(e)	(e)		
Option (Power Indicator)		X	X	X	X		

X = feature supported

a) Turn ON function only. Always goes to channel 2-0.

b) Defaults to Zenith pillow speaker code/(+12v) supply voltage.

c) Quick Shutoff feature only functions when Scan Mode is enabled and if you are using an analog pillow speaker.

d) Dependent upon installer-defined Logical Channel Map.

e) Audio Menu is only accessible when the speaker selected is TV Only or both TV & Pillow.

## Reference: 42LQ640H Hospital Operations (Cont.)

---

### Speaker Selection

The following table outlines speaker settings as determined by Installer Menu items 027 HOSPITAL MODE and 020 FEATURE LEVEL.

Item 027 HOSPITAL MODE Value	Item 020 FEATURE LEVEL Value	Audio Menu TV Speaker	Speaker
0	0 ~ 24	OFF	None
0	0 ~ 24	ON	TV Only
0	64 ~ 65	N/A	Pillow Only
1 ~ 34	N/A	N/A	Pillow Only
65 ~ 98	N/A	OFF	None
65 ~ 98	N/A	ON	TV Only
129 ~ 162	N/A	OFF	Pillow Only
129 ~ 162	N/A	ON	Pillow & TV

**Note:** If the TV is in FTG Mode, the Audio Menu is no longer accessible.

## Reference: Restoring Factory Defaults on the TV(s)

---

This section describes how to restore factory defaults either on a single TV that is currently in Pass-through or FTG Mode or on multiple TVs that are currently in FTG Mode.

**Note:** If the TV(s) is/are currently in FTG Mode, restoring the factory defaults also resets the TV to Pass-through Mode.

### Installer Menu Item 117 FACT DEFAULT

If the TV is currently in Pass-through Mode, you can set Installer Menu item 117 FACT DEFAULT to 1 to restore the factory defaults and clear the channel lineup, including any assigned channel icons and custom text labels.

### Factory “IN-STOP”

If the TV is currently in FTG Mode, a predefined value for Installer Menu item 117 FACT DEFAULT enables access to initiate a factory “IN-STOP” process that will restore the TV to Pass-through Mode in addition to restoring all factory defaults. Contact technical support for the required value for Installer Menu item 117 and for additional information on performing the IN-STOP from the Installer Menu.

### Additional FTG Mode Options

There are two additional options for restoring Pass-through Mode/factory defaults on TVs that are in FTG Mode. The first enables you to restore a single TV to Pass-through Mode, while the second enables you to restore multiple TVs to Pass-through Mode at one time. However, both options require that you create a “Zero Mapped Channels” FTG Configuration (.tlx) file, i.e., an FTG Configuration file with no data. Refer to the **Free-To-Guest (FTG) File Manager User Guide** for further information.

- Using a USB memory device, “Teach” a “Zero Mapped Channels” FTG Configuration (.tlx) file to the TV. Refer to “Teaching FTG Configuration to a TV” on page 47 of this document for further information on the Teaching process.
- If your system uses a Pro:Centric server for remote management/administration, use the Pro:Centric Admin Client to load a “Zero Mapped Channels” FTG Configuration (.tlx) file on the Pro:Centric server. Refer to the **Pro:Centric Server Admin Client User Guide** for further information.

## Reference: Auto Input(s) Sensing Feature

This section provides detailed settings information for Installer Menu item 042 AUTO INPUTS. To disable auto-sensing for all available Aux inputs, set item 042 to 0. To enable auto-sensing for all available Aux inputs, set item 042 to 255. For specifications on all other available settings (i.e., settings for individual inputs), refer to the table on the following page.

**Note:** When both item 042 AUTO INPUTS *and* item 041 SIMPLINK EN are enabled in the Installer Menu, HDMI inputs will be detected by SIMPLINK, but the Auto Input(s) Sensing Feature will not function.

In the Installer Menu, an informational code is displayed at the right of each Auto Inputs value, for example:

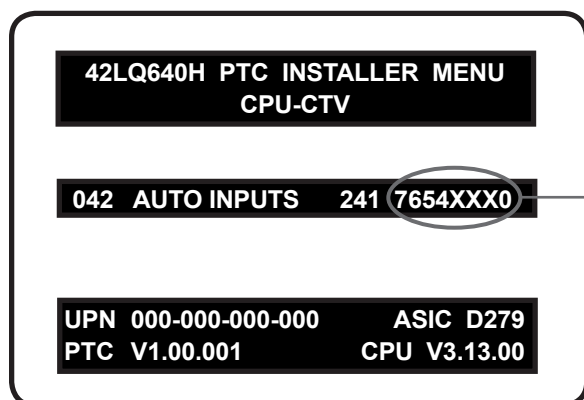

### AUTO INPUTS Display Code

This example illustrates Installer Menu item 042 value 241, which enables auto-sensing for all available Aux inputs. The input #s in the display code (7, 6, 5, 4, 0 in this example) identify the enabled Aux inputs. See table below for a listing of the 42LQ640H Aux inputs and their corresponding display code input #s. The table on the following page shows the display codes for all item 042 values.

Each code consists of eight characters that identify the Aux input(s) for which auto-sensing is enabled. The following table identifies the Installer Menu display code Input # for each Aux input that is available on the 42LQ640H TV models. The table also identifies the Installer Menu item associated with each Aux input. Remember that in order for auto-sensing to be enabled for an input, that input must also be enabled in the Installer Menu.

Installer Menu Display Code Input #	Aux Input	Installer Menu	
		Item	Function
0	AV1	039	REAR AUX EN
4	RGB	087	REAR RGB EN
6	HDMI 1	035	HDMI1 ENABLE
7	HDMI 2	091	HDMI2 ENABLE
5	HDMI 3	092	HDMI3 ENABLE

## Reference: Auto Input(s) Sensing Feature (Cont.)

Item 042 Value	Inputs					Installer Menu Display
	AV1	RGB	HDMI 1	HDMI 2	HDMI 3	
001	Enabled	Disabled	Disabled	Disabled	Disabled	DDDDXXX0
016	Disabled	Enabled	Disabled	Disabled	Disabled	DDD4XXXD
017	Enabled	Enabled	Disabled	Disabled	Disabled	DDD4XXX0
032	Disabled	Disabled	Disabled	Disabled	Enabled	DD5DXXXD
033	Enabled	Disabled	Disabled	Disabled	Enabled	DD5DXXX0
048	Disabled	Enabled	Disabled	Disabled	Enabled	DD54XXXD
049	Enabled	Enabled	Disabled	Disabled	Enabled	DD54XXX0
064	Disabled	Disabled	Enabled	Disabled	Disabled	D6DDXXXD
065	Enabled	Disabled	Enabled	Disabled	Disabled	D6DDXXX0
080	Disabled	Enabled	Enabled	Disabled	Disabled	D6D4XXXD
081	Enabled	Enabled	Enabled	Disabled	Disabled	D6D4XXX0
096	Disabled	Disabled	Enabled	Disabled	Enabled	D65DXXXD
097	Enabled	Disabled	Enabled	Disabled	Enabled	D65DXXX0
112	Disabled	Enabled	Enabled	Disabled	Enabled	D654XXXD
113	Enabled	Enabled	Enabled	Disabled	Enabled	D654XXX0
128	Disabled	Disabled	Disabled	Enabled	Disabled	7DDDXXXD
129	Enabled	Disabled	Disabled	Enabled	Disabled	7DDDXXX0
144	Disabled	Enabled	Disabled	Enabled	Disabled	7DD4XXXD
145	Enabled	Enabled	Disabled	Enabled	Disabled	7DD4XXX0
160	Disabled	Disabled	Disabled	Enabled	Enabled	7D5DXXXD
161	Enabled	Disabled	Disabled	Enabled	Enabled	7D5DXXX0
176	Disabled	Enabled	Disabled	Enabled	Enabled	7D54XXXD
177	Enabled	Enabled	Disabled	Enabled	Enabled	7D54XXX0
192	Disabled	Disabled	Enabled	Enabled	Disabled	76DDXXXD
193	Enabled	Disabled	Enabled	Enabled	Disabled	76DDXXX0
208	Disabled	Enabled	Enabled	Enabled	Disabled	76D4XXXD
209	Enabled	Enabled	Enabled	Enabled	Disabled	76D4XXX0
224	Disabled	Disabled	Enabled	Enabled	Enabled	765DXXXD
225	Enabled	Disabled	Enabled	Enabled	Enabled	765DXXX0
240	Disabled	Enabled	Enabled	Enabled	Enabled	7654XXXD
241	Enabled	Enabled	Enabled	Enabled	Enabled	7654XXX0

X = Aux input source is Disabled or Not Available (i.e., on this TV model)

D = Auto-sensing for input is Disabled

Input # = Auto-sensing for input is Enabled

# Reference: Using the TV Zoning Feature

---

This section describes the TV Zoning feature available with the 42LQ640H model TVs. The TV Zoning feature enables you to create localized configurations for TVs in selected locations, or “Zones,” within the installation environment. This feature is primarily intended for use when the TV is configured for FTG Mode via CPU operation. However, selected elements of TV Zoning (Installer Menu and TV Setup Menu profile Zone assignments) may also be used with TV cloning processes using a USB memory device / .tlx file.

Refer to the appropriate section(s) below for further information on the TV Zoning feature and how to set the TV Zone # in a TV that is currently in Pass-through Mode.

## Using the TV Zoning Feature with FTG Mode via CPU Configuration

The FTG File Manager may be used to create an FTG Configuration (.tlx) file that contains multiple Zone assignments. Zones can be designated for multiple FTG Installer Menu and/or TV Setup Menu profiles. Zone restrictions can also be assigned to individual channels in the FTG Channel Map. Thus, for example, you may create an FTG Installer Menu and/or TV Setup Menu profile to be downloaded to a TV in a hotel lobby and also restrict the channels that are available on that TV.

On location, you must set the TV Zone # in all the TVs in a select area, so that the TVs are configured with corresponding FTG Installer Menu and/or TV Setup Menu settings and/or can omit channels that have been restricted in the FTG Channel Map (see “Set the TV Zone # in the TV” on the following page for further information). TV Zone 0 is the default TV Zone #.

The following subsections briefly describe how to assign Zone designations in the FTG File Manager. Refer to the ***Free-To-Guest (FTG) File Manager User Guide*** for further information.

### FTG Installer Menu Profile Zone Assignments

The FTG File Manager main screen enables you to assign a Zone designation to each Installer Menu profile to be included in an FTG Configuration (.tlx) file. For example, you may wish to create one 42LQ640H Installer Menu profile for a hotel lobby and another 42LQ640H Installer Menu profile for a fitness center, both of which are different from the FTG Installer Menu profile for standard guest rooms. The TV Zoning feature enables you to save multiple FTG Installer Menu profiles, each with its own Zone assignment, in one FTG Configuration (.tlx) file. If each TV in the aforementioned locations has been assigned a TV Zone # as described in the procedure on the following page, the TV(s) will only download the Installer Menu profile in accordance with its(their) Zone assignment.

In the FTG File Manager main screen, you can also edit the Zone designation for each Installer Menu profile and/or TV Setup Menu profile already present in the FTG Configuration List and TV Setup Menu List windows.

**Note:** See also the FTG File Manager main screen overview on page 50. In addition, note that TV Setup Menu profiles cannot be created in the FTG File Manager; they must be “Learned” from a TV.

### FTG Channel Map Zone Assignments

The FTG Channel Map Editor in the FTG File Manager’s FTG Channel Map Configuration Utility enables you to assign Zone restrictions to individual channels that may be prohibited or deemed unsuitable for certain locations. In the FTG Channel Map Editor, one or more Zone restrictions (1–8) may be placed on each channel that is to be restricted. For example, if you wish to restrict a channel from Zones 2 and 4, select both “Zone 2” and “Zone 4” in the Zone Restriction section of the FTG Channel Map Editor screen when defining or editing that channel.

**Note:** While a channel can be restricted from up to eight Zones, a TV can only ever be in (set for) one Zone. See also the FTG Channel Map Editor overview on page 52.

## Reference: Using the TV Zoning Feature (Cont.)

At the same time, keep in mind that the TV Zone designations are not mutually exclusive. That is, you may opt to configure Zone restrictions for selected channels in the FTG Channel Map, but at the same time, you can choose to configure all TVs at the site with the same Installer Menu and/or TV Setup Menu settings. For example, an FTG Configuration (.tx) file being used to configure the TVs at a site may contain multiple Installer Menu and TV Setup Menu profiles with different Zone designations, as well as several channels with Zone restrictions. Each TV configured with the default TV Zone 0 will download only the Installer Menu and/or TV Setup Menu profile(s) with a Zone 0 designation. If, on the other hand, the TV Zone # is set to 1, during configuration the TV will first attempt to retrieve Installer Menu and/or TV Setup Menu profiles with a Zone 1 designation. If none of the Installer Menu and/or TV Setup Menu profiles has a Zone 1 designation, the TV will download the profile(s) with a Zone 0 designation. For the FTG Channel Map configuration, when the TV Zone # is set to 0, the TV will ignore any Zone restrictions (1–8) that may be placed on channels in the FTG Channel Map. However, when the TV Zone # is set to 1, during configuration, the TV will omit any channels that have been restricted from Zone 1 in the FTG Channel Map.

### Using the TV Zoning Feature with Cloning Configuration

A location-specific configuration / .tx file may be saved (Learned) from an individual TV as part of a Master TV Setup and then be used during Teaching. For example, if the TV Zone # in the Master TV is set to 3 before Learning is initiated, the Master TV's Installer Menu and TV Setup Menu profiles will be saved with the TV Zone 3 assignment when Learning is completed. In order to configure the Target TVs with the Zone 3 Installer Menu and TV Setup Menu profiles Learned from the Master TV, you must set the TV Zone # accordingly in the Target TVs before transferring (Teaching) the Master TV Setup. See "Set the TV Zone # in the TV" below. Also, see "Learning / Teaching a Master TV Setup using a USB Memory Device / .tx File" on pages 35 to 36 for additional information on the cloning processes. TV Zone 0 is the default TV Zone #.

### Set the TV Zone # in the TV

Use the following procedure to set a TV Zone # in the TV. Note that this procedure can only be performed while the TV is in Pass-through Mode.

1. Turn ON the TV.
2. Press **MENU** on the Installer Remote, and use the arrow navigation keys to select/highlight the **OPTION** menu option. Then, press **OK**.
3. Use the Up/Down arrows to select **Zone**, and then press **OK**.
4. In the Zone pop-up window, you can set the TV Zone # so that the TV can be configured with Installer Menu and/or TV Setup Menu settings intended only for the assigned Zone. The Installer Menu and/or TV Setup Menu settings may be provided in a .tx file to be used either for Teaching (cloning) or FTG Mode via CPU configuration. If the TV is being configured for FTG Mode via CPU, the TV Zone # setting also allows the TV to omit channels that have been restricted in the FTG Channel Map. Use the Left/Right arrow keys to select the TV Zone # (1–8) for this TV. Then, press **OK**.
5. Press **MENU** to return to TV viewing.

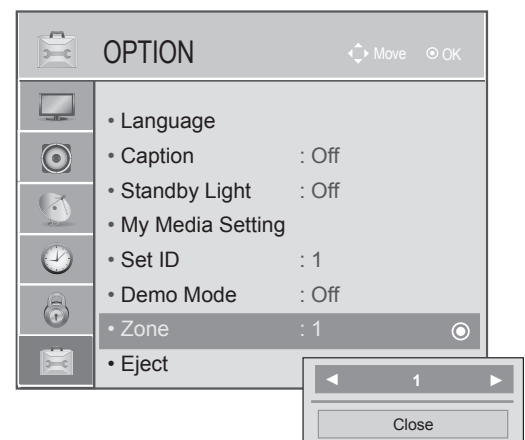



# Reference: 42LQ640H Rear and Side Jack Panels

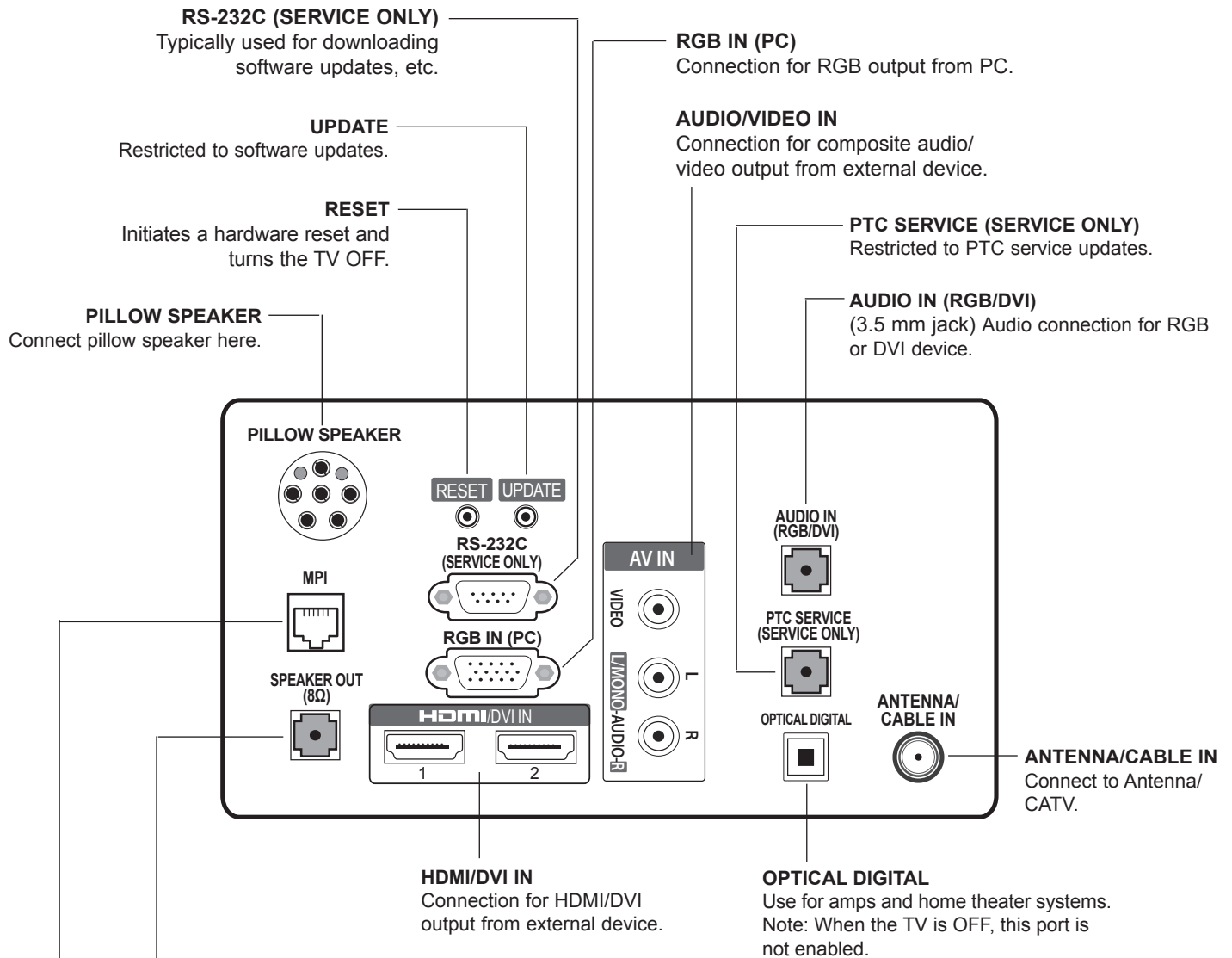

**SPEAKER OUT (8Ω)**  
(3.5 mm jack) Connect external audio (fixed speaker, variable speaker, or fixed line level [amplifier] equipment). See Reference section, "External Stereo Speaker Setup," for further information.

**MPI**  
When the TV is in Pass-through Mode, the MPI function enables an external MPI control device (i.e., clone programmer, VOD/PPV STB, etc.) to control the TV.

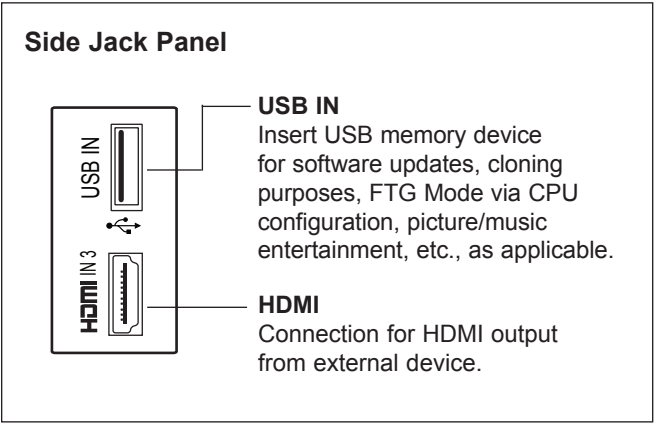

## Reference: External Stereo Speaker Setup

---

The three-contact (left, right, ground) SPEAKER OUT 3.5 mm jack on the 42LQ640H rear panel provides stereo speaker signal outputs (fixed speaker, variable speaker, or fixed line level [amplifier]) for external audio equipment. Set Installer Menu item 097 AUDIO OUTPUT as required in accordance with external audio equipment connected to the TV. Also, refer to the following diagram for pinout details.

 **Caution: Do NOT plug in a mono connector, as this may damage the TV.**

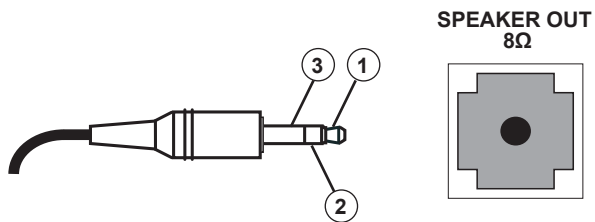

- 
- |   |                 |
|---|-----------------|
| 1 | LEFT (Tip)      |
| 2 | RIGHT (Ring)    |
| 3 | GROUND (Sleeve) |
-

# Reference: Pillow Speaker Setup

The pillow speaker will only be functional after the Express Script/Custom Master TV Setup and/or cloning procedures are complete.

**Note:** When Installer Menu item 027 HOSPITAL MODE is set to 254 (factory default value), there is no power (voltage) supplied to the pillow speaker.

## Connect a Pillow Speaker to the LCD TV

Connect the pillow speaker (see example at right) to the PILLOW SPEAKER interface on the rear jack panel of the TV.

 **Caution:** Use a pillow speaker that is a UL recognized pendant control bearing the warning: “Risk of fire if used in oxygen enriched atmosphere. Keep pendant control away from oxygen equipment.”

## Controlling the TV with Serial Data

These TV models are capable of being controlled by a single-wire, serial data signal. This is an LG patented technology and is being implemented by certain brands of “smart” pillow speakers.

## Pillow Speaker Interface

This connector provides an interface for patient-pendant remote control or entertainment audio and nurse call systems. All lines are isolated from the AC power line. (Optoisolators isolate the control lines, and a transformer isolates the audio.) Earth ground is provided on pin 4 (Common) in the default configuration (e.g., for Zenith/Philips pillow speakers). For negative voltage configuration (e.g., for RCA pillow speakers), +5 volts is provided on pin 4 (Common), with pin 3 (Channel Up/Data In) referenced to ground.

The following table describes the pillow speaker interface pinout (see also diagram at right).

Pin No.	Description
1	Analog external control for TV ON/OFF.
2	No connection
3	Analog external control for Channel Up or Serial Data In.
4	Common connection for control, data, and audio output.
5	Isolated Audio Output. Nominal 14 ohm source impedance with short circuit protection. Intended for a pillow speaker with a low-impedance, pad-type volume control.
6	Analog external control for Channel Down.

## Controlling the TV with Mechanical Switches

A typical analog pillow speaker with mechanical switches will momentarily connect pin 1, 3, or 6 to pin 4 (Common) to control Power ON/OFF, Channel Up, or Channel Down (see schematic at right). These pins are at +13 volts DC (when measured from pin 4) with the switches open. Typical current draw is 8 mA when a switch is closed. (This operation is identical to previous models using the 5-wire interface, except that only +7 volts DC was supplied and current draw was only 2.5 mA.)

Typical Pillow Speaker (Serial Data Control)

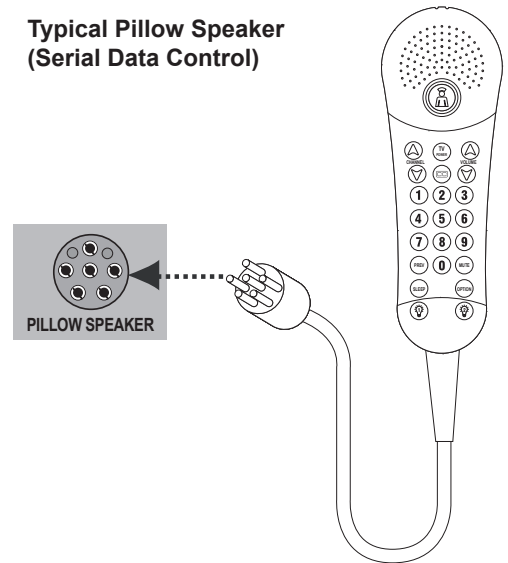

Pillow Speaker Interface Pinout

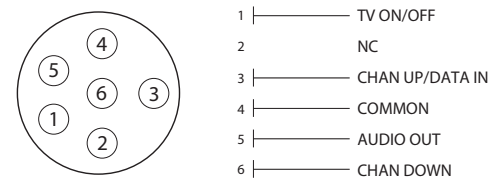

Typical Schematic for Analog Pillow Speaker

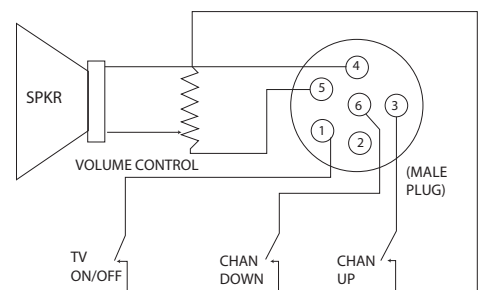

# Reference: Installer Remote Control Typical Key Functions

An LG Installer Remote (p/n: 124-213-07) is required to set up and operate the TV. The LG Installer Remote illustrated below shows typical remote control functions and is provided for reference only. This Installer Remote may vary from the Installer Remote supplied with the TV.

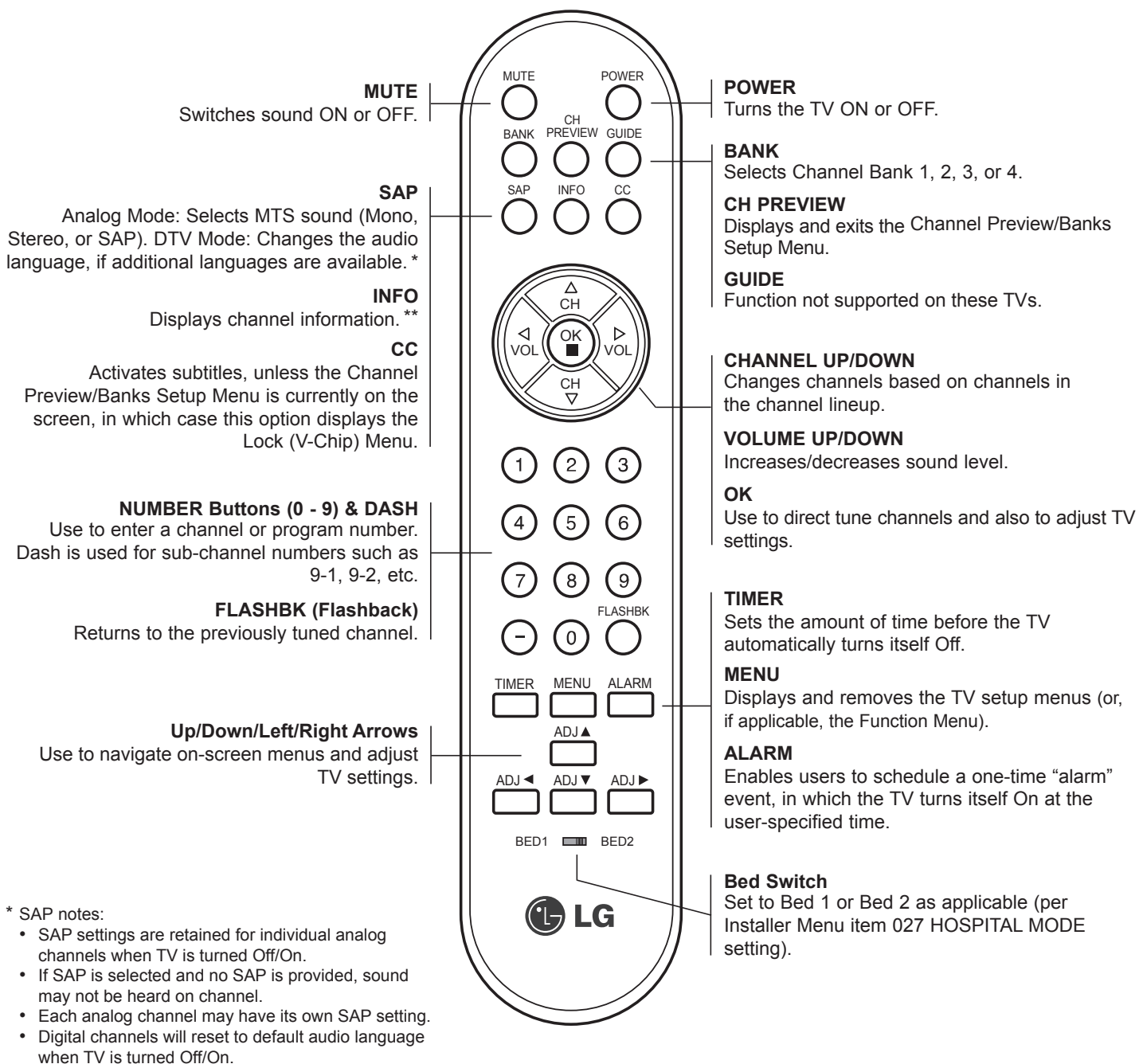

# Reference: USB Media Navigation using Pro:Centric Pillow Speaker

The Pro:Centric pillow speaker is currently the only pillow speaker that enables users to navigate and play/view USB media files (videos, music, photos, etc.). This section provides a brief overview of the Pro:Centric pillow speaker navigation tools.

**Note:** Refer to the Owner's Manual for detailed information on USB memory device requirements and the types of media supported by the 42LQ640H TVs.

1. Insert the USB memory device into the TV's USB IN port.

Once the TV detects the USB device, the Media Menu will be displayed on the TV screen. (The actual menu header shown on the TV screen will reflect the name of your USB device.)

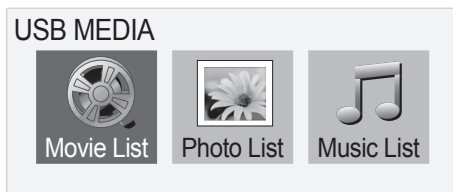

**Note:** If you press the Return button on the pillow speaker, this will exit the Media Menu. If you wish to redisplay the menu, you must physically remove and then reinsert the USB memory device. It is not possible to display the Media Menu using the pillow speaker alone.

2. Use the arrow keys on the pillow speaker to select/highlight the desired menu option, and then press **Enter**.
  3. Within each USB media directory (Movie List, Photo List, or Music List):
    - Use the arrow keys on the pillow speaker to navigate from one folder or file to another, and press **Enter** to open or play a selected folder or file.
    - If there are multiple pages of folders and/or files, use Channel Up/Down on the pillow speaker to move between the pages. At the top right corner of the display, a "Page" indicator will identify the number of pages available in the current directory.
    - Additional menu options are listed at the bottom of the display (each corresponds to a number button on the pillow speaker). These typically enable you to change directories, change the number of thumbnails shown at one time, mark files (to add to play lists), etc.
- Note:** To exit the Media Menu from any of the three USB media directories, press **0** on the pillow speaker. If you wish to redisplay the Media Menu, you must physically remove and then reinsert the USB memory device.
- In View and Play modes, you typically can use the pillow speaker to navigate to another directory level (without exiting the Media Menu).
  - To exit the directory/Media Menu entirely, either press **0** or **Return** on the pillow speaker.

Refer to the TV's interactive guide for additional information on the Media Menu and directory options.

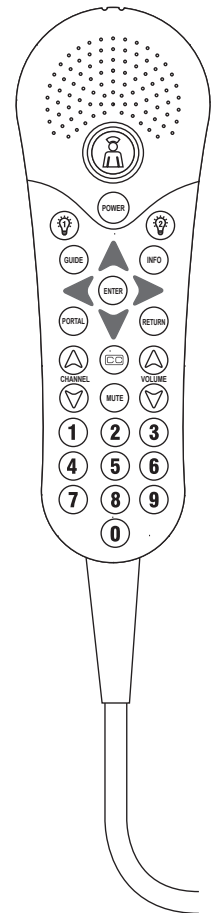

**Typical Pro:Centric  
Pillow Speaker**

## Reference: VESA Standard TV Mounts

---

### General Guidelines: Choosing a Location for Installing a VESA Standard Mount

To the right are some examples of VESA standard mounts. Since there are numerous types of stands and mounts available, only a few are shown here. Refer to the instructions provided with the TV stand that will be used to mount the TV. Be sure the style of stand selected is capable of supporting the weight of the TV and is appropriate for the application.

### Wall Mounts

If the mount will be on a wall, a typical wooden stud behind the wall board would be the preferred choice for a location to attach the wall mount. The wall mount location chosen should be appropriate for drilling holes and have available the required power source as well as antenna/cable and any other equipment leads as necessary.

### Pedestal Mounts and Stands

A sturdy surface on a desk or other similar flat table-like furniture would be the appropriate location for mounting a pedestal-style TV stand.

Most stands are designed so that the wiring is threaded through the stand itself or a loop-through style clamp so that the wiring is neatly bunched and not strung in such a way as to create a potential hazard to the user. (Some stands are portable and can be moved from one location to another.) Be sure all safety considerations are followed.

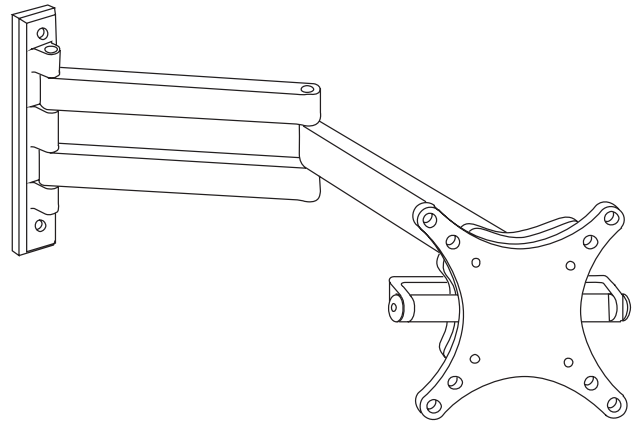

Typical Wall Stud Type Mount with Swivel Bracket

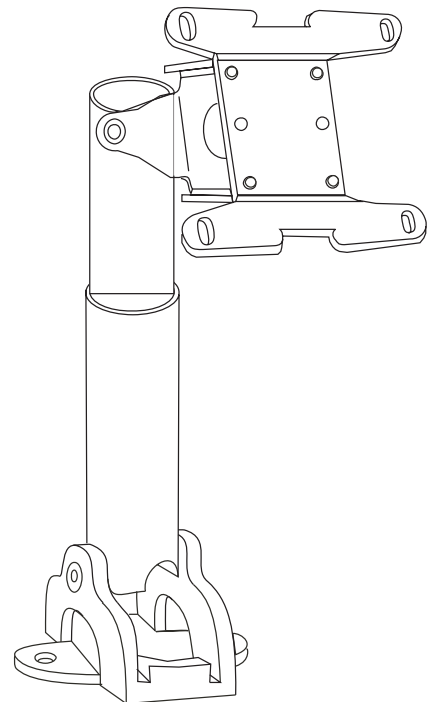

Typical Pedestal Type Mount with Swivel Bracket

## General Troubleshooting (Some Quick and Easy Tips for Resolving Problems)

### Installation

Symptom	Possible Cause(s)	Possible Solution(s)
Cannot direct enter channel number.	(TV in Pass-through Mode) Installer Menu item 028 CH. OVERRIDE is set to 0, i.e., disabled and/or Channel Access was denied in Express Script.	If the channel lineup is locked (recommended setting), only channels that are active in the TV's channel lineup can be selected. Set 028 CH. OVERRIDE to 1 to allow access for direct keypad entry to all channels.
	(TV in FTG Mode) The channel entered is not part of the FTG Channel Map.	Channel access is restricted to channels included in the FTG Channel Map. If necessary, make changes to the FTG Channel Map using the FTG File Manager.
No channels present after setup.	Auto Tuning (Channel Search) not run.	Refer to Express Script or Custom Master TV Setup procedure, as appropriate. Auto Tuning must be run in order for the channel lineup to be populated. Note for Express Script: You must select "Execute Auto Search" in the Auto Search screen to run search (see page 13). To re-activate the Express Script, set Installer Menu item 117 FACT DEFAULT to 1.

### Picture Reception and Sound

Symptom	Possible Cause(s)	Possible Solution(s)
No picture.	TV is turned OFF.	<ul style="list-style-type: none"> <li>• Turn TV ON.</li> <li>• Power failure?</li> </ul>
	Antenna/cable not connected.	Connect antenna/cable signal to TV.
	Connections incorrect.	Check connections on TV.
	MPI not connected.	If applicable, connect MPI cable to MPI device.
	Encrypted program.	Try another channel.
Normal picture, poor or no sound.	Wrong tuning band.	Adjust Installer Menu settings.
	Broadcast problem.	Try a different channel.
	Audio muted.	Press MUTE or use Volume Up key to increase sound level.
	Pillow/TV speaker not configured properly.	Check that Installer Menu items 020 FEATURE LEVEL and 027 HOSPITAL MODE are set as required. Also, if applicable, select TV Speaker in the Audio Menu.

### Erratic Operation

Symptom	Possible Cause(s)	Possible Solution(s)
Installer Menu setup.	Wrong Installer Menu settings.	Adjust Installer Menu settings as required.

### Installer Remote

Symptom	Possible Cause(s)	Possible Solution(s)
Remote doesn't work.	Remote not in TV Mode.	Use MODE key to select "TV"; puts remote into TV Mode.
	Not aimed at IR remote sensor.	Point remote at TV's IR receiver on TV.
	Remote too far from IR sensor.	Move remote closer to TV's IR receiver or darken room.
	MPI not connected.	If applicable, connect MPI cable to MPI device.
	IR path to TV's receiver obstructed.	Remove obstructions.
	Weak batteries.	Replace batteries.
	Wrong battery polarity.	Check that "+" and "-" match in battery compartment.
	Too much light in room.	Dim room light.
	Bed Switch set to wrong bed.	Set switch to Bed #2 unless TV has been configured for Bed #1 setting.
Wrong Installer Remote.	Requires compatible Installer Remote. Contact your LG dealer.	

# Troubleshooting (Cont.)

## Commercial Mode Check / FTG Operation Troubleshooting

### Commercial Mode Check

Use this flowchart to determine whether the TV is currently in Commercial Mode.

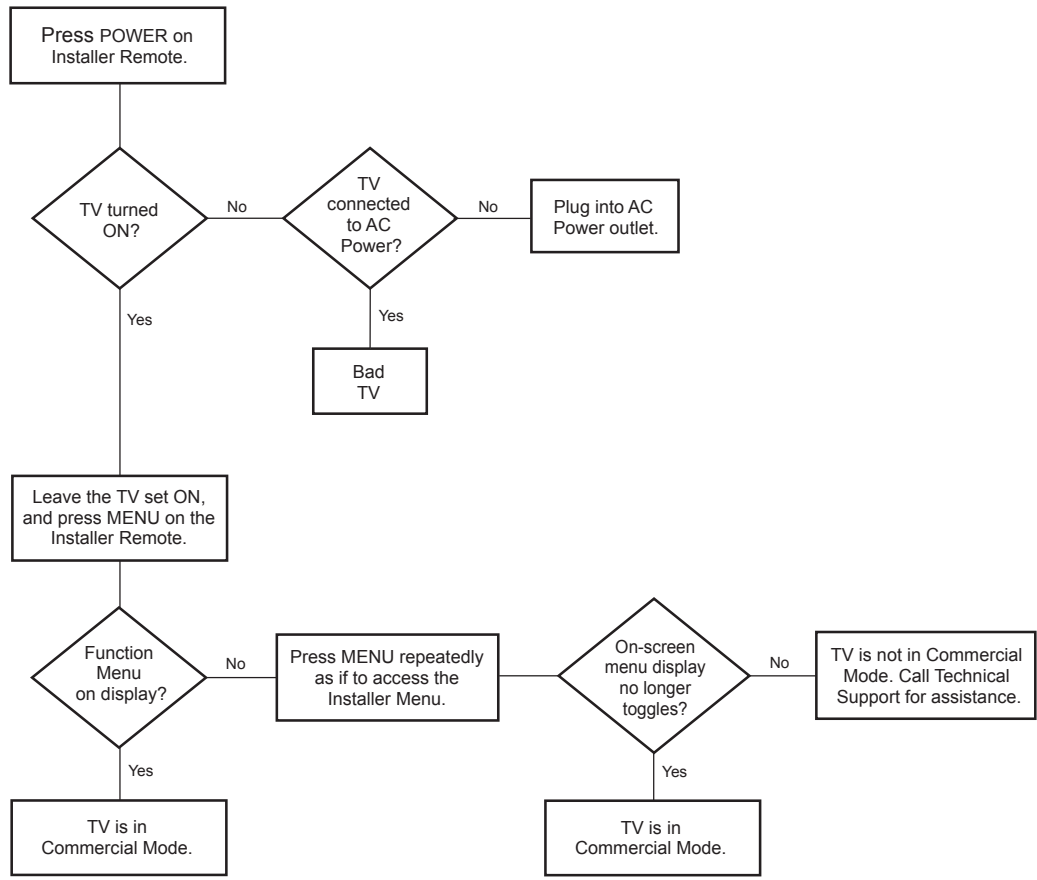

### FTG Operation Troubleshooting

The following table provides troubleshooting information for when the TV is configured for FTG Mode of operation.

Symptom	Possible Cause(s)	Solution(s)
Communication Error ("Communications Timeout")	TV not powered.	Check/connect the TV power cord.
	TV not turned ON.	TV needs to be turned ON (default FTG Mode).



## Clone Programmer Troubleshooting

### Reset Clone Programmer After Static Shock

After replacing exhausted batteries (LT2002 only), or if the clone programmer behaves strangely after a static shock:

- TLL-1100A: Turn the TLL-1100A OFF and then ON.
- LT2002: Use a paper clip or similar instrument inserted through the small hole marked RESET to activate the internal reset switch and restore normal operation.

After a reset, check the real-time clock setting. It may be necessary to reset the clone programmer clock from a TV containing the correct time.

**Note:** See also IMPORTANT CLONING INFORMATION on page 34.

### Clone Programmer

Symptom	Possible Cause(s)	Possible Solution(s)
Clone copies setup in less than 30 seconds.	Not enough time to copy entire TV setup.	TLL-1100A: Turn the TLL-1100A OFF and then ON. LT2002: Press RESET on clone programmer. Then redo Learn/Teach. (Learning usually takes about 90 seconds; Teaching usually takes 3 to 4 minutes.)
Remote does not operate clone programmer.	Wrong Installer Remote.	Only use an LG Installer Remote to operate clone programmer with TV.
Clone menu does not display on TV screen, TLL-1100A shows error message, or LT2002 LED does not blink.	MPI cable not connected.	Connect MPI cable properly, and ensure good connection.
	TV not turned ON.	TV must be turned ON for clone programmer to work.
	(LT2002 only) Weak batteries. (TLL-1100A only) No charge.	Install four (4) fresh AA high-quality alkaline batteries. Ensure the TLL-1100A is fully charged or connected to AC power.
Clone menu hard to read.	Weak signal.	Connect TV to a reliable analog channel signal source.
No time set.	Time not available.	Set time on a TV, and copy time to clone programmer.
Clone not working.	Clone programmer problem.	<ul style="list-style-type: none"> <li>• Try a different clone programmer.</li> <li>• Reset the clone programmer.</li> </ul>
Clone scans channels more than once.	Clone should only scan channels once.	Ensure TV is set up correctly, and try cloning again.

### Master and Target TVs

Symptom	Possible Cause(s)	Possible Solution(s)
Cloning did not work.	Procedure interrupted.	Wait until procedure complete message is displayed.
	Different TV models.	Cloning is only possible with identical model TVs.
	Step(s) omitted or not performed.	Refer to the applicable cloning procedure(s), and make sure all tasks were performed.
(LT2002 only) Clone time disappeared.	Batteries were removed.	Batteries must remain installed to retain time settings.
New setup not present.	Target TV not reset.	Disconnect Target TV from AC power for 15 seconds.

- After cloning operations are complete, unplug the TLL-1100A/LT2002 from the TV.
- If the TV does not display a picture (blank screen) after a few seconds, just change channels.

# Troubleshooting (Cont.)

## Channel Banks Setup Troubleshooting

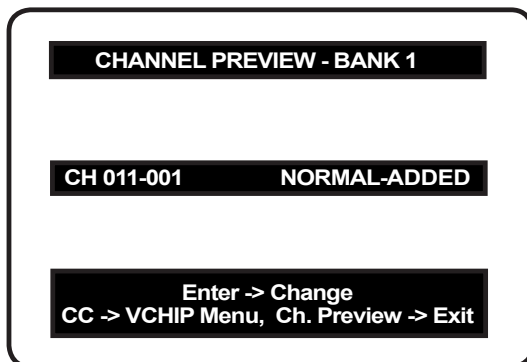

Channel Preview/Banks Setup Menu

Symptom	Possible Cause	Possible Solution
Cannot change channel status in menu.	Channel Access was denied in Express Script and/or Installer Menu item 028 CH. OVERRIDE is set to 0.	Set CH. OVERRIDE to 1 to allow access for channel status change.
Channel Preview/Banks Setup Menu does not appear.	Express Script Installer Menu Wizard/ 2-5-5 + MENU (Custom Master TV Setup) not completed/performed.	The Channel Preview/Banks Setup Menu will not be available until the TV setup is transferred to the PTC. Also, set Installer Menu item 028 CH. OVERRIDE to 1 to allow access for channel status changes.
Channel is blanked in all channel banks.	Blanking a channel in one channel bank will make it blank in all channel banks.	
Cannot tune in deleted channel on Channel Preview/Banks Setup Menu.		Select a channel bank where the deleted channel number is set to NORMAL-ADDED. Direct enter the deleted channel number. Change to the bank in which you want to activate the channel. Select "NORMAL-ADDED" on the Channel Preview/Banks Setup Menu.
"Inactive TV" message appears and then TV turns OFF.	TV is set up to display "Inactive TV" message if all channels are "NORMAL-DELETED" from Channel Bank 4.	Select another channel bank (1, 2, or 3) to return TV to normal operation.
Channel found during Auto Tuning does not tune in with Channel Up/Down.	Channel was deleted in currently selected channel bank.	If banks were set up, premium channels may only be available on another channel bank. Select the channel bank where the channel is set to NORMAL-ADDED. Or, direct enter channel number; then go to Channel Preview/Banks Setup Menu and select "NORMAL-ADDED."
When BANK on Installer Remote is pressed, TV shows Input List Menu.	Installer Menu item 027 HOSPITAL MODE is set to 0.	Set item 027 to appropriate setting for channel banks to appear with BANK key presses.

## Channel Map

Typically refers to a logical channel mapping of physical channels. This allows digital channels, like analog channels, to be tuned without requiring the dash key. Also, channels (analog or digital) can be arranged in any order that seems logical for customer tuning/viewing.

## Channel Lineup

Channels set in the TV memory, via Auto Tuning/manual editing or FTG configuration.

## Channel Banks

Enables tiered channel programming options for hospital models. Each channel bank may offer a custom channel lineup.

## Cloning

The process of capturing a Master TV Setup and transferring it to a Target TV. May be accomplished using either a USB memory device (available on select models) or clone programmer.

## Clone Programmer

An accessory device (sold separately), such as the TLL-1100A or LT2002, used to transfer the Master TV Setup from the Master TV to the Target TV.

## Commercial Mode

A mode of operation that provides a broad range of commercial TV features based on control (settings) provided by the PTC and/or an MPI control device.

## CPU

The TV's Central Processing Unit. Responsible for the presentation of video and audio from content received via the TV's tuner or Aux inputs.

## Express Script Installer Menu Wizard

Hospital model TV configuration wizard that guides the installer through the process of setting up essential hospital model features for a typical viewing application.

## E-Z Installation

Enables splash screen image and TV configuration and firmware file downloads to selected TV models from a Pro:Centric server. Managed and administered via the Pro:Centric Admin Client.

## FTG Mode

LG commercial TV mode that enables Pro:Idiom decryption and logical channel mapping. Implementation and TV operation is based on the "owner" of the FTG Logical Channel Map—the CPU or the EBL. LG's proprietary PC software is required for configuration.

## Function Menu

Available via Installer Remote "MENU" key. Indicates the TV is not in Pass-through Mode. Restricts menu options to a subset of the TV setup menus, allowing users to retain functional control, while disabling setup options.

## Installer Menu

Defines commercial TV functionality based on the parameters set.

## LG Free-To-Guest (FTG)

Refers to a particular commercial mode of operation within an LG TV. See also FTG Mode.

## Logical Channel Number

A number assigned to either a physical or virtual channel number in a Logical Channel Map.

## Major Channel Number

Typically, the RF channel number assigned to a digital video stream.

## Master TV

A TV whose Channel Map and Installer Menu and TV setup menu settings have been configured as a Master TV Setup for cloning purposes.

## Minor Channel Number

A sub-channel or program number assigned to the content embedded in the digital video stream.

## MPI

Multiple Protocol Interface. An MPI port or, for some TV models, an MPI card slot provides external control options for solution providers.

## Pass-through Mode

The TV's factory default mode of operation. TVs can be configured for stand-alone use or as Master TVs for cloning purposes, and/or TVs may be controlled externally in this mode.

## Physical Channel Number

The major channel number assigned to represent a specific 6 MHz RF band as specified by either the broadcast or CATV channel plan. See CEA (formerly EIA) or NCTA specifications for further information.

## Pillow Speaker

A wired remote control for patient in-room hospital model TVs. The pillow speaker also may be connected through a nurse call system providing two way communication between the patient and the nurses' station. TV audio can be configured to originate from the pillow speaker or the TV main speakers or both.

## Pro:Centric Application

LG content delivery and communication interface that provides interactive entertainment, weather, amenities, etc. information for end users. (Powered by Pro:Centric server.)

## Pro:Centric Admin Client

Web editor/content wizard provided for service provider and customer configuration of Pro:Centric application elements.

## Pro:Idiom

Zenith proprietary security software that unlocks access to premium content to help assure rapid, broad deployment of HDTV and other high-value digital content.

## PTC

Protocol Translator Card. The commercial controller (microprocessor) of the commercial TV.

## Target TV

A TV to which a Master TV Setup will be transferred.

## TV Setup Menus

Available via Installer Remote "MENU" key in Pass-through Mode only. Menus provide access to setup and functional features of the TV.

## USB Memory Device

A USB flash drive or USB storage device, etc. that can be used for TV configuration purposes (typically cloning or FTG Mode via CPU configuration) or for updating TV software.

## Virtual Channel Number

An alias (virtual) channel number provided in the data stream, by the broadcaster, of a digital broadcast channel to be displayed by consumer TVs in place of the physical channel number. The major number is the same as the original analog channel number and the minor number is the nth program available in that digital video stream.

# Document Revision History / Open Source Software Notice

---

## Document Revision History

Date	Description
August 2013	Revision A: New document

Product documentation is available online at: [www.LGolutions.com](http://www.LGolutions.com).

---

## Open Source Software Notice

To obtain the source code under GPL, LGPL, MPL and other open source licenses that are contained in this product, please visit <http://opensource.lge.com>. In addition to the source code, all referenced license terms, warranty disclaimers and copyright notices are available for download. LG Electronics will also provide open source code to you on CD-ROM for a charge covering the cost of performing such distribution (such as the cost of media, shipping and handling) upon e-mail request to [opensource@lge.com](mailto:opensource@lge.com). This offer is valid for three (3) years from the date on which you purchased the product.



---

For Customer Support/Service, please call:

**1-888-865-3026**

[www.LGsolutions.com](http://www.LGsolutions.com)

Pro:Idiom is a registered trademark of Zenith Electronics LLC. Pro:Centric is a registered trademark of LG Electronics Inc. All other trademarks or registered trademarks are the property of their respective owners.

## Free Manuals Download Website

<http://myh66.com>

<http://usermanuals.us>

<http://www.somanuals.com>

<http://www.4manuals.cc>

<http://www.manual-lib.com>

<http://www.404manual.com>

<http://www.luxmanual.com>

<http://aubethermostatmanual.com>

Golf course search by state

<http://golfingnear.com>

Email search by domain

<http://emailbydomain.com>

Auto manuals search

<http://auto.somanuals.com>

TV manuals search

<http://tv.somanuals.com>