



LG

Life's Good

HCS6320 CodePlus™ Series MUX/MOD Feature Card

Installation & Setup Guide Warranty

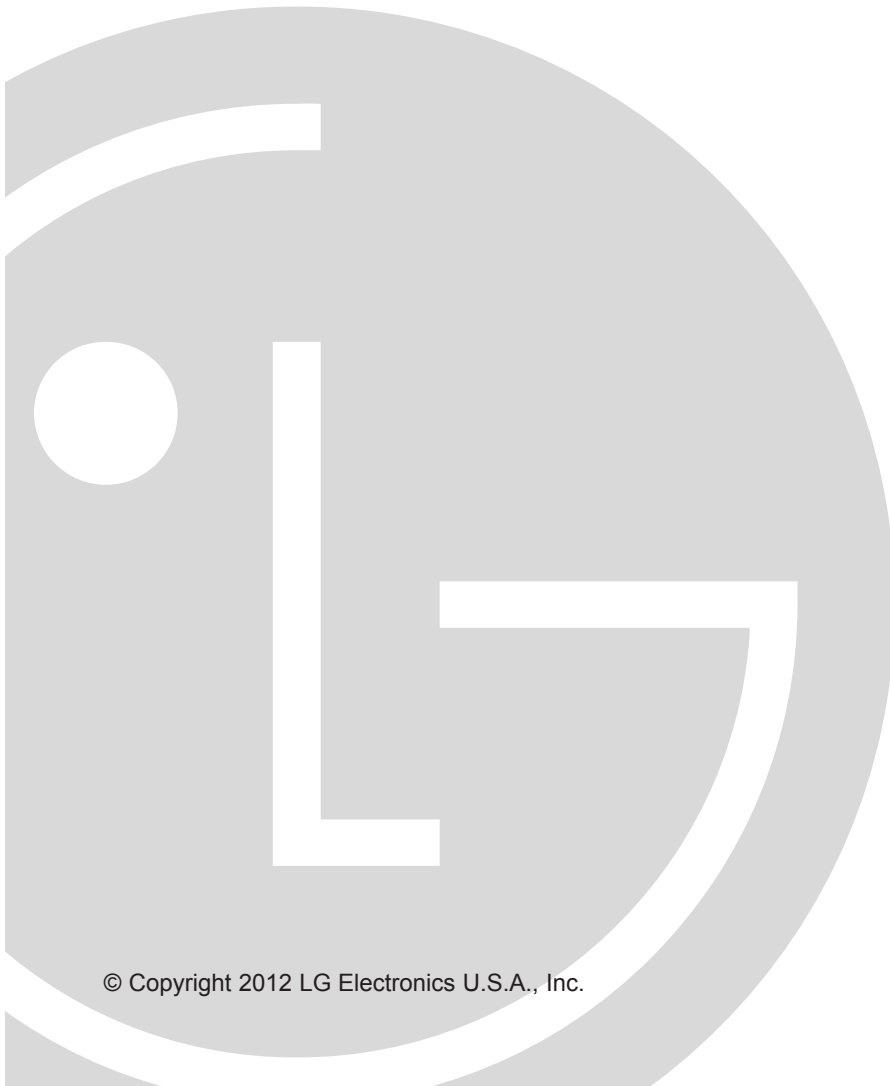

For Customer Support/Service, please call: **1-888-865-3026**

The latest product information and documentation is available online at:

www.LGolutions.com/products



WARNING
RISK OF ELECTRIC SHOCK
DO NOT OPEN



WARNING:

TO REDUCE THE RISK OF ELECTRIC SHOCK DO NOT REMOVE COVER (OR BACK). NO USER-SERVICEABLE PARTS INSIDE. REFER TO QUALIFIED SERVICE PERSONNEL. ALL CARDS MUST BE INSERTED AND REMOVED BY QUALIFIED SERVICE PERSONNEL ONLY.



The lightning flash with arrowhead symbol, within an equilateral triangle, is intended to alert the user to the presence of uninsulated "dangerous voltage" within the product's enclosure that may be of sufficient magnitude to constitute a risk of electric shock to persons.



The exclamation point within an equilateral triangle is intended to alert the user to the presence of important operating and maintenance (servicing) instructions in the literature accompanying the appliance.

WARNING:

TO PREVENT FIRE OR SHOCK HAZARDS, DO NOT EXPOSE THIS PRODUCT TO RAIN OR MOISTURE.

Apparatus shall not be exposed to dripping or splashing and no objects filled with liquids, such as vases, shall be placed on the apparatus.

L'appareil ne doit pas être exposé à des égouttements d'eau ou des éclaboussures et de plus qu'aucun objet rempli de liquide tel que des vases ne doit être placé sur l'appareil.

REGULATORY INFORMATION:

This equipment has been tested and found to comply with the limits for a Class A digital device, pursuant to Part 15 of the FCC Rules. These limits are designed to provide reasonable protection against harmful interference when the equipment is operated in a commercial environment. This equipment generates, uses and can radiate radio frequency energy and, if not installed and used in accordance with the instruction manual, may cause harmful interference to radio communications. Operation of this equipment in a residential area is likely to cause harmful interference in which case the user should be required to correct the interference at his own expense.

CAUTION:

Do not attempt to modify this product in any way without written authorization from LG Electronics U.S.A., Inc. Unauthorized modification could void the user's authority to operate this product.

NOTE TO SATELLITE DISH INSTALLER:

This reminder is provided to call your attention to Articles 810 and 820 of the 2002 National Electrical Code. Refer to Article 810, in particular 810-1 and 810-15, for required grounding of the metal dish antenna. Refer also to 810-2 which, by reference to Article 820, requires that the satellite dish coaxial cable shield be connected to the grounding system of the building as close to the point of cable entry as practical.

COMPLIANCE:

The responsible party for this product's compliance is: LG Electronics U.S.A., Inc.
2000 Millbrook Drive, Lincolnshire, IL 60069, USA • Phone: 1-847-941-8000

Marketed and Distributed in the United States by LG Electronics U.S.A., Inc.
2000 Millbrook Drive, Lincolnshire, IL 60069

IMPORTANT SAFETY INSTRUCTIONS

Important safeguards for you and your new product

THIS PRODUCT HAS BEEN MANUFACTURED AND TESTED WITH SAFETY IN MIND. IMPROPER USE, HOWEVER, CAN RESULT IN POTENTIAL ELECTRICAL SHOCK OR FIRE HAZARDS. TO AVOID DEFEATING THE SAFEGUARDS THAT HAVE BEEN BUILT INTO THIS PRODUCT, PLEASE READ AND OBSERVE THE FOLLOWING SAFETY POINTS WHEN INSTALLING AND USING THIS PRODUCT.

1. Read these instructions.

Read all the safety and operating instructions before operating the product.

2. Keep these instructions.

Retain the safety and operating instructions for future reference.

3. Heed all warnings.

Adhere to all warnings on the product and in the operating instructions.

4. Follow all instructions.

Follow all operating and use instructions.

5. Do not use this apparatus near water.

Do not use this product near water or moisture or in an area, such as a basement, that might become flooded.

6. Clean only with dry cloth.

Unplug this product before cleaning. Do not use liquid cleaners or aerosol cleaners.

7. Refer all servicing to qualified service personnel.

Servicing is required when the apparatus has been damaged in any way, liquid has been spilled or objects have fallen into the apparatus, the apparatus has been exposed to rain or moisture, does not operate normally, or has been dropped.

8. Object and Liquid Entry

Never push objects of any kind into this product through openings as they may touch dangerous voltage points or short-out parts that could result in a fire or electric shock. Never spill liquid of any kind on the product.

9. Outdoor Use



Warning: To prevent fire or shock hazards, do not expose this product to rain or moisture.

10. Wet Location

The apparatus shall not be exposed to dripping or splashing and no objects filled with liquids, such as vases, shall be placed on the apparatus.

11. Test Equipment

In some cases, LG has supplied or recommended the use of test equipment and devices for the setup and testing of the equipment. The operation and maintenance of test equipment is described in their associated instruction manuals. Please refer to these manuals for explicit instructions regarding the safe use and handling of the equipment.

12. Damage Requiring Service

Unplug this product from the wall power outlet and refer servicing to qualified service personnel under the following conditions:

- a. If liquid has been spilled, or objects have fallen into the product.
- b. If the product has been exposed to rain or water.
- c. If the product does not operate normally by following the operating instructions. Adjust only those controls that are covered by the operating instructions, as an improper adjustment of other controls may result in damage and will often require extensive work by a qualified technician to restore the product to its normal operation.

(Continued on next page)

IMPORTANT SAFETY INSTRUCTIONS

(Continued from previous page)

- d. If the product has been dropped or the cabinet has been damaged.
- e. If the product exhibits a distinct change in performance.



Caution: Refer all servicing to qualified service personnel.

13. Servicing



Caution: These servicing instructions are for use by qualified service personnel only. To reduce the risk of electrical shock, do not perform any servicing other than that described in the operating instructions unless you are qualified to do so.

14. Replacement Parts

When replacement parts are required, be sure the service technician uses replacement parts specified by the manufacturer or that have the same characteristics as the original parts. Unauthorized substitutions may result in fire, electric shock, or other hazards.

15. Safety Check

Upon completion of any service or repairs to this product, ask the service technician to perform safety checks to determine that the product is in proper operating condition.

Table of Contents

Safety Warnings	2	Set HCS6320 RF Channels	31
Important Safety Instructions.	3–4	Print the RF Channel Map	31
Table of Contents	5	Display a List of the Transcoder Cards Installed in the Chassis	32
Setup Information	6	Access Individual Transcoder Menus	32
HCS6320 Product Description	7	Perform an External Card Reset	32
Transcoder Product Description	8	Set the HCS6320 IP Address.	33
Card Description	9	Install a Pro:Idiom Key on All Transcoders	33
HCS6320 Functional Blocks	10	Reload the Pro:Idiom Key on All Transcoders	35
Installing a CodePlus Feature Card	11	Update HCS6320 and/or Transcoder Firmware	35
Satellite STB & HCS6320 Initialization & Setup Connections.	12	View MUX or Raw Bitrate Data	36
System Setup	13–14	Configure Card Number to Channel Assignments.	37
Typical System Installation.	13	Reset Password for Reload PI Key GUI Option.	38
Typical Flow Chart for HCS6320	14	Transcoder Menu Commands	39
Network and Communication Setup	15	Satellite Receiver Menu Commands	43
Configuration Options via GUI	16–29	Troubleshooting.	48
Access the CodePlus Transcoder Series Web GUI.	16	Specifications	49
Controller Menu Commands	16	Document Revision History / Notes	50
Transcoder Menu Commands	24	Open Source Software Notice.	51
Satellite STB Menu Commands.	26	Warranty	Back Cover
Configuration Options via Command Line	30–47		
Access the HCS6320 Main Menu	30		
View HCS6320 System Information.	31		

Setup Information

Check the following items before you begin HCS6320 installation and setup procedures.

HCS6320

- The HCS6320 feature card must be installed in a CodePlus™ HCS6150 card frame with one or more CodePlus series HCS7720 transcoder cards. Refer to the Installation & Setup Guide for the card frame to verify that the chassis is installed properly. **Note: All cards must be used in an LG-approved card frame for this product.**
- The HCS6320 must be installed in the card frame CONTROLLER slot. If another CodePlus feature card is currently installed in the CONTROLLER slot, the HCS6320 will replace it.
- The HCS6320 ships with a spare HCS6400 fan card. In an HCS6150R card frame, HCS6400 fan cards are pre-installed in Slots 3, 6, 7, and 10.
- For HCS6320 Service Port connections, you must use an FTDI TTL-USB cable (P/N TTL-232R-5V-AJ).

Channel Assignments

- Create a channel assignment plan for the installation site, or modify an existing plan to incorporate the RF output of the HCS6320. Ensure that up to four contiguous CATV channels are allocated for the HCS6320 RF output. The HCS6320 uses a 256-QAM modulation format, thereby occupying approximately 24 MHz of frequency spectrum.
The RF start channel is user-assigned during system setup, and the remaining channels are then automatically assigned per EIA-542 STD CATV frequency allocation standards. For example, if the RF start channel assignment is channel “2,” the three remaining channels will be “3” “4” and “5.” However, if the RF start channel assignment is “6,” the three remaining channels will be “95” “96” and “97.” Refer to EIA-542 STD CATV frequency allocation tables for further information as required.
The highest available RF channel number for the HCS6320 is “135.” Thus, to allocate all four channels available for HCS6320 RF output, the RF start channel must be set no higher than “132.”

Transcoders

- For HCS6320 MUX/MOD functionality, HCS7720 transcoder cards should be inserted in the following slots: 1, 2, 4, 5, 8, 9, 11, and 12. Refer to the Installation & Setup Guide for HCS7720 transcoders to verify that the cards are installed properly.

HCS6320 Product Description

The HCS6320 MUX/MOD controller is one of the LG CodePlus series feature cards.

Features

- Part of modular system, easily scaled for each application
- Controls up to eight CodePlus transcoder cards with a single IP connection
- Supports Pro:Idiom® encryption key maintenance
- Generates four contiguous 256-QAM cable channels, with up to two program streams multiplexed on each channel
- RF output available to connect to site's RF distribution system
- Short 3U height profile to minimize rack space usage



Transcoder Product Description

Typical HD Transcoder System Overview

The LG HCS6320 MUX/MOD feature card, when used with LG CodePlus series transcoders in a CodePlus card frame, represents an eight-program HDTV solution for commercial and institutional MATV systems (hotels, hospitals, etc.).

A typical Transcoder System with MUX/MOD functionality includes:

- An HCS6320 MUX/MOD feature card.
- One CodePlus HCS7720 HD transcoder card for each HD program offered in the facility's MATV system—up to eight programs supported.
- A CodePlus series card frame specified for both the HCS6320 and the transcoder card(s).
- DISH Network® service. *
- A DISH Network ViP® 222k satellite STB for each transcoder card. *
- A 19-inch rack for mounting. *
- Miscellaneous cables and installation hardware (see also setup information on page 6). *

The integrated elements of the Transcoder System:

- Receive up to eight HD programs from DISH Network.
- Transcode the received digital video and audio streams to MPEG-2 transport streams.
- Encrypt the transcoded digital data streams with Pro:Idiom content protection.
- Multiplex the encrypted streams into four streams of two programs each.
- Modulate and upconvert the multiplexed streams in four contiguous RF channels.

A Pro:Idiom compatible television with a QAM tuner is required to view premium HD content. A proper session ID must be set at the TV in order for Pro:Idiom decryption to be enabled. LG's Pay-Per-View (PPV) partners can set up this session through their interface. LG's Free-To-Guest (FTG) Mode of operation also enables Pro:Idiom decryption.

Note: The RF output from the HCS6320 can be combined with other channels in the site's distribution grid.

* Purchased separately.

Note: Design and specifications subject to change without prior notice.

HCS6320 Card Description

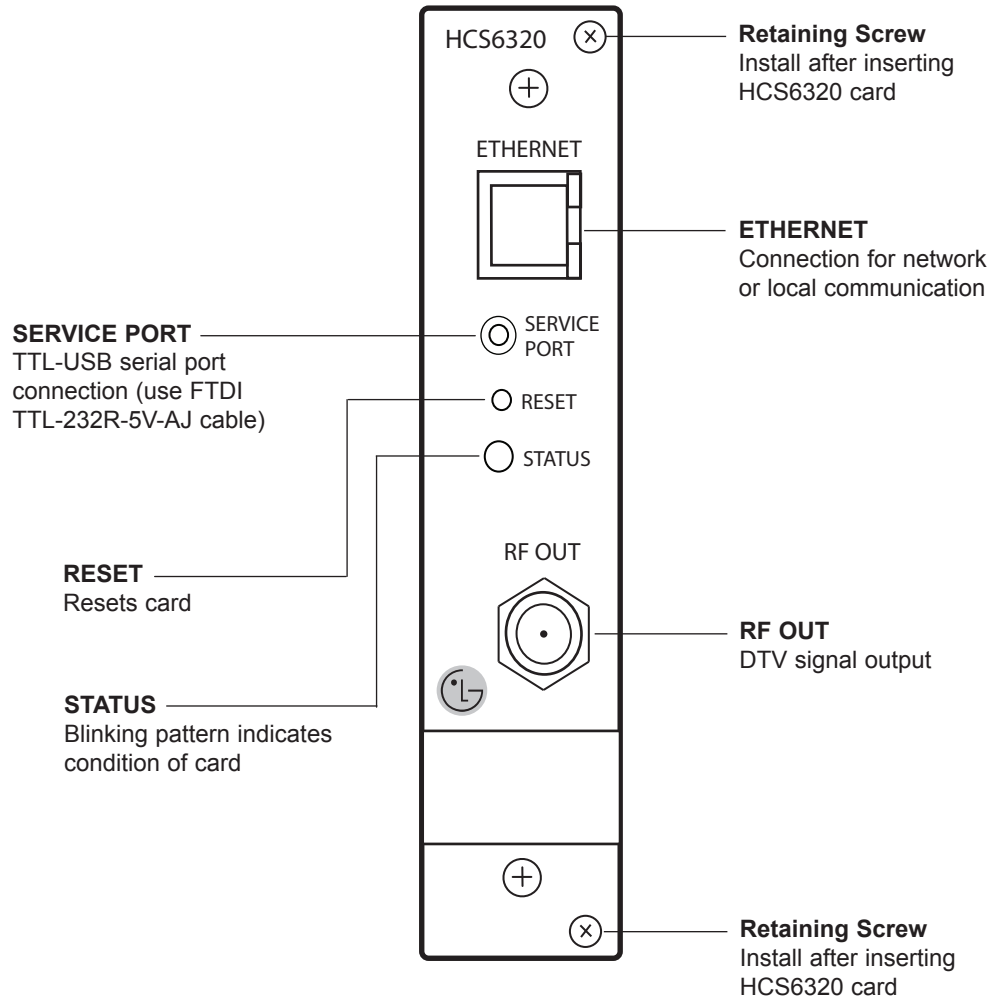

HCS6320 Functional Blocks

The HCS6320 consists of four main functional blocks:

- MUX: Four parallel multiplexers, each of which can combine up to two encrypted transport streams into a single 38 Mbps transport stream. The transport streams from the transcoder cards are supplied to the HCS6320 through the internal backplane circuit board of the card frame.
- MOD: Four parallel 256-QAM modulators that take the MUX output streams and produce four modulated outputs.
- Upconverter: This block takes the modulated output streams from the MOD block and places them on up to four contiguous cable RF channels. The output of this block is a combined RF signal four channels wide.
- Controller: Provides the PC interface for HCS6320 setup and configuration.

HCS6320 default settings assign the inputs of each channel MUX to specific slots in the CodePlus card frame, where the RF start channel is assigned to card frame Slots 1 & 2, the second channel is assigned to card frame Slots 4 & 5, etc.

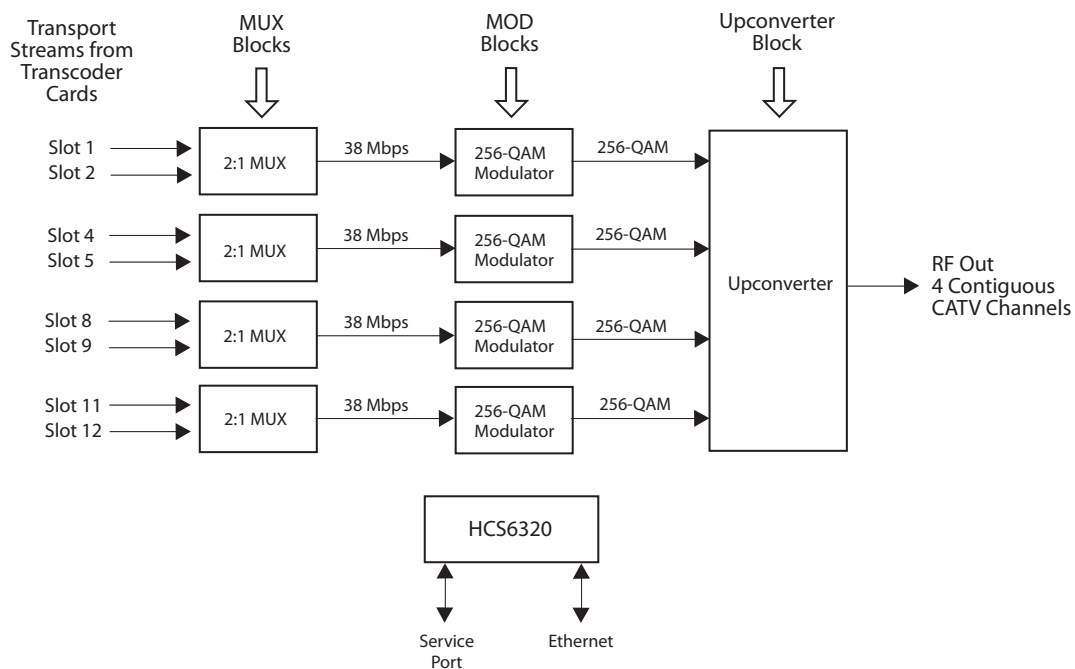

Installing a CodePlus Feature Card

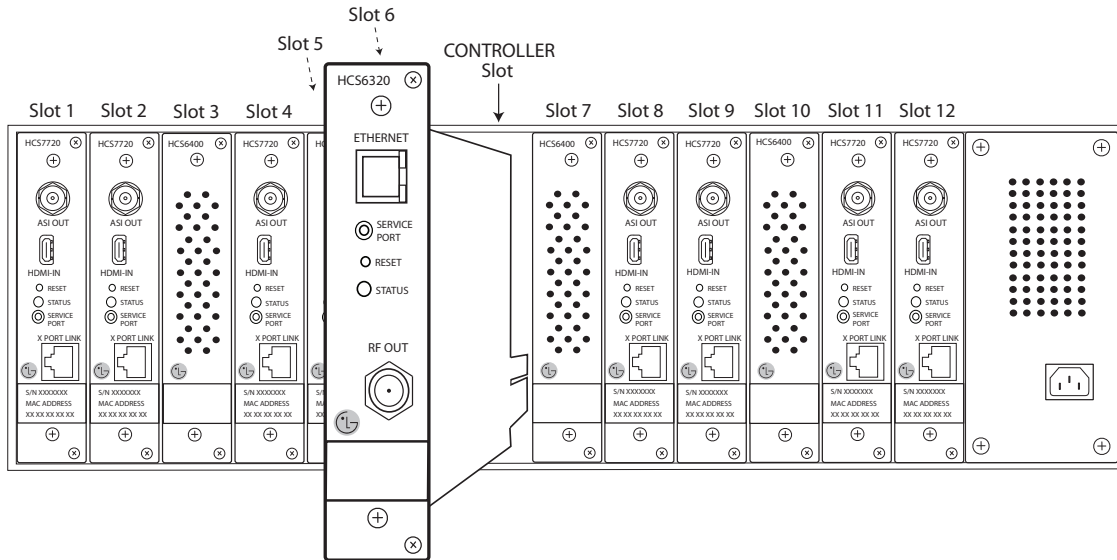

⚠ Note: The CodePlus series products are NOT designed to be hot-swappable!!! Power must be removed to the card frame before any CodePlus transcoder cards are inserted or removed.

⚠ Note: All cards used in the card frame must be inserted and removed by qualified service personnel only.

⚠ Note: Use extreme care when handling an HCS6320 card. Always observe proper precautions with respect to static electricity and mechanical shock. When not installed in a card frame, return the HCS6320 card to the anti-static bag in which it was shipped.

⚠ Note: The card slots in the card frame are NOT all identical!!! An HCS6320 card can only be installed in the CONTROLLER slot. The connector arrangement of Slots 1 to 6 and 7 to 12 is incompatible with the HCS6320.

⚠ Note: When installing cards, remove blank cover plates and insert new cards as applicable. For ports that will not be used, leave the blank cover plates in place for proper ventilation and FCC and safety agency compliance.

Follow the procedure below to install the CodePlus feature card.

1. Unpack the HCS6320 unit.
2. Remove the AC power cord for the card frame from the power outlet.
3. Prepare the CONTROLLER slot in the card frame by removing either the blank cover plate or the CodePlus card currently in the slot.
4. *Without using force*, slide the HCS6320 card into the CONTROLLER slot, and ensure that it is fully inserted.
5. Engage and tighten the top and bottom thumbscrews of the card securely. Note that the thumbscrews should only be finger tight; overtightening may damage the assembly.
6. Refer to the diagram on page 12 for cable connections, and complete the HCS6320 system installation procedure on page 13.

Satellite STB & HCS6320 Initialization & Setup Connections

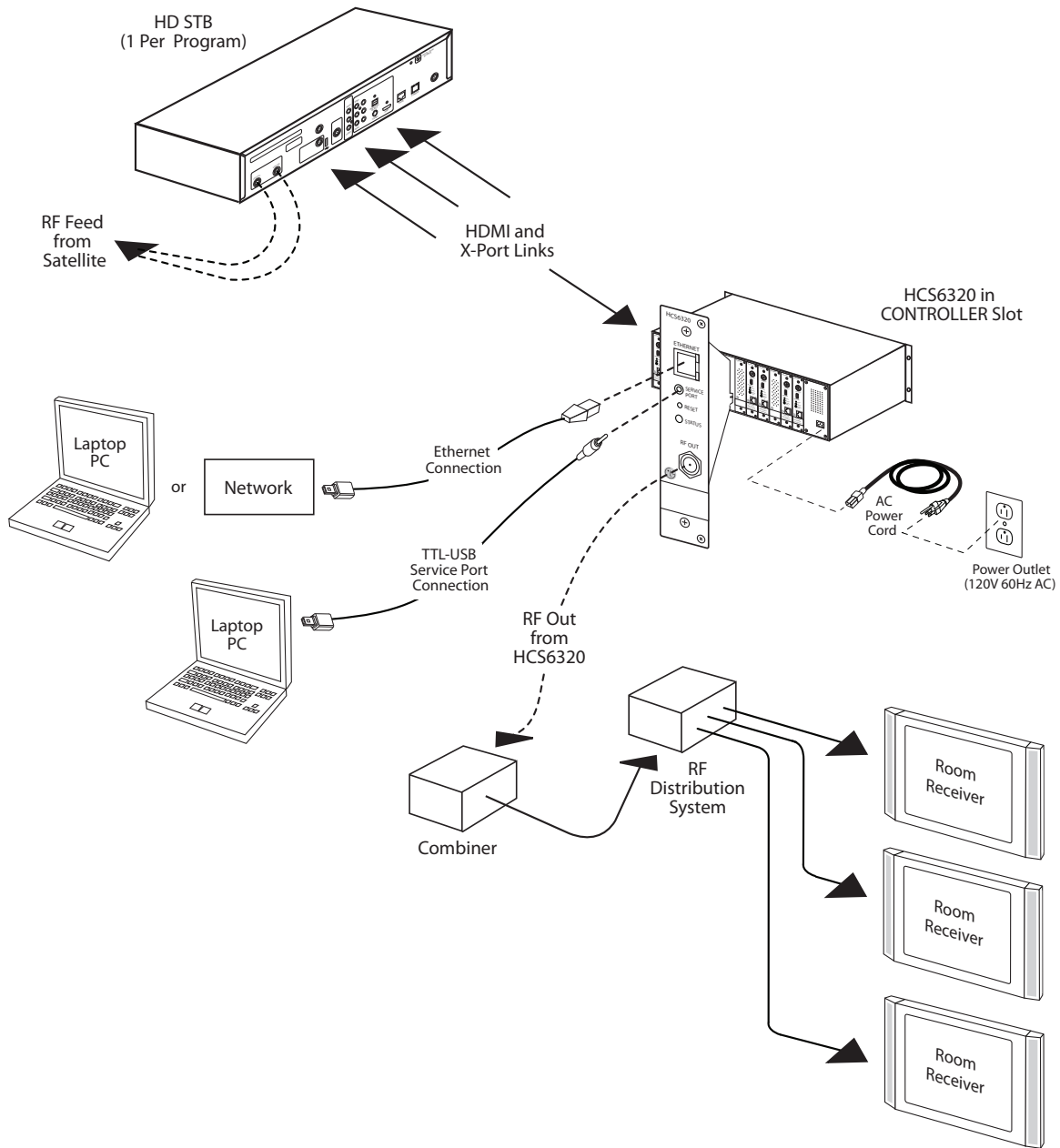

Typical HCS6320 System Installation

(see also Typical Setup Flow Chart on the following page)

1. Verify that the individual transcoder cards are installed and set up as described in the appropriate Installation & Setup Guide.
2. Plug in the power to the CodePlus card frame containing the newly installed feature card and transcoder card(s).

The green STATUS LED on the HCS6320 front panel will blink approximately once every second while the HCS6320 card boots up. The boot-up process for an HCS6320 may take up to one minute. When the boot-up is complete, the STATUS LED will be lit continuously.
3. Once the STATUS LED is lit continuously (no longer blinking), use the FTDI TTL-232R-5V-AJ cable to connect a PC to the HCS6320 Service Port.
4. Using HyperTerminal or an equivalent terminal emulation program on the PC, configure the serial port as follows: Bits per second/ baud = 115200; Data bits = 8; Parity = None; Stop bits = 1; Flow Control = None. Then, initiate communication with the HCS6320.

Once the connection is established, press **Enter** to refresh the screen and display the HCS6320 Main Menu.
5. Use the HCS6320 Main Menu “rf” command, as described on page 31, to set the RF start channel for the HCS6320.
6. (Optional) For remote management purposes, you can connect the HCS6320 to an IP network and then use the Service Port connection to set the HCS6320 IP address:
 - a) Connect an Ethernet cable from the institution’s IP network to the HCS6320 ETHERNET port.
 - b) Use the HCS6320 Main Menu “setip” command, as described on page 33, to set the HCS6320 IP address.
7. Connect the HCS6320 RF OUT to the RF distribution system.
8. Check one or more room receivers to make sure all content is properly mapped and available.

System Setup (Cont.)

Typical Setup Flow Chart for HCS6320

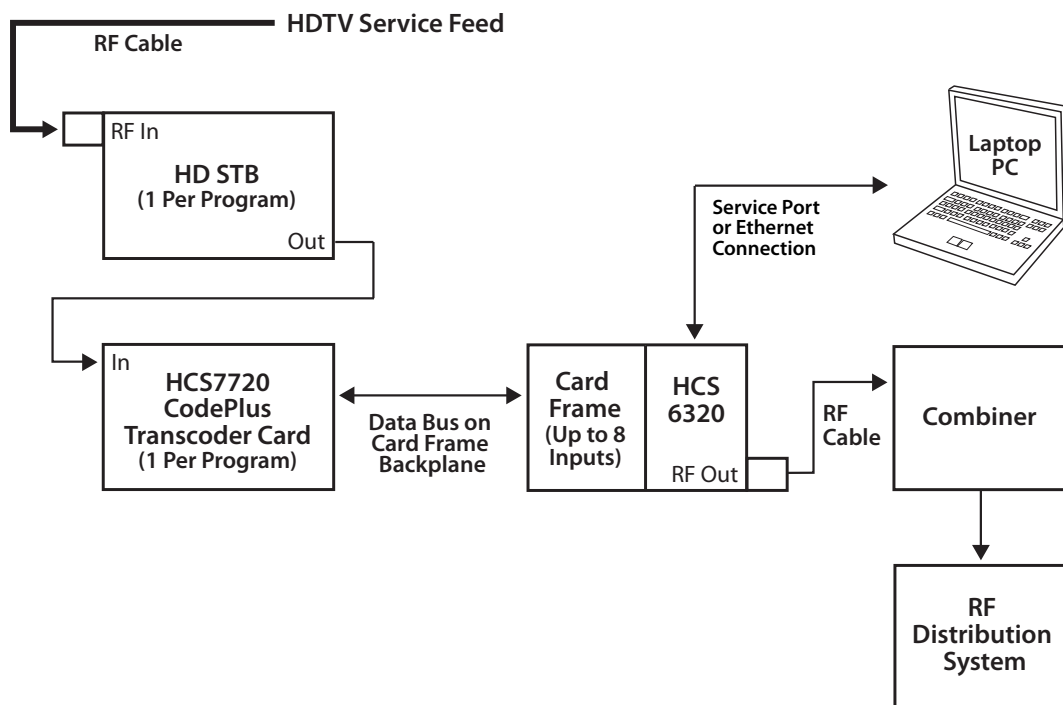

Network and Communication Setup

The HCS6320 feature card and the transcoder cards installed in the CodePlus card frame contain several internal registers for different configuration options. This document describes configuration options via a network or direct connection to the HCS6320.

Refer to the Installation & Setup Guide for HCS7720 transcoder cards for information on performing configuration via a direct connection to the HCS7720 Service Port.



Note: Before you proceed with any additional configuration, the system (including the feature card, transcoders, and satellite STBs) should be installed and operating as described in the Installation and Setup sections in this document.

There are three options for communicating with the HCS6320.

- When the HCS6320 is connected to an IP network, you can use a standard Internet browser to communicate with the HCS6320 via a graphical user interface (GUI).
- When the HCS6320 is connected to an IP network, you can also use Telnet to communicate with the HCS6320 via a command line interface.
- To establish a direct connection to the HCS6320, connect a PC to the serial port on the HCS6320 using the FTDI TTL-USB cable (P/N TTL-232R-5V-AJ). Plug the USB end of the cable into an open USB port on your PC. If necessary, install the device driver. Plug the other end of the cable into the Service Port jack on the HCS6320 front panel.

Using HyperTerminal or an equivalent terminal emulation program on the PC, configure the serial port as follows:

- Bits per second/ baud = 115200
- Data bits = 8
- Parity = None
- Stop bits = 1
- Flow Control = None

Configuration options via web GUI are described on pages 16 to 29; configuration options via command line are described on pages 30 to 47. For security and control purposes, some options available from the command line menus are not available from the GUI.

Note: The default network setting for the HCS6320 is DHCP, in which case the server assigns an IP address to the HCS6320. If necessary, consult the network administrator to obtain the IP address that has been assigned to the HCS6320.

Note: If you want to connect the PC directly to the HCS6320 ETHERNET port using an Ethernet crossover cable, in order to establish communication you must first connect the PC to the HCS6320 Service Port, and set the HCS6320's IP address (see "Set the HCS6320 IP Address" on page 33). The HCS6320's IP address must be on the same subnet as the PC's IP address.

Configuration Options via GUI



Caution: Do NOT initiate simultaneous menu sessions to run commands. Doing so will interfere with active processes and may corrupt the system configuration and/or cause the HCS6320 card to cease normal operation.

Access the CodePlus Transcoder Series Web GUI

Note: The HCS6320 must be connected to an IP network for GUI access. See “Network and Communication Setup” on page 15 for further information.

1. Launch a web browser, and type **http://ipaddress** in the browser’s address bar, where *ipaddress* is the IP address of the HCS6320 card. Then, press **Enter**.

The CodePlus™ Transcoder Series Configuration Homepage provides access to Controller (HCS6320), Transcoder, and Satellite STB menus:

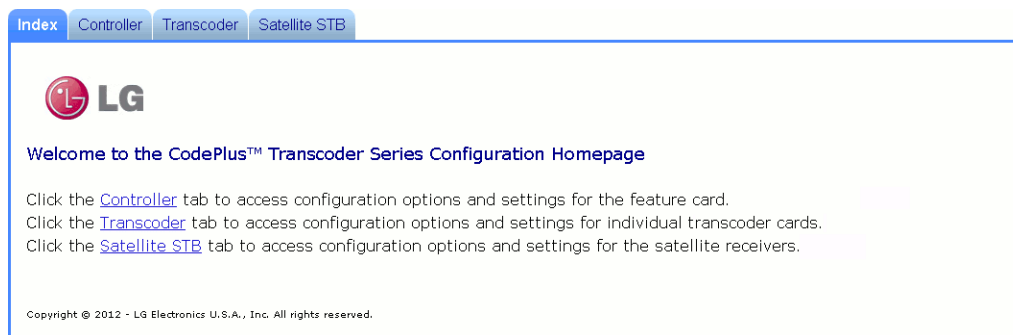

2. Click the appropriate link or tab to access the desired configuration options/settings.

The following sections provide detailed information on the configuration settings and commands. Note that menu options may vary from the examples shown in this document, depending on the HCS6320 firmware version.

When you have completed your activities in the web GUI, you can simply close your browser.

Controller Menu Commands

The following subsections describe how to access and use the Controller Menu commands.

Access the Controller Menu

1. Access the CodePlus Transcoder Series web GUI as described above.
2. With the Homepage on display, click on the **Controller** menu tab or link.

The Controller Menu (see example on following page) enables you to view and modify HCS6320 configuration settings and also enables you to view transcoder data. In addition, the Controller Menu enables you to update HCS6320 and transcoder card firmware.

Configuration Options via GUI (Cont.)

Example: Controller Menu

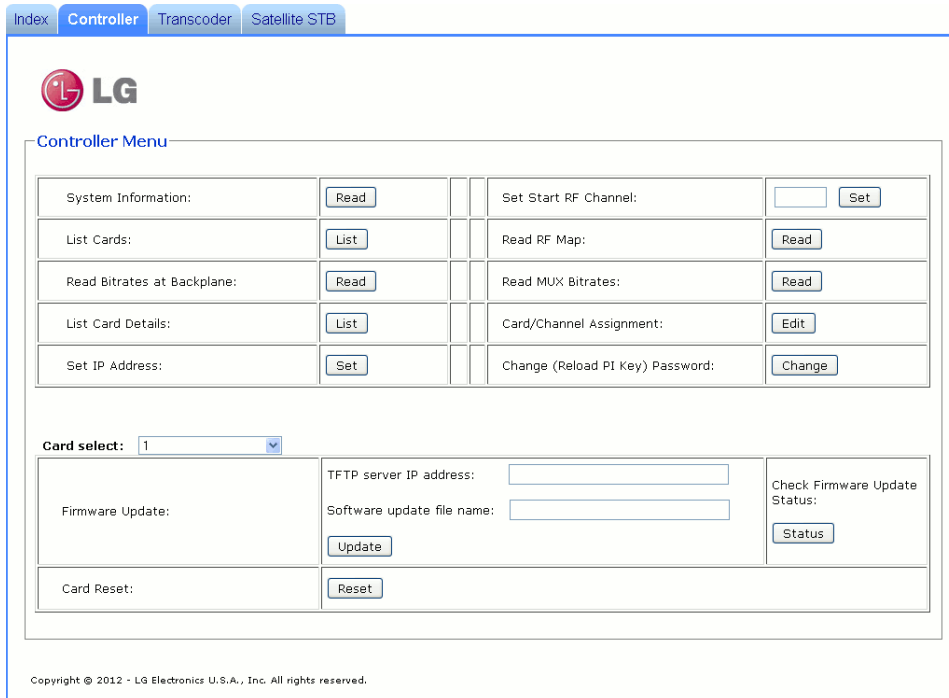

Index Controller Transcoder Satellite STB

LG

Controller Menu

System Information:	Read		Set Start RF Channel:	<input type="text"/>	Set
List Cards:	List		Read RF Map:	Read	
Read Bitrates at Backplane:	Read		Read MUX Bitrates:	Read	
List Card Details:	List		Card/Channel Assignment:	Edit	
Set IP Address:	Set		Change (Reload PI Key) Password:	Change	

Card select: 1

Firmware Update:	TFTP server IP address: <input type="text"/>	Check Firmware Update Status: <input type="button" value="Status"/>
	Software update file name: <input type="text"/>	<input type="button" value="Update"/>
Card Reset:	<input type="button" value="Reset"/>	

Copyright © 2012 - LG Electronics U.S.A., Inc. All rights reserved.

View HCS6320 System Information

With the Controller Menu on display, click on the **Read** button at the right of the System Information field to display HCS6320 hardware and software information.

The System Information display contains important information about the HCS6320, including the unit hardware ID (firmware version), software versions, IP address, MAC address, and serial number, for example:

System Information

```
Model:                HCS6320
Hardware ID:          6320-v1.0-2011-1101
OS version:           HCS6320-1102-2011-1031
Application version:  2.5
IP address:           10.166.60.81
MAC address:          00:0C:63:3C:00:02
Serial#:              901-12420020
```

It is recommended that you record this information for future reference. If you find it necessary to call customer service or engineering support, please have this information available.

Configuration Options via GUI (Cont.)

Set HCS6320 RF Channels

With the Controller Menu on display, type the appropriate RF start channel number in the data entry field at the right of the Set Start RF Channel field. Then, click on the **Set** button.

The remaining channels will be automatically assigned per EIA-542 STD CATV frequency allocation standards, and the system will display the channel assignments for the card slots (see example under “Read the RF Channel Map” below).

Read the RF Channel Map

With the Controller Menu on display, click on the **Read** button at the right of the Read RF Map field to display the current channel assignments, for example:

Channel Map:

```
-----+-----  
Cards   | RF Channel  
-----+-----  
  1,  2 |      2  
  4,  5 |      3  
  8,  9 |      4  
 11, 12 |      5  
-----+-----
```

Display a List of Transcoder Cards Installed in the Chassis

There are two options for listing transcoder cards installed in the chassis: one (List Cards) identifies the type of transcoder cards and the cards’ serial numbers, while the other (List Card Details) identifies the type of transcoder cards, along with the cards’ hardware and software version information. See sample displays below and on the following page.

With the Controller Menu on display, either click on the **List** button at the right of the List Cards field, or click on the **List** button at the right of the List Card Details field.

Example: List Cards Display

Available cards:

```
Card 1: [HCS7720] [001-12080017]  
Card 2: [HCS7720] [001-12080018]  
Card 3: [-]  
Card 4: [HCS7720] [001-12080019]  
Card 5: [HCS7720] [001-12080020]  
Card 6: [-]  
Card 7: [-]  
Card 8: [HCS7720] [001-12080021]  
Card 9: [HCS7720] [001-12020006]  
Card 10: [-]  
Card 11: [HCS7720] [001-12080023]  
Card 12: [HCS7720] [001-12080024]
```

Configuration Options via GUI (Cont.)

Example: List Card Details Display

card#	card type	hardware id	os version	app	[enc]
1:	[HCS7720]	[7720-v1.1-2011-1026]	[HCS7720-943-2011-1025]	[2.5]	[1.2]
2:	[HCS7720]	[7720-v1.1-2011-1026]	[HCS7720-943-2011-1025]	[2.5]	[1.2]
3:	[-]				
4:	[HCS7720]	[7720-v1.1-2011-1026]	[HCS7720-943-2011-1025]	[2.5]	[1.2]
5:	[HCS7720]	[7720-v1.1-2011-1026]	[HCS7720-943-2011-1025]	[2.5]	[1.2]
6:	[-]				
7:	[-]				
8:	[HCS7720]	[7720-v1.1-2011-1026]	[HCS7720-943-2011-1025]	[2.5]	[1.2]
9:	[HCS7720]	[7720-v1.1-2011-1026]	[HCS7720-943-2011-1025]	[2.5]	[1.2]
10:	[-]				
11:	[HCS7720]	[7720-v1.1-2011-1026]	[HCS7720-943-2011-1025]	[2.5]	[1.2]
12:	[HCS7720]	[7720-v1.1-2011-1026]	[HCS7720-943-2011-1025]	[2.5]	[1.2]

View MUX or Raw Bitrate Data

Bitrate data is useful for system monitoring and troubleshooting purposes. Bitrates at the backplane (raw bitrates), are measured at the input pins prior to data processing. MUX bitrates provide information on MUX data processing, i.e., the amount of data filtering in and out of the MUX. See sample displays below and on the following page.

With the Controller Menu on display, either:

- Click on the **Read** button at the right of the Read Bitrates at Backplane field to view raw bitrate data for each installed transcoder card.
- Click on the **Read** button at the right of the Read MUX Bitrates field to view MUX bitrate data for each installed transcoder card.

Example: Bitrates at Backplane Connector (Raw Bitrates) Display

Slot #1	Raw bitrate data 14.228 Mbit/s total 19.396 Mbit/s	
Slot #2	Raw bitrate data 12.537 Mbit/s total 19.390 Mbit/s	
Slot #3	Raw bitrate data 0 total 0	
Slot #4	Raw bitrate data 17.049 Mbit/s total 19.390 Mbit/s	Total number of data bits that are not null packets
Slot #5	Raw bitrate data 15.503 Mbit/s total 19.396 Mbit/s	
Slot #6	Raw bitrate data 0 total 0	
Slot #7	Raw bitrate data 0 total 0	
Slot #8	Raw bitrate data 13.536 Mbit/s total 19.390 Mbit/s	
Slot #9	Raw bitrate data 13.957 Mbit/s total 19.396 Mbit/s	
Slot #10	Raw bitrate data 0 total 0	
Slot #11	Raw bitrate data 7.520 Mbit/s total 19.396 Mbit/s	
Slot #12	Raw bitrate data 18.620 Mbit/s total 19.396 Mbit/s	Total number of data bits in the transport stream

Configuration Options via GUI (Cont.)

Example: MUX Bitrates Display

Slot #1 Bitrate 19.035 Mbit/s (unfiltered 19.065 Mbit/s)
 Slot #2 Bitrate 12.658 Mbit/s (unfiltered 12.694 Mbit/s)
 Mux #1 Output Bitrate 31.746 Mbit/s

Slot #4 Bitrate 19.335 Mbit/s (unfiltered 19.359 Mbit/s)
 Slot #5 Bitrate 14.679 Mbit/s (unfiltered 14.715 Mbit/s)
 Mux #2 Output Bitrate 34.051 Mbit/s

Slot #8 Bitrate 13.013 Mbit/s (unfiltered 13.049 Mbit/s)
 Slot #9 Bitrate 13.903 Mbit/s (unfiltered 13.933 Mbit/s)
 Mux #3 Output Bitrate 26.970 Mbit/s

Slot #11 Bitrate 6.269 Mbit/s (unfiltered 6.305 Mbit/s)
 Slot #12 Bitrate 18.583 Mbit/s (unfiltered 18.614 Mbit/s)
 Mux #4 Output Bitrate 24.900 Mbit/s

Per Mux Total Output Bitrate 38.815 Mbit/s

Data currently in use by the MUX

Unprocessed data

Data currently output by the MUX

Total amount of data (including null packets) output per RF channel

Configure Card Number/Channel Assignments

This option enables you to reconfigure the card number/channel assignments.

1. With the Controller Menu on display, click on the **Edit** button at the right of the Card/Channel Assignment field.
2. In the Configure Card Number to Channel Assignment window, click on the down arrow at the right each Card Number field you wish to reassign, and select from the drop-down list of options the appropriate card number or N/C (no connection) for the RF channel listed in the Channel column.

Configure Card Number to Channel Assignment

Channel	Card Number
54-1	1
54-2	2
55-1	4
55-2	5
56-1	8
56-2	9
57-1	11
57-2	12

Save Configuration

3. When you have completed the assignments, click on the **Save Configuration** button below the Assignment table.

(Continued on next page)

Configuration Options via GUI (Cont.)

(Continued from previous page)

The system will display the New Channel Map, for example:

New Channel Map:

RF	Card Slot
54-1	1
54-2	2
55-1	11
55-2	12
56-1	8
56-2	9
57-1	4
57-2	5

Set the HCS6320 IP Address

1. With the Controller Menu on display, click on the **Set** button at the right of the Set IP Address field.
2. In the Set IP Address window:
 - Select the DHCP Mode setting—Enable or Disable—by clicking the radio button at the left of the appropriate option.
 - If you wish to specify static IP information (i.e., DHCP will be disabled), type the appropriate data in the IP Address, Subnet Mask, and Default Gateway fields.

LG

Set IP Address

DHCP mode: Enable Disable

IP address:

Subnet mask:

Default gateway:

(Continued on next page)

Configuration Options via GUI (Cont.)

(Continued from previous page)

3. Click on the **Submit** button when you are ready to continue.

The system will display an overview of the settings and then prompt you to reset the HCS6320, for example:

```
DHCP mode selected
```

```
Reset the Controller card to activate new IP settings.
```

or

```
Static IP mode selected
```

```
IP address:           xxx.xxx.xxx.xxx
```

```
Subnet mask:         xxx.xxx.xxx.xxx
```

```
Default gateway:    xxx.xxx.xxx.xxx
```

```
Reset the Controller card to activate new IP settings.
```

4. If you are ready to reset the HCS6320 immediately, click on the **Reset** button located below the results text.

Note: If you intend to modify additional configuration settings during the current session, you may wait until all changes are complete before you reset the HCS6320 (see “Perform an External Card Reset” on page 23 for further information); however, note that IP settings will not take effect until the HCS6320 resets.

Change the (Reload Pro:Idiom Key) Password

This option enables you to change the password required to reload the Pro:Idiom key on selected transcoders. The default password is “service”.

1. With the Controller Menu on display, click on the **Change** button at the right of the Change (Reload P:I Key) Password field.

The system will initiate a series of password prompts in pop-up windows.

2. At the `Enter the Current Password` prompt, type the current password and click **OK**.
3. At the `Enter New Password` prompt, type the new password and click **OK**.
4. At the `Confirm New Password` prompt, retype the new password and click **OK**.

When the password is successfully changed, the system will display confirmation, for example:

```
Password changed.
```

Configuration Options via GUI (Cont.)

Update HCS6320 and/or Transcoder Firmware via TFTP

If you are not sure of the current firmware version, view and record the System Information for the HCS6320 and/or the transcoder card(s) before you initiate the firmware update. See “View HCS6320 System Information” on page 17 and/or “View Hardware Information for a Selected Transcoder” on page 24, as necessary.

The firmware update requires that you set up a TFTP server on the same IP network as the HCS6320. Consult the network administrator, as necessary, for further information.



Caution: Do NOT initiate simultaneous menu sessions while a firmware update is in progress. Doing so will interfere with the active processes and may corrupt the system configuration and/or cause the HCS6320 card to cease normal operation.

1. Make sure the firmware update configuration (.cfg) and package (.pkg) files are available on the same machine as the TFTP server. Then, set up the TFTP server, and point to the directory in which the firmware update files are located.
2. With the Controller Menu on display, select the card or cards to which to download firmware: Click on the down arrow at the right of the Card Select field, and select the appropriate option from the drop-down list. You can update firmware on a single transcoder (select the appropriate card number), the Controller (HCS6320), or all transcoder cards.
3. Type the IP address for the TFTP server in the TFTP Server IP Address field and the name of the configuration file in the format “*filename.cfg*” in the Software Update File Name field. Then, click **Update**. This will initiate the installation of both the configuration and package files.

Note: If you wish to check the status of the firmware update while in progress, click on the **Status** button at the right of the Update field.

4. When the firmware update is successfully completed, initiate a reset of ALL the cards that received the firmware update (see “Perform an External Card Reset” below).

Perform an External Card Reset

This option enables you to reset a single transcoder, the Controller (HCS6320), or all transcoder cards.

1. With the Controller Menu on display, select the card or cards to reset: Click on the down arrow at the right of the Card Select field, and select the appropriate option from the drop-down list.
2. Click on the **Reset** button at the right of the Card Reset field.

The system will display confirmation before initiating the reset of the selected card(s), for example:

```
Success. Reset command sent to card 2.
```

Configuration Options via GUI (Cont.)

Transcoder Menu Commands

The following subsections describe how to access and use the Transcoder Menu commands.

Access the Transcoder Menu

1. Access the CodePlus Transcoder Series web GUI as described on page 16.
2. With the Homepage on display, click on the **Transcoder** menu tab or link.

The Transcoder Menu (see example below) enables you to view and modify selected transcoder card configuration settings.

Example: Transcoder Menu



Index	Controller	Transcoder	Satellite STB
 Transcoder Menu			
Card select: 1			
Read Hardware ID:	Read		
Read Software Version:	Read		
Read MUX Bitrates:	Read		
Read PI Key Checksum:	Read		
Reload PI Key:	Reload		
<small>Copyright © 2012 - LG Electronics U.S.A., Inc. All rights reserved.</small>			

View Hardware Information for a Selected Transcoder

1. With the Transcoder Menu on display, click on the down arrow at the right of the Card Select field, and select the appropriate transcoder card from the drop-down list of options.
2. Click on the **Read** button at the right of the Read Hardware ID field to view the selected card's hardware ID (firmware version), for example:

Card 1:
Card HWID# is: 7720-v1.1-2011-1026

Configuration Options via GUI (Cont.)

View Software Information for a Selected Transcoder

1. With the Transcoder Menu on display, click on the down arrow at the right of the Card Select field, and select the appropriate transcoder card from the drop-down list of options.
2. Click on the **Read** button at the right of the Read Software Version field to view the selected card's software versions, for example:

```
Card 1:  
OS version:      HCS7720-943-2011-1025  
Encoder version: 1.2  
Application version: 2.5
```

View MUX Bitrate Data for a Selected Transcoder

1. With the Transcoder Menu on display, click on the down arrow at the right of the Card Select field, and select the appropriate transcoder card from the drop-down list of options
2. Click on the **Read** button at the right of the Read MUX Bitrates field to view MUX bitrate data (displayed in millions of bits per second [Mbit/s]) for the selected transcoder card, for example:

```
Card 1:  
HDMI Input Bitrate 10.955 Mbit/s (raw 10.955 Mbit/s)  
Ethernet Input Bitrate: 3.826 Mbit/s (raw 3.838 Mbit/s)  
Data Output Bitrate: 4.127 Mbit/s  
Total Output Bitrate: 19.390 Mbit/s
```

Refer to the Installation & Setup Guide for HCS7720 transcoder cards for further information on bitrate data.

View the Pro:Idiom Key Checksum

1. With the Transcoder Menu on display, click on the down arrow at the right of the Card Select field, and select the appropriate transcoder card from the drop-down list of options.
2. Click on the **Read** button at the right of the Read PI Key Checksum field to display the Pro:Idiom key checksum for the selected transcoder, for example:

```
Card 1:  
PI key checksum is xxxxxxxxxxxx
```

where xxxxxxxxxxxx is a 10-digit number that identifies the Pro:Idiom key file installed on the transcoder.



Note: All transcoder cards in the card frame must have the same Pro:Idiom key file installed.

Configuration Options via GUI (Cont.)

Reload the Pro:Idiom Key on a Selected Transcoder

This command reloads the Pro:Idiom encryption key on a single transcoder card. Note that a password is required to initiate this command.

1. With the Transcoder Menu on display, click on the down arrow at the right of the Card Select field, and select the appropriate transcoder card from the drop-down list of options.
2. Click on the **Reload** button at the right of the Reload PI Key field.
3. At the pop-up window prompt for the password required to execute the operation, type the password and click **OK**.

When the reload is complete, the system will display confirmation, for example:

```
Card 1:  
Reloading the key ...  
Successfully reloaded PI key
```

Satellite STB Menu Commands

The following subsections describe how to access and use the Satellite STB Menu commands.

Access the Satellite STB Menu

1. Access the CodePlus Transcoder Series web GUI as described on page 16.
2. With the Homepage on display, click on the **Satellite STB** menu tab or link.

The Satellite STB Menu (see example on following page) enables you to view and modify selected satellite STB configuration settings.

Note: The Tuner Select field in the Satellite STB Menu is irrelevant and should be left at its default value (Tuner “1”) when HCS7720 transcoder cards are being used. Results displays that include tuner data for an HCS7720/ViP 222k STB pair will always specify Tuner 1.

Set the STB Channel

1. With the Satellite STB Menu on display, click on the down arrow at the right of the Card Select field, and select the appropriate card from the drop-down list of options.
2. Type the desired channel number (1 – 9999) in the Set Tuner Channel field, and then click on the **Set** button at the right of the entry field.

If the channel is set successfully, the satellite STB will change to the specified DISH Network channel and the system will display confirmation, for example:

```
Card 1 Tuner 1: Channel changed to 209
```

Configuration Options via GUI (Cont.)

Example: Satellite STB Menu

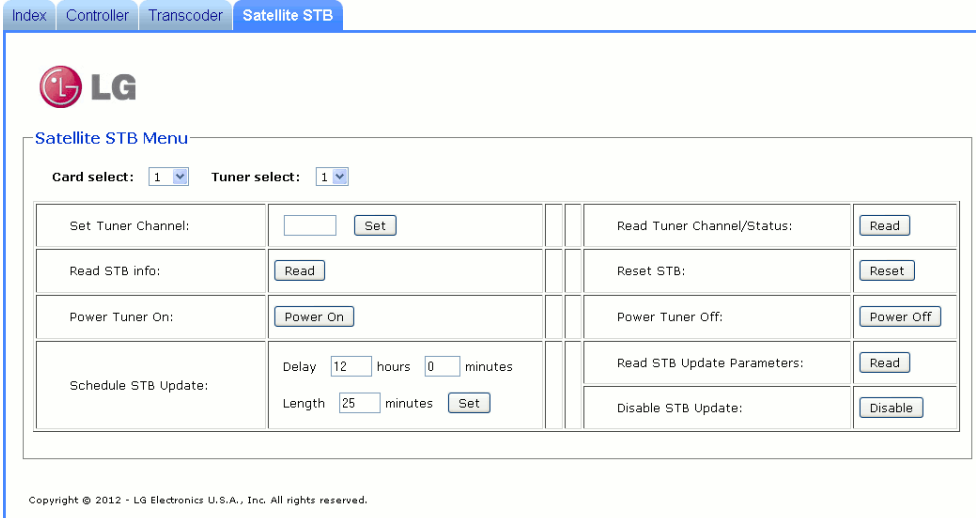

Read the STB Channel and Status

This option enables you to display the STB channel, as well as the lock status of the satellite signal (i.e., the STB is or is not locked to the satellite) and the satellite signal strength (displayed as a percentage) at the Satellite In jack on the satellite STB.

1. With the Satellite STB Menu on display, click on the down arrow at the right of the Card Select field, and select the appropriate transcoder card from the drop-down list of options.
2. Click on the **Read** button at the right of the Read Tuner Channel/Status field to display the currently selected satellite STB channel number, the lock status of the satellite signal, and the satellite signal strength, for example:

```
Card 1 Tuner 1:  
Current STB Channel is 209  
Satellite signal is locked  
Satellite signal strength is 52%
```

If you receive an error message, it may be necessary to reset the satellite STB either using the “Reset STB” command described on page 28 or using the RESET button on the satellite STB front panel.

Configuration Options via GUI (Cont.)

Read STB Information

This option enables you to display the STB model number, software version, serial number, and smart card number.

1. With the Satellite STB Menu on display, click on the down arrow at the right of the Card Select field, and select the appropriate transcoder card from the drop-down list of options.
2. Click on the **Read** button at the right of the Read STB Info field to display the satellite STB information, for example:

Card 1:

```
STB model is ViP222k-HD
STB software version is X398RPLB-N
STB serial number is R0128005665-79
Smart card number is S1920968050-61
```

Power the STB On or Off

Power On and Power Off options in the Satellite STB Menu enable you to power ON a satellite STB from standby mode or power OFF a satellite STB to standby mode.

1. With the Satellite STB Menu on display, click on the down arrow at the right of the Card Select field, and select the appropriate transcoder card from the drop-down list of options.
2. Either:

- Click on the **Power On** button at the right of the Power Tuner On field to power ON the satellite STB.

The system will display confirmation, for example:

```
Card 1 Tuner 1: STB Powered On
```

- Click on the **Power Off** button at the right of the Power Tuner Off field to switch the satellite STB to standby mode. HDMI output as well as Ethernet streaming is disabled.

The system will display confirmation, for example:

```
Card 1 Tuner 1: STB Powered Off
```

Reset the Satellite STB

1. With the Satellite STB Menu on display, click on the down arrow at the right of the Card Select field, and select the appropriate transcoder card from the drop-down list of options.
2. Click on the **Reset** button at the right of the Reset STB field to reset the satellite STB.

The system displays confirmation, for example:

```
Card 1: The STB is resetting...
```

After reset, the satellite STB resumes normal operation.

Configuration Options via GUI (Cont.)

Schedule an STB Update

The STB Software Update feature enables the STB to check for and download software updates on a one-time, user-defined basis. An STB Update should periodically be scheduled in conjunction with software updates from the satellite service provider.



Note: At the time an update is scheduled to begin, the STB will be switched to standby in order to enable it to download the update. When the update window is over, the STB will be switched back ON; however, note that it may take up to 10 minutes for streaming to resume. Contact your service provider for further information.

1. With the Satellite STB Menu on display, click on the down arrow at the right of the Card Select field, and select the appropriate transcoder card from the drop-down list of options.
2. Type the appropriate values in the Schedule STB Update fields:
 - Delay Hours and Minutes: Type the number of hours and minutes to delay before the STB Software Update is initiated.
 - Length: Specify the duration for the update window in minutes.

Note: The system will not allow a maintenance window that is less than 10 minutes or over four hours. The default value “25” is the minimum time span typically recommended for an update. It is also recommended that you schedule a maintenance window during a time when the STB is not likely to be used.
3. When you have completed the fields as necessary, click on the **Set** button at the right of the Schedule STB Update fields.

The system will display confirmation, for example:

Card 1: STB Update successfully configured.

Read STB Update Parameters

1. With the Satellite STB Menu on display, click on the down arrow at the right of the Card Select field, and select the appropriate transcoder card from the drop-down list of options.
2. Click on the **Read** button at the right of the Read STB Update Parameters field to display the current STB Software Update status, for example:

Card 1: STB Update is not scheduled.

or

Card 1: STB Update is scheduled to begin in 12 hours 0 minutes with duration 25 minutes.

Disable an STB Update

1. With the Satellite STB Menu on display, click on the down arrow at the right of the Card Select field, and select the appropriate transcoder card from the drop-down list of options.
2. Click on the **Disable** button at the right of the Disable STB Update field to disable the currently scheduled STB Software Update.

The system will display confirmation, for example:

Card 1: Successfully cleared STB Update configuration

Configuration Options via Command Line



Caution: Do NOT initiate simultaneous menu sessions to run commands. Doing so will interfere with active processes and may corrupt the system configuration and/or cause the HCS6320 card to cease normal operation.

Access the HCS6320 Main Menu

Note: The HCS6320 must be connected to an IP network for Telnet access. For direct access to the HCS6320 Service Port, use the FTDI TTL-USB cable (P/N TTL-232R-5V-AJ). See also “Network and Communication Setup” on page 15 for further information.

1. Establish communication with the HCS6320 using Telnet or via a direct connection to the HCS6320 Service Port.
2. Once communication is established, press **Enter** to refresh the menu display in the terminal. You now have access to the HCS6320 configuration Main Menu (see example below).
3. At the [Main] Command > prompt, type the desired menu command and press **Enter**.

Note: You can always press **Enter** at the [Main] Command > prompt to display the HCS6320 Main Menu. Main Menu options may vary from the example shown, depending on the HCS6320 firmware version.

The following sections describe the configuration commands.

Example: HCS6320 Main Menu

```
-----  
Main Menu      (Copyright 2012 - LGE USA)  
-----  
  
info      System Information  
rf        Set RF Channels  
mrf       Print RF Channels Map  
list      List Cards  
card      Card Menu  
xrst      External Card Reset  
setip     Set Up IP Address  
pi        Install PI Key On All Cards  
pr        Reload PI Key on All Cards  
upd       Update Firmware  
bits      Read MUX Bitrates  
rawbits   Read Bitrates at Backplane Connector  
crosspt   Configure Card Number to Channel Assignment  
rstpwd    Reset Password (for Reload PI Key on Web UI)  
  
[Main] Command >
```

Configuration Options via Command Line (Cont.)

View HCS6320 System Information

1. Access the HCS6320 Main Menu as described on the previous page.
2. At the [Main] Command > prompt, type **info** and press **Enter** to display HCS6320 hardware and software information.

The System Information display contains important information about the HCS6320, including the unit hardware ID (firmware version), software versions, IP address, MAC address, and serial number, for example:

```
System Information
-----
Model:                HCS6320
Hardware ID:          6320-v1.0-2011-1101
OS version:           HCS6320-1102-2011-1031
Application version:  2.5
IP address:           10.166.60.81
MAC address:          00:0C:63:3C:00:02
Serial#:              901-12420020
```

It is recommended that you record this information for future reference. If you find it necessary to call customer service or engineering support, please have this information available.

Set HCS6320 RF Channels

1. Access the HCS6320 Main Menu as described on the previous page.
2. At the [Main] Command > prompt, type **rf** and press **Enter**.
3. At the Enter the start channel number [2 - 132] > prompt, type the appropriate start channel number and press **Enter**.

The remaining channels will be automatically assigned per EIA-542 STD CATV frequency allocation standards, and the system will display the channel assignments (i.e., the Channel Map) for the card slots (see example under "Print the RF Channels Map" below).

Print the RF Channels Map

1. Access the HCS6320 Main Menu as described on the previous page.
2. At the [Main] Command > prompt, type **mrf** and press **Enter** to display the current Channel Map, for example:

```
Channel Map:
-----+-----
Cards   | RF Channel
-----+-----
  1,  2 |      2
  4,  5 |      3
  8,  9 |      4
 11, 12 |      5
-----+-----
```

Configuration Options via Command Line (Cont.)

Display a List of Transcoder Cards Installed in the Chassis

1. Access the HCS6320 Main Menu as described on page 30.
2. At the [Main] Command > prompt, type **list** and press **Enter**.

The display identifies the type of transcoder cards installed and their serial numbers, for example:

Available cards:

```
Card 1: [HCS7720] [001-12080017]
Card 2: [HCS7720] [001-12080018]
Card 3: [-]
Card 4: [HCS7720] [001-12080019]
Card 5: [HCS7720] [001-12080020]
Card 6: [-]
Card 7: [-]
Card 8: [HCS7720] [001-12080021]
Card 9: [HCS7720] [001-12020006]
Card 10: [-]
Card 11: [HCS7720] [001-12080023]
Card 12: [HCS7720] [001-12080024]
```

Access Individual Transcoder Menus

See “Transcoder Menu Commands” on pages 39 to 42 for detailed information on transcoder configuration options.

Perform an External Card Reset

1. Access the HCS6320 Main Menu as described on page 30.
2. At the [Main] Command > prompt, type **xrst** and press **Enter**.
3. At the Enter card number (1-12, 'ctr', or 'all') > prompt, either:
 - Type the slot number of the card and press **Enter** to reset a single transcoder card.
 - Type **all** and press **Enter** to reset each of the transcoder cards.
 - Type **ctr** and press **Enter** to reset the HCS6320.

If you opt to reset one or more of the transcoder cards, the system will display confirmation before initiating the reset of the selected card(s), for example:

Resetting card 5:

If you opt to reset the HCS6320, the system will initiate the reset immediately without further confirmation.

Configuration Options via Command Line (Cont.)

Set the HCS6320 IP Address

1. Access the HCS6320 Main Menu as described on page 30.
2. At the [Main] Command > prompt, type **setip** and press **Enter**.
3. At the Using DHCP (y/n)? prompt, either:
 - Type **y** and press **Enter** if using DHCP. The system will display: IP address has been set.
Go to step 5.
 - Type **n** and press **Enter** to assign a static IP address to the HCS6320. Then, continue with step 4.
4. At each of the following prompts, type the information requested. Press **Enter** after each entry.
Enter IP address: *(Type the host IP address in the format xxx.xxx.xxx.xxx.)*
Enter Subnet Mask: *(Type the subnet mask in the format xxx.xxx.xxx.xxx.)*
Enter Gateway: *(Type the IP address of the default gateway in the format xxx.xxx.xxx.xxx.)*
Once you enter the gateway address, the system will display: IP address has been set.
5. Reset the HCS6320 card (see “Perform an External Card Reset” on page 32). IP settings will not take effect until the HCS6320 resets.
Note: If you intend to modify additional configuration settings during the current session, you may wait until all changes are complete before you reset the HCS6320.

Install a Pro:Idiom Key on All Transcoders

The Pro:Idiom encrypter built into the transcoder cards contains a default encryption key. When first installed, the cards will use this key to encrypt content. This command enables you to change the encryption key, if necessary.

This command installs the Pro:Idiom key on all the transcoders installed in the chassis. To install a Pro:Idiom key on a single transcoder, see “Install a Pro:Idiom Key on the Selected Transcoder” on page 40.



Note: In order for a Pro:Idiom encrypted channel to be displayed, the receiver must contain a Pro:Idiom decrypter, and the receiver must be configured to allow decryption of the desired channel.



Note: The process of updating the encryption key will synchronize the decryption key in any receiver tuned to the cards' output. If the target receiver is turned off or viewing content from a different card, the synchronization will not occur, and the output will be scrambled. Ensure that all encrypters and decrypters in a system are synchronized to the same key.

Configuration Options via Command Line (Cont.)

(Continued from previous page)

 **Caution: Do NOT initiate simultaneous menu sessions while a Pro:Idiom key installation is in progress. Doing so will interfere with the active processes and may corrupt the system configuration and/or cause the HCS6320 card to cease normal operation.**

1. Confirm the directory location of the Pro:Idiom key (.hex) file. Note: For a TFTP file transfer, the key file must be available on the same machine as the TFTP server.
2. Access the HCS6320 Main Menu as described on page 30.
3. At the `[Main] Command >` prompt, type **pi** and press **Enter**.
4. At the `Use TFTP to download key (y/n)?` prompt, either:
 - Type **y** and press **Enter** to use TFTP for the Pro:Idiom key installation.
 - Type **n** and press **Enter** if you will not use TFTP for the Pro:Idiom key installation. At the next system prompt: `Use XMODEM to transfer files (y/n)?`, type **y** and press **Enter**.
5. Refer to the appropriate subsection below, depending on the file transfer option used.

Xmodem File Transfer

The system will request a key file. Transfer the new Pro:Idiom key file using Xmodem protocol.

For example, in HyperTerminal, select **Transfer** and then **Send File...** In the Send File window, enter or select the appropriate Pro:Idiom key file in the Filename field, and select **Xmodem** in the Protocol field.

TFTP Transfer

The HCS6320 must be connected to an IP network for a TFTP transfer. TFTP transfer also requires that you set up a TFTP server on the same IP network as the HCS6320. Consult the network administrator, as necessary, for further information.

- a) Make sure the key file is available on the same machine as the TFTP server. Then, set up the TFTP server, and point to the directory in which the Pro:Idiom key file is located. Note the name of the Pro:Idiom key file; you will need it to initiate the transfer.
- b) At the `Enter TFTP server IP` prompt, type the IP address for the TFTP server and press **Enter**, or simply press **Enter** if the default IP address shown in square brackets is correct.
- c) At the `Enter the PI key file name` prompt, type the name of the Pro:Idiom key file in the format `"filename.hex"` and press **Enter**.

The system will display progress messages as well as the result of the installation process. Note that the new key will be stored in non-volatile storage regardless of process results.

Configuration Options via Command Line (Cont.)

Reload the Pro:Idiom Key on All Transcoders

This command reloads the Pro:Idiom encryption key on all the transcoders installed in the chassis. To reload the Pro:Idiom key on a single transcoder, see “Reload the Pro:Idiom Key on the Selected Transcoder” on page 41.

1. Access the HCS6320 Main Menu as described on page 30.
2. At the `[Main] Command >` prompt, type **pr** and press **Enter** to initiate the reload immediately.

The system will display progress messages as it reloads the key on each transcoder. When the reload is complete, the system will display confirmation:

```
Operation completed
```

Update HCS6320 and/or Transcoder Firmware

If you are not sure of the current firmware version, view and record the System Information for the HCS6320 and/or the transcoder card(s) before you initiate the firmware update. See “View HCS6320 System Information” on page 31 and/or “View Hardware Information for the Selected Transcoder” on page 40, as necessary.

 **Caution: Do NOT initiate simultaneous menu sessions while a firmware update is in progress. Doing so will interfere with the active processes and may corrupt the system configuration and/or cause the HCS6320 card to cease normal operation.**

1. Confirm the directory location of the required firmware update configuration (.cfg) and package (.pkg) files. Note: For a TFTP file transfer, the firmware update files must be available on the same machine as the TFTP server.
2. Access the HCS6320 Main Menu as described on page 30.
3. At the `[Main] Command >` prompt, type **upd** and press **Enter**.
4. At the `Enter card number (1-12, 'ctr', or 'all') >` prompt, either:
 - Type the slot number of the card and press **Enter** to update a single transcoder card.
 - Type **all** and press **Enter** to update each of the transcoder cards.
 - Type **ctr** and press **Enter** to update the HCS6320 firmware.
5. At the `Use TFTP to transfer files (y/n)?` prompt, either:
 - Type **y** and press **Enter** to use TFTP for the firmware update.
 - Type **n** and press **Enter** if you will not use TFTP for the firmware update. At the next system prompt: `Use XMODEM to transfer files (y/n)?`, type **y** and press **Enter**.
6. Refer to the appropriate subsection below, depending on the file transfer option used.

(Continued on next page)

Configuration Options via Command Line (Cont.)

(Continued from previous page)

Xmodem File Transfer

- a) The system will request a configuration (.cfg) file. Transfer the new configuration file using Xmodem protocol.

For example, in HyperTerminal, select **Transfer** and then **Send File...** In the Send File window, enter or select the appropriate configuration file in the Filename field, and select **Xmodem** in the Protocol field.

- b) Upon receipt of the configuration file, the system will request a package (.pkg) file. Transfer the package file using Xmodem protocol.

TFTP Transfer

The HCS6320 must be connected to an IP network for a TFTP transfer. TFTP transfer also requires that you set up a TFTP server on the same IP network as the HCS6320. Consult the network administrator, as necessary, for further information.

- a) Make sure the firmware update files are available on the same machine as the TFTP server. Then, set up the TFTP server, and point to the directory in which the firmware update files are located.

Note the name of the configuration file; you will need it to initiate the transfer.

- b) At the `Enter TFTP server IP` prompt, type the IP address for the TFTP server and press **Enter**, or simply press **Enter** if the default IP address shown in square brackets is correct.
- c) At the `Enter the config file name` prompt, type the name of the configuration file in the format "*filename.cfg*" and press **Enter**. This will initiate the installation of both the configuration and package files.

7. The system will display progress messages as well as the result of the update process (which may take several minutes). When the firmware update is successfully completed, initiate a reset of ALL the cards that received the firmware update (see "Perform an External Card Reset" on page 32).

View MUX or Raw Bitrate Data

Bitrate data is useful for system monitoring and troubleshooting purposes. MUX bitrates provide information on MUX data processing, i.e., the amount of data filtering in and out of the MUX. Raw bitrates are measured at the input pins prior to data processing.

1. Access the HCS6320 Main Menu as described on page 30.
2. At the `[Main] Command >` prompt, either:
 - Type **bits** and press **Enter** to view MUX bitrate data for each HCS6320-controlled transcoder. See example on following page.
 - Type **rawbits** and press **Enter** to view raw bitrate data for each installed transcoder card. See example on following page.

Configuration Options via Command Line (Cont.)

Example: MUX Bitrates Display

```
Slot #1 Bitrate 15.696 Mbit/s (unfiltered 15.732 Mbit/s)
Slot #2 Bitrate 12.658 Mbit/s (unfiltered 12.694 Mbit/s)
Mux #1 Output Bitrate 31.746 Mbit/s
Slot #4 Bitrate 19.335 Mbit/s (unfiltered 19.359 Mbit/s)
Slot #5 Bitrate 14.679 Mbit/s (unfiltered 14.715 Mbit/s)
Mux #2 Output Bitrate 34.051 Mbit/s
Slot #8 Bitrate 13.013 Mbit/s (unfiltered 13.049 Mbit/s)
Slot #9 Bitrate 13.903 Mbit/s (unfiltered 13.933 Mbit/s)
Mux #3 Output Bitrate 26.970 Mbit/s
Slot #11 Bitrate 6.269 Mbit/s (unfiltered 6.305 Mbit/s)
Slot #12 Bitrate 18.583 Mbit/s (unfiltered 18.614 Mbit/s)
Mux #4 Output Bitrate 24.900 Mbit/s
Per Mux Total Output Bitrate 38.815 Mbit/s
```

Data currently in use by the MUX

Unprocessed data

Data currently output by the MUX

Total amount of data (including null packets) output per RF channel

Example: Raw Bitrates Display

```
Slot #1 Raw bitrate data 14.228 Mbit/s total 19.396 Mbit/s
Slot #2 Raw bitrate data 12.537 Mbit/s total 19.390 Mbit/s
Slot #3 Raw bitrate data 0 total 0
Slot #4 Raw bitrate data 17.049 Mbit/s total 19.390 Mbit/s
Slot #5 Raw bitrate data 15.503 Mbit/s total 19.396 Mbit/s
Slot #6 Raw bitrate data 0 total 0
Slot #7 Raw bitrate data 0 total 0
Slot #8 Raw bitrate data 13.536 Mbit/s total 19.390 Mbit/s
Slot #9 Raw bitrate data 13.957 Mbit/s total 19.396 Mbit/s
Slot #10 Raw bitrate data 0 total 0
Slot #11 Raw bitrate data 7.520 Mbit/s total 19.396 Mbit/s
Slot #12 Raw bitrate data 18.620 Mbit/s total 19.396 Mbit/s
```

Total number of data bits that are not null packets

Total number of data bits in the transport stream

Configure Card Number to Channel Assignments

This option enables you to reconfigure the card number/channel assignments.

1. Access the HCS6320 Main Menu as described on page 30.
2. At the [Main] Command > prompt, type **crosspt** and press **Enter**.

The system displays the current channel assignments and prompts for the desired action, for example:

(Continued on next page)

Configuration Options via Command Line (Cont.)

(Continued from previous page)

1. RF 58-1 <-- Slot #1
2. RF 58-2 <-- Slot #2
3. RF 59-1 <-- Slot #4
4. RF 59-2 <-- Slot #5
5. RF 60-1 <-- Slot #8
6. RF 60-2 <-- Slot #9
7. RF 61-1 <-- Slot #11
8. RF 61-2 <-- Slot #12

Do you wish to change the mapping of physical slots to RF channels (y/n)?

3. To change the RF channel mapping, type **y** and press **Enter**.

Note: Type **n** and press **Enter** to return to the Main Menu prompt without changing the channel mapping.

4. At the Enter the mux input number [1 - 8] > prompt, type the line number for the channel you wish to reassign. Then, press **Enter**.
5. At the Enter the slot number [1 - 12] > prompt, type the slot number of the transcoder card you wish to assign to the selected channel. Then, press **Enter**.

The system confirms the new assignment:

```
Set Cross point switch... OK!
```

and then redisplay the channel assignments along with the Main Menu prompt.

6. Repeat steps 2 to 5 to remap additional channels.

Reset Password for Reload PI Key GUI Option

Users who wish to reload a selected transcoder's Pro:Idiom key from the GUI require a password in order to do so. This option enables you to reset the Pro:Idiom password to its default value ("service").

Note: Users also have the ability to set a new password during the process of reloading the Pro:Idiom key from the GUI (see "Change the [Reload Pro:Idiom Key] Password" on page 22).

1. Access the HCS6320 Main Menu as described on page 30.
2. At the [Main] Command > prompt, type **rstpwd** and press **Enter**.
3. At the Reset password (y/n)? prompt for confirmation, either:
 - Type **y** and press **Enter** to reset the default password immediately. The system confirms success (Password reset ok) and then redisplay the Main Menu prompt.
 - Type **n** and press **Enter** to abort the password reset. The system displays confirmation (Password reset. Aborted!) and then redisplay the Main Menu prompt.

Configuration Options via Command Line (Cont.)

Transcoder Menu Commands

The following subsections describe how to access and use the Transcoder Menu commands.

Note: Refer to the Installation & Setup Guide for the applicable transcoder cards for further information on transcoder configuration options.

Access the Transcoder Menu

1. Access the HCS6320 Main Menu as described on page 30.
2. At the `[Main] Command >` prompt, type **card** and press **Enter**.
3. At the `Enter card number (1-12) >` prompt, type the chassis slot number of the transcoder card for which you wish to access configuration options. Then, press **Enter**.

The system identifies the card type and then displays a command prompt for the card menu, for example:

```
Card #1 is: HCS7720
[HCS7720 (1)] Command >
```

4. At the `Command >` prompt, either:
 - Press **Enter** to display the card menu (see example below).
 - Type the desired command and press **Enter**.

Note: You can always press **Enter** at the `Command >` prompt to display the Transcoder Menu.

Example: Transcoder Menu

```
-----
HCS7720 Menu
-----
hwid      Read Hardware ID
ver       Read Software Versions
bits      Read MUX Bitrates
pi        Install PI Key
pr        Reload PI Key
cksum     Read PI Key Checksum
stb       Satellite Receiver Menu
upd       Update Firmware
irst      Internal Reset
ret       Return to Main Menu

[HCS7720 (1)] Command >
```

Configuration Options via Command Line (Cont.)

View Hardware Information for the Selected Transcoder

At the [HCS7720 (#)] Command > prompt, type **hwid** and press **Enter** to view the selected card's hardware ID (firmware version), for example:

```
Card HWID# is: 7720-v1.1-2011-1026
```

View Software Information for the Selected Transcoder

At the [HCS7720 (#)] Command > prompt, type **ver** and press **Enter** to view the selected card's software versions, for example:

```
OS version:           HCS7720-943-2011-1025
Encoder version:      1.2
Application version:  2.5
```

View MUX Bitrate Data for the Selected Transcoder

At the [HCS7720 (#)] Command > prompt, type **bits** and press **Enter**.

MUX bitrate data for the selected transcoder card is displayed in millions of bits per second (Mbit/s), for example:

```
HDMI Input Bitrate 6.684 Mbit/s (raw 6.684 Mbit/s)
Ethernet Input Bitrate: 3.826 Mbit/s (raw 3.838 Mbit/s)
Data Output Bitrate: 4.127 Mbit/s
Total Output Bitrate: 19.390 Mbit/s
```

Refer to the Installation & Setup Guide for HCS7720 transcoder cards for further information on bitrate data.

Install a Pro:Idiom Key on the Selected Transcoder

This command installs the Pro:Idiom encryption key on the selected transcoder card. To install a Pro:Idiom key on all the transcoders, see "Install a Pro:Idiom Key on All Transcoders" on page 33.



Caution: Do NOT initiate simultaneous menu sessions while a Pro:Idiom key installation is in progress. Doing so will interfere with the active processes and may corrupt the system configuration and/or cause the HCS6320 card to cease normal operation.



Note: In order for a Pro:Idiom encrypted channel to be displayed, the receiver must contain a Pro:Idiom decrypter, and the receiver must be configured to allow decryption of the desired channel.

(Continued on next page)

Configuration Options via Command Line (Cont.)

(Continued from previous page)

 **Note:** The process of updating the encryption key will synchronize the decryption key in any receiver tuned to the cards' output. If the target receiver is turned off or viewing content from a different card, the synchronization will not occur, and the output will be scrambled. Ensure that all encrypters and decrypters in a system are synchronized to the same key.

1. Confirm the directory location of the Pro:Idiom key (.hex) file. Note: For a TFTP file transfer, the key file must be available on the same machine as the TFTP server.
2. At the [HCS7720 (#)] Command > prompt, type **pi** and press **Enter**.
3. At the Use TFTP to transfer files (y/n)? prompt, either:
 - Type **y** and press **Enter** to use TFTP for the firmware update.
 - Type **n** and press **Enter** if you will not use TFTP for the firmware update. At the next system prompt: Use XMODEM to transfer files (y/n)?, type **y** and press **Enter**.
4. Complete the update using the selected transfer mode (Xmodem or TFTP). Refer to "Install a Pro:Idiom Key on All Transcoders" on page 33 for further information.

The system will display progress messages as well as the result of the installation process. Note that the new key will be stored in non-volatile storage regardless of process results.

Reload the Pro:Idiom Key on the Selected Transcoder

This command reloads the Pro:Idiom encryption key on the selected transcoder card. To reload the Pro:Idiom key on all the transcoders, see "Reload the Pro:Idiom Key on All Transcoders" on page 35.

1. At the [HCS7720 (#)] Command > prompt, type **pr** and press **Enter**.
2. At the Reload PI key. Continue (y/n)? prompt, type **y** and press **Enter** to continue.

When the reload is complete, the system will display confirmation:

```
Reload PI complete OK
```

View the Pro:Idiom Key Checksum for the Selected Transcoder

At the [Card (#)] Command > prompt, type **cksum** and press **Enter** to display the Pro:Idiom key checksum for the selected transcoder, for example:

```
PI key checksum is xxxxxxxxxxxx
```

where xxxxxxxxxxxx is a 10-digit number that identifies the Pro:Idiom key file installed on the transcoder.

 **Note:** All transcoder cards in the card frame must have the same Pro:Idiom key file installed.

Configuration Options via Command Line (Cont.)

Access the Satellite Receiver Menu for the Selected Transcoder

See “Satellite Receiver Menu Commands” on pages 43 to 47 for detailed information on satellite STB configuration options.

Update Firmware on the Selected Transcoder

This command updates the firmware on the selected transcoder card. To update firmware on all transcoders or on the HCS6320, see “Update HCS6320 and/or Transcoder Firmware” on page 35.

 **Caution: Do NOT initiate simultaneous menu sessions while a firmware update is in progress. Doing so will interfere with the active processes and may corrupt the system configuration and/or cause the HCS6320 card to cease normal operation.**

If you are not sure of the current firmware version, view and record the transcoder hardware ID (firmware version) before you initiate the firmware update. See “View Hardware Information for the Selected Transcoder” on page 40.

1. Confirm the directory location of the required firmware update configuration (.cfg) and package (.pkg) files. Note: For a TFTP file transfer, the firmware update files must be available on the same machine as the TFTP server.
2. At the [HCS7720 (#)] Command > prompt, type **upd** and press **Enter**.
3. At the Use TFTP to transfer files (y/n)? prompt, either:
 - Type **y** and press **Enter** to use TFTP for the firmware update.
 - Type **n** and press **Enter** if you will not use TFTP for the firmware update. At the next system prompt: Use XMODEM to transfer files (y/n)?, type **y** and press **Enter**.
4. Complete the update using the selected transfer mode (Xmodem or TFTP). Refer to “Update HCS6320 and/or Transcoder Firmware” on page 35 for further information.
5. Reset the transcoder card (see “Reset the Selected Transcoder Card” below).

Reset the Selected Transcoder Card

At the [HCS7720 (#)] Command > prompt, type **irst** and press **Enter** to initiate the reset. After reset, the transcoder card resumes normal operation.

Return to the HCS6320 Main Menu

At the [HCS7720 (#)] Command > prompt, type **ret** and press **Enter** to return to the HCS6320 Main Menu.

Configuration Options via Command Line (Cont.)

Satellite Receiver Menu Commands

The following subsections describe how to access and use the Satellite Receiver Menu commands.

Access the Satellite Receiver Menu

1. Access the card menu for the selected transcoder (see “Access the Transcoder Menu” on page 39).
2. At the [HCS7720 (#)] Command > prompt, type **stb** and press **Enter**.
3. At the [Satellite (#)] Command > prompt, either:
 - Press **Enter** to display the Satellite Receiver Menu (see example below).
 - Type the desired command and press **Enter**.

Note: You can always press **Enter** at the Command > prompt to display the Satellite Receiver Menu.

Example: Satellite Receiver Menu

```
-----  
Satellite Receiver Menu  
-----
```

```
getch      Read Current STB Channel  
setch      Set STB Channel  
sglvl      Read Satellite Signal Strength  
lksts      Read Satellite Lock Status  
bnum       Read STB Serial Number  
cnum       Read Smart Card Number  
on         Turn STB On  
off        Turn STB Off (Standby)  
stbrst     Reset Satellite STB  
getupd     Read STB Update Parameters  
setupd     Set STB Update Parameters  
model      Read STB Model  
ver        Read STB Software Version  
ret        Return to Card Menu
```

where:

is the chassis card/slot number you selected for configuration purposes.

```
[Satellite (#)] Command >
```

Configuration Options via Command Line (Cont.)

Read the Current STB Channel

At the [Satellite (#)] Command > prompt, type **getch** and press **Enter** to display the currently selected satellite STB channel number, for example:

```
Card 1: Current STB channel is 200
```

If you receive an error message, it may be necessary to reset the satellite STB either using the “Reset Satellite STB” command described on page 45 or using the RESET button on the STB front panel.

Set the STB Channel

1. At the [Satellite (#)] Command > prompt, type **setch** and press **Enter** to retune the satellite STB.
2. At the Enter channel number > prompt, type the desired channel number (1–9999) and press **Enter**.

Note: Since low channel numbers may be assigned to both SD and HD channels, if this is an HD channel and is also mapped to an unambiguous higher channel number, it is recommended that you type the higher number here.

3. At the prompt for confirmation: Set channel number to xxx (y/n)?, either:
 - Type **y** and press **Enter** to confirm the setting.
 - Type **n** and press **Enter** to return to the [Satellite (#)] Command > prompt without setting a new channel.

Once you confirm the channel number setting, the system will display confirmation, for example:

```
Card 1: Changing STB channel to xxx ... OK
```

Read the Satellite Signal Strength

At the [Satellite (#)] Command > prompt, type **sglvi** and press **Enter** to display the satellite signal strength (displayed as a percentage) at the Satellite In jack on the satellite STB, for example:

```
Card 1: Satellite signal strength is 52%
```

Read the Satellite Lock Status

At the [Satellite (#)] Command > prompt, type **lksts** and press **Enter** to determine whether or not the satellite STB is locked to the satellite, for example:

```
Card 1: Satellite signal is locked
```

Configuration Options via Command Line (Cont.)

Read the Satellite STB Serial Number

At the [Satellite (#)] Command > prompt, type **bnum** and press **Enter** to display the satellite STB serial number, for example:

```
Card 1: STB serial# is: R0128005665-79
```

Read the Satellite STB Smart Card Number

At the [Satellite (#)] Command > prompt, type **cnum** and press **Enter** to display the satellite STB smart card serial number, for example:

```
Card 1: Smart card# is: S1920968050-61
```

Power the Satellite STB On or Off

“Turn STB On” and “Turn STB Off” options in the Satellite Receiver Menu enable you to power ON a satellite STB from standby mode or power OFF a satellite STB to standby mode.

At the [Satellite (#)] Command > prompt, either:

- Type **on** and press **Enter** to power ON the satellite STB.
- Type **off** and press **Enter** to switch the satellite STB to standby mode. HDMI output as well as Ethernet streaming is disabled.

Reset the Satellite STB

1. At the [Satellite (#)] Command > prompt, type **stbrst** and press **Enter** to reset the satellite STB.

2. At the Reset (y/n)? prompt, either:

- Type **y** and press **Enter** to reset the satellite STB. After reset, the satellite STB resumes normal operation.
- Type **n** and press **Enter** to return to the [Satellite (#)] Command > prompt without resetting the STB.

Read and/or Set STB Update Parameters

The STB Software Update feature enables the STB to check for and download software updates on a one-time, user-defined basis. An STB update should periodically be scheduled in conjunction with software updates from the satellite service provider.

 **Note:** At the time an update is scheduled to begin, the STB will be switched to standby in order to enable it to download the update. When the update window is over, the STB will be powered back ON; however, note that it may take up to 10 minutes for streaming to resume. Contact your service provider for further information.

You can view the current STB update status (scheduled, not scheduled, or in progress), and/or you can modify the STB update status/parameters, as required.

Configuration Options via Command Line (Cont.)

Read STB Update Parameters

At the [Satellite (#)] Command > prompt, type **getupd** and press **Enter** to display the current STB update status, for example:

```
STB Update is scheduled to begin in 12 hours 0 minutes  
with duration 25 minutes
```

or

```
STB Update is not scheduled.
```

or

```
STB Update is in progress.
```

```
It will end in 1 minutes (total duration 25 minutes).
```

Set STB Update Parameters

1. At the [Satellite (#)] Command > prompt, type **setupd** and press **Enter**.
2. At the Change STB Update setting (y/n)? prompt, either:
 - Type **y** and press **Enter** to modify the current STB software update parameters.
 - Type **n** and press **Enter** to return to the Satellite Receiver Menu without modifying the STB software update parameters.
3. At the Enable updates (y/n)? prompt, either:
 - Type **y** and press **Enter** to enable and configure STB software update parameters. The system will initiate a series of prompts that enable you to specify the maintenance window for the update. Continue with step 4.
 - Type **n** and press **Enter** to disable the STB software update. Then, press **Enter** again to return to the Command > prompt.
4. At each of the following prompts, type the number of hours and minutes to delay before the STB software update is initiated, as well as the desired duration (in minutes) for the update window. Note that all three of these fields require numerical values. Press **Enter** after each entry.

If applicable, you can also press **Enter** at each prompt to accept the default value in square brackets.

```
Enter the number of hours to delay before starting [12]
```

```
Enter the number of minutes to delay before starting [0]
```

```
Enter the maintenance window duration in minutes [25]
```

Note: The system will not allow a maintenance window that is less than 10 minutes or over four hours. The default value (25 minutes) is the minimum time span typically recommended for an update. It is also recommended that you schedule a maintenance window during a time when the STB is not likely to be in use.

(Continued on next page)

Configuration Options via Command Line (Cont.)

(Continued from previous page)

After you enter a valid maintenance window duration, the system will display confirmation, for example:

```
Configured STB Update... OK
Press any key to continue
```

Read the Satellite STB Model Type

At the [Satellite (#)] Command > prompt, type **model** and press **Enter** to display the STB model type, for example:

```
STB model is: ViP222k-HD
```

Read the Satellite STB Software Version

At the [Satellite (#)] Command > prompt, type **ver** and press **Enter** to display the STB software version, for example:

```
STB sw_ver is: X398RPLB-N
```

Return to the Transcoder Menu

At the [Satellite (#)] Command > prompt, type **ret** and press **Enter** to return to the card menu.

Troubleshooting

This section provides troubleshooting information for the HCS6320. You can find additional troubleshooting help at www.dishnetwork.com.

Equipment Setup Review

- Make sure all connectors and connections are tight and secure on all entertainment system components.
- Check the Ethernet connection; is it viable and working?
 - Observe the green and amber LEDs on the Ethernet connector.
 - The green LED should blink rapidly.
 - The amber LED should stay lit constantly.
- Ensure the satellite STB smart card is up-to-date and authorized by DISH Network.

STATUS LED

The green STATUS LED on the HCS6320 front panel provides general information about the operating condition of the card. Observe the STATUS LED, and refer to the following table:

STATUS LED Behavior	Operating Status
Slow Blinking	Power Up State
Rapid Blinking	Error Condition
Continuously On	Normal Operation
Continuously Off	Fault Condition, No Output

Audio/Video Freeze or Blank Screen

Perform one or more of the following (in order):

- Press the RESET button located on the front of the satellite STB, and allow the STB to retrieve the DISH Network program guide.
- Unplug the power cord of the satellite STB for 15 seconds; then plug it in again.
- Use a small object (for example, a paperclip) to press the recessed RESET button on the HCS6320. Hold for five seconds to initiate the reset.
- Unplug the power cord of the CodePlus card frame for 15 seconds; then plug it in again.

Specifications

Dimensions

Height: 3U (130.20 mm)
Width: 1.102362 inches (28.00 mm)
Depth: 9.055118 inches (230.00 mm)
Weight: 0.5 pounds (0.221 kgrms) Est.

Environmental Storage Conditions

Temperature: -20° to 70° Celsius
-4° to 158° Fahrenheit
Humidity: 95% non-condensing

Operating Conditions

Temperature: 0° to 40° Celsius
32° to 104° Fahrenheit
Humidity: 95% non-condensing

Electrical

RF Out Connector:	Type 'F'
RF Output Span:	4 Contiguous Channels (typically 24 MHz)
RF Output Frequency Range:	54 MHz to 864 MHz
DC Input:	+12V DC @ 1.1 Amps
Active Output Level at RF Out jack:	+ 42 dBmV Min.
Ethernet Input:	10/100BaseT

Note: Design and specifications subject to change without prior notice.

Document Revision History / Notes

Document Revision History

Date	Description
August 2012	Revision A: New document

Product documentation is available online at: www.LGolutions.com/products. From the Products page, select **TVs, Systems & Solutions**, then **Head End Systems**, then **CodePlus Transcoder Series** (click **Show [+]** to view the list of products), then the applicable Modular System option. Click the **Literature & Downloads** tab at the bottom of the Modular System page, and select the required document(s) from the Downloads list.

Notes

Open Source Software Notice

The following GPL executables used in this product are subject to the GPL Version 2.0 License Agreements.

GPL EXECUTABLES: Linux kernel 2.6.26, boa 0.94, busybox 1.10.1, dhcpcd 0.70, eraseall 1.7, inetd 1.0, lrzsz 0.12.20, simpleinit 1.21

To obtain the source code under GPL, LGPL, MPL and other open source licenses that are contained in this product, please visit <http://opensource.lge.com>. In addition to the source code, all referenced license terms, warranty disclaimers and copyright notices are available for download. LG Electronics will also provide open source code to you on CD-ROM for a charge covering the cost of performing such distribution (such as the cost of media, shipping and handling) upon e-mail request to opensource@lge.com. This offer is valid for three (3) years from the date on which you purchased the product.

You can obtain a copy of the GPL license from: <http://www.gnu.org/licenses/old-licenses/gpl-2.0.html>.

This product includes:

- echo:
Copyright © 1998 David I. Bell
Permission is granted to use, distribute, or modify this source, provided that this copyright notice remains intact.
- telnet v1.9:
Copyright © 1989 The Regents of the University of California
 1. Redistributions of source code must retain the above copyright notice, this list of conditions and the following disclaimer.
 2. Redistributions in binary form must reproduce the above copyright notice, this list of conditions and the following disclaimer in the documentation and/or other materials provided with the distribution.
 3. All advertising materials mentioning features or use of this software must display the following acknowledgement: This product includes software developed by the University of California, Berkeley and its contributors.
 4. Neither the name of the University nor the names of its contributors may be used to endorse or promote products derived from this software without specific prior written permission.

All rights reserved.

Permission is hereby granted, free of charge, to any person obtaining a copy of this open source software and associated documentation files (the "Software"), to deal in the Software without restriction, including without limitation the rights to use, copy, modify, merge, publish, distribute, sublicense, and/or sell copies of the Software, and to permit persons to whom the Software is furnished to do so, subject to the following conditions:

SUBJECT TO THE TERMS OF THE GPL VERSION 2.0 LICENSE AGREEMENTS, THE SOFTWARE IS PROVIDED "AS IS", WITHOUT WARRANTY OF ANY KIND, EXPRESS OR IMPLIED, INCLUDING BUT NOT LIMITED TO THE WARRANTIES OF MERCHANTABILITY, FITNESS FOR A PARTICULAR PURPOSE AND NONINFRINGEMENT. IN NO EVENT SHALL THE AUTHORS, COPYRIGHT HOLDERS, OR LG ELECTRONICS (THE "LICENSOR") BE LIABLE FOR ANY CLAIM, DAMAGES OR OTHER LIABILITY, WHETHER IN AN ACTION OF CONTRACT, TORT OR OTHERWISE, ARISING FROM, OUT OF OR IN CONNECTION WITH THE SOFTWARE OR THE USE OR OTHER DEALINGS IN THE SOFTWARE, EVEN IF LICENSOR HAS BEEN ADVISED OF THE POSSIBILITY OF SUCH DAMAGES. LICENSEE ASSUMES THE COST OF ALL NECESSARY SERVICING, REPAIR, OR CORRECTION.

LG HCS6320 MUX/MOD Feature Card Warranty

Broadcast Products Welcome to the LG family! We believe that you will be pleased with your new HCS6320 MUX/MOD feature card. Please read this warranty carefully, it is a "LIMITED WARRANTY" as defined under Federal Law. This warranty gives you specific legal rights, and you may also have other rights that vary from state-to-state within the U.S.A.

LG's RESPONSIBILITY

Warranty Term One year parts and labor from date of purchase or delivery date.

Parts New or remanufactured replacements for factory-defective parts may be used. Such replacement parts are warranted for the remaining portion of the original warranty period.

Warranty Service Warranty service is provided at LG. Customer pays for shipping charges to LG; LG pays for return shipping charges to return HCS6320 to customer. Call **1-888-865-3026** for further information.

Not Covered This warranty covers manufacturing defects and does not cover installation, adjustment of customer controls, installation or repair of antenna systems, cable converters or cable company-supplied equipment; it also does not cover damage due to misuse, abuse, negligence, acts of God or other causes beyond the control of LG. Any alteration of the product after manufacture voids this warranty in its entirety.

This warranty does not cover any missing or stolen access cards.

THIS WARRANTY IS IN LIEU OF ANY OTHER WARRANTY, EXPRESS OR IMPLIED, INCLUDING WITHOUT LIMITATION, ANY WARRANTY OF MERCHANTABILITY OR FITNESS FOR A PARTICULAR PURPOSE, AND LG SHALL NOT BE LIABLE FOR ANY CONSEQUENTIAL, INDIRECT, OR INCIDENTAL DAMAGES OF ANY KIND, INCLUDING LOST REVENUES OR PROFITS IN CONNECTION WITH THIS PRODUCT. SOME STATES DO NOT ALLOW LIMITATIONS ON HOW LONG AN IMPLIED WARRANTY LASTS OR THE EXCLUSION OR LIMITATION OF INCIDENTAL OR CONSEQUENTIAL DAMAGES, SO THE ABOVE LIMITATIONS OR EXCLUSIONS MAY NOT APPLY TO YOU.

OWNER'S RESPONSIBILITY

Effective Warranty Date Warranty begins on the date of delivery of the HCS6320.
For your convenience, keep the dealer's dated bill of sale or delivery ticket as evidence of the purchase date.

Installation Guide Read the Installation & Setup Guide carefully so that you will understand the operation of the HCS6320 and how to adjust the controls.

Antenna Reception problems caused by inadequate antenna or faulty antenna connections are the owner's responsibility.

Warranty Service **For warranty service information, Call 1-888-865-3026.** Parts and service labor that are LG's responsibility (see above) will be provided without charge. Other service is at the owner's expense. If you have any problem in obtaining satisfactory warranty service, call **1-888-865-3026**.
You must provide the model number, serial number and date of purchase or date of original installation.

For Customer Support/Service, please call:

1-888-865-3026

www.LGolutions.com

CodePlus is a trademark of LG Electronics U.S.A., Inc. Pro:Idiom is a registered trademark of Zenith Electronics LLC. DISH, DISH Network, and ViP are registered trademarks of DISH Network LLC. All other trademarks or registered trademarks are the property of their respective owners.

Free Manuals Download Website

<http://myh66.com>

<http://usermanuals.us>

<http://www.somanuals.com>

<http://www.4manuals.cc>

<http://www.manual-lib.com>

<http://www.404manual.com>

<http://www.luxmanual.com>

<http://aubethermostatmanual.com>

Golf course search by state

<http://golfingnear.com>

Email search by domain

<http://emailbydomain.com>

Auto manuals search

<http://auto.somanuals.com>

TV manuals search

<http://tv.somanuals.com>