

DLP PROJECTOR

USER'S GUIDE

Thank you for purchasing the DLP™ Projector.

Please read this user's guide to ensure correct use of the device. Save this user's guide for future reference.

OUTLINE

This DLP™ Projector can display various computer signals and NTSC/PAL/SECAM video signals.

FEATURES

- 1. High Brightness**
- 2. High Resolution**
- 3. Compact Size, Feather Weight for Portability**
- 4. RGB and DVI-D Input Terminal**
- 5. One Touch Auto-Adjustment Function**
- 6. Easy Keystone Adjustment**

Copyright

Copyright © 2003. All rights reserved. No part of this publication may be reproduced, transmitted, transcribed, stored in a retrieval system or translated into any language or computer language, in any form or by any means, electronic, mechanical, magnetic, optical, chemical, manual or otherwise, without the prior written permission of the company.

Disclaimer

The company makes no representations or warranties, either expressed or implied, with respect to the contents hereof and specifically disclaims any warranties, merchantability or fitness for any particular purpose. Furthermore, the company reserves the right to revise this publication and to make changes from time to time in the contents hereof without obligation of the company to notify any person of such revision or changes.

Table of Contents

- Introduction 1**
 - Safety Instructions 1
 - FCC Statement 2
 - EEC STATEMENT 2
 - Shipping Contents 3
 - Optional Accessories 3
 - Projector Description 4
 - Projector 4
 - External Control Panel 5
 - Adjuster 6
 - Projector Features 6
 - Remote Control Description 7
 - Installing or Replacing Batteries (“AAA” type) 9
- Installation 10**
 - Display Size 10
 - Connecting to Various Equipment 11
- Operation 14**
 - Start Up 14
 - Digital Keystone Correction 15
 - Auto Adjustment 15
 - Source Selection 16
 - Blank 16
 - Menu System 17
 - 1. Display Menu 18
 - 2. Image Menu 19
 - 3. Source Menu 20
 - 4. Control Menu 21
 - 5. PIP Menu 22
 - Shutdown 23
- Maintenance 25**
 - Lamp Information 25
 - Use and Replacement of the Lamp 25
 - Lamp Replacement 25
 - Operative Information 26
- Troubleshooting 27**
 - Common Problems & Solutions 27



Status Messages 28

Specifications29

 Projector Specifications 29

 Timing Chart 30

 Supported timing for Analog RGB and DVI inputs 30

 Supported timing for YPbPr input 30

 Supported timing for Video and S-Video inputs 31

Dimensions32

INTRODUCTION

Caution

TO PREVENT SHOCK, DO NOT OPEN THE CABINET. NO USER –SERVICEABLE PARTS INSIDE. REFER SERVICING TO QUALIFIED SERVICE PERSONNEL. PLEASE READ THIS USER’S GUIDE BEFORE YOU OPERATE YOUR PROJECTOR. SAVE THIS USER’S GUIDE FOR FUTURE REFERENCE .

Safety Instructions

1. Read this user’s guide before you operate your projector and save it for future reference.
2. The lamp becomes extremely hot during operation. Allow the projector to cool for approximately 45 minutes prior to removing the lamp assembly for replacement. Do not operate lamps beyond the rated lamp life. Excessive operation of lamps beyond the rated life could cause them to explode on rare occasions.
3. Never replace the lamp assembly or any electronic components unless the projector is unplugged.
4. To reduce the risk of electric shock, do not disassemble this appliance. Take it to a qualified technician when service or repair is required. Incorrect reassembly can cause electric shock when the appliance is subsequently used.
5. Do not place this product on an unstable cart, stand, or table. The product may fall, sustaining serious damage.
6. Do not touch the top cover when the projector is under operation.
7. The projector must be packaged into a carry bag while moving to another place for operation.
8. To avoid the lamp being damaged, never turn the Main Power Switch off in the back of the projector during operation. The normal operation procedures are to turn the power button off, and, after a 90-second cooling process, turn off the Main Power Switch.

Caution

- **Always open the lens shutter when the projector lamp is on.**
 - **Do not look straight at the projector lens during operation. The intense light beam may damage your eyes.**
 - **In some countries, the line voltage is NOT stable. This projector is designed to operate safely within a bandwidth of 100 to 240 volts, but could fail if power cuts or surges of ± 10 volts occur. In these high-risk areas, it is recommended that a power stabilizer unit be used in conjunction with this projector.**
 - **Do not place this projector on the top of cloth or carpet.**
 - **Do not touch the ventilation grill when the projector is under operation.**
-

Save this user's guide: The information contained in this manual will assist you in operating and maintaining your personal projector.

FCC Statement

CLASS B: This equipment generates, uses and can radiate radio frequency energy and, if not installed and used in accordance with the instructions, may cause harmful interference to radio communications. However, there is no guarantee that interference will not occur in a particular installation. If this equipment does cause harmful interference to radio or television reception, which can be determined by turning the equipment off and on, the user is encouraged to try to correct the interference by one or more of the following measures:

- Reorient or relocate the receiving antenna.
- Increase the distance between the equipment and receiver.
- Connect the equipment into an outlet on a circuit different from that to which the receiver is connected.
- Consult the dealer or an experienced radio/TV technician for help.

EEC STATEMENT

This machine was tested against the 89/336/EEC (European Economic Community) for EMC (Electro Magnetic Compatibility) and fulfills these requirements.

Shipping Contents

The projector is shipped with the cables required for connection to standard PC or laptop computers. Carefully unpack and verify that you have all the items shown below. If any of these items are missing, please contact personnel at the place of purchase.

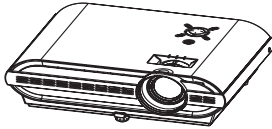

Projector



User's Guide



Quick Start Guide



Remote Control



Batteries

3-2 Converter

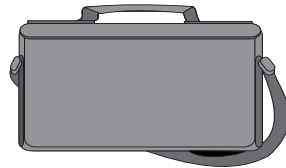

Deluxe Soft Carry Case

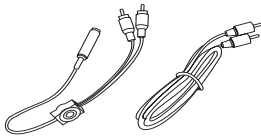

Audio Cable

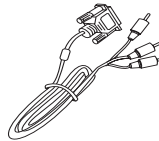

HDTV Cable
(YPbPr)

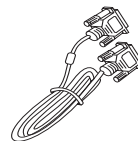

VGA Cable

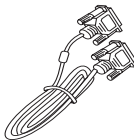

DVI-D Cable

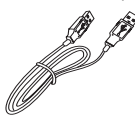

USB Cable

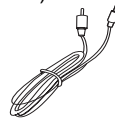

Video Cable

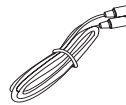

S-Video Cable

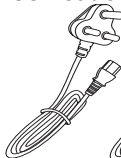

S.A. & India

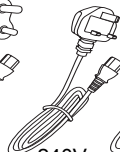

240V

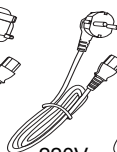

220V

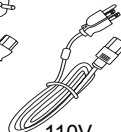

110V

Power Cord

Optional Accessories

1. 250W lamp module
2. Macintosh adapter
3. Ceiling mount kit

Projector Description

Projector

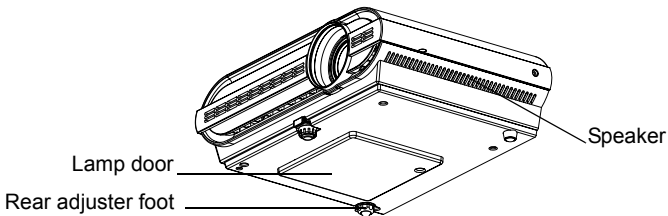
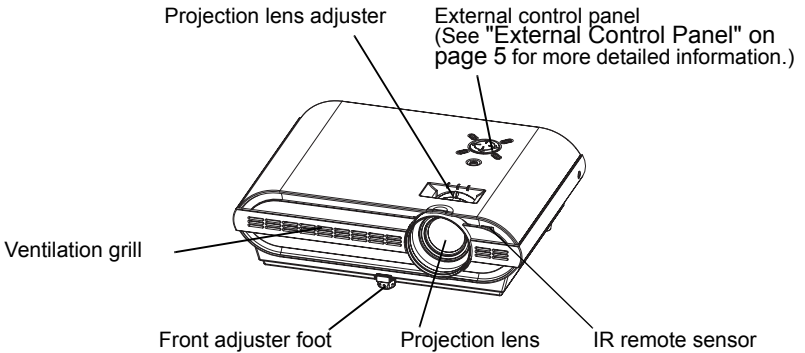
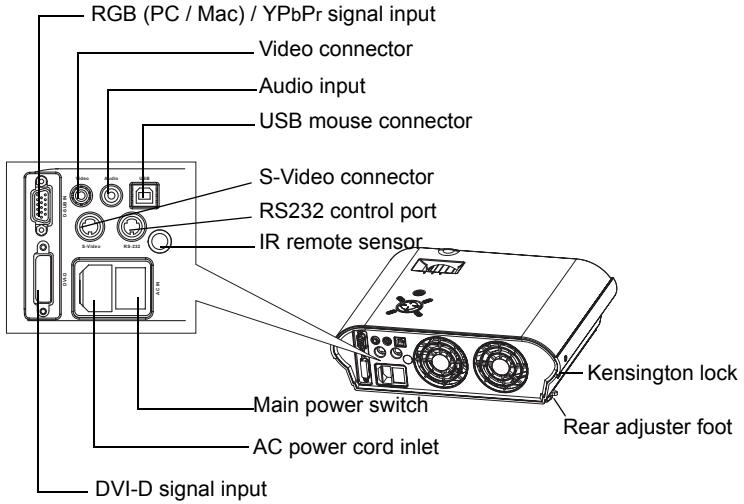

External Control Panel

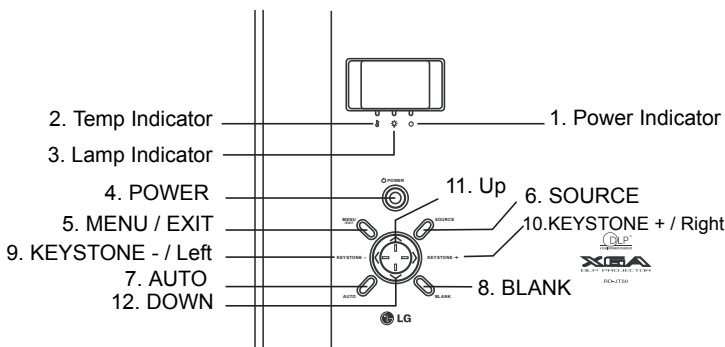

1. Power indicator

The indicator shows green for a normal state. When the projector is in Standby mode, it shows orange toggle. See "Operative Information" on page 26 for more detailed information.

2. Temp indicator

The Temp indicator shows red or flashed red when the system temperature is too high or has fan problems, which may occur if the projector is operated improperly. See "Operative Information" on page 26 for more detailed information.

3. Lamp Indicator

The Lamp Indicator will light up when the lamp needs service, cooling or replacement. See "Lamp Information" on page 25 and "Operative Information" on page 26 for more detailed information.

4. POWER

Press and hold the POWER key for 1 second to turn on or off the projector.

5. MENU / EXIT

Brings the OSD menu or leaves the OSD menu.

6. SOURCE

Selects signal sources from among Analog RGB, DVI, YPbPr, S-Video and Composite Video.

7. AUTO

Automatically determines the suitable frequency and clock for current received signals. The auto adjustment function will not affect the current brightness and colors settings.

8. BLANK

Uses **BLANK** to hide the screen image. You can press **BLANK** again or **RETURN** to bring the image back.

When this function is activated, the sound will not stop, unless you press **MUTE**.

9. KEYSTONE - 10. KEYSTONE +

Presses **KEYSTONE -** to correct a image that is wider at the top. Presses **KEYSTONE +** to correct a image that is wider at the bottom.

9. Left < 10. Right >

11. Up ^ 12. Down v

When the On-Screen Menu system is activated, the four buttons help you navigate among choices and settings in the menus and sub-menus.

Adjuster

The projector is equipped with 1 quick-release adjuster foot. Push the button to adjust its tilt angle.

1. Lift the projector up and press the adjuster button to release the adjuster. The adjuster will drop into position and be locked.
2. Screw the rear adjuster to fine-tune the tilt angle.

Note: The adjuster can only bear the weight of the projector itself . Please do not place any additional burden on it.

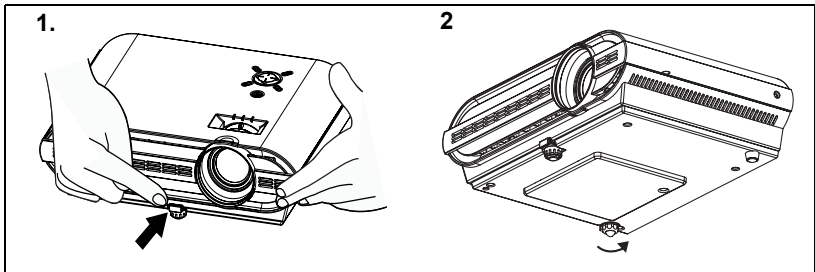

Projector Features

The projector integrates high-performance optical engine projection and a user-friendly design to deliver high reliability and ease of use.

The projector offers the following features:

- Small and light for portability.
- Full-function remote control with laser pointer/ remote mouse function.
- High quality manual zoom lens.
- One-key auto-adjustment to display the best picture quality in PC mode.
- Easy digital keystone correction through hot keys to correct distorted images.
- High resolution.
- Ultra-high brightness projection lamp.
- Ability to display 16.7 million colors.
- On-screen menus in 8 languages: English, French, German, Italian, Spanish, Korean, Simplified Chinese, and Traditional Chinese.
- Powerful AV function to provide high quality AV picture.
- HDTV compatibility (YPbPr).
- RGB and DVI-D input terminal

Note: The brightness of the projected image will vary depending on the ambient lighting conditions and contrast/brightness settings.

Remote Control Description

The remote control sensors are located in the front/ back of the projector.

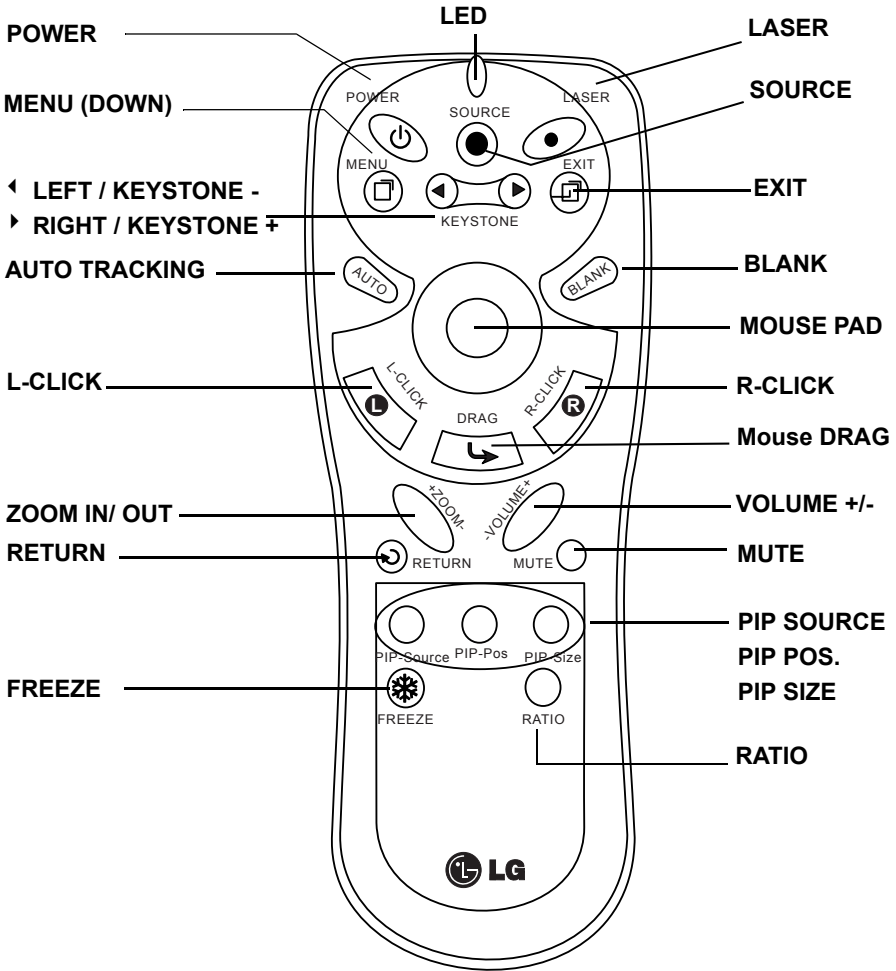

1. ◀ LEFT / KEYSTONE -, ▶ RIGHT / KEYSTONE +

When the OSD menu is activated, the buttons function as ◀ Left / ▶ Right. For the rest of time, the buttons function as Keystone - / Keystone +.

2. MOUSE PAD, MOUSE, L-CCLICK, R-CCLICK

When a PC or notebook is connected to the projector with a USB connector, these buttons work as a mouse.

3. ZOOM IN/ OUT

By pressing ZOOM IN +, the center of the picture will be magnified. When the + button is pressed again, the picture is further magnified, up to four times the original size. By pressing ZOOM OUT -, the size of the image is reduced. When the - button is pressed again, the picture is further reduced until it is restored to its original size. To return to the normal display mode, press the RETURN button. (This function can be used in combination with FREEZE.)

4. FREEZE

The image is frozen when FREEZE is pressed. A "Pause" icon will appear in the lower right corner of the screen. To stop the freeze function, press the FREEZE button, RETURN button or SOURCE button (when the input source is switched over during display) again.

5. PIP SOURCE, PIP POS., PIP SIZE

By pressing the PIP-Source, PIP-Pos and PIP-Size buttons, you can enable the PIP (Picture In Picture) function and choose the position and size of the PIP image.

6. RATIO

By pressing the Ratio button, you can select the screen aspect ratio you prefer: 4:3,16:9 or native input source resolution in RGB or DVI mode (when the input source's resolution is lower than the projector provides, you don't need to rescale the image.).

7. RETURN

Back to the last state from "ZOOM", "BLANK", "FREEZE" or "PIP".

Installing or Replacing Batteries (“AAA” type)

- ❶ Push and open the battery compartment lid in the direction shown.

- ❷ Install batteries as indicated by the diagram inside the compartment.

- ❸ Position the lid over the compartment and snap it back into place.

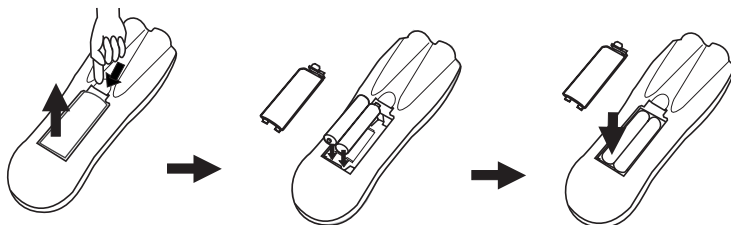

Caution

Avoid excessive heat and humidity. There may be danger of an explosion if batteries are incorrectly replaced. Replace only with the same or equivalent type recommended by the manufacturer. Dispose of used batteries according to the manufacturer's instructions.

INSTALLATION

Display Size

Place the projector at the required distance from the screen according to the desired picture size (see the table below).

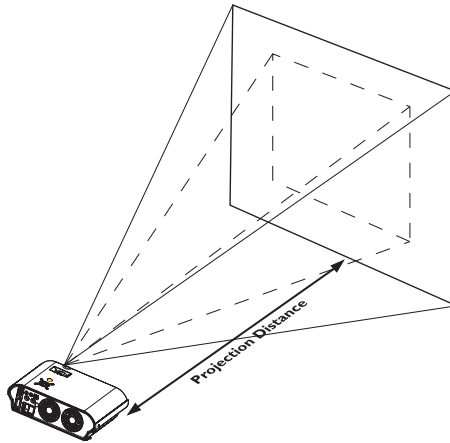

RD-JT50 / RD-JT52 display size chart (4:3 aspect ratio)

Distance from screen		Diagonal measurement			
		Minimum zoom		Maximum zoom	
feet	inches	feet	inches	feet	inches
6	72	3.73	44.8	4.57	54.9
8	96	4.98	59.7	6.10	73.2
10	120	6.22	74.7	7.62	91.4
12	144	7.47	89.6	9.14	109.7
14	168	8.71	104.5	10.67	128.0
16	192	9.96	119.5	12.19	146.3
18	216	11.20	134.4	13.72	164.6
20	240	12.45	149.4	15.24	182.9
22	264	13.69	164.3	16.76	201.2
24	288	14.94	179.2	18.29	219.5

Distance from screen		Diagonal measurement			
		Minimum zoom		Maximum zoom	
meters	cm	meters	cm	meters	cm
1.5	150	0.93	93.3	1.14	114.3
2.0	200	1.24	124.5	1.52	152.4
2.5	250	1.56	155.6	1.91	190.5
3.0	300	1.87	186.7	2.29	228.6
3.5	350	2.18	217.8	2.67	266.7
4.0	400	2.49	248.9	3.05	304.8
4.5	450	2.80	280.0	3.43	342.9
5.0	500	3.11	311.2	3.81	381.0
5.5	550	3.42	342.3	4.19	419.1
6.0	600	3.73	373.4	4.57	457.2

RD-JT50 / RD-JT52 (XGA) screen size chart (16:9 aspect ratio)

Distance from screen		Diagonal measurement			
		Minimum zoom		Maximum zoom	
feet	inches	feet	inches	feet	inches
6	72	3.44	41.3	4.20	50.4
8	96	4.59	55.1	5.60	67.2
10	120	5.74	68.8	7.00	84.0
12	144	6.88	82.6	8.40	100.8
14	168	8.03	96.4	9.80	117.6
16	192	9.18	110.1	11.20	134.4
18	216	10.32	123.9	12.60	151.2
20	240	11.47	137.7	14.00	167.9
22	264	12.62	151.4	15.39	184.7
24	288	13.77	165.2	16.79	201.5

Distance from screen		Diagonal measurement			
		Minimum zoom		Maximum zoom	
meters	cm	meters	cm	meters	cm
1.5	150	0.86	86.0	1.05	105.0
2.0	200	1.15	114.7	1.40	140.0
2.5	250	1.43	143.4	1.75	179.4
3.0	300	1.72	172.1	2.10	209.9
3.5	350	2.01	200.8	2.45	244.9
4.0	400	2.29	229.4	2.80	279.9
4.5	450	2.58	258.1	3.15	314.9
5.0	500	2.87	286.8	3.50	349.9
5.5	550	3.15	315.5	3.85	384.9
6.0	600	3.44	344.1	4.20	419.9

 There is 3% ~ 5% tolerance among these numbers due to optical component limits.

* 1m = 3.28 feet, 1 foot = 0.305m, 1m = 100cm, 1 foot = 12 inches

Connecting to Various Equipment

HDTV description

The projector is capable of displaying various High Definition TV display modes. Some of these sources are:

- Digital-VHS (D-VHS) player
- DVD player
- Satellite Dish HDTV receiver
- DTV tuners

Most of these sources will provide an analog composite video output, a standard VGA output, or a YPbPr (default) format.

The projector is capable of accepting HDTV data through a YPbPr connector. Use a HDTV cable that came with your projector to display HDTV images.

The following standards are supported in the HDTV function:

- 480i
- 480p
- 576i
- 576p
- 720p
- 1080i

Please refer to "Menu System" on page 17 for information on the HDTV (YPbPr) OSD selections.

Connecting to Various Equipment

It only takes a few seconds to connect your projector to your desktop or notebook computer, VCR, or other systems. However, a Mac adapter (an optional accessory) is needed for connection to Macintosh computers.

Connecting to Various Equipment

It only takes a few seconds to connect your projector to your desktop or notebook computer, VCR, or other systems. However, a Mac adapter (an optional accessory) is needed for connection to Macintosh computers.

1. Notebook/ Computer (Macintosh computer is only supported with D-Sub IN connector.)

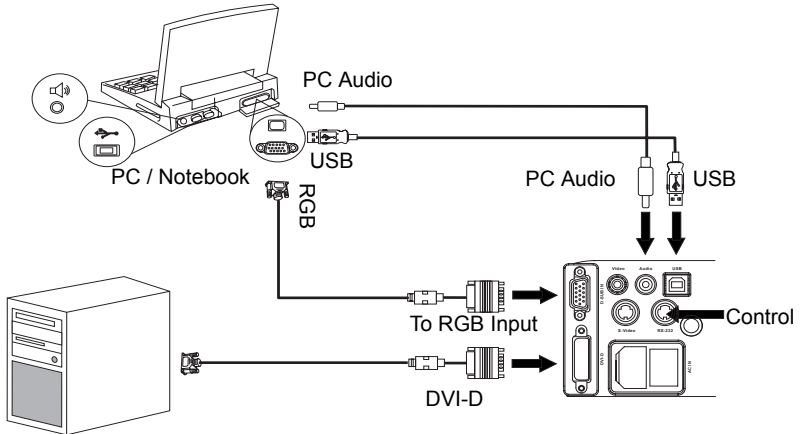

The USB cable is not needed unless you have a remote control with mouse functions.

2. DVD player or HDTV signal can only support D-SUB IN.

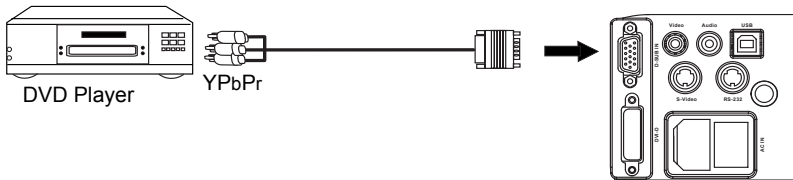

3. S-video device

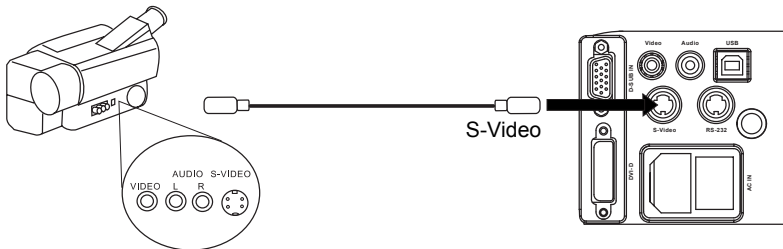

4. Video device or VCR

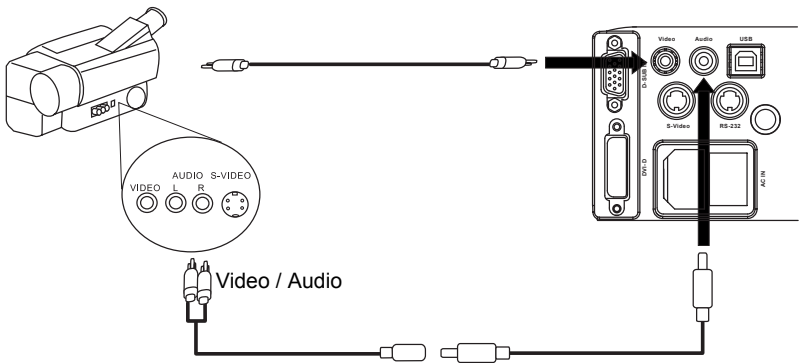

OPERATION

Start Up

1. Plug the power cord into a wall socket.

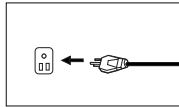

(110V)

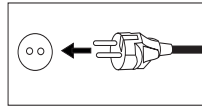

(220V)

2. Turn the Main Power Switch on.

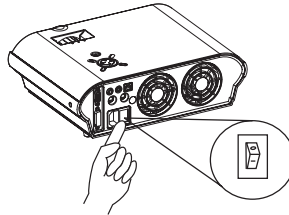

3. Press and hold **POWER** to start the unit. The Power Indicator flashes green and stays green when the power is turned on.

Projector

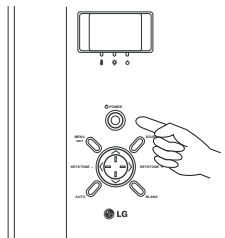

Remote Control

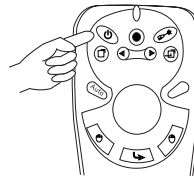

(When the power is turned off, there is a 90-second cooling period before the projector can be re-started.)

4. Switch on all connected equipment.

Digital Keystone Correction

Keystoning refers to the situation where the projected image is noticeably wider at either the top or bottom. To correct this, press **KEYSTONE** ◀ / ▶ (hot key) on the remote control, and then adjust the sliding bar labeled Keystone, as needed. Press ◀ to correct keystoning at the top of the image. Press ▶ to correct keystoning at the bottom of the image.

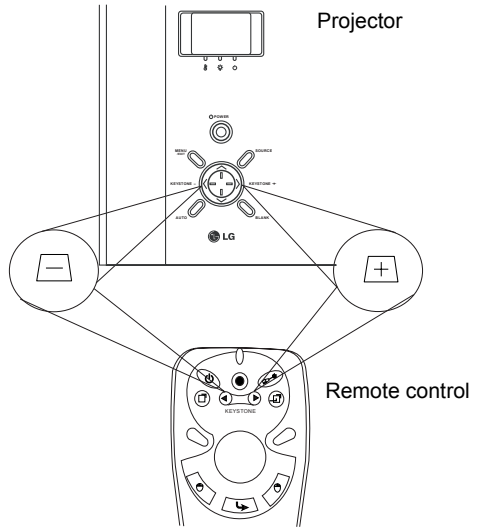

Auto Adjustment

In some cases, you may need to optimize the picture quality. To do this, press the **AUTO** key on the control panel of the projector or on the remote control. The built-in Intelligent Auto Adjustment function will re-adjust settings to provide the best picture quality.

**This function is available only in Analog RGB mode.*

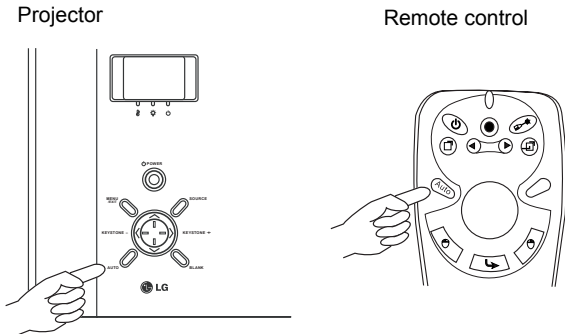

Source Selection

When several input sources are available, press the **SOURCE** key to make a selection from the control panel of the projector or the remote control.

 Because Analog RGB and YPbPr inputs share the same terminal in the back of the projector, there's only one signal can be applied at one time.

Projector

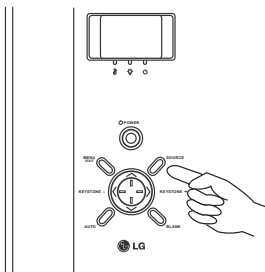

Remote control



Blank

Uses **BLANK** to hide the screen image and press **BLANK** again or **RETURN** to bring the image back.

Projector

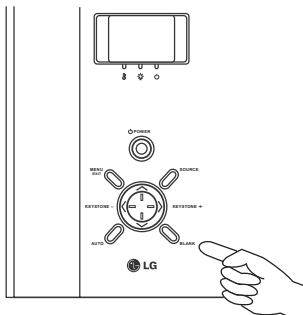

Remote control







Menu System

To use the **MENU** button on the remote control:







1. Press **MENU** to display the main OSD menu.
2. Press ◀ or ▶ to select a sub-menu.
3. Press **MENU** again to select items in the sub-menu.
4. Press ◀ or ▶ to adjust / select items.
5. Press EXIT to return to the previous menu.

To use the **MENU / EXIT** button on the projector control panel:

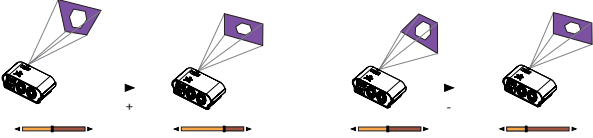
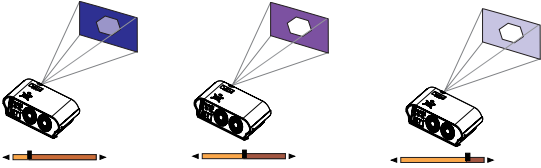
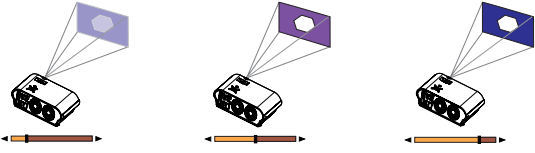







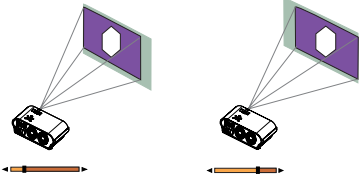

1. Press **MENU / EXIT** to display the main OSD menu.
2. Press < or > to select a sub-menu.
3. Press **v (DOWN)** to select items in the sub-menu.
4. Press <, >, ^ or V to adjust / select items.
5. Press MENU/ EXIT to return to the previous menu. :

Menu Bar					
Sub-menu	Display	Image	Source	Control	PIP
Analog RGB	Keystone Brightness Contrast Phase H Size	Auto Resize H Position V Position Color Temp Information	Mirror Source Volume Mute	Main Page: Language OSD: Setup Economic Mode Reset Lamp Hour OSD Sub Page: OSD Pos. OSD Time Set Up Sub Page: Source Scan Keystone Hold Mirror Hold Blank Time Auto Off User Logo	Main Page: PIP Source PIP Size PIP Pos. H Position V Position More Options Sub Page: Brightness Contrast Color Tint Sharpness System
DVI		Ratio H Position V Position Color Tint Color Temp			
Y/Pb/Pr (480p / 576p / 720p / 1080i)		Ratio System Color Temp Information			
Y/Pb/Pr (480i / 576i)		Ratio System Color Temp Information			
Video		Ratio System Sharpness Color Temp Information			
S-Video	Keystone Brightness Contrast Color Tint	Ratio System Sharpness Color Temp Information			

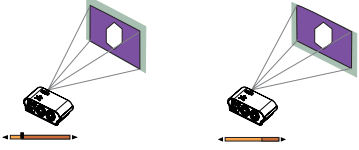



1. Display Menu

FUNCTION	DESCRIPTION
Keystone	Corrects any keystone of the image. 
Brightness	Adjusts the brightness of the image. 
Contrast	Adjusts the degree of difference between dark and light in the image. 
Phase	Adjusts to avoid the occurrence of flicker.   This function is not available when the input mode is Video, S-Video, DVI or YPbPr 480i / 576i.
H Size	Adjusts to fit in the desired image size.  This function is not available when the input mode is Video, S-Video, DVI or YPbPr 480i / 576i.
Color	Increases or decreases the color range (R, G, B) of the image.  This function is not available when the input mode is Analog RGB, DVI or YPbPr.
Tint	Adjusts the image to make it appear more red or green.  This function is not available when the input mode is Analog RGB, DVI or YPbPr and the input system is PAL or SECAM.

2. Image Menu

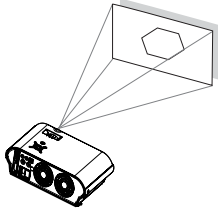
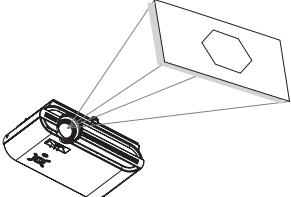
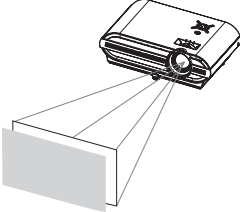
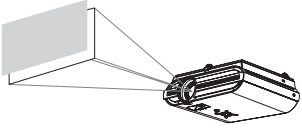
FUNCTION	DESCRIPTION
Auto Resize	<p>Makes the best fit of the image to the screen, 1. On 2. Off 3. 16:9</p> <p> This function is available only when the input mode is Analog RGB and DVI.</p>
Ratio	<p>Users have 2 options for the image ratio. 1. 4 : 3 2. 16 : 9</p> <p> This function is available when the input mode is YPbPr, Video or S-Video.</p>
H Position	<p>Adjusts the horizontal position of the projected image.</p> <div style="text-align: center;">  </div> <p> This function is available only when the input mode is Analog RGB.</p>
V Position	<p>Adjusts the vertical position of the projected image.</p> <div style="text-align: center;">  </div> <p> This function is available only when the input mode is Analog RGB.</p>
Color Temp	Adjusts the color temperature to fit your preference.
Information	Shows the current resolution.
System	<p>System information will be shown: 1.NTSC 2. PAL 3.SECAM</p> <p> The input System cannot be changed by selection.</p>
Sharpness	<p>Adjusts the image to make it look sharper or softer.</p> <p> This function is not available when the input mode is Analog RGB, DVI or YPbPr.</p>
Color	<p>Increases or decreases the color range (R, G, B) of the image.</p> <p> This function is available only when the input mode is YPbPr.</p>
Tint	<p>Adjusts the image to make it appear more red or green.</p> <p> This function is not available when the selected System is PAL.</p>

3. Source Menu



FUNCTION	DESCRIPTION	
<p>Mirror</p>	<p>1. Default</p>	<p>2. Ceiling mounted projection</p>
		
	<p>3. Rear screen projection</p> 	<p>4. Ceiling mounted and rear-screen projection</p> 
	<p>Source</p> <p>Shows the input source from among RGB, DVI, YPbPr, S-Video and Composite Video when several sources are available.</p> <p> The input Source cannot be changed by selection.</p>	
<p>Volume</p>	<p>Adjusts the volume level.</p> 	
<p>Mute</p>	<p>Off On</p>  	

4. Control Menu

FUNCTION	DESCRIPTION
Language	Language sets the language for the OSD control menus. Use the ◀ / ▶ key to select the desired language from among English, French, German, Italian, Spanish, Korean, Traditional Chinese and Simplified Chinese.
OSD	OSD Pos. Selects a desired OSD position.
	OSD Time Sets the length of time the OSD will remain active after the last time you pressed the button. The range is from 5 to 60 seconds in 5-second increments.
Setup	Source Scan When svelected, activates the Source scan function.
	Keystone Hold When selected, preserves the last keystone correction value even when the projector is restarted.
	Mirror Hold When selected, preserves the last mirror correction value even when the projector is restarted.
	Blank Time Determines the length of time before the projector is shut off when Blank is activated.
	Auto Off Sets the length of time before the system is shut off when no input is detected.
	User Logo Enables the user to define his/her own logo screen that will display during strat-up. Three modes are available: Default (LG logo), black screen and blue screen.
Economic Mode	Selects Economic mode to lower brightness and extend the lamp life.
Reset	Returns all settings to their factory preset values.
Lamp Hour	Shows lamp usage time.

5. PIP Menu

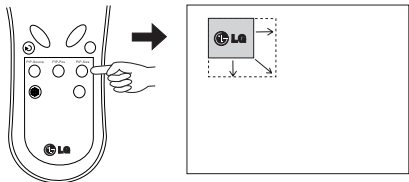
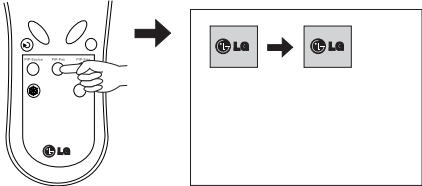
These functions are available only when the input mode is Analog RGB and the PIP source is Video or S-Video.

FUNCTION	DESCRIPTION
PIP Source	Selects the source for the PIP.
PIP Size	<p>Enables use of the ◀ / ▶ key to scroll through the four alternatives: Off, Small, Medium, Large.</p> 
PIP Position	<p>Selects a desired position for the PIP.</p> 
H Position	Adjusts the horizontal position of the PIP image.
V Position	Adjusts the vertical position of the PIP image.
More Options	Enables use of the ◀ / ▶ key to select more PIP functions including Brightness, Contrast, Color, Tint, Sharpness and System.
Brightness	Adjusts the brightness of the PIP image.
Contrast	Adjusts the degree of difference between dark and light for the PIP image.
Color	Increases or decreases the color range (R, G, B) of the image.
Tint	Adjusts the image to make it appear more red or green.
Sharpness	Adjusts the image to make it appear sharper or softer.
System	<p>Shows PIP image systems: NTSC, PAL, SECAM.</p>  The input System cannot be changed by selection.

Shutdown

1. Press and hold **POWER** and a warning message will appear. To turn off the projector, press and hold **POWER** again.

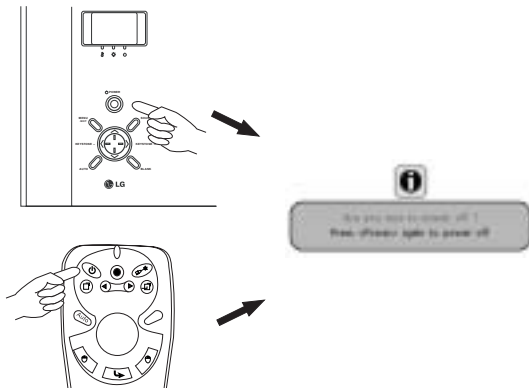

2. The fan will continue to run for approximately 90 seconds.
3. Turn off the main power switch.

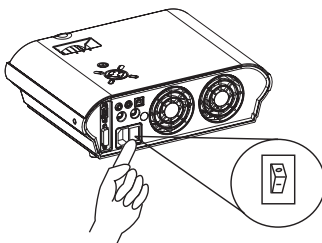

* After the projector is turned off, there is a 90-second cooling period before the projector can be re-started.

4. Disconnect the power cord from the wall socket.

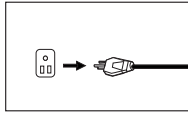

(110V)

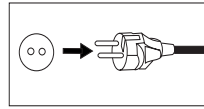

(220V)

⚠ Caution

- Please do not unplug the power cord before **POWER** is shut down or during the two-minute cooling process.
 - If the projector is not properly shut down, to protect the lamp, the system will detect this and cool the lamp for 90 seconds automatically before turning on again.
-

MAINTENANCE

Lamp Information

Use and Replacement of the Lamp

The lamp life is 1500 hours. When the Lamp Indicator lights up orange suggesting the time of lamp replacement, please install a new lamp or consult your dealer. An old lamp could cause a malfunction in the projector and in rare instances may even explode.

Lamp Replacement

Please check with LG service center for the information of lamp replacement.



Caution

HIGH VOLTAGE/ HIGH TEMPERATURE/ HIGH PRESS

WHEN REPLACING THE LAMP, TURN OFF THE PROJECTOR AND PULL OUT THE CORD FROM THE RECEPTACLE BEFORE REPLACING THE LAMP.

WAIT UNTIL THE LAMP BECOMES COOL (MINIMUM 45 MINUTES).

TOUCHING THE LAMP WHEN IT IS HOT MAY CAUSE A BURN ON YOUR HAND.

A HIGH-PRESSURE LAMP WHICH WHEN HOT, MAY EXPLODE IF IMPROPERLY HANDLED.

To reduce the risk of injuries to fingers and damage to internal components, use caution when removing lamp glass that has shattered into sharp pieces.

To reduce the risk of injuries to fingers and/or compromising image quality by touching the lens, do not touch the empty lamp compartment when the lamp is removed.

This lamp contains mercury. Consult your local hazardous waste regulations to dispose of this lamp in a proper manner.

Operative Information

When the three LEDs light up, they indicate the power, lamp or internal temperature status or possible problems:

LED Indicator	LEDs Display	Description
Power Indicator	Orange	Standby (The AC power switch is on, and the projector is off.)
	Blinking Green	When the power button is pressed, the indicator blinks green until the LG logo shows up.
	Green	The projector is working,
	Blinking Orange	POWER-DOWN. It will cool down for 90 seconds after the power is turned off.
	-	Off (The AC power switch is off.)
Lamp Indicator	Orange	The lamp has been in operation for over 1400 hours. The OSD message "CHANGE LAMP, AND RESET LAMP TIMER." will be displayed on the screen for 30 seconds.
	Red	The lamp has been in operation for over 1500 hours. The OSD message "OUT OF LAMP USAGE TIME. CHANGE THE LAMP!" will be displayed on the screen for 30 seconds.
	Blinking Red	Something is wrong with the lamp power supply. Please turn off the projector within 3 seconds.
Temperature Indicator	Red	The internal temperature of the projector is too hot. When the temperature inside the projector is too high, the OSD message "Temperature is too high. Going to shut down." will be displayed on the screen for 10 seconds and then the projector will automatically shutdown. The fans will be continuing to run for 90 seconds, then you can restart the projector.
	Blinking Red	Something is wrong with the fans. The OSD message "Fan or Diode error. Going to shut down." will be displayed on the screen for 10 seconds, and then the projector will automatically shutdown. Please turn the projector off.

TROUBLESHOOTING

Common Problems & Solutions

? NO POWER

☞ Try these solutions:

- Make sure the power cord is inserted snugged into the AC adapter socket.
- Make sure the power cord is inserted snugged into the power outlet.
- Toggle the power switch to the position “1”.
- Wait 90 seconds after the projector is turned off before turning the projector back on.

? NO PICTURE

☞ Try these solutions:

- Check for the proper input source.
- Ensure all cables are connected properly.
- Adjust the brightness and contrast.
- Remove the lens cap.

? TRAPEZOID IMAGE ON THE SCREEN

☞ Try these solutions:

- Reposition the unit to improve its angle on the screen.
- Use the **KEYSTONE** correction key on the control panel of the projector or the remote control unit.

? POOR COLOR

☞ Try these solutions:

- Select the correct video system.
- Adjust brightness, contrast, or color.

? BLURRED IMAGE

☞ Try these solutions:

- Press **AUTO** on the control panel of the projector or the remote control unit to get better picture quality.
- Adjust the focus.
- Reposition the unit to improve its projection angle.
- Ensure the distance between the unit and screen is within the adjustment range of the lens.

? REMOTE CONTROL DOES NOT WORK

☞ Try these solutions:

- Replace the batteries with new ones.
- Make sure there is no obstacle between the remote control and the projector.
- Stand within 6 meters (19.5 feet) of the projector.
- Make sure nothing is blocking the front and rear receivers.

Status Messages

On-Screen Messages	Description
SEARCHING	Projector is searching for input.
ACQUIRING SIGNAL	Projector has identified the input signal and is running the auto image adjustment function.
OUT OF RANGE	Input signal frequency exceeds the projector's range.
LAMP WARNING - CHANGE LAMP AND RESET LAMP TIMER!	The lamp has been in operation for 1400 hours. Install a new lamp for optimal performance.
OUT OF LAMP USAGE TIME. CHANGE THE LAMP!	The lamp has been in operation for over 1500 hours. The warning message will display for 30 seconds.

SPECIFICATIONS

Projector Specifications

Technical Specifications

Note: All specifications are subject to change without notice.

General

Product name	Personal Projector
Model name	RDJT50 1024X768 XGA
	RDJT52 1024X768 XGA

Optical

Display system	1-CHIP DMD
Lens F/Number	F/2.6
Lamp	250W UHP lamp

Electrical

Power supply	AC100 ~ 240V, 4.0A, 50/60 Hz (Automatic)
Power consumption	330W (Typical)

Mechanical

Dimensions	302.3 mm (W) x 91.7 mm (H) x 216.3 mm (D)
Operating temperature range	0°C ~ 35°C
Weight	6.6 lbs (3.0 Kg)

Input terminal

Computer input	
D-SUB IN	D-sub 15-pin (female)
DVI-D	DVI-D 19-pin (female)
Video signal input	
S-VIDEO	Mini DIN 4-pin port x1
VIDEO	RCA jack x1
HDTV signal input	D-sub <--> YPbPr RCA jack x3, through D-SUB IN terminal
Audio signal input	
Audio	Mini jack stereo port

Output

USB mouse connector	A/B series x1
Speaker	2 watt x 1

Control

RS-232C	9-pin x1
---------	----------

Timing Chart

Supported timing for Analog RGB and DVI inputs

Resolution	Horizontal Frequency (kHz)	Vertical Frequency (Hz)	Pixel Frequency (MHz)	Mode
720x400	37.927	85.039	35.500	720x400_85
640x480	31.469	59.940	25.175	VGA_60
	37.861	72.809	31.500	VGA_72
	37.500	75.000	31.500	VGA_75
	43.269	85.008	36.000	VGA_85
800x600	35.156	56.250	36.000	SVGA_56
	37.879	60.317	40.000	SVGA_60
	48.077	72.188	50.000	SVGA_72
	46.875	75.000	49.500	SVGA_75
	53.674	85.061	56.250	SVGA_85
832x624	49.725	74.550	57.283	MAC16"
1024x768	35.522	86.957	44.900	XGA_43i
	48.363	60.004	65.000	XGA_60
	56.476	70.069	75.000	XGA_70
	60.023	75.029	78.750	XGA_75
	68.667	84.997	94.500	XGA_85
	60.134	74.700	79.857	MAC19"
1152x864	67.500	75.000	108.000	SXGA1_75
1280x960	60.000	60.000	108.000	QuadVGA_60
1280x1024	63.981	60.020	108.000	SXGA3_60

Supported timing for YPbPr input

Signal Format	Horizontal Frequency (kHz)	Vertical Frequency (Hz)
480i(525i)@60Hz	15.73	59.94
480p(525p)@60Hz	31.47	59.94
576i(625i)@50Hz	15.63	50.00
576p(625p)@50Hz	31.25	50.00
720p(750p)@60Hz	45.00	60.00
720p(750p)@50Hz	37.50	50.00
1080i(1125i)@60Hz	33.75	60.00
1080i(1125i)@50Hz	28.13	50.00

Supported timing for Video and S-Video inputs

Video mode	Horizontal Frequency (kHz)	Vertical Frequency (Hz)	Pixel Frequency (MHz)
NTSC	15.73	60	3.58
PAL	15.63	50	4.43
SECAM	15.63	50	4.25 or 4.41
PAL-M	15.73	60	3.58
PAL-N	15.63	50	3.58
PAL-60	15.73	60	4.43
NTSC4.43	15.73	60	4.43

DIMENSIONS

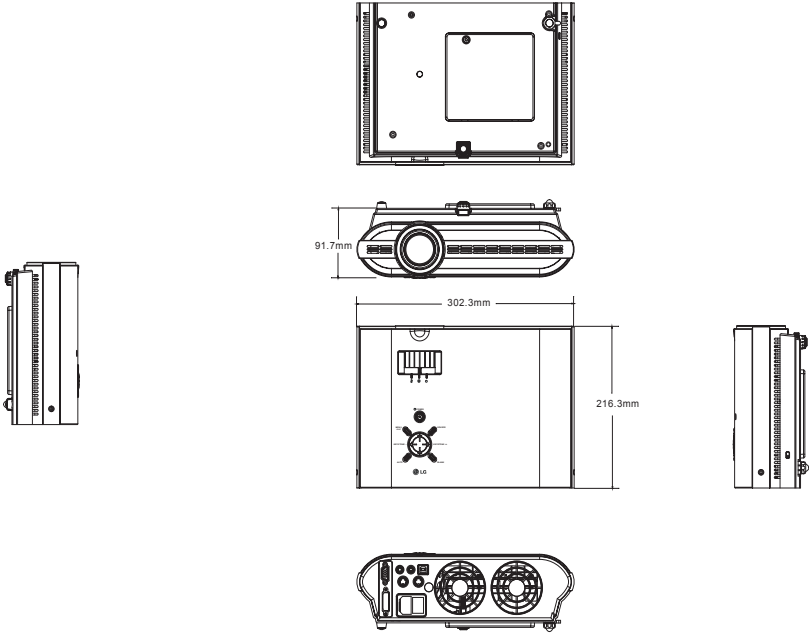

Unit: mm

Free Manuals Download Website

<http://myh66.com>

<http://usermanuals.us>

<http://www.somanuals.com>

<http://www.4manuals.cc>

<http://www.manual-lib.com>

<http://www.404manual.com>

<http://www.luxmanual.com>

<http://aubethermostatmanual.com>

Golf course search by state

<http://golfingnear.com>

Email search by domain

<http://emailbydomain.com>

Auto manuals search

<http://auto.somanuals.com>

TV manuals search

<http://tv.somanuals.com>