

DLP PROJECTOR

USER'S GUIDE

Thank you for purchasing the DLP Projector.

Please read this user's guide to ensure correct use of the device. Save this user's guide for future reference.

OUTLINE

This DLP Projector can display various computer signals and NTSC/PAL/SECAM video signals.

FEATURES

- 1. High Brightness**
- 2. High Resolution**
- 3. Compact Size, Feather Weight for Portability**
- 4. Durable Magnesium Alloy Body**
- 5. RGB input Terminal**
- 6. One Touch Auto-Adjustment Function**
- 7. Easy Keystone Adjustment**

Copyright

Copyright © 2002. All rights reserved. No part of this publication may be reproduced, transmitted, transcribed, stored in a retrieval system or translated into any language or computer language, in any form or by any means, electronic, mechanical, magnetic, optical, chemical, manual or otherwise, without the prior written permission of the company.

Disclaimer

The company makes no representations or warranties, either expressed or implied, with respect to the contents hereof and specifically disclaims any warranties, merchantability or fitness for any particular purpose. Furthermore, the company reserves the right to revise this publication and to make changes from time to time in the contents hereof without obligation of the company to notify any person of such revision or changes.

Table of Contents

Introduction	1
Safety Instructions	1
FCC Statement	2
Shipping Contents	3
Optional Accessories	3
Projector Description	4
Projector	4
External Control Panel	5
Adjuster	6
Projector Features	6
Remote Control Description	7
Installing or Replacing Batteries	8
Installation	9
Screen Size	9
Connecting to Various Equipment	9
Operation	11
Start Up	11
Digital Keystone Correction	12
Auto Adjustment	12
Source Selection	13
Menu System	13
1. Display Menu	14
2. Image Menu	15
3. Source Menu	16
4. Control Menu	17
5. PIP Menu	18
Shutdown	19
Maintenance	20
Lamp Information	20
Use and Replacement of the Lamp	20
Lamp LED Indicators	20
Lamp Replacement	20
Temp Information	21
Troubleshooting	22
Status Messages	23
Specifications	24
Projector Specifications	24
Timing Chart	25
Dimensions	26



INTRODUCTION

Caution

TO PREVENT SHOCK, DO NOT OPEN THE CABINET. NO USER –SERVICEABLE PARTS INSIDE. REFER SERVICING TO QUALIFIED SERVICE PERSONNEL. PLEASE READ THIS USER’S GUIDE BEFORE YOU OPERATE YOUR PROJECTOR. SAVE THIS USER’S GUIDE FOR FUTURE REFERENCE .

Safety Instructions

1. Read this user’s guide before you operate your projector and save it for future reference.
2. The lamp becomes extremely hot during operation. Allow the projector to cool for approximately 45 minutes prior to removing the lamp assembly for replacement. Do not operate lamps beyond the rated lamp life. Excessive operation of lamps beyond the rated life could cause them to explode on rare occasions.
3. Never replace the lamp assembly or any electronic components unless the projector is unplugged.
4. To reduce the risk of electric shock, do not disassemble this appliance. Take it to a qualified technician when service or repair is required. Incorrect reassembly can cause electric shock when the appliance is subsequently used.
5. Do not place this product on an unstable cart, stand, or table. The product may fall, sustaining serious damage.
6. This product is capable of displaying inverted images for ceiling mount installation. Please use suitable equipment for mounting the unit and ensure it is securely installed.

Caution

- **Always open the lens shutter or remove the lens cap when the projector lamp is on.**
- **Do not look straight at the projector lens during operation. The intense light beam may damage your eyes.**
- **In some countries, the line voltage is NOT stable. This projector is designed to operate safely within a bandwidth of 110 to 230 volts, but could fail if power cuts or surges of more than 10 volts occur. In these high-risk areas, it is recommended that a power stabilizer unit be used in conjunction with this projector.**
- **Do not place this projector on the top of cloth or carpet.**

- **Do not touch the ventilation grill when the projector is under operation.**
-

Save this user's guide: The information contained in this manual will assist you in operating and maintaining your personal projector.

FCC Statement

FCC STATEMENT - CLASS A: This equipment generates, uses and can radiate radio frequency energy, and if not installed and used in accordance with the instruction manual, may cause interference to radio communications. It has been tested and found to comply with the limits for a Class "A" computing device pursuant to Subpart B of Part 15 of the FCC Rules, which are designed to provide reasonable protection against such interference when operated in a commercial environment. Operation of this equipment in a residential area is likely to cause interference, in which case the user at his/her own expense will be required to take whatever measures may be required to correct the interference.

FCC STATEMENT - CLASS B: This equipment generates, uses and can radiate radio frequency energy and, if not installed and used in accordance with the instructions, may cause harmful interference to radio communications. However, there is no guarantee that interference will not occur in a particular installation. If this equipment does cause harmful interference to radio or television reception, which can be determined by turning the equipment off and on, the user is encouraged to try to correct the interference by one or more of the following measures:

- Reorient or relocate the receiving antenna.
- Increase the distance between the equipment and receiver.
- Connect the equipment into an outlet on a circuit different from that to which the receiver is connected.
- Consult the dealer or an experienced radio/TV technician for help.

EEC STATEMENT: This machine was tested against the 89/336/EEC (European Economic Community) for EMC (Electro Magnetic Compatibility) and fulfills these requirements.

Shipping Contents

The Projector is shipped with the cables required for connection to standard PC or laptop computers. Carefully unpack and verify that you have all the items shown below. If any of these items are missing, please contact personnel at the place of purchase.

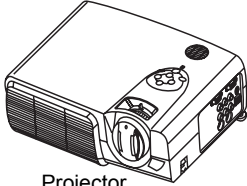

Projector



User's Guide



Quick Start Guide



Remote Control

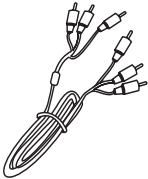

HDTV Cable



3-2 Converter



Batteries

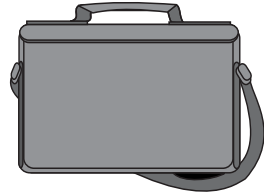

Deluxe Soft Carry Case

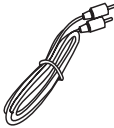

Audio Cable

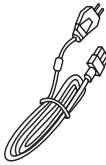

India Power (S.A)

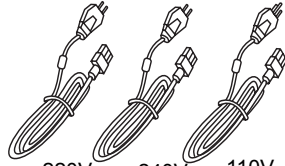

Power Cord

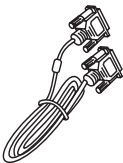

VGA Cable

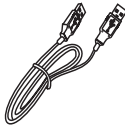

USB Cable

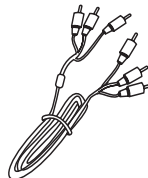

AV Cable

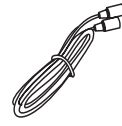

S-Video Cable

Optional Accessories

1. Macintosh adapter
2. 210W Lamp module

Projector Description

Projector

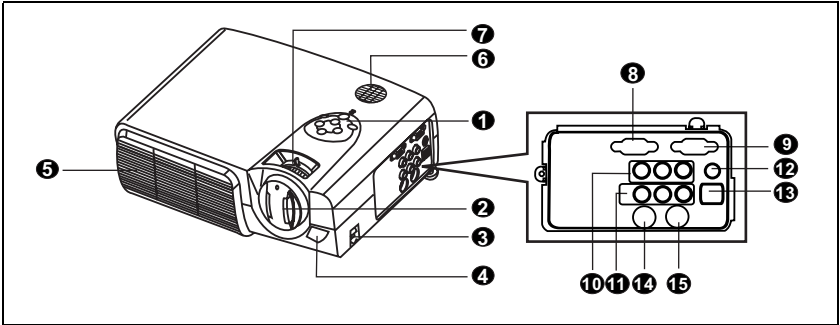

- | | |
|---|--------------------------|
| ① External control panel
(see next page) | ⑪ Audio/ Video connector |
| ② Projection lens | ⑫ Computer Audio IN |
| ③ Front adjuster | ⑬ USB mouse connector |
| ④ IR remote sensor | ⑭ S-Video jack |
| ⑤ Ventilation grill | ⑮ RS-232C control port |
| ⑥ Speaker | ⑯ Rear adjuster feet |
| ⑦ Projection lens adjuster | ⑰ Kensington lock |
| ⑧ Computer signal input | ⑱ AC power cord inlet |
| ⑨ Computer signal output | ⑲ Main power switch |
| ⑩ YPBPR connector | ⑳ Lamp door |

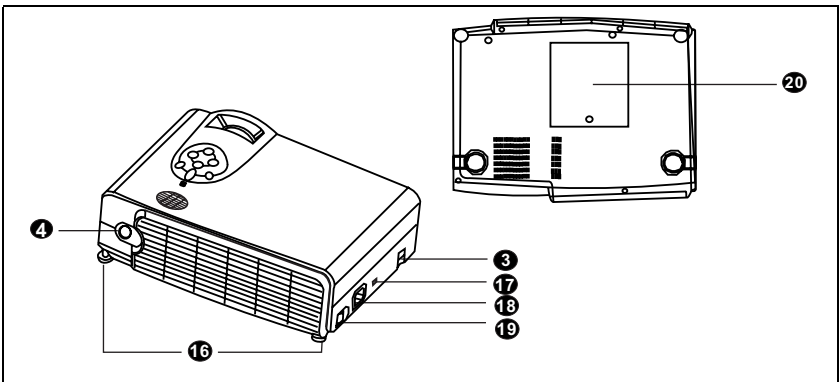

External Control Panel

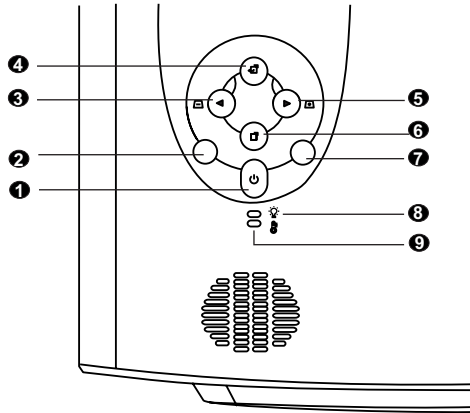

1 Power

Presses the **Power** key to turn the projector on or off.

2 Auto

Automatically determines the best picture settings for current received signals.

3 Left/ Keystone -

4 Exit

5 Right/ Keystone + **6 Menu**

Menu will display the menu system on screen. Press **Menu** again to access the sub-menus. **Left** and **Right** help you navigate among choices and settings in the menus and sub-menus. However, when the on-screen menu is not activated, the **Left** and **Right** buttons will function as **Keystone +/-** hot keys.

Press the **Exit** button to go back to the main menu. Press **Exit** again to leave the menu system.

7 Source

Selects signal sources from among PC, YPBPR, Video and S-Video.

8 Lamp Indicator

The Lamp Indicator will light up when the lamp needs service, cooling or replacement. See "Lamp Information" on page 20 for more detailed information.

9 Temp indicator

The Temp indicator will flash when the system temperature is too high, which may occur if the projector is operated improperly. See "Temp Information" on page 21 for more detailed information.

Adjuster

The projector is equipped with 2 quick-release adjuster feet. Push the buttons to adjust its tilt angle.

1. Lift the projector up and press the adjuster button to release the adjuster.
2. The adjuster will drop into position and be locked.

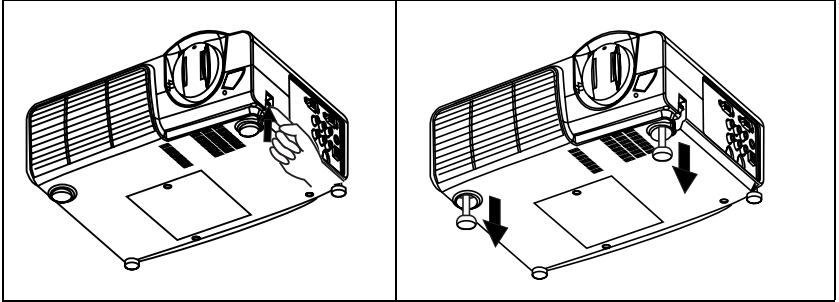

Projector Features

The projector integrates high-performance optical engine projection and a user-friendly design to deliver high reliability and ease of use.

The projector offers the following features:

- Small and light for portability
- Full-function remote control with laser pointer/ remote mouse function
- High quality manual zoom lens
- One-key auto-adjustment to display the best picture quality
- Easy digital keystone correction through hot keys to correct distorted images
- Adjustable color balance control for data/video display
- Ultra-high brightness projection lamp
- Ability to display 16.7 million colors
- On-screen menus in 10 languages: English, French, German, Italian, Spanish, Russian, Polish, Korean, Simplified Chinese, and Traditional Chinese.
- Switchable Normal/ Video mode for data/ video display
- Powerful AV function to provide high quality AV picture
- HDTV compatibility (YPbPr)

Note: The brightness of the projected image will vary depending on the ambient lighting conditions and contrast/brightness settings.

Remote Control Description

The remote control sensors are located in the front/ back of the projector. The distance between the sensor and the remote control should not exceed 6 meters.

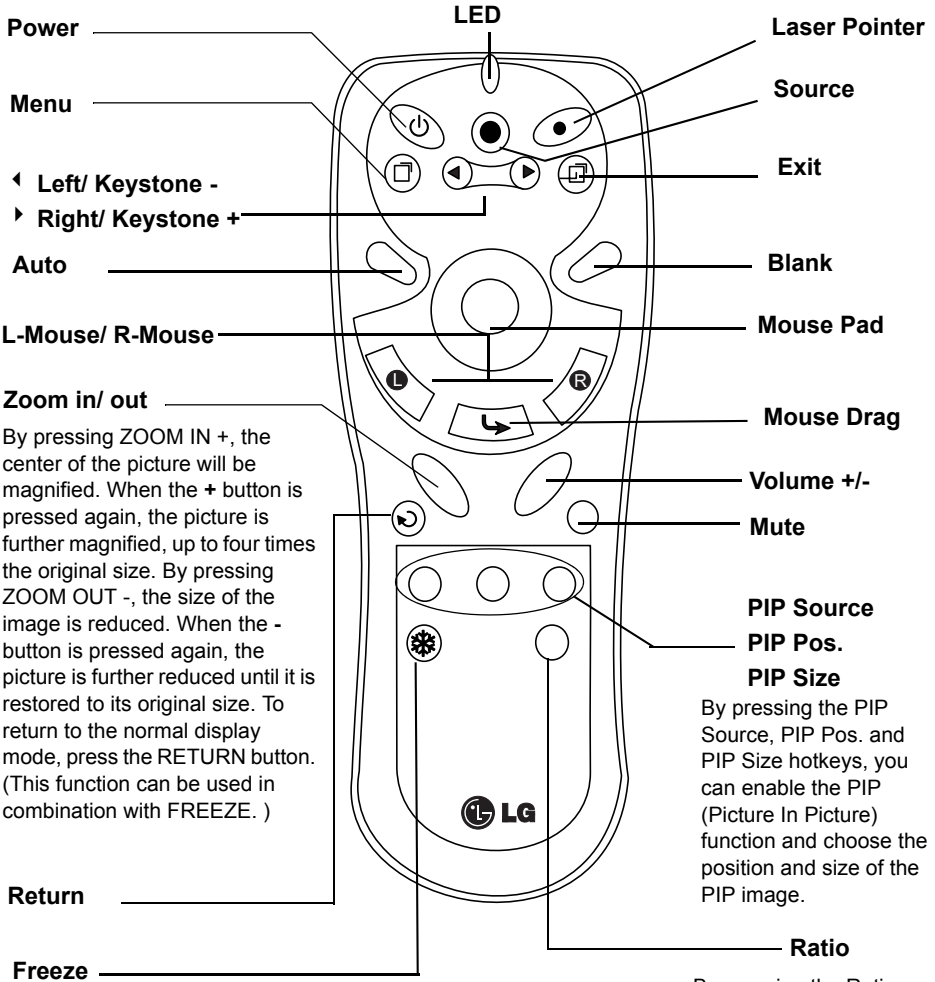

Zoom in/ out
 By pressing ZOOM IN +, the center of the picture will be magnified. When the + button is pressed again, the picture is further magnified, up to four times the original size. By pressing ZOOM OUT -, the size of the image is reduced. When the - button is pressed again, the picture is further reduced until it is restored to its original size. To return to the normal display mode, press the RETURN button. (This function can be used in combination with FREEZE.)

Return
Freeze

The image is frozen when FREEZE is pressed. A "Pause" icon will appear in the lower right corner of the screen. To stop the freeze function, press the FREEZE button, RETURN button or SOURCE button (when the input source is switched over during display) again.

PIP Source
PIP Pos.
PIP Size
 By pressing the PIP Source, PIP Pos. and PIP Size hotkeys, you can enable the PIP (Picture In Picture) function and choose the position and size of the PIP image.

Ratio
 By pressing the Ratio hotkey, you can select the screen aspect ratio you prefer: 4:3,16:9

Installing or Replacing Batteries

- 1 Push and slide the battery compartment lid in the direction

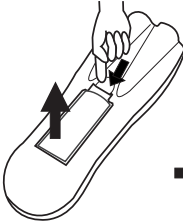

- 2 Install batteries as indicated by the diagram inside the compartment.

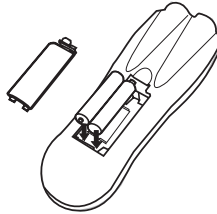

- 3 Position the lid over the compartment and snap it back into place.

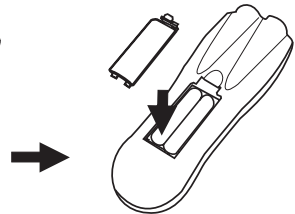

Caution

Avoid excessive heat and humidity. There may be danger of an explosion if batteries are incorrectly replaced. Replace only with the same or equivalent type recommended by the manufacturer. Dispose of used batteries according to the manufacturer's instructions.

INSTALLATION

Screen Size

Place the projector at the required distance from the screen according to the desired picture size (see the table below).

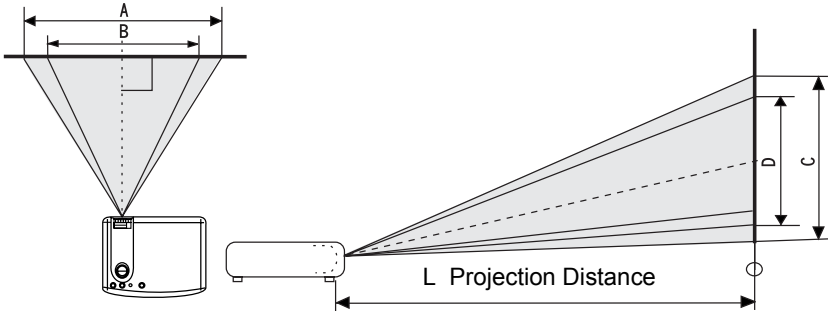

Screen Size (Max.)			L. Projection distance (cm)	Screen Size (Min.)		
Diagonal (in)	A. Width (cm)	C. Height (cm)		Diagonal (in)	B. Width (cm)	D. Height (cm)
30.4	61.8	46.3	100	24.9	50.7	38.0
60.8	123.7	92.7	200	49.9	101.3	76.0
91.2	185.3	138.9	300	74.7	151.9	113.9
121.5	247.0	185.2	400	99.7	202.5	151.9
151.9	308.7	231.6	500	124.6	253.2	189.9
182.3	370.5	277.9	600	149.5	303.8	227.9
212.8	432.2	324.2	700	174.6	354.4	266.2
243.1	494.0	370.5	800	199.4	405.1	303.8
273.5	555.7	416.7	900	224.3	455.7	341.8
303.9	617.5	463.1	1000	249.2	506.3	379.8

Connecting to Various Equipment

HDTV description

The projector is capable of displaying various High Definition TV display modes. Some of these sources are:

- Digital-VHS (D-VHS) player
- DVD player
- Satellite Dish HDTV receiver
- DTV tuners

Most of these sources will provide an analog component video output, a standard VGA output, or a YPBPR (default) format.

The projector is capable of accepting HDTV data through a YPBPR connector. Use a HDTV cable that came with your projector to display HDTV images.

The following standards are supported in the HDTV function:

- 480i
- 480p
- 720p
- 1080i

Please refer to "Menu System" on page 13 for information on the HDTV OSD selections.

Connecting to Various Equipment

It only takes a few seconds to connect your projector to your desktop or notebook computer, VCR, or other systems. However, a Mac adapter (an optional accessory) is needed for connection to Macintosh computers.

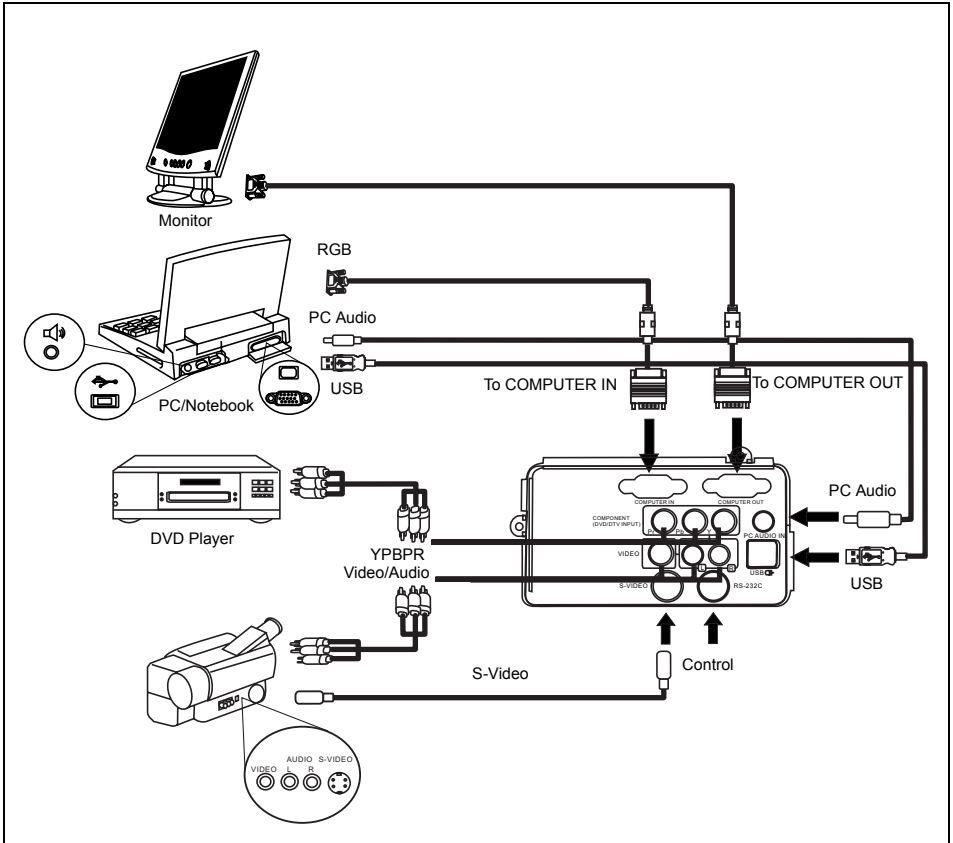

OPERATION

Start Up

1. Plug the power cord into a wall socket.

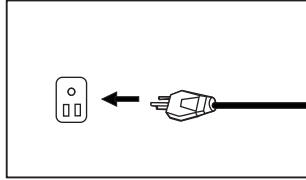

2. Turn on the main power switch.

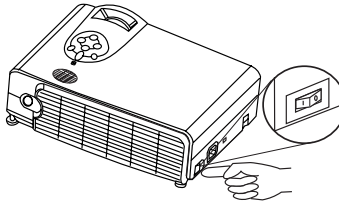

3. Press POWER to start the unit. The back-lit POWER key flashes green and stays green when the power is turned on.

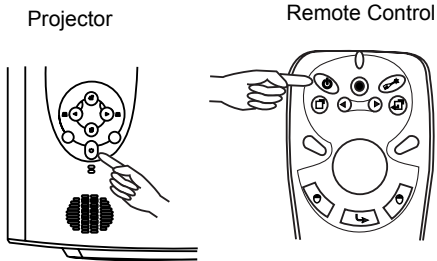

(When the power is turned off, there is a 120-second cooling period before the projector can be re-started.)

4. Switch on all connected equipment.

Digital Keystone Correction

Keystoning refers to the situation where the projected image is noticeably wider at either the top or bottom. To correct this, press **KEYSTONE +/-** (hot key) on the control panel of the projector or on the remote control, and then adjust the sliding bar labeled **Keystone**, as needed. Press **+** to correct keystoning at the top of the image. Press **-** to correct keystoning at the bottom of the image.

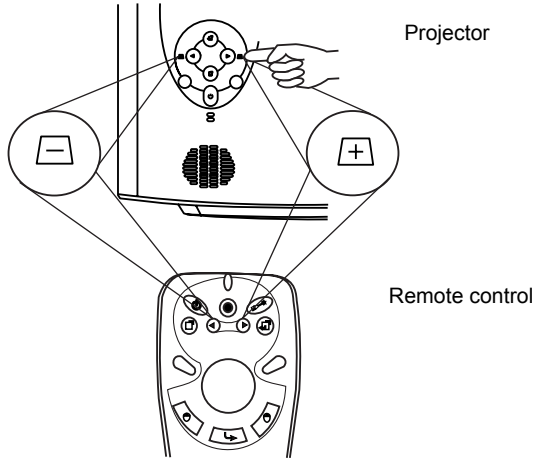

Auto Adjustment

In some cases, you may need to optimize the picture quality. To do this, press the **AUTO** key on the control panel of the projector or on the remote control. Within 3 seconds, the built-in Intelligent Auto Adjustment function will re-adjust settings to provide the best picture quality.

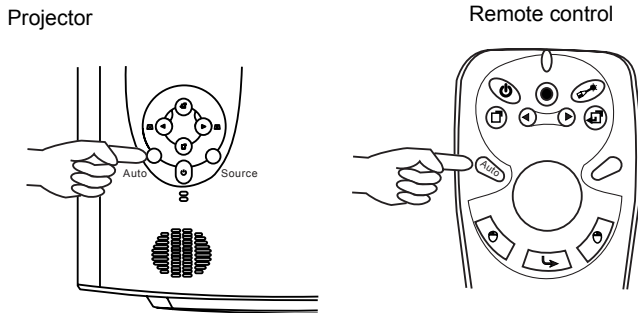

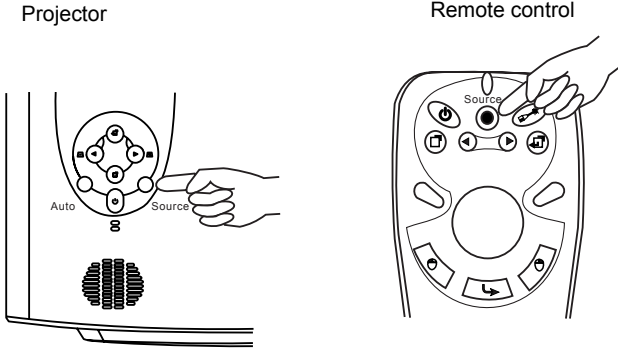

Source Selection

When several input sources are available, press the SOURCE key to make a selection from the control panel of the projector or the remote control.



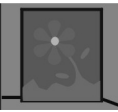
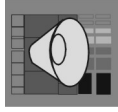
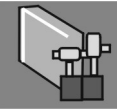

Menu System

Press **Menu** for the main menu, and then press ◀ or ▶ to select a sub-menu. Press **Menu** again to select items in the sub-menu.

Menu Bar						
Sub-menu	Display	Image	Source	Control	PIP	
PC	Keystone Brightness Contrast Phase H Size	Ratio H-position V-position Color Temp Information	Mirror Source Volume Treble Bass Mute	Language OSD Setup Default Video Mode Lamp hour	Main page: PIP Source PIP Size PIP Pos. H Position V Position More Options	
Y/Pb/Pr		Ratio H-position V-position Color Tint Color Temp				Sub Page: Brightness Contrast Color Tint Sharpness System
Video		Ratio System Sharpness Color Temp Information				

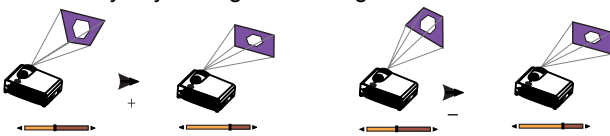
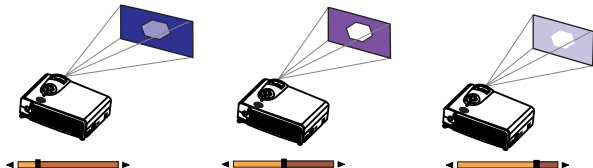
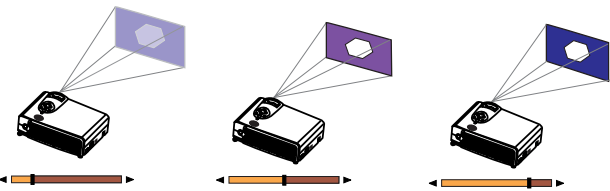



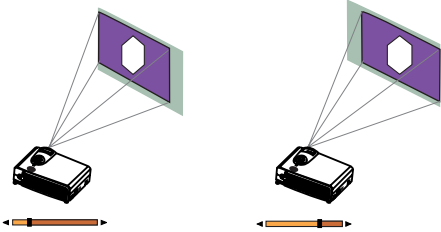
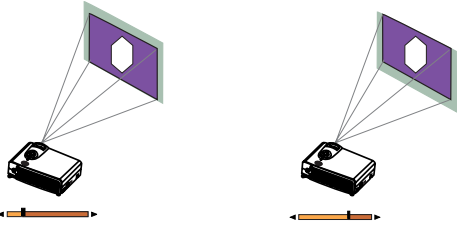

1. Display Menu

FUNCTION	DESCRIPTION
<p>Keystone</p>	<p>Corrects any keystoneing of the image.</p> 
<p>Brightness</p>	<p>Adjusts the brightness of the image.</p> 
<p>Contrast</p>	<p>Adjusts the degree of difference between dark and light in the image.</p> 
<p>Phase</p>	<p>Adjusts to avoid the occurrence of flicker.</p>  <p><i>*This function is not available when the input mode is Video or S-Video.</i></p>
<p>H Size</p>	<p>Adjusts to fit in the desired image size.</p> <p><i>*This function is not available when the input mode is Video or S-Video.</i></p>
<p>Color</p>	<p>Increases or decreases the color range (R, G, B) of the image.</p> <p><i>*This function is not available when the input mode is PC.</i></p>
<p>Tint</p>	<p>Adjusts the image to make it appear more red or blue.</p> <p><i>*This function is not available when the input mode is PC.</i></p>

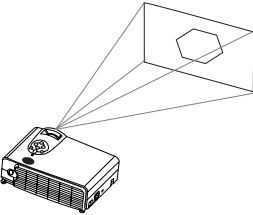
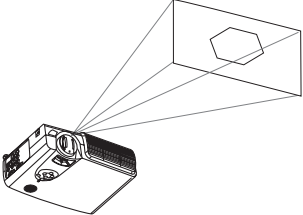
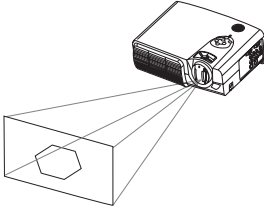
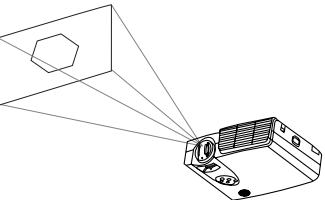
2. Image Menu

FUNCTION	DESCRIPTION
Ratio	Users have 2 options for the image ratio. 1. 4:3 2. 16:9
H Position	Adjusts the horizontal position of the projected image. 
V Position	Adjusts the vertical position of the projected image. 
Color Temp	Adjusts the color temperature to fit your preference.
Information	Shows the current resolution.
System	System information will be shown: 1.NTSC 2. PAL 3.SECAM <i>*The default setting for System is Auto.</i>
Sharpness	Adjusts the image to make it look sharper or softer. <i>*This function is not available when the input mode is PC or YPBPr.</i>
Color	Increases or decreases the color range (R, G, B) of the image. <i>*This function is not available when the input mode is PC.</i>
Tint	Adjusts the image to make it appear more red or blue. <i>*This function is not available when the input mode is PC.</i>

3. Source Menu

FUNCTION	DESCRIPTION	
Mirror	1. Default	2. Ceiling mounted projection
		
	3. Rear screen projection	4. Ceiling mounted and rear-screen projection
		
Source	Selects the input source from among PC, YPBPR, Video and S-Video.	
Volume	Adjusts the volume level. 	
Treble	Adjusts the treble level. 	
Bass	Adjusts the bass level. 	
Mute	Off 	On 

4. Control Menu

FUNCTION	DESCRIPTION
Language	Language sets the language for the OSD control menus. Use the ◀ / ▶ key to select the desired language from among English, French, German, Italian, Spanish, Russian, Polish, Korean, Simplified Chinese and Traditional Chinese.
OSD	OSD Pos. Selects a desired OSD position.
	OSD Time Sets the length of time the OSD will remain active after the last time you pressed the button. The range is from 5 to 60 seconds in 5-second increments.
Setup	Source Scan When selected, activates the Source scan function.
	Keystone hold When selected, preserves the last keystone correction value even when the projector is restarted.
	Mirror hold When selected, preserves the last mirror correction value even when the projector is restarted.
	Blank time Determines the length of time from 1 to 60 minutes before the projector is shut off when Blank is activated.
	Auto Off Sets the length of time from 1 to 60 minutes before the system is shut off when no input is detected.
	User logo Enables the user to define the logo screen that will display during start-up. Three modes are available: Default (LG logo), black screen and blue screen.
Default	Returns all settings to their factory preset values.
Video Mode	Selects video mode.
Lamp hour	Shows lamp usage time.

5. PIP Menu

These functions are available only when the input mode is PC and the PIP source is Video or S-Video.

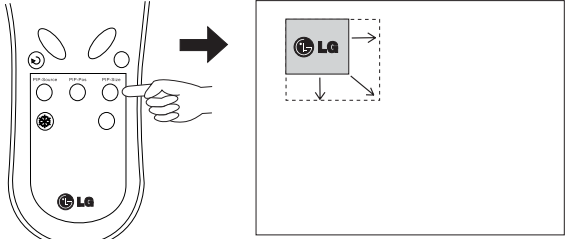
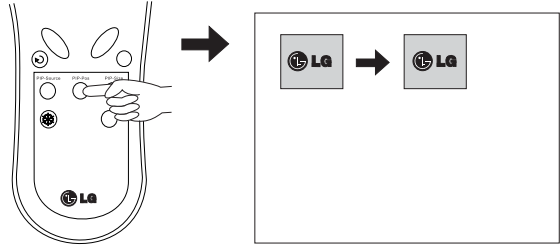
FUNCTION	DESCRIPTION
PIP Source	Selects the source for the PIP.
PIP Size	<p>Enables use of the ◀ / ▶ key to scroll through the four alternatives: Off, Small, Medium, Large.</p> 
PIP Position	<p>Selects a desired position for the PIP.</p> 
H. Position	Adjusts the horizontal position of the PIP image.
V. Position	Adjusts the vertical position of the PIP image.
More Options	Enables use of the ◀ / ▶ key to select more PIP functions including Brightness, Contrast, Color, Tint, Sharpness and System.
Brightness	Adjusts the brightness of the PIP image.
Contrast	Adjusts the degree of difference between dark and light for the PIP image.
Color	Increases or decreases the color range (R, G, B) of the image.
Tint	Adjusts the image to make it appear more red or blue.
Sharpness	Adjusts the image to make it appear sharper or softer
System	Selects PIP image systems: NTSC, PAL, SECAM

Shutdown

1. Press **POWER** and a warning message will appear. To turn off the projector, press **POWER** again.

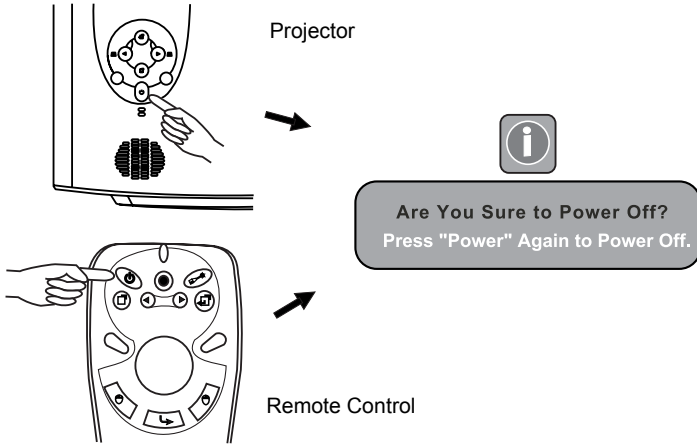

2. The fan will continue to run for approximately two minutes.
3. Turn off the ON/OFF switch.

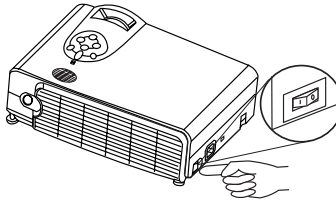

4. Disconnect the power cord from the wall socket.

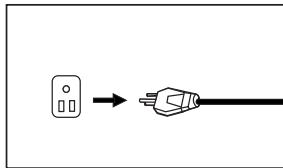

Caution

- Please do not unplug the power cord before **POWER** is shut down or during the two-minute cooling process.
- If the projector is not properly shut down, to protect the lamp, the system will detect this and cool the lamp for two minutes automatically before turning on again.

MAINTENANCE

Lamp Information

Use and Replacement of the Lamp

When the Lamp Indicator lights up red or a message appears suggesting the time of lamp replacement, please install a new lamp or consult your dealer. An old lamp could cause a malfunction in the projector and in rare instances may even explode.

Lamp LED Indicators

Lamp Life Indicators	When the LED lights up red, it is warning you that lamp usage has exceeded 1500 hours. Replace the projection lamp with a new one immediately.
The Lamp is not properly attached	LED lights up red.
Lamp temperature is too high	When the projector's internal temperature is too high for the projector to operate safely, the LED blinks orange and the lamp turns off automatically. The LED keeps blinking while the unit is off. If the LED light is off, the operation and temperature of the projector's lamp are normal.

Caution

The LAMP indicator will light up if the lamp becomes too hot. Turn off the power and let the projector cool for 45 minutes. If the LAMP indicator is still red when turning the power on, please contact your dealer.

Lamp Replacement

Please check with LG service center for the information of lamp replacement.

 **Caution**

To reduce the risk of severe burns, allow the projector to cool for at least 45 minutes before replacing the lamp.

To reduce the risk of injuries to fingers and damage to internal components, use caution when removing lamp glass that has shattered into sharp pieces.

To reduce the risk of injuries to fingers and/or compromising image quality by touching the lens, do not touch the empty lamp compartment when the lamp is removed.

This lamp contains mercury. Consult your local hazardous waste regulations to dispose of this lamp in a proper manner.

Temp Information

When the LED lights up, it is warning you of the following possible problems:

1. The internal temperature is too high.
2. The fans are not working.

Turn off the projector and contact qualified service personnel for further help.

TROUBLESHOOTING

Common Problems & Solutions

PROBLEMS	TRY THESE SOLUTIONS
NO POWER	<ul style="list-style-type: none">• Make sure the power cord is inserted snugly into the AC adapter socket.• Make sure the power cord is inserted snugly into the power outlet.• Toggle the power switch to the position "I".• Wait two minutes after the projector is turned off before turning the projector back on.
NO PICTURE	<ul style="list-style-type: none">• Check for the proper input source.• Ensure all cables are connected properly.• Adjust the brightness and contrast.• Remove the lens cap.
TRAPEZOID IMAGE ON THE SCREEN	<ul style="list-style-type: none">• Reposition the unit to improve its angle on the screen.• Use the Keystone correction key on the control panel of the projector or the remote control unit.
POOR COLOR	<ul style="list-style-type: none">• Select the correct video system.• Adjust brightness, contrast, or saturation.
BLURRED IMAGE	<ul style="list-style-type: none">• Press Auto on the control panel of the projector or the remote control unit to get better picture quality.• Adjust the focus.• Reposition the unit to improve its projection angle.• Ensure the distance between the unit and screen is within the adjustment range of the lens.
REMOTE CONTROL DOES NOT WORK	<ul style="list-style-type: none">• Replace the batteries with new ones.• Make sure there is no obstacle between the remote control and the projector.• Stand within 6 meters (20 feet) of the projector.• Make sure nothing is blocking the front and rear receivers.

Status Messages

On-Screen Messages	Description
SEARCHING	Projector is searching for input.
ACQUIRING SIGNAL	Projector has identified the input signal and is running the auto image adjustment function.
OUT OF RANGE	Input signal frequency exceeds the projector's range.
LAMP WARNING - CHANGE LAMP AND RESET LAMP TIMER!	The lamp has been in operation for 1400 hours. Install a new lamp for optimal performance.
OUT OF LAMP USAGE TIME. CHANGE THE LAMP!	The lamp has been in operation for 1480 hours, and the power will turn off after 20 hours.
OUT OF LAMP USAGE TIME. YOU HAVE TO CHANGE THE LAMP!	The lamp has been in operation for over 1500 hours. The warning message will display for 30 seconds every 5 minutes after you turn on the projector and the power will turn off automatically after 10 minutes.

SPECIFICATIONS

Projector Specifications

Technical Specifications

Note: All specifications are subject to change without notice.

General

Product name	Personal Projector
Model name	RD-JT40 1024X768 XGA
	RD-JT41 800X600 SVGA

Optical

Display system	1-CHIP DMD
Lens F/Number	F/2.6
Lamp	210W NSH lamp

Electrical

Power supply	AC100 ~ 240V, 3.5A, 50/60 Hz (Automatic)
Power consumption	330 W (Max)

Mechanical

Dimensions	308 mm (W) x 95 mm (H) x 238 mm (D)
Operating temperature range	0°C ~ 40°C
Weight	7 lbs (3.2 Kg)

Input terminal

Computer input	
RGB input	D-sub 15-pin (female)
Video signal input	
S-VIDEO	Mini DIN 4-pin port x1
VIDEO	RCA jack x1
HDTV signal input	YPBPR RCA jack x3
Audio signal input	
Audio 1	Mini jack stereo port
Audio 2	RCA jack L, R x2

Output

USB mouse connector	A/B series x1
Speaker	3 watt x 1

Control

RS-232C	9-pin x1
---------	----------

Timing Chart

Resolution	H Sync (kHz)	V Sync (Hz)	Remark
640x350	31.5	70.1	
640x400	37.9	85.1	VESA
720x400	31.5	70.0	
720x400	37.9	85.1	VESA
640x480	31.5	60.0	VESA
640x480	37.9	72.8	VESA
640x480	35.0	66.7	Macintosh
640x480	43.3	85.0	VESA
800x600	35.2	56.3	VESA
800x600	37.9	60.3	VESA
800x600	48.1	72.2	VESA
800x600	46.9	75.0	VESA
800x600	53.7	85.1	VESA
832x624	49.7	74.5	Macintosh
1024x768	48.4	60.0	VESA
1024x768	56.5	70.1	VESA
1024x768	60.0	75.0	VESA
1024x768	68.7	85.0	VESA
1280x1024	64.0	60.0	VESA

DIMENSIONS

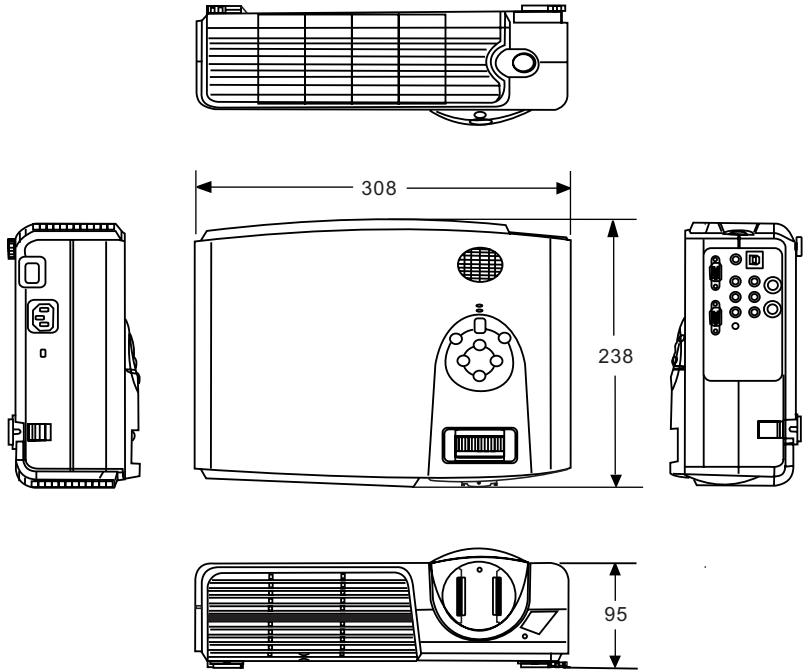

Unit: mm

Free Manuals Download Website

<http://myh66.com>

<http://usermanuals.us>

<http://www.somanuals.com>

<http://www.4manuals.cc>

<http://www.manual-lib.com>

<http://www.404manual.com>

<http://www.luxmanual.com>

<http://aubethermostatmanual.com>

Golf course search by state

<http://golfingnear.com>

Email search by domain

<http://emailbydomain.com>

Auto manuals search

<http://auto.somanuals.com>

TV manuals search

<http://tv.somanuals.com>