



# RD-JT40/RD-JT41 SERVICE MANUAL

### Caution

Be sure to read this manual before servicing. To assure safety from fire, electric shock, injury, harmful radiation and materials, various measures are provided in this Acer DLP projector. Be sure to read cautionary items described in the manual to maintain safety before servicing.

### Service Warning

1. When replace the lamp, to avoid burns to yor fingers. The lamp becomes too hot.
2. Nevr touch the lamp bulbwith a finger or anything else. Never drop it or give it a shock. They may cause bursting of the bulb.
3. This projector is provided with a high voltage circuit for the lamp. Do not touch the electric parts of powrer unit (main), when turn on the pojector.
4. Do not touch the exhaust fan, during operation.

### Contents

1. Specifications.....	2
2. Spare Parts List.....	4
3. Shipping Cntents.....	5
4. Projector Dsription.....	6
5. Rmote Control Desription.....	9
6. Insallation.....	11
7. Operation.....	13
8. Shutdown.....	21
9. Maintenance.....	22
10. Lamp Replacement.....	23
11. Trouble Shooting.....	25
12. Timing Char.....	33
13. DMD Image Secification.....	34
14. Electrical nterface Character.....	37
15. Final Assembly Alignent Procedure.....	39
16. Pakng Description.....	44
17. Appearance Description.....	45
18. Dimension.....	47
19. Schematics.....	48
20. Assy Drawing.....	85

# 1. SPECIFICATIONS

## Projector Specifications

### Technical Specifications

**Note: All specifications are subject to change without notice.**

<b>General</b>	
Product name	Personal Projector
Model name	RD-JT40    1024*768XGA
	RD-JT41    800*600SVGA
<b>Optical</b>	
Display system	1-CHIP DMD
Lens F/Number	F/2.6
Lamp	210W NSH lamp
<b>Electrical</b>	
Power supply	AC100 ~ 240V, 3.5A, 50/60 Hz (Automatic)
Power consumption	330 W (Max)
<b>Mechanical</b>	
Dimensions	308mm/12in (W) x 95mm/3.7in (H) x 238mm/9.4in (D)
Operating temperature range	10°C ~ 40°C
Weight	6.9 lbs (3.1 Kg)
<b>Input terminal</b>	
Computer input	
RGB input	D-sub 15-pin (female)
Video signal input	
S-VIDEO	Mini DIN 4-pin port x1
VIDEO	RCA jack x1
HDTV signal input	YPBPR RCA jack x3
Audio signal input	
Audio 1	Mini jack stereo port
Audio 2	RCA jack L, R x2
<b>Output</b>	
USB mouse connector	A/B series x1
Speaker	2 watt x 1
<b>Control</b>	
RS-232C	9-pin x1

## Service Information

### Accessories (included in the Standard Package)

Description of parts	Part No.
Power cord (EU)	27.82718.281
Power cord (US)	27.01818.000
Power cord (UK)	27.01018.000
VGA signal cable	50.J0508.502
Video cable	50.73213.501
S-Video cable	50.72920.011
PC audio cable	50.74405.501
Soft carrying case	98.J3402.001
HDTV cable	50.J2401.001
USB mouse cable	50.73213.501
Remote control	98.J3401.001
3-2 converter	22.91007.011

### Optional Accessories (not included in the Standard Package)

Description of parts	Part No.
Mac adapter (switchable)	20.20118.A15
Spare lamp module	60.J3416.CB1

## 2. Spare Parts List

Item No:99.J3477.L11 Projector LG RD-JT40 spare parts list

Parts No	Description
55.J3405.001	PCBA FAN CONTROL/B DX660
55.J3408.001	PCBA DC-DC/B DX660
60.J3419.001	ASSY PFC MODULE DX660
55.J3407.001	PCBA PFC CONTROL/B DX660
60.J3477.L11	ASSY ENGINE DX660-L11
55.J3419.001	PCBA THERMAL/B DX660
60.J3403.021	ASSY LOWER CASE P838 DX660/LG
42.J3415.001	FOOT REAR SILICON BLA. DX660
65.J3406.001	ADJUST FOOT FRONT MARS
55.J3401.001	PCBA DMD/B DX660
55.J3402.031	PCBA MAIN/BD LG DX660
60.J3414.031	ASSY OPTICAL ENG. DX660/LG
55.J3404.001	PCBA CHIP/B DX660
60.J3415.021	ASSY HSG DMD DX660/LG
71.01076.001	IC DIGITA IMAG DMD1076-7LGA11
60.J3404.001	ASSY BALLAST MODULE DX660
60.J3405.002	ASSY REAR FAN HLD MODULE DX66
60.J3407.021	ASSY REAR CVR MODULE DX660/LG
60.J3409.001	ASSY CAP LENS TRANS. DX660
60.J3412.061	ASSY UPPER CASE P896 DX660/LG
55.J3403.001	PCBA KEYPAD BD DX660
60.J3416.001	ASSY LAMP MODULE U DX660
60.J3482.001	ASSY REMOTE+CABLE LG DXS660
27.01018.000	CORD H05VV-F 13A250V 1830MM U
27.01818.000	CORD SVT#18*3C 10A125V 1830US
27.82718.281	CORD H05VV-F 10A250V EUR BLK
50.73213.501	CABLE 4P USB A-B 1800MM BLACK
50.J0508.502	SIGNAL/C 15/15P 2500MM/BLK
50.J7111.501	CABLE A/V (G.B.R)1800 BLK 784
50.72918.001	CABLE A/V RCA(R,W,Y)1500MM
50.72920.011	C.A MIN-DIN 4P S-VIDEO W/S 15
50.74405.501	CABLE AUD PC99PT284C/PT577C B
98.J3403.001	REMOTE CONTROLLER DXS660 LG
98.J3404.001	SOFT CASE DXS660 LG

Item No:99.J3877.L11 Projector LG RD-JT41 spare parts list

Parts No	Description
55.J3405.001	PCBA FAN CONTROL/B DX660
55.J3408.001	PCBA DC-DC/B DX660
60.J3419.001	ASSY PFC MODULE DX660
55.J3407.001	PCBA PFC CONTROL/B DX660
60.J3877.L11	ASSY ENGINE DS660-L11
55.J3419.001	PCBA THERMAL/B DX660
60.J3403.021	ASSY LOWER CASE P838 DX660/LG
42.J3415.001	FOOT REAR SILICON BLA. DX660
65.J3406.001	ADJUST FOOT FRONT MARS
60.J3406.061	ASSY INTERFACE MODULE DS660/L
55.J3801.001	PCBA DMD/BD FOR DS660
55.J3804.M21	PCBA MAIN/BD FOR LG DS660
60.J3410.001	ASSY BOX LAMP DX660
60.J3411.001	ASSY BKT BLOWER DX660
60.J3414.041	ASSY OPTICAL ENG. DS660/LG
55.J3802.001	PCBA DMD CHIP/BD FOR DS660
60.J3415.021	ASSY HSG DMD DX660/LG
71.08460.000	IC DIGITAL IMAG DMD8460 LGA11
60.J3404.001	ASSY BALLAST MODULE DX660
60.J3405.002	ASSY REAR FAN HLD MODULE DX660
60.J3407.021	ASSY REAR CVR MODULE DX660/LG
60.J3409.001	ASSY CAP LENS TRANS. DX660
60.J3412.071	ASSY UPPER CASE P896 DS660/LG
55.J3403.001	PCBA KEYPAD BD DX660
60.J3413.071	ASSY SUB U/C P896 DS660/LG
60.J3416.001	ASSY LAMP MODULE U DX660
60.J3417.021	ASSY DOOR LAMP P838 DX660/LG
60.J3481.001	ASSY MANU+WARRANTY LG
60.J3482.001	ASSY REMOTE+CABLE LG DXS660
98.J3403.001	REMOTE CONTROLLER DXS660 LG
98.J3404.001	SOFT CASE DXS660 LG

### 3. Shipping Contents

The Projector is shipped with the cables required for connection to standard PC or laptop computers. Carefully unpack and verify that you have all the items shown below. If any of these items are missing, please contact personnel at the place of purchase.

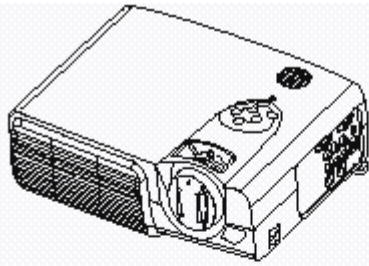

Projector



User's Guide



Quick Start Guide



User's  
CD Manual



Remote Control



3-2 Converter



Battery

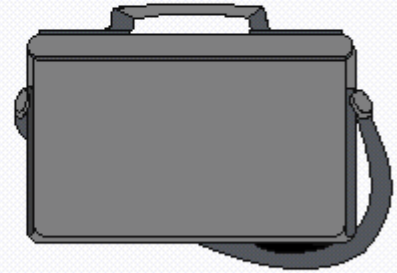

Deluxe Soft Carry Case

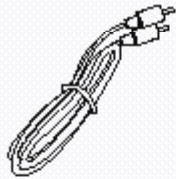

Audio Cable

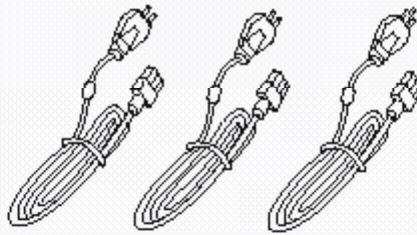

220V 240V 110V  
Power Cord



HDTV Cable



VGA Cable



USB Cable

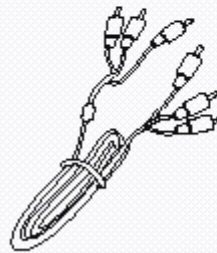

AV Cable



S-Video Cable

### Optional Accessories

1. Macintosh adapter
2. 210W Lamp module

## 4. Projector Description

### Projector

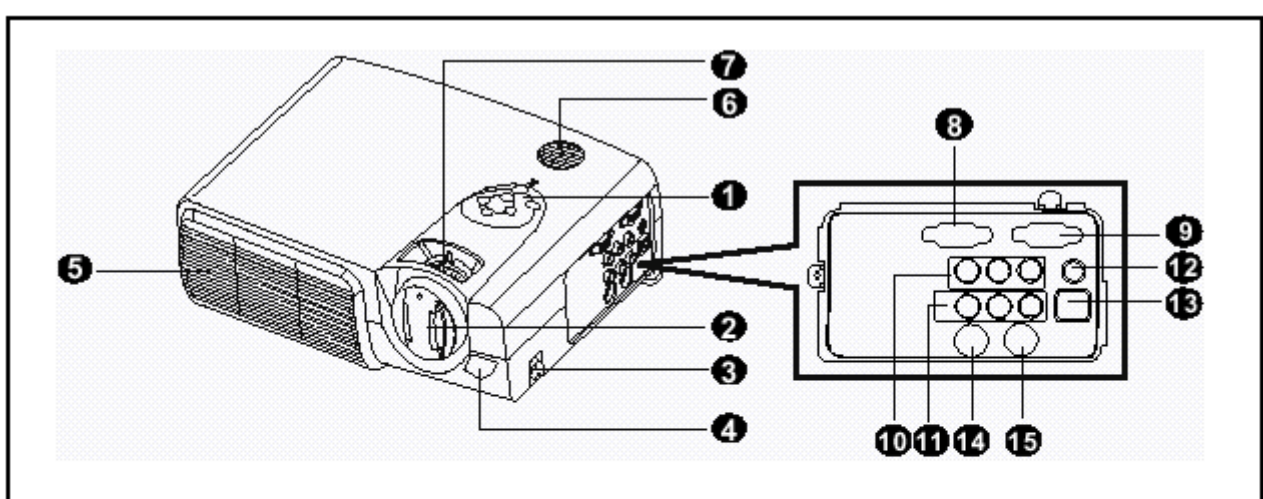

- |  |                                  |
|--|----------------------------------|
| <b>1</b> External control panel<br>(see next page) | <b>11</b> Audio/ Video connector |
| <b>2</b> Projection lens                           | <b>12</b> Audio jack             |
| <b>3</b> Front adjuster                            | <b>13</b> USB mouse connector    |
| <b>4</b> IR remote sensor                          | <b>14</b> S-Video jack           |
| <b>5</b> Ventilation grill                         | <b>15</b> RS 232 control port    |
| <b>6</b> Speaker                                   | <b>16</b> Rear adjuster feet     |
| <b>7</b> Projection lens adjuster                  | <b>17</b> Kensington lock        |
| <b>8</b> RGB signal input                          | <b>18</b> AC power cord inlet    |
| <b>9</b> RGB signal output                         | <b>19</b> Main power switch      |
| <b>10</b> YPBPR connector                          | <b>20</b> Lamp door              |

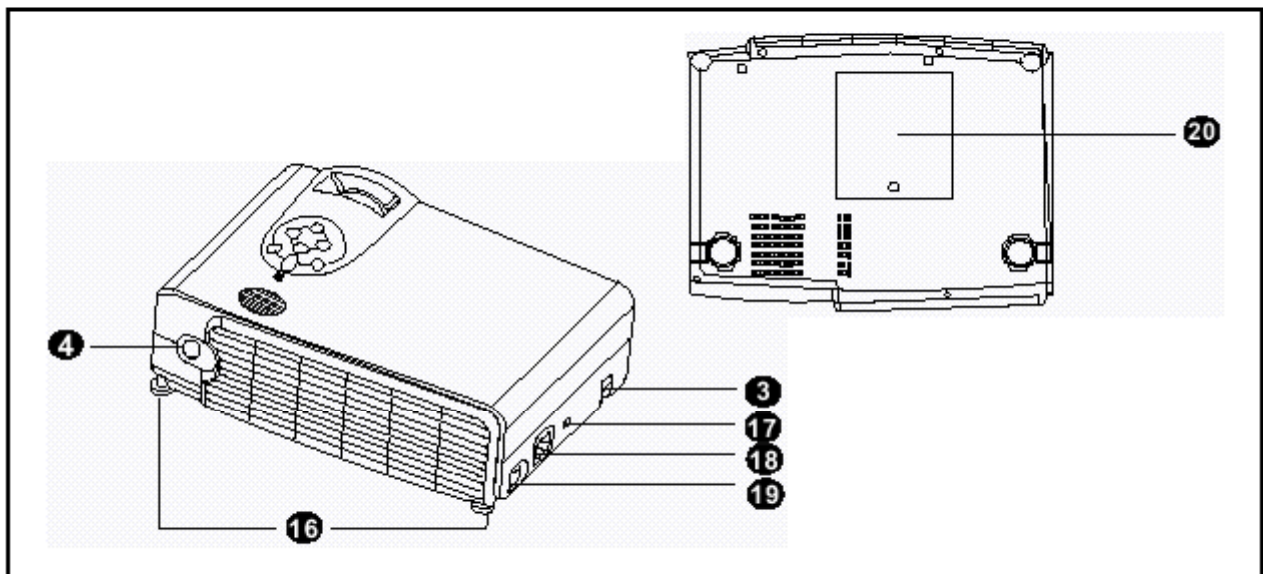

External Control Panel

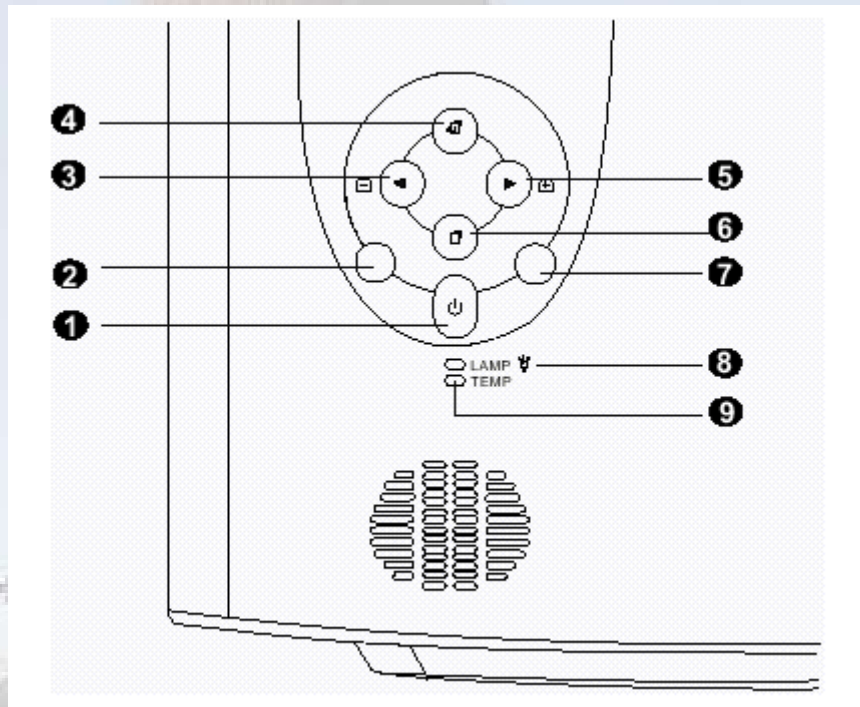

**1 Power**

Presses the **Power** key to turn the projector on or off.

**2 Auto**

Automatically determines the best picture settings for current received signals.

**3 Left/ Keystone -      4 Exit**

**5 Right/ Keystone +    6 Menu**

**Menu** will display the menu system on screen. Press **Menu** again to access the sub-menus. **Left** and **Right** help you navigate among choices and settings in the menus and sub-menus. However, when the on-screen menu is not activated, the **Left** and **Right** buttons will function as **Keystone +/-** hot keys.

Press the **Exit** button to go back to the main menu. Press **Exit** again to leave the menu system.

**7 Source**

Selects signal sources from among PC, Video, S-Video and YPBPR.

**8 Lamp Indicator**

The Lamp Indicator will light up when the lamp needs service, cooling or replacement. See "Lamp Information" on page 20 for more detailed information.

**9 Temp indicator**

The Temp indicator will flash when the system temperature is too high, which may occur if the projector is operated improperly. See "Temp Information" on page 22 for more detailed information.



The projector is equipped with 2 quick-release adjuster feet. Push the buttons to adjust its tilt angle.

1. Lift the projector up and press the adjuster button to release the adjuster.
2. The adjuster will drop into position and be locked.

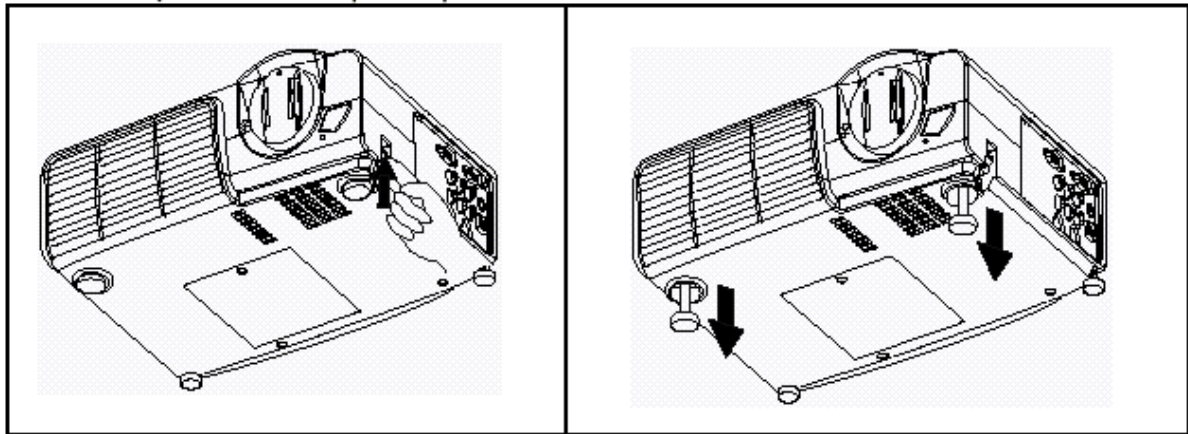

### Projector Features

The projector integrates high-performance optical engine projection and a user-friendly design to deliver high reliability and ease of use. The projector offers the following features:

- Small and light for portability
- Full-function remote control with laser pointer/ remote mouse function
- High quality manual zoom lens
- One-key auto-adjustment to display the best picture quality
- Easy digital keystone correction through hot keys to correct distorted images
- Adjustable color balance control for data/video display
- Ultra-high brightness projection lamp
- Ability to display 16.7 million colors
- On-screen menus in 8 languages: English, French, German, Italian, Spanish, Korean, Simplified Chinese, and Traditional Chinese.
- Switchable Normal/ Video mode for data/ video display
- Powerful AV function to provide high quality AV picture
- HDTV compatibility (YPBPR)

**Note: The brightness of the projected image will vary depending on the ambient lighting conditions and contrast/brightness settings.**

## 5. Remote Control Description

The remote control sensors are located in the front/ back of the projector. The distance between the sensor and the remote control should not exceed 6 meters.

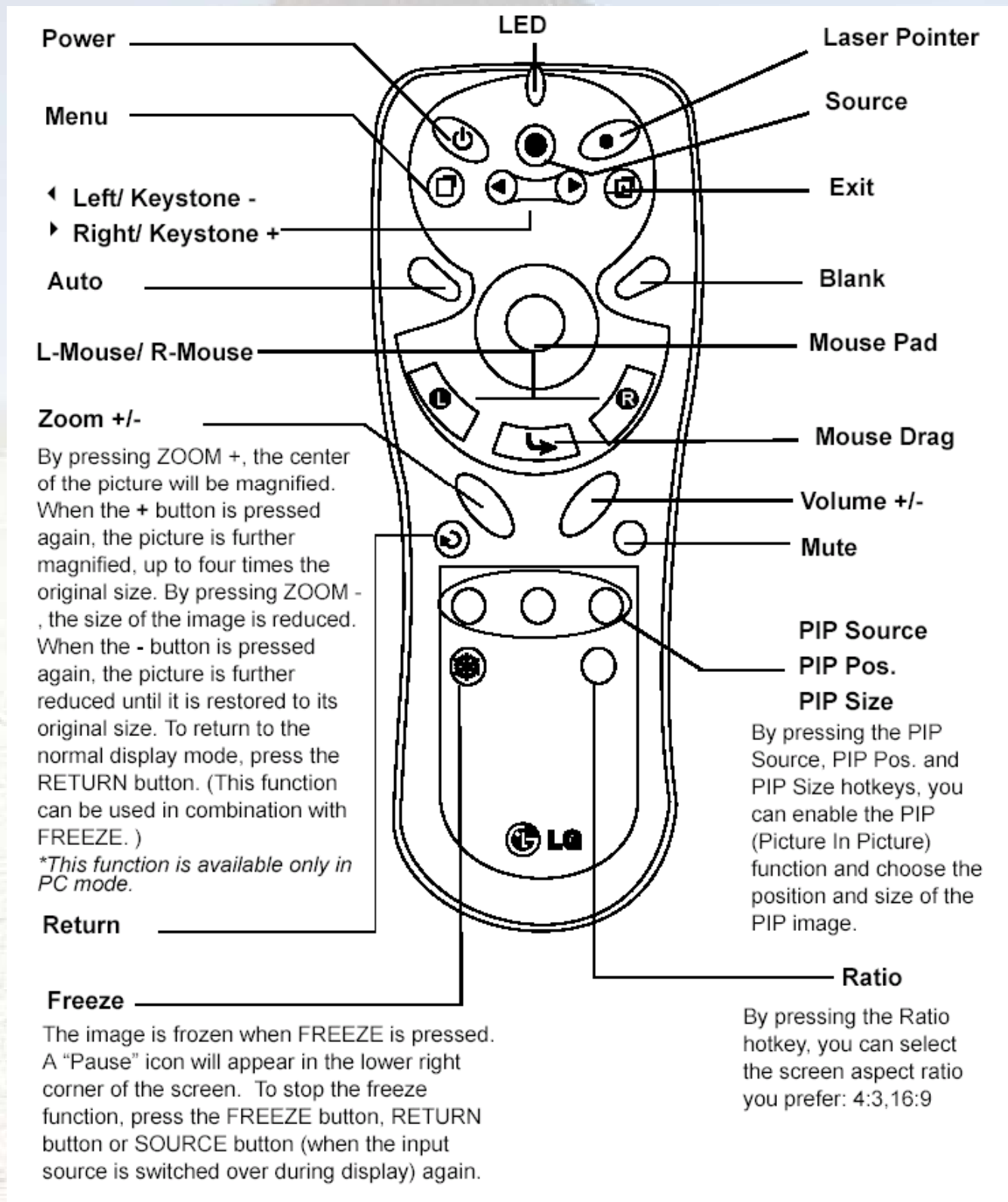

**1** Push and slide the battery compartment lid in the direction shown.

**2** Install batteries as indicated by the diagram inside the compartment.

**3** Position the lid over the compartment and snap it back into place.

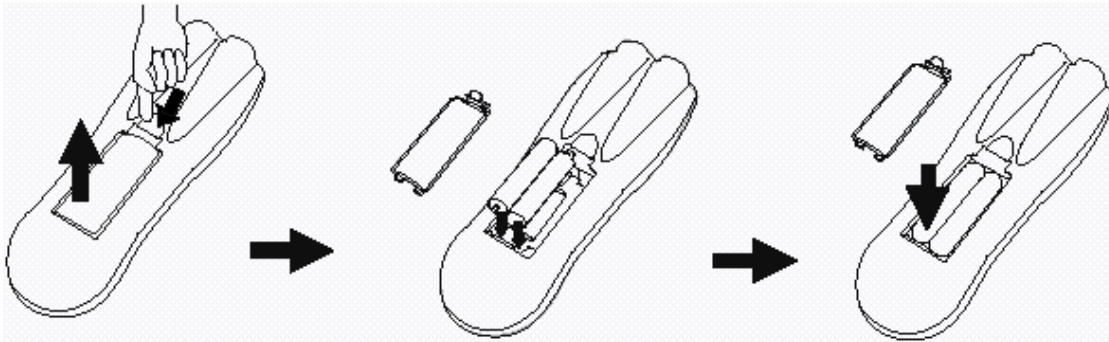

**⚠ Caution**

Avoid excessive heat and humidity. There may be danger of an explosion if batteries are incorrectly replaced. Replace only with the same or equivalent type recommended by the manufacturer. Dispose of used batteries according to the manufacturer's instructions.

## 6. INSTALLATION

### Screen Size

Place the projector at the required distance from the screen according to the desired picture size (see the table below).

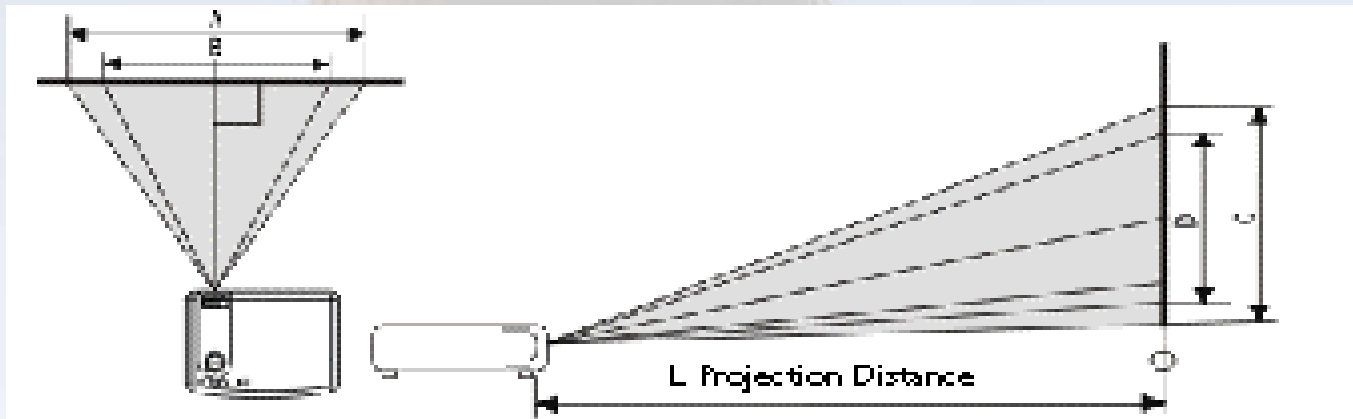

Screen Size (Max.)			L. Projection distance (cm/in)	Screen Size (Min.)		
Diagonal (cm/in)	A. Width (cm/in)	C. Height (cm/in)		Diagonal (cm/in)	B. Width (cm/in)	D. Height (cm/in)
77/30.4	61.8/24	46.3/18	100/39	63/24.9	50.7/20	38.0/15
154/60.8	123.65/49	92.7/36	200/79	127/49.9	101.3/40	76.0/30
232/91.2	185.3/73	138.9/55	300/118	190/74.7	151.9/60	113.9/45
309/121.5	247.0/97	185.2/73	400/157	253/99.7	202.5/80	151.9/60
386/151.9	308.7/122	231.6/91	500/197	316/124.6	253.2/100	189.9/75
463/182.3	370.5/146	277.9/109	600/236	380/149.5	303.8/120	227.9/90
541/213.1	432.2/170	324.18/128	700/276	443/174.6	354.4/140	266.2/105
617/243.1	494.0/194	370.5/146	800/315	506/199.4	405.1/160	303.8/120
695/273.5	555.7/219	416.7/164	900/354	570/224.3	455.7/180	341.8/135
772/303.9	617.5/243	463.11/182	1000/394	633/249.2	506.3/200	379.8/150

### Connecting to Various Equipment

#### HDTV description

The projector is capable of displaying various High Definition TV display modes. Some of these sources are:

- Digital-VHS (D-VHS) player
- DVD player
- Satellite Dish HDTV receiver
- DTV tuners

Most of these sources will provide an analog component video output, a standard VGA output, or a YPBPR (default) format.

The projector is capable of accepting HDTV data through a YPBPR connector. Use a HDTV cable that came with your projector to display HDTV images.

The following standards are supported in the HDTV function:

- 480i
- 480p
- 720p
- 1080i

Please refer to "Menu System" on page 13 for information on the HDTV OSD selections.

### Connecting to Various Equipment

It only takes a few seconds to connect your projector to your desktop or notebook computer, VCR, or other systems. However, a Mac adapter (an optional accessory) is needed for connection to Macintosh computers.

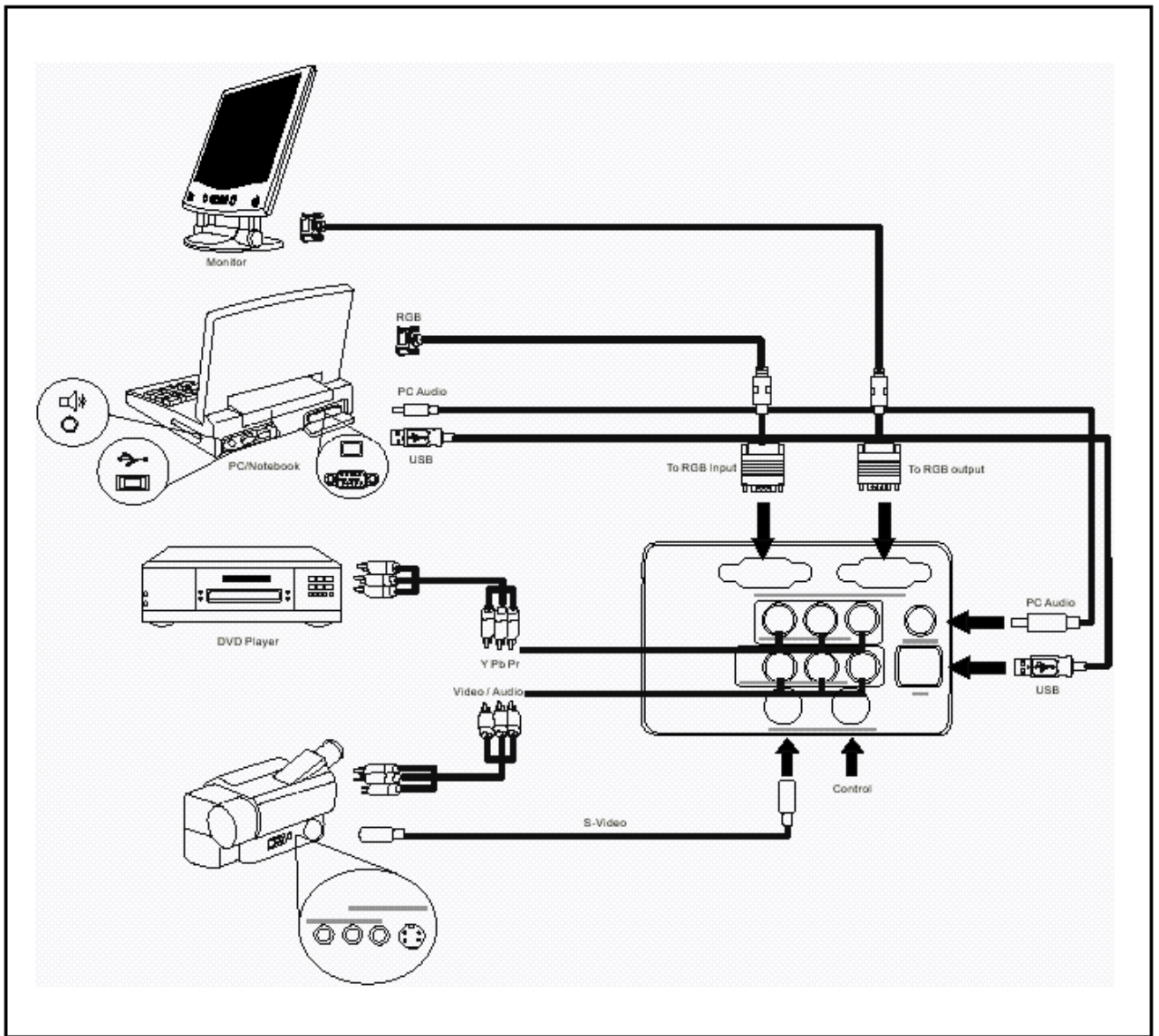

## 7. OPERATION

### Start Up

1. Plug the power cord into a wall socket.

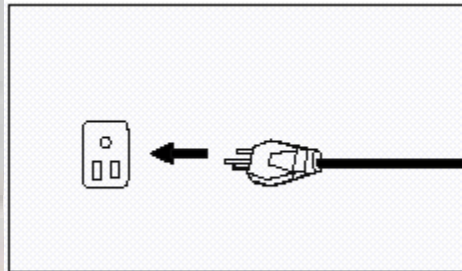

2. Turn on the main power switch.

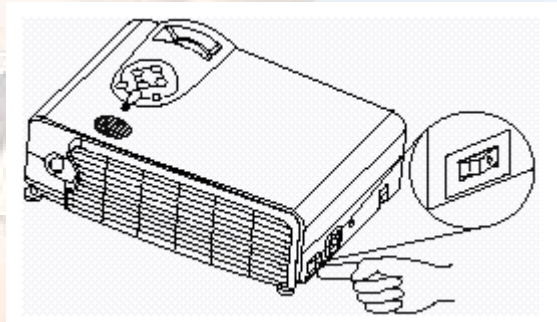

3. Press POWER to start the unit. The back-lit POWER key flashes green and stays green when the power is turned on

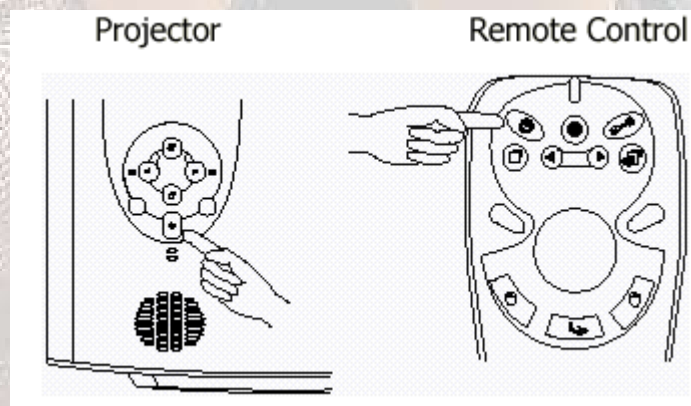

(When the power is turned off, there is a 60-second cooling period before the projector can be re-started.)

4. Switch on all connected equipment.

### Digital Keystone Correction

Keystoning refers to the situation where the projected image is noticeably wider at either the top or bottom. To correct this, press KEYSTONE +/- (hot key) on the control panel of the projector or on the remote control, and then adjust the sliding bar labeled Keystone, as needed. Press + to correct keystoning at the top of the image. Press - to correct keystoning at the bottom of the image.

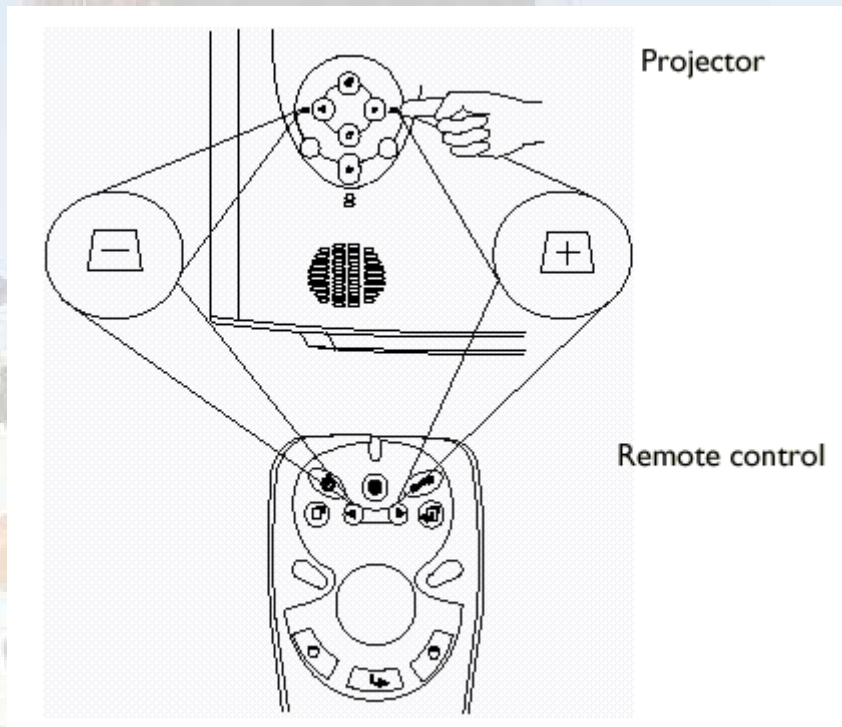

### Auto Adjustment

In some cases, you may need to optimize the picture quality. To do this, press the AUTO key on the control panel of the projector or on the remote control. Within 3 seconds, the built-in Intelligent Auto Adjustment function will re-adjust settings to provide the best picture quality.

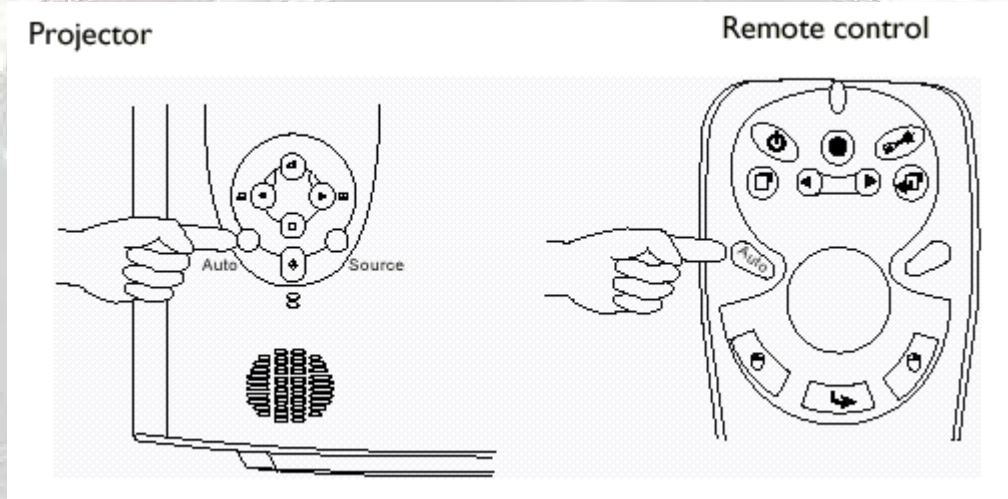

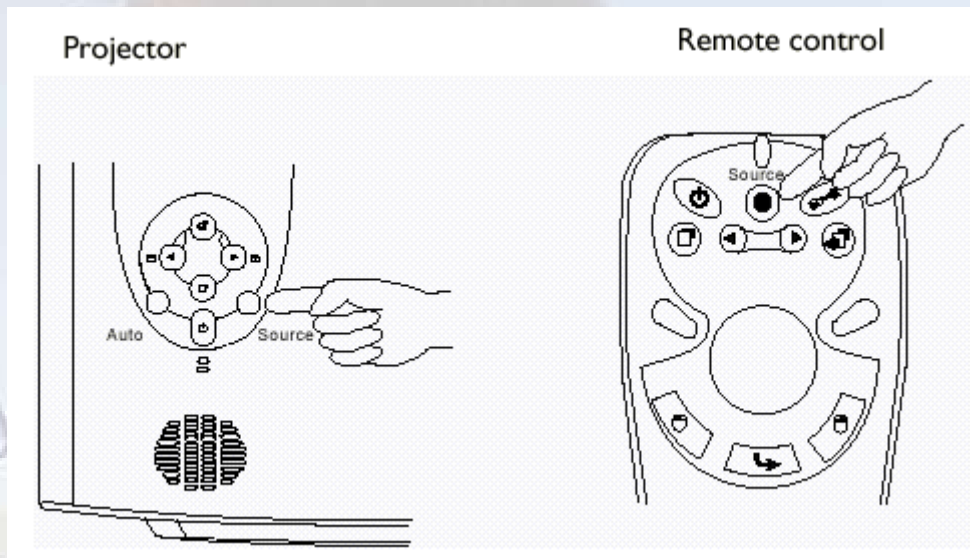

### Source Selection

When several input sources are available, press the SOURCE key to make a selection from the control panel of the projector or the remote control.



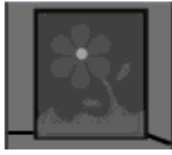
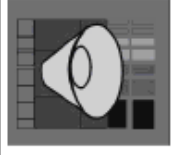
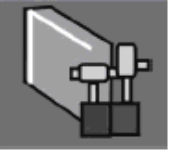

### Menu System

Press **Menu** for the main menu, and then press ◀ or ▶ to select a sub-menu. Press **Menu** again to select items in the sub-menu.

Menu Bar					
Sub-menu	Display	Image	Source	Control	PIP
<b>PC</b>	Keystone Brightness Contrast Phase H.Size	Ratio H-position V-position Color Temp Information	Mirror Source Volume Treble Bass Mute	Language OSD Setup Default Video Mode Lamp hour	Main page: PIP Source PIP Size PIP Pos. H. Position V.Position More Options
<b>Y/Pb/Pr</b>		Ratio H-position V-position Color Tint Color Temp			
<b>Video</b>		Keystone Brightness Contrast Color Tint			



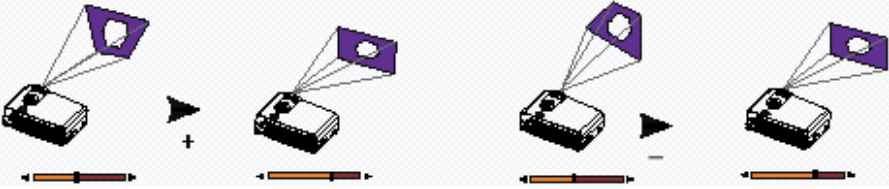
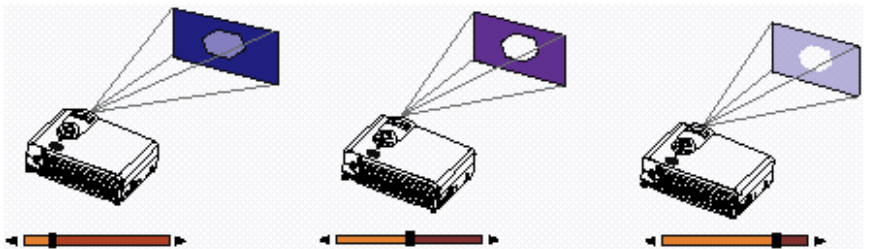
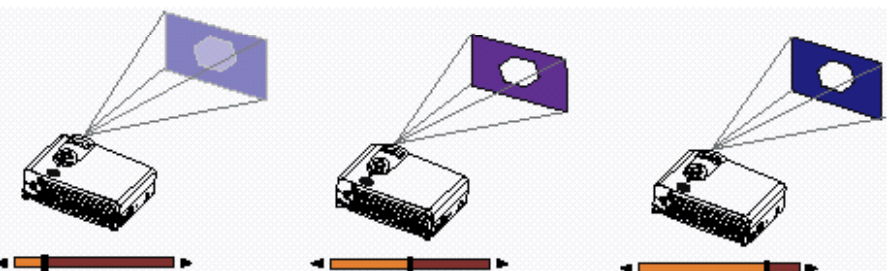



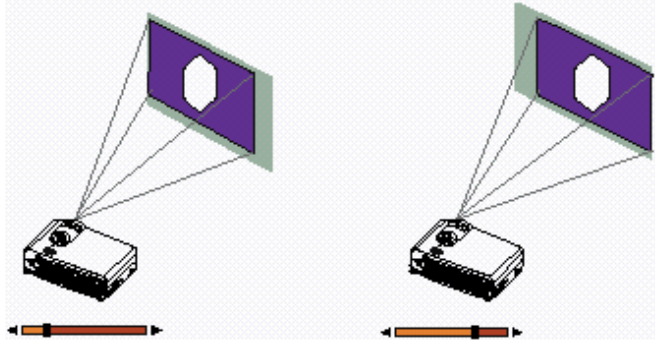
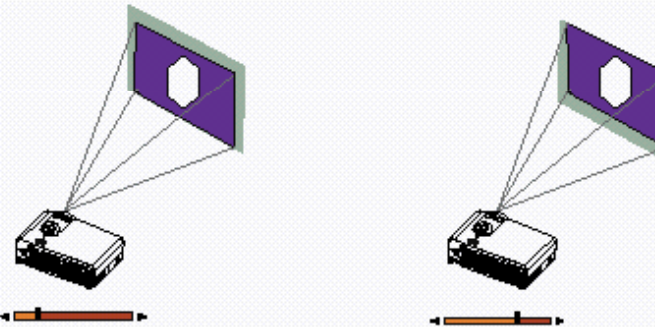

## 1. Display Menu

FUNCTION	DESCRIPTION
<p><b>Keystone</b></p>	<p>Corrects any keystoneing of the image.</p> 
<p><b>Brightness</b></p>	<p>Adjusts the brightness of the image.</p> 
<p><b>Contrast</b></p>	<p>Adjusts the degree of difference between dark and light in the image.</p> 
<p><b>Phase</b></p>	<p>Adjusts to avoid the occurrence of flicker.</p>  <p><i>*This function is not available when the input mode is Video or S-Video.</i></p>
<p><b>H.Size</b></p>	<p>Adjusts to fit in the desired image size.</p> <p><i>*This function is not available when the input mode is Video or S-Video.</i></p>
<p><b>Color</b></p>	<p>Increases or decreases the color range (R, G, B) of the image.</p> <p><i>*This function is not available when the input mode is PC.</i></p>
<p><b>Tint</b></p>	<p>Adjusts the image to make it appear more red or blue.</p> <p><i>*This function is not available when the input mode is PC.</i></p>

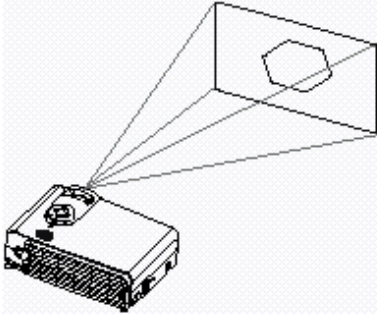
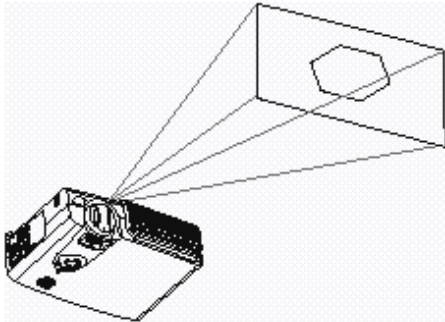
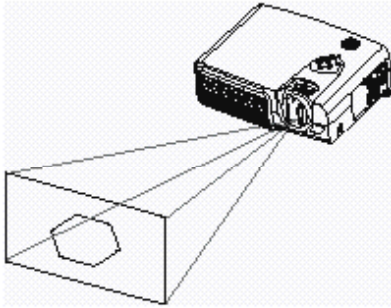
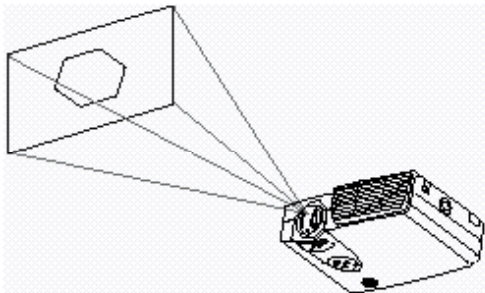
## 2. Image Menu

FUNCTION	DESCRIPTION
<b>Ratio</b>	Users have 3 options for the image ratio. 1. 1:1 2. 4:3 3. 16:9
<b>H-position</b>	Adjusts the horizontal position of the projected image. 
<b>V-position</b>	Adjusts the vertical position of the projected image. 
<b>Color Temp.</b>	Adjusts the color temperature to fit your preference.
<b>Information</b>	Shows the current resolution.
<b>System</b>	System information will be shown: 1. Auto 2. NTSC 3. PAL 4. SECAM <b>*The default setting for System is Auto.</b>
<b>Sharpness</b>	Adjusts the image to make it look sharper or softer. <b>*This function is not available when the input mode is PC or YPBPR.</b>
<b>Color</b>	Increases or decreases the color range (R, G, B) of the image. <b>*This function is not available when the input mode is PC.</b>
<b>Tint</b>	Adjusts the image to make it appear more red or blue. <b>*This function is not available when the input mode is PC.</b>

### 3. Source Menu

FUNCTION	DESCRIPTION	
<p><b>Mirror</b></p>	<p><b>1. Default</b></p> 	<p><b>2. Ceiling mounted projection</b></p> 
	<p><b>3. Rear screen projection</b></p> 	<p><b>4. Ceiling mounted and rear-screen projection</b></p> 
	<p><b>Source</b> Selects the input source from among PC, Video, S-Video, and YPBPR.</p>	
	<p><b>Volume</b> Adjusts the volume level.</p> 	
<p><b>Treble</b> Adjusts the treble level.</p> 		
<p><b>Bass</b> Adjusts the bass level.</p> 		
<p><b>Mute</b></p> <p style="text-align: center;"> <span data-bbox="480 1883 539 1917">Off</span> <span data-bbox="703 1883 762 1917">On</span> </p>  		

#### 4. Control Menu

FUNCTION	DESCRIPTION
<b>Language</b>	Language sets the language for the OSD control menus. Use the 3 / 4 key to select the desired language from among English, French, German, Italian, Spanish, Korean, Simplified Chinese and Traditional Chinese.
<b>OSD</b>	<b>OSD Pos.</b> Selects a desired OSD position.
	<b>OSD Time</b> Sets the length of time the OSD will remain active after the last time you pressed the button. The range is from 5 to 60 seconds in 5-second increments.
<b>Setup</b>	<b>Source scan</b> When selected, activates the Source scan function.
	<b>Keystone hold</b> When selected, preserves the last keystone correction value even when the projector is restarted.
	<b>Mirror hold</b> When selected, preserves the last mirror correction value even when the projector is restarted.
	<b>Blank time</b> Determines the length of time before the projector is shut off when Blank is activated.
	<b>Auto off</b> Sets the length of time before the system is shut off when no input is detected.
	<b>User logo</b> Enables the user to define the logo screen that will display during start-up. Three modes are available: Default (BOXLIGHT logo), black screen and blue screen.
<b>Default</b>	Returns all settings to their factory preset values.
<b>Video Mode</b>	Selects video mode.
<b>Lamp hour</b>	Shows lamp usage time.

### 5. PIP Menu

These functions are available only when the input mode is PC and the PIP source is Video or S-Video

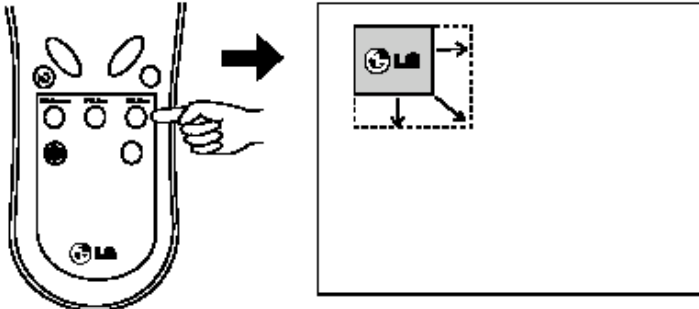
FUNCTION	DESCRIPTION
<b>PIP Source</b>	Selects the source for the PIP. 1. Off 2. Video 3. S-Video
<b>PIP Size</b>	Enables use of the ◀ or ▶ key to scroll through the three alternatives: Small, Medium, Large. 
<b>H Position</b>	Adjusts the horizontal position of the PIP image.
<b>V Position</b>	Adjusts the vertical position of the PIP image.
<b>More Options</b>	Enables use of the ◀ or ▶ key to select more PIP functions including Brightness, Contrast, Color, Tint, Sharpness and System.
<b>Brightness</b>	Adjusts the brightness of the PIP image.
<b>Contrast</b>	Adjusts the degree of difference between dark and light for the PIP image.
<b>Color</b>	Increases or decreases the color range (R, G, B) of the image.
<b>Tint</b>	Adjusts the image to make it appear more red or blue.
<b>Sharpness</b>	Adjusts the image to make it appear sharper or softer
<b>System</b>	Selects PIP image systems: NTSC, PAL, SECAM

## 8. Shutdown

1. Press POWER and a warning message will appear. To turn off the projector, press POWER again.

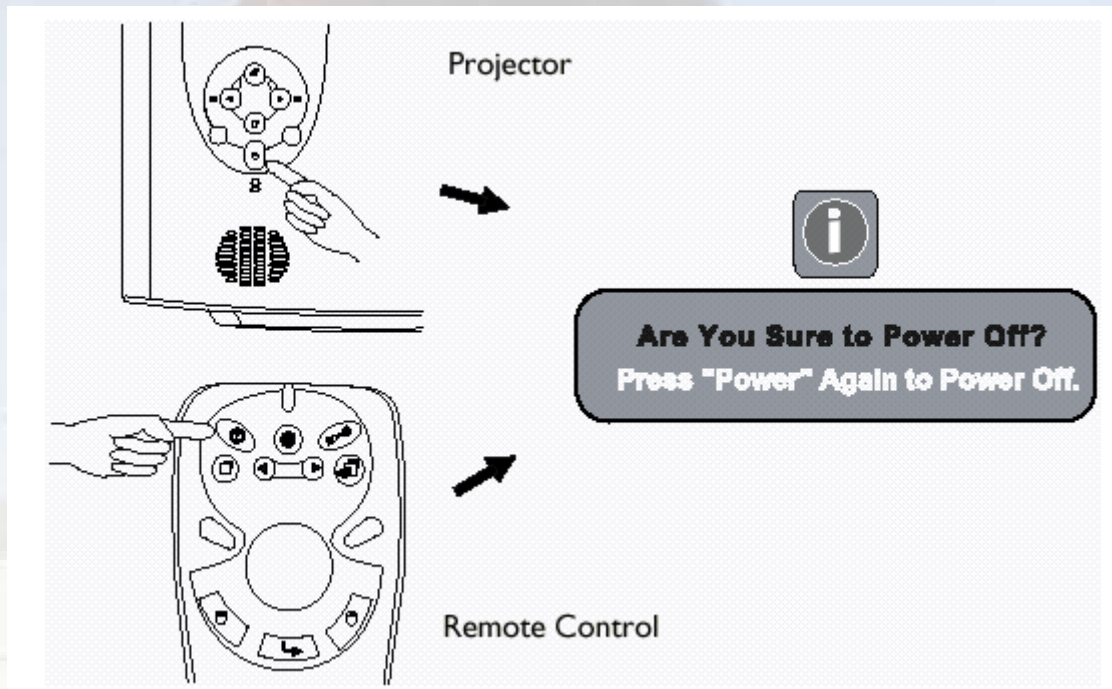

2. The fan will continue to run for approximately two minutes.
3. Turn off the main power switch.

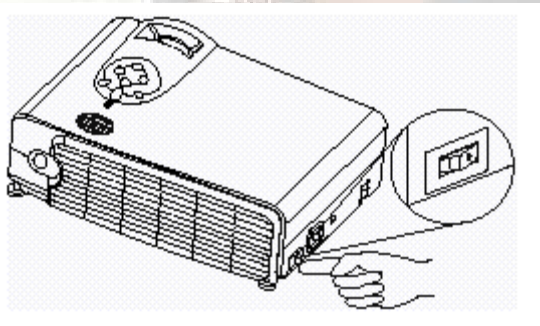

4. Disconnect the power cord from the wall socket.

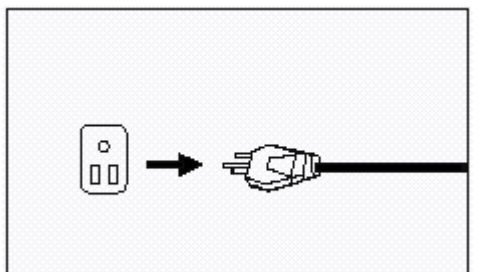

### **Caution**

Please do not unplug the power cord before POWER is shut down or during the two-minute cooling process. If the projector is not properly shut down, to protect the lamp, the system will detect this and cool the lamp for two minutes automatically before turning on again.

## 9. MAINTENANCE

### Lamp Information

#### Use and Replacement of the Lamp

When the lamp Indicator lights up red or a message appears suggesting the time of lamp replacement, please install a new lamp or consult your dealer. An old lamp could cause a malfunction in the projector and in rare instances may even explode.

#### Lamp LED Indicators

Lamp Life Indicators	When the LED lights up red, it is warning you that lamp usage has exceeded 1500 hours. Replace the projection lamp with a new one immediately.
The Lamp is not properly attached	LED lights up red.
The temperature is too high	When the projector's internal temperature is too high for the projector to operate safely, the LED blinks orange and the lamp turns off automatically. The LED keeps blinking while the unit is off. If the LED light is off, the operation and temperature of the projector's lamp are normal.

#### Caution

The LAMP indicator will light up if the lamp becomes too hot. Turn off the power and let the projector cool for 45 minutes. If the LAMP indicator is still red when turning the power on, please contact your dealer.

## 10. Lamp Replacement

### **Caution**

To reduce the risk of electrical shock, always turn off the projector and disconnect the power cord before changing the lamp

1. Press the **POWER** button to switch off the projector. Disconnect the power cord from the outlet and the projector.
2. Loosen the screw and remove the lamp cover. If the lamp is hot, avoid burns by waiting 45 minutes until the lamp has cooled.
3. Loosen the 3 screws. (It is strongly recommended that you use a magnetic-head screwdriver.) Pull the handle to remove the lamp housing. If the screws are not loosened completely, they could injure your fingers. Do not insert your hand into the box after the lamp is removed. If you touch the optical components inside, this could cause color unevenness in projected images.
4. Replace the lamp with a new one. Insert it into the projector, and tighten the screws firmly. Loose screws may cause a bad connection, which may result in malfunction.
5. Re-install the lamp cover and tighten the screw. **Do not turn on the power with the lamp cover removed.** Whenever the lamp is replaced, reset the total lamp operation time. **Do not reset if the lamp is not replaced as this could cause damage.**

### Step 1

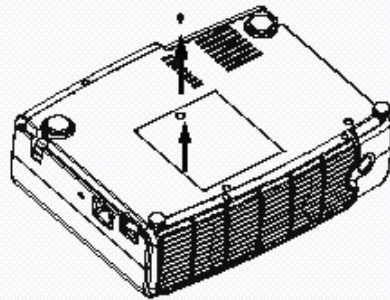

### Step 2

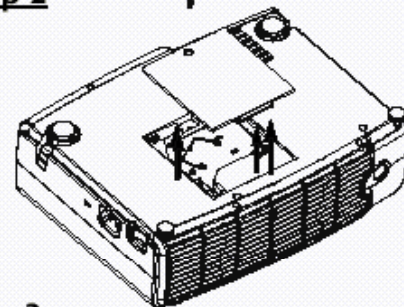

### Step 3

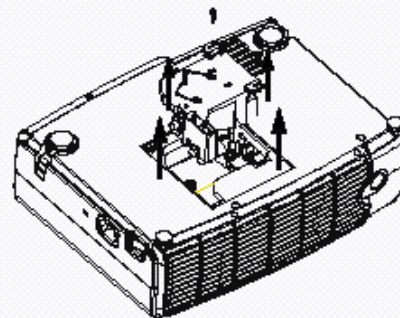

### Step 4

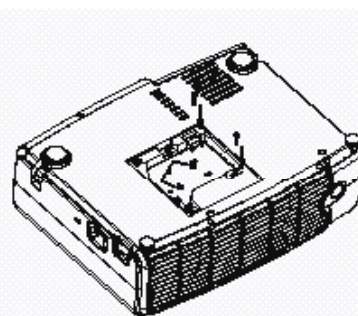



**⚠ Caution**

To reduce the risk of severe burns, allow the projector to cool for at least 45 minutes before replacing the lamp.



To reduce the risk of injuries to fingers and damage to internal components, use caution when removing lamp glass that has shattered into sharp pieces.

To reduce the risk of injuries to fingers and/or compromising image quality by touching the lens, do not touch the empty lamp compartment when the lamp is removed.

This lamp contains mercury. Consult your local hazardous waste regulations to dispose of this lamp in a proper manner.

**Resetting Lamp Hours**

If you replace the lamp after 1500hours of operation, please follow the instructions below within 10 minutes of powering on.

OSD	FUNCTION
	<p>Press the Exit button on the projector for 3 seconds to display the total used lamp time.</p>
	<ul style="list-style-type: none"> <li>• Press the MENU button on the projector during the lamp hour message. An adjustment message will appear.</li> <li>• Press ◀ or ▶ to reset lamp hours or press EXIT to leave.</li> </ul>

**Temp Information**

When the LED lights up, it is warning you of the following possible problems:

1. The internal temperature is too high.
2. The fans are not working.

Turn off the projector and contact qualified service personnel for further help.

## 11. TROUBLE SHOOTING

### Common Problems & Solutions

PROBLEMS	TRY THESE SOLUTIONS
<b>NO POWER</b>	<ul style="list-style-type: none"> <li>◆ Make sure the power cord is inserted snugged into the AC adapter socket.</li> <li>◆ Make sure the power cord is inserted snugged into the power outlet.</li> <li>◆ Toggle the power switch to the position "I"</li> <li>◆ Wait two minutes after the projector is turned off before turning the projector back on.</li> </ul>
<b>NO PICTURE</b>	<ul style="list-style-type: none"> <li>◆ Check for the proper input source.</li> <li>◆ Ensure all cables are connected properly.</li> <li>◆ Adjust the brightness and contrast.</li> <li>◆ Remove the lens cap.</li> </ul>
<b>TRAPEZOID IMAGE ON THE SCREEN</b>	<ul style="list-style-type: none"> <li>◆ Reposition the unit to improve its angle on the screen.</li> <li>◆ Use the <b>Keystone</b> correction key on the control panel of the projector or the remote control unit.</li> </ul>
<b>POOR COLOR</b>	<ul style="list-style-type: none"> <li>◆ Select the correct video system.</li> <li>◆ Adjust brightness, contrast, or saturation.</li> </ul>
<b>BLURRED IMAGE</b>	<ul style="list-style-type: none"> <li>◆ Press <b>Auto</b> on the control panel of the projector or the remote control unit to get better picture quality.</li> <li>◆ Adjust the focus.</li> <li>◆ Reposition the unit to improve its projection angle.</li> <li>◆ Ensure the distance between the unit and screen is within the adjustment range of the lens.</li> </ul>
<b>REMOTE CONTROL DOES NOT WORK</b>	<ul style="list-style-type: none"> <li>◆ Replace the batteries with new ones.</li> <li>◆ Make sure there is no obstacle between the remote control and the projector.</li> <li>◆ Stand within 4 meters (13 feet) of the projector.</li> <li>◆ Make sure nothing is blocking the front and rear receivers.</li> </ul>

### Status Messages

On-Screen Messages	Description
<b>SEARCHING</b>	Projector is searching for input.
<b>ACQUIRING SIGNAL</b>	Projector has identified the input signal and is running the auto image adjustment function.
<b>OUT OF RANGE</b>	Input signal frequency exceeds the projector's range.
<b>LAMP WARNING – CHANGE LAMP AND RESET LAMP TIMER!</b>	The lamp has been in operation for 1400 hours. Install a new lamp for optimal performance.
<b>OUT OF LAMP USAGE TIME. CHANGE THE LAMP!</b>	The lamp has been in operation for 1480 hours, and the power will turn off after 20 hours.
<b>OUT OF LAMP USAGE TIME. YOU HAVE TO CHANGE THE LAMP!</b>	The lamp has been in operation for over 1500 hours. The warning message will display for 30 seconds every 5 minutes after you turn on the projector and the power will turn off automatically after 10 minutes.

# 1. Final Assembly Trouble Shooting Guide

## System Trouble Shooting Flow Char

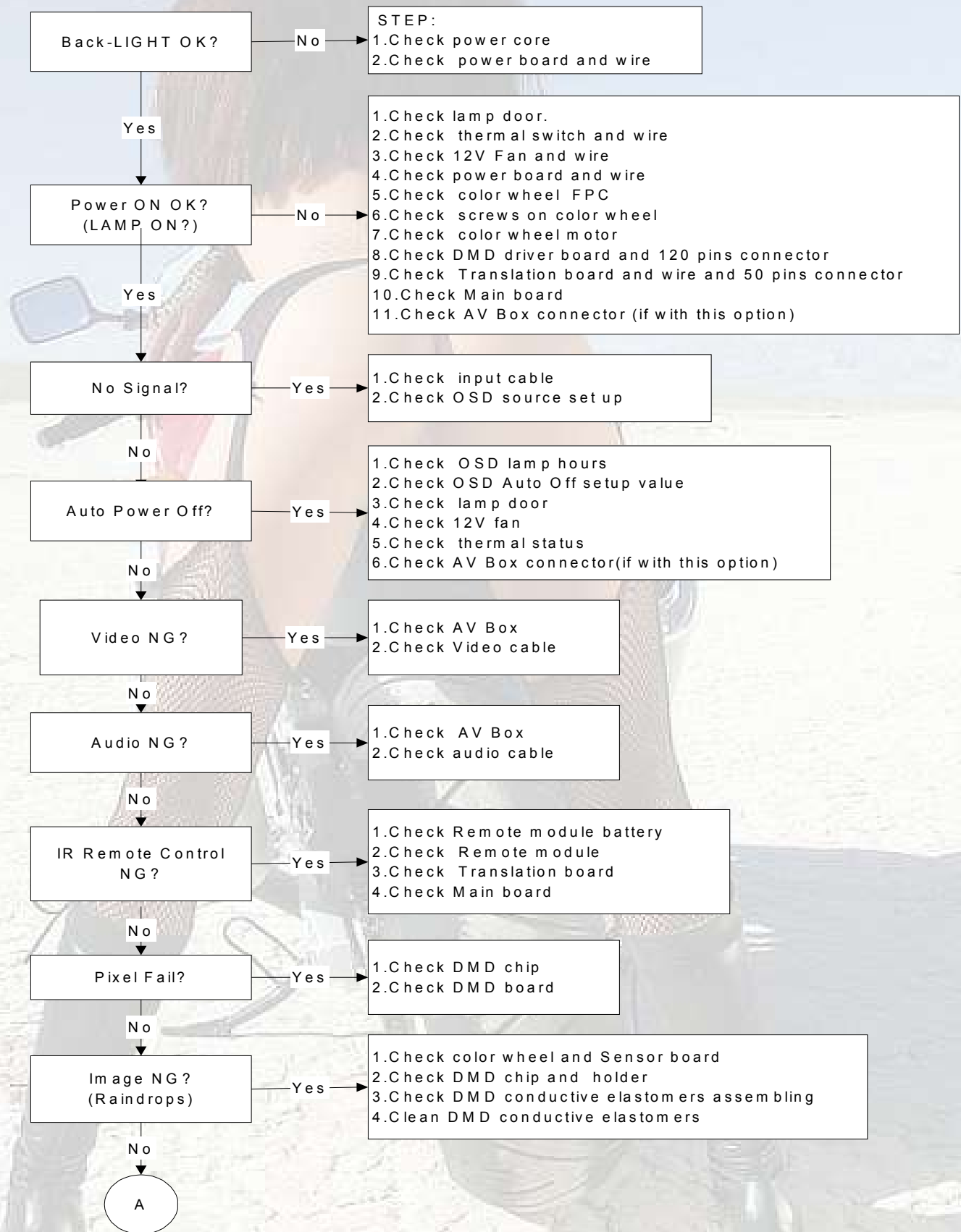

## 2. Engine Assembly Trouble Shooting Guide

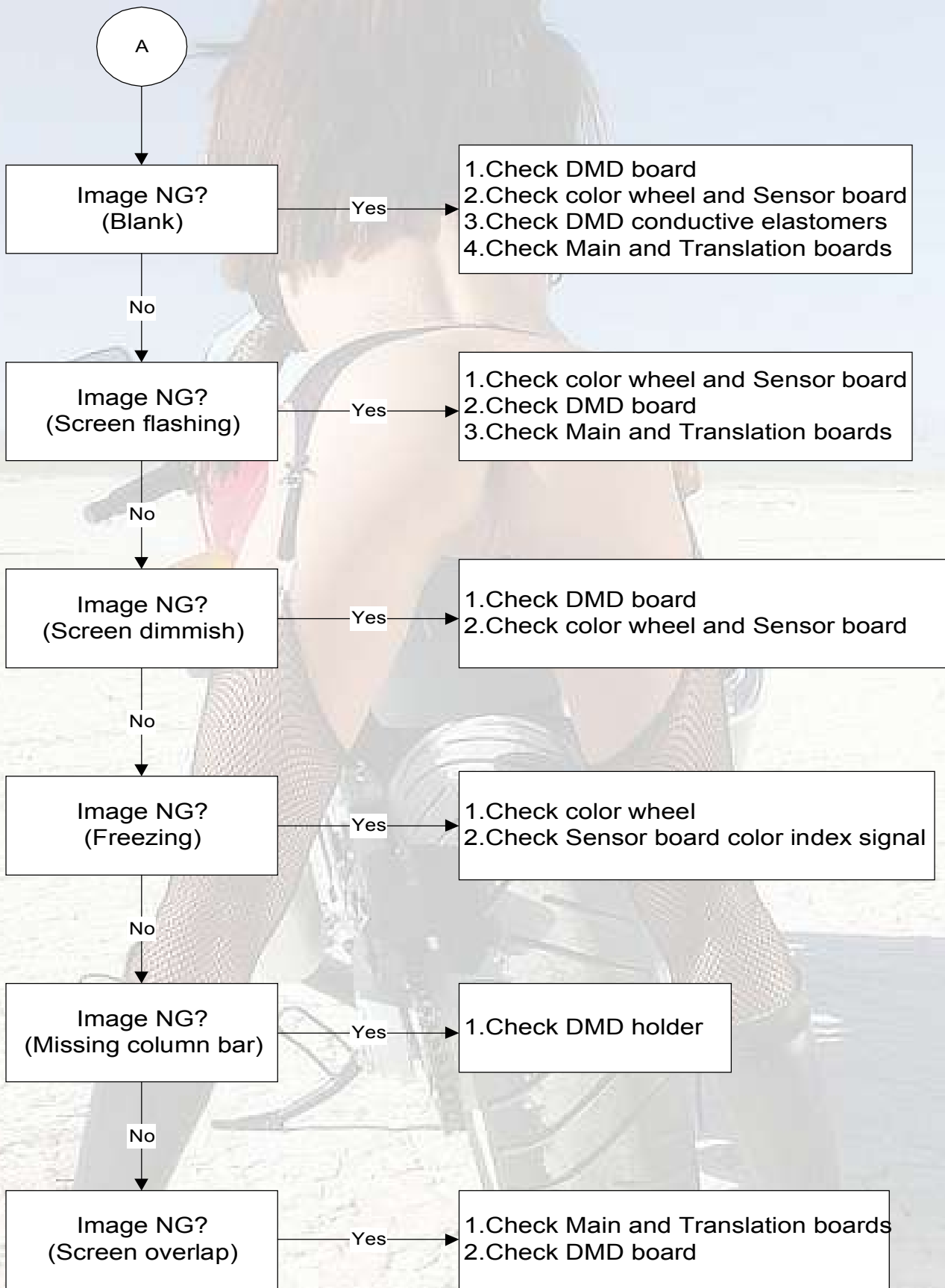

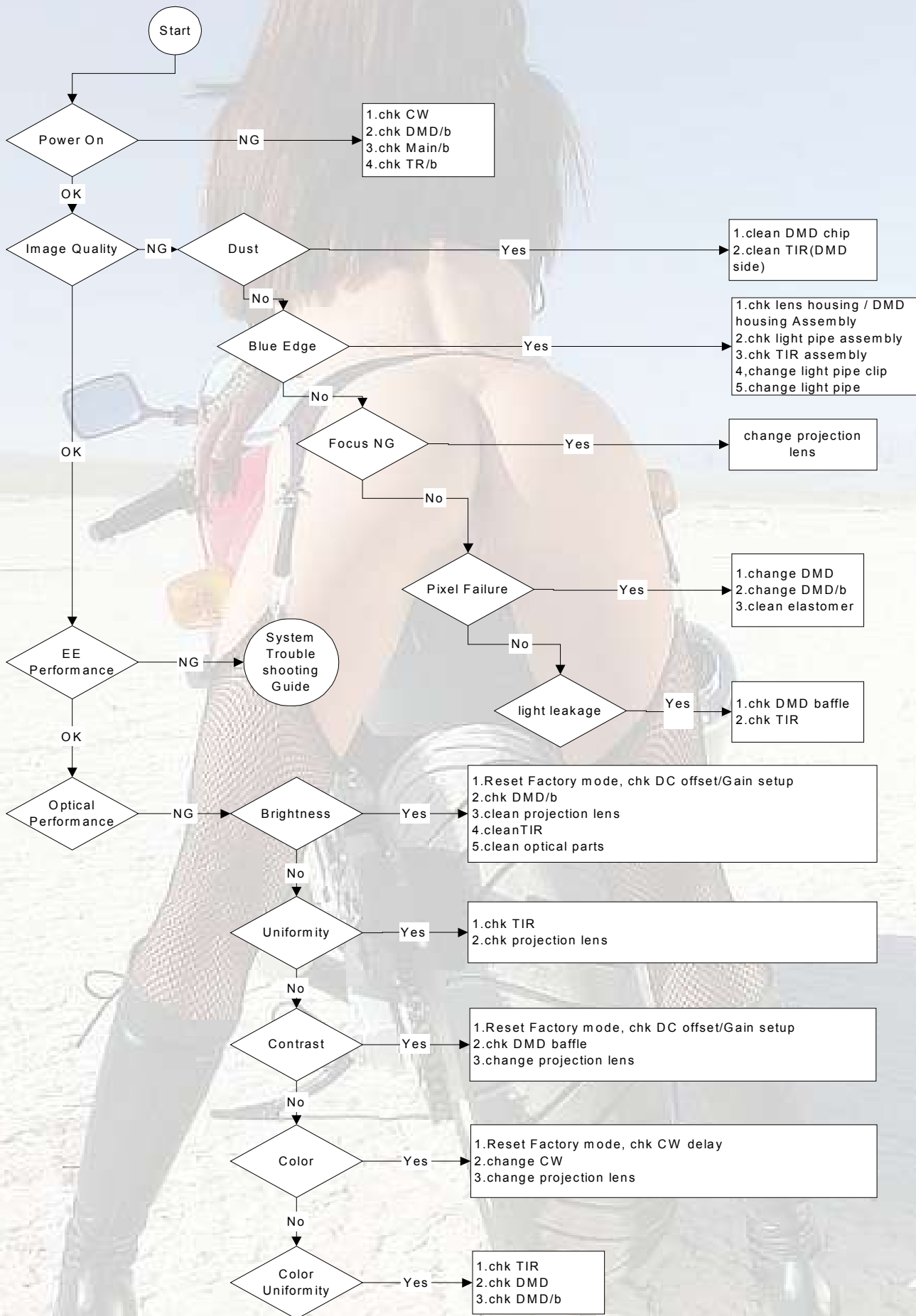

### 3. Main Board Trouble Shooting Guide



### 4. Power Supply Trouble Shooting Guide

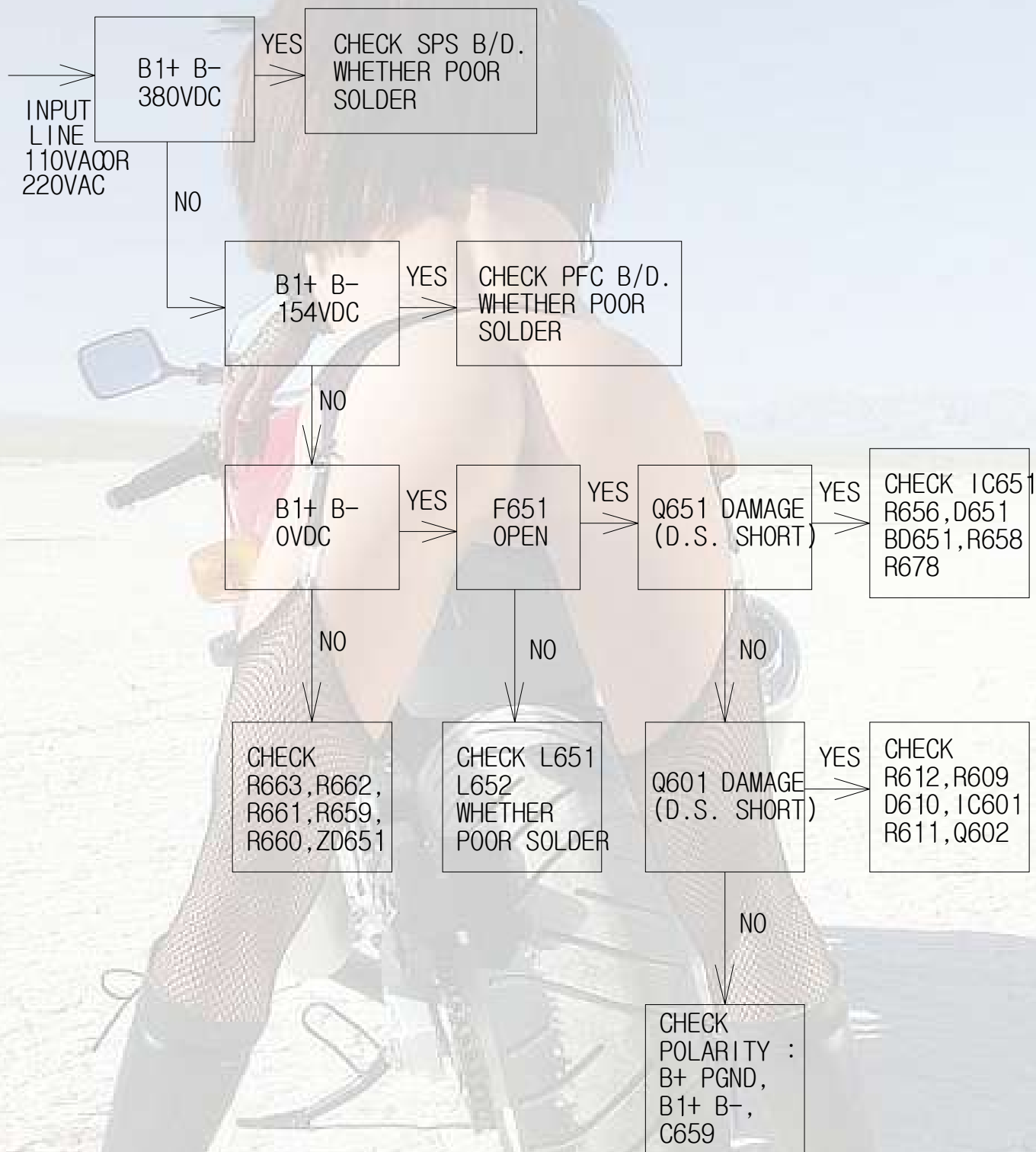

### 5. Translation Board Trouble Shooting Guide

D S 6 6 0 T r a n s l a t i o n B o a r d T r o u b l e S h o o t i n g G u i d e

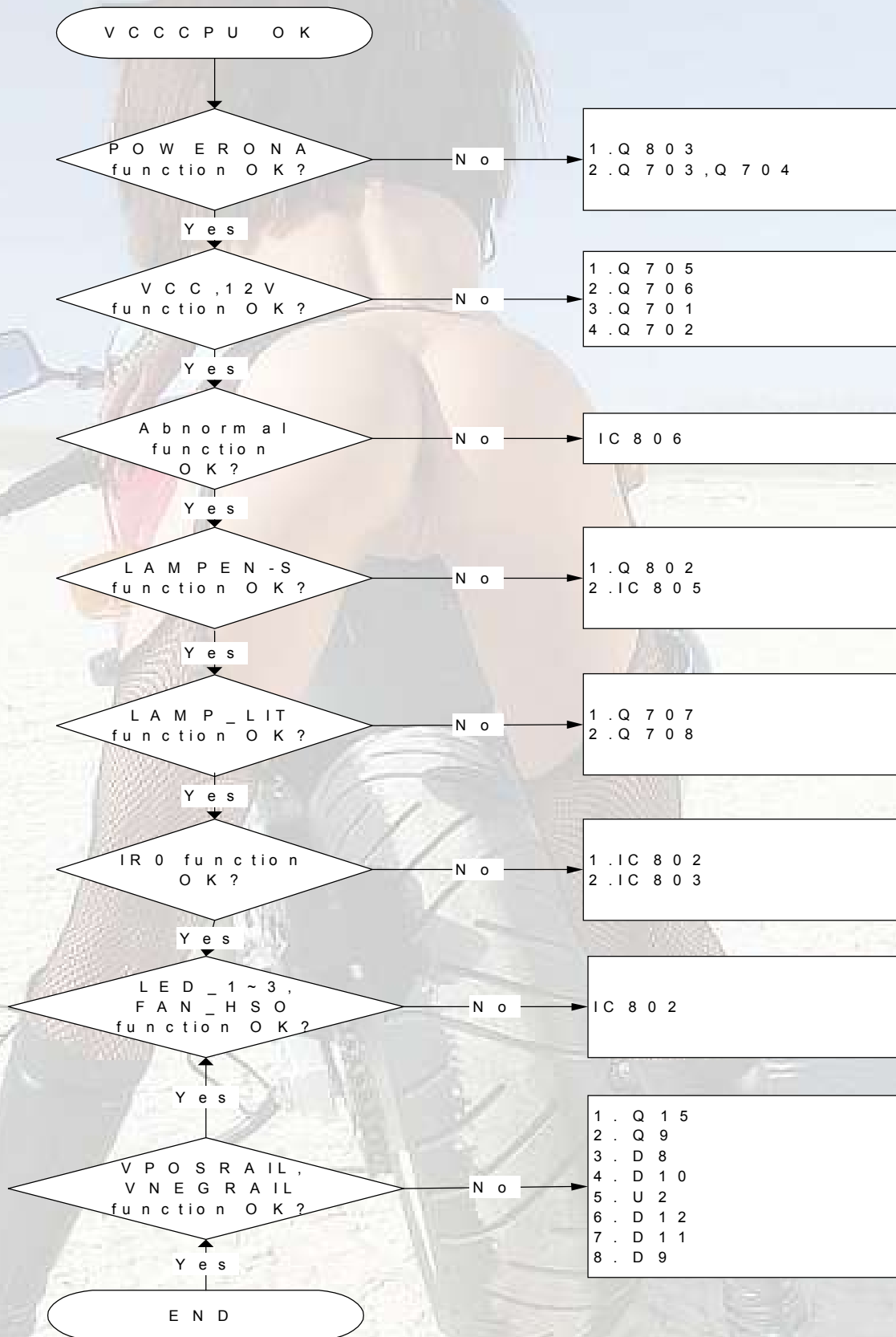



## 6. DMD Board Trouble Shooting Guide

- Check power voltages.
- Check clocks from oscillator (58 MHz), from ASIC (58 MHz and 116 MHz), from FPGA (9.667 MHz and 2.4 MHz), to Hitachi (14 MHz), to motor controller (9.667 MHz)
- Verify HSYNC, VSYNC, ACTDATA, SYNCVALID, POWERGOOD, RESETZ from computer or source at 60 Hz. Verify these signals meet TI specified timing per Hardware ICD.
- Verify color wheel index running at 120 Hz
- If no color wheel spinning, check data transfer on the following lines: MTRDATA, MTRCLK, MTRSELZ.
- Verify phase lock of color wheel by checking rising edge of Index 275 us after Vsync
- If previous steps are verified, microcontroller is OK.
- Verify motor\_spin line from microcontroller to FPGA is logic high.
- Verify hardware LAMPEN to ballast. Lamp type must be set to appropriate type if problems with getting LAMPLIT appear.
- 3.5 seconds after LAMPLIT, DMD should become active (unpark) and display an image.
- Verify reset (HRESETZ, pin 1) from FPGA to microcontroller only goes low once during the lamp strike period. LAMPLIT should be stable after microcontroller last reset.
- If everything else verified, but still no image, perform the following checks:
- Check DMD voltages at output of generation circuits, but also out of SR16 IC (be careful not to probe on pins or the device could be damaged): VBIAS (22-25v), VRESET (-26V), VCC2 (7.5V). Please attached file for reset waveform.
- Check voltage enables from FPGA are active as appropriate. If not, output drivers may be blown from previous probing.
- Be sure two reset lines are not tied together or the device WILL be damaged.
- Verify I2C communication by reading system status and microcontroller version. Verify READY bit in Status Byte.
- Set curtain mode to Full Green and verify green is displayed over entire screen. Repeat for Red and Blue. This checks for functionality of TI electronics between ASIC and DMD.
- If colors are wrong, check color wheel is spinning the correct direction. Put unit in red curtain mode and use a photosensor to verify that red is displayed 220 uS after color wheel Index.
- Use spoke light test register number 0x0E to verify sequence color transitions occur during wheel spoke interval. See Software ICD for register 0x0E.

### Other suggestions:

- Be sure front end electronics are sending one pixel per clock.
- Elastomer and DMD are aligned properly to pads.
- Check data transfer on the following lines: PBCLKZ, PBDAT0, PBDAT1.
- If Color wheel has difficulty in starting or is unstable, the timing capacitors may need to be adjusted to match the motor parameter.

## 12. Timing Chart

Resolution	H Sync (kHz)	V Sync (Hz)	Remark
640x350	31.5	70.1	
640x400	37.9	85.1	VESA
720x400	31.5	70.0	
720x400	37.9	85.1	VESA
640x480	31.5	60.0	VESA
640x480	37.9	72.8	VESA
640x480	35	66.7	Macintosh
640x480	43.3	85.0	VESA
800x600	35.2	56.3	VESA
800x600	37.9	60.3	VESA
800x600	46.9	75.0	VESA
800x600	48.1	72.2	VESA
800x600	53.7	85.1	VESA
832x624	49.7	74.5	Macintosh
1024x768	48.4	60.0	VESA
1024x768	56.5	70.1	VESA
1024x768	60.0	75.0	VESA
1024x768	68.7	85.0	VESA
1280x1024	64.0	60.0	VESA

## DMD Image Specification

### 1. SCOPE

This document specifies the image quality requirements applicable to the DLP™ XGA Component Set. The Component Set provides the DLP™ XGA Projector with digital imaging functionality based on Digital Micromirror Device (DMD) technology.

### 2. Definitions

#### 2.1 Blemish

A blemish is an obstruction, reflection, or refraction of light that is visible, but out of focus in the projected image under specified conditions of inspection (see Table 1). It is caused by a particle, scratch, or other artifact located in the image illumination path.

#### 2.2 Dark pixel

A single pixel or mirror that is stuck in the OFF position and is visibly darker than the surrounding pixels.

#### 2.3 Bright pixel

A single pixel or mirror that is stuck in the ON position and is visibly brighter than the surrounding pixels.

#### 2.4 Unstable pixel

A single pixel or mirror that does not operate in sequence with parameters loaded into memory. The unstable pixel appears to be flickering asynchronously with the image.

#### 2.5 Adjacent pixel

Two or more stuck pixels sharing a common border or common point, also referred to as a cluster.

#### 2.6 Streaks

Artifact resulting from localized variation in mirror tilt angle relative to surrounding mirrors. They are similar in appearance to window scratches but appear at the mirror level. Streaks appear as faint diagonal or arcing patterns in the image.

#### 2.7 Sea of Mirrors (SOM)

SOM is a rectangular array of off-state mirrors surrounding the active area.

#### 2.8 Eyecatcher

A small localized light “spot” which has high spatial frequency and high differential brightness. These are due to various DMD window or window aperture “defects” including: digs, voids, particles and scratches.

#### 2.9 Border Artifacts

All variations of these artifacts are acceptable under this image quality specification.

Border artifacts are a general category of image artifacts that may show up on screen in the area outside of the active array. Border artifacts include: Exposed Bond Wires, Exposed Metal 2, and Reflective Edge.

##### 2.9.1 Bond Wires

Bond Wires attach the die to the superstructure. If visible, they will appear as short light

parallel lines outside of the Sea of Mirrors (SOM).

#### 2.9.2 Exposed Metal 2

Exposed Metal 2 is due to a shift in positioning of either the die or the window aperture which may allow light to be reflected off of the layer of metal 2 that is below the super structure (mirrors). This defect is located at the outer edge of the SOM.

#### 2.9.3 Reflective Edge

Reflective Edge is light that may reflect from the edge of the DMD's window aperture onto the projection screen. It will appear as a thin diffuse line outside of the SOM.

#### 2.10 Two Zone Blue 60 Screen

The Two Zone Blue 60 screen is used to test for major dark blemishes. Refer to Figure 1 for configuration. All areas of the screen are colored a Microsoft Paintbrush blue 60 (green and red set at 0, blue set at 60).

NOTE: If linear degamma is not used then the Microsoft Paintbrush values must be adjusted to match the degamma table being used in order to generate an equivalent blue level on the test screen image.

#### 2.11 Two Zone Gray 10 Screen

The Two Zone Gray 10 screen is used to test for major light blemishes. Refer to Figure 1 for configuration. All areas of the screen are colored a Microsoft Paintbrush gray 10 (green, red, and blue set at 10).

NOTE: If linear degamma is not used then the Microsoft Paintbrush values must be adjusted to match the degamma table being used in order to generate an equivalent gray level on the test screen image.

### 3. ACCEPTANCE REQUIREMENTS

#### 3.1 Conditions of Acceptance

All DMD image quality defects must be determined under the following projected image test conditions:

- a. Projector degamma shall be linear.
- b. Projector error diffusion shall be "off"
- c. Projector brightness and contrast settings shall be set to nominal.
- d. The diagonal size of the projected image shall be a minimum of 60 inches.
- e. The projection screen shall be 1X gain.
- f. The projected image shall be inspected from an 8 feet minimum viewing distance.
- g. The image shall be in focus during all Table 1 tests.

#### 3.2 Test Sequence

Tests shall be run in the sequence listed in Table 1.

TABLE 1. Image Quality Specification

SEQ #	TEST	SCREEN	ACCEPTANCE CRITERIA
1	Major Dark Blemish	Two Zone Blue 60	1. No blemish will be darker than Microsoft Blue 60 in the Critical Zone 2. □ 2 blemishes in the Non-Critical Zone 3. No blemish will be > ½” long/diameter
2	Major Light Blemish	Two Zone Gray 10	1. No blemish will be lighter than Microsoft Gray 10 in the Critical Zone 2. □ 2 blemishes in the Non Critical Zone 3. No blemish will be > ½” long/diameter
3	Eyecatcher	Gray 10	1. No eyecatcher will be lighter than Microsoft Gray 10
	Streaks	Blue 60 Gray 10 White	1. No streaks
	Projected Images	Any screen	1. No adjacent pixels 2. No bright pixels (Active Area) 3. □ 1 bright pixel (SOM) 4. □ 4 dark pixels 5. □ 6 minor blemishes 6. No DMD window aperture shadowing on the Active Area 7. No unstable pixels in Active Area

Notes:

1. Projected blemish numbers include the count for the shadow of the artifact in addition to the artifact itself, so that the count usually represents a single artifact on the window.
2. No blemish shall be more than 5 inches long or have a total area of more than 5 square inches on a 60 inch diagonal projected image. (□ ½ inch for Major Blemish tests)
3. During all Table 1 tests, projected images shall be inspected in accordance with the conditions of inspection specified in Section 3.
4. The rejection basis for all cosmetic DMD defects (scratches, nicks, particles) will be the projected image tests referenced in Table 1.
5. Any other image quality issue not specifically defined in this document shall be acceptable.
6. Black screens shall not be used as a basis for rejecting DMDs for image quality.

## 14. Electrical Interface Character

### Interface Definition

- 15 pin definition of the mini D-sub male for DDC1/2B protocol

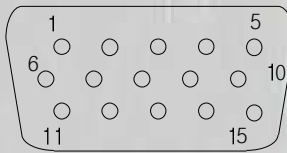

Pin	Definition	Pin	Definition	Pin	Definition	Pin	Definition
1	Red video	2	Green Video	3	Blue Video	4	Monitor ID bit 2
5	Return	6	Red Video Return	7	Green Video Return	8	Blue Video Return
9	+5 Volt Supply (Mandatory Supply)	10	Sync. Return	11	Monitor ID bit 0	12	Bi-directional data (SDA)
13	Horizontal Sync	14	Vertical Sync	15	Data clock (SCL)		

- Video & Component Input



Pi	Definition	Pi	Definition	Pi	Definition
1	Composite video input	2	Audio input (left channel)	3	Audio input (right channel)
4	Luminance video input	5	B-Y Chroma input	6	R-Y Chroma input

- 3.5 mm phone plug is used for stereo audio signal input.
- S-Video input

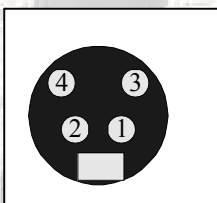

Pin	Description
1	GND
2	GND
3	Luminance
4	Chroma

- Control Port

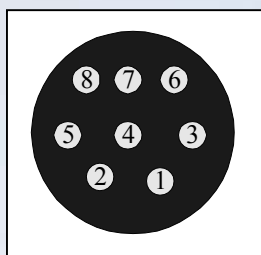

Pin	Description	Pin	Description
1	Reserved	2	Reserved
3	TX	4	Reserved
5	Reserved	6	Reserved
7	RX	8	GND

## 15. Final Assembly Alignment Procedure

Unless other specified, all alignments should meet the following conditions:

1. All power on and power off condition should be last for more than 5 minute. i.e. no power on is permitted if UUT(Unit under test) had not been power off and last for more than 5 minute since last power on.
2. Brightness and contrast should be measured only 5 minute or more after lamp is on.
3. UUT should be placed at a distance ranges from 1.5 to 5 meter.
4. Applied timing should be 1024\*768 @65Hz (XGA); 800\*600@60Hz (SVGA)

Before test, be sure the following configurations are done properly:

1. Turn off light in test chamber.
2. Test chamber condition as per ANSI IT7.215-1992.
3. Connect DSUB cable to Graphics port of UUT.
4. Connect stereo input to stereo input of UUT.
5. Connect RCA terminal to Video input of UUT.
6. Connect S terminal to S-Video input of UUT.
7. Connect AC power cord to UUT.

### (A) Video EE Check

Equipment: VG828, DVD Player

Aspect Ratio: 4:3

Channel	Prime Mode	Timing	Pattern	Item	Criteria
Composite Video	*	NTSC (H: 15.73KHz, 29.96Hz, I)	PT2 Master Pattern	Gray	0-100%
				H&V Res.	1 Line
				Color	Hue, Sat need correct Color Noise Acceptable
				Smear	Not acceptable
				Linearity	As optical spec
				Jitter, Swing, Snack, Ring, Cross-talk	Only Color Noise Acceptable
				PT976 64Gray & Color	Gray & Color Check
	PT863 Text	EM Character	EM distinguish Color Noise Acceptable		
	Movie	Video Essential			
		PAL (H: 15.63KHz, 25Hz, I)	PT2 Master Pattern	Gray	0-100%
				H&V Res.	1 Line
				Color	Hue, Sat need correct Color Noise Acceptable
				Smear	Not acceptable
				Linearity	As optical spec
Jitter, Swing, Snack, Ring, Cross-talk				Only Color Noise Acceptable	



Channel	Prime Mode	Timing	Pattern	Item	Criteria	
S-Video	*	NTSC (H: 15.73KHz, 29.96Hz, I)	PT2 Master Pattern	Gray	0-100%	
				H&V Res.	1 Line	
				Color	Hue, Sat need correct	
				Smear	Not acceptable	
				Linearity	As optical spec	
				Jitter, Swing, Snack, Ring, Cross-talk	Not Acceptable	
				PT976 64Gray & Color	Gray & Color Check	64 Step
				PT863 Text	EM Character	EM distinguish
	Movie	Video Essential				
	PAL (H: 15.63KHz, 25Hz, I)	PT2 Master Pattern	Gray	0-100%		
			H&V Res.	1 Line		
			Color	Hue, Sat need correct		
			Smear	Not acceptable		
			Linearity	As optical spec		
Jitter, Swing, Snack, Ring, Cross-talk			Not Acceptable			
PT976 64Gray & Color			Gray & Color Check	64 Step		
PT863 Text			EM Character	EM distinguish		
Movie	Video Essential					
YcbCr	*	NTSC (H: 15.73KHz, 29.96Hz, I)	PT2 Master Pattern	Gray	0-100%	
				H&V Res.	1 Line	
				Color	Hue, Sat need correct	
				Smear	Not acceptable	
				Linearity	As optical spec	
				Jitter, Swing, Snack, Ring, Cross-talk	Not Acceptable	
				PT976 64Gray & Color	Gray & Color Check	64 Step
				PT863 Text	EM Character	EM distinguish
	Movie	Video Essential				
	PAL (H: 15.63KHz, 25Hz, I)	PT2 Master Pattern	Gray	0-100%		
			H&V Res.	1 Line		
			Color	Hue, Sat need correct		
			Smear	Not acceptable		
			Linearity	As optical spec		
Jitter, Swing, Snack, Ring, Cross-talk			Not Acceptable			
PT976 64Gray & Color			Gray & Color Check	64 Step		
PT863 Text			EM Character	EM distinguish		
Movie	Video Essential					
YPbPr	*	480p (H: 31.54KHz, 60.08Hz, p)	PT2 Master Pattern	Gray	0-100%	
				H&V Res.	1 Line	
				Color	Hue, Sat need correct	
				Smear	Not acceptable	
				Linearity	As optical spec	
				Jitter, Swing, Snack, Ring, Cross-talk	Not Acceptable	
				PT976 64Gray & Color	Gray & Color Check	64 Step
				PT863 Text	EM Character	EM distinguish
				Movie	Video Essential	
				Movie	Video Essential	

			PT863 Text	EM Character	EM Clear
			Movie	Video Essential	
	720p (H: 45.00KHz, 60Hz, p)	PT2 Master Pattern	Gray	H&V Res.	0-100% 2 Line
			Color	Smear	Hue, Sat need correct Not acceptable
			Linearity	Jitter, Swing, Snack, Ring, Cross-talk	As optical spec Not Acceptable
	1080i (H: 33.75KHz, 30Hz, I)	PT2 Master Pattern	Gray	H&V Res.	0-100% 4 Line
			Color	Smear	Hue, Sat need correct Not acceptable
			Linearity	Jitter, Swing, Snack, Ring, Cross-talk	As optical spec Only interlace jitter acceptable

(B) PC EE Check:

Equipment: Chroma 2250, CL-100

Aspect Ratio: 4:3

Channel	Prime Mode	Timing	Pattern	Item	Criteria	
DSB	*	1024*768@8 5Hz (68.677KHz, 84.997Hz)	PT5 SMPTE 3	Gray	0-100%	
				H&V Res.	1 Line	
				Color	Hue, Sat need correct	
				Smear	Not acceptable	
				Linearity	As optical spec	
				Jitter, Swing, Snack, Ring, Cross-talk	Not Acceptable	
			PT48 32 Gray	Gray Check	32 Step	
			PT85 Text	Character	Clear	
			PT46 10 Gray	ColorTemp@80 %Gray		
				Cool (1)	(0.272,0.283) ±0.02	
				Standard (2)	(0.281,0.311) ±0.02	
				Warm (3)	(0.313,0.329) ±0.02	
			Picture Phone Lady	Picture check		
			640*400@70 Hz (31.47KHz, 70.08Hz)	PT2 Master Pattern	Gray	0-100%
					H&V Res.	1 Line
Color	Hue, Sat need correct					
Smear	Not acceptable					
Linearity	As optical spec					
Jitter, Swing, Snack, Ring, Cross-talk	Not Acceptable					
640*480@60 Hz	PT2 Master Pattern	Gray	0-100%			
		H&V Res.	1 Line			

	(31.469KHz, 59.94Hz)		Color	Hue, Sat need correct
			Smear	Not acceptable
			Linearity	As optical spec
			Jitter, Swing, Snack, Ring, Cross-talk	Not Acceptable
	640*400@85 Hz (43.269KHz, 85.008Hz)	PT2 Master Pattern	Gray	0-100%
			H&V Res.	1 Line
			Color	Hue, Sat need correct
			Smear	Not acceptable
			Linearity	As optical spec
			Jitter, Swing, Snack, Ring, Cross-talk	Not Acceptable
	800*600@60 Hz (37.879KHz, 60.317Hz)	PT2 Master Pattern	Gray	0-100%
			H&V Res.	1 Line
			Color	Hue, Sat need correct
			Smear	Not acceptable
			Linearity	As optical spec
			Jitter, Swing, Snack, Ring, Cross-talk	Not Acceptable
	800*600@75 Hz (46.875KHz, 75Hz)	PT2 Master Pattern	Gray	0-100%
			H&V Res.	1 Line
			Color	Hue, Sat need correct
			Smear	Not acceptable
			Linearity	As optical spec
			Jitter, Swing, Snack, Ring, Cross-talk	Not Acceptable
	800*600 @85Hz (53.67KHz, 85.06Hz)	PT2 Master Pattern	Gray	0-100%
			H&V Res.	2 Line
			Color	Hue, Sat need correct
			Smear	Not acceptable
			Linearity	As optical spec
			Jitter, Swing, Snack, Ring, Cross-talk	Not Acceptable
	1024*768@6 0Hz (48.4KHz, 60Hz)	PT2 Master Pattern	Gray	0-100%
			H&V Res.	2 Line
			Color	Hue, Sat need correct
			Smear	Not acceptable
			Linearity	As optical spec
			Jitter, Swing, Snack, Ring, Cross-talk	Not Acceptable
	1024*768@7 5Hz (60.023KHz, 75.029Hz)	PT2 Master Pattern	Gray	0-100%
			H&V Res.	2 Line
			Color	Hue, Sat need correct
			Smear	Not acceptable
			Linearity	As optical spec
			Jitter, Swing, Snack, Ring, Cross-talk	Not Acceptable

(C) Optical Check

Equipment: Chroma 2250, CL-100

Aspect Ratio: 4:3

User OSD setting: (PC), 30 gray

Final Check				
Step	Screen	Check Items	Acceptance Criteria	Equipment
1. Brightness	100% W Pattern	ANSI Lumens	$\geq 450$ @PC mode	
		Uniformity	$\geq 70\%$	
2. Contrast Ratio	Checker Board	ANSI C/R	$\geq 130:1$	
3. Color	R Pattern	Chromaticity Coordinate x, y	$\square \leq 0.04$	
	G Pattern	Chromaticity Coordinate x, y	$\square \leq 0.04$	
	B Pattern	Chromaticity Coordinate x, y	$\square \leq 0.04$	
	100% W Pattern	Chromaticity Coordinate x, y	$\square \leq 0.04$	
		Uniformity	$\square \leq 0.04$	
	50% W Pattern	Chromaticity Coordinate x, y	$\square \leq 0.04$	
4. DMD	Blue 180 Pattern	Dark Blemish	$\leq 6$	
		Dark pixel	$\leq 4$	
	Gray 30 Pattern	Bright Blemish	$\leq 6$	
		Bright pixel	$= 0$	

Inspection				
Step	Check Items	Acceptance Criteria	Equipment	
1. Appearance	CHK Appearance	C315		
2. Button	CHK Functionality	Shinning and No Stuck		
3. Front / Rear Foot	CHK Functionality	Adjustable		
4. Zoom / Focus Ring	CHK Functionality	Adjustable		
5. CFM	Measure Air Flow	$\geq$ TBD CFM		
6. PC	SMPTE133 Pattern	Jitter	PC	
		Geometry		
		Focus/Ring		
	Color Ramp Pattern	Stuck Bit		
Flashing				
Phone Lady picture	Tint			
	General Picture Quality			
7. Video (RCA, S-Video)	Static pattern (SMPTE133 Pattern)	Flicker		DVD Player
		Stuck Bit		
	Dynamic movie (Toy Story/ Video Essential)	Tint		
		Noise		
8. Audio		Input / Output	DVD Player	
			PC input	
9. OSD/Remote			High Power Generator	
10. Hi-Pot				

## 16. PACKING DESCRIPTION

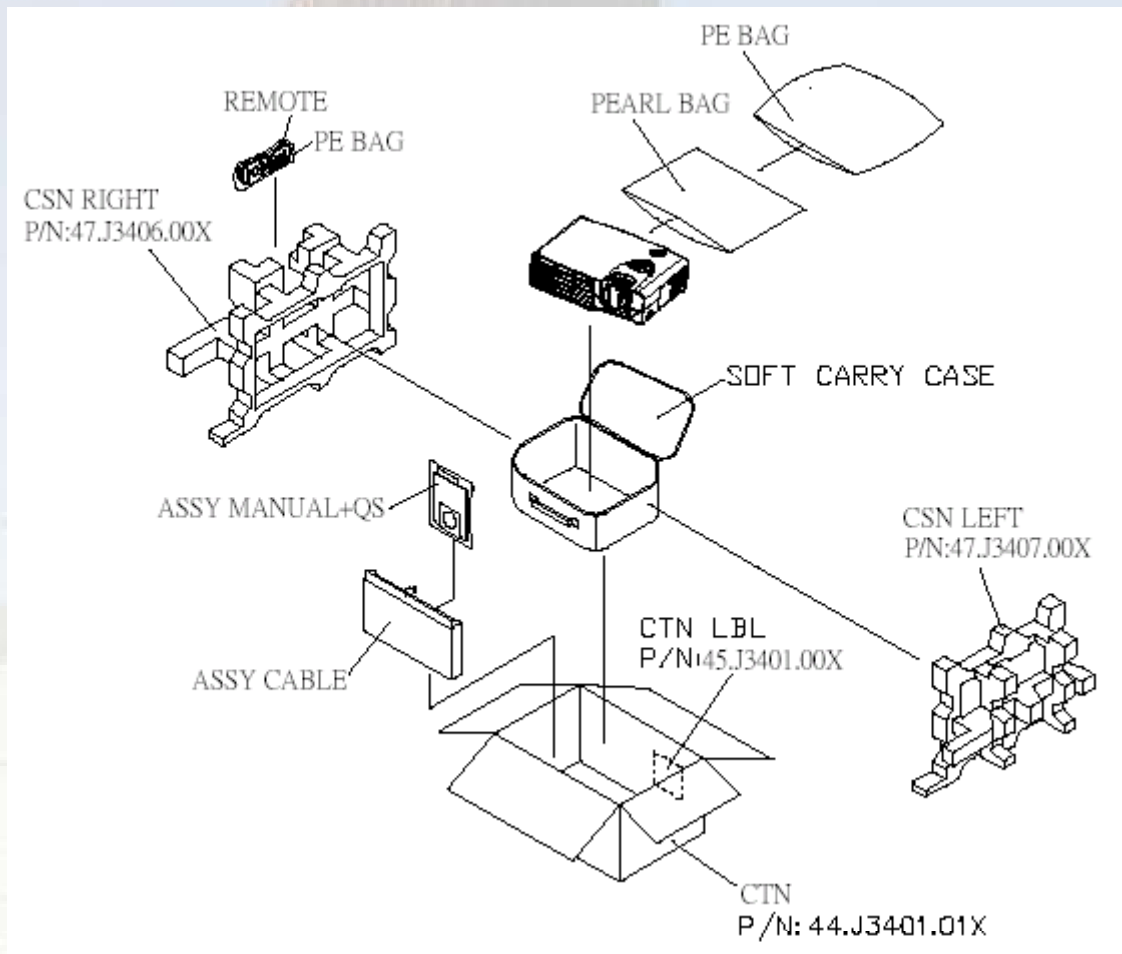

### CTN LBL PRINTING:

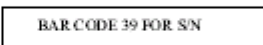
<b>Model Name:</b>	<b>RD-JT40</b>	
<b>Resolution :</b>	<b>XGA</b>	Made in Taiwan
<b>S/N: YMMACXXXXX</b>		
		<b>OTHER</b>

P/N:45.L2701.001

**Model Name: RD-JT41**

**Resolution : SVGA**

Made in Taiwan

S/N: YMMACXXXXX

BAR CODE 39 FOR S/N

**OTHER**

P/N:45.L2701.001

## 17. APPEARANCE DESCRIPTION

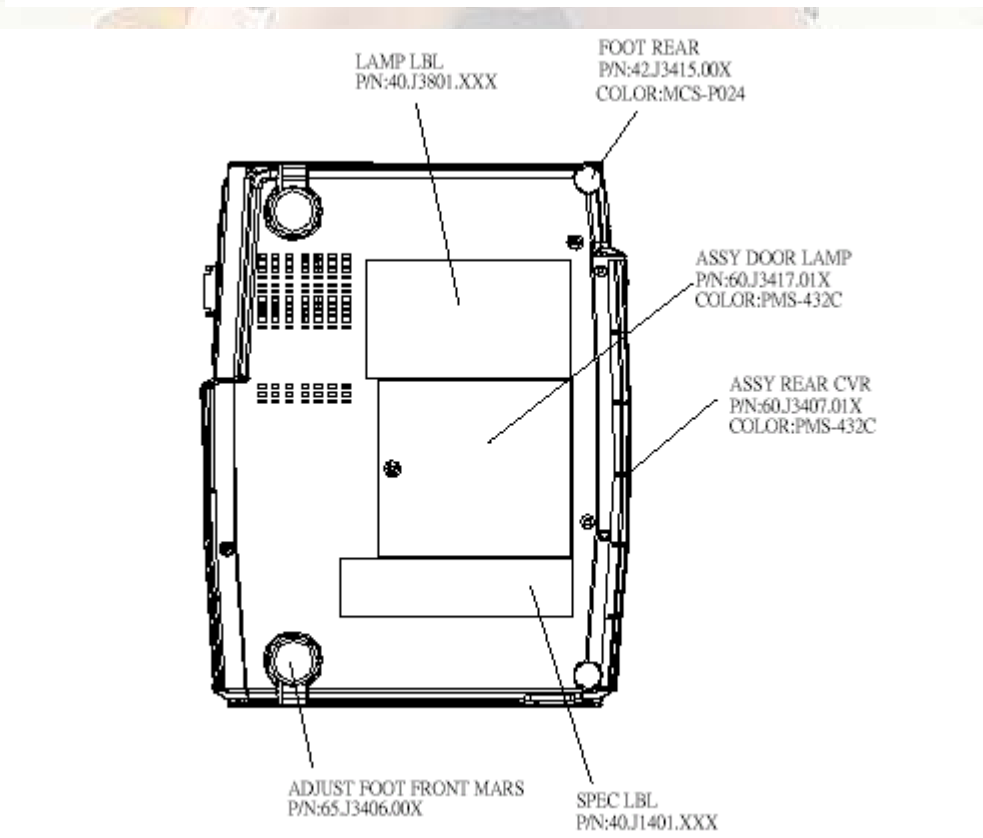
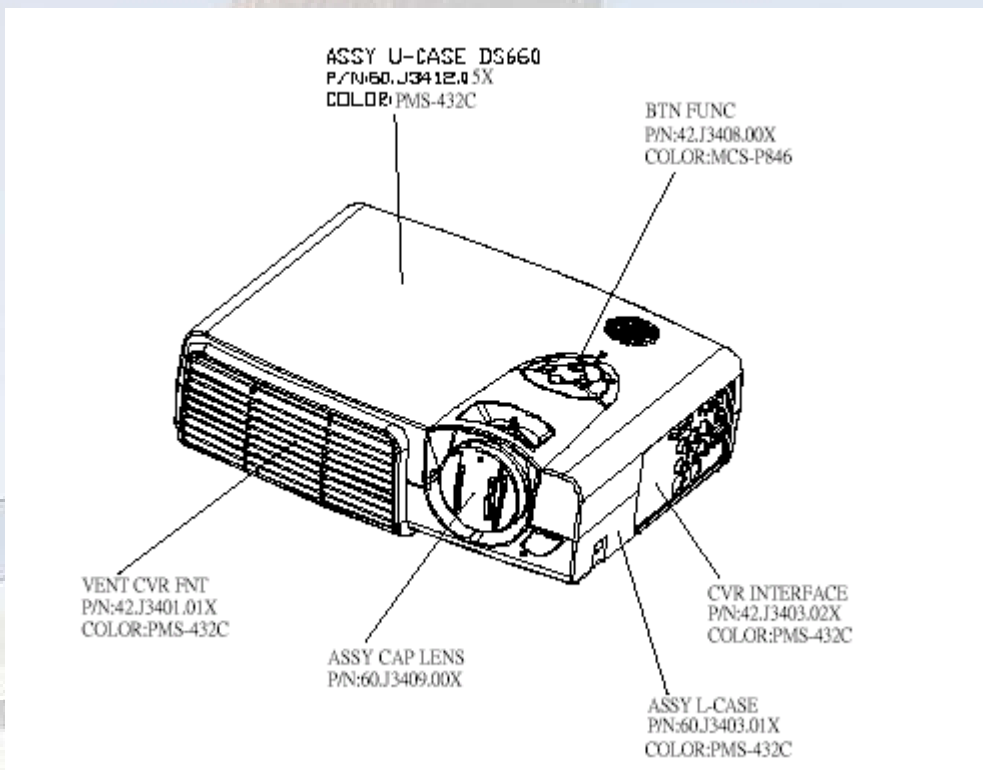

**SPEC LBL PRINTING**

**Model No.: RD-JT40**  
**Manufacturer: LG**  
**AS Rating: ~ 150000**  
**Model No.: YMMACXXXX**  
**Ship Date: October 2002**  
**Made in Taiwan**

**FC** Total No. Output: 150000  
**UL** LISTED  
**CE**  
**GS**  
**CCC**

**BAR CODE 35 (DGA+ SERIAL NO.)**  
**40.J1401.082**

**PLANT CODE: H=BQY**  
**P=BQM**  
**T=BQS**  
**X=BQX**

**YEAR (2002)**  
**YMMACXXXX**  
**MONTH**      **FIXED**      **SERIAL NO**  
 (every month need to reset back 00001 counting by both XGA and BVGA together)

**LAMP LBL PRINTING**

65 mm

121 mm

**Lamp Unit: 60.J3804.001**

**HAZARD VOLTAGE / HAZARD TEMPERATURE / HAZARD PRESSURE**  
**HAZARD TENSJON / HAZARD TEMPERATURERISIKO / HAZARD PRESSJON**  
**HAZARD VOLTAGE / HAZARD TEMPERATURE / HAZARD PRESSURE**  
**HAZARD TENSJON / HAZARD TEMPERATURERISIKO / HAZARD PRESSJON**

**Lamp: Ushio Inc.**  
**Type No.: NSH 210MD**

**P/N: 40.J3801.001**



## 18. Dimensions

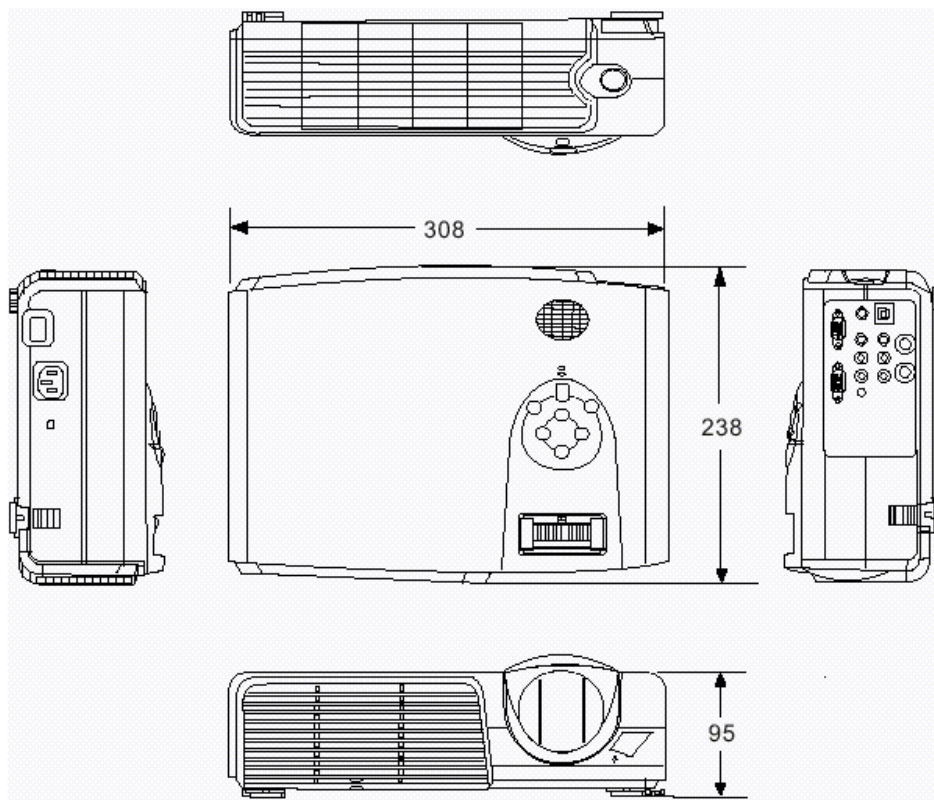

Unit: mm

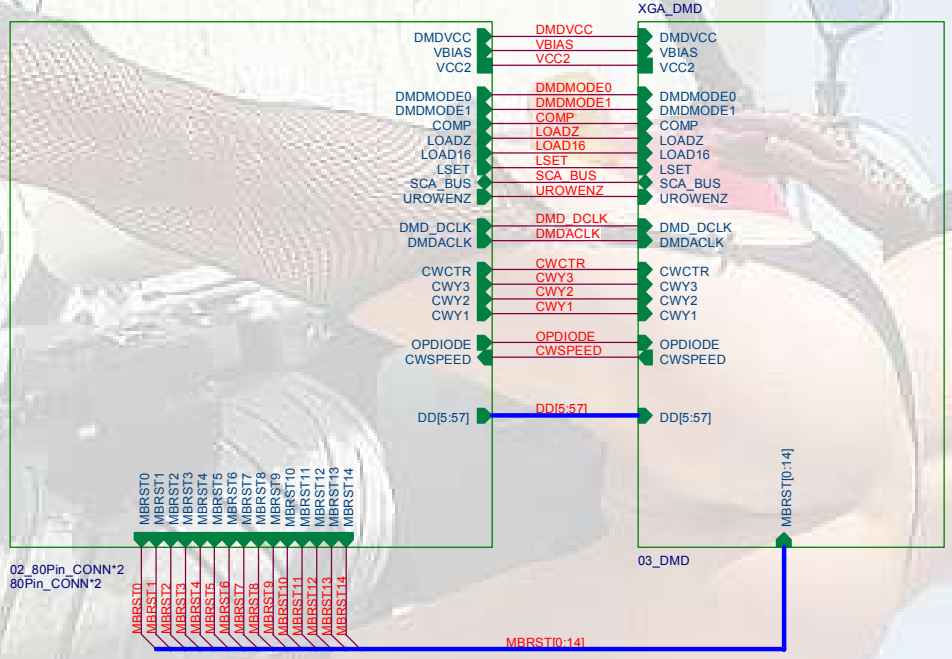

Project Code					99.J3877.001				
Title					DS660 DMD CHIP BD				
Size	Document Number		48.J3802.S01		FAB:S01		Rev		0
A3	304-C01								
Date: Monday, March 25, 2002			Sheet		1 of 4				
Prepared By		Reviewed By		Approved By					
ANGEL HU		BILL WJ CHANG		T.S.WU					

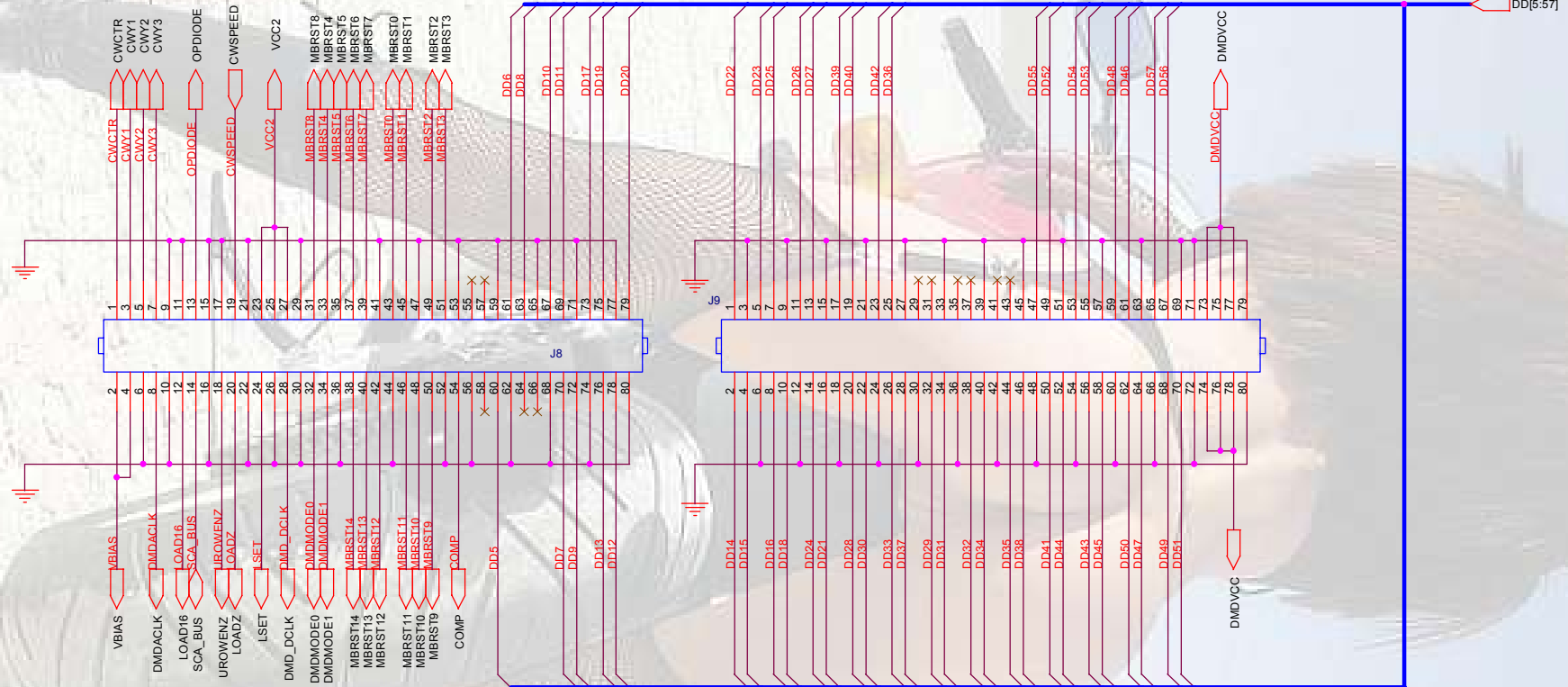

Project Code		99.J3877.001		
Title		DS660 DMD CHIP BD		
Size	Document Number	48.J3802.S01	FAB:S01	Rev
A3	304-C01			0
Date:	Monday, March 25, 2002	Sheet	2	of 4
Prepared By	ANGEL HU	Reviewed By	BILL WJ CHANG	Approved By
				T.S.WU

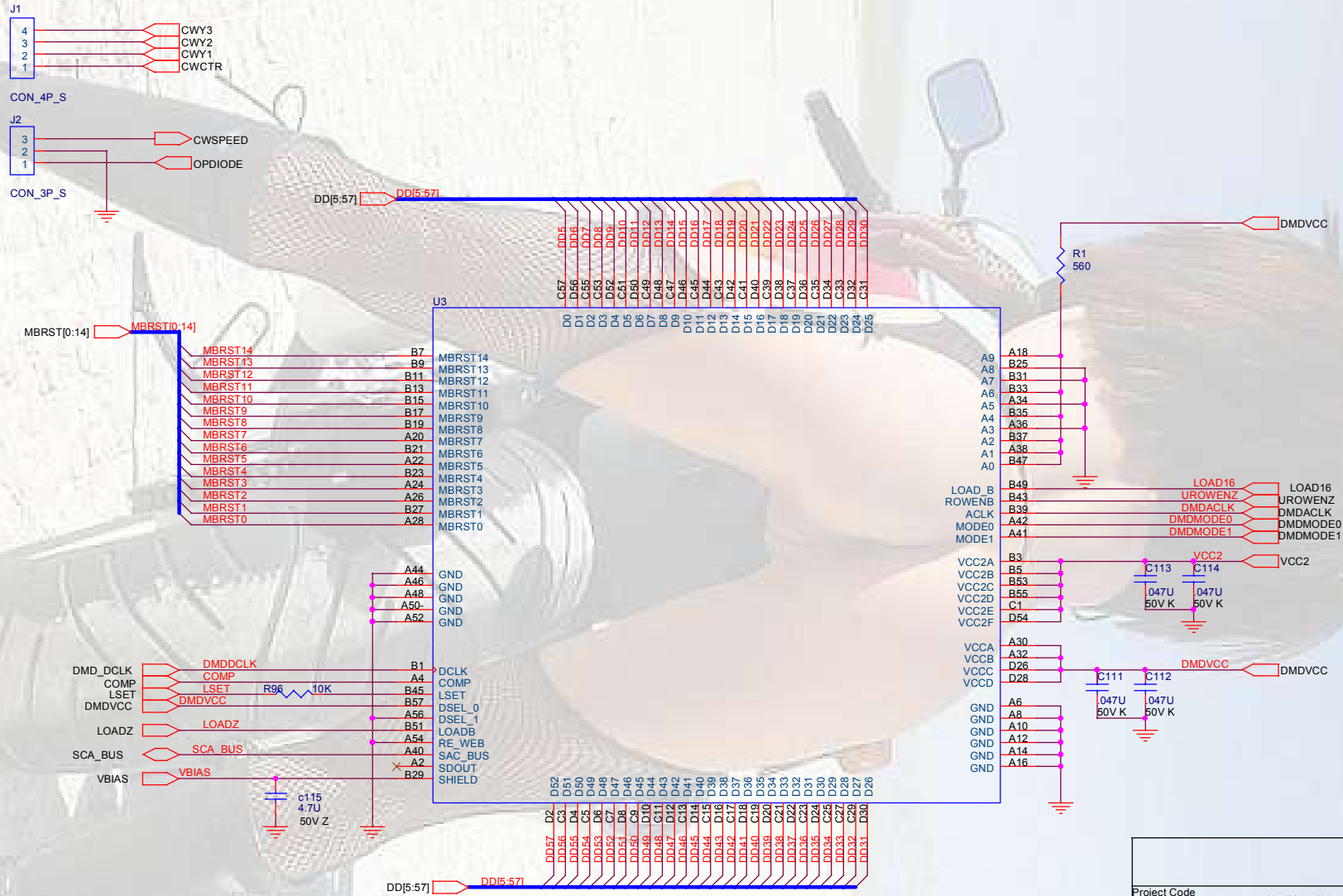

Project Code		99.J3877.001		
Title		DS660 DMD CHIP BD		
Size	Document Number	48.J3802.S01	FAB:S01	Rev
A3	304-C01			0
Date:	Monday, March 25, 2002	Sheet	3 of 4	
Prepared By	ANGEL HU	Reviewed By	BILL WJ CHANG	Approved By
				T.S.WU

Screw Holes

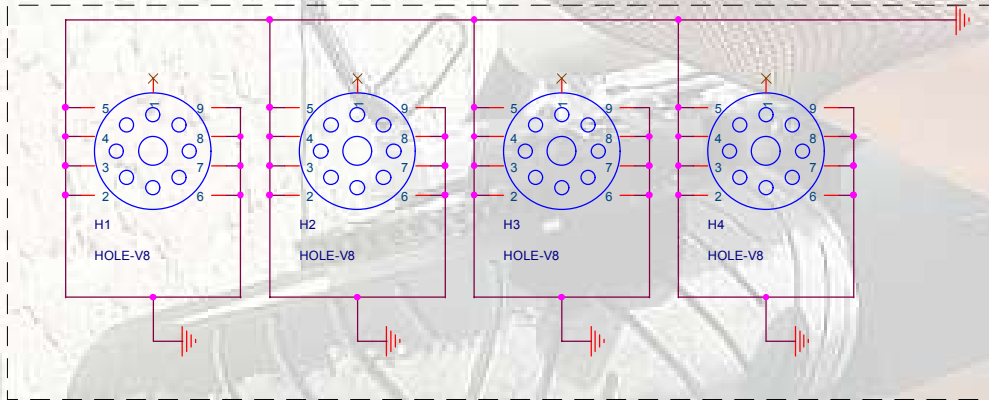

Optical Points



Project Code					99.J3877.001				
Title					DS660 DMD CHIP BD				
Size	Document Number				48.J3802.S01	FAB:S01	Rev		
A3	304-C01						0		
Date: Monday, March 25, 2002				Sheet		4 of 4			
Prepared By			Reviewed By			Approved By			
ANGEL HU			BILL WJ CHANG			T.S.WU			

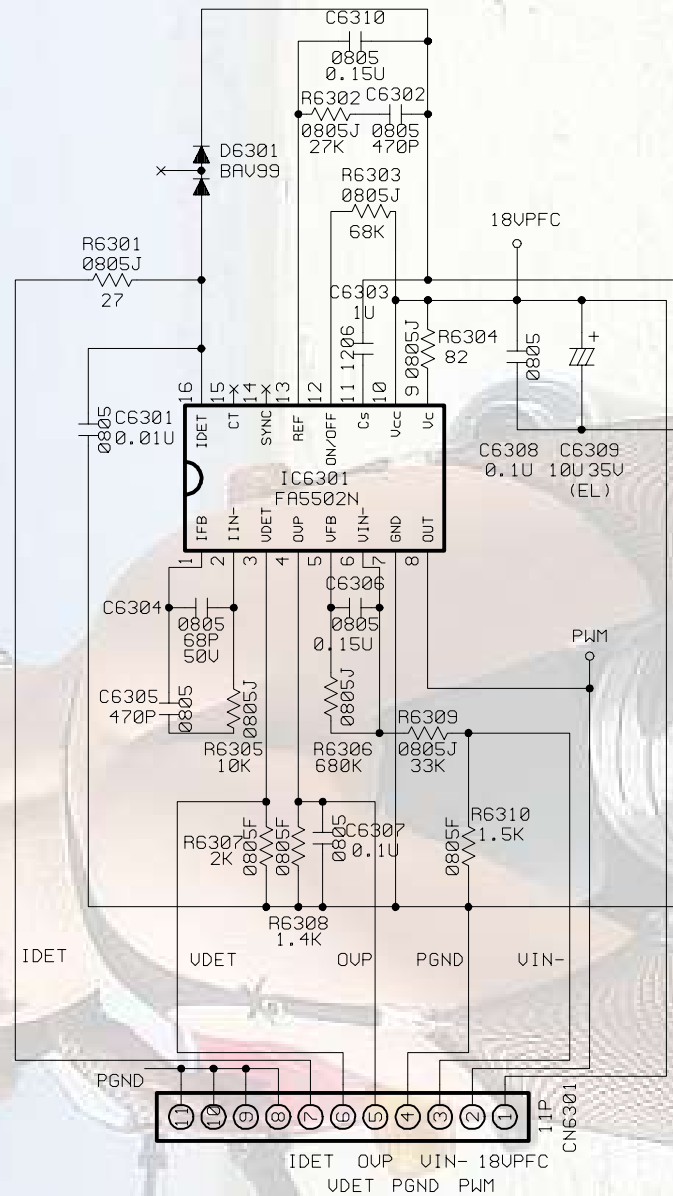

- NOTES
1. Resistor values are in ohm, K=1,000 ohm, M=1,000,000 ohm
  2. All resistors are 1/8 watt, 5% except where otherwise indicated
  3.  $\nabla$   $\nabla$   $\nabla$  Represents PCB common ground.

DS660 PFC CONTROL BD SCHEMATICS				
SIZE A4	J3407A00.SCH	FAB A00	Doc.No. 304-C07	REV. 0
DATE : 10/3/2002		Sheet	1	OF 1
Project Code. 99.J3877.001				
Prepared By ANGEL HU 10/3/2002		Reviewed By KEN JA CHEN 10/3/2002		Approved By JACK CHEN 10/3/2002

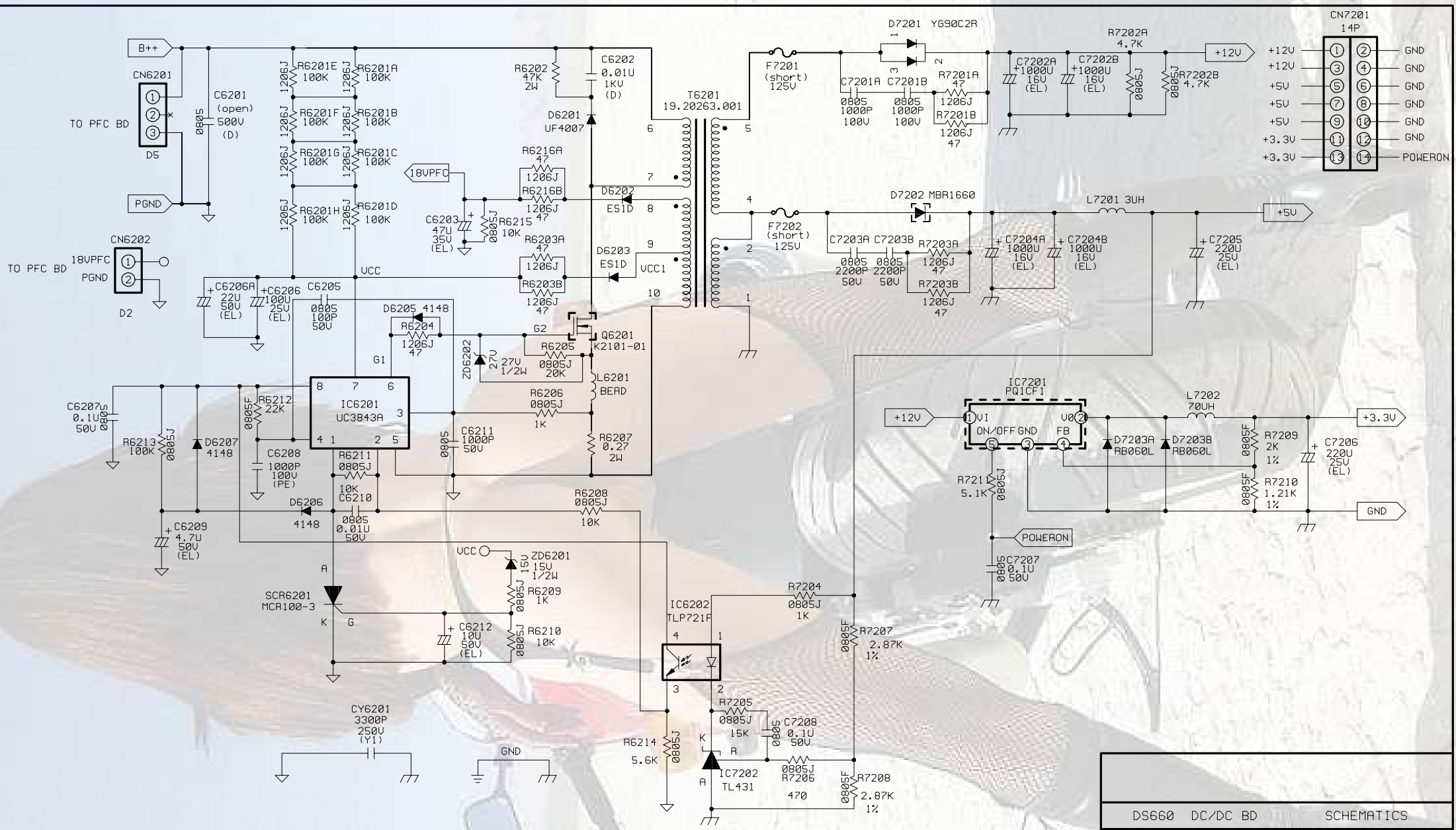

NOTES: 1. Resistor values are in ohm, K=1,000 ohm, M=1,000,000 ohm  
 2. All resistors are 0805, 5% except where otherwise indicated  
 3.  $\perp$   $\nabla$   $\equiv$  Represents PCB common ground.

DS660 DC/DC BD		SCHEMATICS		
SIZE A4	J3408A00.SCH	FAB A00	Doc.No. 304-C08	REV. 0
DATE : 10/3/2002		Sheet	1	OF 1
Project Code. 99.J3877.001				
Prepared By ANGEL HU 10/3/2002		Reviewed By KEN JA CHEN 10/3/2002		Approved By JACK CHEN 10/3/2002

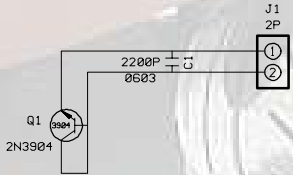
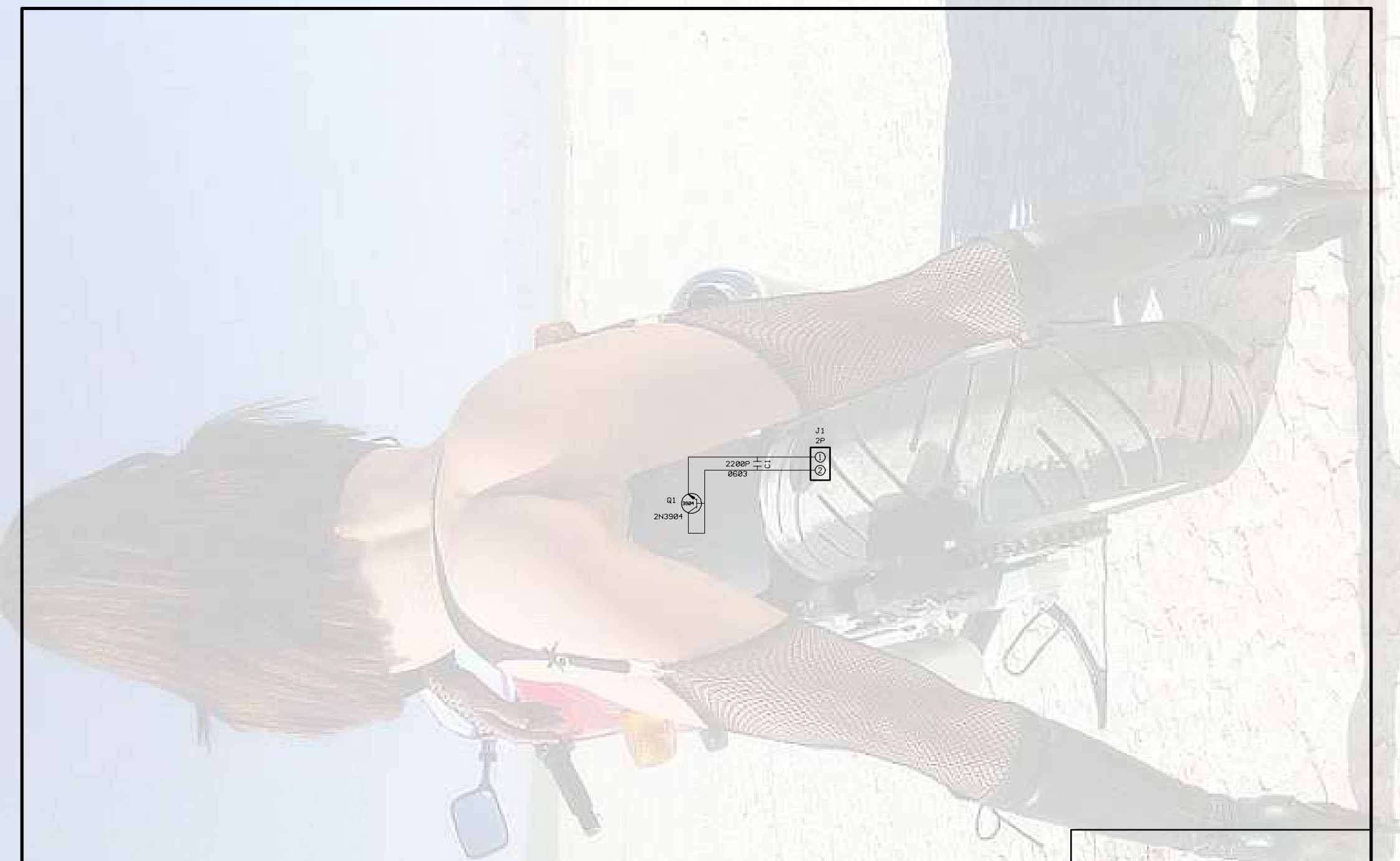

DS660 THERMAL BD SCHEMATICS				
SIZE A3	J3419A01.SCH	FAB A01	Doc.No. 304-C09	REV. 0
DATE : 10/3/2002		Sheet 1 OF 1		
Project Code. 99.J3877.001				
Prepared By ANGEL HU 10/3/2002		Reviewed By JOHN LIN 10/3/2002		Approved By T.S WU 10/3/2002



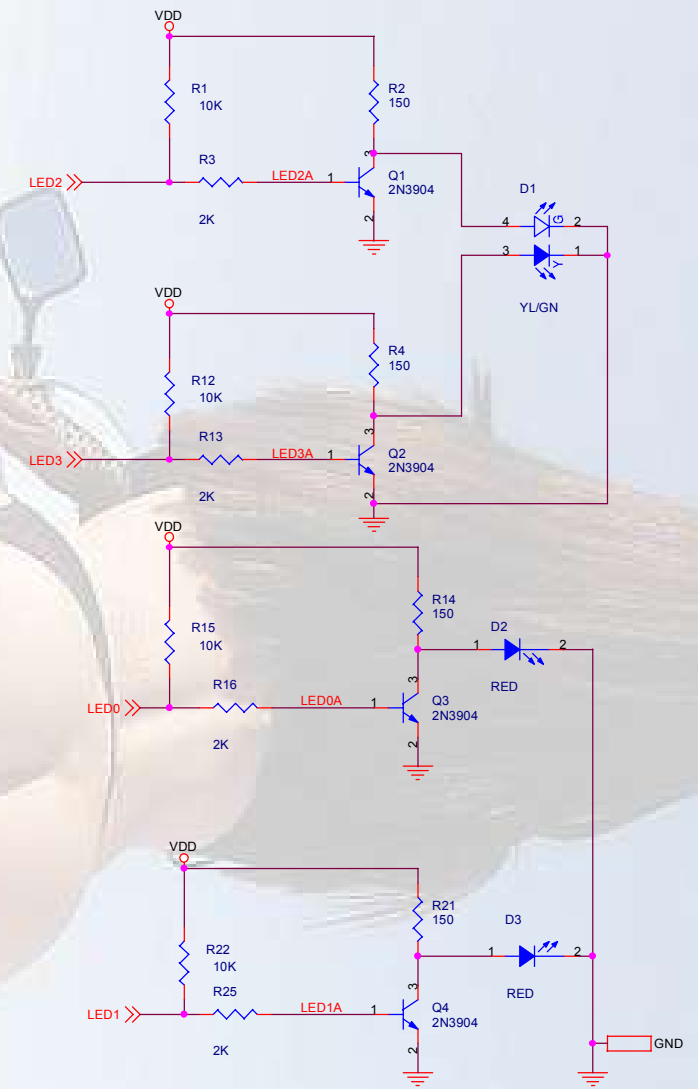
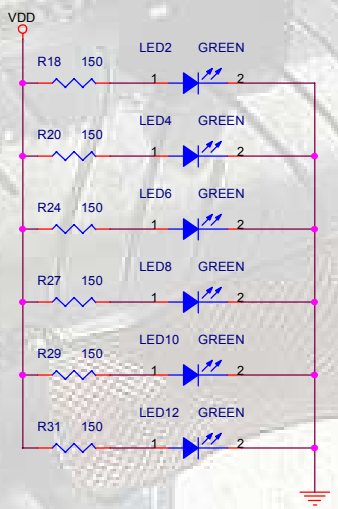
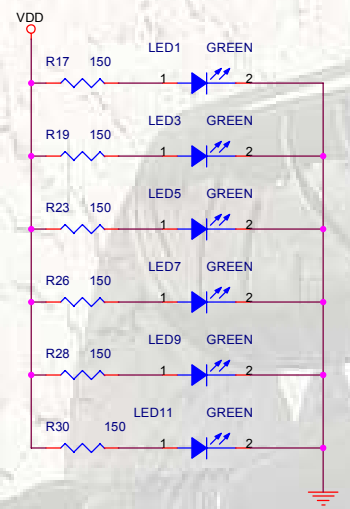
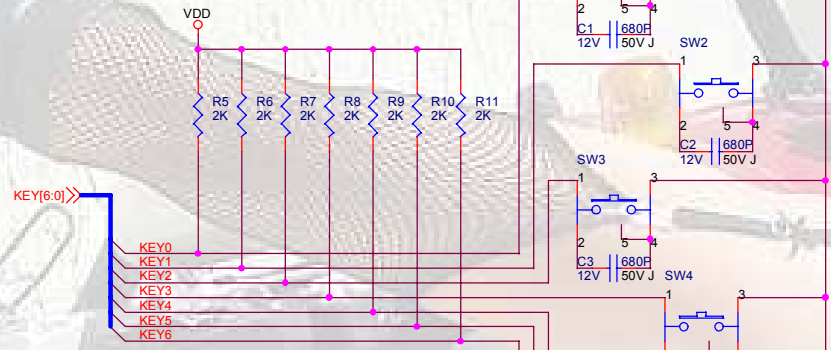
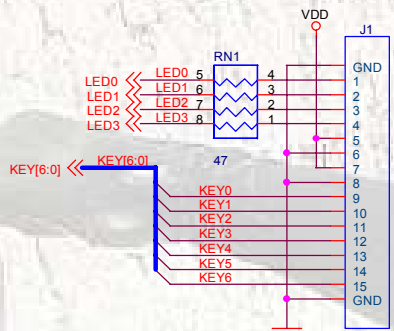

Project Code		99-J2077-001		
Title				
DX660		KEYPAD BD SCHEMatics		
Size	Document Number	48.J3403.S01	FAB:S01	Rev
A3	304-C01			0
Date: Saturday, March 02, 2002		Sheet	1 of 2	
Prepared By		Reviewed By	Approved By	
ANGEL HU		BILL WJ CHANG	H.C.TSOU	

Optical Points

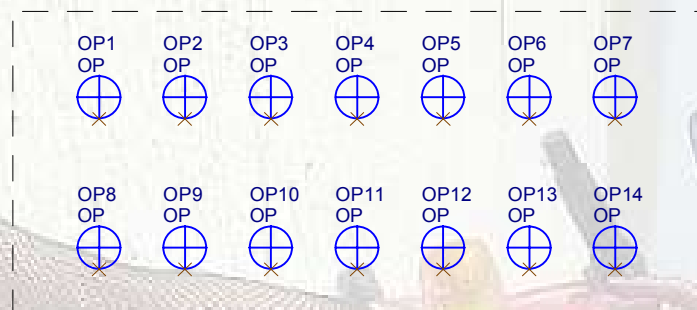

Screw Holes

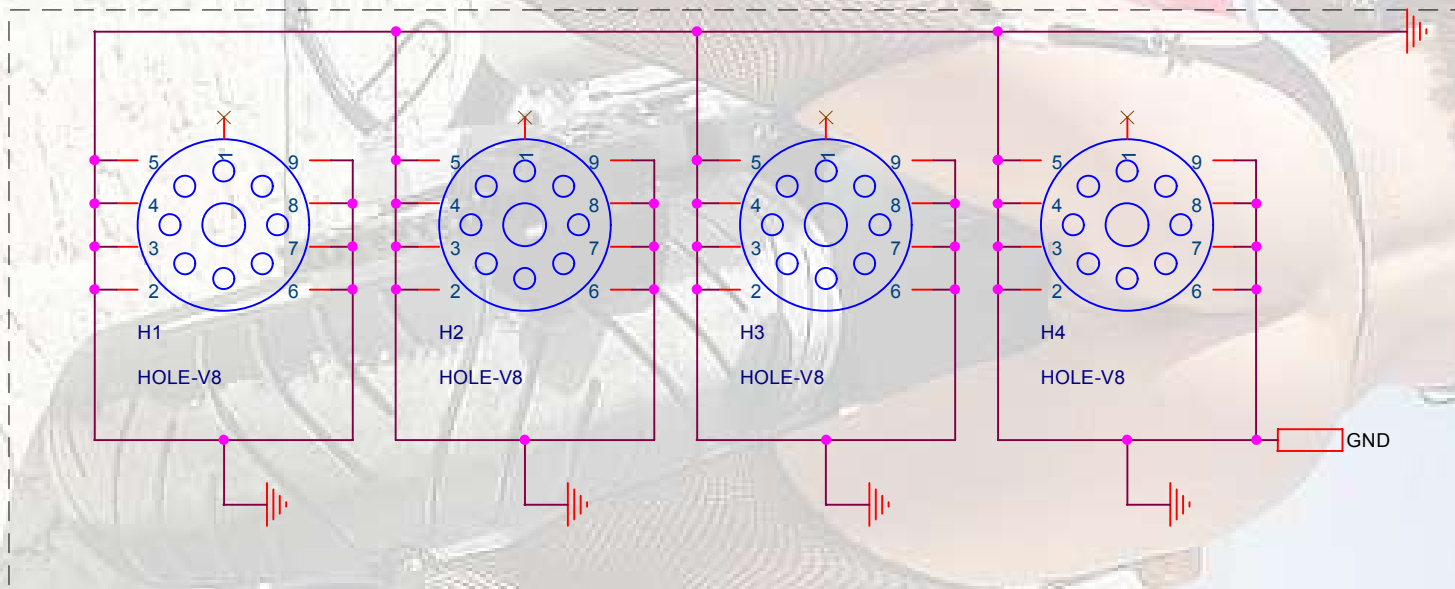

Project Code		99.J2077.001	
Title			
DX660		KEYPAD BD SCHEMAICS	
Size	Document Number		Rev
A3	304-C01	48.J3403.S01	FAB:S01 0
Date:	Saturday, March 02, 2002	Sheet	2 of 2
Prepared By	Reviewed By	Approved By	
ANGEL HU	BILL WJ CHANG	H.C.TSOU	

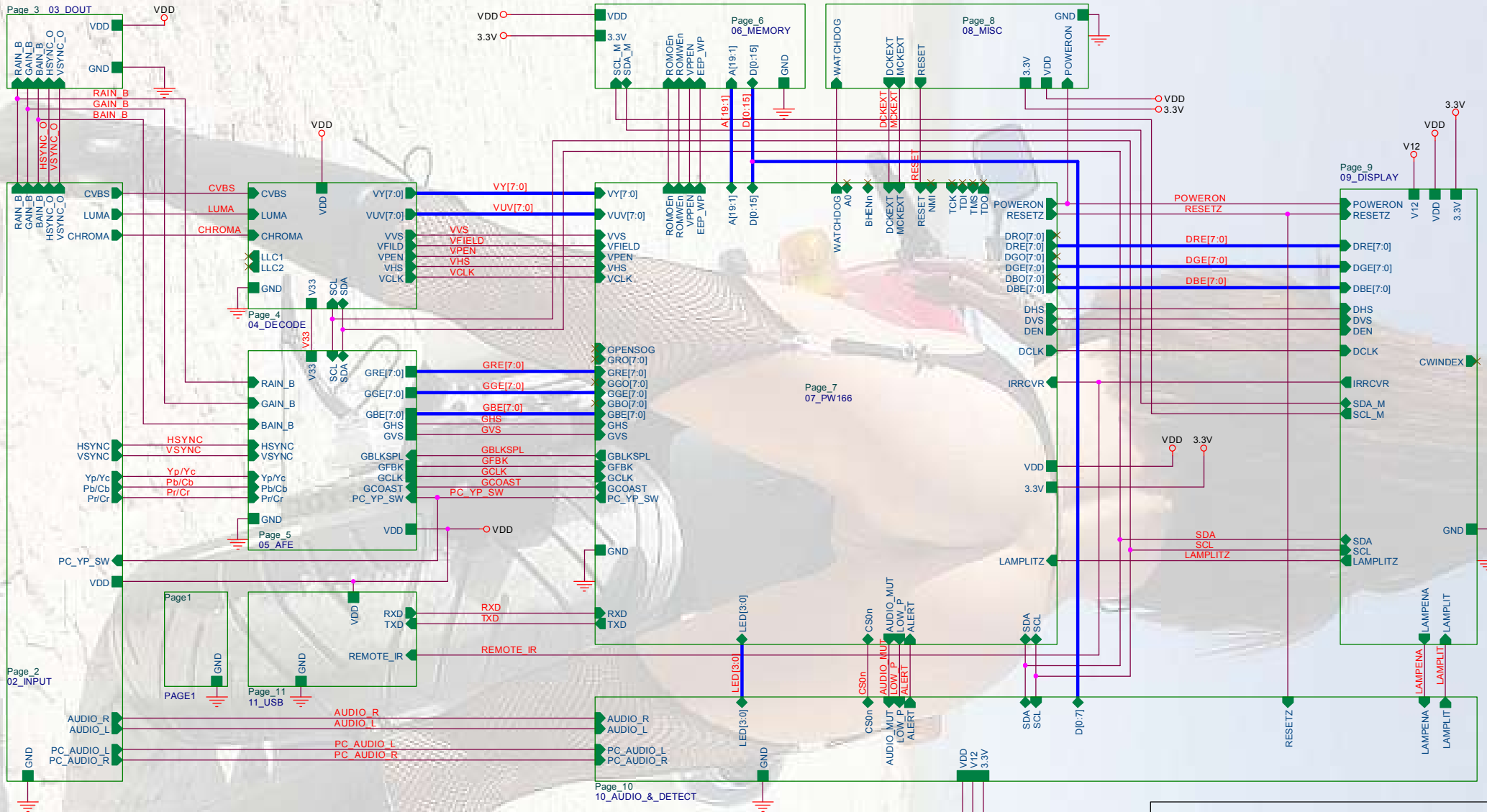

Project Code	99.J3477.001	Model Name	DX660	OEM/ODM Model Name	NA
Title MAIN BD					
Size	PCB P/N 48.J3402.S03	PCB Rev.	S03	Document Number	304-C02
Rev.	1				
Date:	Tuesday, May 21, 2002	Sheet	1	of	12
Prepared By	ANGEL HU	Reviewed By	BILL WJ CHANG	Approved By	T.S.WU

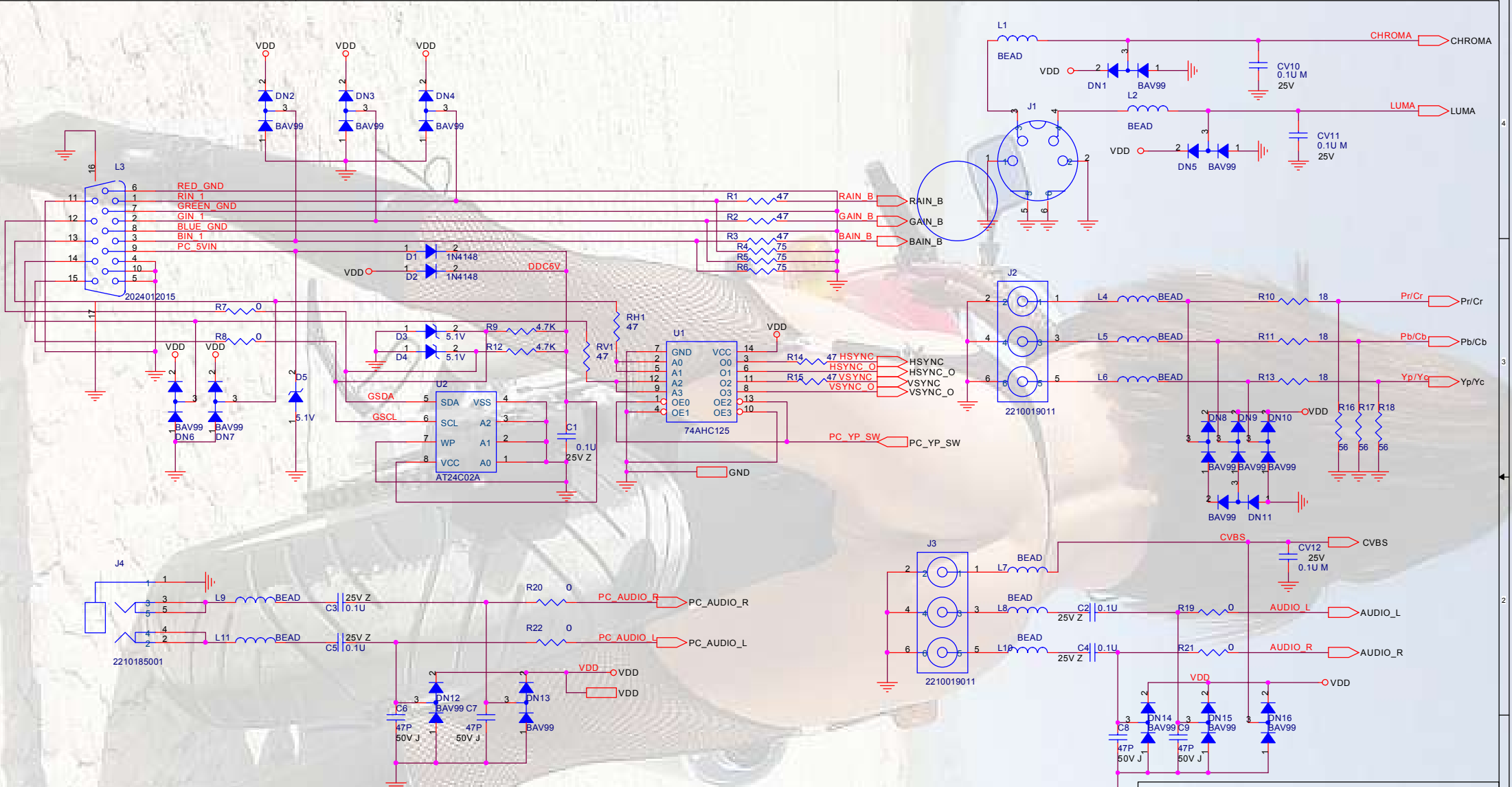

Project Code 99.J3477.001		Model Name DX660		OEM/ODM Model Name NA	
Title MAIN BD					
Size <Size>	PCB P/N 48.J3402.S03	PCB Rev. S03	Document Number 304-C02	Rev. 1	
Date: Tuesday, May 21, 2002			Sheet 2 of 12		
Prepared By ANGEL HU		Reviewed By BILL WJ CHANG		Approved By T.S.WU	

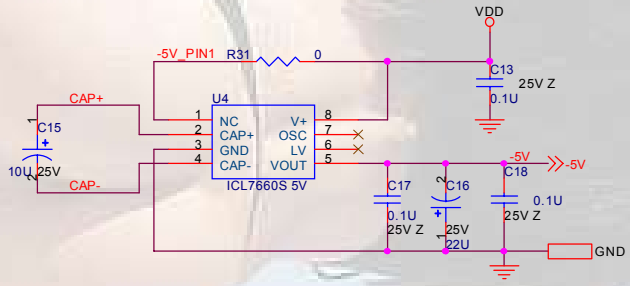
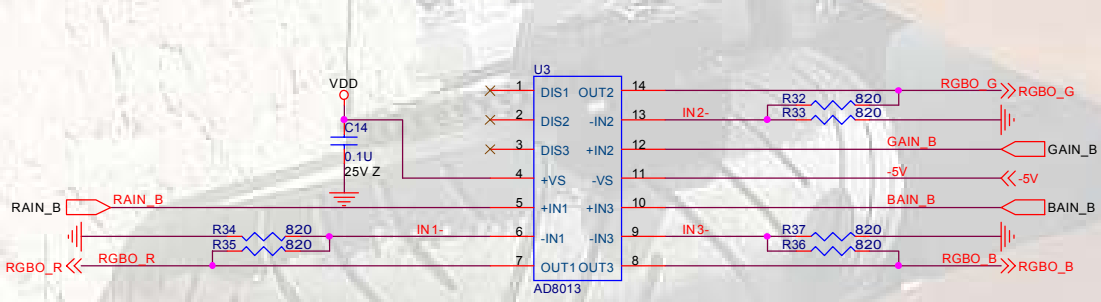
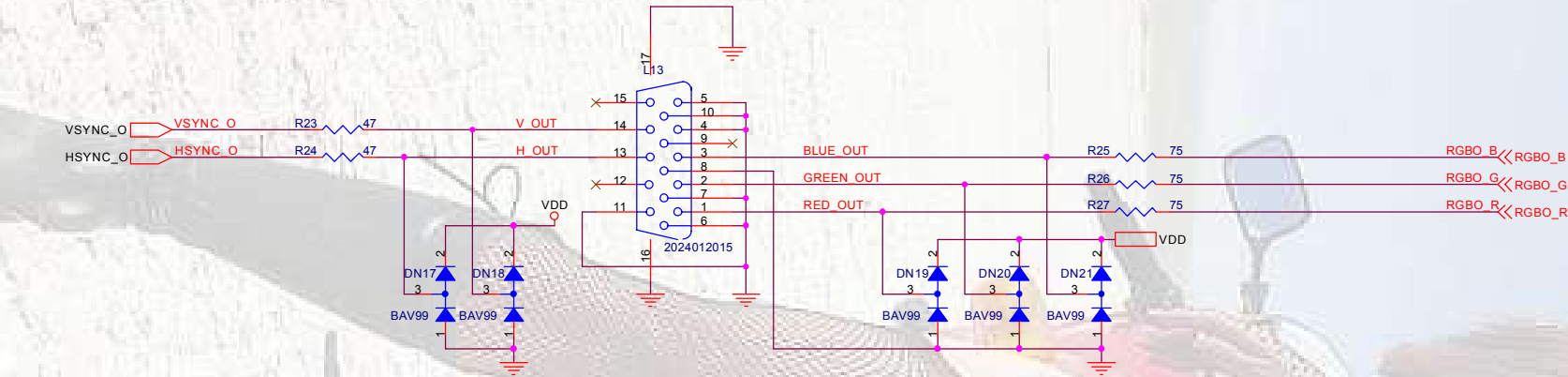

Project Code					Model Name					OEM/ODM Model Name				
99.J3477.001					DX660					NA				
Title														
MAIN BD														
Size	PCB P/N	PCB Rev.	Document Number	Rev.										
<Size>	48.J3402.S03	S03	304-C02	1										
Date:	Tuesday, May 21, 2002			Sheet	3		of		12					
Prepared By					Reviewed By					Approved By				
ANGEL HU					BILL WJ CHANG					T.S.WU				

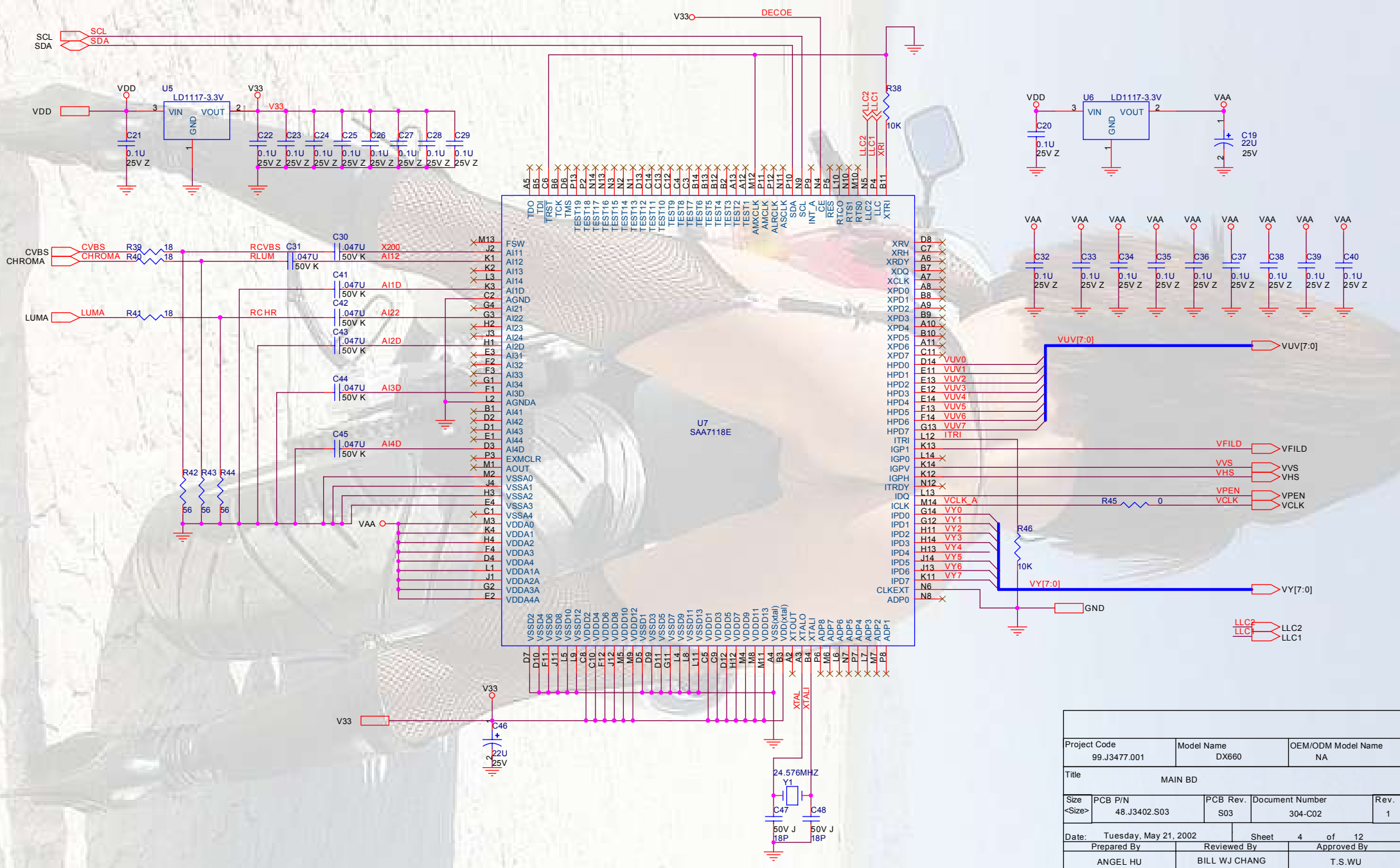

Project Code 99.J3477.001		Model Name DX660		OEM/ODM Model Name NA	
Title MAIN BD					
Size <Size>	PCB P/N 48.J3402.S03	PCB Rev. S03	Document Number 304-C02	Rev. 1	
Date: Tuesday, May 21, 2002			Sheet 4 of 12		
Prepared By ANGEL HU		Reviewed By BILL WJ CHANG		Approved By T.S.WU	

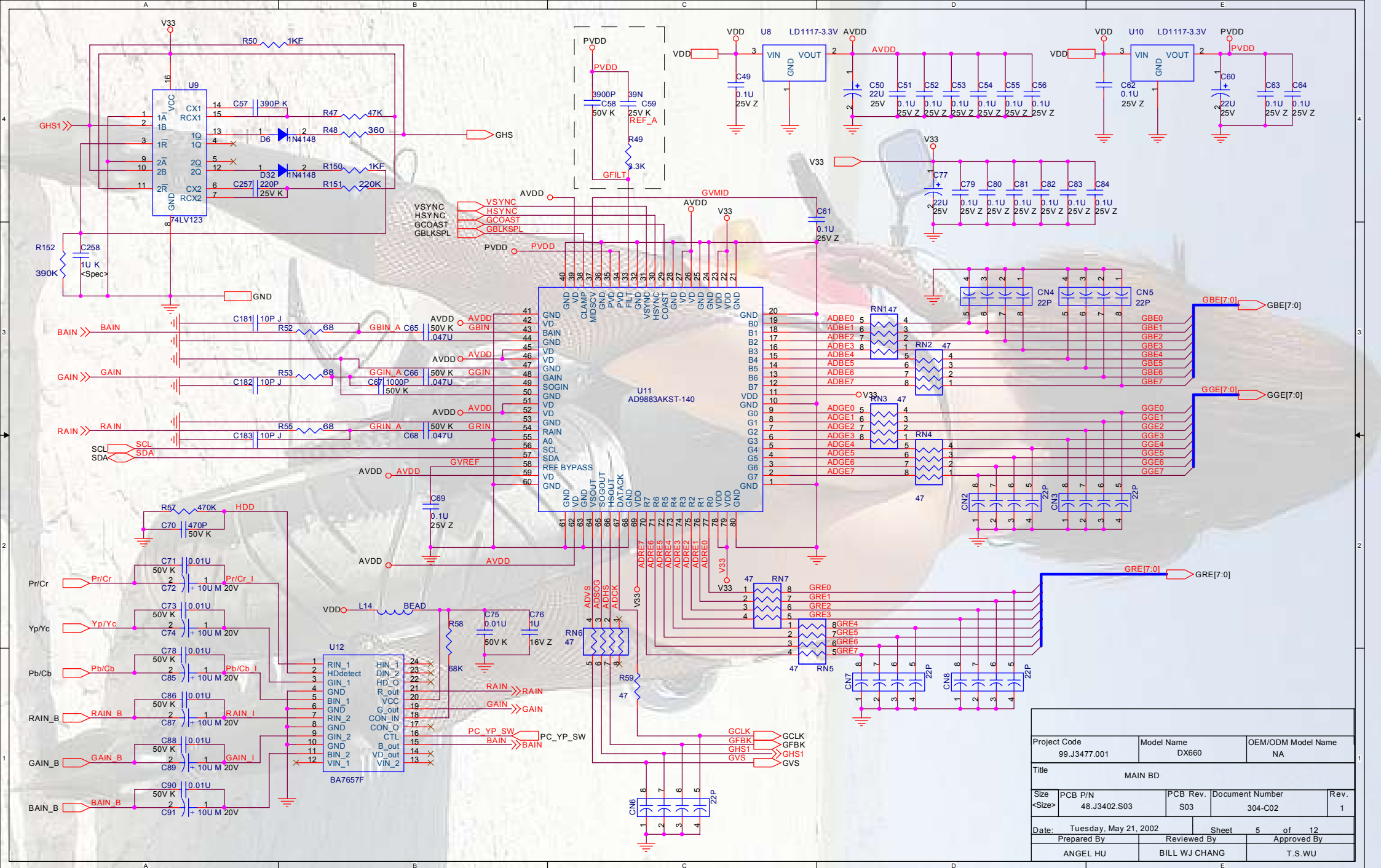

Project Code	Model Name	OEM/ODM Model Name		
99.J3477.001	DX660	NA		
Title				
MAIN BD				
Size <Size>	PCB P/N	PCB Rev.	Document Number	Rev.
	48.J3402.S03	S03	304-C02	1
Date:	Tuesday, May 21, 2002	Sheet	5 of 12	
Prepared By	ANGEL HU	Reviewed By	BILL WJ CHANG	Approved By
			T.S.WU	

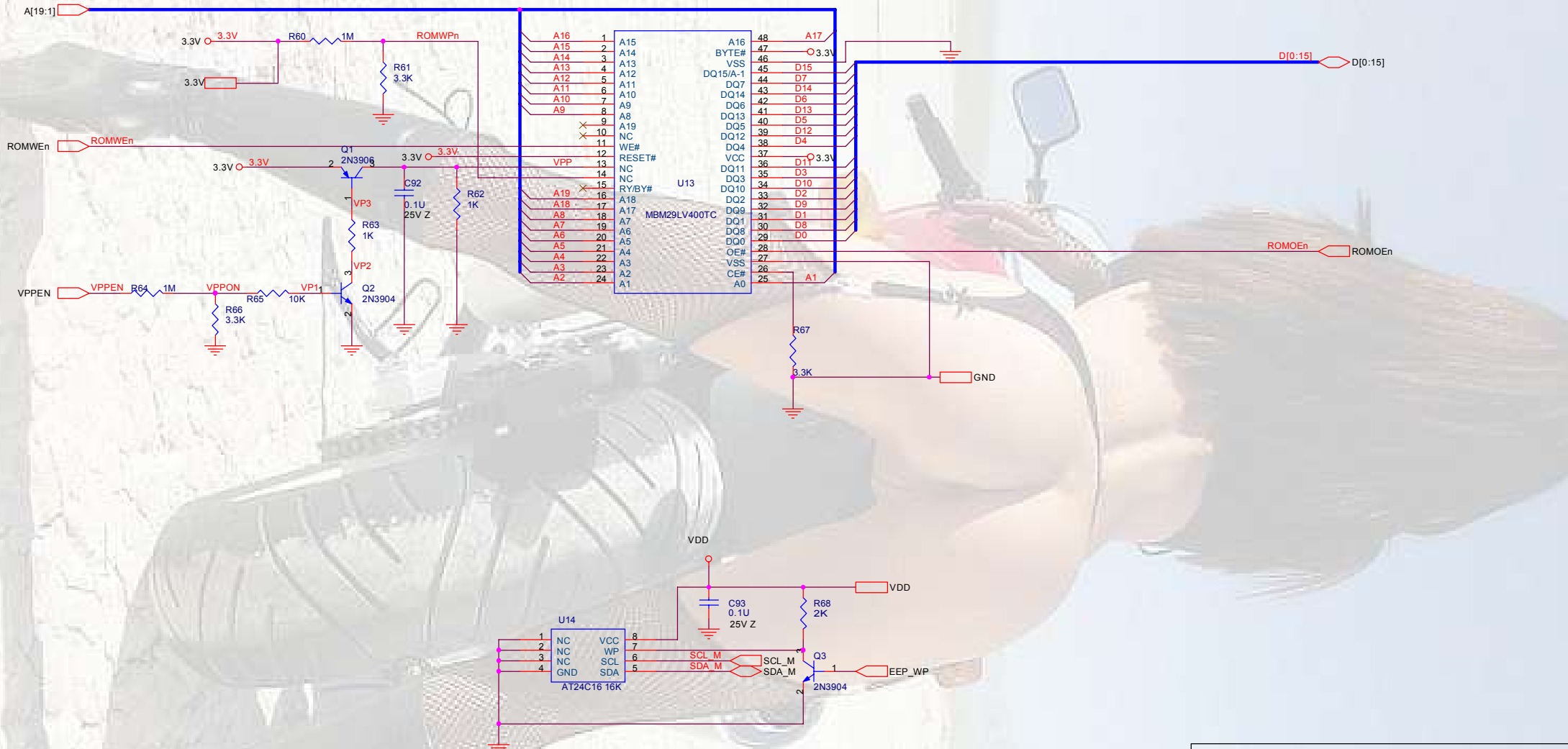

Project Code 99.J3477.001		Model Name DX660		OEM/ODM Model Name NA	
Title MAIN BD					
Size <Size>	PCB P/N 48.J3402.S03	PCB Rev. S03	Document Number 304-C02	Rev. 1	
Date: Tuesday, May 21, 2002			Sheet 6 of 12		
Prepared By ANGEL HU		Reviewed By BILL WJ CHANG		Approved By T.S.WU	



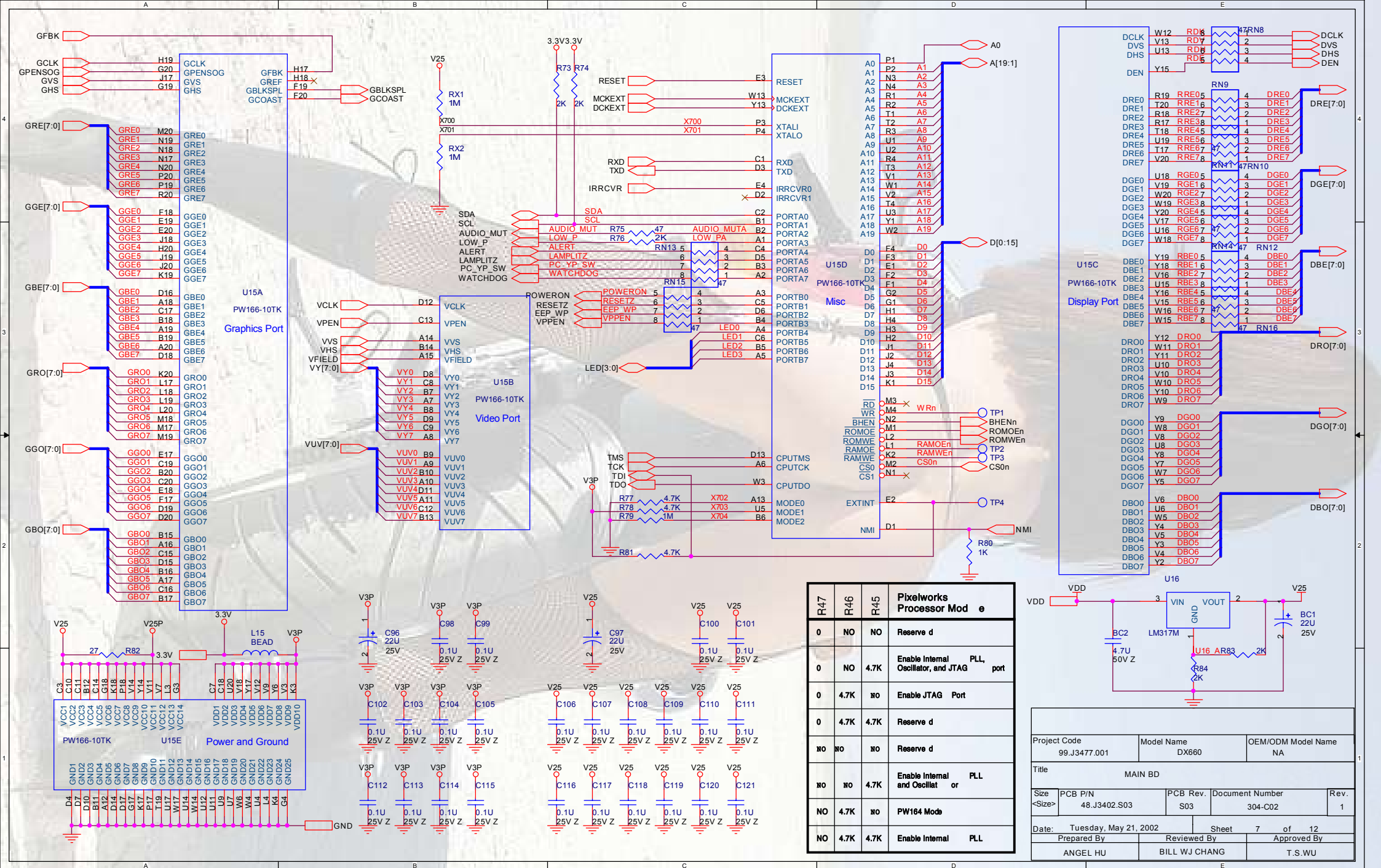

R47	R46	R45	Pixelworks Processor Module
0	NO	NO	Reserved
0	NO	4.7K	Enable Internal Oscillator, and JTAG port
0	4.7K	NO	Enable JTAG Port
0	4.7K	4.7K	Reserved
NO	NO	NO	Reserved
NO	NO	4.7K	Enable Internal and Oscillator
NO	4.7K	NO	PW164 Mode
NO	4.7K	4.7K	Enable Internal PLL

Project Code 99.J3477.001		Model Name DX660		OEM/ODM Model Name NA	
Title MAIN BD					
Size <Size>	PCB P/N 48.J3402.S03	PCB Rev. S03	Document Number 304-C02	Rev. 1	
Date: Tuesday, May 21, 2002		Sheet 7 of 12			
Prepared By ANGEL HU		Reviewed By BILL WJ CHANG		Approved By T.S.WU	

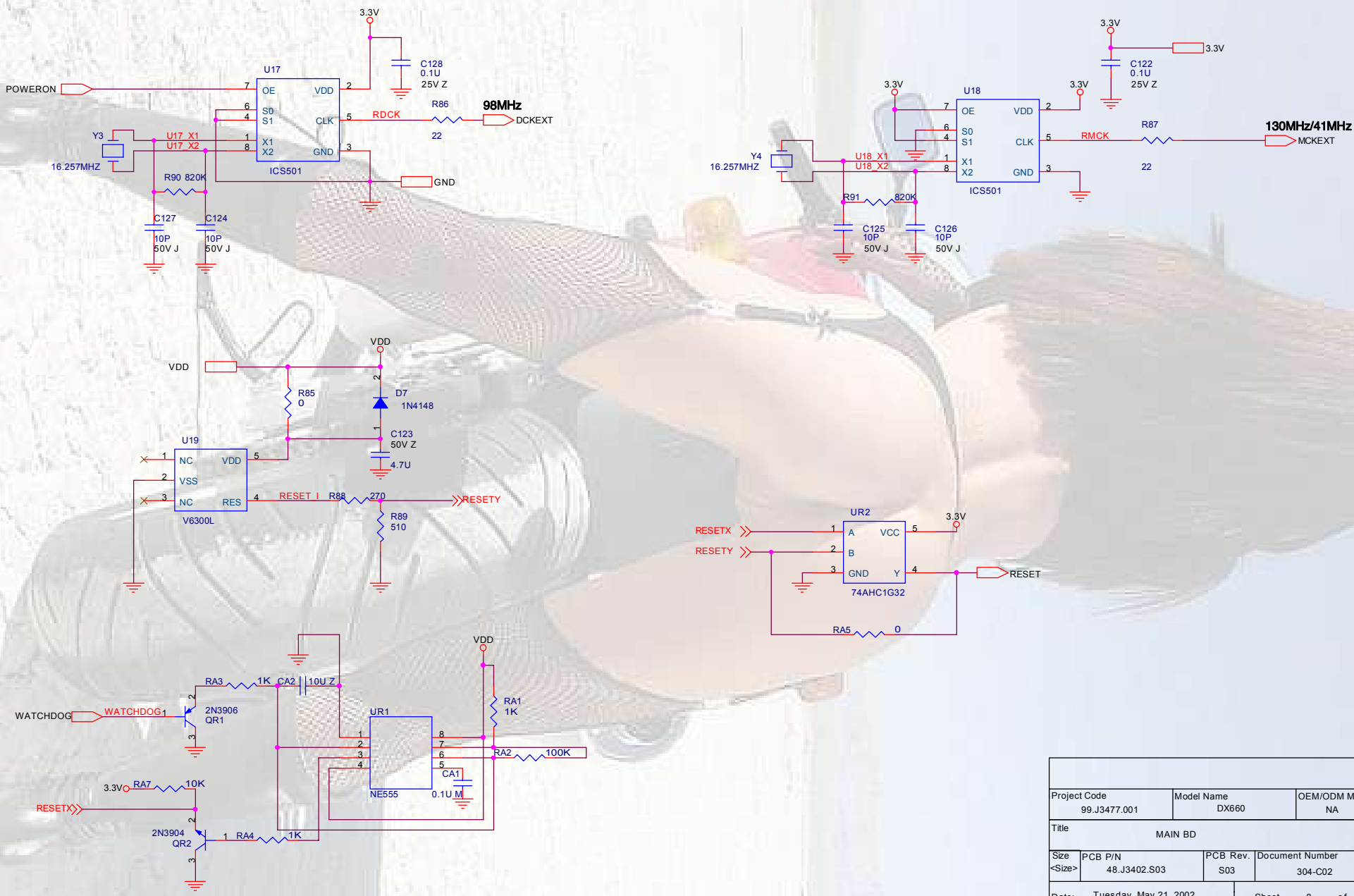

Project Code	Model Name	OEM/ODM Model Name		
99.J3477.001	DX660	NA		
Title				
MAIN BD				
Size	PCB P/N	PCB Rev.	Document Number	Rev.
<Size>	48.J3402.S03	S03	304-C02	1
Date: Tuesday, May 21, 2002		Sheet 8 of 12		
Prepared By		Reviewed By		Approved By
ANGEL HU		BILL WJ CHANG		T.S.WU

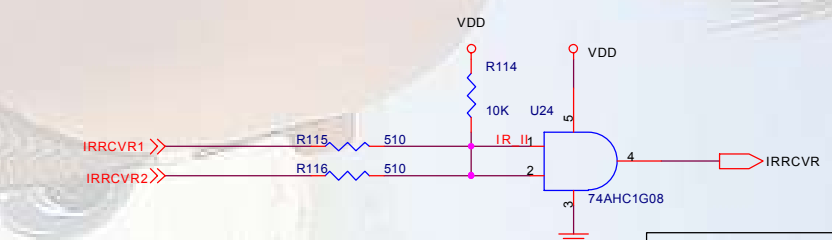
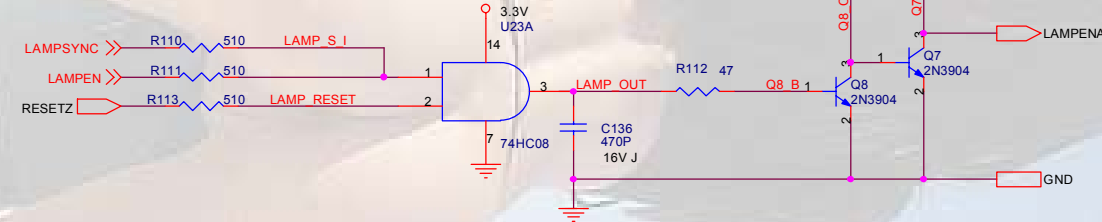
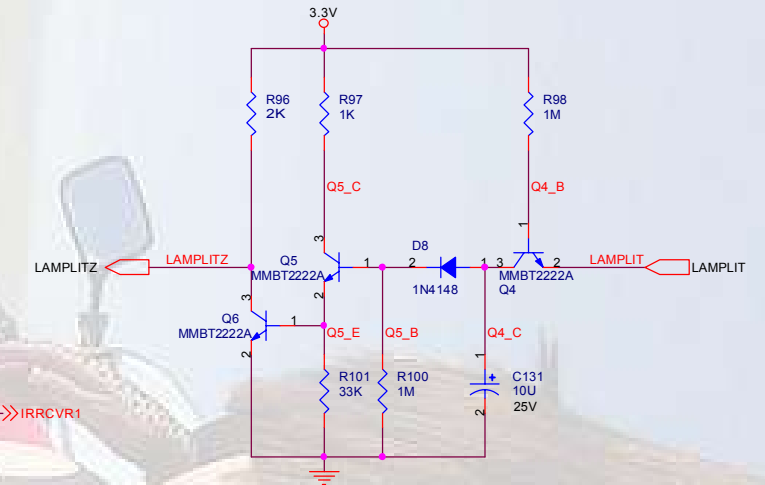
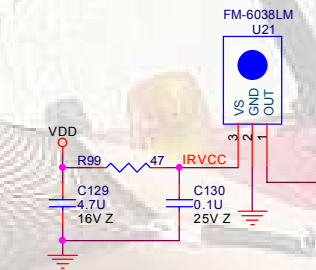
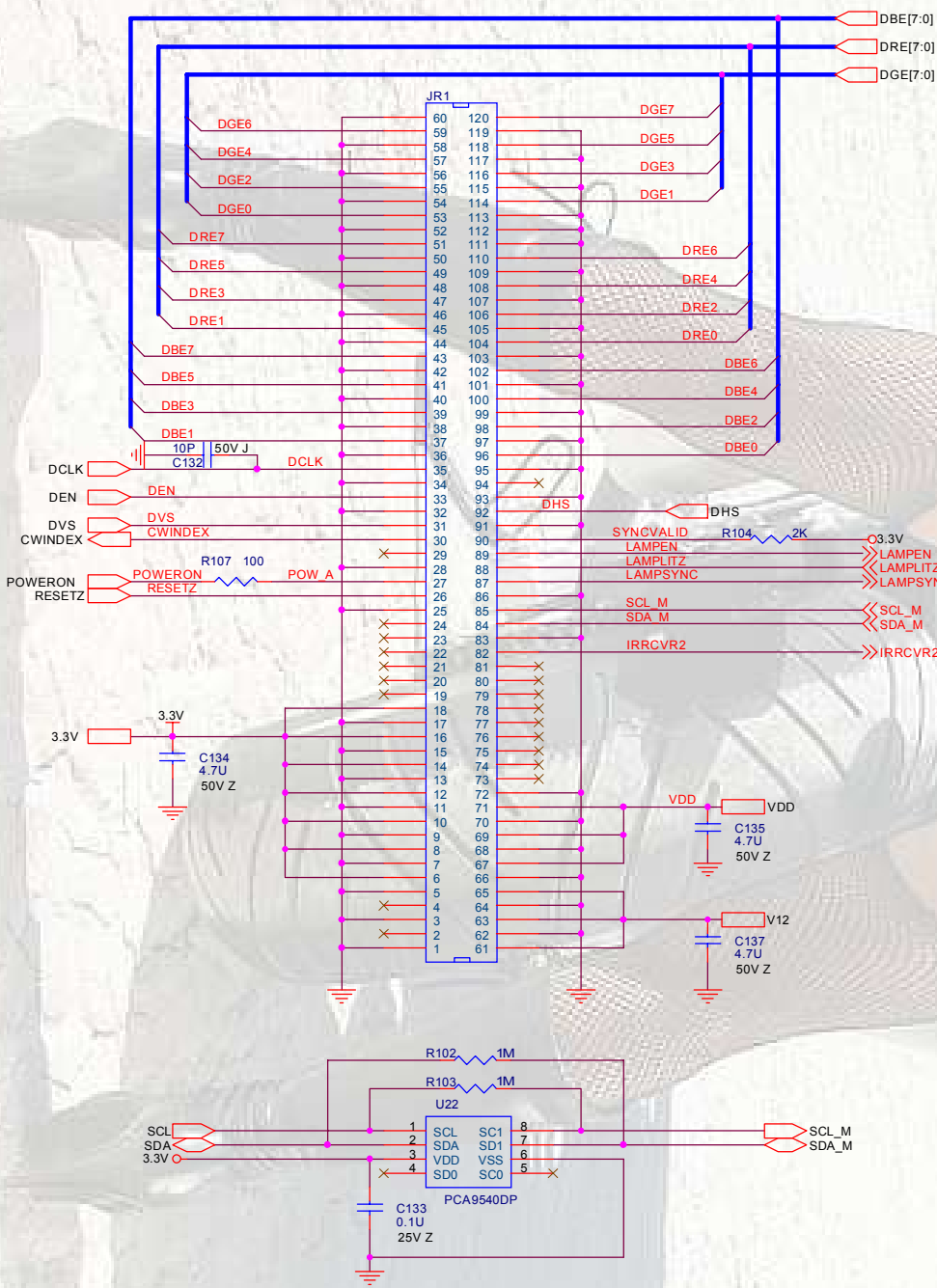

Project Code	Model Name	OEM/ODM Model Name
99.J3477.001	DX660	NA
Title		
MAIN BD		
Size	PCB P/N	PCB Rev.
<Size>	48.J3402.S03	S03
Document Number	Rev.	
304-C02	1	
Date:	Tuesday, May 21, 2002	Sheet 9 of 12
Prepared By	Reviewed By	Approved By
ANGEL HU	BILL WJ CHANG	T.S.WU

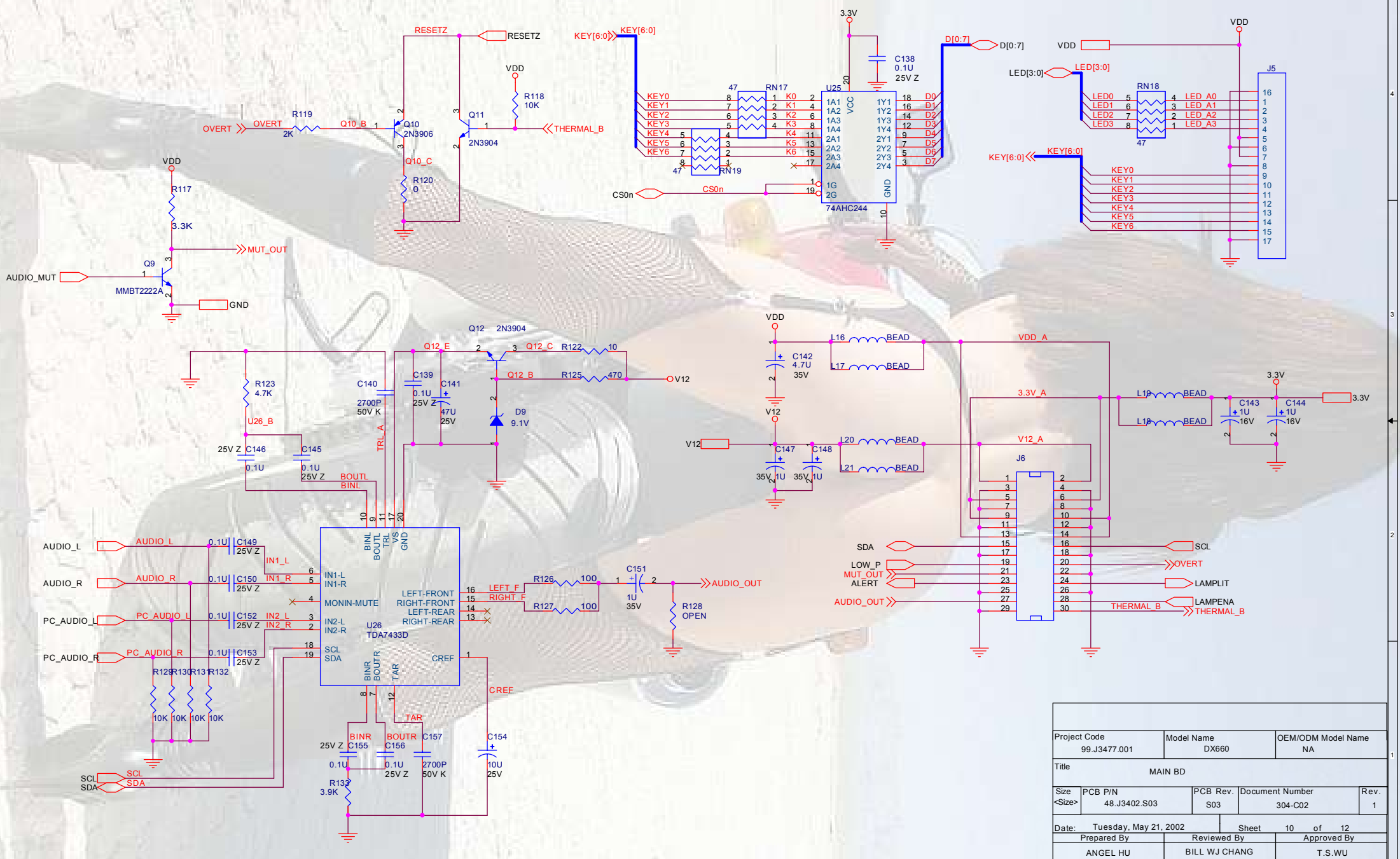

Project Code	Model Name	OEM/ODM Model Name		
99.J3477.001	DX660	NA		
Title				
MAIN BD				
Size	PCB P/N	PCB Rev.	Document Number	Rev.
<Size>	48.J3402.S03	S03	304-C02	1
Date:	Tuesday, May 21, 2002	Sheet	10 of 12	
Prepared By	ANGEL HU	Reviewed By	BILL WJ CHANG	Approved By
				T.S.WU

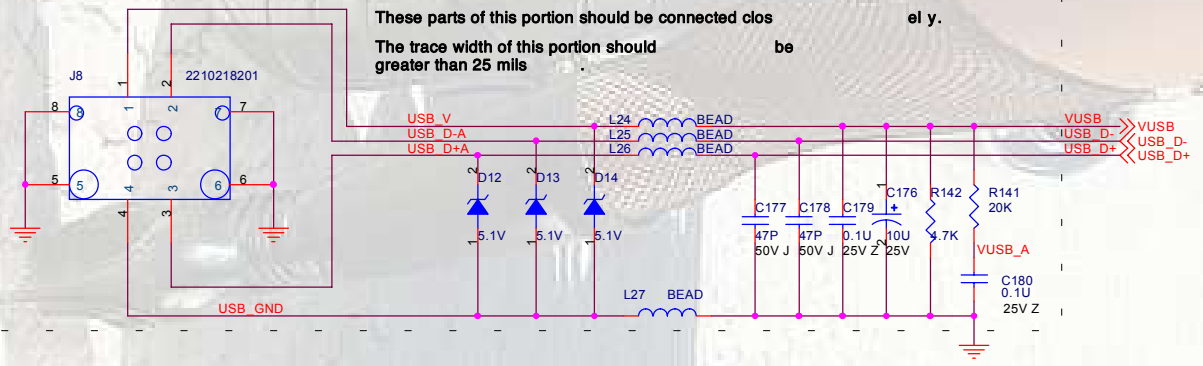
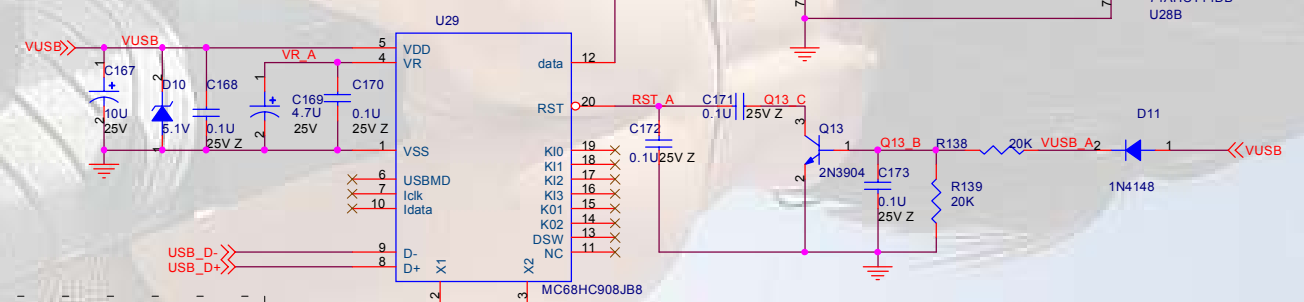
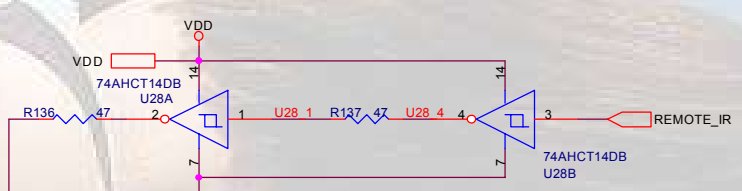
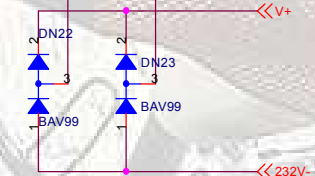
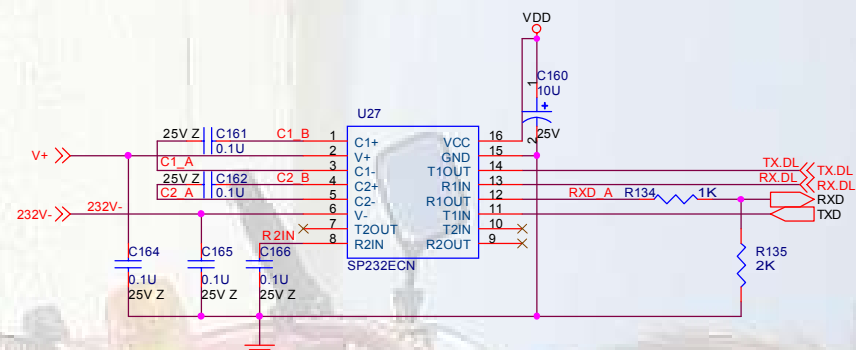
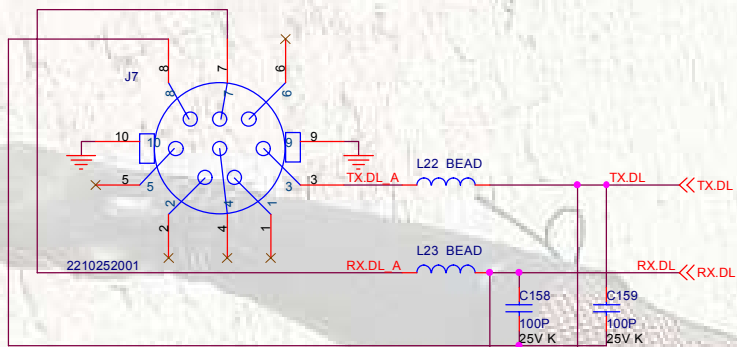

These parts of this portion should be connected closely.

The trace width of this portion should be greater than 25 mils.

Project Code 99.J3477.001	Model Name DX660	OEM/ODM Model Name NA		
Title MAIN BD				
Size <Size>	PCB P/N 48.J3402.S03	PCB Rev. S03	Document Number 304-C02	Rev. 1
Date: Tuesday, May 21, 2002	Sheet 11 of 12		Approved By	
Prepared By ANGEL HU	Reviewed By BILL WJ CHANG	Approved By T.S.WU		

Screw Holes

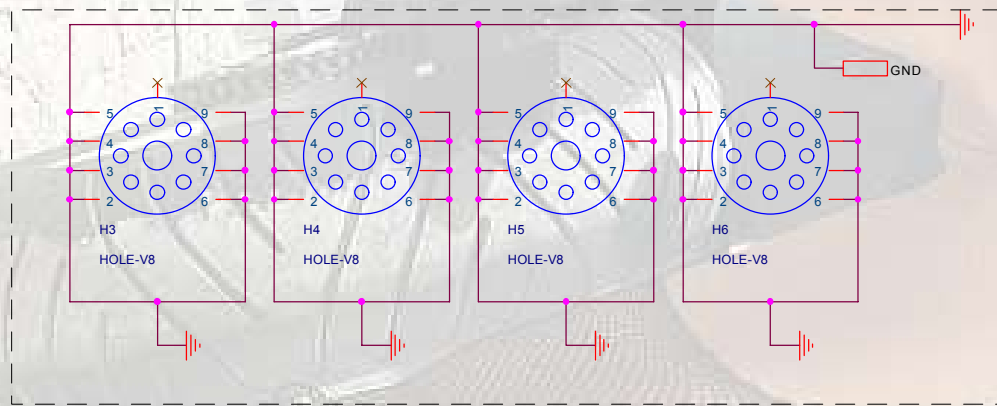

Optical Pin

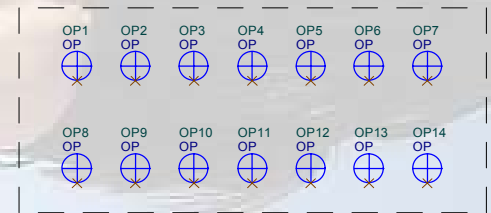

Project Code					Model Name					OEM/ODM Model Name				
99.J3477.001					DX660					NA				
Title														
MAIN BD														
Size	PCB P/N	PCB Rev.			Document Number			Rev.						
<Size>	48.J3402.S03	S03			304-C02			1						
Date: Tuesday, May 21, 2002					Sheet 12 of 12									
Prepared By					Reviewed By					Approved By				
ANGEL HU					BILL WJ CHANG					T.S.WU				

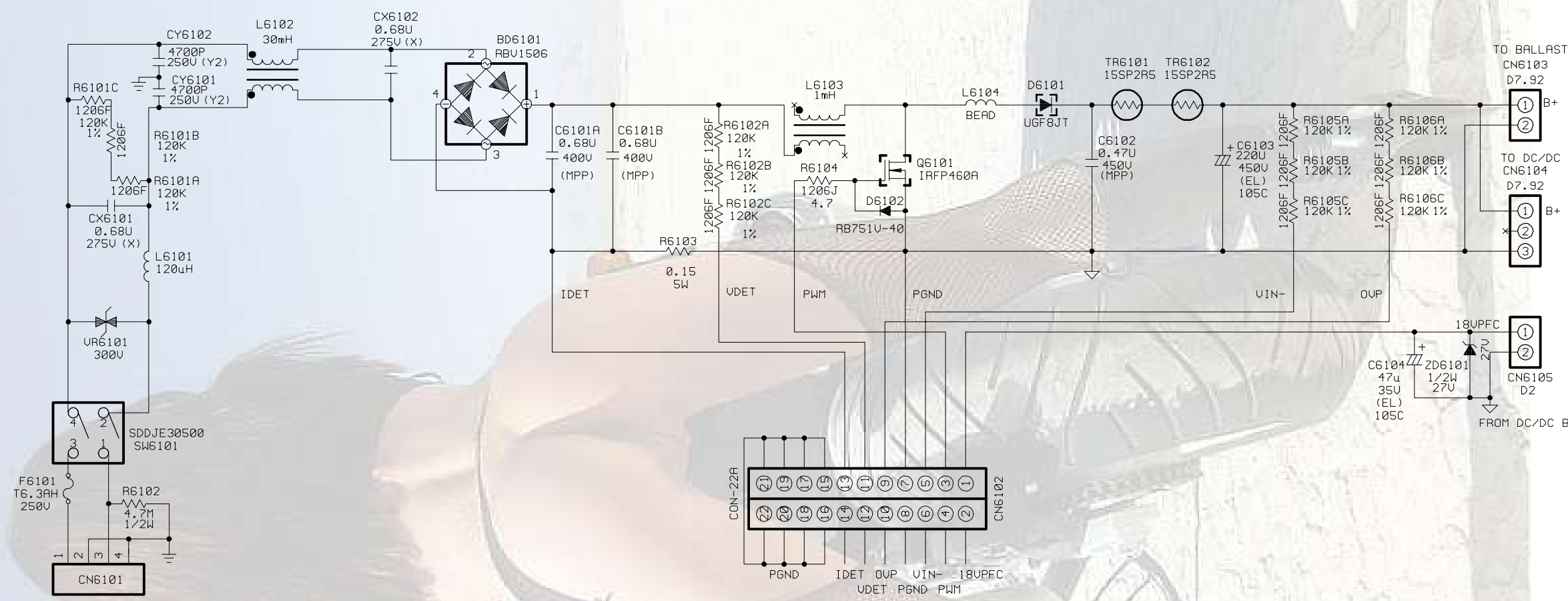

NOTES:  
 1. Resistor values are in ohm, K=1,000 ohm, M=1,000,000 ohm  
 2. All resistors are 1/8 watt, 5% except where otherwise indicated  
 3.  $\text{---} \text{---} \text{---}$  Represents PCB common ground.

DX660 PFC BD SCHEMATICS				
SIZE	48.J3406.S02	FAB	Doc. No.	REV.
A4		S02	304-C04	0
DATE :	3/27/2002	Sheet	1	OF 1
Project Code.		99.J3477.001		
Prepared By	Reviewed By	Approved By		
ANGEL HU 3/27/2002	KEN JA CHEN 3/27/2002	ANDREW TAN 3/27/2002		

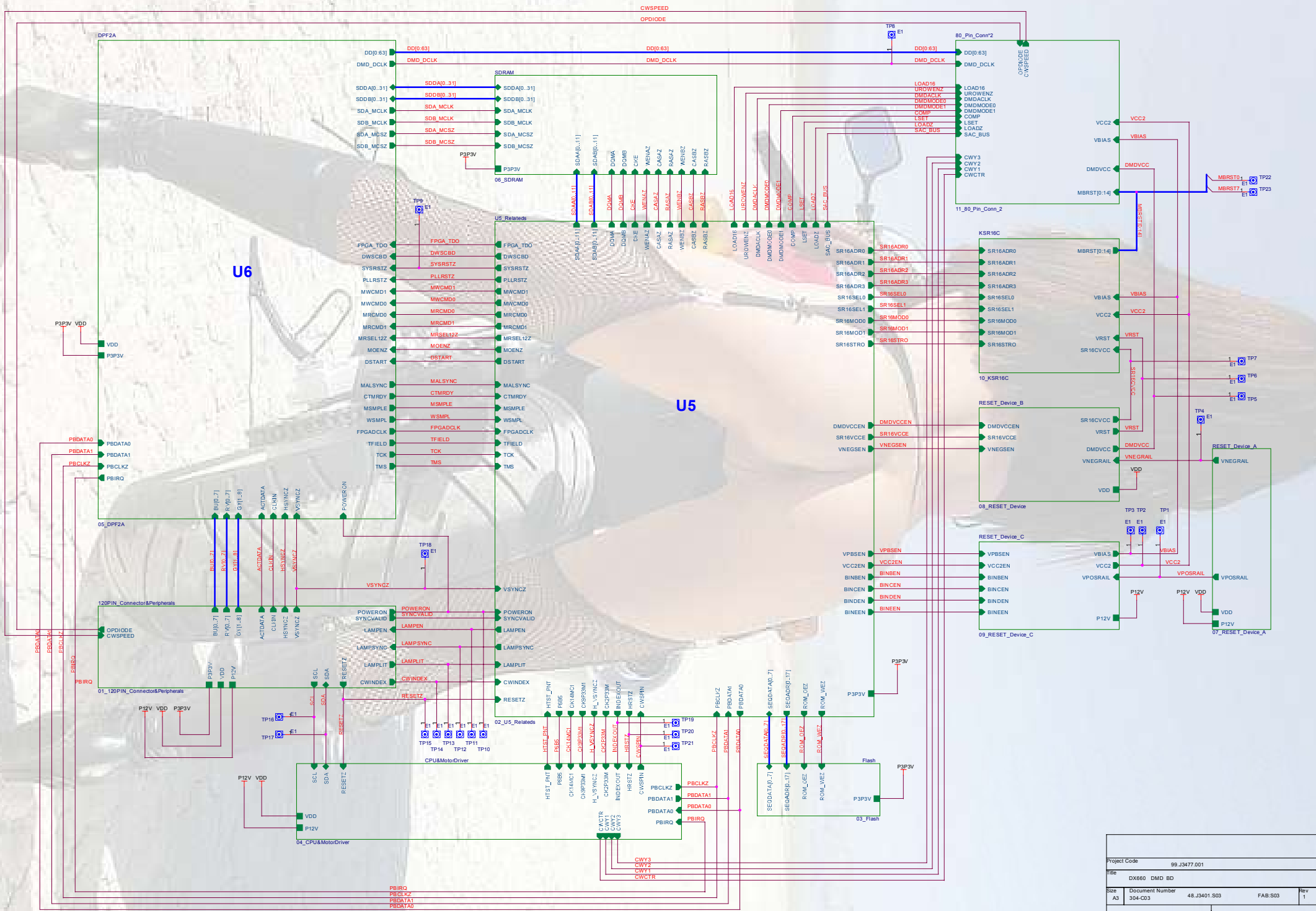

Project Code				99-J3477.001	
Title				DX660 DMD BD	
Size	Document Number	48.J3401.S03	FAB:S03	Rev 1	
Date: Wednesday, April 17, 2002		Sheet 1 of 12		Approved By	
ANGEL HU		BILL WJ CHANG		H.C.TSOU	



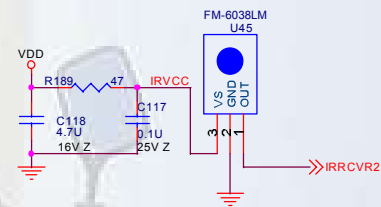
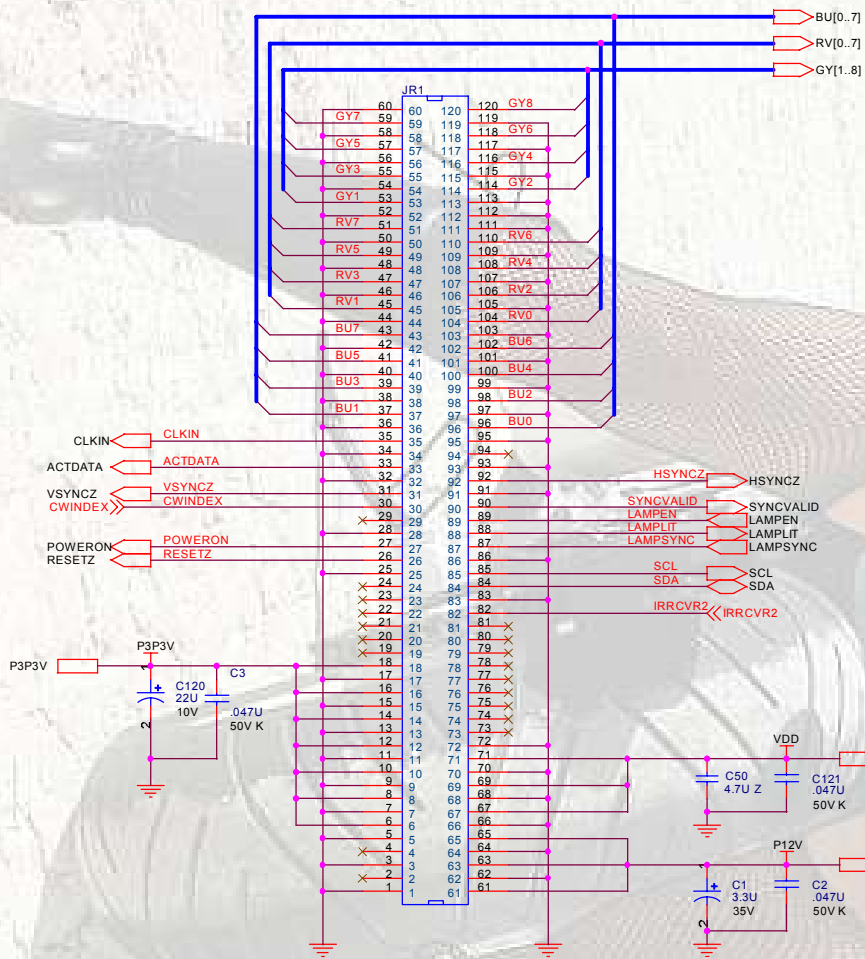

From CW Sensor  
20.L2021.003

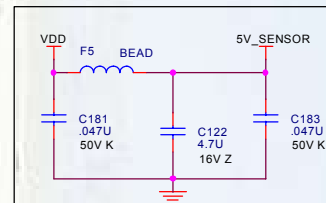
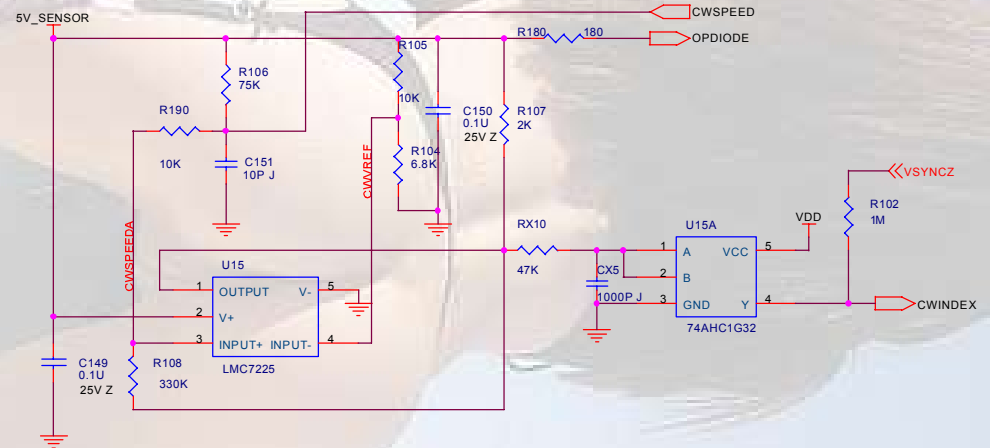

Power Supply noly for CW Sensor

1 page is modified all

Project Code					99.J3477.001									
Title										DX660 DMD BD				
Size	Document Number	48.J3401.S03			FAB:S03	Rev	1							
Date:					Wednesday, April 17, 2002		Sheet		2		of 12			
Prepared By			Reviewed By			Approved By								
ANGEL HU			BILL WJ CHANG			H.C.TSOU								

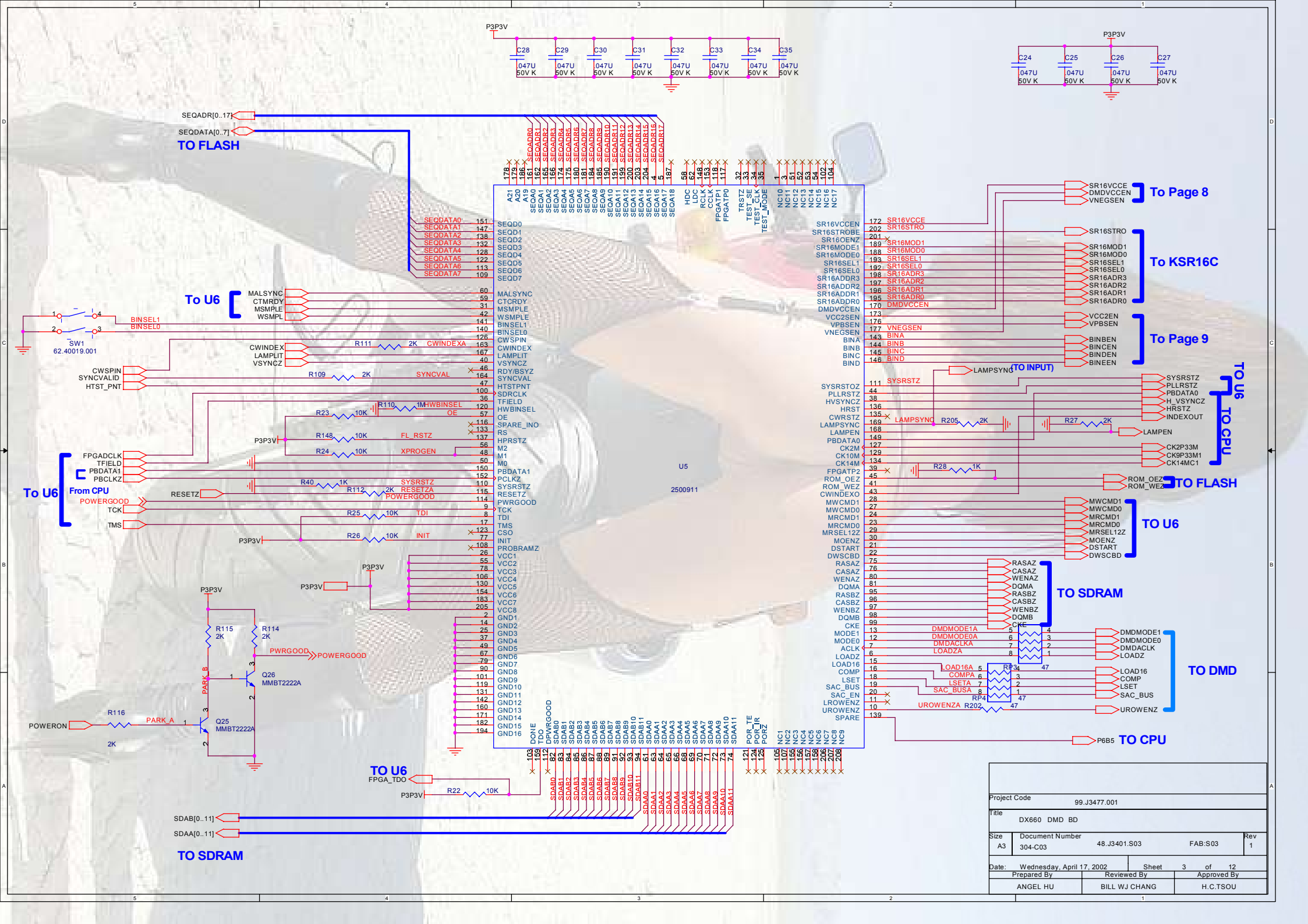

Project Code		99.J3477.001				
Title				DX660 DMD BD		
Size	Document Number	48.J3401.S03	FAB:S03	Rev	1	
Date:		Wednesday, April 17, 2002	Sheet	3	of 12	
Prepared By		ANGEL HU	Reviewed By	BILL WJ CHANG	Approved By	H.C.TSOU

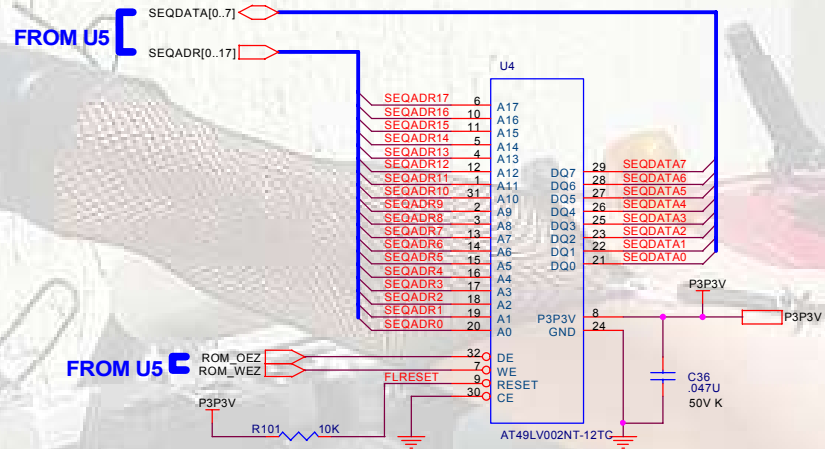

**Screw Holes**

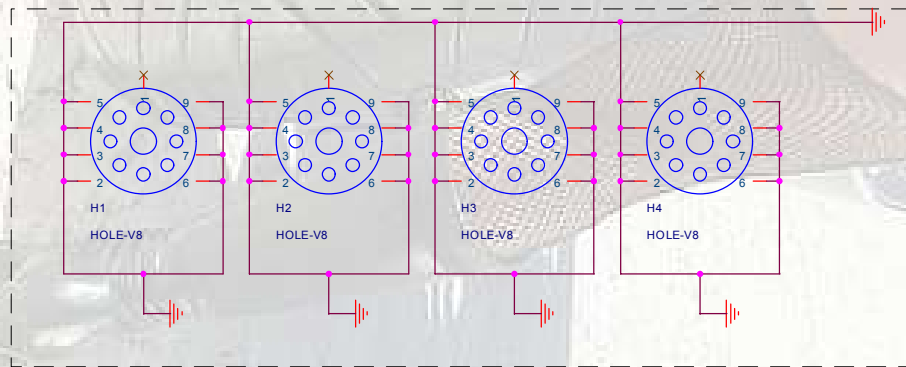

**Optical Pin**

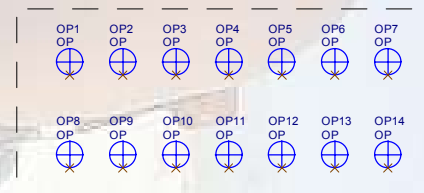

Project Code					99.J3477.001				
Title					DX660 DMD BD				
Size	Document Number	48.J3401.S03			FAB:S03	Rev			
A3	304-C03					1			
Date: Wednesday, April 17, 2002				Sheet		4 of 12			
Prepared By			Reviewed By			Approved By			
ANGEL HU			BILL WJ CHANG			H.C.TSOU			

**TOP VIEW**



**RB717F  
BAT54SWT1**

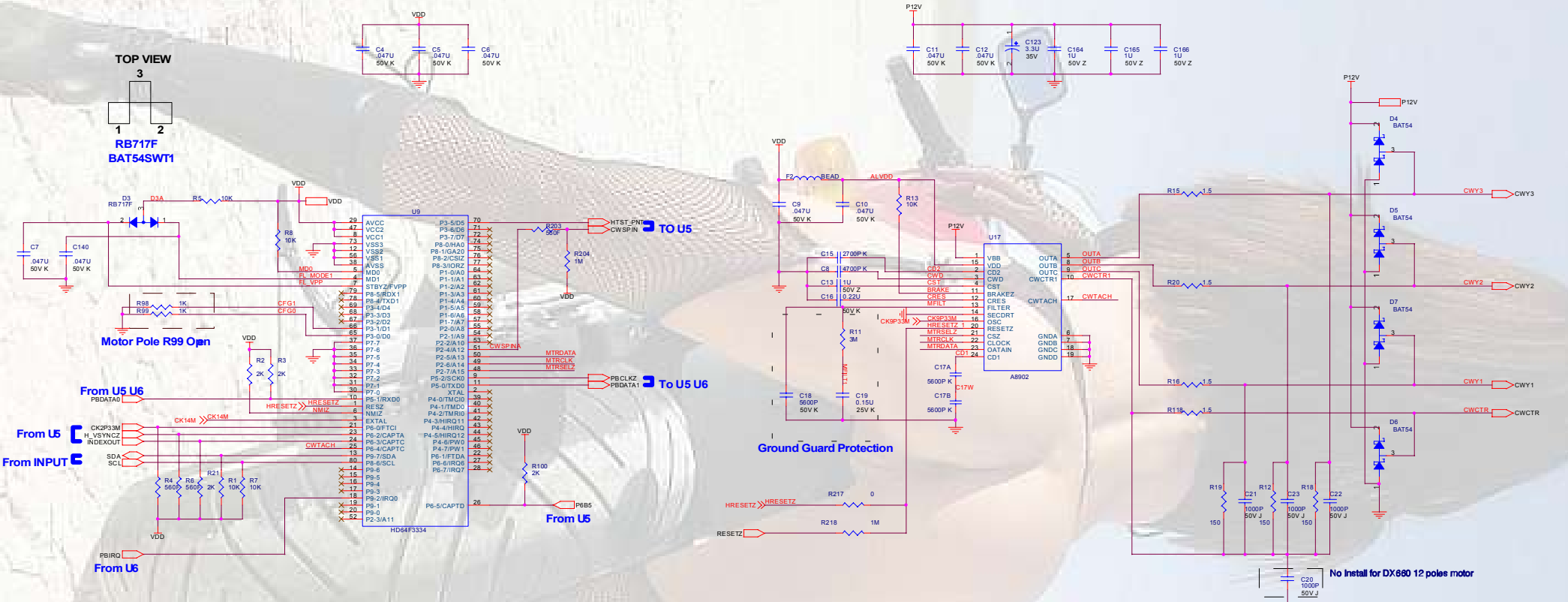

<b>R98</b>	<b>R99</b>	<b>8POLES</b>
YES	YES	
YES	NO	<b>12POLES</b>
NO	YES	<b>16POLES</b>

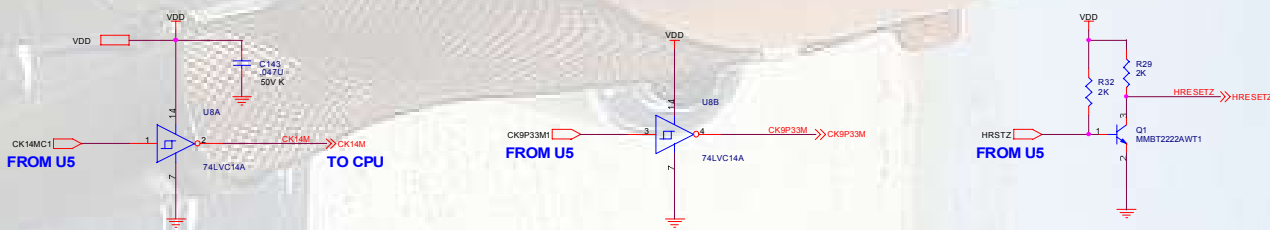

**No install for DX660 12 poles motor**

Project Code	99_J3477.001		
Title	DX660 DMD BD		
Size	Document Number	48.J3401.S03	FAB:503
A3	304-CD3		Rev 1
Date	Wednesday, April 17, 2002	Sheet	5 of 12
Prepared By	ANGEL HU	Released By	BILL WJ CHANG
Approved By			H.C.TSOU

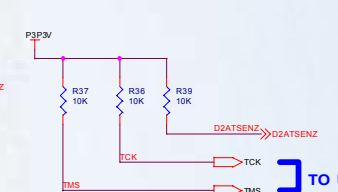
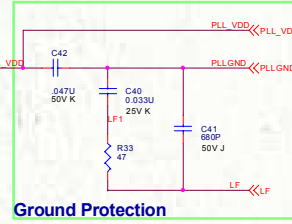
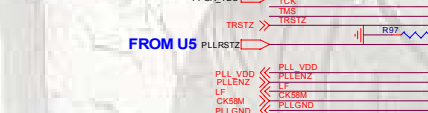
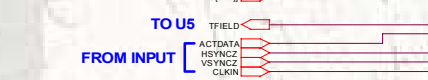
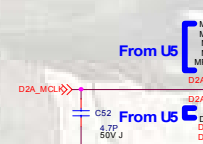
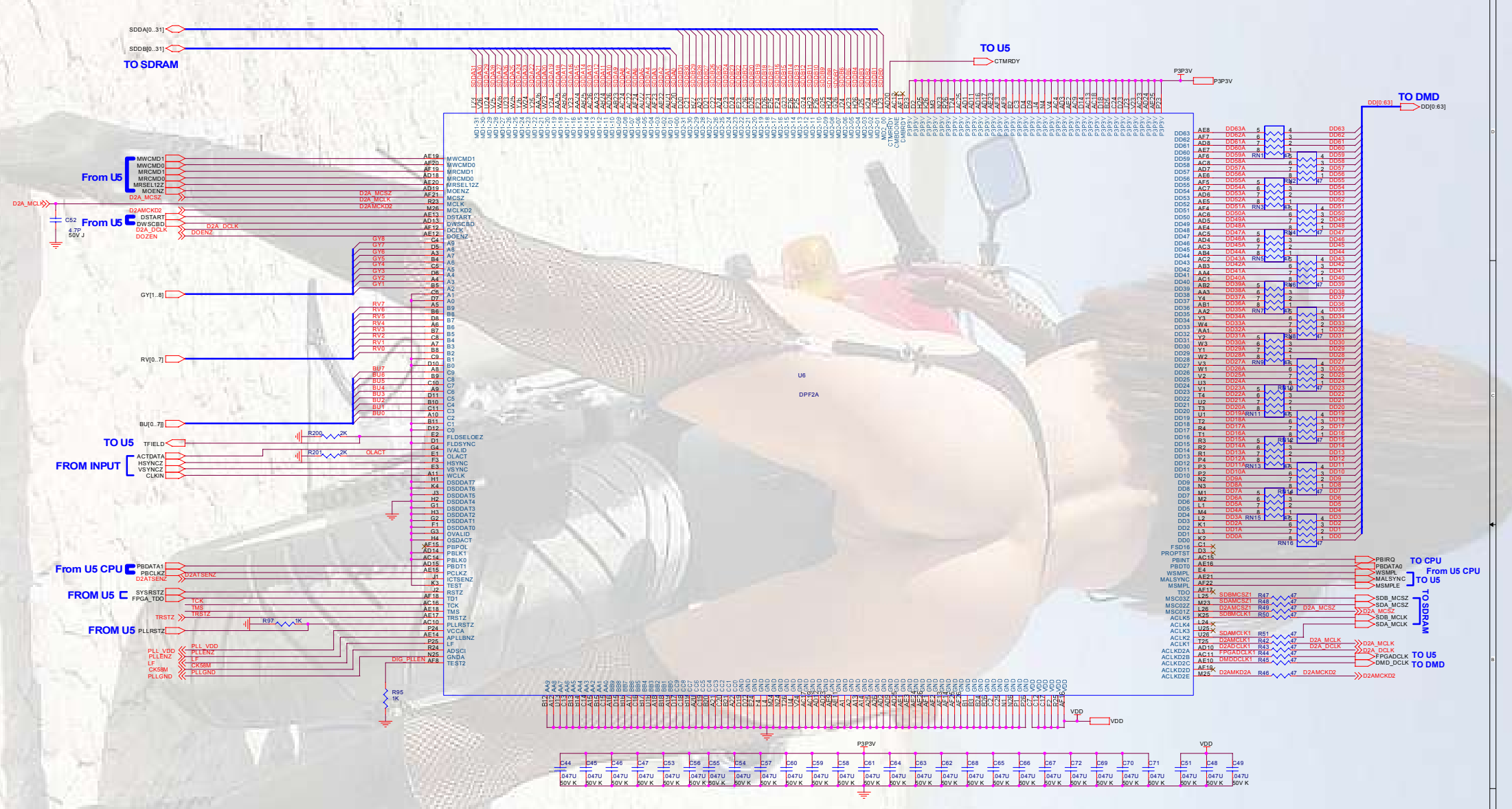

Project Code	99.J3477.001		
File	DX680 DMD BD		
Size	Document Number	48.J3401.S03	FAB.S03
A3	304-C03		
Date:	Wednesday, April 17, 2002	Sheet	6 of 12
Prepared By:	ANGEL HU	Reviewed By:	BILL WJ CHANG
Approved By:			H.C.TSOU

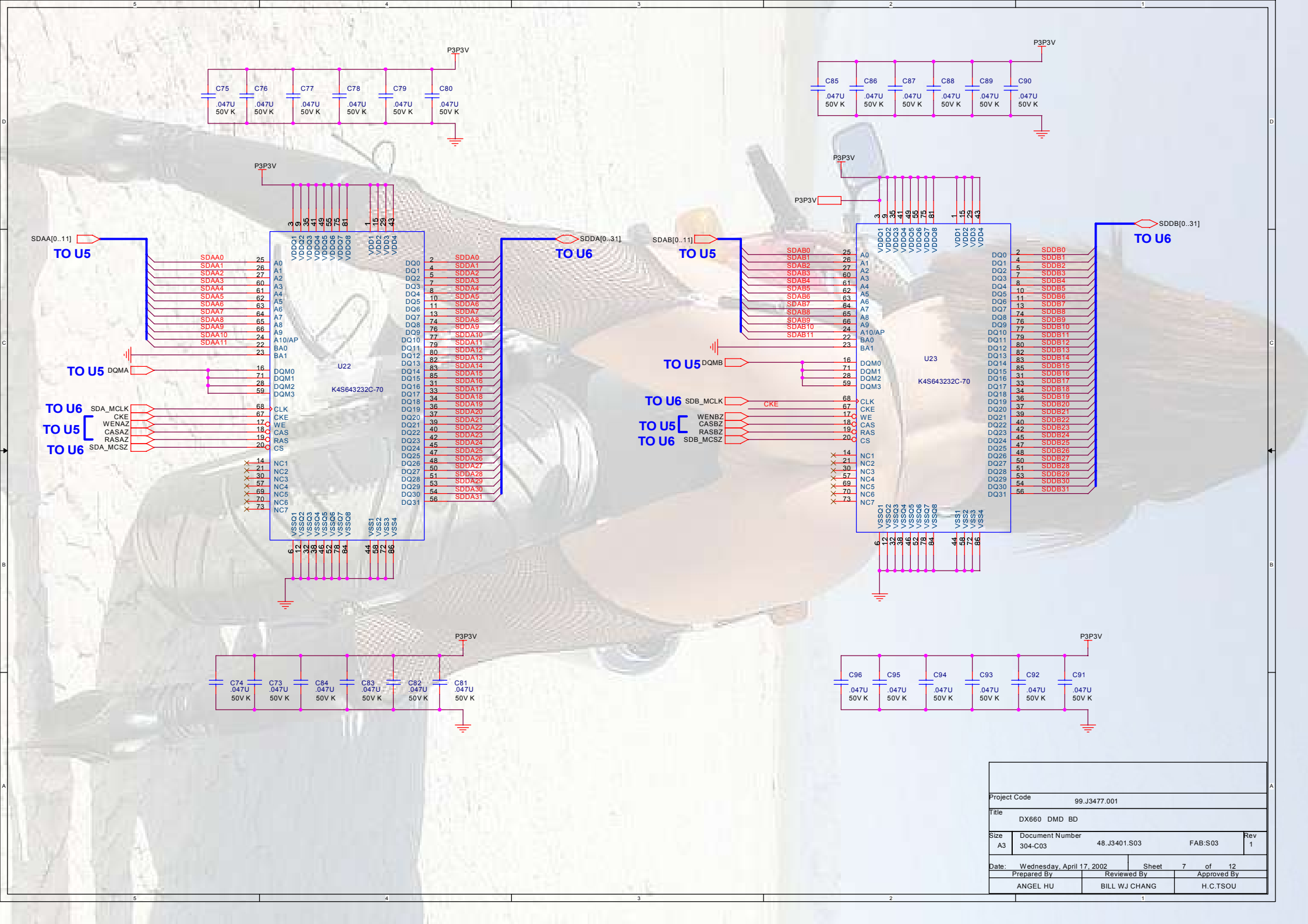

Project Code				99.J3477.001	
Title				DX660 DMD BD	
Size	Document Number	48.J3401.S03	FAB:S03	Rev	1
A3					
Date:	Wednesday, April 17, 2002	Sheet	7	of	12
Prepared By	ANGEL HU	Reviewed By	BILL WJ CHANG	Approved By	H.C.TSOU

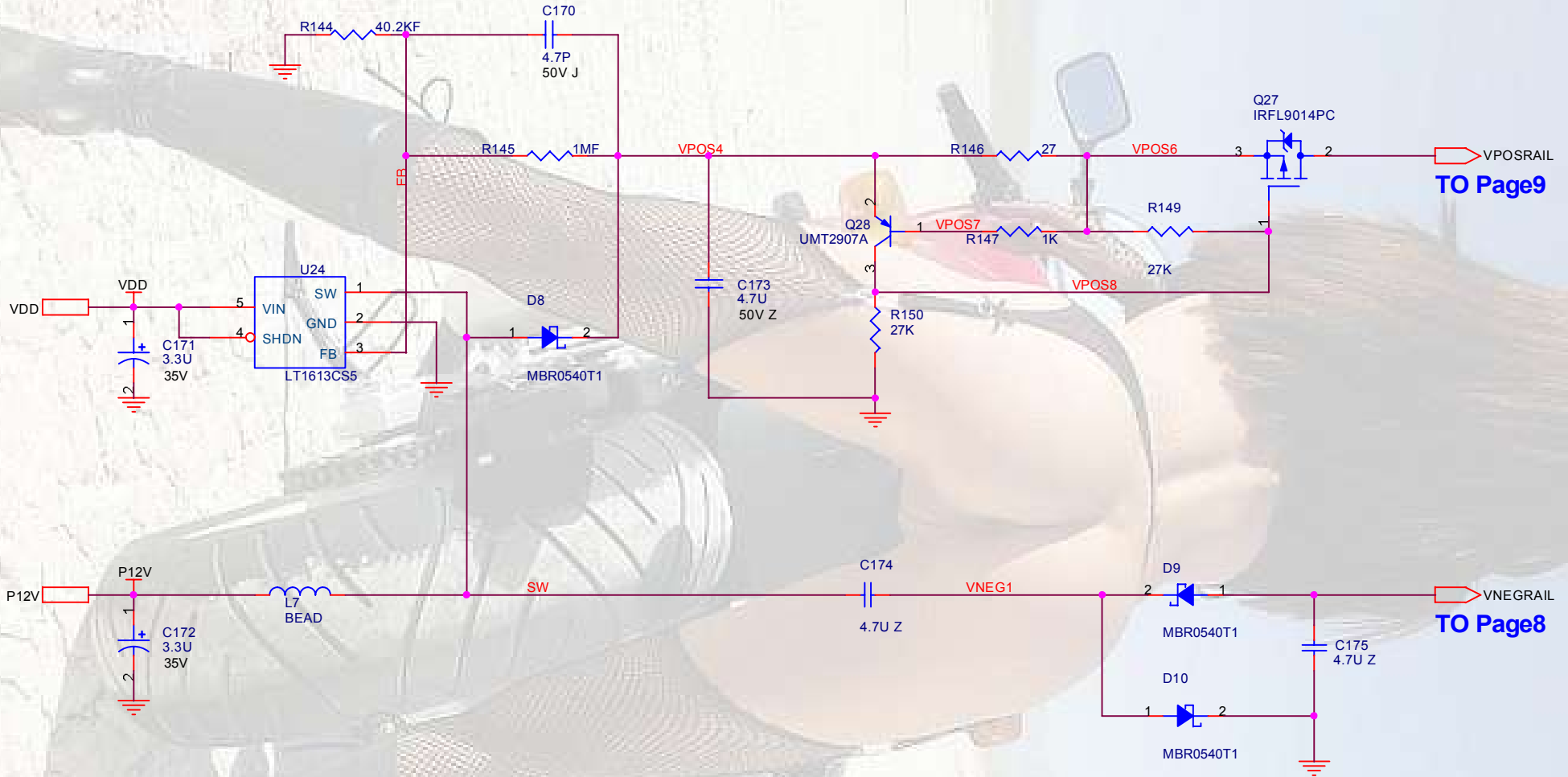

TO Page9

TO Page8

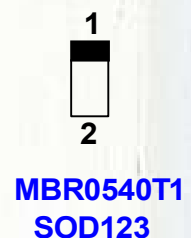
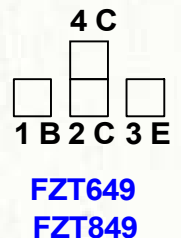
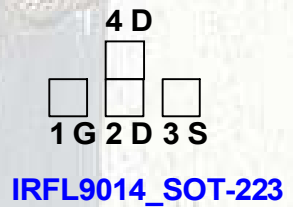
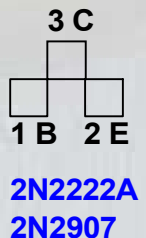
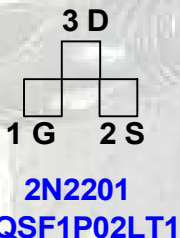

Project Code				99.J3477.001	
Title				DX660 DMD BD	
Size	Document Number	48.J3401.S03	FAB:S03	Rev	1
A3	304-C03				
Date: Wednesday, April 17, 2002		Sheet	8	of 12	
Prepared By		Reviewed By		Approved By	
ANGEL HU		BILL WJ CHANG		H.C.TSOU	

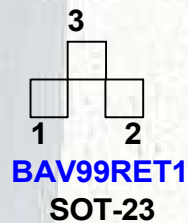
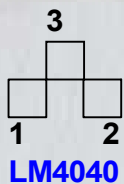
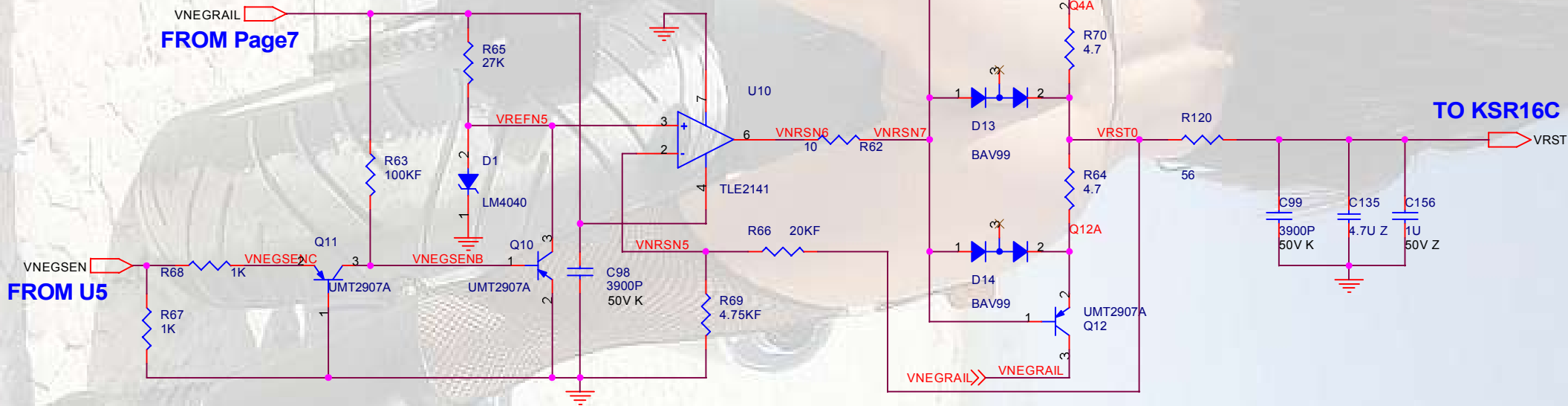
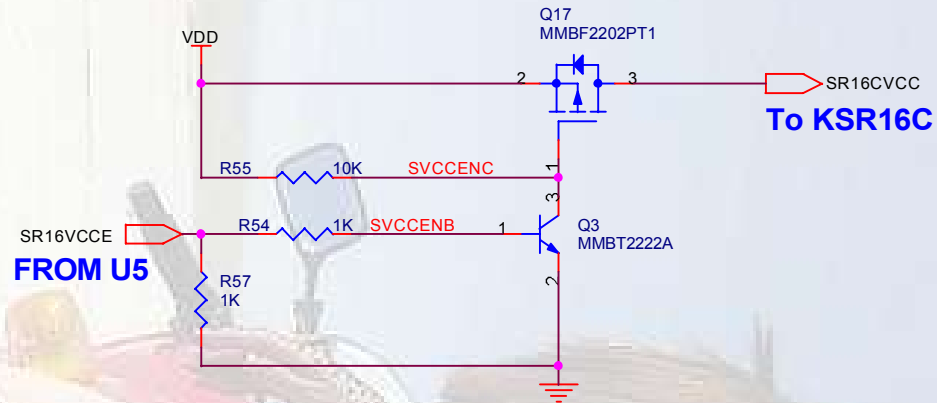
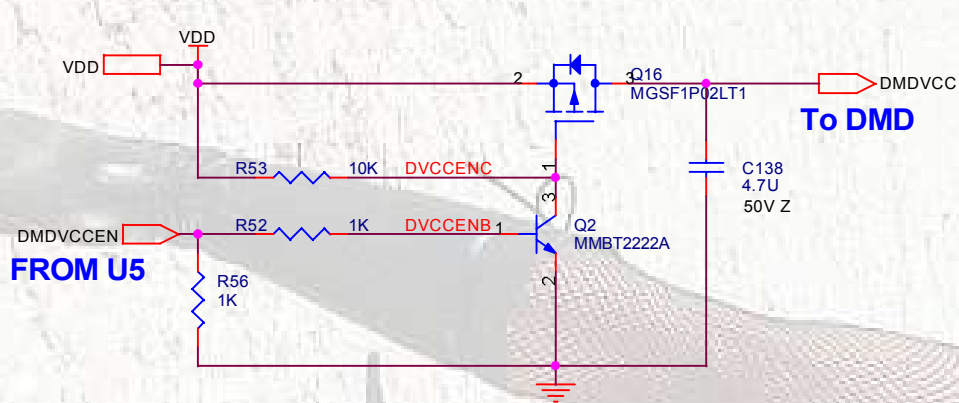

Project Code		99.J3477.001		
Title		DX660 DMD BD		
Size	Document Number	48.J3401.S03	FAB:S03	Rev
A3	304-C03			1
Date: Wednesday, April 17, 2002		Sheet 9 of 12		
Prepared By		Reviewed By		Approved By
ANGEL HU		BILL WJ CHANG		H.C.TSOU



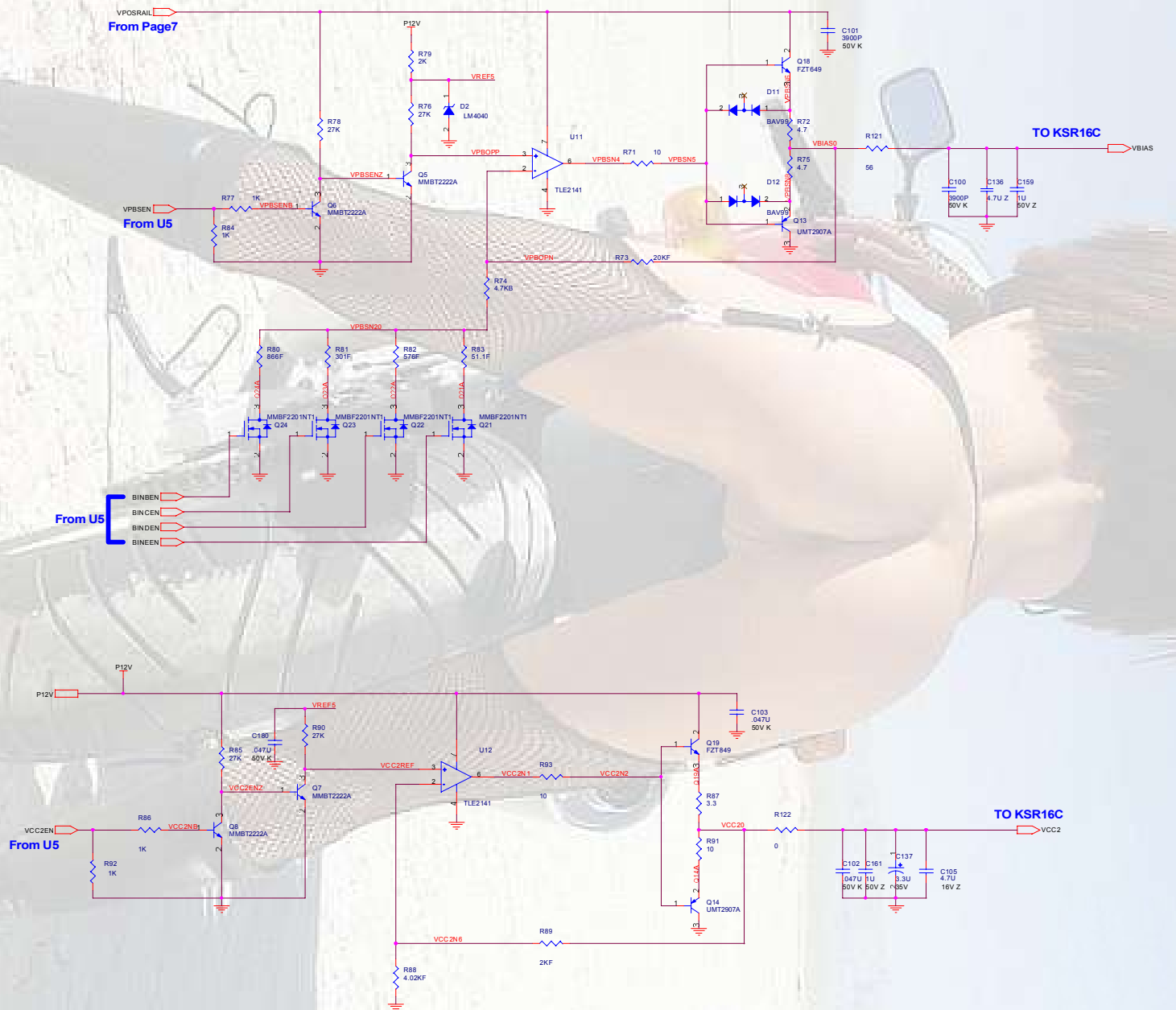

Project Code	99_J3477.001		
Title	DX660 DMD BD		
Size	Document Number	48_J3401.S03	FAB.S03
A3	304-C03		Rev 1
Date:	Wednesday, April 17, 2002	Sheet	10 of 12
Prepared By:	ANGEL HU	Reviewed By:	BILL WJ CHANG
		Approved By:	H.C.TSOU

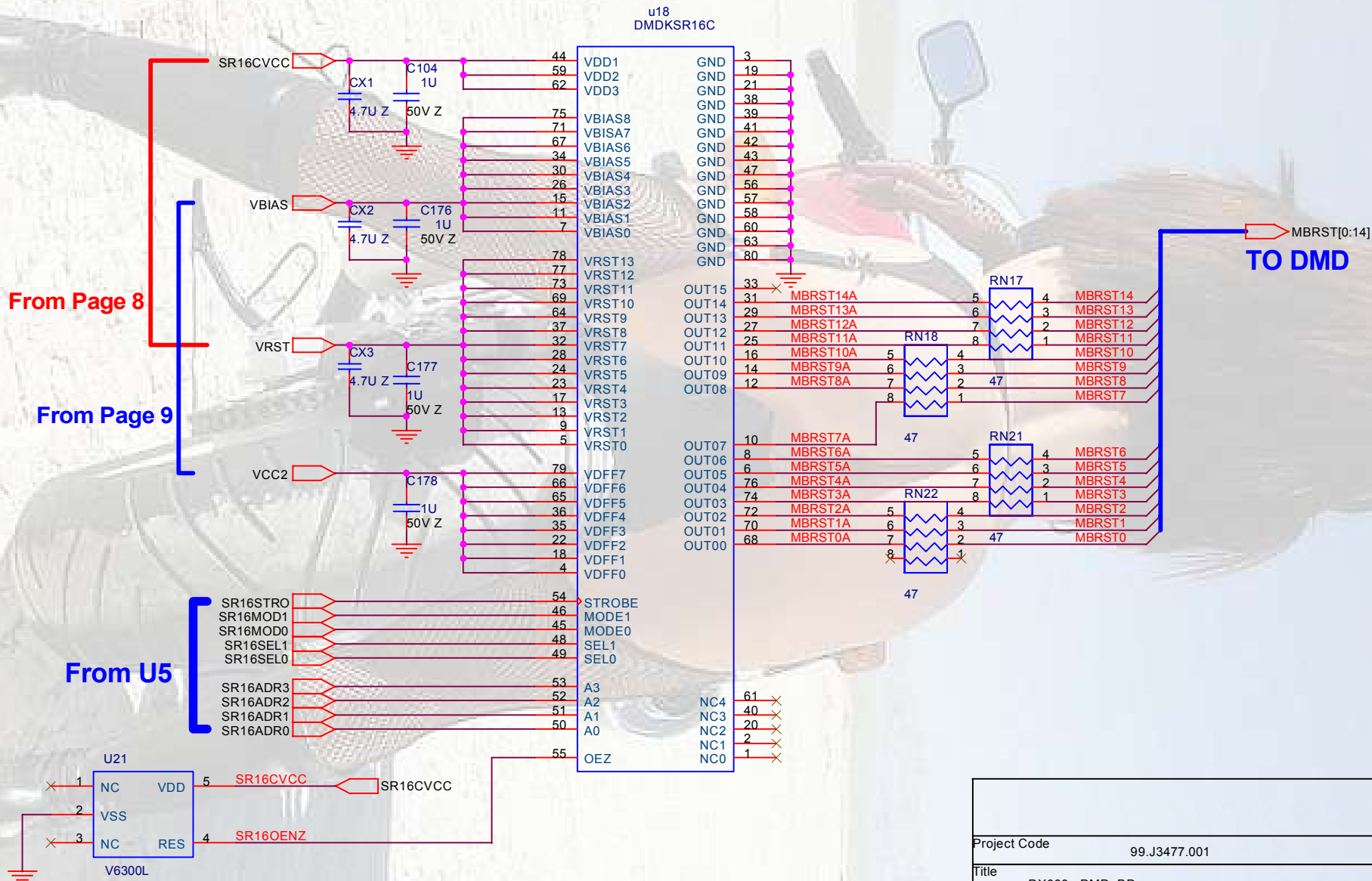

Project Code		99.J3477.001		
Title		DX660 DMD BD		
Size	Document Number	48.J3401.S03	FAB:S03	Rev 1
A3	304-C03			
Date: Wednesday, April 17, 2002		Sheet 11 of 12		
Prepared By		Reviewed By		Approved By
ANGEL HU		BILL WJ CHANG		H.C.TSOU

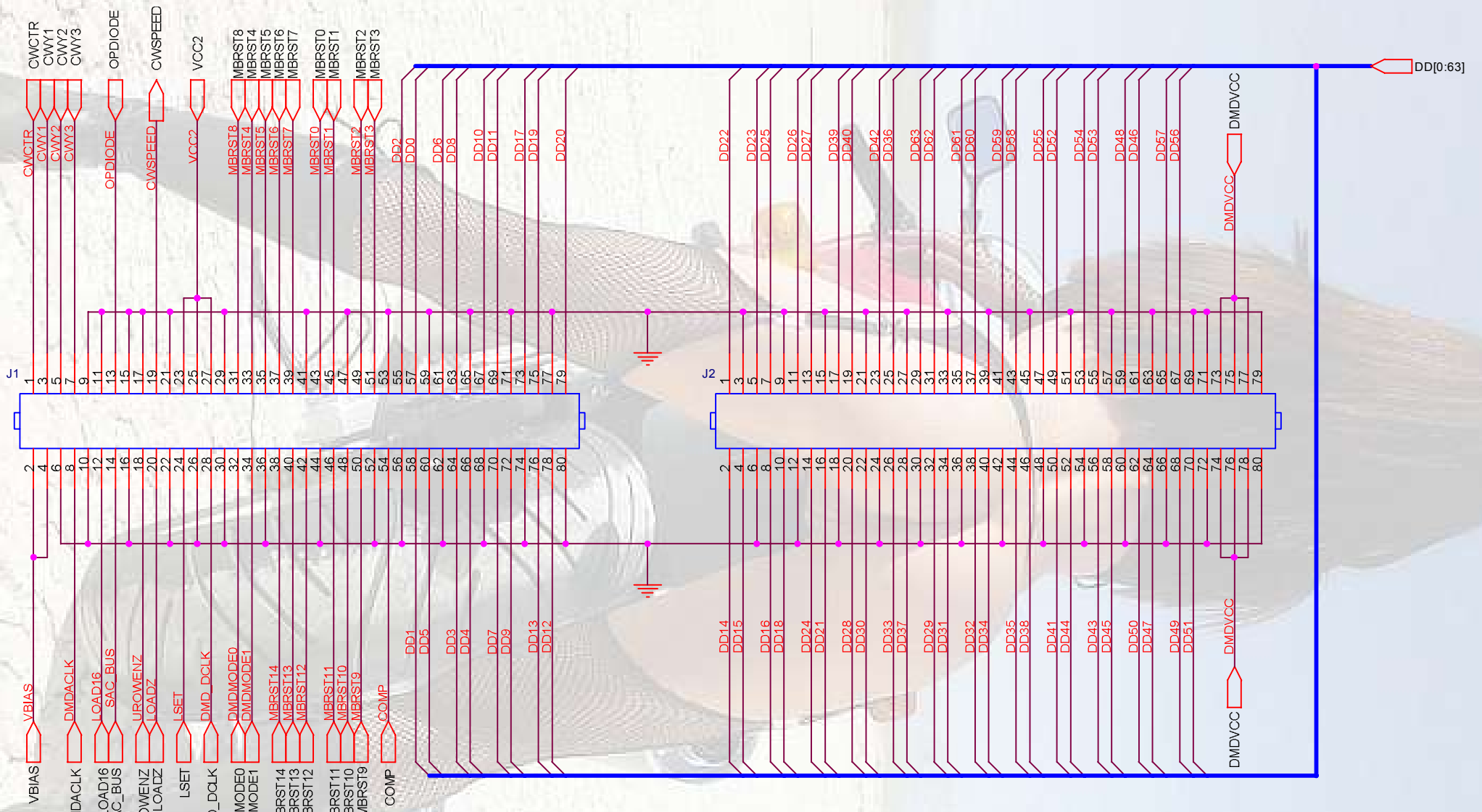

Project Code		99.J3477.001		
Title		DX660 DMD BD		
Size	Document Number	48.J3401.S03	FAB:S03	Rev
A3	304-C03			1
Date: Wednesday, April 17, 2002		Sheet 12 of 12		
Prepared By		Reviewed By		Approved By
ANGEL HU		BILL WJ CHANG		H.C.TSOU

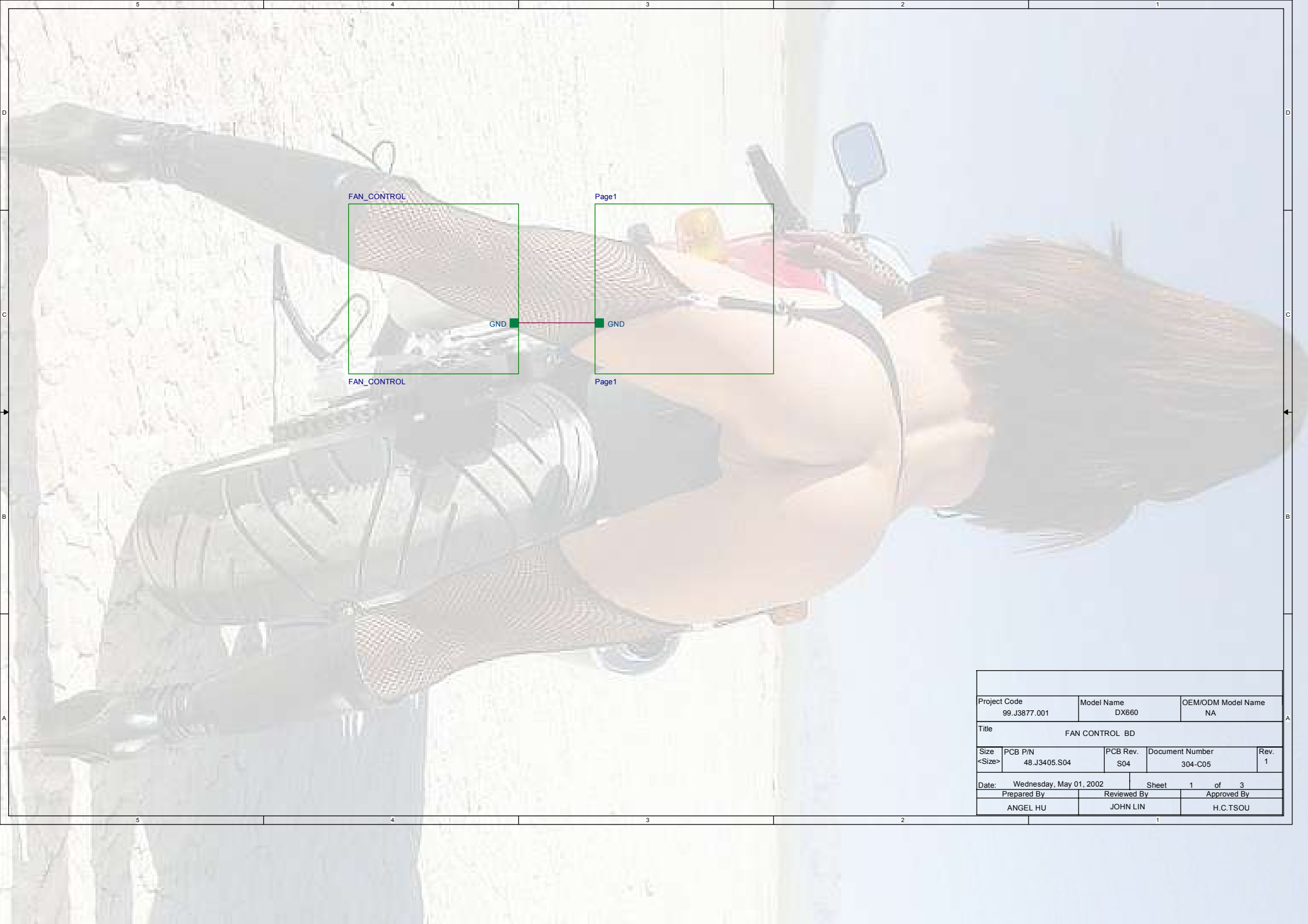

FAN\_CONTROL

Page1

GND

GND

FAN\_CONTROL

Page1

Project Code					Model Name		OEM/ODM Model Name		
99.J3877.001					DX660		NA		
Title					FAN CONTROL BD				
Size	PCB P/N	PCB Rev.	Document Number	Rev.					
<Size>	48.J3405.S04	S04	304-C05	1					
Date:	Wednesday, May 01, 2002			Sheet	1	of	3		
Prepared By		Reviewed By		Approved By					
ANGEL HU		JOHN LIN		H.C.TSOU					

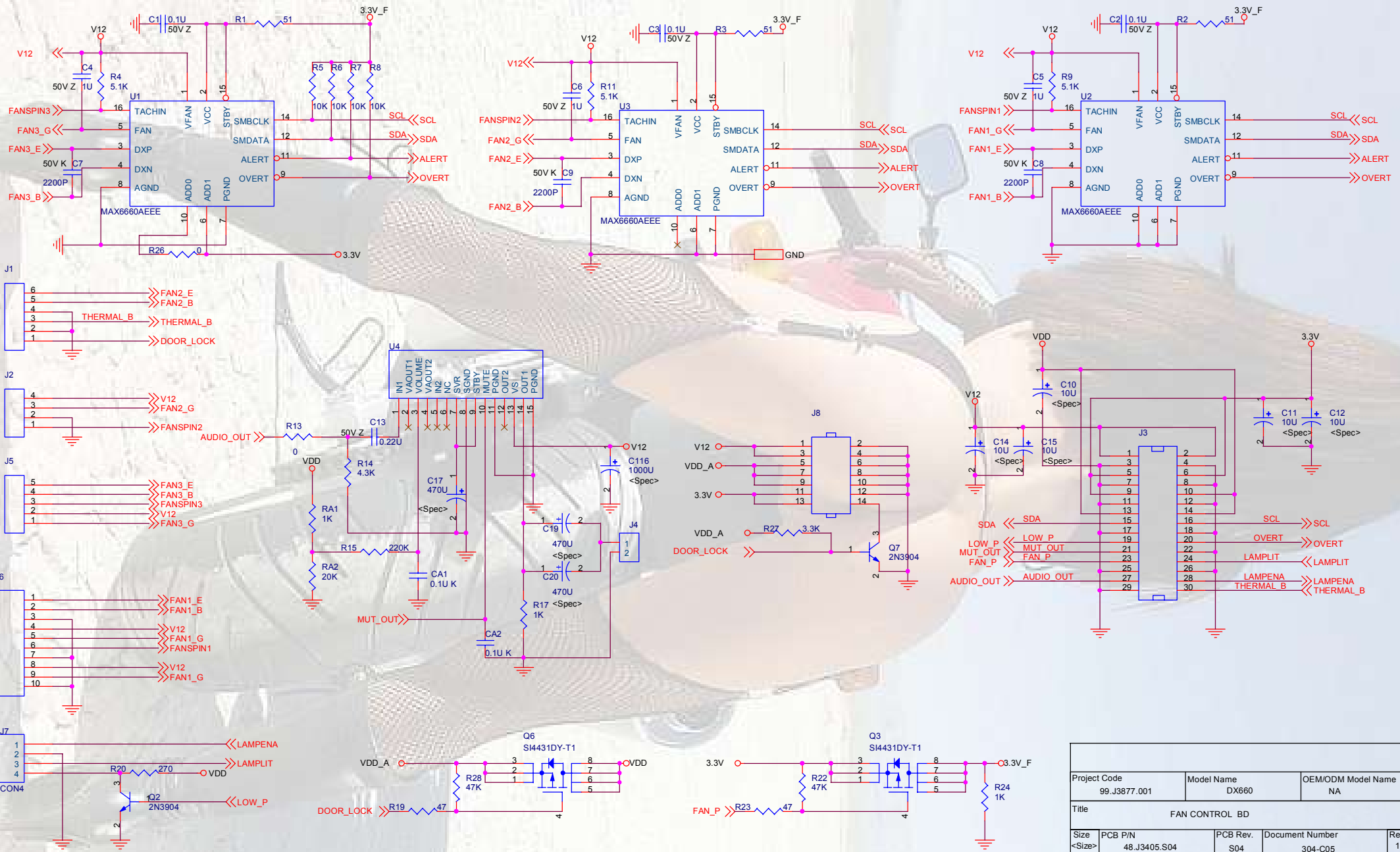

Project Code 99.J3877.001	Model Name DX660	OEM/ODM Model Name NA		
Title FAN CONTROL BD				
Size <Size>	PCB P/N 48.J3405.S04	PCB Rev. S04	Document Number 304-C05	Rev. 1
Date: Wednesday, May 01, 2002	Sheet 2	of 3		
Prepared By ANGEL HU	Reviewed By JOHN LIN	Approved By H.C.TSOU		

Screw Holes

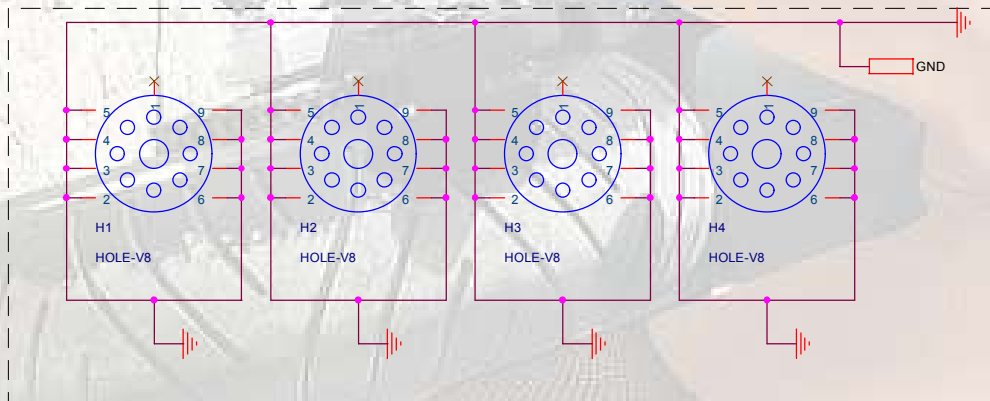

Optical Points

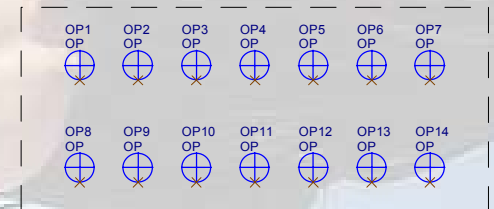

Project Code					Model Name					OEM/ODM Model Name				
99.J3877.001					DX660					NA				
Title														
FAN CONTROL BD														
Size	PCB P/N	PCB Rev.	Document Number	Rev.										
<Size>	48.J3405.S04	S04	304-C05	1										
Date:	Wednesday, May 01, 2002				Sheet	3				of	3			
Prepared By					Reviewed By					Approved By				
ANGEL HU					JOHN LIN					H.C.TSOU				

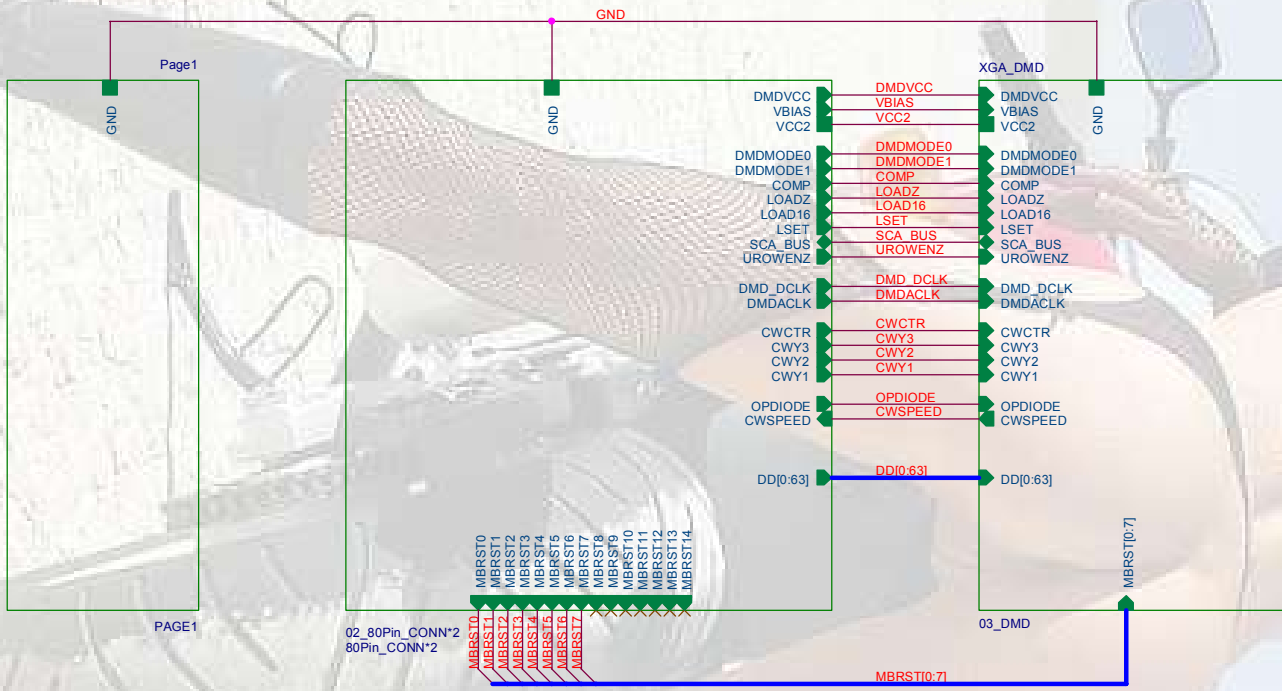

Project Code					99.J3477.001									
Title										DX660 CHIP BD				
Size	Document Number	48.J3404.S02			FAB:S02			Rev	0					
A3	304-C06													
Date: Saturday, April 27, 2002							Sheet		1	of	4			
Prepared By			Reviewed By			Approved By								
ANGEL HU			BILL WJ CHANG			T.S.WU								

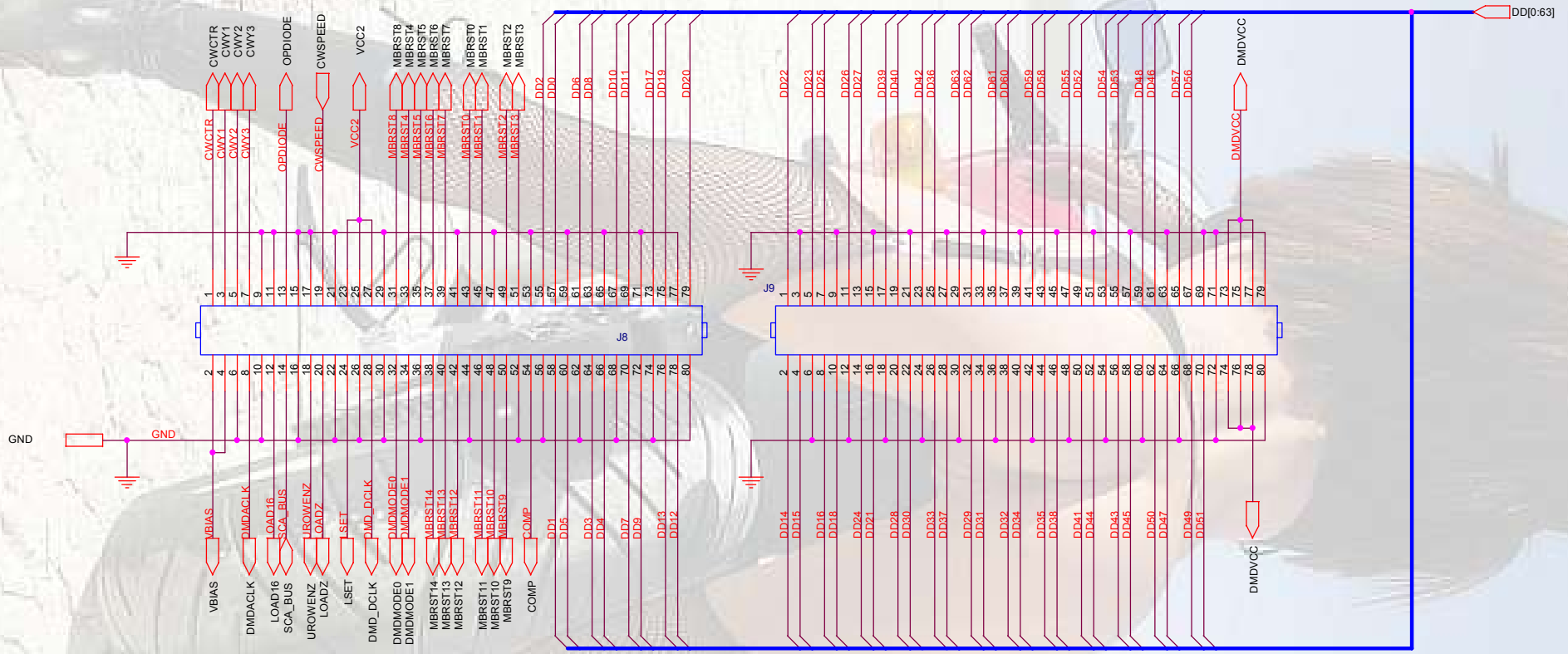

Project Code		99.J3477.001		
Title		DX660 CHIP BD		
Size	Document Number	48.J3404.S02	FAB:S02	Rev 0
A3	304-C06			
Date:	Saturday, April 27, 2002	Sheet	2	of 4
Prepared By	Reviewed By	Approved By		
ANGEL HU	BILL WJ CHANG	T.S.WU		



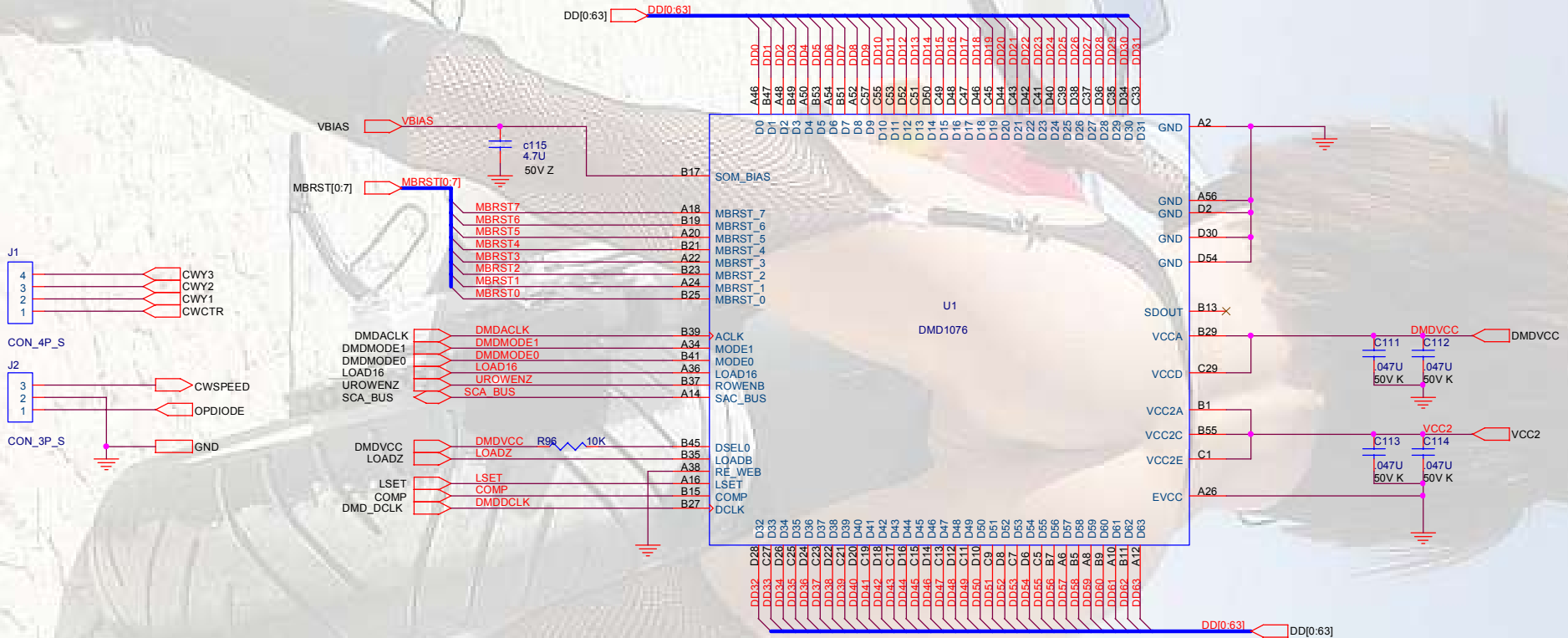

Project Code		99.J3477.001		
Title				
DX660 CHIP BD				
Size	Document Number	48.J3404.S02	FAB:S02	Rev
A3	304-C06			0
Date:	Saturday, April 27, 2002	Sheet	3	of 4
Prepared By	Reviewed By	Approved By		
ANGEL HU	BILL WJ CHANG	T.S.WU		

Screw Holes

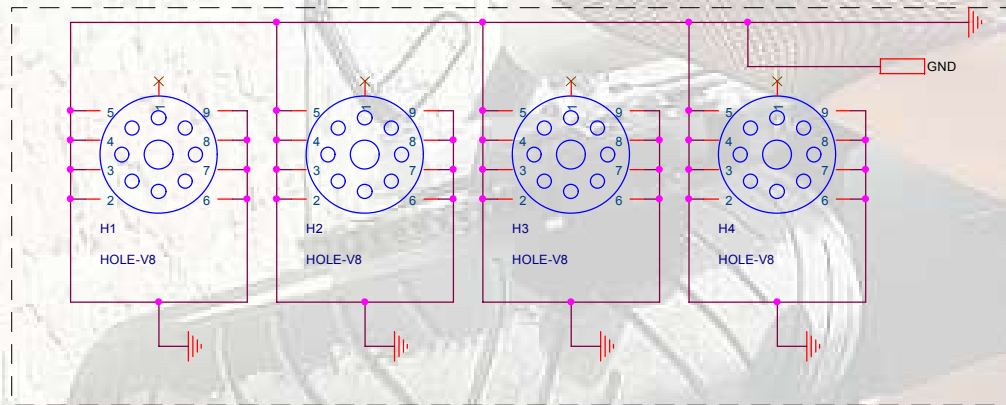

Optical Points



Project Code					99.J3477.001									
Title										DX660 CHIP BD				
Size	Document Number	48.J3404.S02			FAB:S02			Rev	0					
A3	304-C06													
Date: Saturday, April 27, 2002							Sheet			4 of 4				
Prepared By			Reviewed By			Approved By								
ANGEL HU			BILL WJ CHANG			T.S.WU								

## Free Manuals Download Website

<http://myh66.com>

<http://usermanuals.us>

<http://www.somanuals.com>

<http://www.4manuals.cc>

<http://www.manual-lib.com>

<http://www.404manual.com>

<http://www.luxmanual.com>

<http://aubethermostatmanual.com>

Golf course search by state

<http://golfingnear.com>

Email search by domain

<http://emailbydomain.com>

Auto manuals search

<http://auto.somanuals.com>

TV manuals search

<http://tv.somanuals.com>