

QHW series

Digital Weighing Scales

User's guide

Contents

SECTION 1 INTRODUCTION.....	1
SECTION 2 SPECIFICATIONS.....	2
SECTION 3 INSTALLATION.....	3
3.1 General Installation.....	3
3.2 Install of QHW series.....	3
SECTION 4 KEY DESCRIPTIONS.....	4
SECTION 5 DISPLAYS.....	5
SECTION 6 OPERATION.....	6
6.1 Zeroing the display.....	6
6.2 Taring.....	6
6.3 Weighing a sample.....	6
6.4 Percent weighing.....	6
6.5 Parts counting.....	7
6.6 Check-weighing.....	7
6.7 Accumulated total.....	8
6.8 Manual accumulation.....	8
6.9 Automatic accumulation.....	9
SECTION 7 BATTERY OPERATION.....	10
SECTION 8 RS-232 OUTPUT.....	11
SECTION 9 PARAMETERS.....	12
SECTION 10 CALIBRATION.....	13
SECTION 11 ERROR CODES.....	15

SECTION 1 INTRODUCTION

The QHW series of scales provides an accurate, fast and versatile series of general purpose weighing scales with counting, % weighing and check-weighing functions.

There are 4 models in each series, with capacities up to 30 kg.

They all have stainless steel weighing platforms on an ABS base assembly.

All the keypads are sealed, color coded membrane switches and the displays are large easy to read liquid crystal type displays (LCD). The LCD's are supplied with a backlight.

All units include automatic zero tracking, audible alarm for pre-set weights, automatic tare, pre-set tare and an accumulation facility that allows the count to be stored and recalled as an accumulated total.

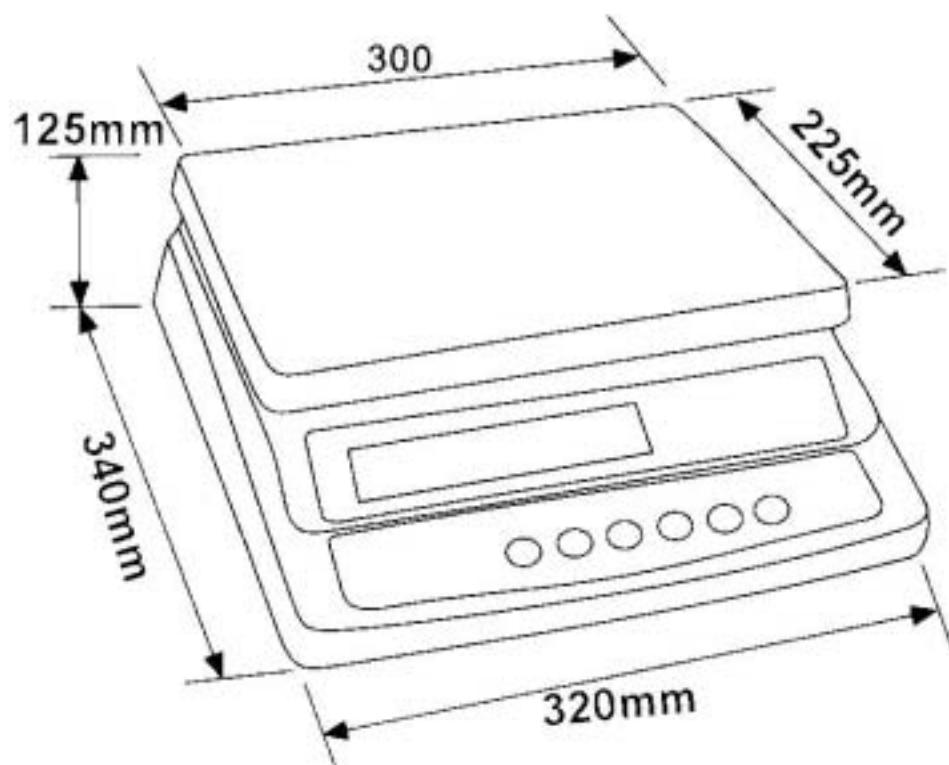

SECTION 2 SPECIFICATIONS

QHW SERIES				
Model #	QHW 3	QHW 6	QHW 15	QHW 30
Maximum Capacity	3kg	6kg	15kg	30kg
Readability	0.1g	0.2	0.5	1g
Resolution	1:30000	1:30000	1:30000	1:30000
Tare Range	-3kg	-6kg	-10kg	-30kg
Minimum Capacity	2g	4g	10g	20g
Repeatability (Std Dev)	0.1	0.2	0.5g	1g
Linearity \pm	0.2g	0.4	1g	2g
Units of Measure	kg, g, Lb., oz.			

Common Specifications

Interface	RS-232 Output Optional
Stabilisation Time	2 Seconds typical
Operating Temperature	0°C - 40°C / 32°F - 104°F
Power supply (external)	115 / 230 Vac, 50/60Hz, 10 watts
Calibration	Automatic External
Display	6 digits LCD digital display
Draft shield	N/A
Balance Housing	ABS Plastic, Stainless Steel platform
Pan Size	225 x 300mm / 8.9 x 11.8"
Overall Dimensions (wxdxh)	320 x 340 x 125mm / 12.6 x 13.4 x 4.9"
Gross Weight	3.8kg/8.4lb
Applications	General Purpose Scale
Functions	Weighing, parts counting, % weight, Check weighing,
Other Features and Specs	Internal rechargeable battery (~70 hours operation)

SECTION 3 INSTALLATION

3.1 GENERAL INSTALLATION

The scales should be sited in a location that will not degrade the accuracy.

Avoid extremes of temperature. Do not place in direct sunlight or near air conditioning vents.

Avoid unsuitable tables. The tables or floor must be rigid and not vibrate. Do not place near vibrating machinery.

Avoid unstable power sources. Do not use near large users of electricity such as welding equipment or large motors.

Avoid high humidity that might cause condensation. Avoid direct contact with water. Do not spray or immerse the scales in water.

Avoid air movement such as from fans or opening doors. Do not place near open windows.

Keep the scales clean.

Do not stack material on the scales when they are not in use.

3.2 INSTALLATION of QHW SERIES

The QHW Series comes with a stainless steel platform packed separately. Place the platform in the locating holes on the top cover. Do not press with excessive force as this could damage the load cell inside.

Level the scale by adjusting the four feet. The scale should be adjusted such that the bubble in the spirit level is in the centre of the level and the scale is supported by all four feet, If the scale rocks readjust the feet.

Attach the mains cable to the connector on the bottom of the scale. The power switch is located on the base near the front of the scale.

SECTION 4 KEY DESCRIPTIONS

Zero or

Set the zero point for all subsequent weighing. The display shows zero.

A secondary function  , of "Enter" key when setting parameters or other functions.

Tare or

Tares the scale. Stores the current weight in memory as a tare value, subtracts the tare value from the weight and shows the results. This is the net weight. Entering a value using the keypad will store that value as the tare value.

A secondary function  , of incrementing the active digit when setting a value for parameters or other functions.

Lim or

Sets the limits for check weighing. Allows setting of either the low limit or the high limit or both.

Secondary function  , is to move the active digit to the right when setting values for parameters or other functions.

%

Enters the percent weighing function. Allows the weight, unit weight, and count to be seen when parts counting.

Secondary function  , is to move the active digit to the left when setting values for parameters or other functions.

Func or

Used to select the function of the scale. If the scale is weighing it will select parts counting. If it is not in weighing mode it will return the user to weighing.

Secondary function (**C**) , is to act as a clear key when setting values for parameters or other functions.

Print or



To print the results to a PC or printer using the optional RS-232 interface. It also adds the value to the accumulation memory if the accumulation function is not automatic.

Secondary function (**ESC**) , is to return to normal operation when the scale is in a parameter setting mode.

U key

This key will select either kilograms, pounds, ounce, g and t for the weighing unit.

SECTION 5 DISPLAYS

The LCD display will show a value and a unit to the right of the digits. In addition there are labels for TARE, GROSS weight, ZERO  and for Low battery 

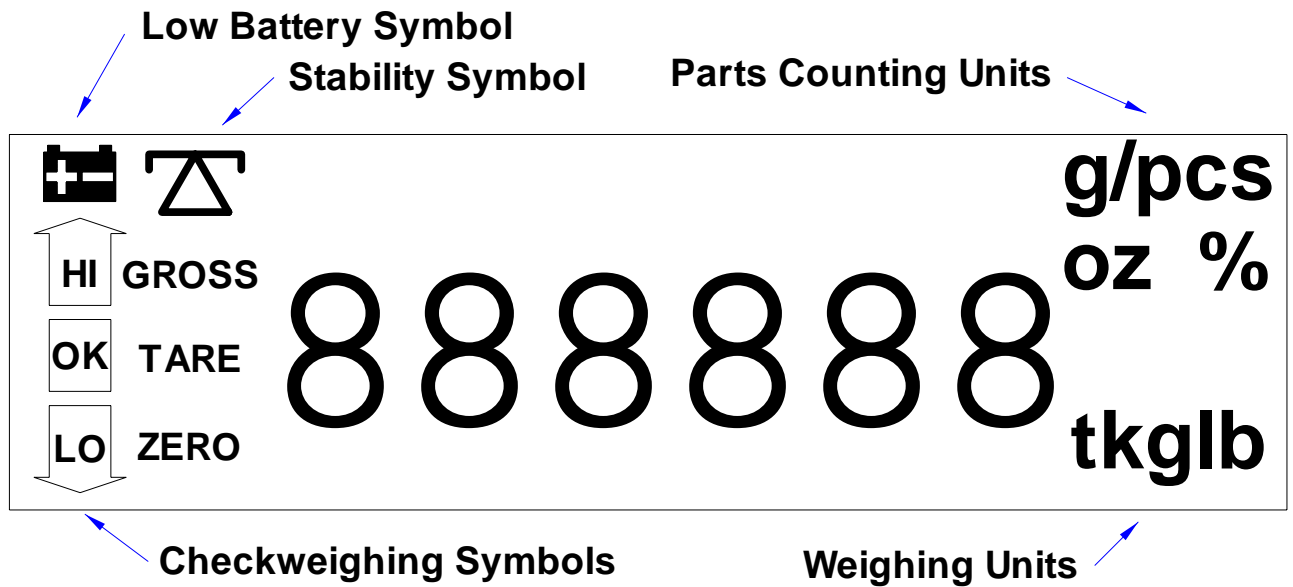

SECTION 6 OPERATION

6.1 ZEROING THE DISPLAY

You can press the **ZERO/ENTER** key at any time to set the zero point from which all other weighing and counting is measured, within 4% of power up zero. This will usually only be necessary when the platform is empty. When the zero point is obtained the display will show the indicator for zero.

The scale has an automatic rezeroing function to account for minor drifting or accumulation of material on the platform. However you may need to press the **ZERO/ENTER** key to rezero the scale if small amounts of weight are shown when the platform is empty.

6.2 TARING

Zero the scale by pressing the **ZERO/ENTER** key if necessary. The zero indicator will be on.

Place a container on the platform, a value for its weight will be displayed.

Press the **TARE** key to tare the scale. The weight that was displayed is stored as the tare value and that value is subtracted from the display, leaving zero on the display. The "TARE" indicator will be on. As product is added only the weight of the product will be shown. The scale could be tared a second time if another type of product was to be added to the first one. Again only the weight that is added after taring will be displayed.

When the container is removed a negative value will be shown. If the scale was tared just before removing the container this value is the gross weight of the container plus all product that was removed. The zero indicator will also be on because the platform is back to the same condition it was when the **ZERO/ENTER** key was last pressed.

6.3 WEIGHING A SAMPLE

To determine the weight of a sample first tare the empty container then place the sample in the container. The display will show the weight and the units of weight currently in use.

6.4 PERCENT WEIGHING

The scale will allow a sample weight to be shown as 100%. Then any other weight placed on the scale will be displayed as a percentage of the original sample. For example 350g is placed on the scale and the % key is pressed the display will show 100.00%.

Removing the 350g weight and putting a 300g weight on the scale the display will show 85.71% as 300g is 85.71% of 350g.

Note: the scale may jump by large numbers unexpectedly if small weights are used to set the 100% level. For example if only 23.5g is on a scale with 0.5g increments and the scale is set to 100%, the display will show 100.00%, however a small change

of weight will cause the display to jump to 102.13% as one scale division (0.5g) increase to 24.0g will be equivalent to a 2.13% increase.

Removing the 350g weight and putting a 300g weight on the scale the display will show 85.71% as 300g is 85.71% of 350g.

Pressing the **FUNC** key will return the scale to weighing.

6.5 PARTS COUNTING

When the scale is showing weight, pressing the **FUNC** key will start the parts counting function.

Before beginning, tare the weight of any container that will be used, leaving the empty container on the scale. Place the number of samples on the scale. The number should match the options for parts counting, 10, 20, 50, 100 or 200 pieces.

Press the **FUNC** key to begin. The scale will show "SP 10" asking for a sample size of 10 parts. Change the sample size by pressing the **TARE/↑** key. the display will cycle through the options: 10,20, 50, 100, 200 and back to 10.

Press the **ZERO/ENTER** key when the number matches the number of parts used for the sample. As more weight is added the display will show the number of parts (pcs).

Press the **%** key to display unit weight (g/pcs), Total weight (kg) or the count (pcs). Press the **FUNC** key to return to normal weighing.

6.6 CHECK-WEIGHING

Check-weighing is a procedure to cause an alarm to sound when the weight on the scale meets or exceeds values stored in memory. The memory holds values for a high limit and a low limit. Either limit can be used or both can be used.

Press the **LIMIT** key. The display will show the current High Limit with the left most digit flashing and the HI symbol on to the left of the display..

To change the value shown use the **%/←** and the **LIMIT/→** to select the digit to change. Then use the **TARE/↑** key to increment the flashing digit. When the desired value is shown press the **ZERO/ENTER** key to accept the value. If you want to reset the value to zero press the **FUNC/C** key to clear the value.

After pressing the **ZERO/ENTER** key the display will then show the Low Limit, the LO symbol will be on to the left side of the display.

Enter the low limit in the same way the high limit was entered.

After pressing the **ZERO/ENTER** key the scale will return to weighing with the Check-weighing function enabled.

When a weight is placed on the scale the arrows will show if the weight is above or below the limits and the beeper will sound as described below.

BOTH LIMITS SET

The display will show OK and the beeper will sound when the weight is between the limits.

LOW LIMIT SET,

HIGH LIMIT is set to zero

The display will show OK and the beeper will sound when the weight is less than the Low Limit. Above the Low Limit the display will show HIGH and the beeper will be off.

HIGH LIMIT SET,

LOW LIMIT is set to zero

The display will show LOW and the beeper will be off when the weight is less than the High Limit. Above the High Limit the display will show OK and the beeper will be on.

BOTH LIMITS SET. LOW IS SET GREATER THAN HIGH

The beeper will never sound and the display will show LOW if the weight is less than the LOW limit, and HIGH if the weight is greater than the Low Limit.

NOTE: The weight must be greater than 20 scale divisions for the check weighing to operate.

To disable the Check-Weighing function enter zero into both limits by pressing the **FUNC/C** key when the current limits are shown then pressing the **ZERO/ENTER** key to store the zero values.

6.7 ACCUMULATED TOTAL

The scale can be set to accumulate automatically when a weight is added to the scale or manually by pressing the **PRINT** key. See the PARAMETERS Section for details of selecting the method. The accumulation function is only available when weighing. It is disabled during percent weighing or parts counting.

6.8 MANUAL ACCUMULATION

When the scale is set to manual accumulation the weight displayed will be stored in memory when the **PRINT** key is pressed and the weight is stable.

The display will show "ACC 1" and then the total in memory for 2 seconds before returning to normal. If the optional RS-232 interface is installed the weight will be output to a printer or PC.

Remove the weight, allowing the scale to return to zero and put a second weight on. Press **PRINT**, the display will show "ACC 2" and then show the new total.

Continue until all weights have been added.

To view the totals in memory press the **PRINT** key when the scale is at zero. The display will show the total number of items "ACC xx" and the total weight before returning to zero. The totals will also be printed via the RS-232 interface.

To erase the memory press **PRINT** to view the totals and then press the **FUNC/C** key to clear the memory.

6.9 AUTOMATIC ACCUMULATION

When the scale has been set to Automatic Accumulation the value is stored in memory automatically.

Add a weight to the scale, the beeper will sound when the scale is stable to signify the value is accepted. Remove the weight.

The display will show "ACC 1" and the totals in memory when the scale returns to zero. Adding a second weight will repeat the process.

While the weight is on the scale it is permissible to press the **PRINT** key to store the value immediately. In this case the scale will not store the value when the weight is removed.

The totals can be viewed as above.

In all cases the scale must return to zero or a negative number before another sample can be added to the memory.

More product can then be added and **PRINT** pressed again. This can continue for up to 99 entries, or until the capacity weight display is exceeded.

SECTION 7 BATTERY OPERATION

The scales can be operated from the battery if desired. The battery life is approximately 100 hours.

When the battery needs charging the arrow above the low battery symbol under the weight display will turn on. The battery should be charged as soon as the arrow above the symbol is on. The scale will still operate for about 10 hours after which it will automatically switch off to protect the battery.

To charge the battery simply plug into the mains power. The scale does not need to be turned on.

The battery should be charged for 12 hours for full capacity.

Just under the quantity display is an LED to indicate the status of battery charging. When the scale is plugged into the mains power the internal battery will be charged. If the LED is green the battery has a full charge. If it is Red the battery is nearly discharged and yellow indicates the battery is being charged.

As the battery is used it may fail to hold a full charge. If the battery life becomes unacceptable then contact your distributor .

SECTION 8 RS-232 OUTPUT

The QHW Series of scales can be ordered with an optional RS-232 output.

Specifications:

RS-232 output of weighing data
ASCII code
4800 Baud
8 data bits
No Parity

Connector: 9 pin d-subminiature socket

Pin 2 Output

Pin 3 Input, not used at this time

Pin 5 Signal Ground

Data Format for normal weighing operations, parts counting or recalling of totals from memory will all be different. Examples follow:

Normal Output

GS	1.234kg	GS for Gross weight, NT for net weight and a unit of weight
No..	1	This number increments every time a new value is stored in memory
Total	1.234kg	The total value stored in memory
<lf>		Includes 2 line feeds
<lf>		

When percent weighing the output is the weight shown in percent only.

GS	100.00%	GS for Gross weight, NT for net weight and a unit of weight
<lf>		Includes 2 line feeds
<lf>		

SECTION 9 PARAMETERS

The scale has 6 parameters that can be set by the user. These allow the user to set the scale to:

- Display the weight in other increments of weight to minimize the affects of vibration, wind or other environmental conditions.
- Control the back light on the display. It may be necessary to turn the backlight off to maximize battery life.
- Set the Accumulation to Automatic, manual or set the RS-232 interface to continuously print the weight.
- Set whether accumulation when print
- Set auto zero range
- Select another weighing unit than the standard.

To set parameters press the **FUNC** and **PRINT** keys at the same time.

The display will show "Inc xx" The first value shown is the default scale increment value. To select a different increment value press the **TARE/↑** key to change the value then press the **ZERO/ENTER** key.

For example on a 15kg scale the standard increment is 0.5g, the value can be changed to 1.0g or 2.0g.

The next parameter is control of the backlight. The standard is to have the backlight operate automatically, turning off when the scale is not used. The backlight can be set to be "EL On" , "EL Au" (Automatic) or "EL Off". The maximum battery life is achieved with the backlight turned off.

Press the **TARE/↑** key to change the value then press the **ZERO/ENTER** key.

Automatic accumulation is next. With "Au On" the memory will accumulate the weight automatically, "Au Off" will enable the manual accumulation and with "P Cont" set the RS-232 interface will send the weight continuously and the accumulation function is disabled.

Press the **TARE/↑** key to change the value then press the **ZERO/ENTER** key.

Whether accumulation when print is next, With "ACC ON" when you print it will accumulation, "ACC OF" will only print without accumulation.

Press the **TARE/↑** key to change the setting then press the **ZERO/ENTER** key.

Auto zero range is next, you can select 0.5d, 1d, 2d and 4d.

Press the **TARE/↑** key to change the setting then press the **ZERO/ENTER** key.

The displayed unit of weight is set next. The scales are normally calibrated and display in kilograms, however they will show the weight in grams, ounces or pounds and selected by this function.

Press the **TARE/↑** key to change the value then press the **ZERO/ENTER** key.

When the scales are set to display in other units of weight the accumulation function is still keeping the weight in kilograms.

SECTION 10 CALIBRATION

10.1 Linear calibrate

To start calibration turn the scale off and then turn it back on. Press the **limit** and **%** keys together during the initial counting from 9 to 0 on the display.

The display will show "unLoAd". Remove all weight from the pan and then press the **ZERO/ENTER** key to set the initial zero point.

The display will then show the first calibration weight request. Put this weight on the platform and then press the **ZERO/ENTER** key when stable. The scale should be stable before pressing the **ZERO/ENTER** key to accept a weight. The stability indicator will turn on to show the value is stable.

After all calibrate weight completed, press **ZERO/ENTER** to complete the calibration. The scale will begin counting back to zero after the last weight has been selected.

Calibration weights

QHW SERIES				
Model #	QHW 3	QHW 6	QHW 15	QHW 30
Weight 1	zero	zero	zero	zero
Weight 2	1000g	2kg	5kg	10kg
Weight 3	3000g	6kg	15kg	30kg

10.2 Normal calibrate

To start calibration turn the scale off and then turn it back on. Press the **Tare** and **%** keys together during the initial counting from 9 to 0 on the display.

The display will show "unLoAd". Remove all weight from the pan and then press the **ZERO/ENTER** key to set the initial zero point.

Then use **%**, **Limit** and **Tare** key to key in calibrate weight, press **Zero** key to sure, display shows "load", put this weight on platter, after stable indicator on, press **Zero** key to sure.

After selfchecking again, QHW is ready for you.

SECTION 11 ERROR CODES

During the initial power-on testing or during operation it is possible the scale may show an error message. The meaning of the error messages is described below.

If an error message is shown repeat the procedure that caused the message, turning the balance on, calibration or other functions. If the error message still is shown then contact your dealer for further support.

ERROR CODE	DESCRIPTION	POSSIBLE CAUSES
Err 4	Initial Zero is greater than allowed (4% of maximum capacity) when power is turned on or when the ZERO/ENTER key is pressed,	Weight on the pan when turning the scale on. Excessive weight on the pan when zeroing the scale. Improper calibration of the scale. Damaged load cell. Damaged Electronics.
Err 5	Keyboard Error.	Improper operation of the scale.
Err 6	A/D count is not correct when turning the scale on.	Platform not installed. Load cell damaged. Electronics damaged.

To view the A/D count press the **ZERO/ENTER** key and the % key at the same time while the scale is performing the initial check at power-on. Press **ZERO/ENTER** to return to normal.

Free Manuals Download Website

<http://myh66.com>

<http://usermanuals.us>

<http://www.somanuals.com>

<http://www.4manuals.cc>

<http://www.manual-lib.com>

<http://www.404manual.com>

<http://www.luxmanual.com>

<http://aubethermostatmanual.com>

Golf course search by state

<http://golfingnear.com>

Email search by domain

<http://emailbydomain.com>

Auto manuals search

<http://auto.somanuals.com>

TV manuals search

<http://tv.somanuals.com>