

‘ez Phone’

Installation and User Guide

Model: LDK system

Issue 1.0A

2004.09.03

LG Electronics Inc

REVISION HISTORY

ISSUE	DATE	Description
1.0A	2003.04.18	
		- General Description
		- Fixed miss spelling. - Removed the cartoon - Transfer with address book window. - Hardware Requirement
		- Add short key without pressing ctrl key (Transfer, Edit and so on) - Transfer by name - Modified Normal popup window.
		- Add short key without pressing ctrl key (Transfer, Edit and so on) - Transfer by name - Modified Normal popup window.
		- Message Hook Dial (Ctrl + C -> Ctrl + D) changed to (Ctrl + C -> Ctrl + Shift + D)
	2003.8.10	- SLT, DECT with ez Phone - Favorite (Schedule Dial Window) manual update
	2003.9.10	- Add Functionality(Camp on, msg wait, etc)- For LDK 100,300, 600
	2003.10.10	- Modified normal popup window manual (Blind transfer-> Transfer)
	2003.11.05	- Modified Option window for Searching way) – B.0Ad - Auto ACNR for Busy of External outgoing call (Schedule Dial) – B.0Ad
	2003.11.11	- Fixed outlook import, export
	2003.12.05	- SMS OVER GSM , Recommendation(for outlook) .(over 2.0Ag) - Added User greeting SAVE Button(over 2.0Ah)
	2004.04.19	- V3 Function(Agent, Conference Room, VMIB Addition)
	2004.05.01	- Dao Installation is internally processed by ez phone installation program. But if you meet error message ‘internal application error”, you should install Dao program by manually.(Page 16)
	2004.07.27	- Net DSS is added for flex button assignment - Keeping sorting order for station window & SLT SMS Receiving

'EZ PHONE'	1
GENERAL DESCRIPTION	6
1. INTRODUCING EZ PHONE (LDK SYSTEM)	6
1.1. Overview	6
2. HARDWARE / SOFTWARE REQUIREMENT	8
2.1. Hardware Requirement	8
2.2. Software Requirement	8
2.3. Connections	9
INSTALLING1 (LDK TSP)	11
INSTALLING2 (DAO)	16
USER FEATURE DESCRIPTION	23
1. MAIN WINDOW	25
1.1 Menu	25
1.2 Top Toolbar	26
1.3 Bottom Toolbar	30
1.4 Call Window	33
1.5 Information Window	41
1.6 Message Window	42
Usage.....	42
1.7 Station Information Window	44
1.8 Address Book Window (Own DB Address)	47

1.9	Log – View.....	49
1.10	Favorite (Schedule Dial Window).....	50
2.	ETC WINDOW	52
2.1	Flex Button Assignment Dialog.....	52
2.2	VMIB Dialog.....	53
2.3	Customize Dialog.....	53
2.4	Option Dialog.....	56
2.5	Always On Top.....	60
2.6	Import Outlook Contacts Into My Own Address Book	61
2.7	Export My Own Address Book Export to Outlook	62
3	TIPS	64
3.1	Focus (F1, F2, F3, F4)	64
3.2	Sub Window Focus (Ctrl + Tab).....	65
3.3	Make Call without using 'ez Phone' Window.	66
3.4	Task Bar State.....	66
3.5	Lock Key Missing Message Box.....	67
3.6	SLT and DECT.	67
4	ADDITION(INTEGRATION VERSION)	68
1.1	Operation for internal outgoing call(when ring back)	68
1.2	Operation for internal outgoing call(when busy)	68
1.3	Operation for connected status	69

1.4	Vimb and Msg wait Notification	69
1.5	My station program(in menu)	70
1.6	Auto ACNR(Schedule Dial Window).....	70
1.7	SMS OVER GSM.....	71
5	MODIFIED FEATURE (INTEGRATION VERSION).....	74

GENERAL DESCRIPTION

1. Introducing ez Phone (LDK SYSTEM)

1.1. Overview

Welcome to LDK- 'ez Phone' for Windows Computer Telephony Integration (CTI). Computer Telephony adds computer intelligence to the making and receiving of telephone calls. With Computer Telephony, user can use computers to take advantage of a wide range of sophisticated communication features and services over a telephone line. LDK-PCPHONE includes a various value added features to integrate Computer and Telephone, to manage all the details associated with telephone business. With LDK-'ez Phone' 's Graphical User Interface, you can easily use the following features;

- Many kind of DB (Outlook, Gold mine, ACT!, ACCESS, ECXEL) are can be import and export.
- Working [operating] together with Outlook contacts real timely.
- Dial Reservation List. (Automatic call operation)
- 3 Kinds of Popup windows for notify incoming call.
- Simple Mode Window and Own Memo List.
- Make outgoing calls, place a call on 'Hold & unhold' and Transfer, conference, park/unpark etc.
- Log a call for your history and statistical information.
- Utilize Dial Database File
- View Call Processing Status
- ETC. (Option, Customize.)
- Mobile SMS Sending

There are two types of ez Phone version.

One is an entry; the other is a deluxe.

Please refer to the below table for each version's function.

Entry

- ✓ **Local DB, Capacity Limit**
- ✓ **Basic DKTU feature**

- ◆ Individual DB
- ◆ Screen Pop w/local DB
- ◆ Call Log : Max 20
- ◆ Received, Missed, Dialed
- ◆ Click & Call
- ◆ Flexible BTN Assign
- ◆ Call by name
- ◆ Only for local DB
- ◆ Call Transfer
- ◆ Hold/Retrieve
- ◆ Forwarding
- ◆ Keyboard Mapping

Delux

- ✓ **DB Conversion**
- ✓ **SMS to Keypad and Mobile**

- ◆ All Entry features
- ◆ DB Conversion :
- ◆ MS Outlook/Access, Goldmine
- ◆ ACT Database import and export
- ◆ SMS(Private, Mobile) Sending
- ◆ SMS control
- ◆ Forwarding
- ◆ Differential ring by CLI
- ◆ Email Notification
- ◆ VMIB Control
- ◆ ACNR
- ◆ Call Filtering : VIP/Black List
- ◆ By DND/FWD/Ring
- ◆ Scheduled Dial

Table 1

2. Hardware / Software Requirement

2.1. Hardware Requirement

1) Key System: LDK SYSTEM

Normal Key set.(DKTU), SLT, DECT(over GDC-345H)

2) Normal Requirement

→ Your PC should be at least meet the following requirements

- **Operating System:** Win 98, Windows NT, Window 2000
Win Me, Window XP home, pro.
- **Recommend Processor:** Pentium III 300 MHz
- **Recommend RAM:** 128 MB
- **Available Hard Space:** 200 MB
- **Video Card:** SVGA(Min. 256 colors/800x600)
- **Minimum Processor:** Pentium MMX- 200MHz
- **Minimum RAM:** 64 MB

Notes: For 800x600, the right window (Date/Time, Own memo) can not be shown and be used

2.2. Software Requirement

1) PC: Window 98 or higher

ez Phone Program (CTI Application)

2) Dao35Registor.exe

3) To make the connection between the 'ez Phone' and your telephone (LDK), you have to install LG TAPI-driver packed together.

2.3. Connections

◆ 1st Party (For LDK 24 Only) - NeXer

The following **Figure 1** describes the Interface Block Diagram of LDK 24 Main System Unit.



[Figure 1] LDK - 'ez Phone' System Block Diagram (1st Party)

◆ 1st Party (LDK 100,300,600 Only)

The following **Figure 2** describes the Interface Block Diagram of LDK-300 Main System Unit, DTIB, CTI Keypad, and RS-232C Port 9 pin male connections of the LDK system.

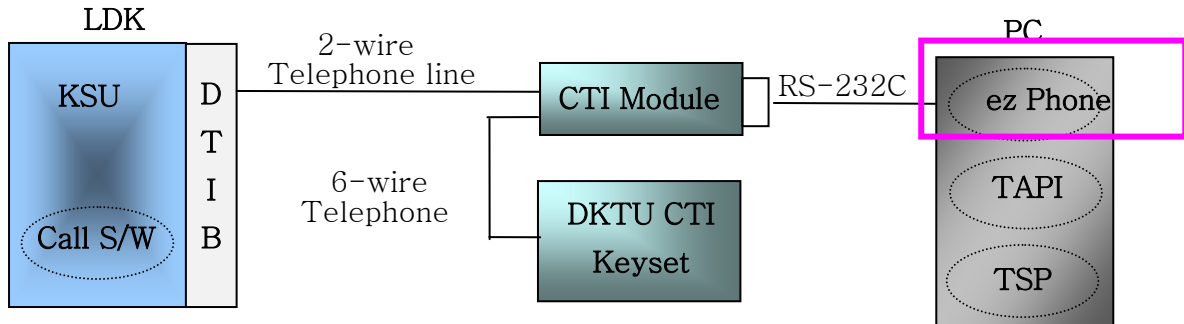

[Figure 2] LDK - 'ez Phone' System Block Diagram (1st Party)

◆ **3rd Party (LDK 100,300,600 Only)**

The following **Figure 3** describes the Interface Block Diagram of LDK-300 Main System Unit, DTIB, Normal Keyset, CTI Server, and PC.

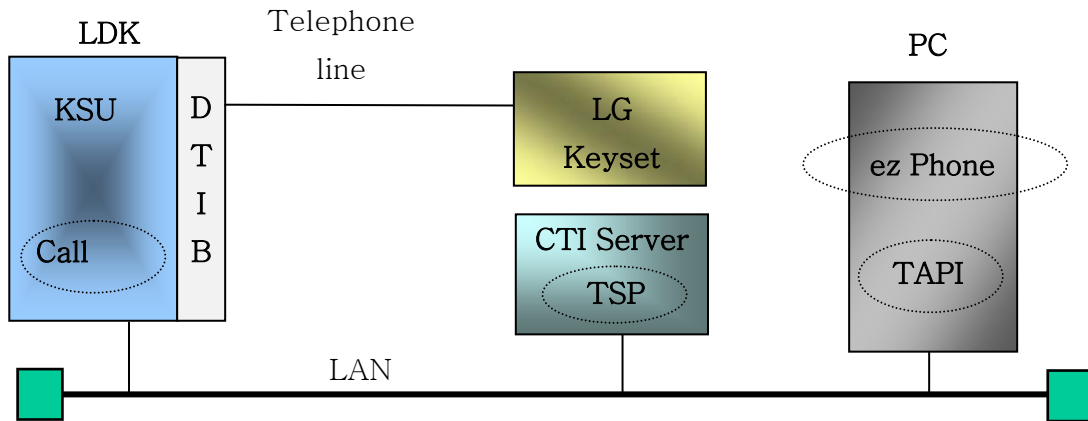

[Figure 3] LDK -- 'ez Phone' System Block Diagram (3rd Party)

- **CTI Server should set each user for ez Phone line assignment**
- **This method is different from LDK -24 line assignment.**
- **This setting should be needed an expert for CTI server management**

Installing1 (LDK TSP)

You must Setup TSP File First.

- ◆ 1st Party

You should install LDK TSP to your computer.

- ◆ 3rd Party

You should install LDK TSP to CTI server pc.

If you setup TSP, the following wizard is appeared.

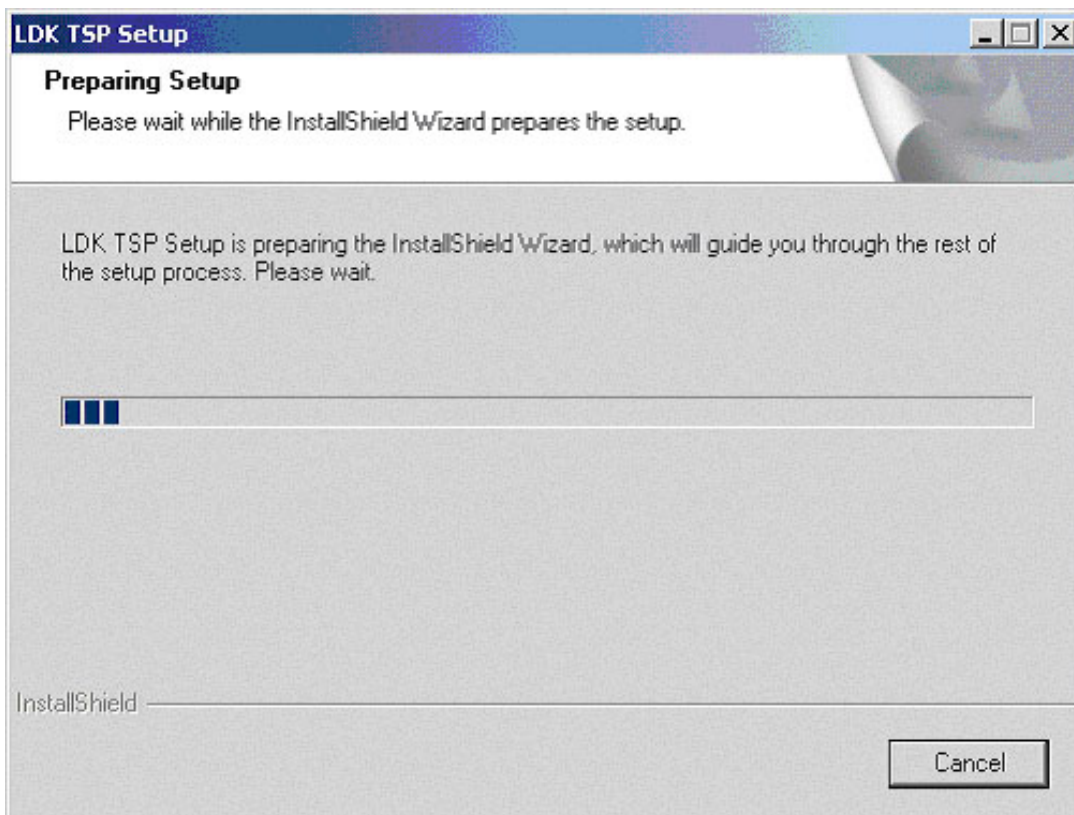

If you want to install the TSP, Click [Yes]. If you click [No], Setup is canceled.

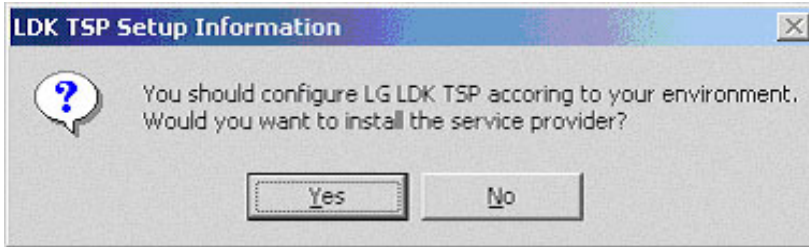

If you click [Yes], setup is complete.

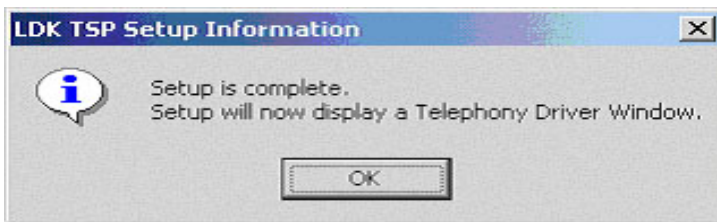

Click [OK], you will see the next dialog.

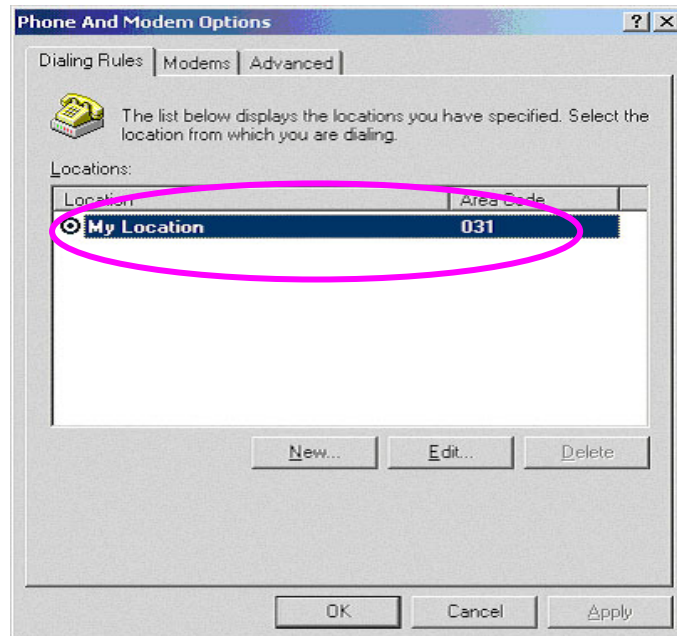

- ***Then, Click My Location and press [Edit] button. Then, you will see the below Dialog.***
- ***This is very important to make Co line call with 'ez Phone' or other Client.***

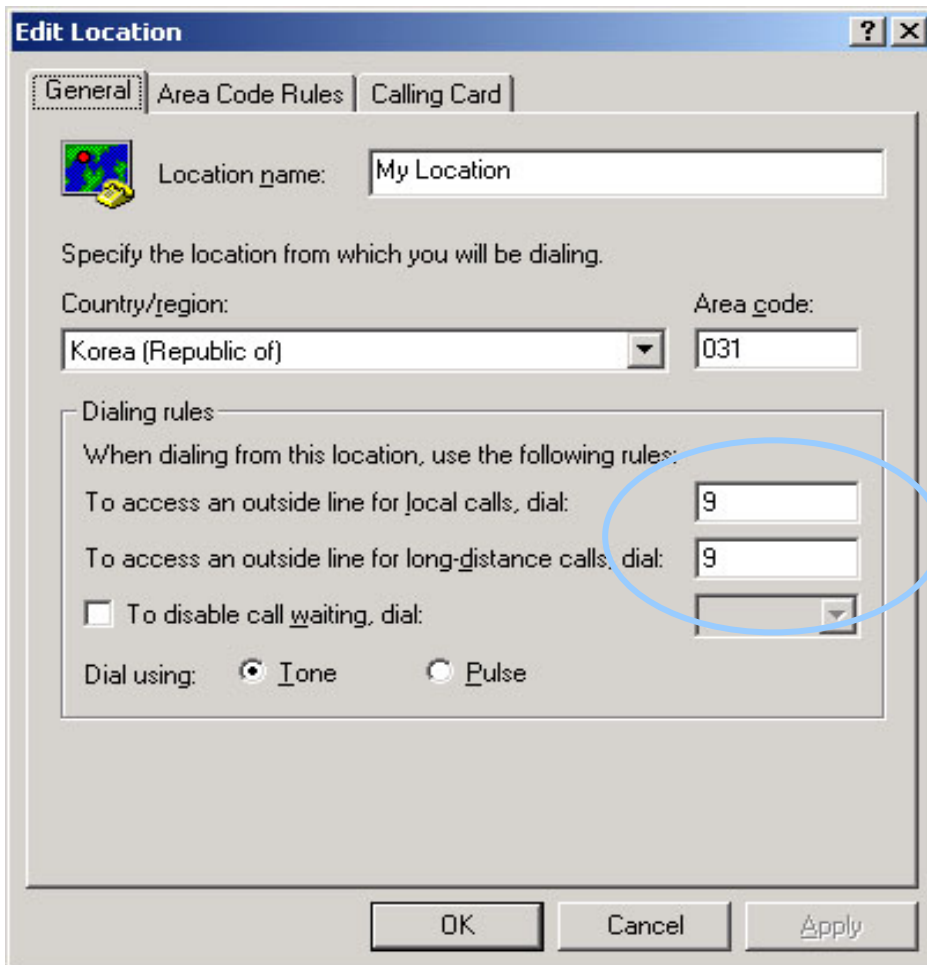

Loop Code should be set in your desktop PC for making external call)- Both of 1st and 3rd party

LDK SYSTEM adds this number when make Co line Call.

EX) A number which is saved in your address book or any other number is over than 6 char,

'ez Phone' thinks the number is for Co line call number. So, adds this number in front of the number.

4566- 222- 4444 → 9 4566- 222- 4444 (Loop number 9 is added)

When you make call with Keyset, how do you press number?

May you press [LOOP] then 4566 222 4444 → To input Loop Number is not necessary for 'ez Phone'.

Or [LOOP] [LOOP] then 4566 222 4444 → To input Loop Number is necessary once(ex. 9-4566 222 4444)

Click [Advanced] tab.

After selecting [Telephony Service Provider for LDK], click [Configure...]

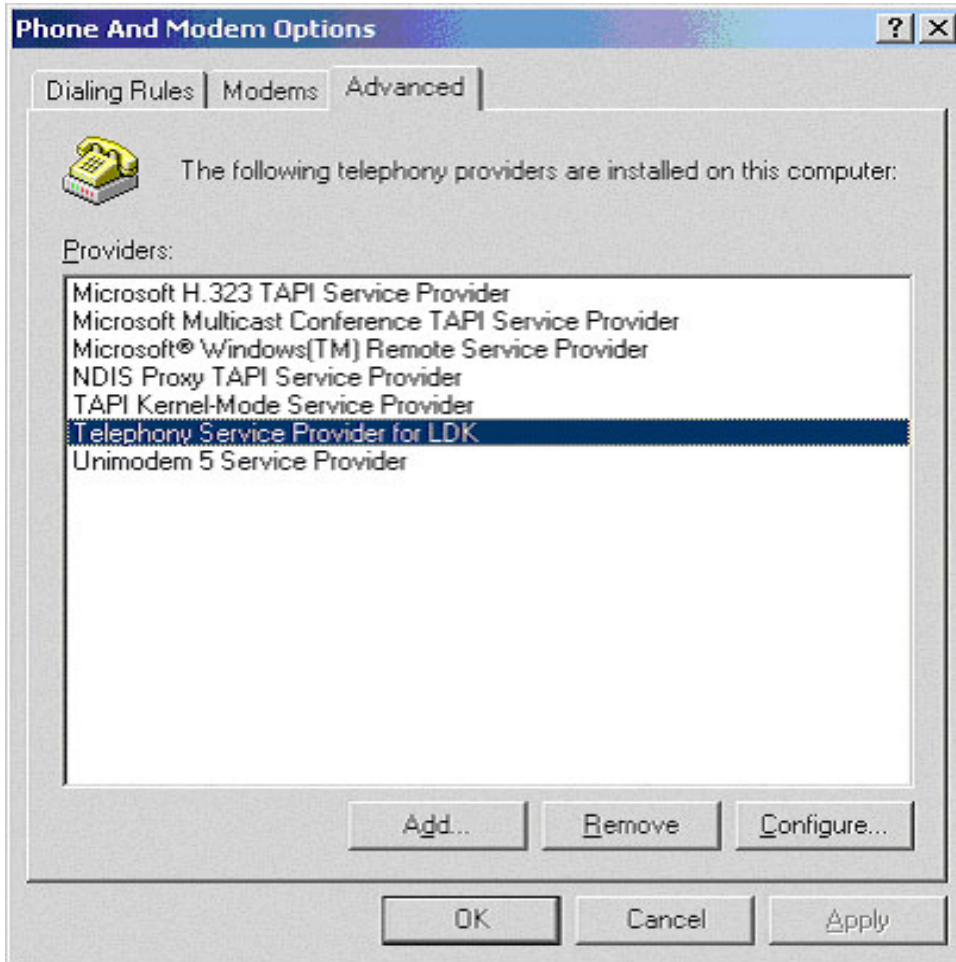

**** Important Note**

- 1) LDK TSP Install guide should be referred when you install TSP on your PC

In this dialog, you should set

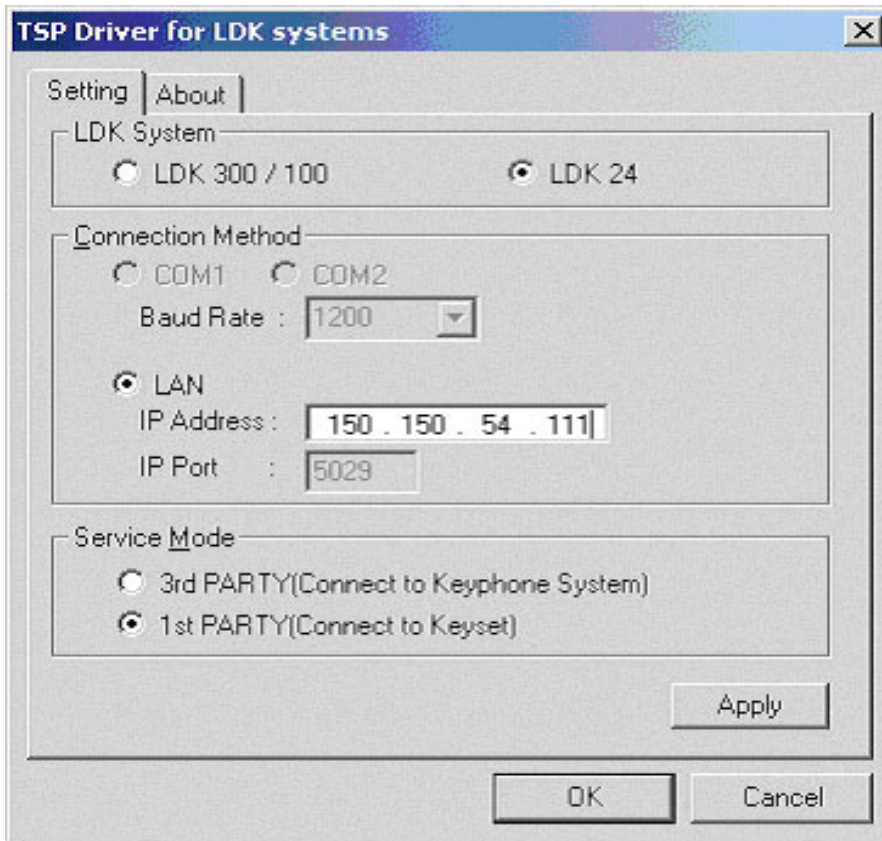

In above dialog, select LDK system(LDK SYSTEM), service mode(1st, 3rd).

IP Address is the IP of LDK SYSTEM

After setting, click [Apply] or [OK] button. Setup is complete.

Once more, after changing some value, you should **restart computer**

Installing2 (DAO)

Remark: DAO Set up program should be run by user

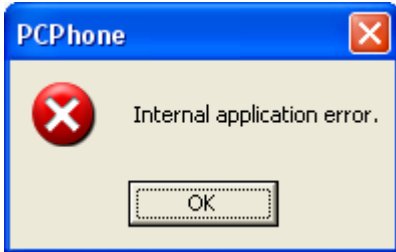

If you meet the error message "Internal application error" when you start ez Phone, install 'Dao35Redist.exe'.

"Dao35Redist.exe" installation file is existed in ez Phone installation folder.

Do not cancel this procedure. This DAO is for ez Phone database control.

Notes: **ez Phone Phase II (2.0A_)** is always installed with follow windows.

ez Phone Phase III(3.0A_) is installed without follow windows.

But if above error is occurred, install 'Dao35Redits.exe'

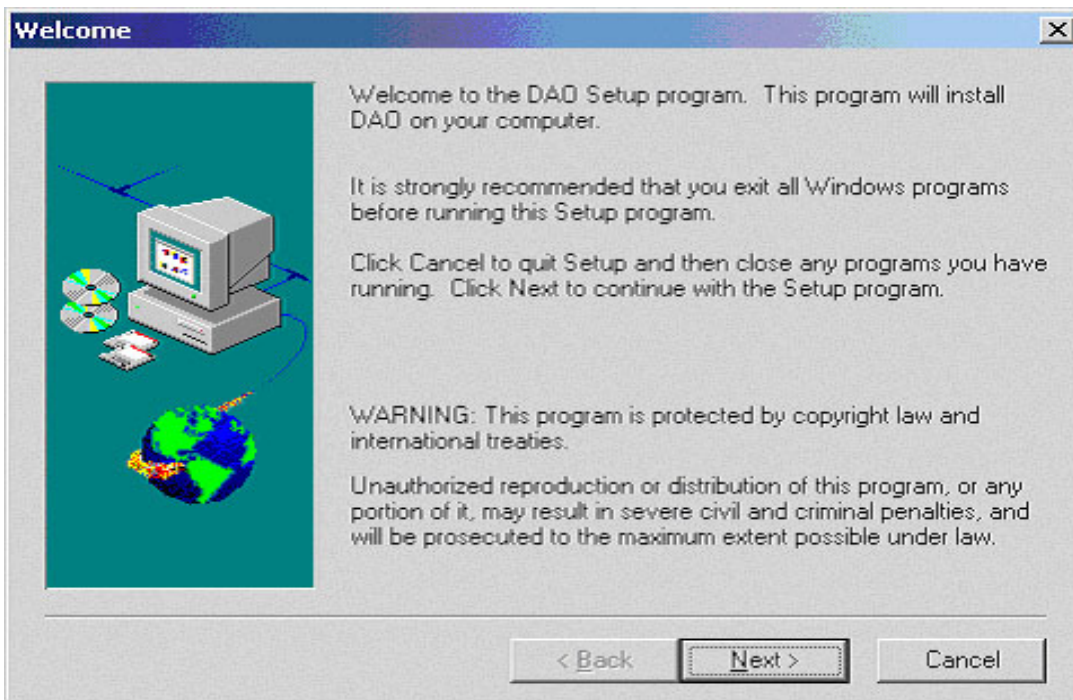

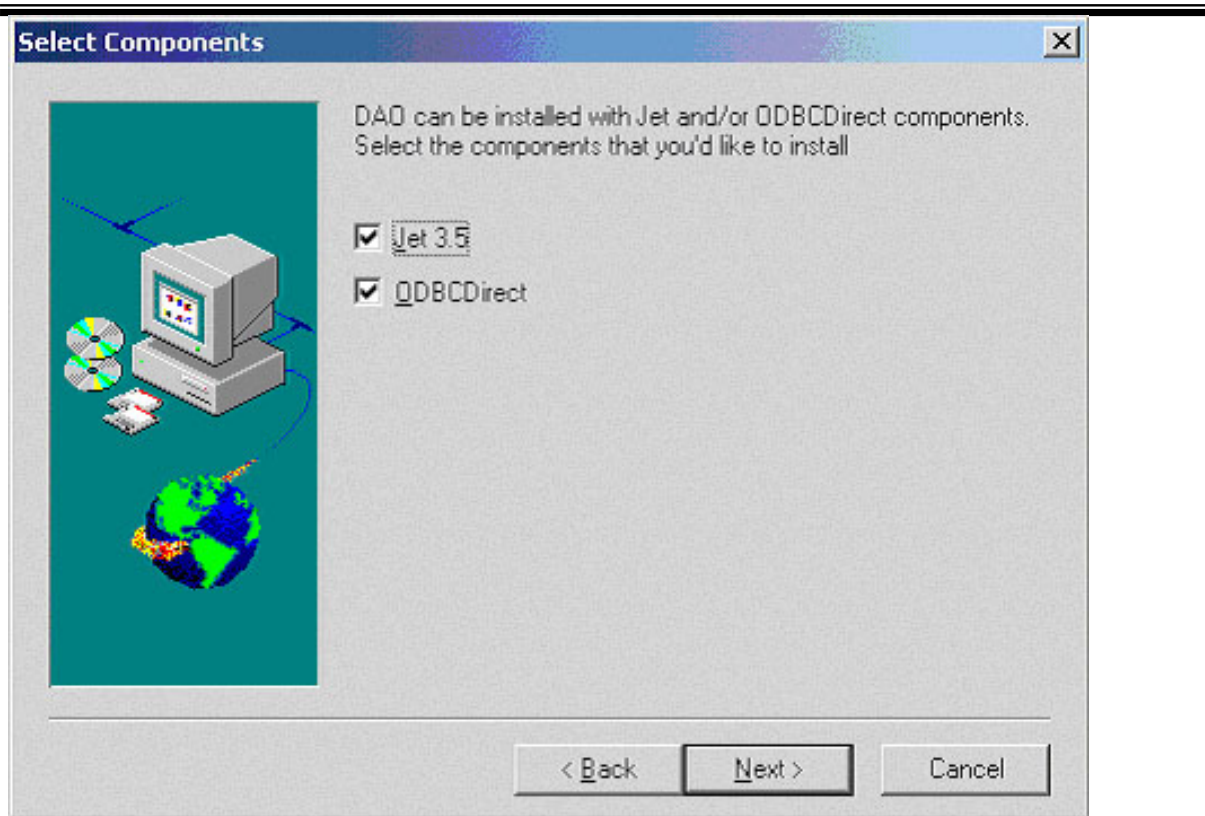

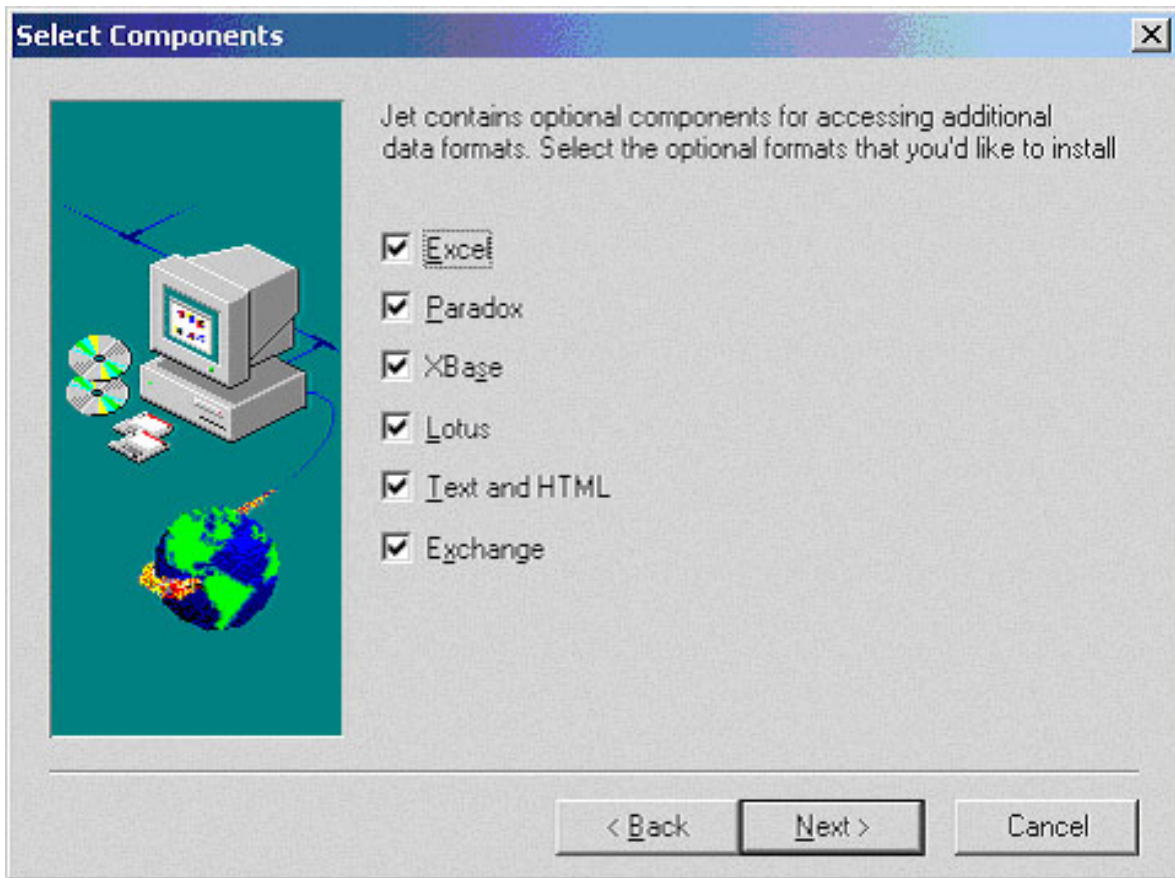

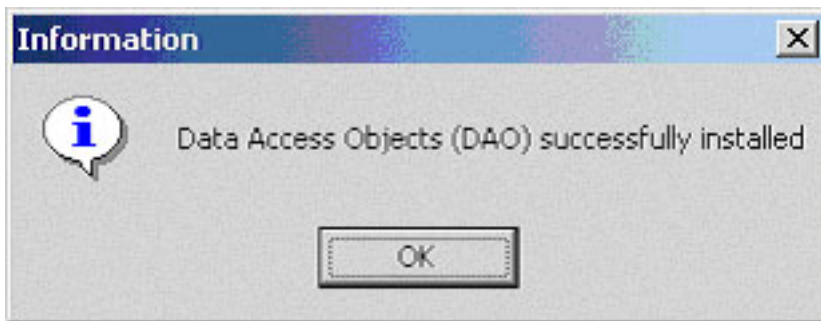
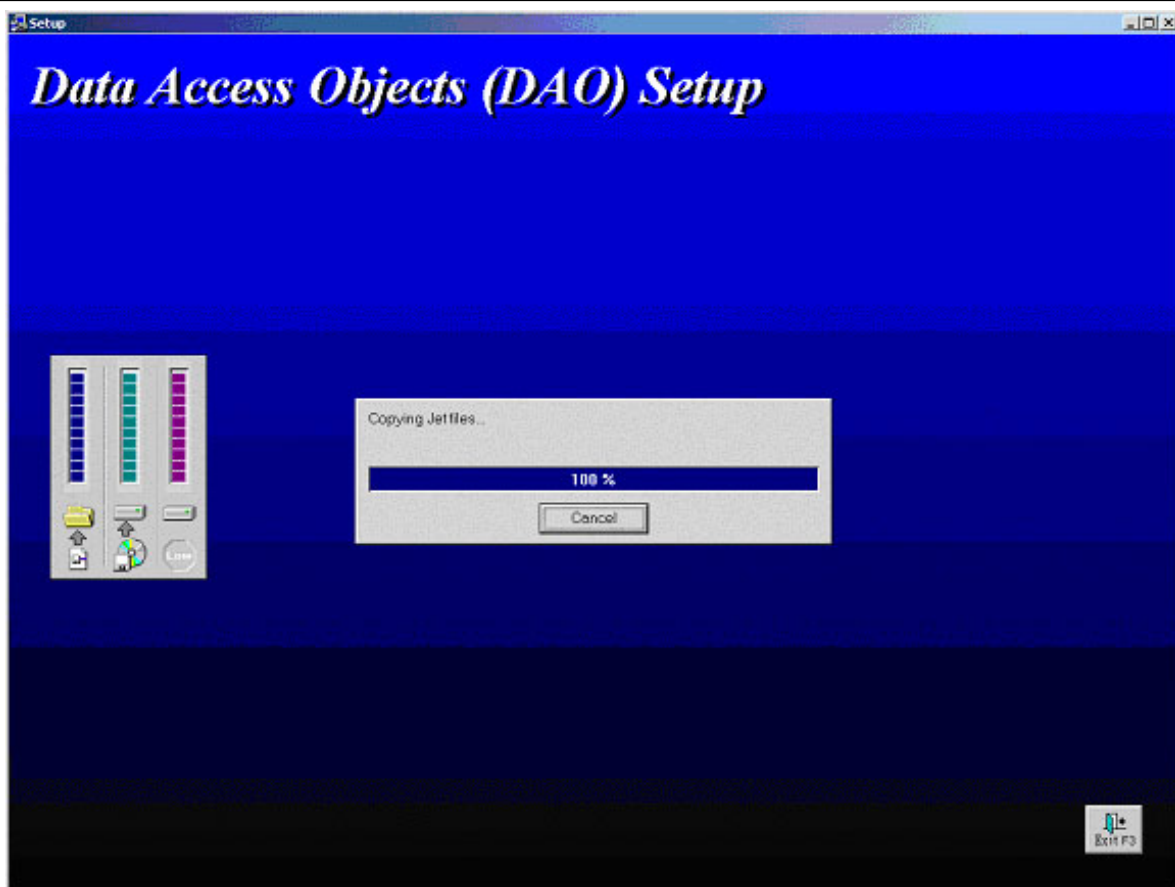

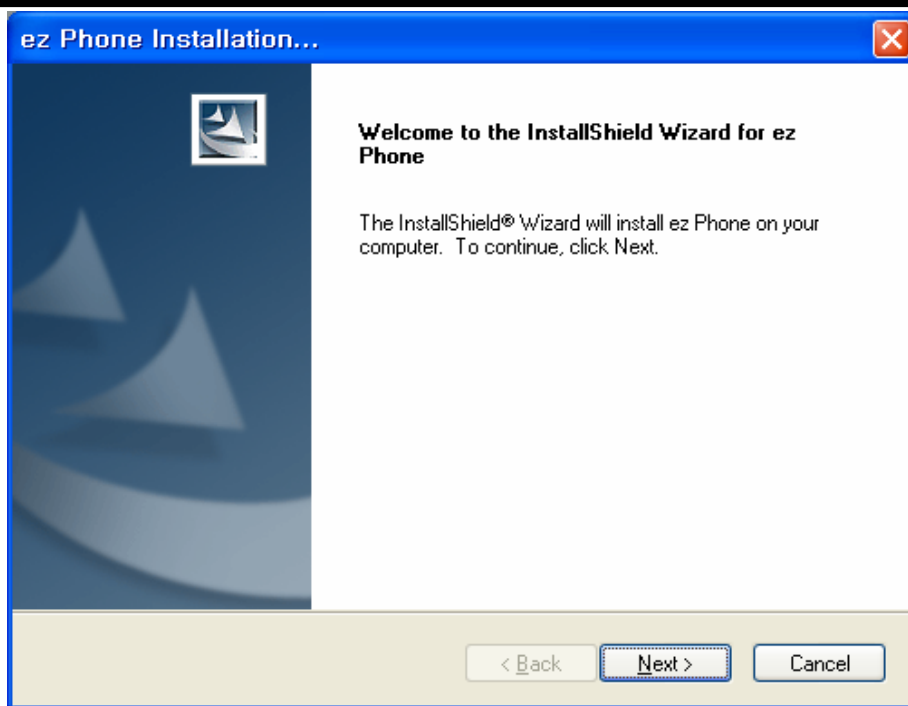

Starting 'ez Phone' Installation.

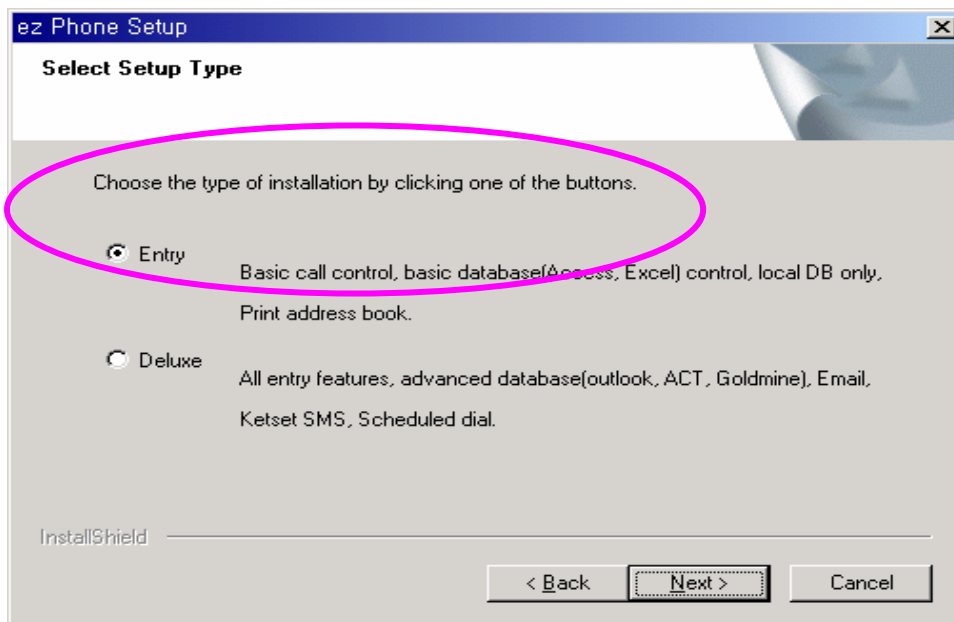

In above dialog, select 'ez Phone' Type(Entry or Deluxe)

For Entry (Basic Call Control, Own Address Book)

For Deluxe (All Entry's Feature and Email, Outlook Contacts, Gold Mine, ACT DB , Filtering and so on.

* For more detail function, please refer to **Table 1**.

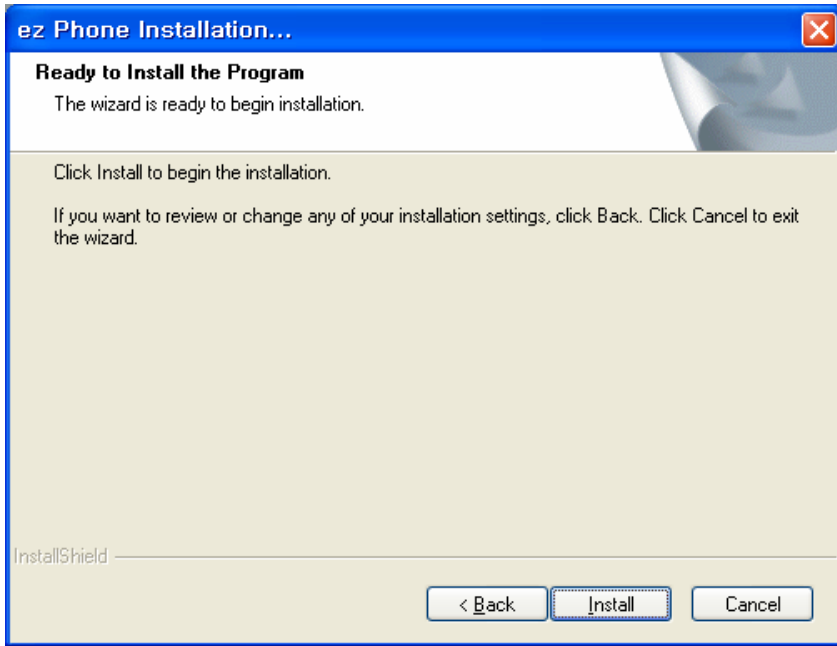

Start [Install] button

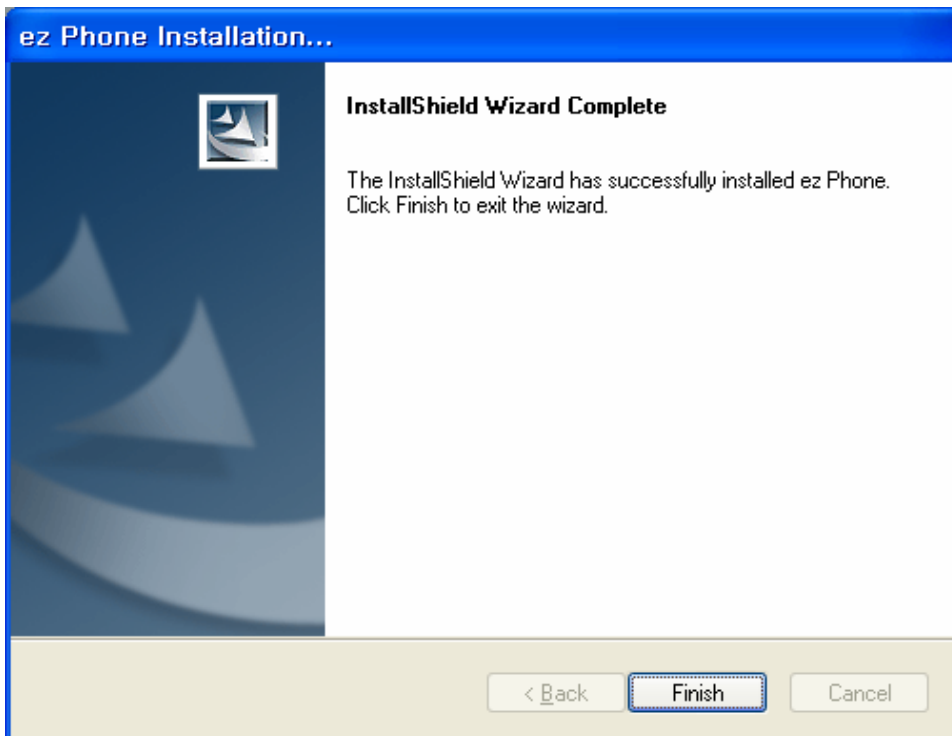

'ez Phone' Setup Complete

**** Note (This is only for LDK – 24 1st Party)**

- Before you run the 'ez Phone' Program, you must check LDK SYSTEM Web Admin.
- The below screen is for Station CTI Setting of LDK SYSTEM. (Circle 1) : PGM 125
- The IP address of your PC should be set into input box (Circle 2) beside station logical number (Circle 3)
- Then everything's done for serve.

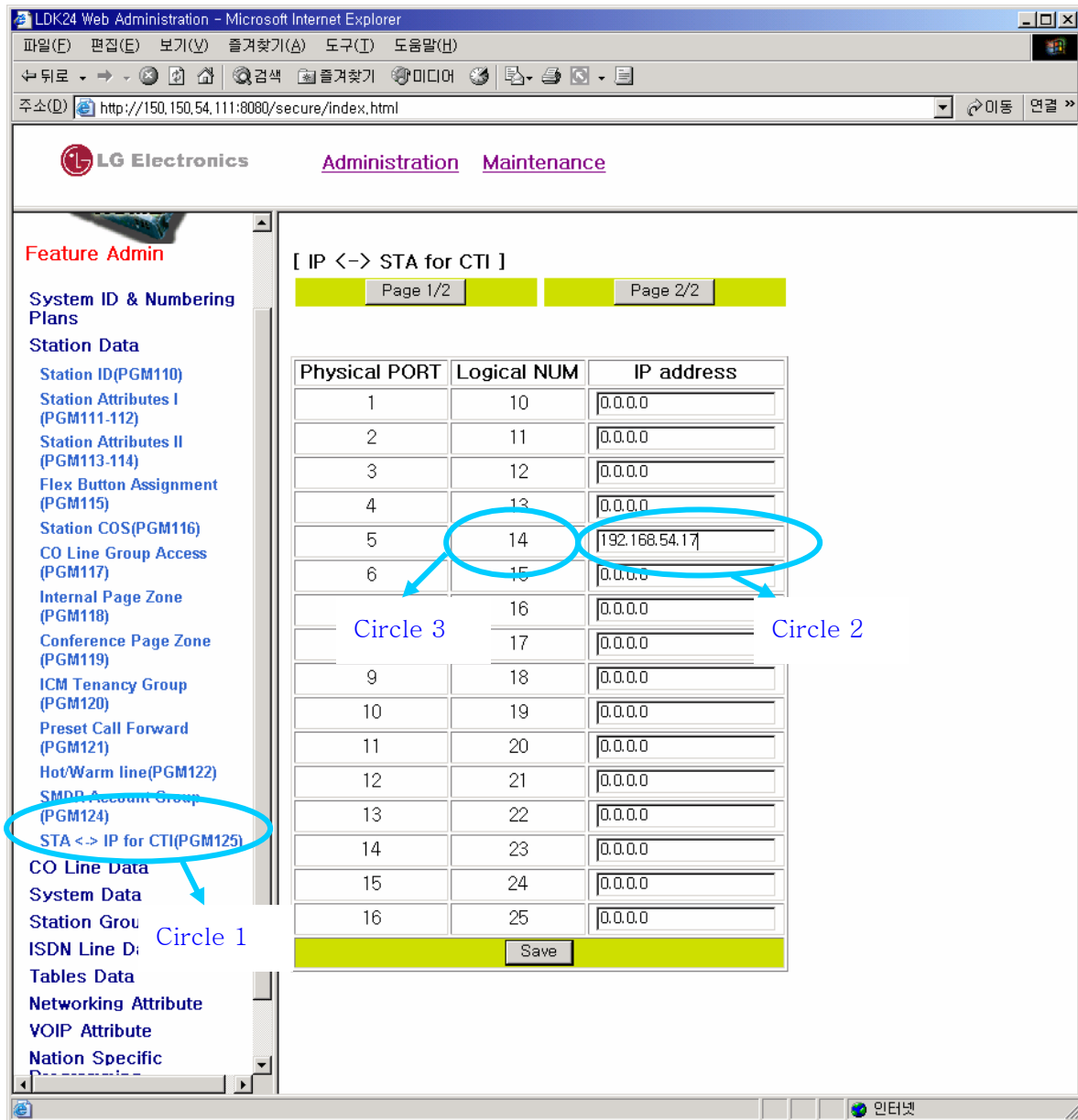

Circle 1: STA <-> IP for CTM(PGM 125)

Circle 2: ez Phone User's IP Address

Circle 3: Station Logical Number

(Ex. Station 14 ez Phone user's IP Address is 192.168.54.17)

USER FEATURE DESCRIPTION

In this part, a main window, 6 sub windows and menu will be described. It's an initial display shown below. A user doesn't need to select his station number to register into the program but LDK SYSTEM – 'ez Phone' automatically select a correct line that assigned to your Desktop PC.

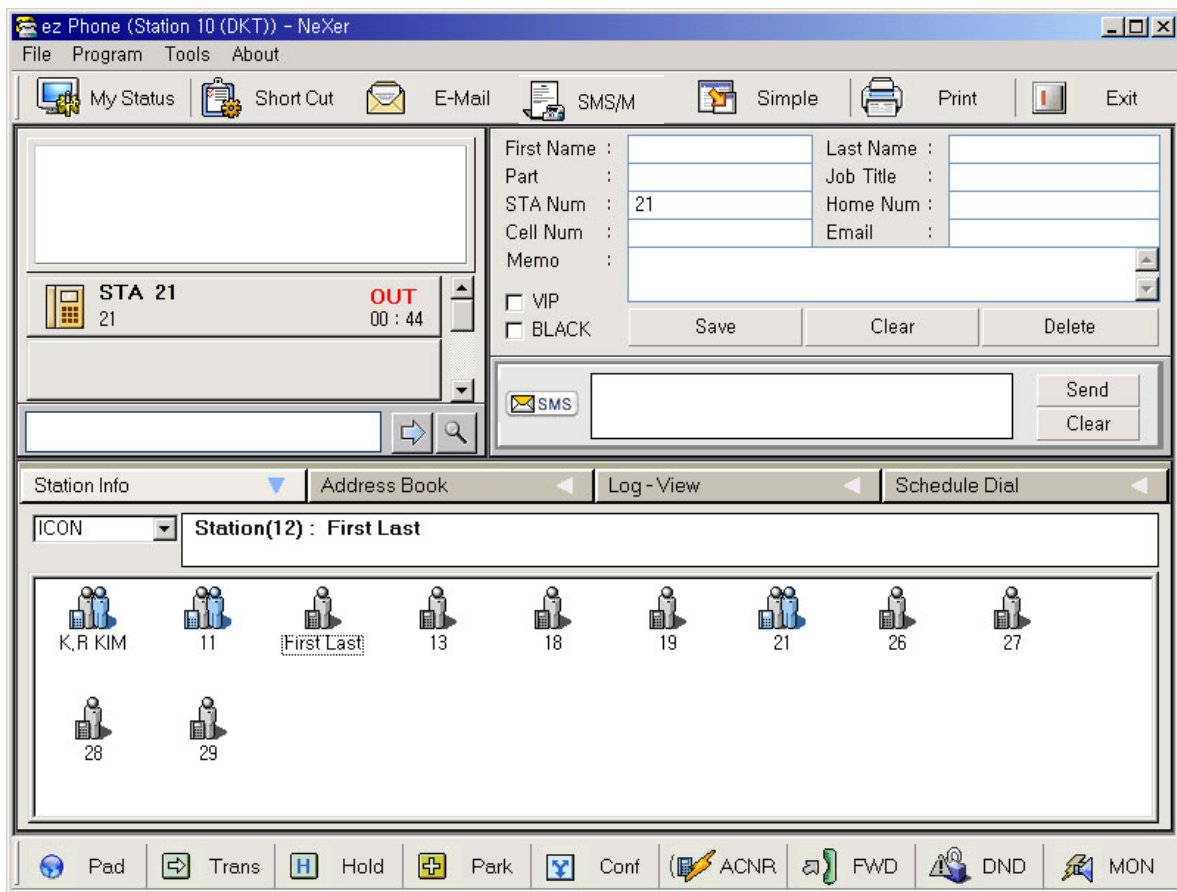

** Note: For 800x600, the right window(Date/Time, Own memo) can not be shown and be used
The right window is just extra window for the design.

***1st party except LDK –24(NeXer) has no information for other station and no operation related with station information window.**

There are two types of ez Phone version. The limited functionality for Entry version is followed below.

Entry Version:

Functionality:

- New Database Creation (Access, Excel)
- Call control(make call, hold call, park/unpark, transfer)
- Import DB (Access, Excel)
- Export DB (Access, Excel)
- Print Address book
- Forward (Internal, Off-net, VMIB)
- Always on top
- All features for Outlook are not available.

Deluxe Version:

Functionality:

- **All Features of Entry Version**
 - Import DB (outlook)
 - Export DB (outlook)
 - VMIB control(Msgwait, OutMessage, Paging Message) – Notify the number of VMIB Msg and MsgWait.
 - Flex button assignment.
 - ACNR
 - EMAIL
 - All features for Outlook are available. (Outlook Contact)
 - Differential ring by CLI
 - Call Filtering: VIP/Black List by DND/FWD/Ring
 - Scheduled Dial
 - KeySet SMS
-

1. Main Window

1.1 Menu

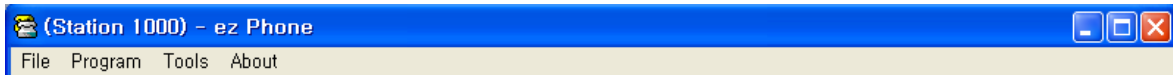

◆ File

- | | |
|---------------------|--|
| A. New DB | → Create New DB |
| i. MS ACCESS. (MDB) | → Make new MDB file |
| ii. MS EXCEL. (XLS) | → Make new XLS file |
| B. Import DB | → Import DB to Address Book |
| i. Outlook. | → From Outlook Contacts |
| ii. Gold Mine | → From Gold Mind Contacts |
| iii. ACT! | → From ACT! Contacts |
| iv. ACCESS. | → From MDB file what you create |
| v. EXCEL. | → From XLS file what you create |
| C. Export DB | → Export DB from Address Book |
| i. Outlook. | → To Outlook Contacts |
| ii. Gold Mine | → To Gold Mind Contacts |
| iii. ACT! | → To ACT! Contacts |
| iv. ACCESS. | → To MDB file with Creating New DB |
| v. EXCEL. | → To XLS file with Creating New DB |
| D. Print | → Print Address Book |
| E. Print Setup | → Print Setup as usual |
| F. Exit | → Exit Program and Save what you have done |

◆ Program

- | | |
|---------------------------|---|
| A. TSP-Setting | → TAPI Drive Setting |
| B. Language | → Change Language |
| C. Forward | → Show Forward dialog |
| D. VMIB Control | → Show VMIB Control dialog to play or delete. |
| E. Flex Button Assignment | → You Can assign a new attribute to each flex.button. |
| F. Received Keypad SMS | → Show a received message for other station |
| G. My Station Program | → Set Your Own Keypad Attributes |
| H. Conference Room | → Phase III only: Make/Delete Conference room |

◆ **Tools**

- A. Outlook Launch → Simply Launch Outlook program.
→ **Phase II Only**
- B. Short Cut Display → Show you import hot key with Dialog
- C. Customize
- D. Option → Check what you want.
- E. Always on top
- F. Send SMS to Mobile → Send SMS to Mobile
→ **Phase III Only**
- G. Key Mapping → Assign HOT Key
→ **Phase III Only**

◆ **About**

- A. About 'ez Phone'

1.2 Top Toolbar



*** My Status (For Mouse Operation Partially)**

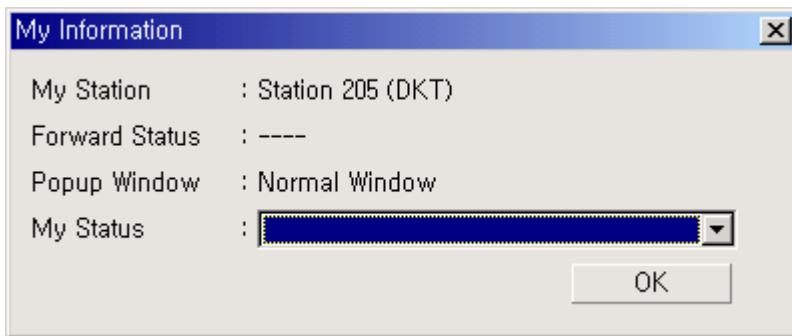

- A. My Station Information (Show your station)
- B. Forward Condition (If you forward you station, the information will be displayed)
- C. Popup Window Type (Main Popup, Normal Popup, Simple Popup)
(Display kind of popup window, you choose a kind in option window)
- D. My Status (Show My Status to another Station when any Key Set SMS arrived)
(Directly send my status to the station which sent me 'key set sms' when I am absent.)

✓ **Short Cut (For Short Cut Operation with Tab)**

→ Show you Short Cut

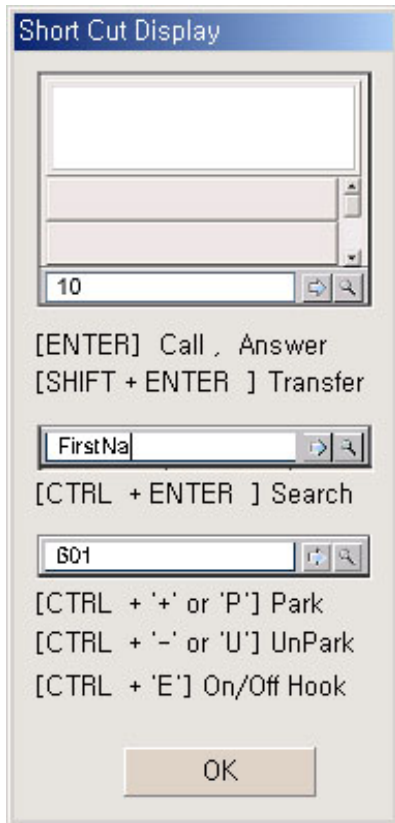

- A. [Enter]
 - If there is no call → Make Call
 - If there is a incoming call → Answer
 -
- B. [Shift + Enter]
 - If there is incoming call → Redirect Transfer
 - If there is a connected call → Normal Transfer
- C. [Ctrl + Enter]
 - Search all matched contacts that you have
- D. [Ctrl + '+' or 'P']
 - Parking Call to "Parking Place Number"
- E. [Ctrl + '-' or 'U']
 - Unparking Call from "Park Place Number"
- F. [Ctrl + 'E'] // End Call with Dial tone
 - Press Monitor Button
 - On/Off Hook (ONLY for DKT)
- G. [Ctrl + 'H'] Hold Call

* Note1: The window focus should be in the edit box to use short cut key. About some short cut, the focus is not necessary. Eg) [Ctrl + '+' or 'P'], [Ctrl + '-' or 'U'], [Ctrl + 'H'] Hold Call

* Note 2: If you use note book, ctrl + '+' and ctrl + '-' is not valid.

In this case, you should have to use ctrl + 'P' and ctrl + 'U'

* Note 3: Ctrl + E(Off-hook, On-hook) is not valid for SLT and DECT(MP V3 DECT Mon button is supported!) But Ctrl + E means "Complete Transfer" for SLT and DECT

✓ **New DB or Export DB from or to Access(MDB)**

- 1. Keep office 97(access 97(MDB)) format; new database which created by menu 'New DB'
- 2. You can edit, add or delete the new file record with database engine such as access 97(office 97).
- 3. If you don't change access 97(MDB) format, you can also edit, add or delete the new file records with office 2000(Access 2000).
- 4. About excel, all office versions are allowed to edit, add or delete the new file records.
- 5. Please use the menu 'New DB', if you want to create new file.

✓ **Email (For Mouse Operation Partially)**

→ You can send an email to other with drag & drop method or just click list.

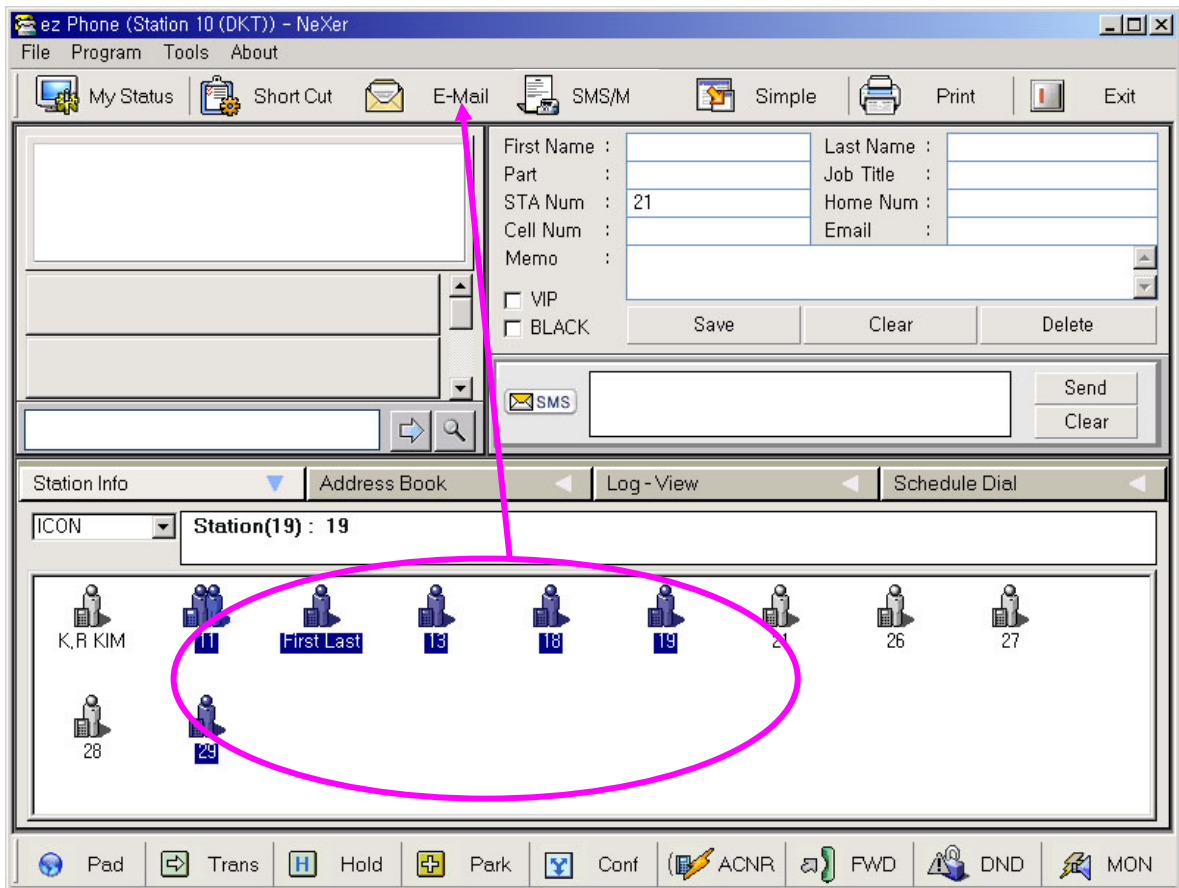

(Send email by drag&drop)

✓ **SMS OVER GSM (For Mouse Operation Partially)**

→ Send SMS Message Over GSM

→ SMS Dialog will be shown.

✓ **Simple (For Mouse Operation Partially)**

→ Make main window to simple window and also recover main window from simple window.

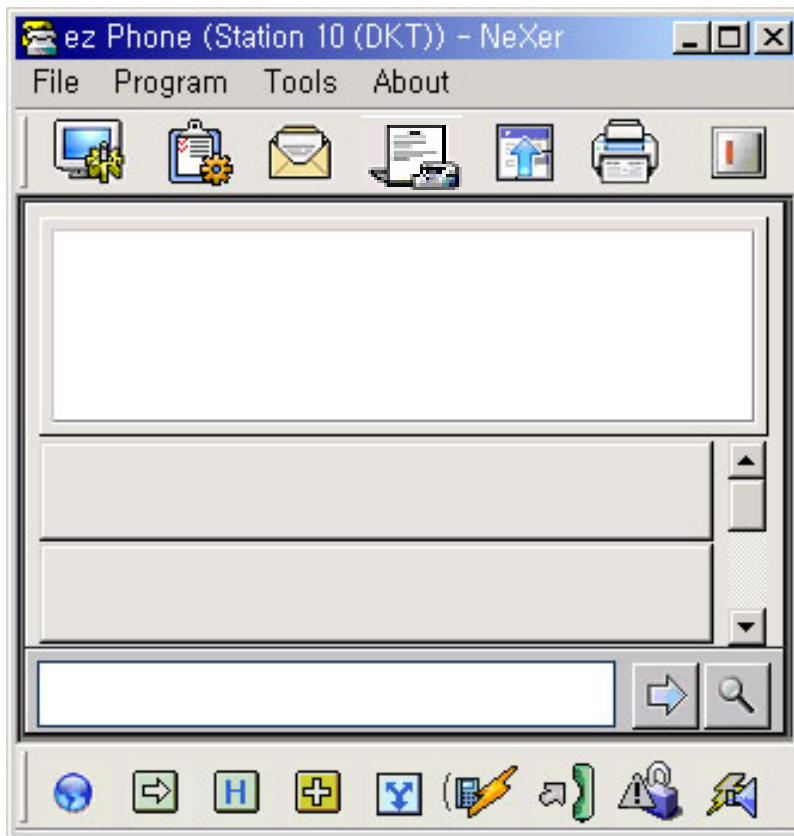

✓ **Print (For Mouse Operation Partially)**

→ Print all of Address Book list

✓ **Exit (For Mouse Operation Partially)**

→ Exit Program and Save what you have done

1.3 Bottom Toolbar



✓ **Pad (For Mouse Operation Partially)**

- You can send a dial button press tone when you have a connected call
- Just insert digit to make call or transfer call.

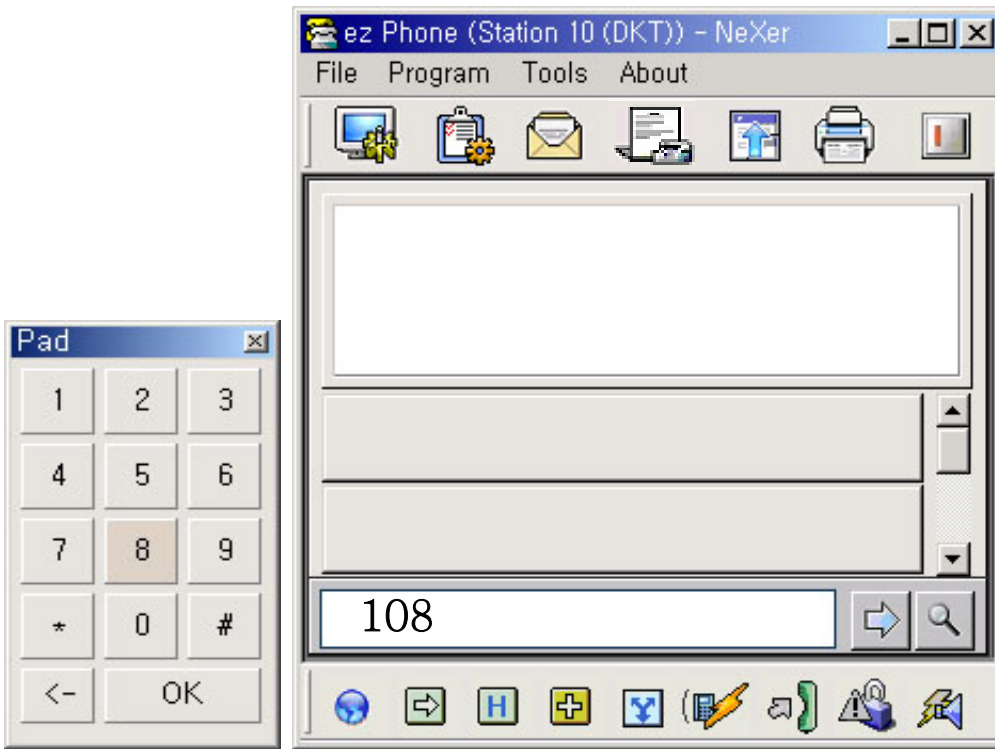

✓ **Transfer (For Mouse Operation Partially)**

- Just click to set transferred target in station info window or address book window with mouse then press this button or press just 'T'.
- Transfer operation will automatically dial that target clicked.
- Show you detail operation next.

✓ **Hold (For Mouse Operation Partially)**

- Hold a connected call if you have.
- For unhold, you click the button which has a holding call in call queue window.

✓ **Park (For Mouse Operation Partially)**

- Park a connected call if you have.
- You must set a Parking Place Address First then Press this.
- Use 'Key pad' or just type Address (ex 601) into Edit Box below.



(Edit Box)

✓ **Conference (For Mouse Operation Partially)**

- Show Conference Dialog.
- You can do conference call with selecting by previous mouse selection.
- Then you can dial other party number.
- If other party answers, then you press add conference button to join it into conference
- If other party does not answer or the line is busy, you should hang up these calls for returning a initial condition. There is button for hanging up.
- If some unexpected error happens, you click the button for recovering error button.

✓ **ACNR (For Mouse Operation Partially)**

- Auto redial when you have external outgoing call or external busy call.
 - This is not redial button. This is ACNR button.
 - If you press this button, the call is try to make call automatically several time administrated in system.
 - When ACNR is activated, clicking this button means to deactivate ACNR
-

✓ **Forward Dialog (For Mouse Operation Partially)**

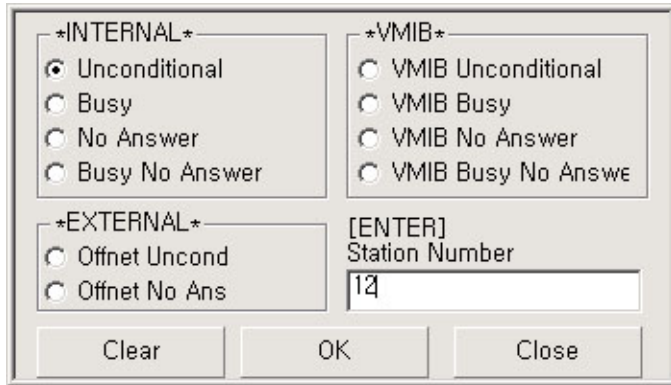

→ 4 Types Internal FWD

→ 2 Types External FWD

→ 4 Types VMIB FWD

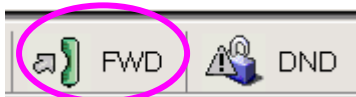

→ Note your Forward Status by Color bitmap when your station was forwarded.

*Note : If your station is forwarded before running ez Phone. Ez Phone will not have the forward information.

If you want ez Phone have the forward information, you clear forward and set forward again.

✓ **DND Operation (For Mouse Operation Partially)**

- Notify the Status by too kind of bitmap.
- Change the Status by pressing this tool button
- Toggle key

-- DND ON



-- DND OFF



✓ **Monitor Button (For Mouse Operation Partially)**

- Notify the Status by too kind of bitmap. (3 Party Only)
- Change the Status by pressing this tool button
- Toggle key

1.4 Call Window

- Display information of call
- Make Call
- Transfer

Redirect(Blind) Transfer. (Without answering an incoming call)

Normal Transfer. (When there is a connected call)

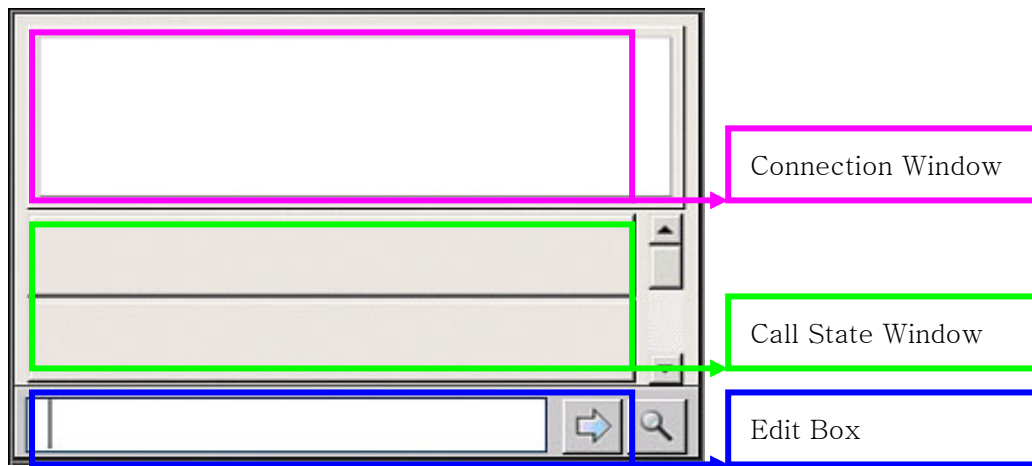

■ New incoming call arrived

- Display information to 'Call State Window'

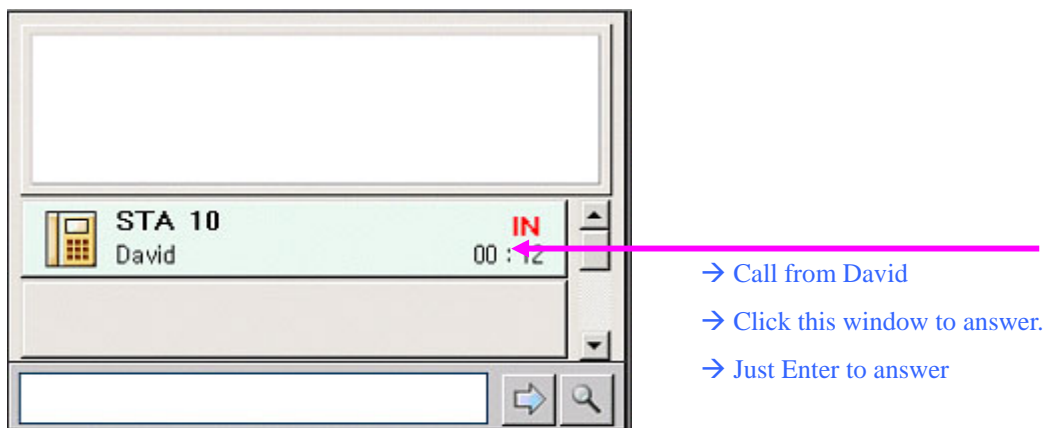

(STATE 1) Incoming Call

*** STATE 1 → Click or Enter (Connected)**

- Display information to 'Connection window'

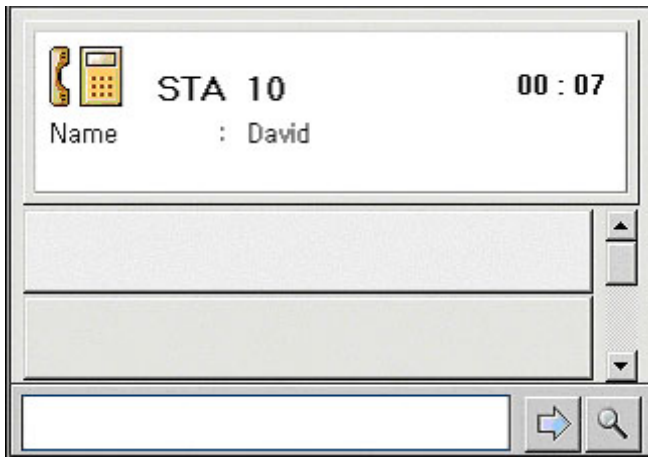

(STATE 1.1) Connected

* **STATE 1.1** → Set Target first and Press [Shift + Enter] or Click Transfer Button on the bottom tool bar (Normal Transfer)

→ Hold and make call

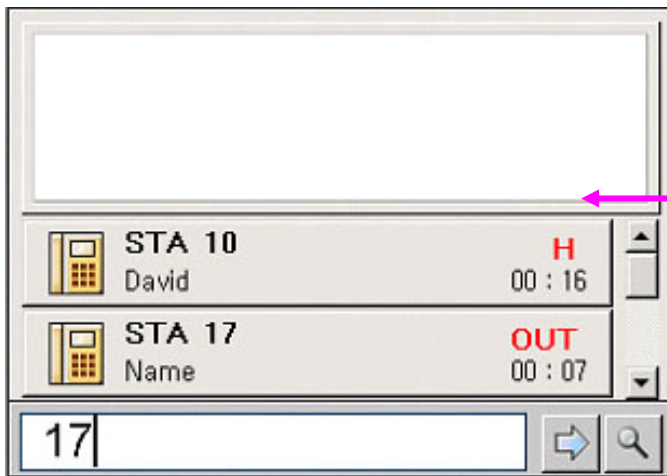

- 1. Connected Call is on Hold
- 2. Make Call with transfer Target

(STATE 1.1.1) Normal Transfer

***STATE 1.1.1** → On Hook or Press Mon or [Ctrl + E]

→ Transfer Completed.

***STATE 1** → Set Target first and Press [Shift + Enter] or Click Transfer Button on the bottom tool bar (Redirect Transfer)

→ Transfer completed without answering the incoming call.

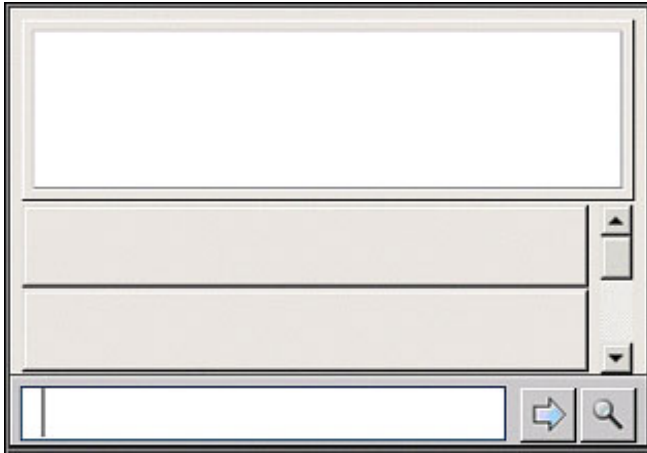

* **STATE 1.1** → Click Hold Button on the bottom tool bar
→ Hold the connected call.

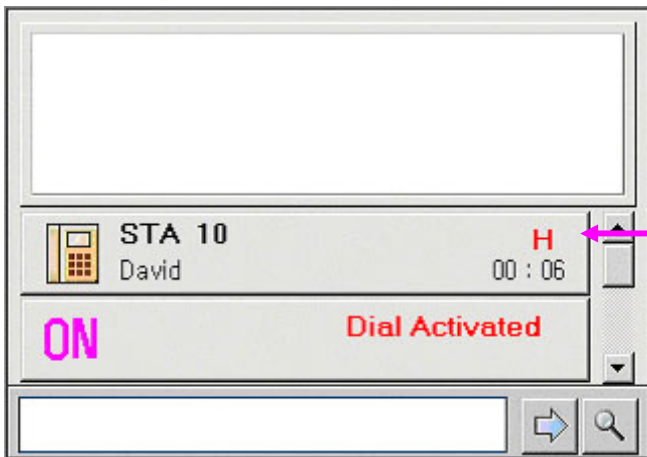

(STATE 1.1.2) Hold

* **STATE 1.1.2** → Click Call State window that has a hold call
→ re-connection call → **STATE 1.1**



■ **Make New Call**

→ Set target with inserting number into Edit box or selecting target by mouse click → [ENTER] or double click make **New Outgoing Call**.

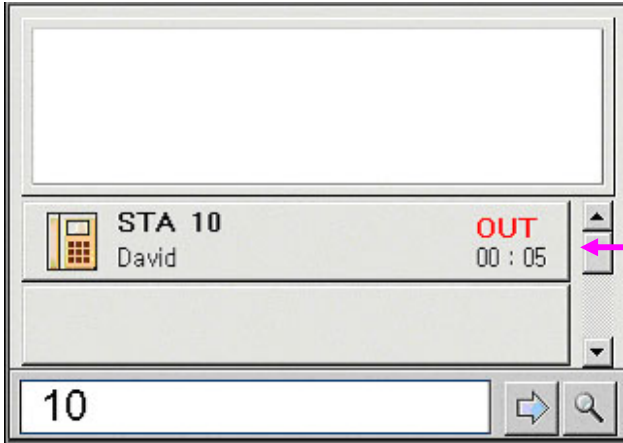

STATE 2 (Outgoing Call)

* **STATE 2** → Click Call State window that has an Outgoing call
→ **Outgoing Call Drop**



Make Call By Name

** *Can also Transfer by Name*

**** Note 1**

The input number less than 5 characters may be an internal call number by 'ez Phone'. If you want to avoid this, set number like follow example.

→ EX) 0/4512 (In this case, 0 means the loop) → 0 - 4512('ez Phone' Dial This)

**** Note 2(About CO line)**

If input number over than 5 characters may be added with loop automatically

→ EX) 123-456-4666(Input Phone Number) → 0-123-456-4666 ('ez Phone' Dial This)

If you want to use private co line, you should keep the follow format.

→ EX) 1/123-456-4666 (Input Phone Number) → 8801 123-456-4666 ('ez Phone' Dial This)

**** Note 3(About CO line)**

Any phone number in 'ez Phone' should be related with Note 2

→ EX) 123-4567-890(Input Phone Number)→ 0-123-456-4666 ('ez Phone' Dial This)

→ EX) 0-123-4567-890(Input Phone Number)→ 0-0-123-456-4666 ('ez Phone' Dial This)

**** Note 4(if Loop digit is '0')**

0095→ this is short than 5, so ez Phone dial this as internal call, but system call this as co line call(0-095) because the first character is loop.

01004→ this is 5 character string, so ez Phone add 0 and dial 0- 01004.

As example, it is little confused, so you keep format in this kind of short co line call with '/'

■ Search List with partial name or number

→ Set target with inserting Name or Number into Edit box and then Press [CTRL +

ENTER] or click 

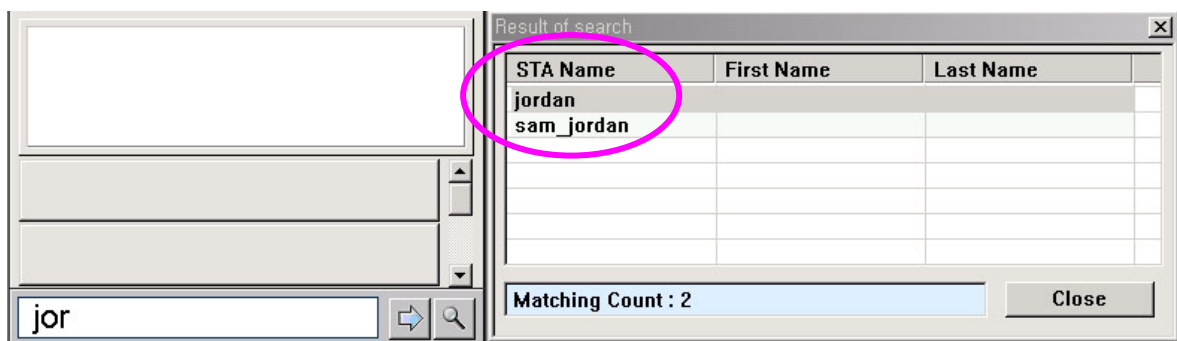

* Key word 'jor'

* List up with matching

If you change selecting row found, the related information will be indicated in station info window or address book window.

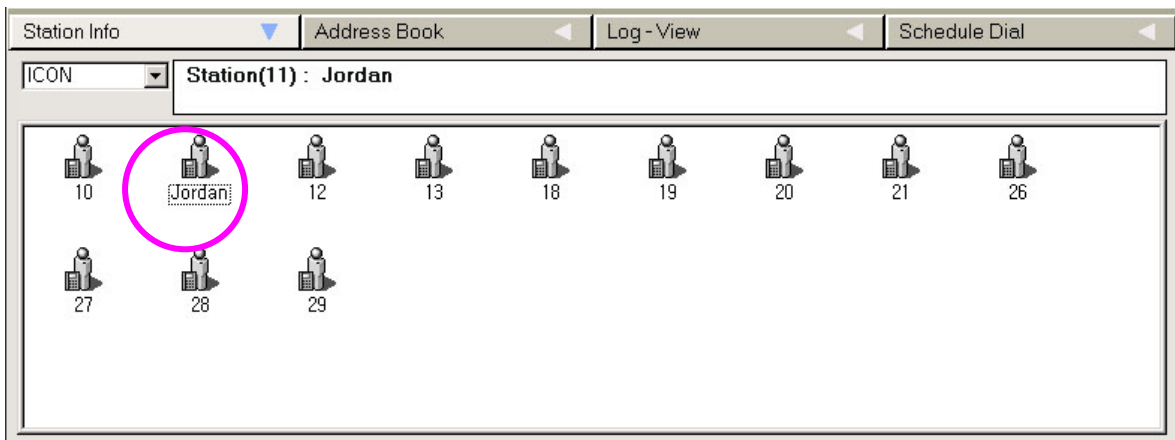

→ This Window indicates matching item what you search.

→ After that, just Enter make call or other operation.

■ **Park or Unpark the connected call**

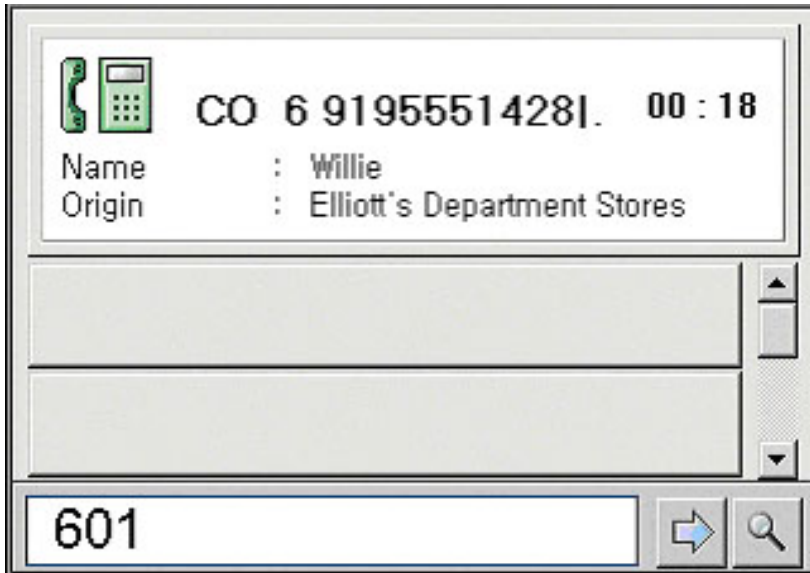

➤ ***PARK**

[Ctrl + '+' or 'P'] or click Park button on the bottom toolbar.
Parking area should be empty to park connected call. (eg.601)

➤ ***UNPARK**

[Ctrl + '-' or 'U']
parked call should be existed in the parking area(eg.601)

Note 1 : If you pc is note book, '+' and '-' is not supported. In this case you have to use 'P' or 'U'.

Note 2 : If your key board is normal, you can use both of them(+,P, -,U

■ Mouse click easy Transfer

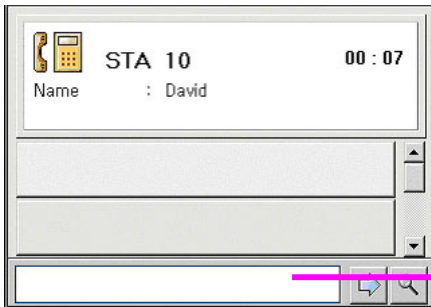

If this edit box is empty.

(Condition 1)

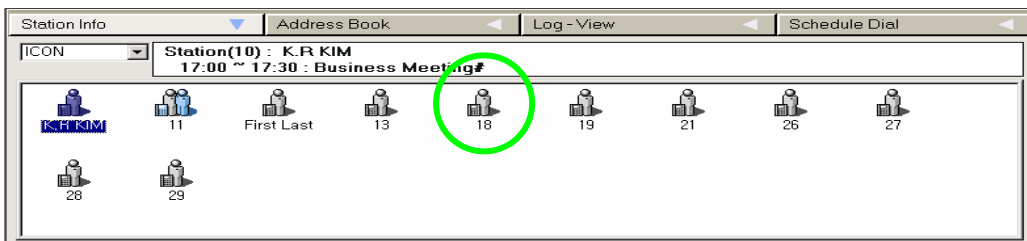

(Station Window) Transfer to other station(ex, Station 18)

(Condition 1-> Click a station icon by mouse) or

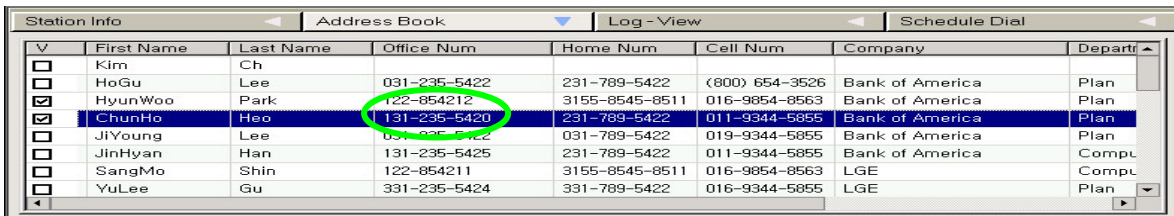

(Address Window) Transfer to off-net co line(ex, 131-235-5420)

(If station window type is 'report', transfer operation is same as address book transfer)

(Condition 1-> Click an address number by mouse)

(Condition 1-> Click -> Press "Trans" button on bottom toolbar)



Tips: Also you can transfer with pressing short key 'T' on station info window or address book window after selecting a phone number or list.

1.5 Information Window

→ Display all information of the connected or ringing call.

→ If calling from you don't have in your address book or Outlook contacts, you can save the information indirectly with using this information window. If the call is for internal call you cannot delete record. Only saving is ok. And for internal station the memo is not valid. It is only for address book

First Name :	<input type="text"/>	Last Name :	<input type="text"/>
Company :	<input type="text"/>	Job Title :	<input type="text"/>
Office Num :	<input type="text"/>	Home Num :	<input type="text"/>
Cell Num :	<input type="text"/>	Email :	<input type="text"/>
Memo :	<input type="text"/>		
<input type="checkbox"/> VIP			
<input type="checkbox"/> BLACK			
Save		Clear	Delete

	<input type="text"/>	Send
		Clear

→ Call From K.R KIM

First Name :	K.R	Last Name :	Kim
Company :	LGE	Job Title :	Eng.
Office Num :	+82 0314504444	Home Num :	+82 0314505555
Cell Num :	+82 0314506666	Email :	<input type="text"/>
Memo :	He is going to visit us in May.		
<input checked="" type="checkbox"/> VIP			
<input type="checkbox"/> BLACK			
Save		Clear	Delete

	<input type="text"/>	Send
		Clear

→ He is a VIP Customer.

1.6 Message Window

(The numbers of character are 21 for 1st party, 48 for 3rd party)

→ Send a short message to Keypad or other ez Phone User or Attd.

→ Display the received short message from other ez Phone User or Attd.



(Keypad Message View)

Usage

- Select Station by mouse.

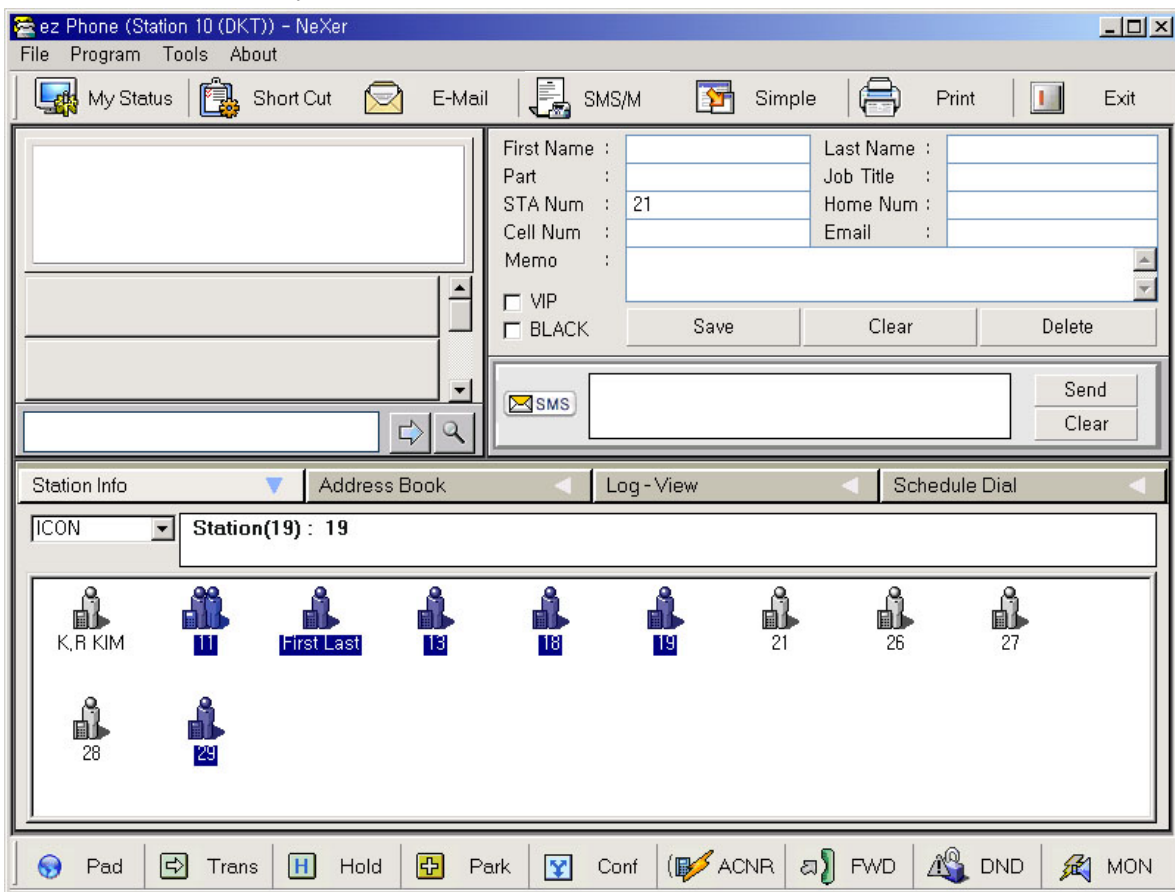

- Type Message



- Press Send button or [CTRL + ENTER]

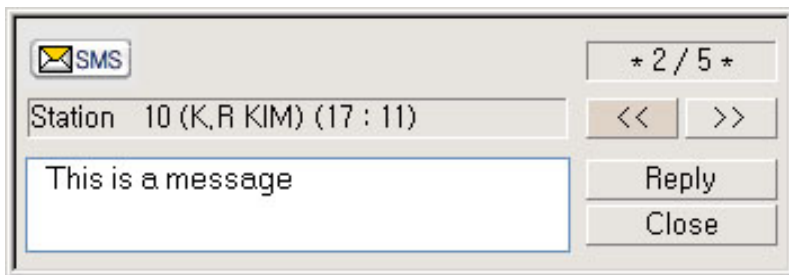

- When you've got Message Form Other Station

1.7 Station Information Window

- ✧ Display Other Station.
- ✧ Monitor Other Station's Status (Busy or Idle)
- ✧ Make Call By Double Click
- ✧ Get schedule from Outlook Program.
- ✧ Set Transfer Target
- ✧ Email & Edit
- ✧ 4 Different types display (Icon, Small Icon, Report, list)

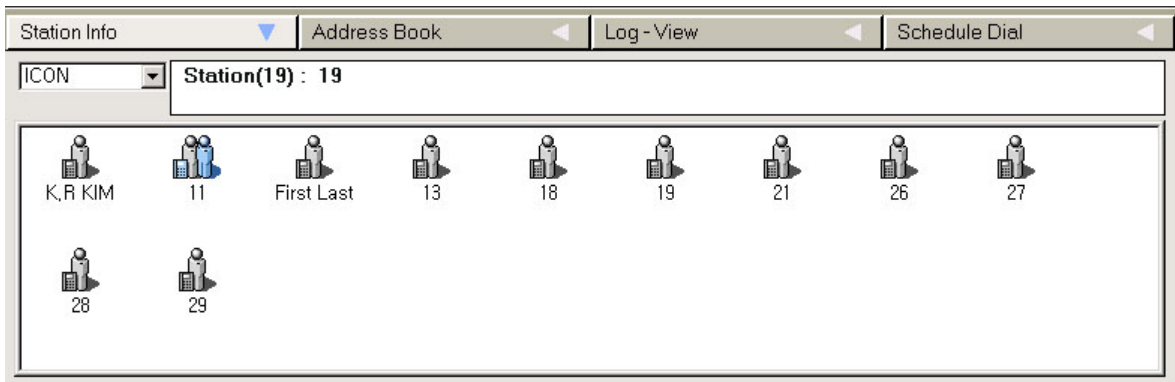

- ◆ LDK 24 1st → Stations are displayed automatically. (A station state is changed automatically.)
- ◆ LDK 100, 300, 600 1st → Stations are not displayed automatically. (A station state is not changed)
- ◆ LDK 100, 300, 600 3rd → Stations are displayed automatically. (A station state is changed automatically)

■ **Get Outlook Schedule. ('Ctrl + S', S)**

Do Not this operation if outlook is not installed. If do, error may be occurred.

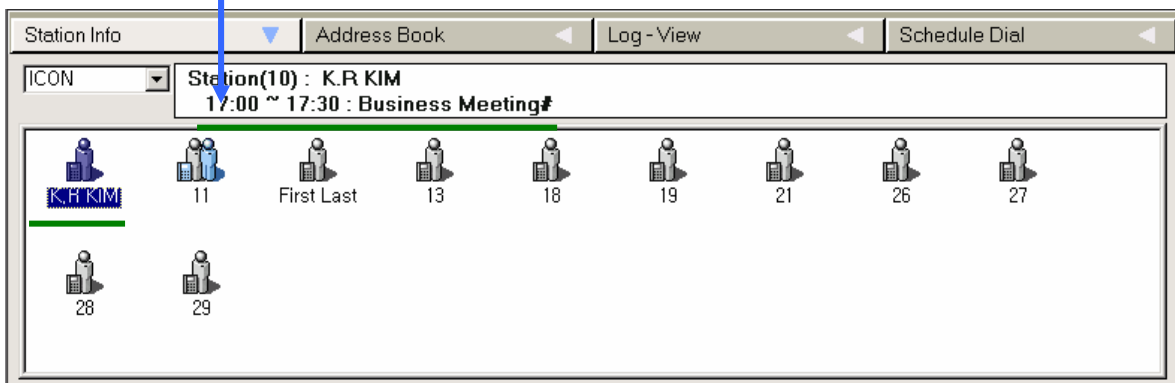
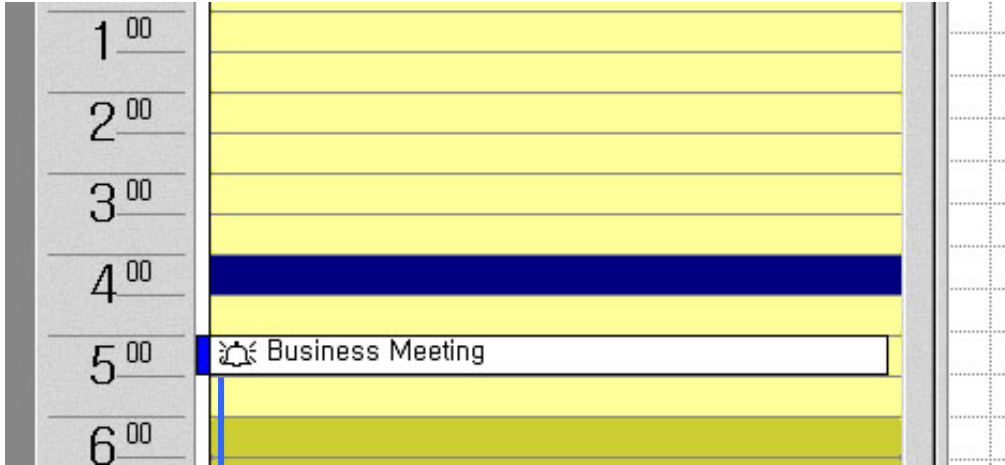

■ **Station Popup window**

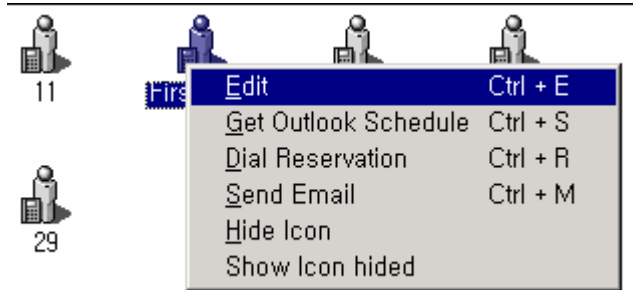

Tips: Without pressing control key, you can use the operation.

Just pressing 'E' with Ctrl +'E' Just pressing 'S' with Ctrl +'S' Just pressing 'M' with Ctrl +'M'

And so on.

■ **Edit Station Information ('Ctrl + E' or 'E')**

- You can edit the station data.
- If station name includes blank(' '), you can not make call with this name. Eg) 'Tel' 'co' → For call this should be 'Telco'
- You can call by name eg) 'K.R' or 'K.R' 'Kim'.

Save&Close		Apply		Close	
STA Name	Hongj				
STA Num	12				
Cell Num	019-9145-2280				
Home Num					
Part	LG S/W				
IP address	0 . 0 . 0 . 0				
E-Mail	Obong2@hanmail.net				
First Name	Kyoung Youl				
Last Name	Kim				

(Editing window)

■ **4 Types of Display**

- Icon Type(Big Icon)
- Report Type (See details)
- Report Type (Useful when there are many stations)
- List Type (Useful when there are many stations)

1.8 Address Book Window (Own DB Address)

- ✓ Registration New DB
- ✓ Edit Existed DB
- ✓ Delete Exited DB
- ✓ Make Call by Click or Enter
- ✓ Send email by Click or Enter
- ✓ Column Size or field can be customized

V	First Name	Last Name	Office Num	Home Num	Cell Num	Company	Depart
<input type="checkbox"/>	Kim	Ch					
<input type="checkbox"/>	HoGu	Lee	031-235-5422	231-789-5422	(800) 654-3526	Bank of America	Plan
<input checked="" type="checkbox"/>	HyunWoo	Park	122-854212	3155-8545-8511	016-9854-8563	Bank of America	Plan
<input checked="" type="checkbox"/>	ChunHo	Heo	131-235-5420	231-789-5422	011-9344-5855	Bank of America	Plan
<input type="checkbox"/>	JiYoung	Lee	031-235-5422	031-789-5422	019-9344-5855	Bank of America	Plan
<input type="checkbox"/>	JinHyan	Han	131-235-5425	231-789-5422	011-9344-5855	Bank of America	Compu
<input type="checkbox"/>	SangMo	Shin	122-854211	3155-8545-8511	016-9854-8563	LGE	Compu
<input type="checkbox"/>	YuLee	Gu	331-235-5424	331-789-5422	016-9344-5855	LGE	Plan

* **Note:** Unreasonable long string for each column may cause some display problem or Database Error.

■ Own contacts DB Display

→ Save and Modify.

Edit Contact - HyunWoo Park

Save&Close
Apply
Clear
Close

First Name	<input type="text" value="HyunWoo"/>	Company	<input type="text" value="Bank of America"/>
Last Name	<input type="text" value="Park"/>	Job Title	<input type="text" value="Programmer"/>
Zip	<input type="text" value="331-541"/>	Office Num	<input type="text" value="122-854212"/>
State	<input type="text" value="GA"/>	Home Num	<input type="text" value="3155-8545-8511"/>
City	<input type="text" value="Norcross"/>	Cell Num	<input type="text" value="016-9854-8563"/>
Address	<input type="text" value="bagie Street"/>	Fax Num	<input type="text" value="(201) 661-8001"/>
Country	<input type="text" value="America"/>	Email	<input type="text" value="smLee@lge.com"/>
<input type="checkbox"/> VIP	Memo		
<input type="checkbox"/> BLACK	<input type="text" value="*** JON *** December 4, 1995 at 8:49am"/>		

■ **Address Popup windows**

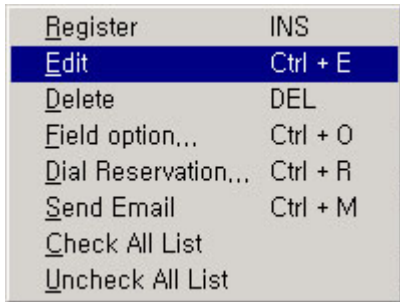

Tips: Without pressing control key, you can use the operation.

Just pressing 'E' with Ctrl +'E' Just pressing 'O' with Ctrl +'O' Just pressing 'R' with Ctrl +'R' And so on

■ **Column Field Option windows**

- ✓ You can hide some field
- ✓ At least one of phone number should be checked.

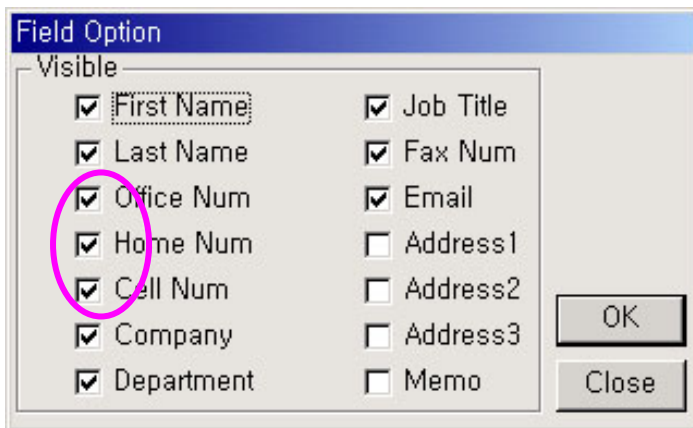

■ **Call Reservation Dialog**

- ✓ You can reserve Phone call.

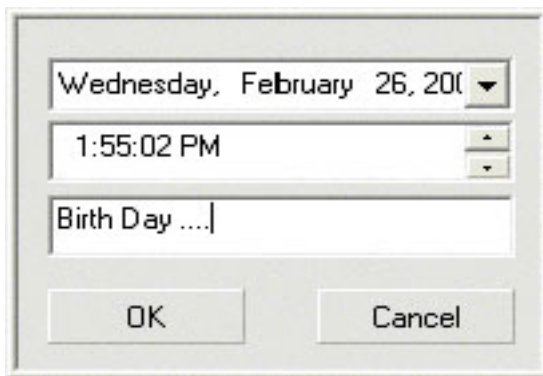

1.9 Log – View

- Call History is listed up
- Delete Exited Log
- Make Call by Click or Enter
- Filtering by In/Out or Internal/External
- Connected/Not Connected
- Record or stop record by Option

Station Info	Address Book	Log - View	Favorite								
Record				Num	Name	Date	Hour	Dur			
<input checked="" type="radio"/> All Log				CO 6 20355510911 I...	Dale	02/26	13 : 37	00 : 00	No	Outgoing	External
<input type="checkbox"/> Incoming				CO 6 20355510911 I...	Dale	02/26	13 : 37	00 : 01	No	Outgoing	External
<input type="checkbox"/> Outgoing				STA 18	Good	02/26	11 : 48	00 : 09	No	Outgoing	Internal
<input type="checkbox"/> Internal				CO 6 91955514281 I...	Willie	02/26	11 : 13	00 : 40	Yes	Outgoing	External
<input type="checkbox"/> External				STA 11	Jordan	02/25	19 : 27	00 : 01	No	Outgoing	Internal
<input type="checkbox"/> Answered				CO 6 133650	UnKnown	02/22	16 : 19	00 : 11	Yes	Outgoing	External
<input type="checkbox"/> No ANS				CO 6 133650	UnKnown	02/22	16 : 18	00 : 13	Yes	Outgoing	External

Filtering by attribute

EX) Stop Log and Filtering by Outgoing.

Station Info	Address Book	Log - View	Favorite								
Stop				Num	Name	Date	Hour	Dur			
<input type="radio"/> All Log				CO 6 20355510911 I...	Dale	02/26	13 : 37	00 : 00	No	Outgoing	External
<input type="checkbox"/> Incoming				CO 6 20355510911 I...	Dale	02/26	13 : 37	00 : 01	No	Outgoing	External
<input checked="" type="checkbox"/> Outgoing				STA 18	Good	02/26	11 : 48	00 : 09	No	Outgoing	Internal
<input type="checkbox"/> Internal				CO 6 91955514281 I...	Willie	02/26	11 : 13	00 : 40	Yes	Outgoing	External
<input type="checkbox"/> External				STA 11	Jordan	02/25	19 : 27	00 : 01	No	Outgoing	Internal
<input type="checkbox"/> Answered				CO 6 133650	UnKnown	02/22	16 : 19	00 : 11	Yes	Outgoing	External
<input type="checkbox"/> No ANS				CO 6 133650	UnKnown	02/22	16 : 18	00 : 13	Yes	Outgoing	External

1.10 Favorite (Schedule Dial Window)

- Calls reserved are listed up
- 3 State (Past, Ready, On)
- If On, 'Confirm Pop up' will be shown up
- You can make a call reservation here also
- Insert Data and Press [INS] Key
- Remove Key : Delete one of list that you don't need.
- [Ins] Key(Insert key On Keyboard) for making reservation into the list as short cut.

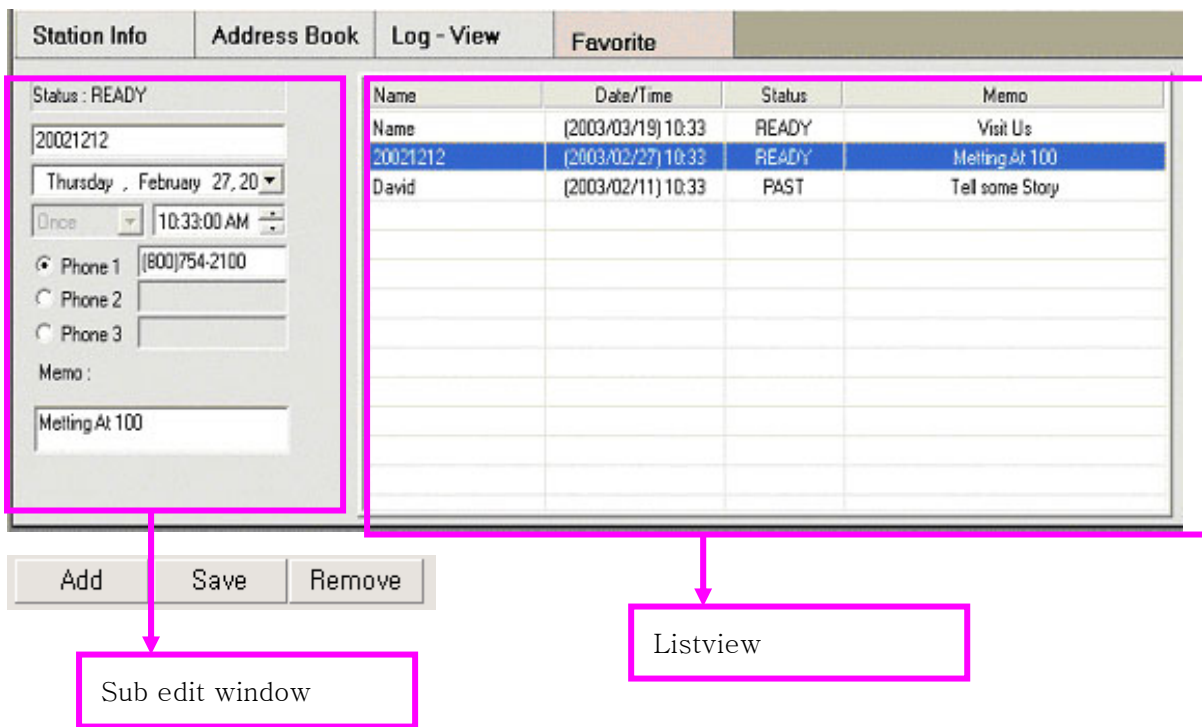

Add (Short key→Insert Key on your keyboard)

: Add a new list to Listview.

Save (Short key→Enter Key on your keyboard)

For short key, window focus should be in the sub edit window

: Save a changed value of reserved list in Listview

Remove (Short key→Delete Key on your keyboard)

For short key, window focus should be in Listview

: Remove on of list reserved.

■ Call Reservation Call Pop Up Window.

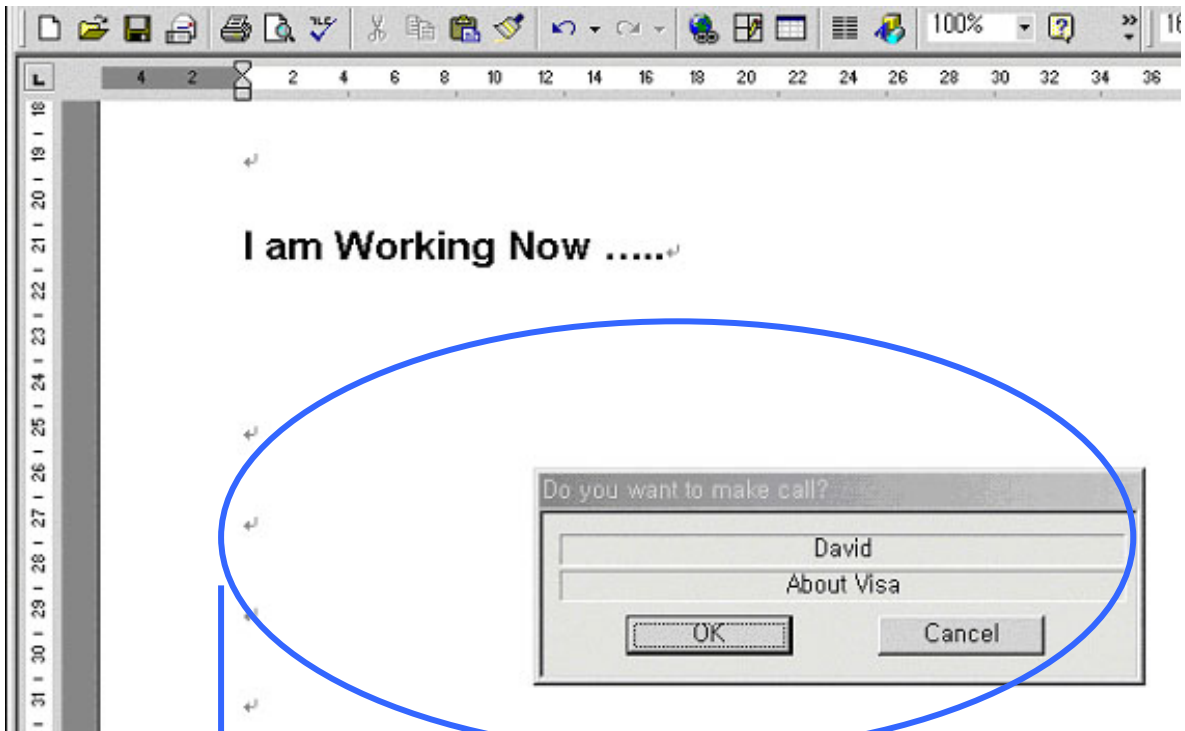

1. Notify First with Dialog
2. Press Ok → Make reserved Call
3. Press Cancel → Cancel reserved Call.

2. Etc Window

2.1 Flex Button Assignment Dialog

- ✓ Set flex button attribute to each button.
- ✓ Easy Assignment.
- ✓ ex) If you press F01, the assignment will be displayed in detail on right side. If you want change the assignment, select new value on right side window and press ok to save new value.
- **The number of button is fixed as 24. (LDK 24 1st, LDK 100, 300, 600 1st Party)**
- **The number of button is the number of your keyset button number. (LDK 100, 300, 600 3rd Party) (Not supported current version)**

Ex)

1. Press Button that you want to know flex button assignment.
2. You can see flex button assignment on right side of dialog.
3. If you want to change the assignment, select a type with combo box and insert value in edit box. Then press OK to save data to the button really.
4. If you click another without saving, the assignment will not be changed.

Below sample is for “Flex 8 for Station 11”

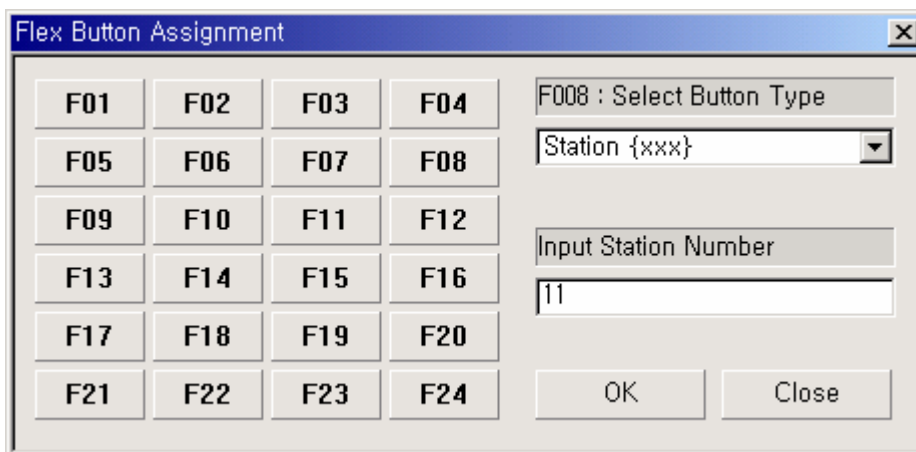

***Note:** Some features will be “empty” or “...” if the feature is not in the list of “select button type”. For Co and Co Group, your station should have permission to change it.

2.2 VMIB Dialog

- Message Play or Record
- Easy management VMIB
- Display the number of VMIB Msg left
- Same as normal window.

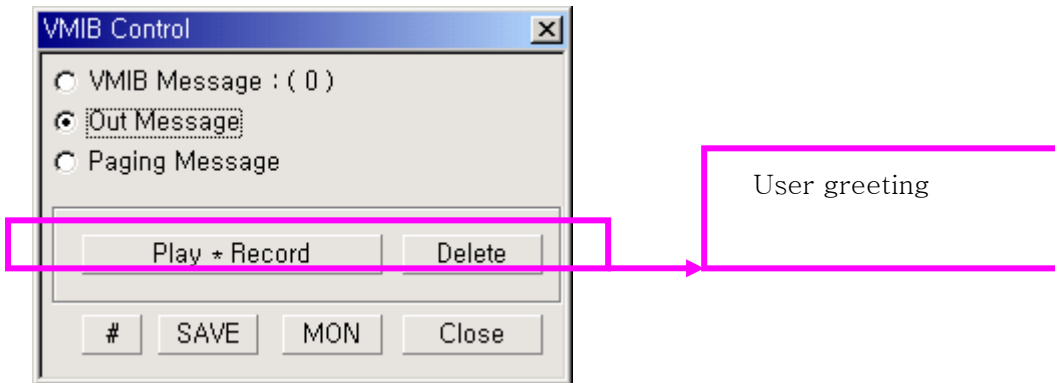

and SAVE button is only for “User greeting” recording.
Do not use them for other function.

2.3 Customize Dialog

1. Bell Sound

- **VIP, Normal, Black List could have each sound.**
- **You Can Filtering by Bell Sound**

If a list in address is VIP, the sound file assigned will be played when call is incoming from Co line.

If a list in address is Black, the sound file assigned will be played when call is incoming from Co line.

If a list in address is Normal, the sound file assigned will be played when call is incoming from Co line.

The file can be any mid files or wav file on your pc.

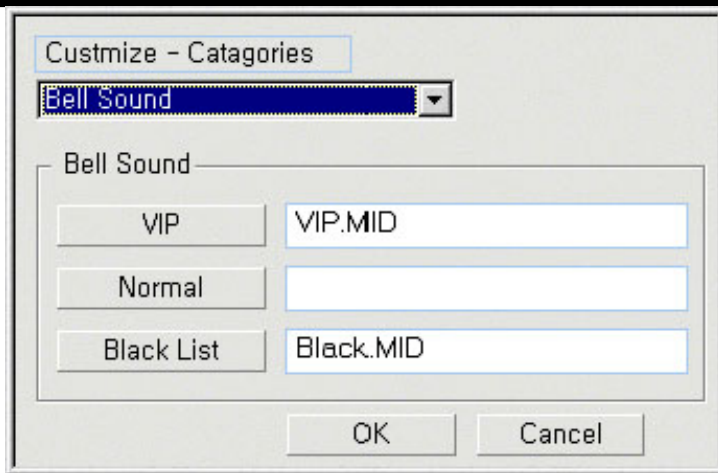

2. Black List Call Filtering

- Do Not Filtering (Filtering by Bell Sound if sound is set)

***Note:**

- ✓ In this case, ez Phone filters VIP, Black or Normal with sound files if you registered in the edit box

- By DND (Black List Call is arriving → Automatically DND)

***Note:**

- ✓ This functionality can not be used for attendant station
- By Forward VMIB (Black List Call → Automatically FWD)

***Note**

- ✓ For forward VMIB, admin PGM 140 CO TYPE should be IDSN_DID
- ✓ User greeting message should be existed.
- ✓ Check that you are able to use VMIB control or not.

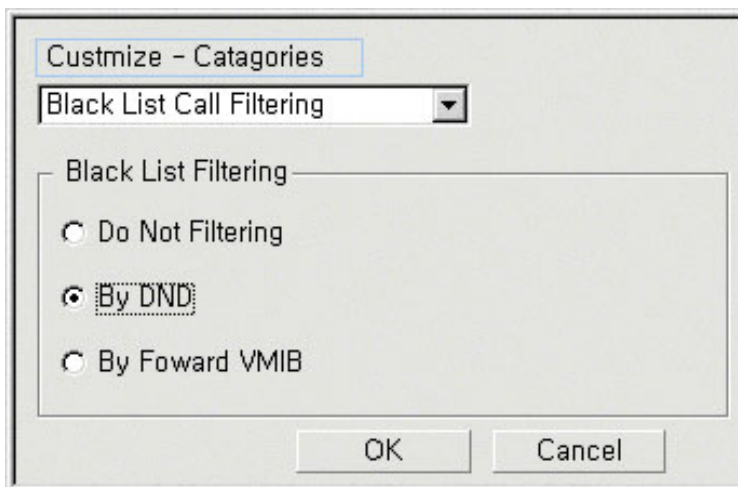

3. Outlook

* **Checking and unchecking means 'Enable' and 'Disable'**

* **If you check 'Check Box', the operation is activated.**

- Auto launch Outlook when 'ez Phone' is starting.

If you check 'Auto Start', Outlook program is will be started when ez Phone is starting. In this case, outlook should be installed.

- Automatically bring Outlook Schedule every some hour.
(30Min, 60Min, 90Min, 120Min)

If you check 'Schedule Auto Import', this operation will bring your station information window for each station.

- Use outlook email client as default

When your pc email client is not outlook email client, email function in ez Phone will work with your pc email client. If outlook is installed and you want to email with outlook, you should check the 'Check box'

If outlook is default email client, to check 'check box' is not necessary.

- Set new contact default folder

When you create new contact

ez Phone should be known the target folder because there can be more than two contacts.

If you set the default folder, next time new created contact will be placed in it. If you want to change this, press button and change it. The important thing is that the folder should be set as contact folder for valid operation.

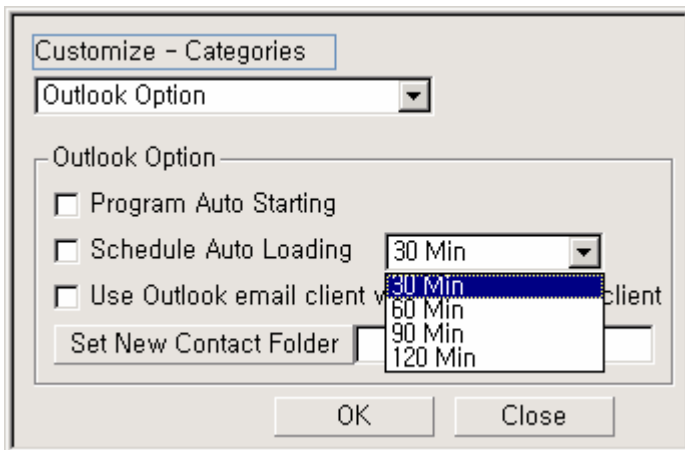

3. Log – View Option

- Check Internal (Internal Call record)
 - Check External (External Call record)
 - Check Outgoing (Outgoing Call record)
 - Check Incoming (Incoming Call record)
 - Set Max Log-View list's Count (default 20)
-
- If you check the check box, the call according to check box will be left on 'Log-View window'
 - Ex) Outgoing External call will not be left on 'Log-View window'

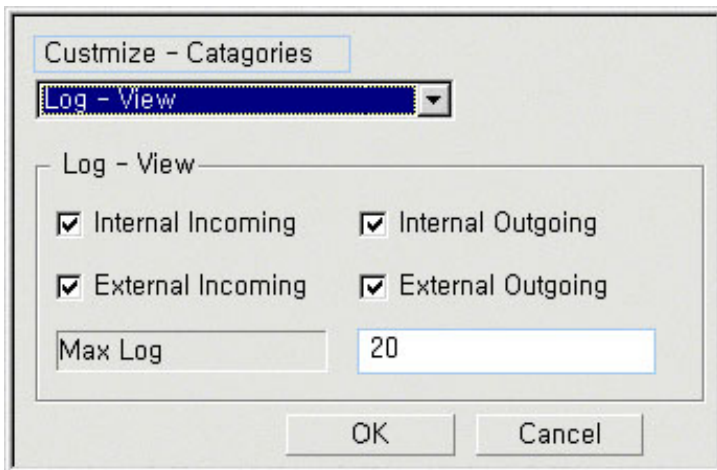

- ✓ Entry version of ez Phone could not have more than 20 logs.
- ✓ Deluxe could have more than 20 logs and you can insert max number of log history.

2.4 Option Dialog

** Pop up Window Style

- ◆ Minimize → Main Window Recovering (When new call is in)
- ◆ Minimize → Normal Popup (When new call is in)
- ◆ Minimize → Simple Popup (When new call is in)

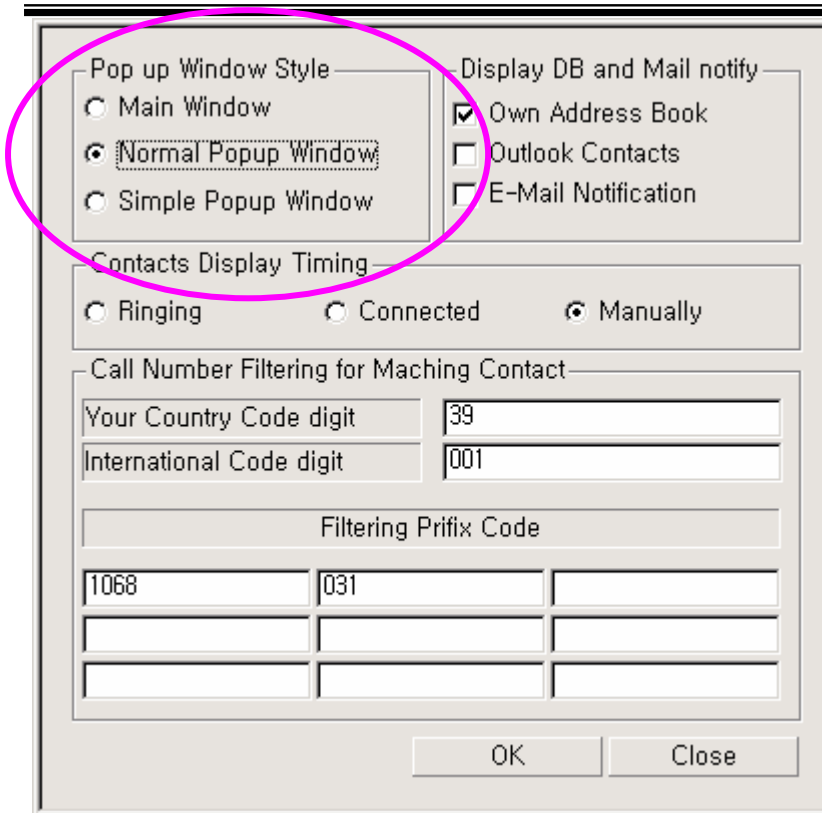

Normal Popup

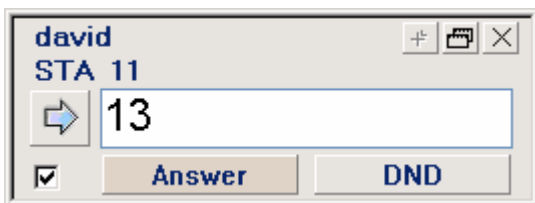

- ◆ If check the check box, this window is not disappeared after answering a call. If not, it is disappeared.
- ◆ The Normal Pop Up Window is shown at Window Task Bar(Bottom)
- ◆ You Can Answer, Transfer, Redirect Transfer Call without Main window
- ◆ Create contact and show contact. '+' is the button.
- ◆ Redirect Transfer is a transfer when incoming call is ringing not connected.

Simple Popup

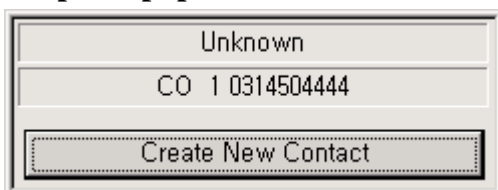

- ◆ This window is useful when outlook program is integrated.

- ◆ If there is no data in outlook contacts or own address book, you can create new database directly.
- ◆ You can open or create contact manually with pressing button.
 - ✓ If you want create a new contact for unregistered CLI, you should select this window.
 - ✓ **Note:** ez Phone should be on tray task bar or minimized. In this case, you can make a new contact for unregistered CLI.

**** Display DB and Mail Notify.**

- ◆ Display Own Address Book (When new external call is in or out)
- ◆ Display Outlook Contacts (When new external call is in or out)
- ◆ Notify new Mail Arrived.

NOTE: We recommend importing your outlook contacts for fast operation.

Country Code & International Digit

These rules will filter a prefix from a telephone number, so that these numbers will be displayed correctly.

- ◆ Country Code : Insert your country code for international call
Ex) Spain-> 34, Korea -> 82
- ◆ International Digit: Insert your international call access digit.
For making a call other country.
Ex) Spain-> 00, Korea -> 001, Italy -> 39
Sample:(00 means international call access digit : 00 39 039 2345 4567)

◇ These rules will filter a prefix from a telephone number.
Ex) you dial 1234567890, but system makes the number to 10791234567890

In this case you need to insert '1079' to make same number for matching addressed phone number. K.R Kim number 1234567890 is addressed, but 10791234567890 is not addressed. So if you insert "1079" in the box, this number 10791234567890 will be same as 1234567890. So correct contact popup or correct name will be displayed in window. This is only for matching addressed name or contact popup window. It is not related with any call process.

You can choose one of popup timing.

** When popup timing is ringing or connected**

For a call ringing or connected, contact popup will be displayed if contact is existed automatically.

If not, contact popup won't be displayed.

In this case there is not button to create a new contact of unknown CLI.

** When popup timing is 'Manually'**

You can decide that pop up contact or not. In this case, you can also create a contact of unknown CLI.

And you can decide to create a new contact or not

Own Address Book

✓ If the connected call or ringing number is existed in Address Book

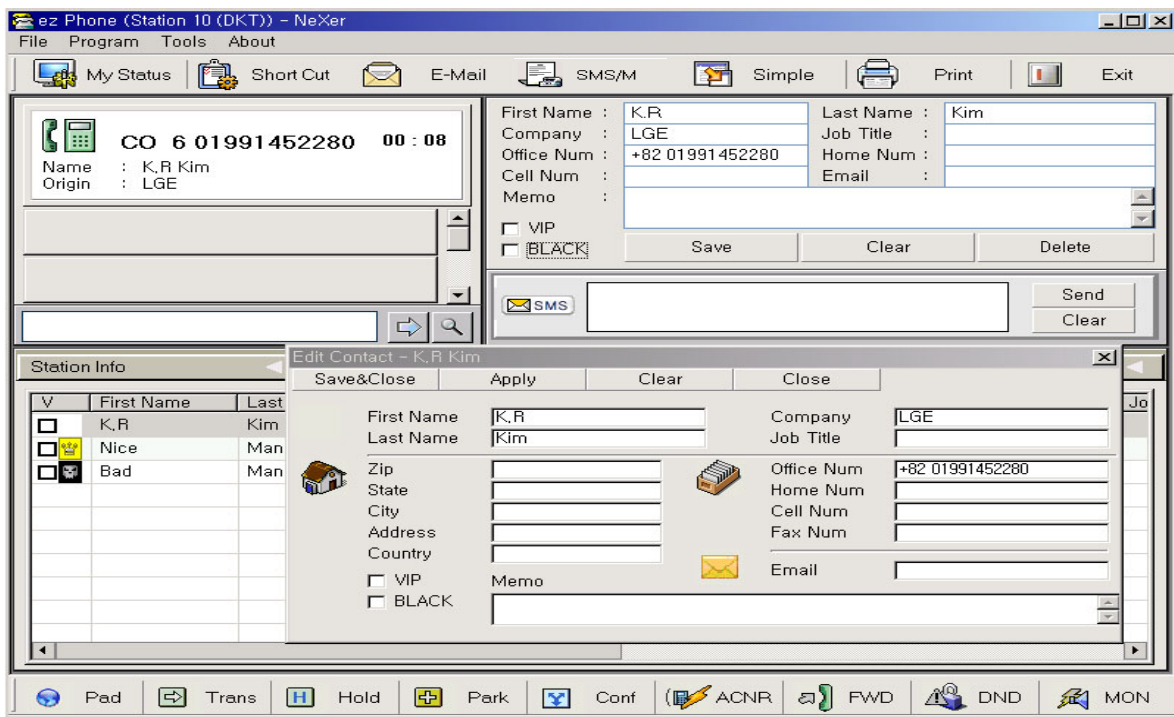

If call CLI is registered, the own address book popup window can be displayed.

The popup timing is depended on "popup timing option" and "Display DB"

Outlook contacts

- ✓ If the connected call or ringing number is existed in Outlook Contacts

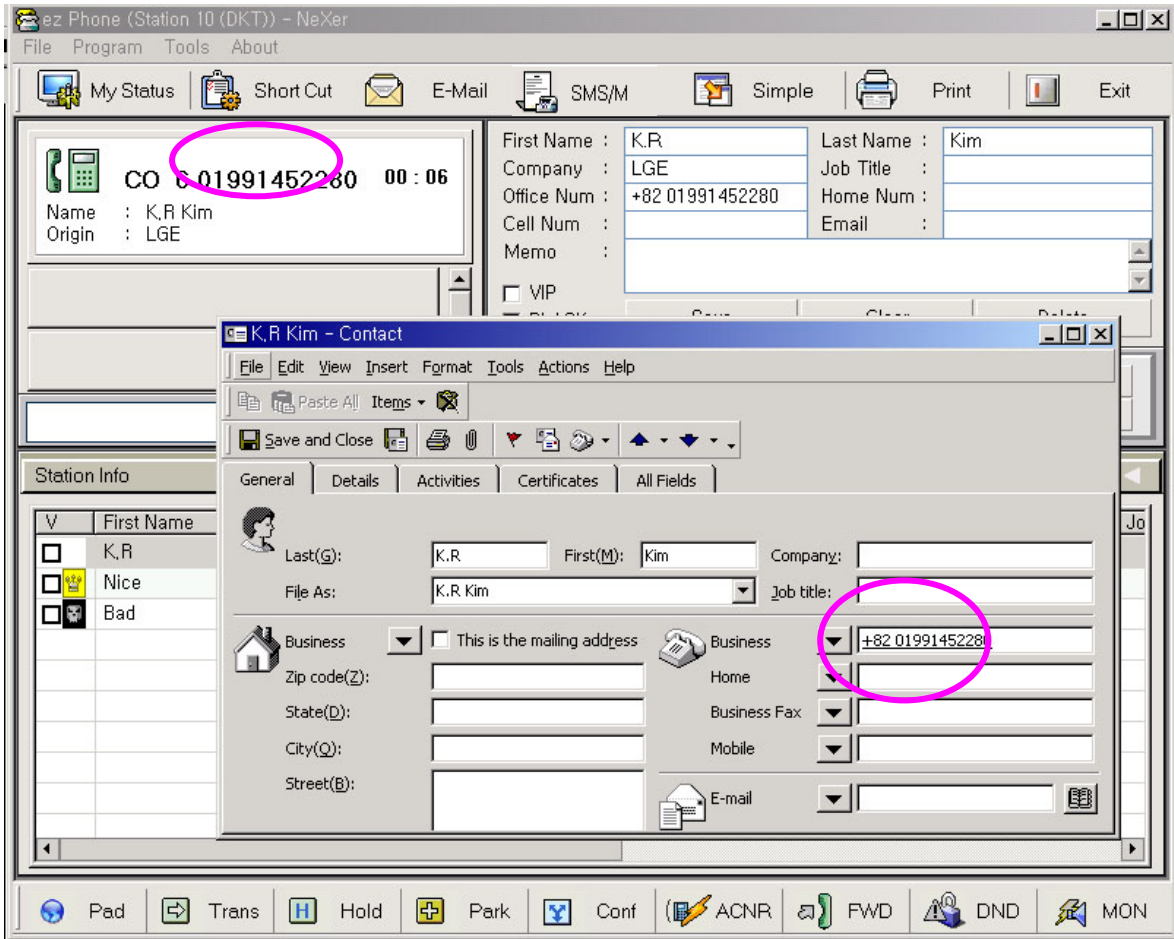

If call CLI is resisted, the outlook contact popup window can be displayed.
The popup timing is depended on "popup timing option" and "Display DB"

2.5 Always On Top

- Place 'ez Phone' Always Top.
- ✓ The 'ez Phone' is always placed as foreground window.
- ✓ Any Window Can not hide this window.

2.6 Import Outlook Contacts Into My Own Address Book

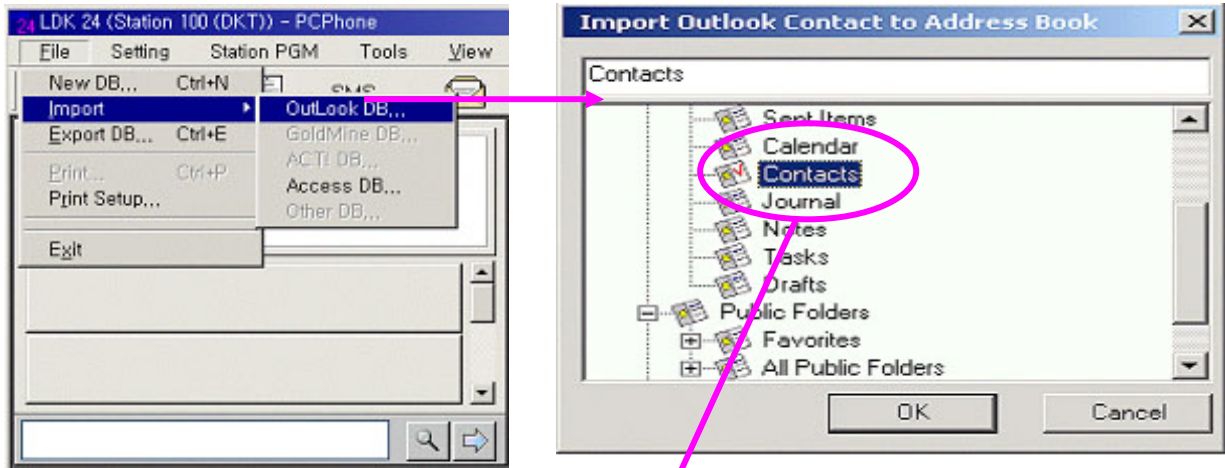

1. Import Outlook DB

2. Choose Contact Folder

Result

Station Info	Address Book	Log - View	Favorite					
V	Last Name	First Name	Home No.	Cell No.	Office No.	Company	Department	Job
<input checked="" type="checkbox"/>	Miles	Dana B. Miles			4567101	FrontRange S...	Sales	
<input type="checkbox"/>	Williams	Morley Willia...	(719)272-3800	(800)654-3526	(503)712-2222	Kaiser Perm...	Marketing	
<input checked="" type="checkbox"/>	Noel	Randall Noel	(719)272-3800	(800)654-3526	4567100	Dean Witter	Marketing	
<input type="checkbox"/>	Dennkow	Bea Dennkow	(719)272-3800	(800)654-3526	(708)552-3311	Cadtech Engi...	Engineering	

- Import from Outlook Contacts into 'ez Phone' Address Book
- Note : Should be selected Contacts Folder of Outlook program.

➤ **Recommendation(for outlook):**

For fast operation related with outlook contact you should import outlook contact.

2.7 Export My Own Address Book Export to Outlook

Set check before exporting data to other Database format

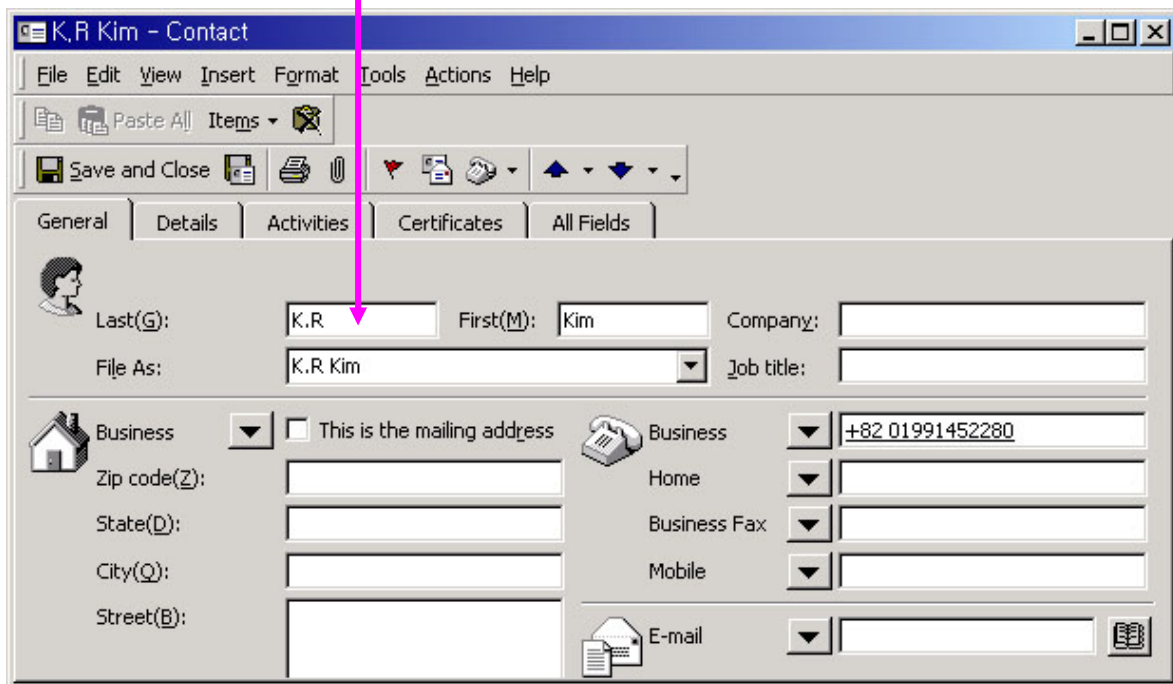
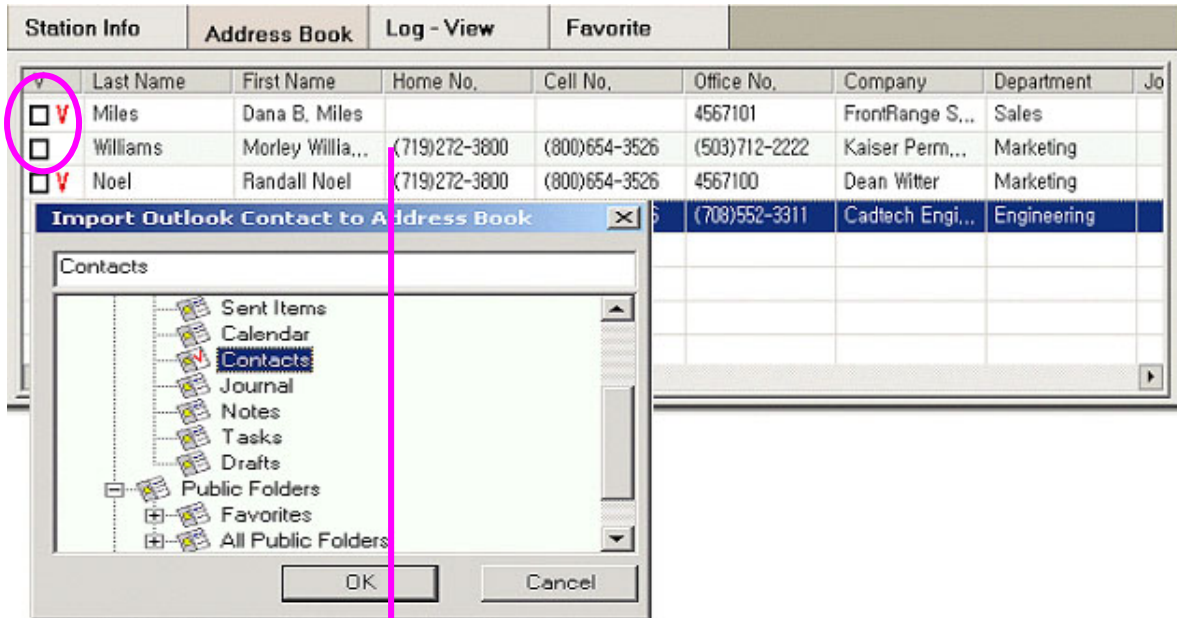

- ✓ Export to Outlook Contacts Folder from 'ez Phone' Address Book
- ✓ **Note** : Should be selected Contacts Folder of Outlook program.

■ **Conference window**

(For LDK 24- NeXer)

1. You can do operation for conference when there is one connected call.
2. If you have connected call, press "Conf" button on bottom toolbar window.
3. Then you can see above window.
4. Then you have to dial to another party to make it join into conf.
5. The sample window means to make 15station to join into Conf.
6. If 15 Station answers, you press add conf button to join in.
7. If you want to remove one of them , just click list and then press Remove From Conf.
8. *If 15 Station is busy or invalid, you press hang up .*
9. Then you can take normal connected state.
10. If error is occurred, press recover correct state from error.

(For Ldk 100, 300, 600)

1~ 6 Same

7. If you want add one more party, press 'prepare' and 'dial'.
8. If the called party answer, press 'Add Conf'
9. 7~ 8 repeat.

* Remove and error correction is same with LDK 24 conference.

3 Tips

'ez Phone' can be handle without mouse except Menu, Top Tool Bar and Bottom Tool Bar.

As you know, any window control operation needs to have a focus to use tab or enter key operation and so on.

3.1 Focus (F1, F2, F3, F4)

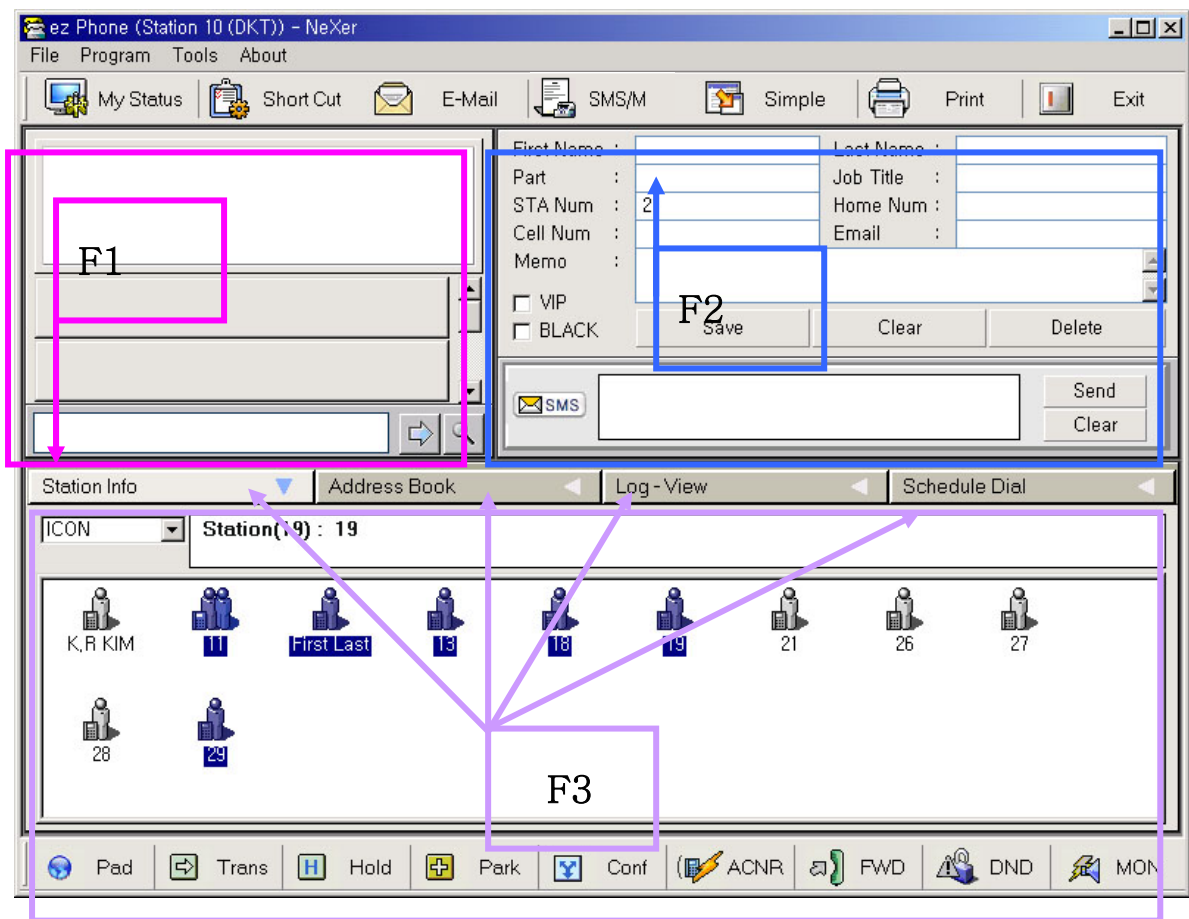

If one of windows has a window focus, you can set window focus any control(ex. Button, edit box window, list control and so on) by key board(tab or cursor) and then order it act.

3.2 Sub Window Focus (Ctrl + Tab)

When the bottom window has the window focus, you can change sub window's position by using [ctrl + tab]

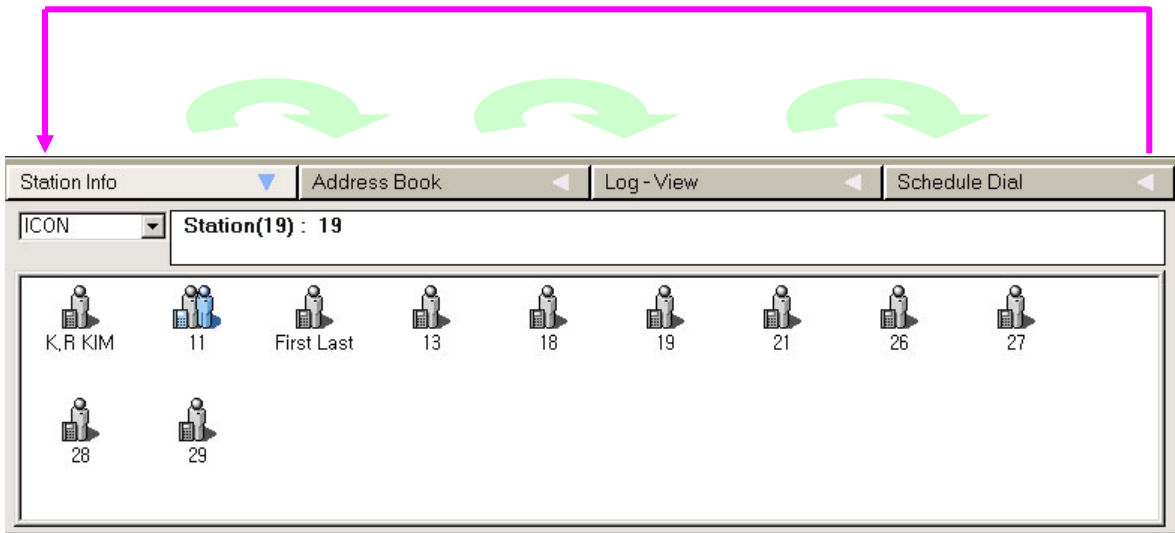

3.3 Make Call without using 'ez Phone' Window.

You can make a call with selecting a number string on any kind of application window.

The first step is to select a number string and then to press **Ctrl + C**.

The second step is to just **press Ctrl + Shift + D** then 'ez Phone' makes a new call.

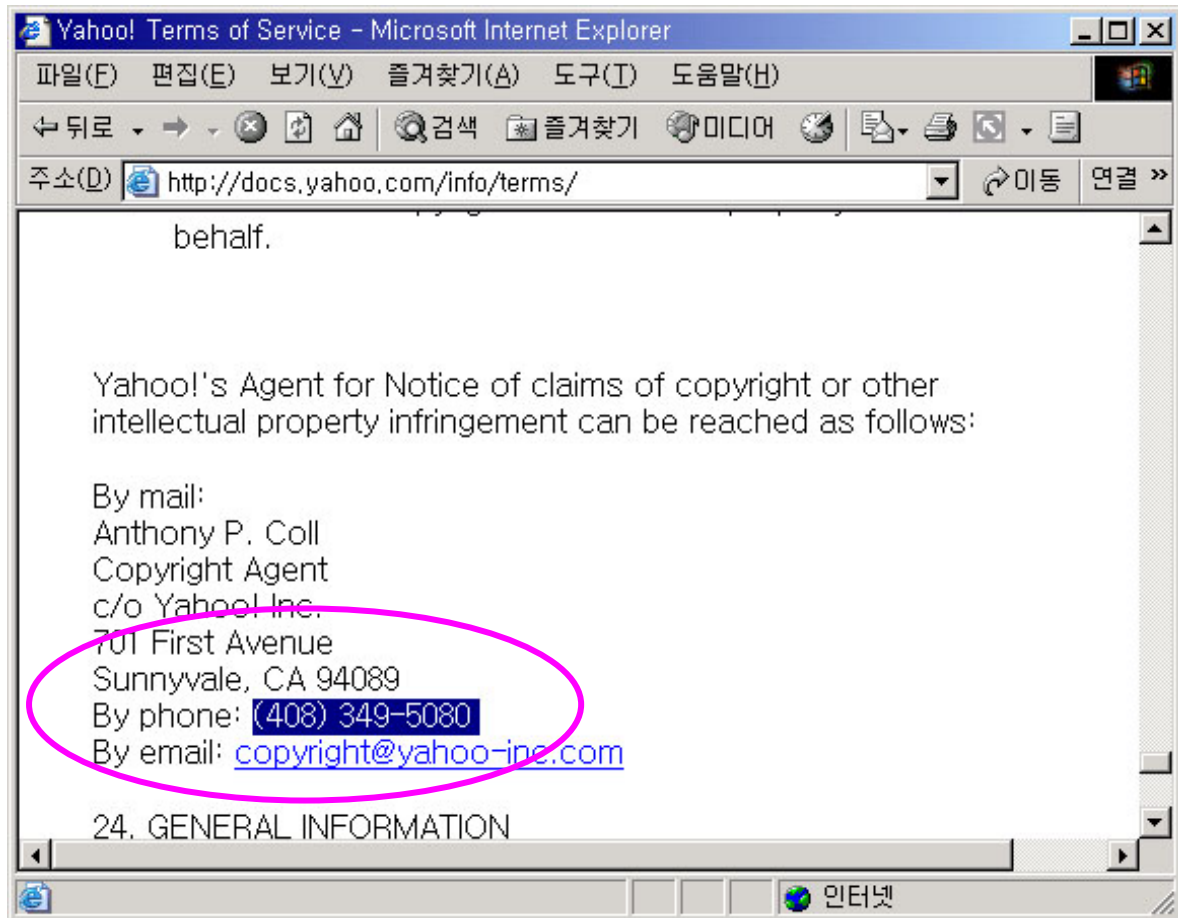

3.4 Task Bar State

1. Normal State



2. If there is a missed call.



3.5 Lock Key Missing Message Box

1. If there is no lock key for “ez Phone”, you will meet the below message box.



2. If you meet this message box, please contact the local dealer for 'ez Phone' lock key

3.6 SLT and DECT.

- There is “MON” button for SLT and DECT.
- ACNR is not valid for SLT and DECT
- If you want to make call with SLT, you should lift its receiver.
- If you want to answer an incoming call with SLT, you should lift its receiver.
- DECT has “TALK” button instead of “MON” button. Both are very similar. But if you want to hang up a call with DECT, you should press “TALK” button on your dect terminal.
- Flex button assignment is not valid for SLT and DECT
- ACNR is not valid for SLT and DECT.
- DECT ez Phone send some messages to DECT terminal. And DECT terminal will be given the message and do operation correctly what ez Phone sent. But DECT terminal could not display correct state automatically. So if you want to see correct state(like DND, FWD and so on), you need to refresh DECT terminal by your hand. But ez Phone state is always correct. After making call and answering call, the DECT terminal shows you correct state automatically.
- If system does not give some feature for SLT and DECT, ez Phone does same for them.

4 Addition (Integration Version) – Over Phase II

1.1 Operation for internal outgoing call (when ring back)

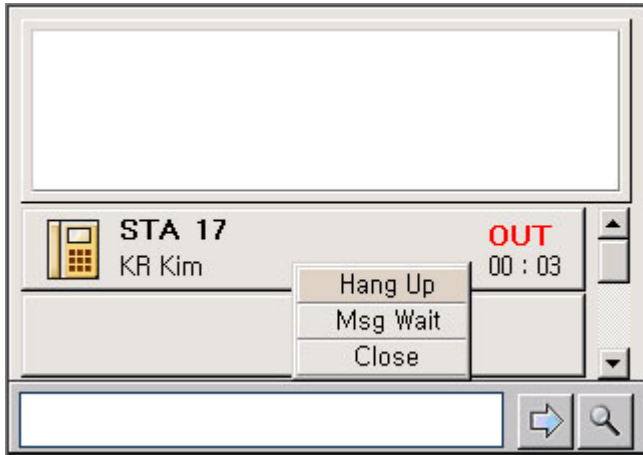

- Left button clicking is for drop the call.
- Right button clicking gives you more operations (Hang up, Message wait)

1.2 Operation for internal outgoing call(when busy)

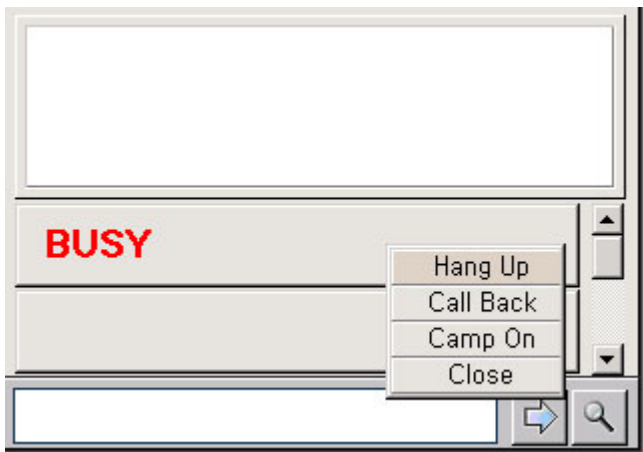

- Left button clicking is for drop the call..
- Right button clicking gives you more operations(Hang up, call back, camp on)

1.3 Operation for connected status

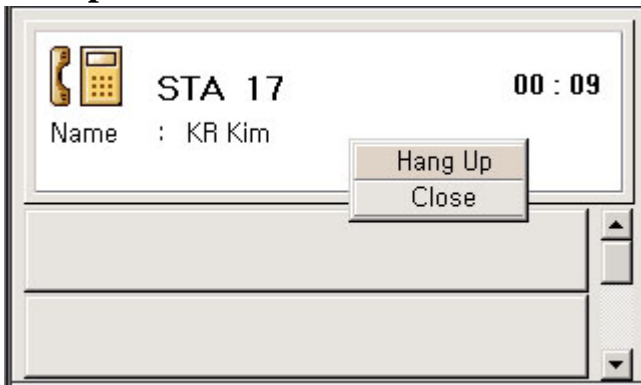

- No operation for left mouse clicking
- Right button clicking gives you 'hang up' operation

1.4 Vimb and Msg wait Notification



- If new message is arrived, the icon will be blink.
- And press the icon you can see what's new and can control them.
- Left side button is for VMIB and right side button is MSG wait.
- If you click left side button, you can see the count of left VMIB and control it.
- If you click right side button, you can see Message wait.

1.5 My station program(in menu)

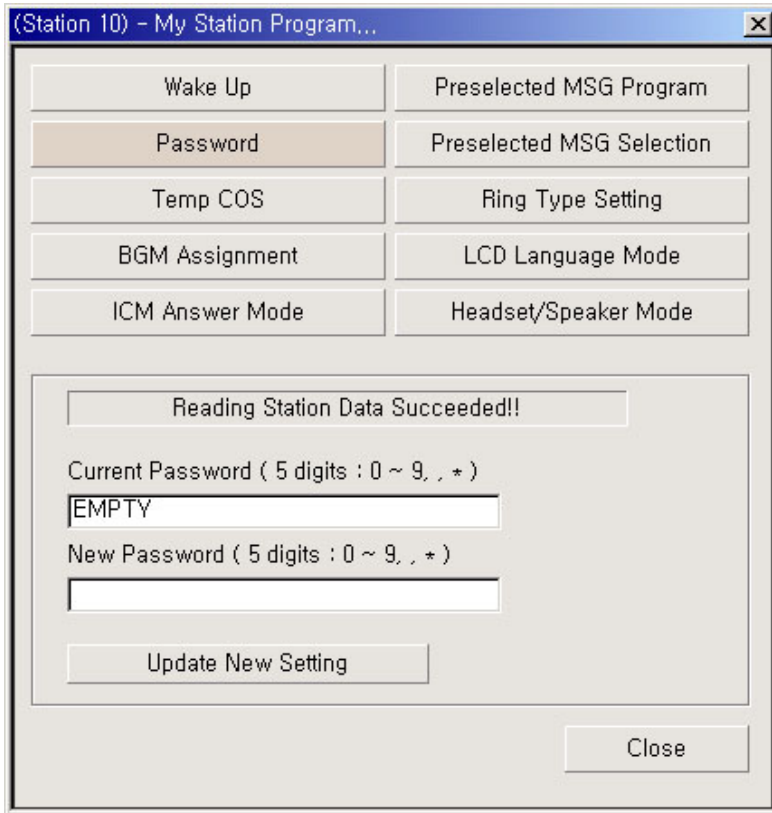

- ✓ Wake up, Password setting, Background music and so on.
- ✓ Each attribute is displayed on bottom when you press the button. Then you can change or set data.
- ✓ The message 'Operation success' means correct data
- ✓ Press 'New setting apply' when you want to change data..

1.6 Auto ACNR(Schedule Dial Window)

- Ez Phone sets ACNR when 'Scheduled dialing' meets 'Busy State' for external outgoing call.

1.7 SMS OVER GSM

- Ez Phone can send SMS to Mobile Phone

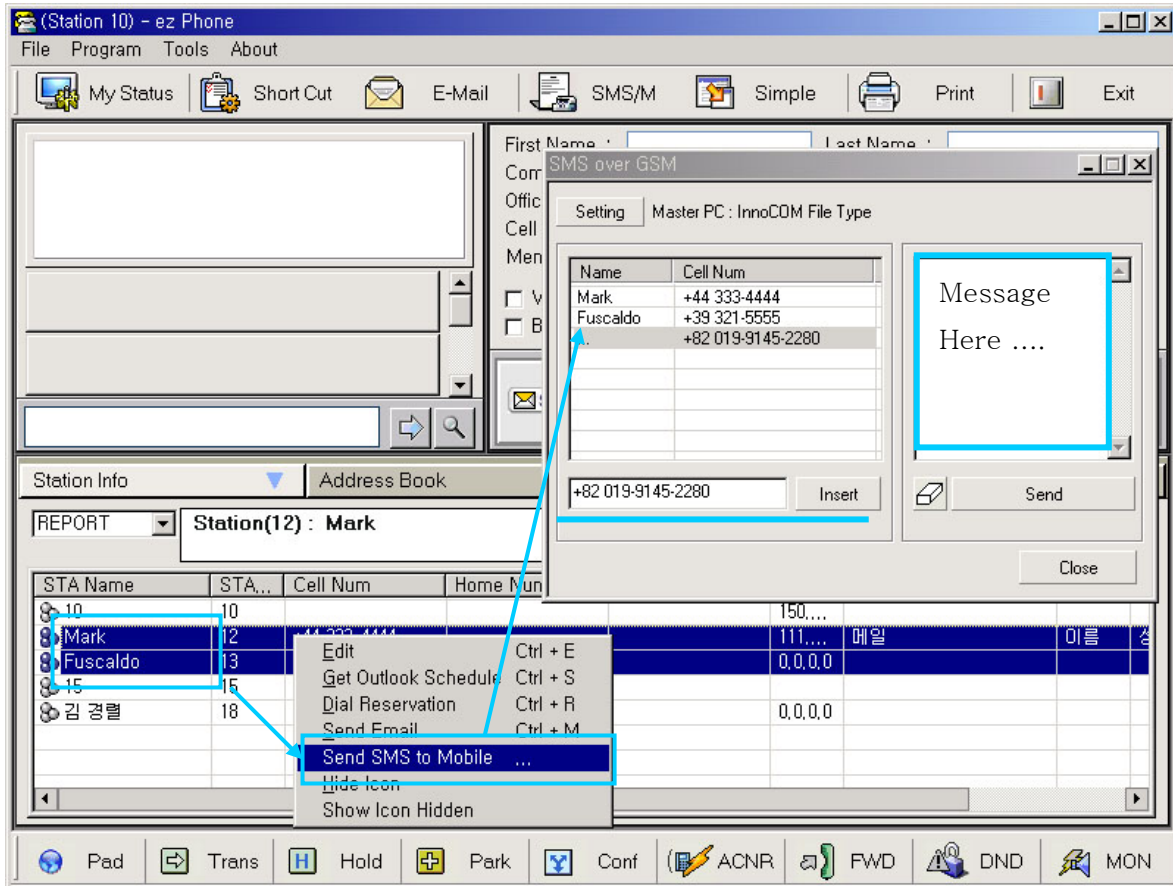

Step 1: Drag Icons with mouse and Click Right Mouse button and then Click 'Send SMS to Mobile (For Station Window)

Step 1': Check the check box and Click Right Mouse button and then Click 'Send SMS to Mobile (For Address book Window)

Step 2: The targets will be into SMS Sending Dialog.(You can set target directly with insert button on SMS Sending Dialog.

Step 3: Write some message in to Message Text Box

Step 4: Send ..

Note: To send SMS, you should set previous setting correctly.

About Setting is below.

◆ **SMS Previous Setting**

You should restart ez Phone when any setting changed.



Right status for sending



Wrong status for sending

1. Master PC (Master PC can be ez Phone or ez Attd)

- ✓ If your computer has SMS Modem or connection to SMS service hardware.
- ✓ Check Master PC check box

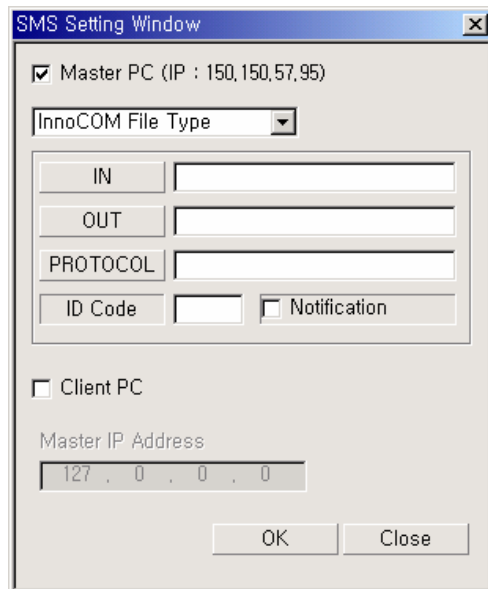

(File Sharing Type)

- a) File Sharing Type(Innocom GSMLine SMS should be set to send message)
 - i. Set SERVER/OUT Path for sending SMS(Supported Current Version)
 - ii. Set ID code

◆ **Now ez Phone(Phase III 3.0Af) supports only “Inocomm file sharing way” for sending SMS**

2. Client PC (Client PC can be ez Phone or ez Attd)

→ If your computer is client of Master PC that has SMS Modem or connection to SMS service hardware.

→ Check Client PC check box

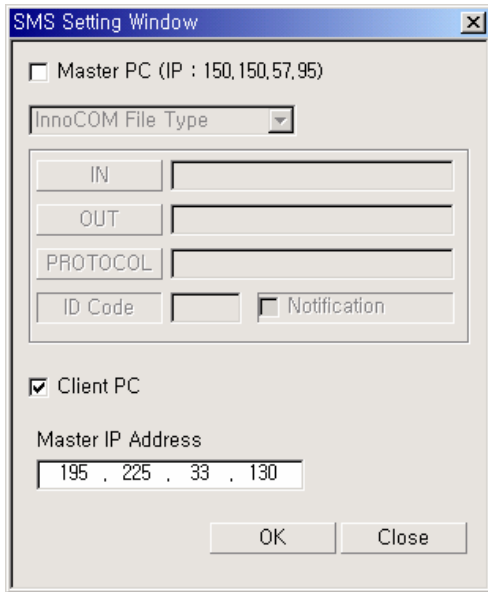

✓ Just Set Master PC IP Address.

5 New and Modified Feature (Integration Version)

1.1 Option Window

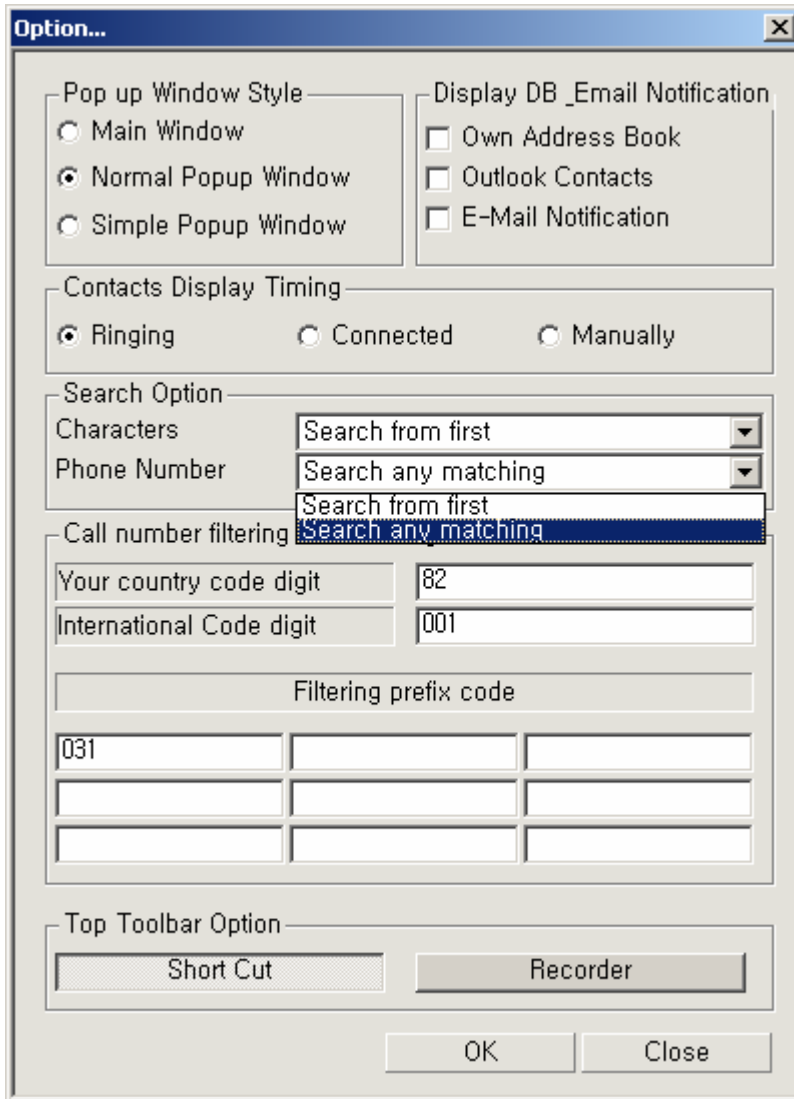

1) Search Option(Phase II 2.0Ah Over)

Search option is added two features for searching list for station info and address book.

- ✓ **Characters(Station name, First Name , Last Name)**
- ✓ **Phone Number**

If you want to search list with the first character matching, select 'Search from first'

If you want to search list any matching list, select 'Search any matching'

2) Top Toolbar Option (Phase III Only)

1. Short Cut

- Show Short Cut Icon

2. Recorder Link

- Show Recorder Link Icon

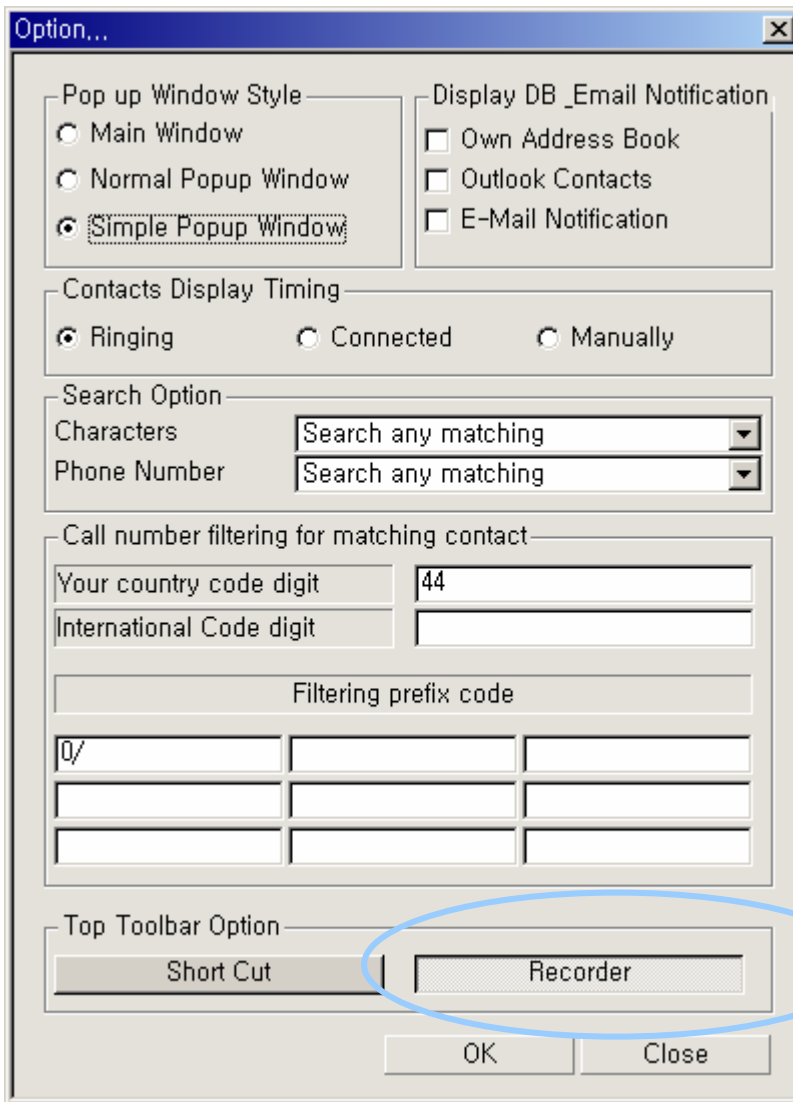

Set this button down for call recording program

3) Recording Link(To send data to call recording program) (Phase III Only)



◆ Condition

1. When you have a connected call on ez Phone
2. a) Call Recording program is installed and running on window.
 - ez Phone send data(phone number, first name, last name)
 - Call Recoding program will update the data and starting recording
- b) Call Recording program is installed and not running on window.
 - ez Phone executes the Call Recording Program
 - ez Phone send data(phone number, first name, last name)
 - Call Recoding program will update the data and starting recording

4) Agent Log In (Phase III Only)

- If your station is dummy station, you can see below dialog and log in with agent number and password.

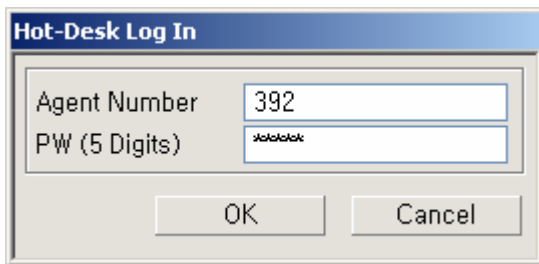

5) Agent Log out

- When ez Phone is closing, you can see below dialog if your station is logged in as agent.

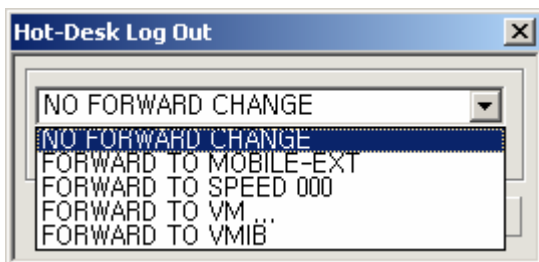

6) Conference Room(Phase III Only)

- Your can make, join and delete the conference room.

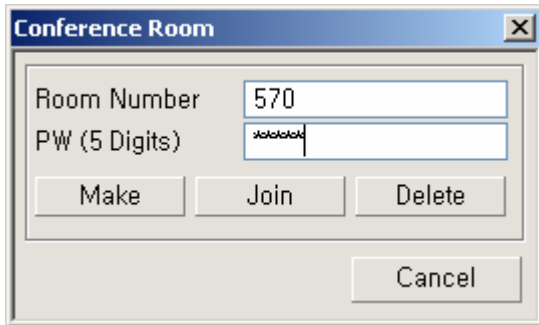

7) Key mapping(Phase III Only)

- You can change key mapping.
- Make sure the focus on the window that the key is valid.

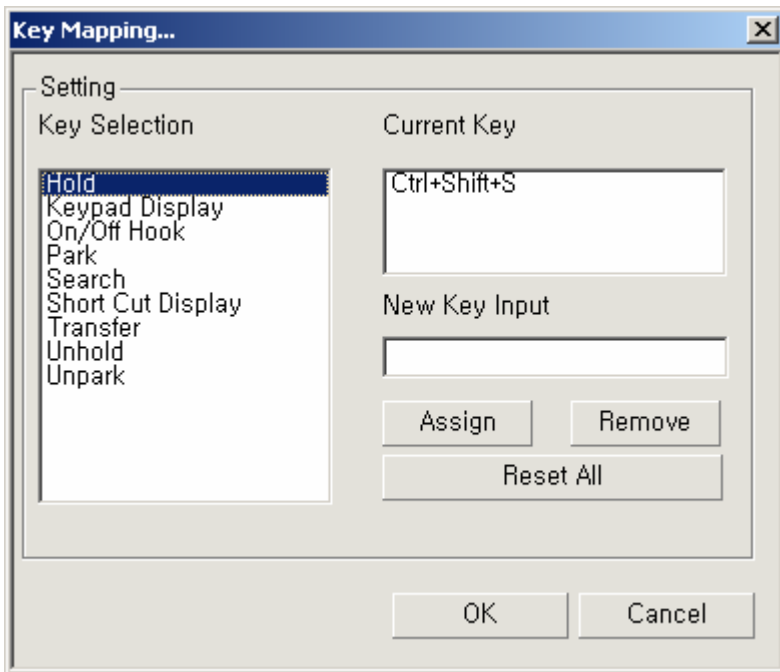

8) Default Text For Email(Phase III Only)

9)

- Below message will be inserted the email client automatically.

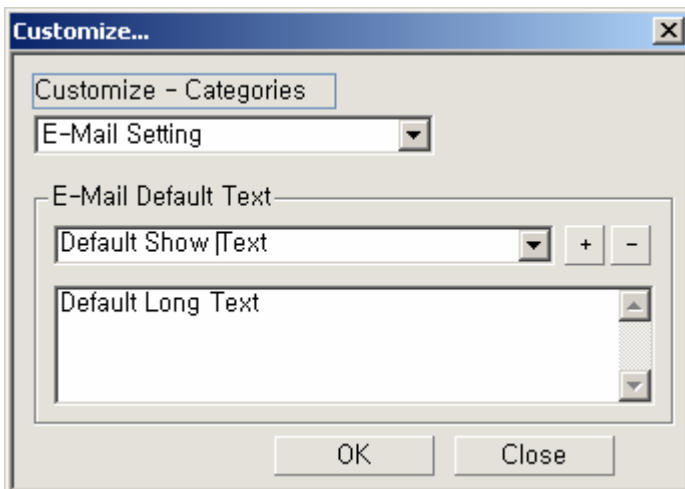

10) This is today note. (Phase III Only)

(Phase II)→ Note is not based on day.

➤ You can save the text for each day

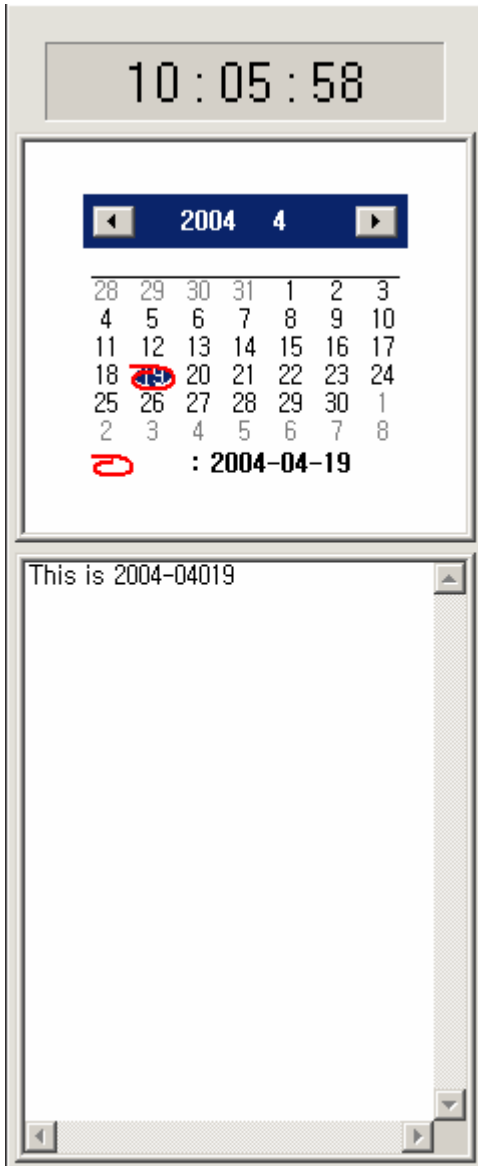

11) **Joint Conference room or transfer Conference room. (Phase III Only)**

- Make sure the password. If there is no password just number(eg. 570) is enough.
- If the password existed, add the password after number with '/'
- Conference room call only supports 'dial' and 'hang up'

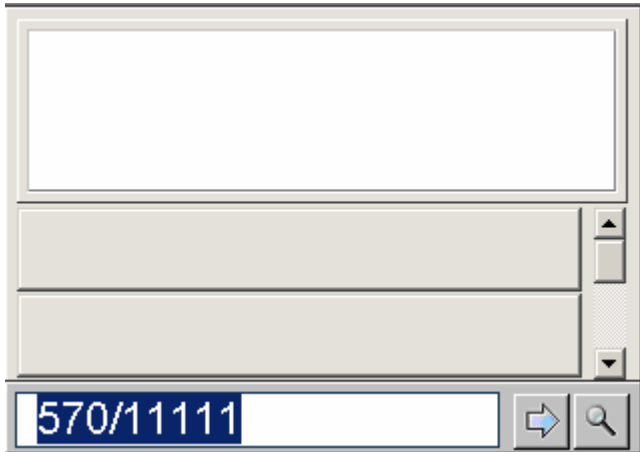

12) Drag and Drop Conference Call(Phase III Only)

1. Drag station or address book and drop for conference.(First member)
2. If call member is over then 3, press Pre Add Conf and do drag & drop.

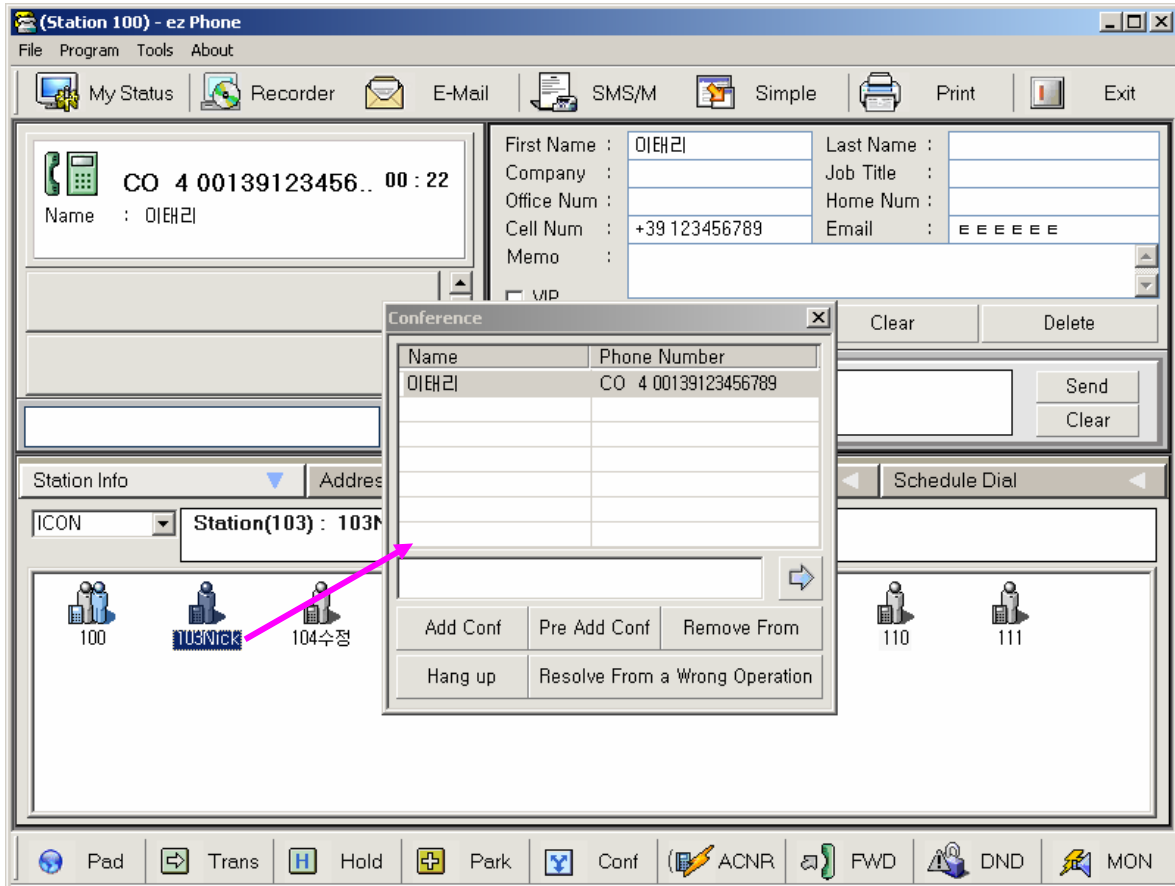

13) Quick Operation(Phase III Only)

- User can dial directly with tray icon right pop-up menu when ez Phone window is minimized.

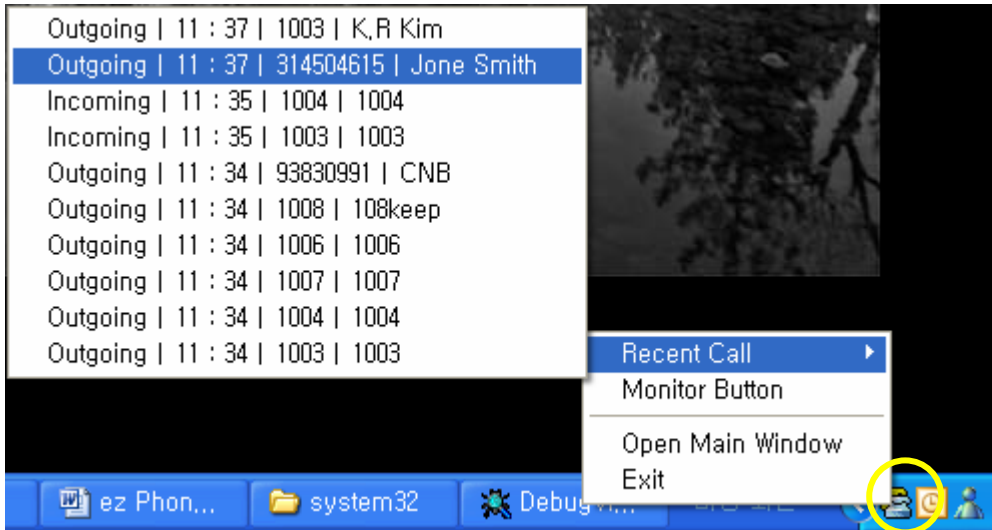

14) About Slave Station

- ez Phone works with only Master Station, so 'Call log' and 'Call Information' of Slave is not supported .

15) About MS Office Security(Service pack is installed)

- If you meet the follow message box from MS Outlook when importing or exporting 'Contact' or 'Schedule'. You should confirm the message box.
- Check the check box then click 'Yes' button. If you click 'No', there will be error message in ez Phone. In this case you should restart ez Phone

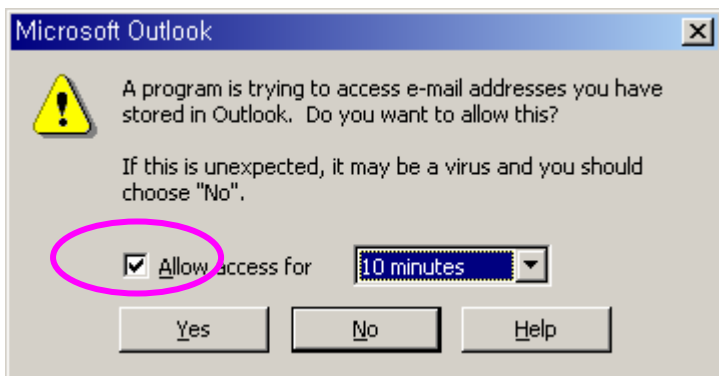

If you don't want to see the message, you need to install 'Express Click yes' program of Microsoft.

Free Manuals Download Website

<http://myh66.com>

<http://usermanuals.us>

<http://www.somanuals.com>

<http://www.4manuals.cc>

<http://www.manual-lib.com>

<http://www.404manual.com>

<http://www.luxmanual.com>

<http://aubethermostatmanual.com>

Golf course search by state

<http://golfingnear.com>

Email search by domain

<http://emailbydomain.com>

Auto manuals search

<http://auto.somanuals.com>

TV manuals search

<http://tv.somanuals.com>