



LG
Life's Good

OWNER'S MANUAL

Video Call Camera

Please read this manual carefully before operating your set and retain it for future reference.

AN-VC500

www.lg.com
(Brazil : www.lge.com)

CONTENTS

PREPARATION

| | |
|--|---|
| Overview | 3 |
| Installing the Video Call Camera | 4 |

USING Skype (NetCast Smart TV)

| | |
|---|----|
| Start Skype..... | 5 |
| Create account / Sign in..... | 5 |
| Skype menu | 6 |
| Contacts..... | 6 |
| Add Contact..... | 6 |
| Call Phones | 6 |
| History..... | 7 |
| My Information | 7 |
| Settings | 7 |
| Make a Video Call to the Contact..... | 8 |
| Make a Call (Voice only) to a Contact | 9 |
| Receiving a Call | 10 |

USING Skype (webOS Smart TV)

| | |
|---|----|
| Start Skype..... | 11 |
| Create account / Sign in..... | 11 |
| Skype menu | 12 |
| Contacts..... | 12 |
| Add Contact..... | 12 |
| Call Phones | 12 |
| History..... | 13 |
| My PROFILE | 13 |
| Settings | 13 |
| Make a Video Call to the Contact..... | 14 |
| Make a Call (Voice only) to a Contact | 15 |
| Receiving a Call | 16 |

APPENDIX

| | |
|-----------------------------|----|
| Troubleshooting | 17 |
| Product Specifications..... | 18 |

Product Handling

- Do not let the camera get wet. Liquid getting into the camera could cause a short circuit.
- Wipe the camera gently with a dry cloth to remove any dust or dirt. If the product is very dirty, spray a mild detergent on the cloth first.
- Do not clean with thinner, alcohol, benzene or any other volatile agent. These may damage the product's surface or affect its operation.
- Do not disassemble, repair or alter the product. Incorrect disassembly may cause a fire, electric shock, or injury.
- Do not shake the camera.
- Do not pull on the cable.

Installation Instructions

- Make sure you have enough space for connections when installing the product.
- Do not install in a dusty, dirty or moist area.
- Do not install in direct sunlight or near a heat source.
- Magnetic objects, such as speakers, may interfere with the camera's operation.
- Install the product in a place with moderate temperature and humidity. The recommended temperature range is 0 °C to 40 °C.
- Strong electromagnetic waves from other devices could interfere with the camera's operation.
- Remove all the protective plastic bags (Vinyl) before use.

The product and company names contained in this manual may or may not be registered trademarks or copyrights, and are only used for identification or explanatory purposes. All trademarks reserved.

The AN-VC500 is a Video Call Camera that can be used with some LG TVs.

The following model lines are supported:

EA8 / EA9 / EC / JL / LA6 / LA7 / LA8 / LA9 / LB49 / LB57 / LB58 / LB61 / LB63 / LB65 / LB67 / LB68 / LB69 / LB7 / LB8 / LN4 / LN5 / LN6 / MS5 / MS7 / MT9 / PB66 / PB69 / PH47 / PH66 / PH67 / PN47 / PN57 / PN67 / UB / UC

* Every model line listed is not available in every country.

PREPARATION

OVERVIEW

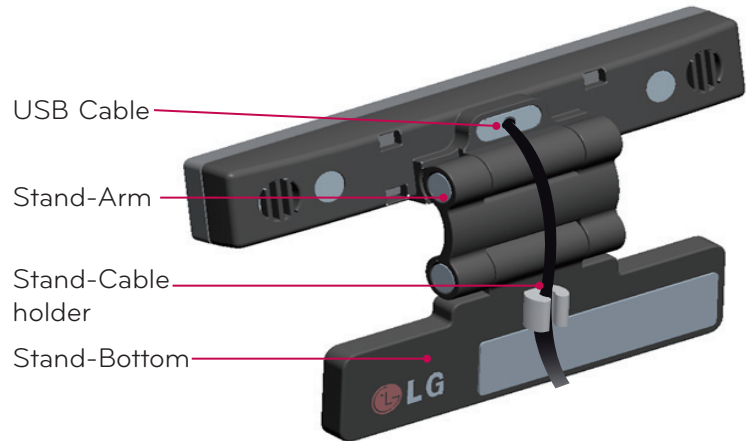
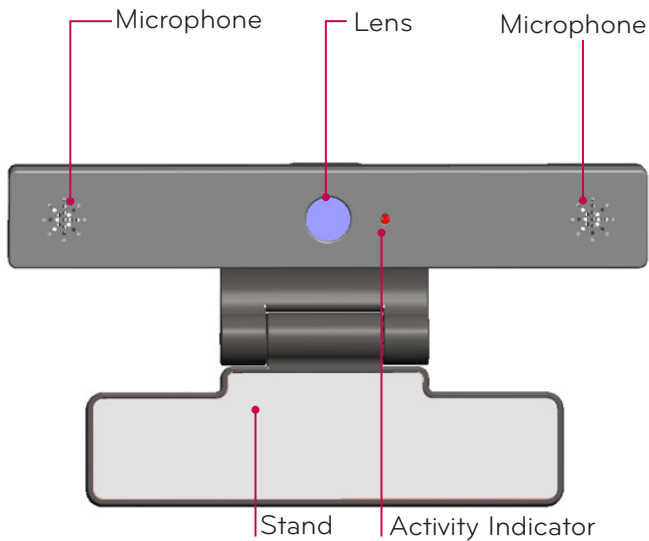

! NOTE:

- ▶ If the Skype app is not installed on the TV, download the app at the LG Store.
* For instructions regarding the LG Store, refer to the TV User Guide.
- ▶ For best results when using external speakers, only use the front right/left (stereo) speakers when using Skype.
- ▶ When making a video call with Skype using a PC, the Skype software version for Windows should be 4.2 or newer. (Visit the Skype homepage (www.skype.com) for operating systems other than Windows, e.g. OS X, Linux, etc.)
- ▶ Video calls can not be made to a Mac that runs Skype 2.8 or lower.
- ▶ Content can be changed or deleted depending on Content Provider.
- ▶ Please visit the content provider's web site for specific information on their services.
- ▶ The software update screen will automatically appear when an update is available.
- ▶ For some models, you cannot use input devices such as a keyboard and mouse while using Skype (premium content).
(Keyboard does not with
EA8 / EA9 / EC / JL / LA6 / LA7 / LA8 / LA9 / LB49 / LB57 / LB58 / LB61 / LB63 / LB65 / LB67 / LB68 / LB69 / LB7 / LB8 / LN4 / LN5 / LN6 / MS5 / MS7 / MT9 / PB66 / PB69 / PH47 / PH66 / PH67 / PN47 / PN57 / PN67 / UB / UC)
- ▶ Before using the built-in camera, you must recognize the fact that you are legally responsible for the use or misuse of the camera by the relevant national laws including criminal law.
- ▶ The relevant laws include the Personal Information Protection law which regulates the processing and transferring of personal information and the law which regulates the monitoring by camera in a workplace and other places.
- ▶ When using the built-in camera, the user must gain consent from the data subjects. Please avoid using the camera in the following manner.
 - (1) Using the camera in areas where the use of camera is generally prohibited such as restroom, locker room, fitting room, and security area.
 - (2) Using the camera while causing the infringement of privacy.
 - (3) Using the camera while causing the violation of the relevant regulations or laws.



No emergency calls with Skype

Skype is not a telephone replacement service, and cannot be used for emergency service dialing.

PREPARATION

INSTALLING THE VIDEO CALL CAMERA

- 1 Unfold the stand and put it on the top center of the TV set.

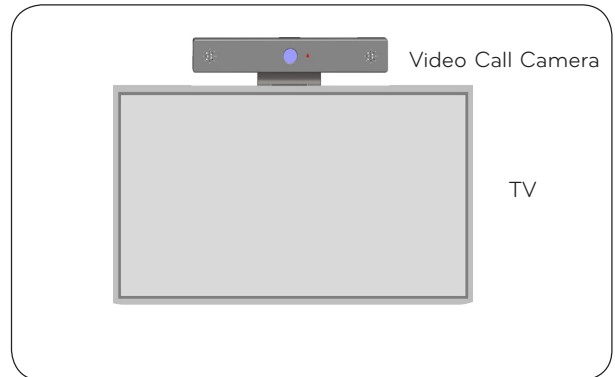

- 2 Fold the stand.

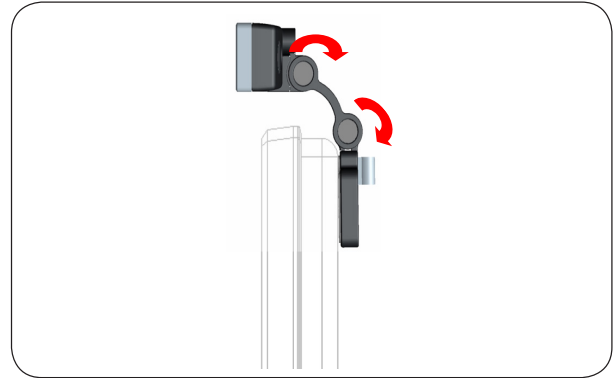

- 3 (A) Firmly attach the TV stand to the back of the TV set using the stand magnet.

(B) If you have difficulty attaching the stand or want to prevent it from slipping off, use the Velcro tape to secure it.

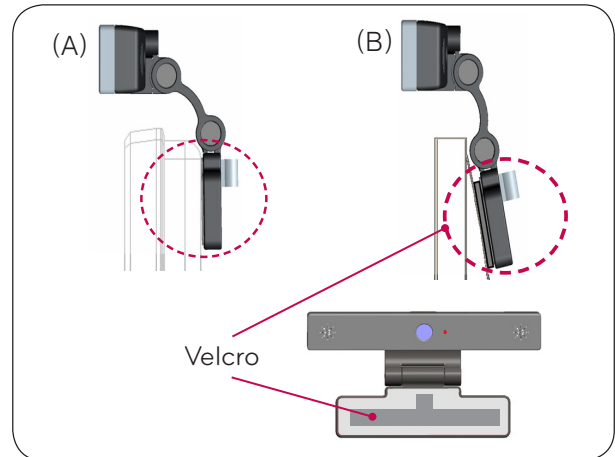

- 4 Connect the USB cable to the side of the TV. The camera may not work if it is connected through the USB hub.

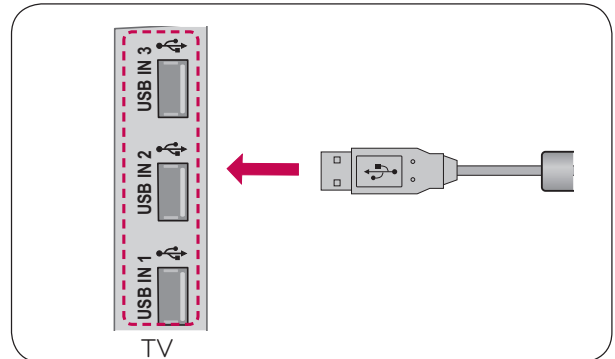





! NOTE

- ▶ For the best quality video and audio outputs, install the camera on the top-center of your TV.
- ▶ Set up with the television switched off.
- ▶ When using external speakers, allow sufficient space between the microphones and the speakers.
- ▶ The TV must be connected to a network for Skype to work.

USING Skype (NetCast Smart TV) START Skype

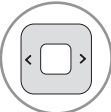



REGULAR REMOTE CONTROL

- 1 Press  
- 2    Start **Skype**.

! NOTE:

- ▶ Skype must be connected to a network to operate.

MAGIC REMOTE CONTROL

- 1 Press  
- 2   Start **Skype**.

CREATE ACCOUNT / SIGN IN



After selecting the Skype icon from the Premium menu, enter your Skype name and password. Choose "Sign me in when Skype starts" to sign in automatically when the TV is switched on.

! NOTE:

- ▶ You can log in with your existing Skype account or a Skype account that is merged with your Microsoft account.
- ▶ To create a new Skype account that is already merged with your Microsoft account, please refer to their websites for further information.

Skype MENU



Contacts

This is the list of contacts in your contact list. For more details about how to make a call, refer to pages 9 and 10.

! NOTE:

- ▶ The maximum number of contacts that can be stored is limited by the storage capacity.
- ▶ If there are more than 500 contacts, the list's performance and stability may be affected.

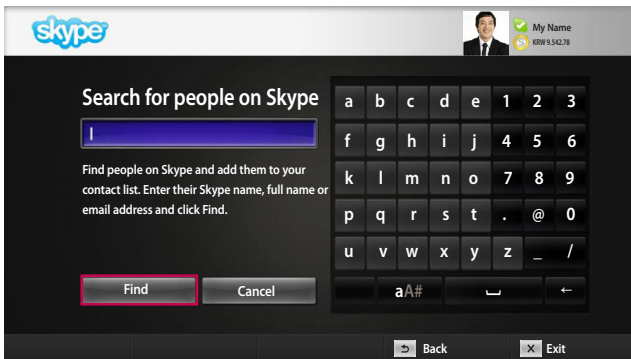

Add Contact

When pressing the **RED** button on the remote control while on the contact list, the following screen appears. This allows you to search or add users.

Press the **"Find"** button to start a search, or press the **"Cancel"** button to return to the previous menu.

! NOTE:

- ▶ Search results will be in alphabetical order.

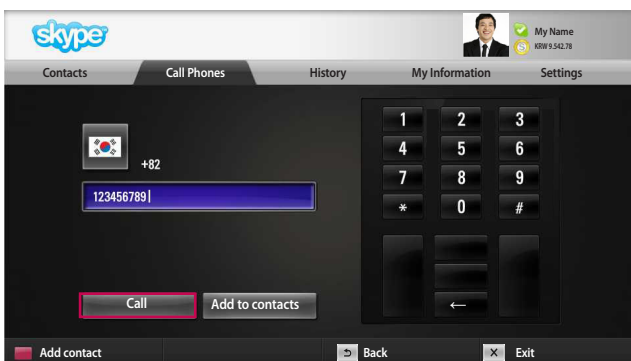

Call Phones

Select the country you would like to call and enter a phone number. Now select **"Call"**.

! NOTE:

- ▶ To use Call Phones, you will need **Skype Credit**. For more details, visit the Skype homepage (www.skype.com).

Skype MENU (CONTINUED)

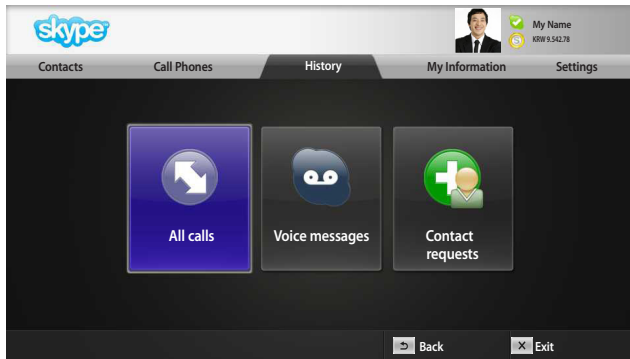

History

This lists All calls/Voicemails/Authorization requests. By selecting 'All calls,' you can check your Incoming/outgoing/missed calls.

You can check the received event list by selecting 'Voice messages' or 'Contact requests'.

The numbers on the right side of each item indicate the number of unchecked items.

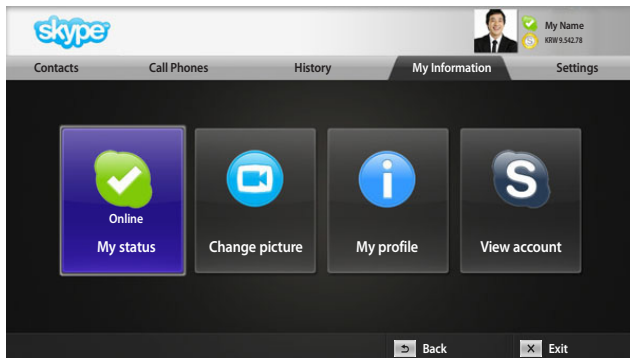

My Information

The information menu consists of 'My status,' 'Change picture,' 'My profile' and 'View account'.

! NOTE:

- ▶ The maximum number of photos that can be saved using Snapshot is limited.

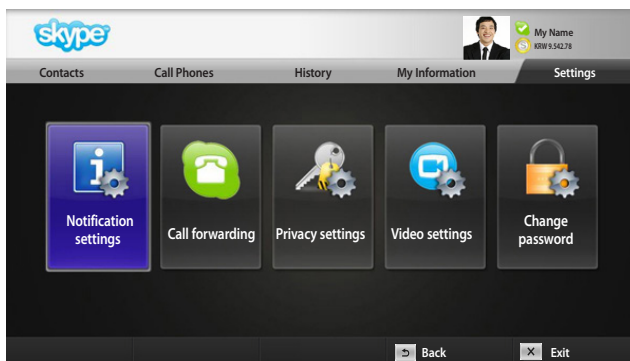

Settings

The settings menu includes 'Notification settings,' 'Call forwarding,' 'Privacy settings,' 'Video settings' and 'Change password'.

! NOTE:

- ▶ It may take several minutes for applying the new setting value.

MAKE A VIDEO CALL TO THE CONTACT



Select a contact from your contact list.
Press the **"Video call"** button.

NOTE:

- ▶ It can take from a few seconds to several minutes for a call to be connected to the party.



OR



- Inviting people / Add people** : Add to call member.
- Screen mode** : Changes video window.
- Camera zoom in / out** : Zooms the video in or out.
- Pointing zoom** : The magnified image will be sent to the other party by using "the pointing zoom feature". The magnified image is only one square of the nine part grid.
- Stop my video** : Your video disappears, and the connected party cannot watch it either.
- Mute microphone** : Mutes the microphone, and the connected party cannot hear your voice either.
- End Call** : Ends the call.
- Hold Call** : Holds the call until the **"Resume call"** button is pressed.
- Call quality information** : Video quality will be affected by downstream network conditions.

- **Critical**: Very slow internet access.
- **Low** : Slow internet access.
- **Normal**: Fast internet access.

MAKE A CALL (VOICE ONLY) TO A CONTACT



OR

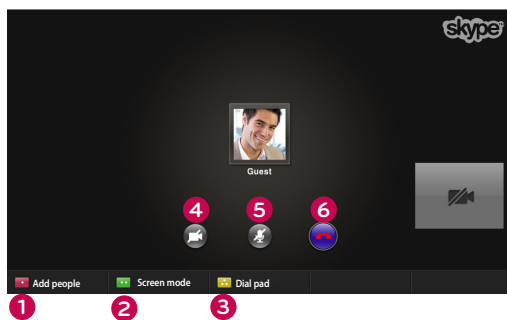

Select a contact from your contact list.

Press the **"Call"** button.

Once a contact's phone number is registered, you can select among the contact's Skype name and phone numbers.

! NOTE:

- ▶ It can take from a few seconds to several minutes for a call to be connected to the party.

- 1 **Inviting people / Add people** : Add to call member.
- 2 **Screen mode** : Changes video window.
- 3 **Display dial pad / Dial pad** : Opens a numerical keypad.
- 4 **Start my video** : Shares your video with the connected party.
- 5 **Mute microphone** : Mutes your audio. The connected party can not hear your audio.
- 6 **End Call** : Ends the call.
- 7 **Hold Call** : Holds the call until the **"Resume call"** button is pressed.

RECEIVING A CALL

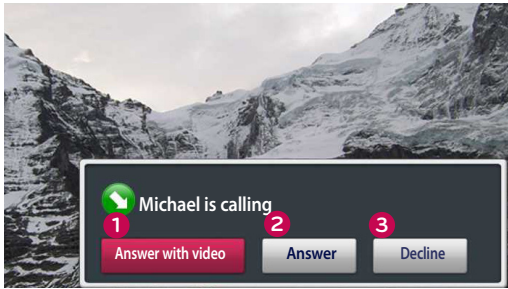

OR

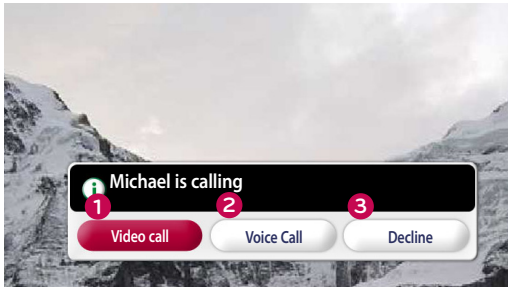

When someone calls while you are watching TV, a message appears on the bottom right of the screen.

- 1 **Answer with video** : Receive the call with video (stops the TV).
- 2 **Answer** : Receive the call.
- 3 **Decline** : Do not receive the call, and continue watching TV.

! NOTE:

- ▶ Set your status to "do not disturb" to prevent Skype pop-ups.
- ▶ If the incoming call is a conference call, the "Answer with Video" option is not available.

- 1 **Video call** : Receive the call with video.
- 2 **Voice Call**: Receive the call with voice.
- 3 **Decline** : Do not receive the call.

USING Skype (webOS Smart TV)

START Skype

REGULAR REMOTE CONTROL

- 1 Press 
- 2    Start **Skype**.

! NOTE:

- ▶ Skype must be connected to a network to operate.

MAGIC REMOTE CONTROL

- 1 Press 
- 2   Start **Skype**.

CREATE ACCOUNT / SIGN IN

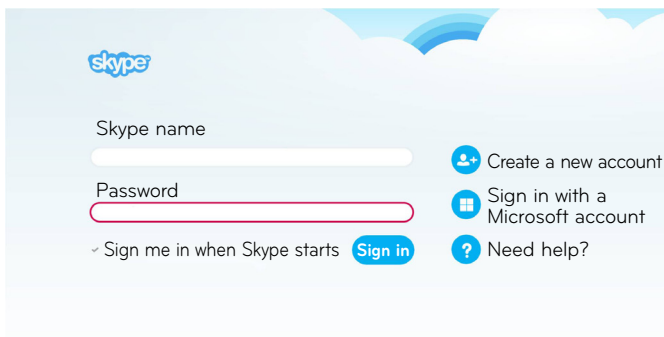

After selecting the Skype icon, enter your Skype name and password. Choose "Sign me in when Skype starts" to sign in automatically when the TV is switched on.

! NOTE:

- ▶ You can log in with your existing Skype account or a Skype account that is merged with your Microsoft account.
- ▶ To create a new Skype account that is already merged with your Microsoft account, please refer to their websites for further information.

Skype MENU

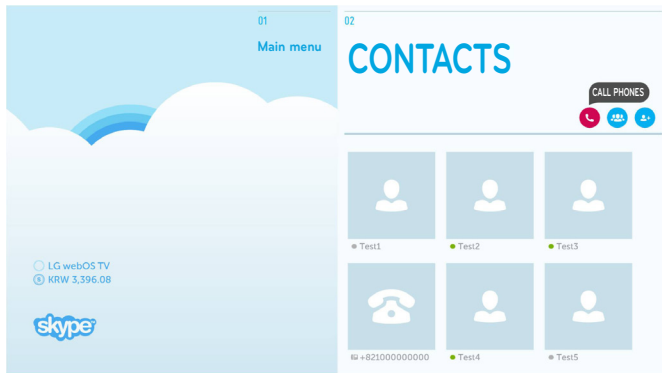

CONTACTS

This is the list of contacts in your contact list. For more details about how to make a call, refer to pages 14 and 16.

! NOTE:

- ▶ The maximum number of contacts that can be stored is limited by the storage capacity.
- ▶ If there are more than 500 contacts, the list's performance and stability may be affected.

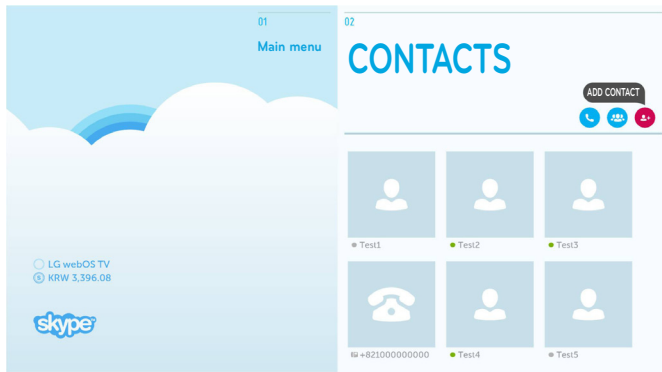

ADD CONTACT

Press 'ADD CONTACT' button on the 'CONTACTS' screen.

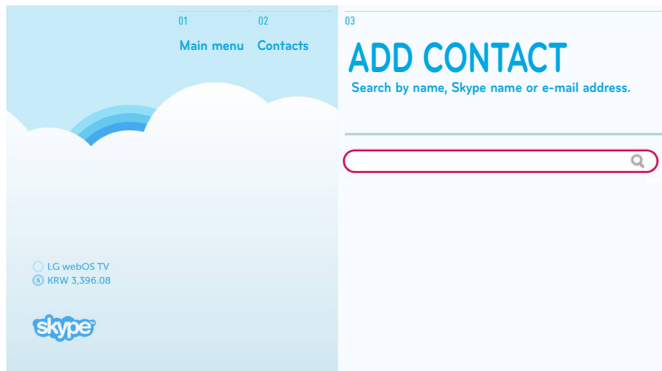

You can search for Skype users using the search bar. From the search results, you can add a contact you want.

! NOTE:

- ▶ Search results will be in alphabetical order.

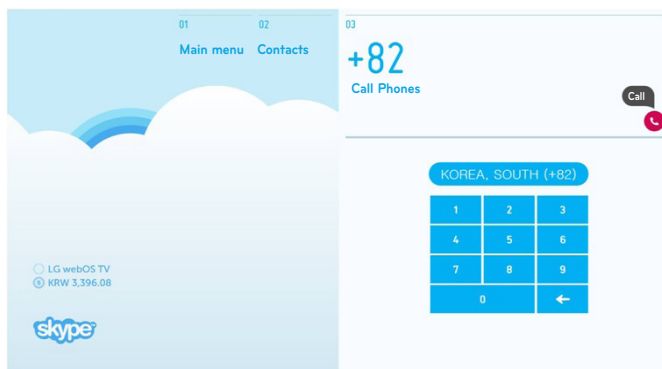

Call Phones

Select the country you would like to call and enter a phone number. Now select 'Call'.

! NOTE:

- ▶ To use Call Phones, you will need **Skype Credit**. For more details, visit the Skype homepage (www.skype.com).

Skype MENU (CONTINUED)

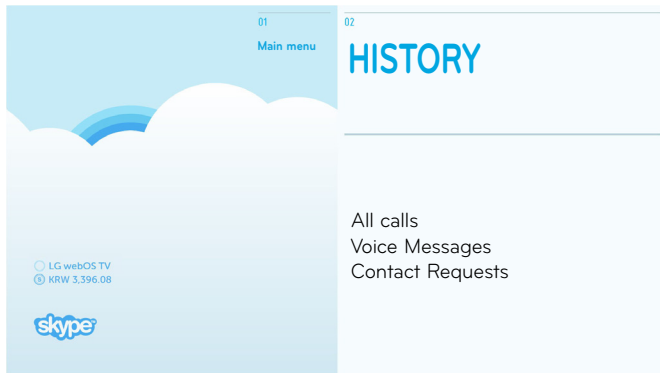

HISTORY

This lists 'All calls', 'Voice Messages', 'Contact Requests'.

By selecting 'All calls,' you can check your Incoming/outgoing/missed calls.

You can check the received event list by selecting 'Voice messages' or 'Contact requests'.

The numbers on the right side of each item indicate the number of unchecked items.



MY PROFILE

The information menu consists of 'Status', 'Mood Message' and 'Profile'.

! NOTE:

- ▶ You can use the 'Snapshot' from 'Edit' screen.
- ▶ The maximum number of photos that can be saved using Snapshot is limited.

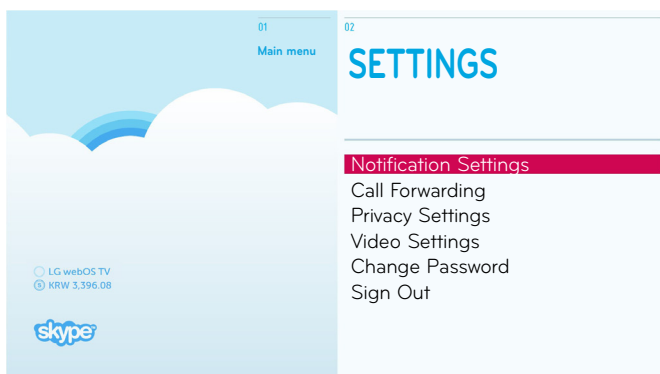

SETTINGS

The settings menu includes 'Notification Settings', 'Call Forwarding', 'Privacy Settings', 'Video Settings', 'Change Password' and 'Sign Out'.

! NOTE:

- ▶ It may take several minutes for applying the new setting value.

MAKE A VIDEO CALL TO THE CONTACT

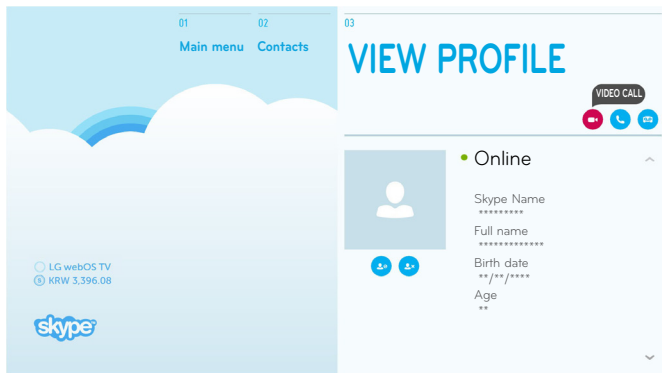

From your contacts list, select a person you want to call.

Press the 'VIDEO CALL' button.

! NOTE:

- ▶ It can take from a few seconds to several minutes for a call to be connected to the party.



OR

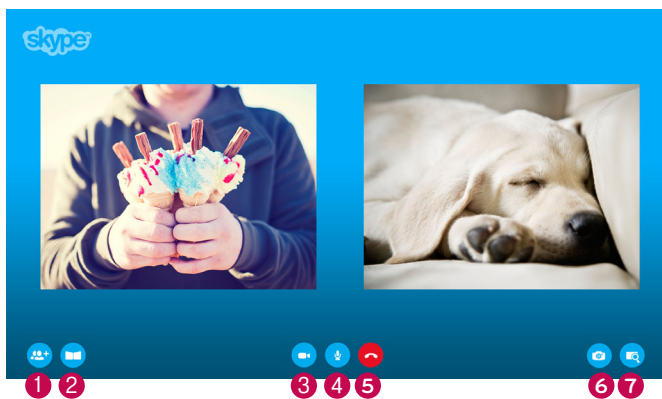

1 ADD PEOPLE

: Add to call member.

2 SCREEN MODE

: Changes video window.

3 CAMERA OFF

: Your video disappears, and the connected party cannot watch it either.

4 MIC OFF

: Mutes the microphone, and the connected party cannot hear your voice either.

5 END CALL

: Ends the call.

6 CAMERA ZOOM IN / OUT

: Zooms the video in or out.

7 POINTING ZOOM

: The magnified image will be sent to the other party by using "the pointing zoom feature". The magnified image is only one square of the nine part grid.

MAKE A CALL (VOICE ONLY) TO A CONTACT

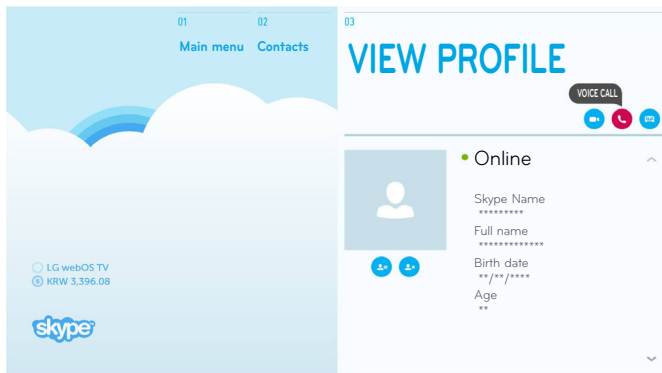

From your contacts list, select a person you want to call.

Press the 'VOICECALL' button.

! NOTE:

- ▶ It can take from a few seconds to several minutes for a call to be connected to the party.

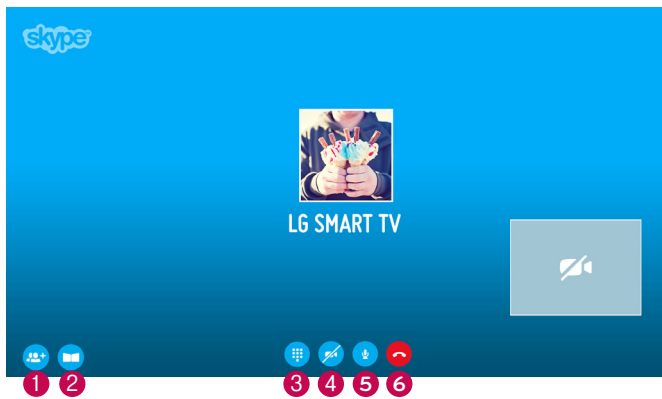

1 ADD PEOPLE

: Add to call member.

2 SCREEN MODE

: Changes video window.

3 DIAL PAD

: Opens a numerical keypad.

4 CAMERA ON

: Shares your video with the connected party.

5 MIC OFF

: Mutes your audio. The connected party can not hear your audio.

6 END CALL

: Ends the call.

RECEIVING A CALL

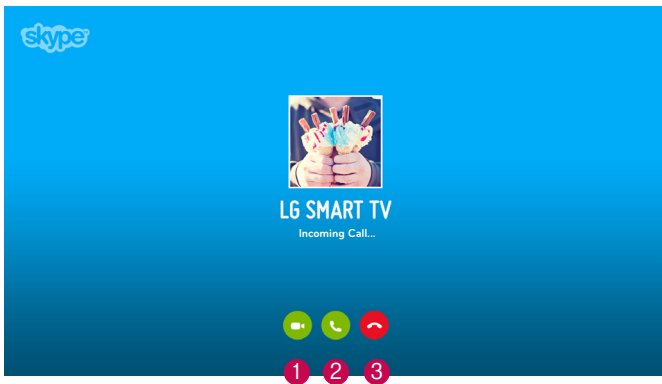

When someone calls while you are watching TV, a message appears on the bottom of the screen.

- 1 **DECLINE** : Do not receive the call, and continue watching TV.
- 2 **ANSWER** : The Skype app launches and the screen switches to the 'Incoming Call...' screen.

This is a screen that is displayed when you select 'ANSWER'.

- 1 **Answer with video**
: Receive the call with video.
- 2 **Answer with audio**
: Receive the call with voice.
- 3 **Decline** : Do not receive the call.

! NOTE:

- ▶ If the incoming call is a conference call, the "Answer with Video" option is not available.

APPENDIX

TROUBLESHOOTING

| For the problems listed below | Check the following areas |
|--|--|
| If Skype doesn't start | <ul style="list-style-type: none">■ Check whether the Video Call Camera is properly connected to the USB port on the TV.■ Check the network connection status. |
| If the Notification Window is not displayed when a call is received | <ul style="list-style-type: none">■ Check that your status is not set as "Do not disturb".■ When using certain TV functions, incoming calls can't be received (e.g. during a software update, etc.).■ Check 'Privacy Settings' is "Allow calls from people in my contact list only". |
| If there's echo (e.g. when you hear your own voice played back through the speakers) | <ul style="list-style-type: none">■ Position the Video Call Camera at the top-center of your TV.■ Change the home theater audio setting to stereo rather than surround.■ Reduce the speaker volume.■ Too much echo in the room can decrease audio quality.■ Test microphone using the 'Echo / Sound Test Service'. |
| If you're not able to receive any video or if it is of low quality | <ul style="list-style-type: none">■ Internet or network congestion can degrade video quality.■ Using wireless can also degrade video quality. We recommend using a wired internet connection.■ Screen quality can decrease when using Zoom-In. We recommend you use minimum zoom during video calls.■ Check whether the call quality information is marked as "critical". If this is the case, video quality can be degraded. |
| If the call ends abruptly | <ul style="list-style-type: none">■ When certain TV functions are activated, the call may be disconnected. (e.g. Sleep timer, etc.)■ Do not unplug the Video Call Camera during a call. |
| If the Skype menu does not appear on the Premium menu | <ul style="list-style-type: none">■ Check whether your TV supports the Video Call Camera (see page 2).■ Connect the camera to your TV, then update the software. For details about how to update the software, refer to your TV manual. |
| Other issues | <ul style="list-style-type: none">■ Issues may arise from network congestion or problems with the Skype network.■ For further inquiries about Skype functions, visit www.skype.com. |

APPENDIX

PRODUCT SPECIFICATIONS

| MODELS | | AN-VC500 (Video Call Camera) | |
|-------------------------------------|-----------------------|--------------------------------------|--------------------|
| Dimensions (Width x Height x Depth) | | 112 mm x 56 mm x 38 mm (dongle only) | |
| Weight | | 107.8 g | |
| Video | Lens | Focus | More than 100 cm |
| | | Field of Vision | 61.25° in diagonal |
| | Effective pixels | 1920 x 1080 | |
| | Output format | H.264, MJPEG, YUV | |
| | Output Image | Full-HD, HD, VGA, QVGA, QQVGA | |
| Audio | Microphone | 2 microphones | |
| Interface | | USB | |
| Environmental conditions | Operating Temperature | 0 °C - 40 °C | |
| | Operating Humidity | 0 % - 80 % | |
| | Storage Temperature | -20 °C - 70 °C | |
| | Storage Humidity | 0 % - 90 % | |

- Contents in this manual may be changed without prior notice due to upgrade of product functions.
- The specifications shown above may be altered without prior notice to improve quality.
- This product follows Skype Encoding Camera Specification (SECS) 2.1.



Video calls through an LG TV cannot be made using the following devices:

- ASUS Skype Video Phone Touch SV1TS
- ASUS Skype Videophone Touch SV1TW
- AIGURU_SV1 Skype Video Phone

*The list of devices that are not supported may be amended without prior notification.



"Skype is a trademark of Skype or its related companies. Although this product has been tested and met our certification standards for audio and video quality, it is not endorsed by Skype, Skype Communications S.a.r.l. or any of their related companies."

Copyright:

© 2003-2014, Skype



Free Manuals Download Website

<http://myh66.com>

<http://usermanuals.us>

<http://www.somanuals.com>

<http://www.4manuals.cc>

<http://www.manual-lib.com>

<http://www.404manual.com>

<http://www.luxmanual.com>

<http://aubethermostatmanual.com>

Golf course search by state

<http://golfingnear.com>

Email search by domain

<http://emailbydomain.com>

Auto manuals search

<http://auto.somanuals.com>

TV manuals search

<http://tv.somanuals.com>